

# SERVICE MANUAL

## HEATED LANDING ZONE (HLZ 18 AND HLZ 22)

---

This equipment chapter is to be inserted in the Equipment Manual.

MANUFACTURED BY FRYMASTER, L.L.C.  
8700 Line Avenue  
SHREVEPORT, LOUISIANA 71106  
PHONE 1(318)865-1711  
1 (800) 24 FRYER



### TABLE OF CONTENTS

<b>1. WARRANTY STATEMENT .....</b>	<b>1</b>
1.1 WARRANTY PROVISIONS - HEATED LANDING ZONE .....	1
1.2 PARTS RETURN .....	1
1.3 WARRANTY EXCLUSIONS.....	1
<b>2. PARTS ORDERING AND SERVICE INFORMATION .....</b>	<b>2</b>
<b>3. HEATED LANDING ZONE .....</b>	<b>3</b>
<b>4. INSTALLATION/SETUP .....</b>	<b>3</b>
<b>5. OPERATION .....</b>	<b>3</b>
<b>6. HLZ MODEL/COMPONENT IDENTIFICATION .....</b>	<b>4</b>
<b>7. HLZ COMPUTER OPERATION AND PROGRAMMING .....</b>	<b>5</b>
7.1 PROGRAMMING TEMPERATURE .....	5
7.2 OPERATION .....	6
<b>8. HLZ OPERATOR TROUBLESHOOTING .....</b>	<b>8</b>
<b>9. SERVICE INFORMATION .....</b>	<b>9</b>
9.1 PARTS LIST.....	9
9.2 INTERIOR VIEW OF AN HLZ .....	9
9.3 PROCEDURES.....	11
10 DIAGNOSTIC TESTS.....	15
11 WIRING DIAGRAM.....	18

Frymaster L.L.C., 8700 Line Avenue, Shreveport, Louisiana 71106  
318-865-1711 FAX 318-862-2394

**NOTICE**

IF, DURING THE WARRANTY PERIOD, THE CUSTOMER USES A PART FOR THIS MANITOWOC EQUIPMENT OTHER THAN AN **UNMODIFIED** NEW OR RECYCLED PART PURCHASED DIRECTLY FROM FRYMASTER DEAN, OR ANY OF ITS AUTHORIZED SERVICE CENTERS, AND/OR THE PART BEING USED IS MODIFIED FROM ITS ORIGINAL CONFIGURATION, THIS WARRANTY WILL BE VOID. FURTHER, FRYMASTER DEAN AND ITS AFFILIATES WILL NOT BE LIABLE FOR ANY CLAIMS, DAMAGES OR EXPENSES INCURRED BY THE CUSTOMER WHICH ARISE DIRECTLY OR INDIRECTLY, IN WHOLE OR IN PART, DUE TO THE INSTALLATION OF ANY MODIFIED PART AND/OR PART RECEIVED FROM AN UNAUTHORIZED SERVICE CENTER.

**THIS SERVICE MANUAL SUPERCEDES  
ALL PREVIOUS EDITIONS OF THE HLZ SERVICE MANUAL.**

**FOR YOUR SAFETY  
DO NOT STORE OR USE GASOLINE OR OTHER FLAMMABLE VAPORS AND LIQUIDS IN  
THE VICINITY OF THIS OR ANY OTHER APPLIANCE.**

**DO NOT OPERATE OR SERVICE THE HLZ SERIES WITHOUT FIRST READING THIS  
MANUAL.**

**DO NOT OPERATE THE HLZ SERIES UNLESS IT HAS BEEN PROPERLY INSTALLED  
AND CHECKED.**

**DO NOT OPERATE THE HLZ SERIES UNLESS ALL SERVICE AND ACCESS PANELS  
ARE IN PLACE AND PROPERLY SECURED.**

**DO NOT ATTEMPT TO REPAIR OR REPLACE ANY COMPONENT OF THE HLZ SERIES  
UNLESS ALL POWER TO THE UNIT HAS BEEN DISCONNECTED.**

**USE CAUTION WHEN SETTING UP, OPERATING, OR CLEANING THE HEATED  
LANDING ZONE TO AVOID CONTACT WITH HEATED SURFACES.**

**HAZARD COMMUNICATION STANDARD, (HCS) - THE PROCEDURES IN THIS MANUAL  
INCLUDE THE USE OF CHEMICAL PRODUCTS. THESE CHEMICAL PRODUCTS WILL  
BE PRINTED IN BOLD FACE, FOLLOWED BY THE ABBREVIATION (HCS) IN THE TEXT  
PORTION OF THE PROCEDURE. SEE THE HAZARD COMMUNICATION STANDARD,  
(HCS) MANUAL FOR THE APPROPRIATE MATERIAL SAFETY DATA SHEET(S), (MSDS).**

# 1. WARRANTY STATEMENT

The Frymaster Corporation makes the following limited warranties to the original purchaser only for this equipment and replacement parts:

## **WARRANTY PROVISIONS - HEATED LANDING ZONE**

- A. The Frymaster Corporation warrants all components against defects in material and workmanship for a period of 2 years.
- B. All parts, with the exception of fuses, are warranted for 1 year after installation date of cabinet.
- C. If any parts, except fuses, become defective during the first year after installation date, Frymaster will also pay straight-time labor costs to replace the part, plus up to 100 miles/160 km of travel (50 miles/80 km each way).

## **PARTS RETURN**

- A. All defective in-warranty parts must be returned to a Frymaster Authorized Factory Service Center within 60 days for credit. After 60 days, no credit will be allowed.

## **WARRANTY EXCLUSIONS**

This warranty does not cover equipment which has been damaged due to misuse, abuse, alteration, or accident such as:

- improper or unauthorized repair;
- failure to follow proper installation instructions and/or scheduled maintenance procedures as prescribed in your MRC cards;
- improper maintenance;
- damage in shipment;
- abnormal use;
- removal, alteration, or obliteration of the rating plate;

This warranty also does not cover:

- transportation or travel over 100 miles/160 km (50 miles/80 km each way), or travel time over two (2) hours;
- overtime or holiday charges;
- consequential damages (the cost of repairing or replacing other property which is damaged), loss of time, profits, use or any other incidental damages of any kind.

There are no implied warranties or merchantability or fitness for any particular use or purpose.

For international warranty, the above procedures apply, except that the customer is responsible for freight and duty charges.

# 2. PARTS ORDERING AND SERVICE INFORMATION

Parts orders may be placed directly with your local Frymaster Factory Authorized Servicer (FAS)/Distributor. A list of Frymaster FASC/ Distributors is posted at [WWW.frymaster.com](http://WWW.frymaster.com). If you do not have access to this list, please contact the Frymaster Service Department at 1-800-24-FRYER or 1-318-865-1711.

To speed up your order, the following information is required:

Model Number \_\_\_\_\_  
Serial Number \_\_\_\_\_  
Voltage \_\_\_\_\_  
Item Part Number \_\_\_\_\_  
Quantity Needed \_\_\_\_\_

Frymaster L.L.C., 8700 Line Avenue, Shreveport, Louisiana 71106  
318-865-1711 FAX 318-862-2394

Service may be obtained by contacting your local Frymaster Authorized Servicer /Distributor. Service information may be obtained by calling the Frymaster Service Department. The following information will be needed in order to assist you quickly and efficiently:

Model Number \_\_\_\_\_

Serial Number \_\_\_\_\_

Nature of the Problem \_\_\_\_\_

\_\_\_\_\_

\_\_\_\_\_

\_\_\_\_\_

Also any other information which may be helpful in solving your service problem.

RETAIN AND STORE THIS MANUAL IN THE EQUIPMENT MANUAL FOR FUTURE USE.

Frymaster L.L.C., 8700 Line Avenue, Shreveport, Louisiana 71106  
318-865-1711 FAX 318-862-2394

### 3. HEATED LANDING ZONE

The **Heated Landing Zone** or **HLZ** is designed to hold assembled sandwiches. By circulating heated air evenly across the open staging area, the Heated Landing Zone keeps sandwiches hot without drying or cooking. The Heated Landing Zone meets all McDonald's standards for safety, efficiency, food safety, and cleanliness.

### 4. INSTALLATION/SETUP

Upon arrival, inspect the HLZ for concealed damage. Immediately report any damage to the delivering freight company. Claims must be filed within 15 days after receipt of the unit.

Make sure that the unit is placed on an even surface and that the area surrounding the HLZ is free of clutter that would interfere with air flow.

#### INSTALL OPTIONAL BURGER BUMPER (Units built before 10/98)

The burger bumper may be placed on either side of the HLZ to prevent pass through of product. Burger bumpers are provided by the KES. See figure 1.

#### INSTALL FILTER SCREEN (Units built after 10/98)

The filter screen is design to prevent debris from entering the Computer Cowl Assembly and clogging the blower assembly. Simply fit the part on to the vent opening of the computer cowl assembly. The filter screen will snap into position. If equipped with an optional holding screw, tighten screw to pull the filter screen snug into position.

#### POWER REQUIREMENTS:

- Voltage – Two models are available: 208 VAC and 240 VAC\*
- Frequency - 60 Hz
- Single Phase
- 20 amp Service

### 5. OPERATION

1. Plug the unit into the power source.\*
2. See "HLZ COMPUTER OPERATION AND PROGRAMMING, Section 7" for proper setup and operation of the computer.
3. Place product in the HLZ in accordance with the restaurant's established procedures.
4. **CLOSING** - When closing the store, remove all product from the HLZ and perform daily preventive maintenance in accordance with the MRC. Turn the computer OFF.

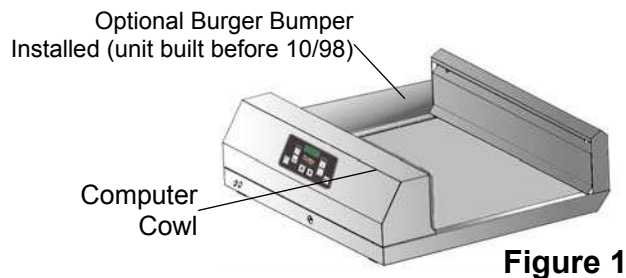

Figure 1



The filter screen snaps into place on rear of the air-intake tower.

*\* If the 240 VAC model is operated on 208 VAC, the unit will heat slowly and may not reach maximum temperature. If the 208 VAC model is operated on 240 VAC, component damage is probable. To ensure proper operation, the power source should match the voltage on the rating plate on the bottom of the HLZ.*

**THIS APPLIANCE IS EQUIPPED WITH A GROUNDING PLUG FOR YOUR PROTECTION AGAINST SHOCK HAZARD AND MUST BE PLUGGED INTO A PROPERLY GROUND RECEPTACLE. DO NOT CUT OR REMOVE THE GROUNDING PRONG FROM THIS PLUG.**

## 6. HLZ MODEL/COMPONENT IDENTIFICATION

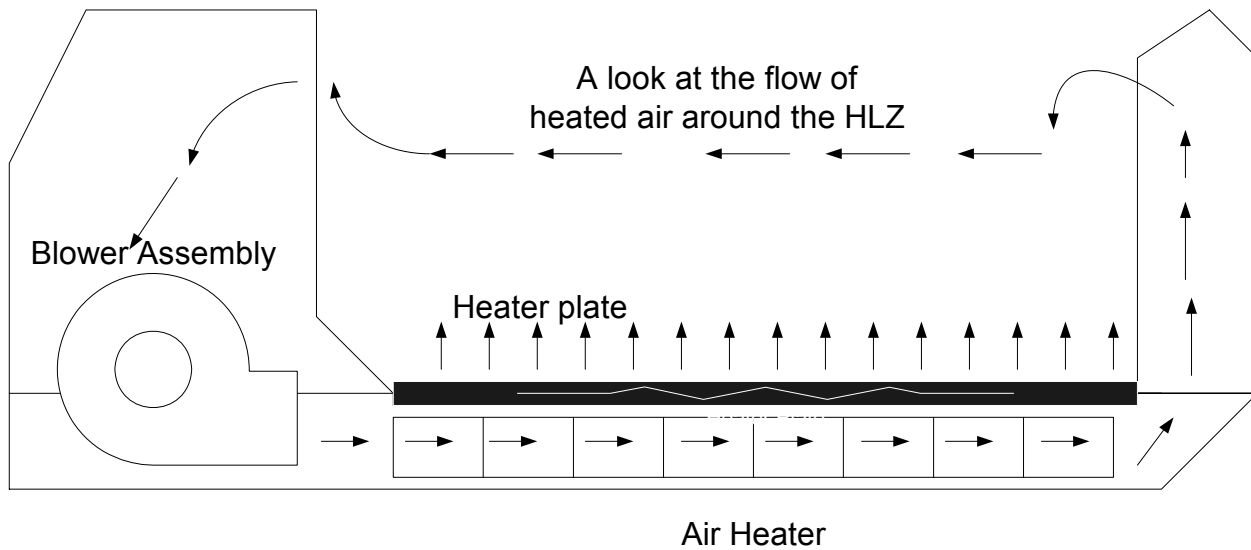
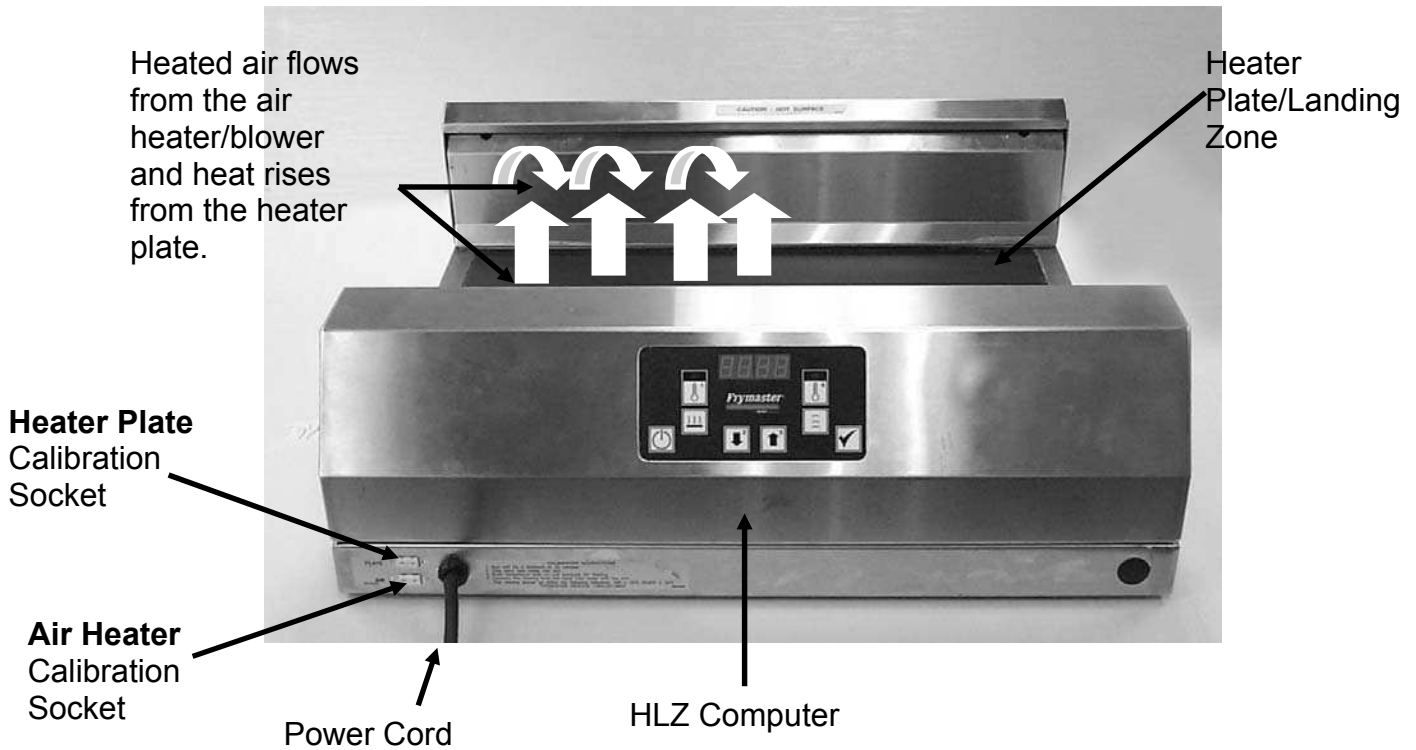

Frymaster L.L.C., 8700 Line Avenue, Shreveport, Louisiana 71106  
 318-865-1711 FAX 318-862-2394

## 7. HLZ COMPUTER OPERATION AND PROGRAMMING

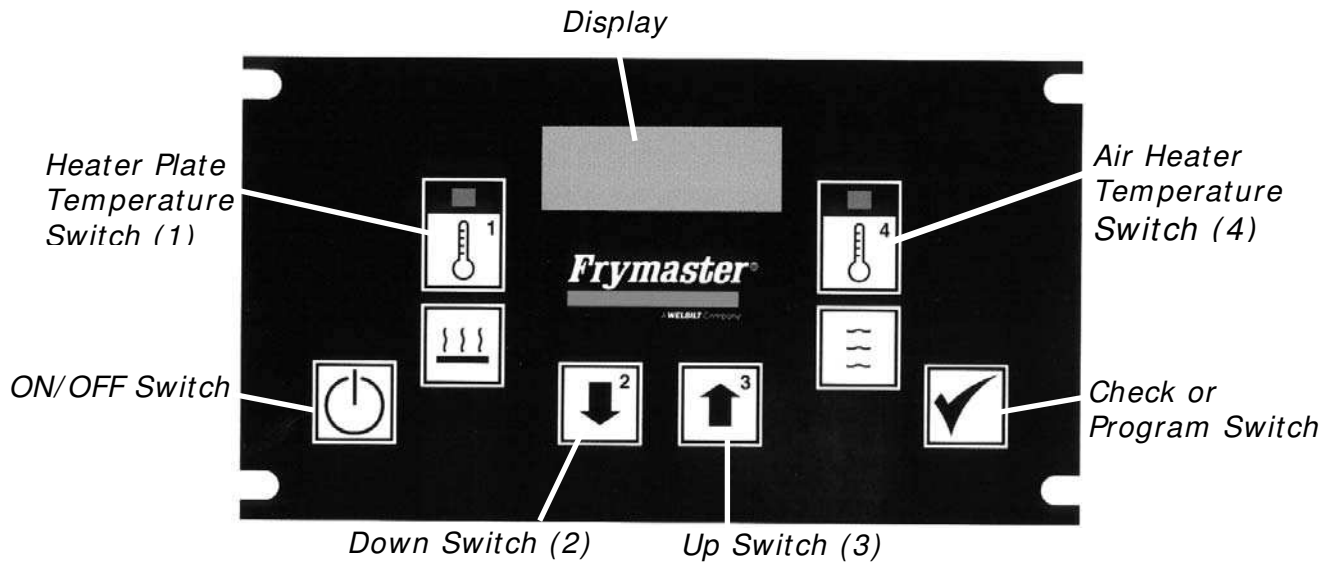

### 7.1 Programming Temperature

You are able to program the setpoint temperature of both the air heater and the heater plate via the computer interface. The heater plate factory default is set to the McDonald's standard of 160°F. The air heater factory default is set to the McDonald's standard of 220°F. If the factory default temperature settings are acceptable, skip to Section 7.2, Page 6.

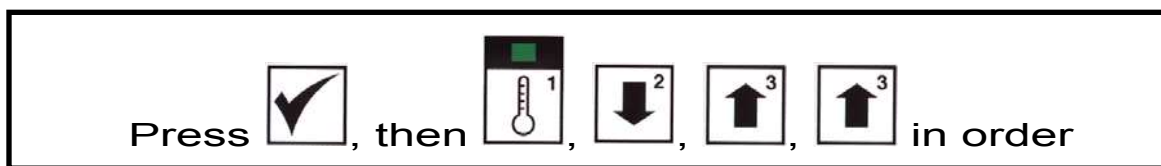

Ensure that the HLZ computer is in the OFF position (nothing in the display).

Press the check switch and enter the code (1,2,3,3). The numerals in the upper right-hand corner represent the key number.





The display will read SET and the LEDs on both the Heater Plate Switch (1) and the Air Heater Switch (4) will light. Press the switch that corresponds to the heater you wish to program.



Display reads **SET**,  and  LED's light.

Press  to program the heater plate or  to program the air heater.

Press the Up and Down Arrow Keys to achieve the desired set-point temperature, then press the Check Switch once. Both heater LEDs will again light.

Press  or  to get desired setpoint, then press  to lock the temperature in.

If you are finished with programming both heaters, press the Check Switch again to store the programmed setpoints and exit the programming mode OR to change the setpoint temperature for the other heater, press the corresponding Heater Switch (1 or 4). Program as described in Step 4.

When finished, press  again to exit programming mode. To change the other heater, press  to program the heater plate or  to program the air heater, then go to Step 4 for instructions.

## 7.2 Operation

1. Press the ON/OFF switch to the ON position (the display will light and cycle through an initialization sequence). The display will read –LO- until the air heater and heater plate are within 15°F of setpoint. It will take approximately 10 minutes for the HLZ to achieve operating temperature.

Frymaster L.L.C., 8700 Line Avenue, Shreveport, Louisiana 71106  
318-865-1711 FAX 318-862-2394



Press  to turn on the computer.

The display will read **— LO —** until both heaters are within 15°F of setpoint

NOTE: A small LED will light in the display when either the heater plate or air heater is energized.

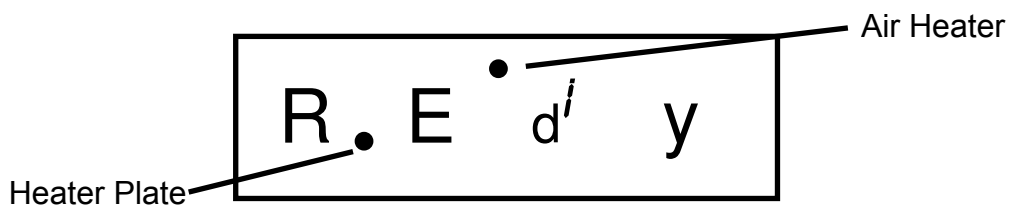

When the HLZ is ready for operation, the display reads REdY (ready). Place product in the HLZ in accordance with the restaurant's established procedures.

NOTE: To check the *actual* temperature of a heater, press the corresponding Temperature Switch once. To check the *setpoint* temperature of a heater, press the switch twice (an indicator will light when the setpoint is displayed).

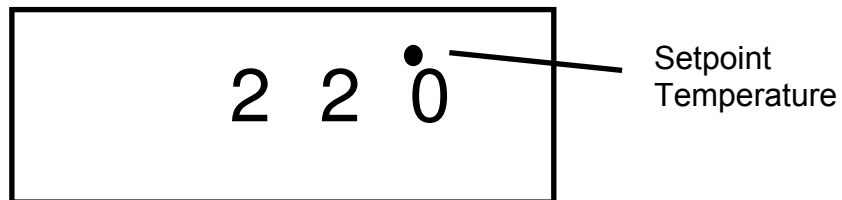

## 8. Operator Troubleshooting Guide

Symptom	Possible Cause
<b>No computer display; no flow from air tower</b>	No power Circuit breaker out Low voltage Bad fuse Bad transformer Hi-limit out
<b>No flow from air tower</b>	Bad latching relay
<b>After 20 minutes of operation computer display shows PROB</b>	<i>RTD probe has failed. Isolate failed component by checking temperature of air and heater plate with the temperature display keys on the computer. The plate temperature should be within <math>\pm 15^{\circ}\text{F}</math> of setpoint. The air heat should be within <math>\pm 25^{\circ}\text{F}</math> of setpoint. If both temperatures are good, the computer is likely bad.</i>
<b>After 20 minutes of operation computer display shows HI</b>	Plate heater, plate heater relay or RTD are faulty.
<b>After 20 minutes of operation computer display shows LO</b>	Air heater, air heater relay or RTD are faulty

## 9. SERVICE INFORMATION

### 9.1 PARTS LIST

Description	Part Number
Transformer, 208V/240V/12V	807-0979
Transformer 230V (CE)	807-3185
Air Heater, 208V	826-1549
Air Heater 230V (CE)	807-3630
Air Heater, 240V	807-3011
Shield, HLZ Heater	900-8486
Air RTD Probe	807-3036
Bracket, RTD/Thermocouple	900-8366SP
Delivery Air Back W/A	823-2741
Air Thermocouple	807-3043
HLZ 22 Plate, Heater with RTD and Thermocouple, 208V/240V (22"x15.5")	806-9238SP
HLZ 18 Plate, Heater with RTD and Thermocouple, 208/240V (22"x12")	806-9239
Line Filter (CE)	807-2818
Plug Assembly, Computer	806-9636
Air Relay, SS Service	826-2038
Plate Relay, SS Service	826-1958

Relay, Latching	807-3021
Blower, 230V (CE)	807-3691
Blower, 208V/240V	807-3637
Hi-Limit	807-3631
Fuse Block	807-2820
Fuse, 20A	807-2819
Cordset, Twist Lock, HLZ	807-3020
Cordset, CE	807-1696
Cordset, Japanese	807-3419
Cordset, China	807-4409
RTV#108 Silicone Rubber	811-0511
Gasket, HLZ Plate/Cowl	816-0418
Filter Screen	810-1724
Acrylic Tape	811-1042
Computer Assembly, HLZ	826-2535
Cowl Assembly	823-2745
Cowl Tinnerman Clips	809-0448
Front Delivery Air W/A	823-2742
Lug, Grounding 14 GA	807-2972
Pad, HLZ Leg	826-1561

### 9.2 Interior view of an HLZ (Cowl Assembly removed)

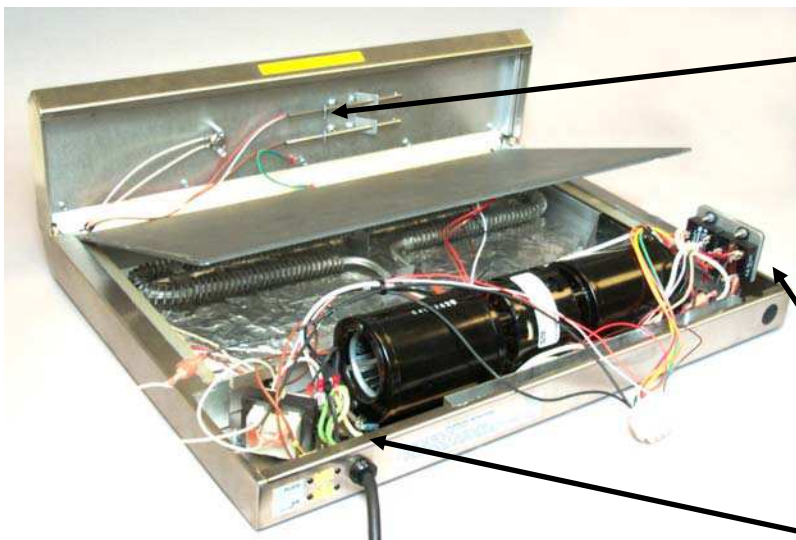

HLZ with heater plate elevated.

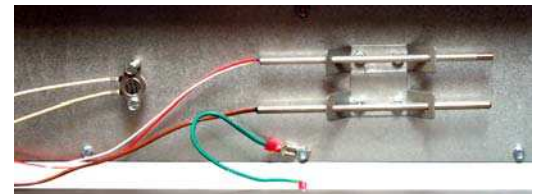

Hi-limit (left above) and air thermocouple (bottom right above) and air RTD.

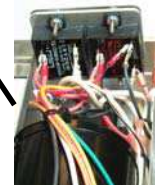

Solid state relays



Transformer and fuses.

### 9.3 Repair Procedures

#### 1. Accessing the interior of the HLZ (Set up for testing):

- a. Disconnect power cord from outlet.
- b. Turn unit on its side. Remove the five access screws located on the bottom of the unit.
- c. Then set the unit back down on its base. Place paper towels on the heater plate to protect it from scratching. Remove the cowl assembly and lay the cowl on the heater plate while troubleshooting.



The cowl assembly is held on by five screws, which are removed from the bottom of the unit.

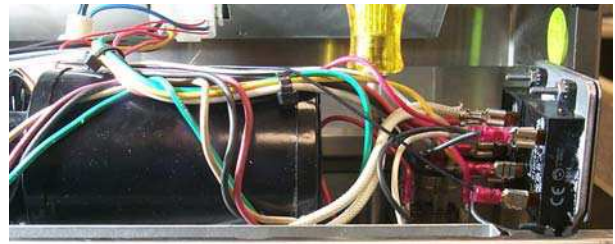
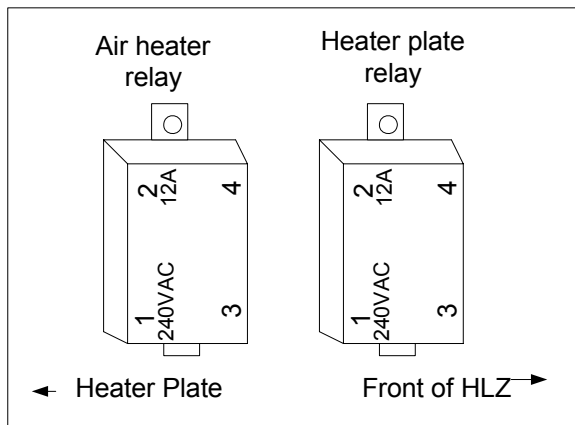

The relays are best replaced by removing the plate that holds them in place. Two 5/16 nuts hold the plate in place.

#### 9.4 Replacing Solid State Relays:

- a. Avoid miswiring. Examine the terminals carefully and take notes to avoid miswiring.
- b. Remove the plate holding the relay assembly. The nuts holding the relays in place are easier to reach with the assembly out of the unit.
- c. Remove the two nuts holding relays to plate.
- d. Apply heat sink compound and install new relay.
- e. Reverse this procedure to reinstall.

## 9.5 Opening the Air Delivery Tower:

- a. The air thermocouple and air RTD are located in the air delivery tower. To access them, the front air delivery assembly must be removed.
- b. Insert a 5/16" nut driver through the front air delivery assembly access holes and turn the nuts counterclockwise to loosen. **Do not remove the nuts.** Grab the bottom flange of the front air delivery, push upwards and pull towards you. Be careful, there are two tabs on the front air delivery bottom that must clear the heater plate to allow removal of the front air delivery.

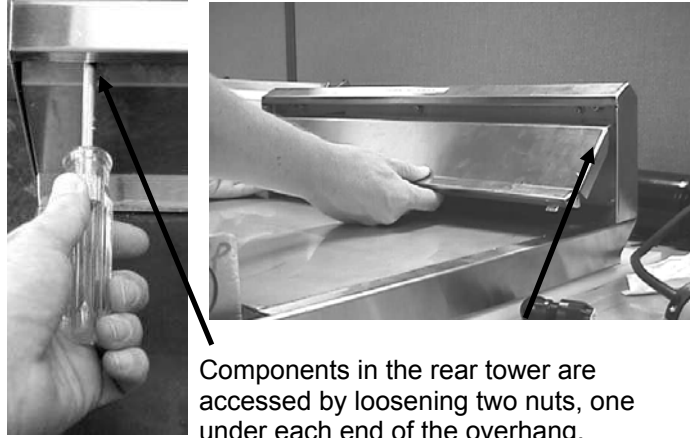

## 9.6 Replacing Air Thermocouple and Air RTD Probe:

- a. Follow procedures in section 9.3. to access the Air Delivery tower components.
- b. Cut old lead wires close to the faulty air thermocouple or Air RTD Probe. Disconnect lead wires at the test plug. Leave lead wires in place for now.
- c. Remove the faulty Air Thermocouple or Air RTD Probe from the bracket.
- d. Install the replacement Air Thermocouple or Air RTD Probe into the bracket.
- e. Attach the new lead wires to the old lead wires on the Air Thermocouple or Air RTD Probe on the bracket-side of unit. Grasp the old leads at the test plug and gently pull the leads towards you.
- f. Once the new lead wires have been pulled through, disconnect the old lead wires, and attach the new leads to the test plug.

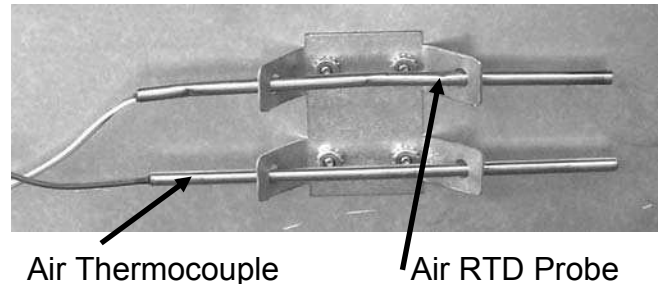

- g. Go to step 9.3.2 and reassemble the air delivery tower.

### 9.7 Accessing the Plate and Air Heaters:

- a. Use the following method to remove the plate heater assembly or access the compartment underneath the plate heater.
- b. Remove the cowl assembly per steps 9.3.
- c. Then remove the air delivery assembly following steps in 9.5.
- d. Insert a thin, sharp knife, i.e. Exacto-type, between the heater plate and the HLZ chassis. Carefully cut the silicon adhesive between the heater plate and the chassis.

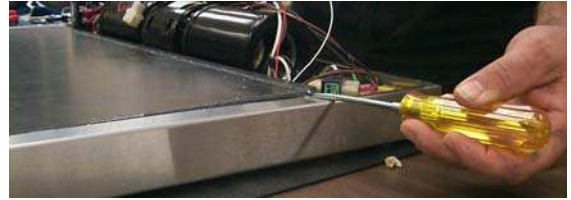

After cutting the acrylic adhesive between the heater plate and the HLZ chassis, use a screwdriver to gently lift the heater plate.

- e. Lift the heater plate by prying up one end of the heater plate away from the HLZ chassis. The plate is held in place by an acrylic tape. It will be difficult to break the bond between the heater plate and chassis.
- f. Remove acrylic tape from the heater plate and frame to prevent rebounding while servicing.



Gently lift the heater plate, which may still be stuck to the adhesive. Apply new acrylic tape to the chassis before reinstalling the heater plate.

- g. When reinstalling the heater plate, apply new acrylic tape to the HLZ chassis first. Then position the heater plate standing on its side against the back air delivery assembly. The heater plate leads should be coming off the “top” edge of the heater plate.
- h. Once the heater plate is aligned properly with the HLZ chassis, gently lower the heater plate until the plate end with the lead wires is approximately 2 inches from the chassis. Feed the leads through the opening in the chassis wall.
- i. Finish lowering the heater plate into place and connect the heater plate lead wires.

**NOTE: A hot platen is easier to remove. The heat makes the adhesive more pliable.**

## 9.8 Replacing Hi-limit

- a. Follow steps in Accessing plate and air heaters, 9.7.
- b. Remove the shield over the air heater
- c. Remove the brace on the left side of the base assembly, exposing the wire raceway.
- d. Remove the grommets the hi-limit wiring passes through.
- e. Remove the existing hi-limit and pull wiring through cabinet.
- f. Mount the hi-limit on the the spacers, providing a stand-off from the panel..
- g. Push the wires through the raceway toward the transformer on the controller side of the HLZ.
- h. Slip the wires from the hi-limit into the area occupied by the transformer.
- i. Slip the hi-limit wires into the removed grommets and snap back into place.
- j. Plug the black wire leading from pin 1 in the computer plug into the terminal of the hi-limit.
- k. Plug the other hi-limit terminal onto the transformer.
- l. Ensure all connections are tight.
- m. Retie the wiring assembly
- n. Replace the brace, which forms the wire raceway.
- o. Replace the metal shield over the air heater.
- p. Clear away the old adhesive holding the heater plate in place.
- q. Put the single-back adhesive in place adhesive-side down and position the heater plate.
- r. Ensure the heater plate's ground wire is reconnected.
- s. Plug the 15-pin connector into the computer and replace the controller housing.
- t. Reassemble unit as described in step 9.9 below.

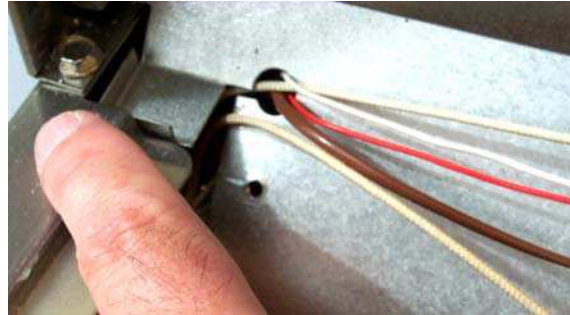

The wires for the hi-limit are routed through the hole used by the RTD wiring. Slip the wires into slot (shown above) and into the hole.



The wire is routed from the air cowling, through the raceway, emerging at the transformer.

## 9.9 Reinstalling the Cowl Assembly and Air Delivery Assembly/Gasket Installation

### a. Cowl Assembly:

1. Clean surface area thoroughly.
2. Remove any old adhesive.
3. Apply a new gasket to bottom edge of the cowl assembly.
4. Test fit the cowl assembly to see if a gap is visible once the cowl assembly is properly seated. If a gap remains, apply a second gasket to create a better seal.
5. Plug in the computer harness and reinstall the cowl assembly .

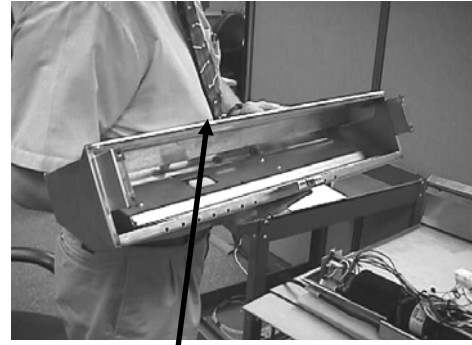

Apply gasket or sealant along this edge

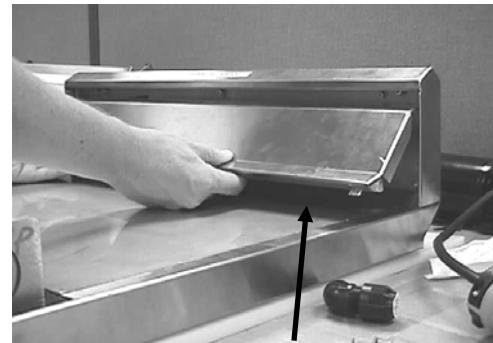

Apply gasket or sealant along this edge

### b. Air Delivery Tower Assembly:

1. Clean surface area thoroughly.
2. Remove any old adhesive.
3. Apply new gasket along bottom edge of the front air delivery panel.
4. Test fit the air delivery assembly to see if a gap is visible once the assembly is properly seated. If a gap remains, apply a second gasket to create a better seal.
5. Make sure the brackets on the back-side of the front air delivery assembly slide up and under the nuts on the back air delivery mounting screws (see figure 9-8). Once the front air delivery tabs clear the heater plate and the front air delivery is seated, tighten the mounting screws to pull the front air delivery flush against the back air delivery assembly. An air seal is created between the lower sections of the front air delivery and back air delivery assemblies. This seal forces the heated air up the rear and then down the front-side of the front air delivery assembly. After reinstalling the air delivery tower, reseal around the heater plate with RTV #108 silicone rubber compound, PN 811-0511.



## 10 Diagnostic Tests for HLZ

### 10.1 Relays

*The following tests are conducted with power applied.*

**Symptom:** Air heater or plate heater will not heat.

**Symptom:** Air heater or plate heater over heats. **NOTE:** Unit will display PROB if overheated. The probes are producing out of range resistance. Allow unit to cool before checking probes.

#### Tests:

- With power supplied and computer turned on, measure DC voltage across input terminals of relay. With computer calling for heat ( dot illuminated on display), the reading should be approximately 12 VDC. Failure to measure DC voltage points to a problem with the computer or connection.
- With power supplied and computer turned on, measure AC voltage across output terminals of relay. With computer calling for heat (dot illuminated in display), the reading should be .6 - .9 VAC. Reading line voltage with the computer calling for heat, indicates a failure of the computer to supply the necessary DC voltage to close the relay or a failure of the relay.

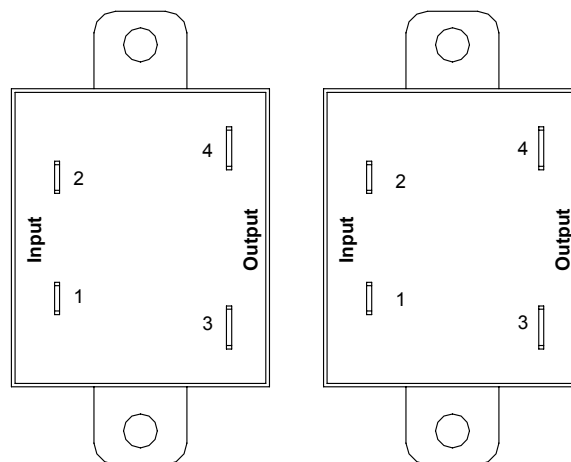

Viewed from the front of the HLZ, the air heater relay is nearest the heater plate; the heater plate relay is nearest the front of the unit.

### 10.2 Computer

**Symptom:** Faulty or no display.

**Symptom:** No response to buttons.

#### Tests:

#### Input power

- With the computer disconnected, check for 12VAC between pins 1 and 3.

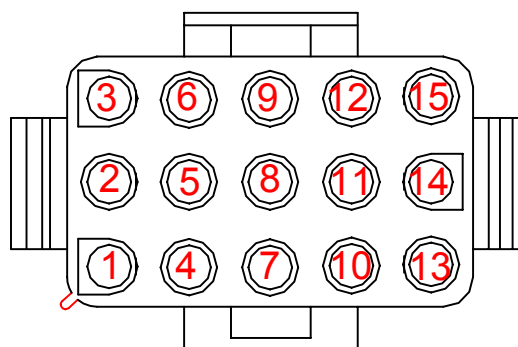

The pins in the computer plug are counted bottom to top, left to right starting with the pin marked by a protruding ridge.

## Output power

- With the computer plugged in and turned on, check for 14VDC from pin 5 on the computer terminal to ground.

### 10.3 Transformer

**Symptom:** Unit has no display

**Test:**

- Line voltage should be measured across the input side of the transformer; 12VAC should be measured across the output side.

### 10.4 Plate Heater RTD

*The following tests are conducted without power applied.*

**Symptom:** Unit displays Probe. Actual plate temp is not within 5°F of setpoint. Temperature must be taken from thermocouple built into unit.

**Test:**

- With power removed from the HLZ, measure resistance between pins 9 and 13 on the computer plug and compare readings to listing on the resistance chart. With the unit cool, the resistance reading should approximate the resistance shown on the chart for the room temperature. Also check for short to ground. A chaffed wire shorting to the chassis can produce resistance readings within proper range.

Resistance Chart		
Centegrade	Fahrenheit	Ohms
21	70	1080
27	80	1101
32	90	1122
38	100	1143
43	110	1164
49	120	1185
54	130	1206
60	140	1226
66	150	1247
71	160	1268
77	170	1289
82	180	1309
88	190	1330
93	200	1350
99	210	1371
104	220	1391
110	230	1412
116	240	1432
121	250	1453
127	260	1473
132	270	1493
138	280	1514
143	290	1534
149	300	1554

Resistance chart

### 10.5 Air RTD

**Symptom:** Unit displays Probe. Actual air temp is not within 5°F of setpoint.

**Test:**

- With power removed from the HLZ, measure resistance between pins 14 and 15 on the computer plug and compare with air temperature on the resistance chart in this section. Also check for short to ground. A chaffed wire shorting to the chassis can produce resistance readings within proper range.

## 10.6 Plate Heater

**Symptom:** No heat when voltage is applied.

**Symptom:** Overheats

**Tests:**

- With power removed from the HLZ , measure resistance between terminal 4 (white wires) on the latching relay and terminal 4 on the plate heater relay. The reading should be 215 to 230 ohms on an HLZ 18; 150-180 ohms on an HLZ 22. Also, check for continuity to the chassis. Resistance seen there indicates a chaffed or shorted wire.

## 10.7 Air Heater

**Symptom:** No heat when voltage is applied.

**Symptom:** Overheats

**Test:**

- With power removed from the HLZ , measure resistance between pin 4 (white wire) on the latching relay and terminal 4 on the air heater relay. The reading should be between 18 and 26 ohms on a 208V unit and 25 and 33 ohms on a 240V unit. Also, check for continuity to the chassis. Resistance seen there indicates a chaffed or shorted wire.

## 10.8 Latching Relay

**Symptom:** Computer calls for heat (dot illuminated). No heat from plate and blower doesn't operate.

**Test:**

- With power removed from the HLZ and the wire removed from pin 1 or 0 of the latching relay, measure resistance between pins 1 and 0. It should be between 79 and 89 ohms.

## 10.9 Blower

**Symptom:** No airflow.

**Symptom:** Unit overheats; displays PROB.

**Tests:**

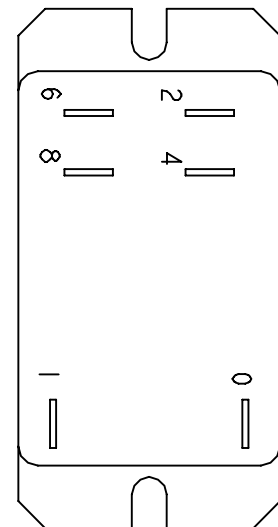

The latching relay is positioned in the HLZ with the 0 and 1 terminals facing the front of the unit.

- Remove power from unit. On 208V units, disconnect black and white wires connecting blower to heat and latching relays. The resistance between the wires should be between 55 and 65 ohms.
- Remove power from unit. On 240V units, disconnect red and white wires connecting blower to heat and latching relays. The resistance between the wires should be between 62 and 72 ohms.

## 10.10 Hi-limit

**Symptom:** No display on controller.

**Test:**

- The hi-limit is in the 12-volt output from the transformer. Remove power from unit. Disconnect the white braided lead from the wire leading from pin 1 on the computer plug. Disconnect the white braided lead from the 12-volt side of the transformer. Check continuity in the hi-limit circuit.

## 11 Wiring Diagram

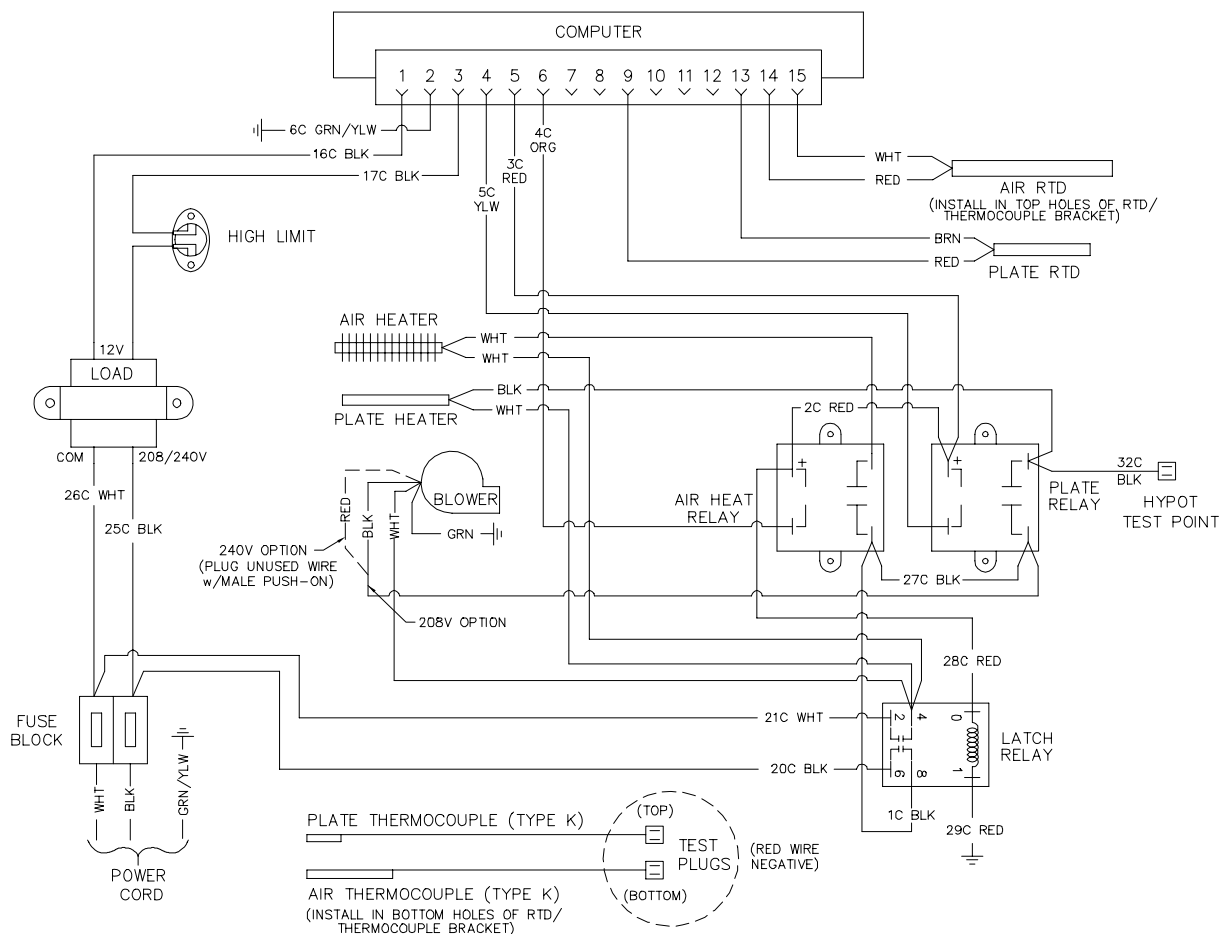

Frymaster L.L.C., 8700 Line Avenue, Shreveport, Louisiana 71106  
318-865-1711 FAX 318-862-2394