

Job Information
Type:
Catalog #:
Project:
Comments:
Prepared by:

Transforming tomorrow's lighting....today!

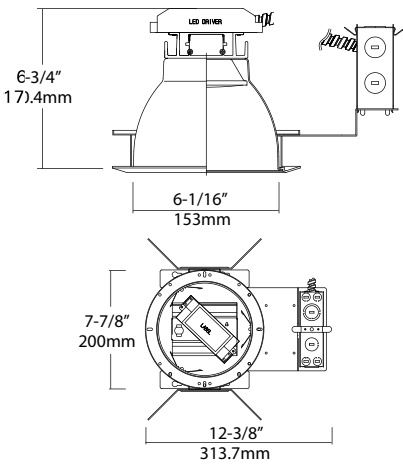

Dimensions



Ceiling Cut-out: 6-3/8"~7-1/4"

Description

6" Architectural frame-in kits combined with LED module and integral reflector. This is designed for use in non-insulated ceiling. Insulation material must be kept a minimum of 3" from fixture. Provided in high efficacy LED with dimmable driver and the special optical diffusion allows high lumen transmission and light uniformity.

Features

Mounting Ring

- 20-gauge CRS mounting ring, black-painted. 1-5/8" deep collar may use for various thickness of ceiling materials.

LED module & Trim

- Aluminum extruded Heat sink designed to facilitate heat dissipation to reduce LED junction temperature for maintaining constant light output, color and life of solid state components.
- Module construction includes LED, heat sink and lens.
- Heavy gauge aluminum reflector anodized in clear, haze, gold, champagne and pewter color finish. Reflectors may provide with black and white milled groove baffle collar.

Junction Box

- Listed for through branch circuit wiring. (Max. 8 No 12 AWG 90° branch circuit conductors. (4 in, 4 out)
- (5) 1/2" knockouts with true pry-out slots and (4) knockouts with Romex cable clamp.
- Ground wire provided on J-box.

Mounting Channel Bracket

- Commercial mounting kit provided up to 5" vertical adjustment, which accommodates 1/2" EMT conduit, optional HB-24 or HBC-24 bar hanger or lathing channels for T-bar grid or concealed spline ceiling.

LED POWER SUPPLY

- 10-100% dimmable for 120V electronic low voltage dimmer switches.
- Driver feature power factor >.90, THD <20% and has integral thermal protection to sense over temperature or internal failure.
- Driver mounts externally to the module, allowing future replacement, if needed.

Warranty

- 50,000hr of lamp life.

Listing

- ETL Listed.
- State of California Title 24
- Energy star qualified

Job Information
Type:
Catalog #:
Project:
Comments:
Prepared by:

Transforming tomorrow's lighting....today!

ORDERING INFORMATION:

Example: (DLED-AFK6-26-50-UNV-DM)

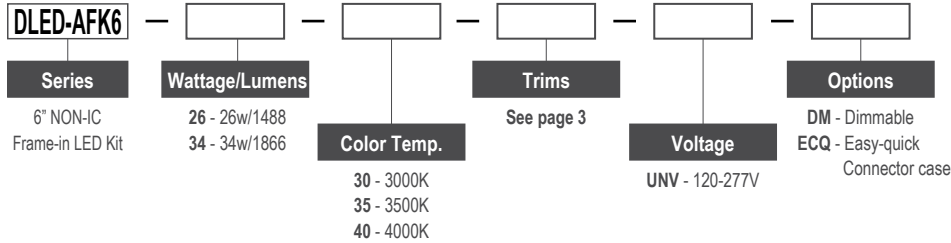

* Optional : Easy-quick connector case
(patent pending)

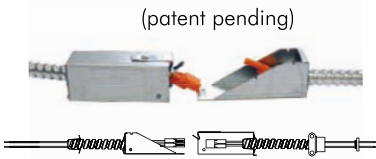

Job Information	
Type:	
Catalog #:	
Project:	
Comments:	
Prepared by:	

Transforming tomorrow's lighting....today!

6" NON-IC Frame-in LED Kit

PHOTOMETRY

DLED-AFK6

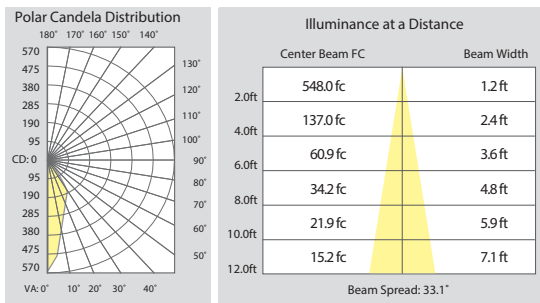

DLED-AFK6-34-N

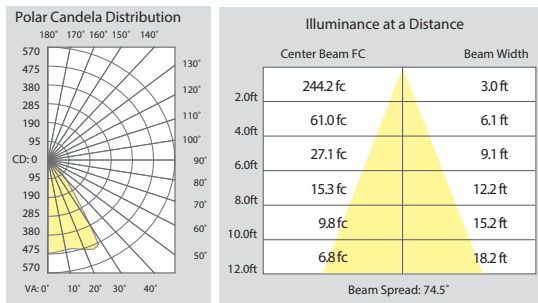

DLED-AFK6-34-W

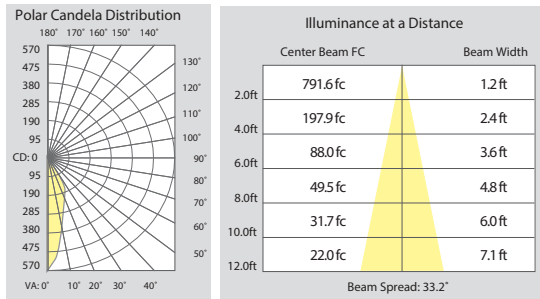

DLED-AFK6-43-N

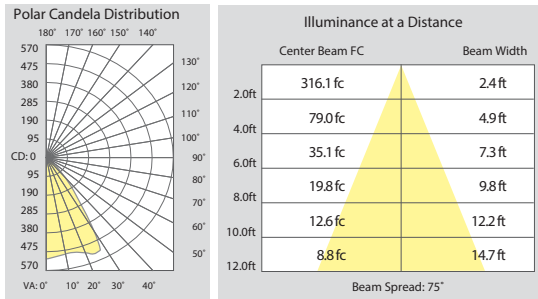

DLED-AFK6-43-W

TRIMS

REFLECTOR * White plastic ring standard. Also available with metal rings.



DLEDT-R64
Specular Open Reflector

DLEDT-R614
Baffle w/ Reflector

DLEDT-R641
Baffled lens w/ Reflector

DLEDT-R636
Wall Wash w/ Kick-off Plate

DLEDT-R640
Reflector w/ Frosted Drop Lens