

# **evaluation of diesel fuel cetane and aromatics effects on emissions from euro-3 engines**

Prepared for the CONCAWE Automotive Emissions Management Group by its  
Special Task Force AE/STF-18:

D H Cuvelier (Chairman)

R H Clark  
R De Craecker  
H J Guttman  
M Honkanen  
E B M Jansen  
G Martini  
E G Reynolds  
D J Rickeard  
G Wolff  
P J Zemroch

N D Thompson (Technical Coordinator)

Reproduction permitted with due acknowledgement

© CONCAWE  
Brussels  
March 2002

## ABSTRACT

Following EPEFE, the influence of two important diesel fuel quality parameters on emissions remained under debate. These were the difference (if any) between natural and additive-derived cetane and the influence of aromatics content. Another key issue was how emissions from more modern engines would be influenced by fuel quality. CONCAWE has therefore conducted a rigorous test programme to examine exhaust emissions from 3 light-duty vehicles and 2 heavy-duty engines representing Euro-3 technology levels. Two fuel matrices were tested to evaluate the influence of cetane (natural and improved) and aromatics (mono- versus poly-).

Fuel effects were generally small compared to engine technology effects and test variability. Despite the rigorous test design, statistically significant fuel effects were difficult to identify. Increasing cetane number had no significant effect on NO<sub>x</sub> or PM, but directionally reduced emissions of HC and CO. Cetane trends did not differentiate between natural and additive-derived cetane. Aromatics effects were small and showed variation between vehicles.

## KEYWORDS

exhaust emissions, diesel, diesel fuel, diesel engine, engine technology, vehicle technology, fuel quality, aromatics, mono-aromatics, poly-aromatics, cetane number, cetane improver, Euro-3

## INTERNET

This report is available as an Adobe pdf file on the CONCAWE website ([www.concaawe.be](http://www.concaawe.be)).

### NOTE:

*Considerable efforts have been made to assure the accuracy and reliability of the information contained in this publication. However, neither CONCAWE nor any company participating in CONCAWE can accept liability for any loss, damage or injury whatsoever resulting from the use of this information.*

*This report does not necessarily represent the views of any company participating in CONCAWE.*

<b>CONTENTS</b>		Page
<b>SUMMARY</b>		<b>V</b>
<b>1.</b>	<b>INTRODUCTION</b>	<b>1</b>
<b>2.</b>	<b>OBJECTIVES</b>	<b>2</b>
<b>3.</b>	<b>VEHICLE/ENGINE SELECTION</b>	<b>3</b>
	3.1. LD VEHICLES	3
	3.2. HD ENGINES	5
<b>4.</b>	<b>DESIGN OF FUEL MATRIX</b>	<b>7</b>
	4.1. INTRODUCTION	7
	4.2. AROMATICS MATRIX	7
	4.3. CETANE MATRIX	9
<b>5.</b>	<b>TEST METHODOLOGY</b>	<b>10</b>
	5.1. LD TEST PROGRAMME	10
	5.2. HD TEST PROGRAMME	11
<b>6.</b>	<b>STATISTICAL ANALYSIS METHODOLOGY</b>	<b>12</b>
<b>7.</b>	<b>RESULTS</b>	<b>14</b>
	7.1. TEST VARIABILITY AND FUEL EFFECTS	14
	7.2. FUEL AND VEHICLE EFFECTS	16
	7.3. CETANE NUMBER (CN) EFFECTS	21
	7.3.1. Cetane Matrix Analysis	21
	7.3.2. Cetane Effects on Emissions	21
	7.3.2.1. Summary of cetane effects	26
	7.3.2.2. Natural versus additive-derived cetane	26
	7.4. AROMATICS EFFECTS	27
	7.4.1. Total aromatics effects	32
	7.4.2. Mono- and Poly-aromatics effects	32
	7.4.2.1. Heavy-Duty	37
	7.4.2.2. Light-Duty	37
	7.4.2.3. Overall Evaluation	37
	7.5. LIGHT-DUTY MODAL EMISSIONS ANALYSIS	38
	7.6. PARTICULATE FILTER ANALYSIS FOR LD FLEET	43
<b>8.</b>	<b>CONCLUSIONS</b>	<b>48</b>
<b>9.</b>	<b>FURTHER WORK</b>	<b>50</b>
<b>10.</b>	<b>GLOSSARY</b>	<b>51</b>
<b>11.</b>	<b>REFERENCES</b>	<b>52</b>
<b>12.</b>	<b>ACKNOWLEDGEMENTS</b>	<b>53</b>

---

<b>APPENDICES</b>		<b>54</b>
<b>APPENDIX 1</b>	<b>OIL CHANGE PROCEDURE</b>	<b>54</b>
<b>APPENDIX 2</b>	<b>PROPERTIES OF TEST FUEL USED FOR LD VEHICLES INITIAL EMISSIONS COMPLIANCE</b>	<b>55</b>
<b>APPENDIX 3</b>	<b>EMISSIONS COMPLIANCE TEST RESULTS ON THE LD VEHICLES</b>	<b>56</b>
<b>APPENDIX 4</b>	<b>PROPERTIES OF TEST FUEL USED FOR HD ENGINE INITIAL EMISSIONS COMPLIANCE</b>	<b>57</b>
<b>APPENDIX 5</b>	<b>EMISSIONS COMPLIANCE TEST RESULTS ON THE HD ENGINES</b>	<b>58</b>
<b>APPENDIX 6</b>	<b>ANALYSIS RESULTS OF SAMPLES FROM AROMATICS MATRIX</b>	<b>60</b>
<b>APPENDIX 7</b>	<b>ANALYSIS RESULTS OF SAMPLES FROM CETANE MATRIX</b>	<b>61</b>
<b>APPENDIX 8</b>	<b>LD VEHICLE TEST PROTOCOL</b>	<b>62</b>
<b>APPENDIX 9</b>	<b>FUEL CHANGE PROCEDURE FOR LD VEHICLES</b>	<b>63</b>
<b>APPENDIX 10</b>	<b>HEAVY-DUTY TEST OPERATING CONDITIONS</b>	<b>64</b>
<b>APPENDIX 11</b>	<b>HEAVY-DUTY TEST PROTOCOL DETAILS</b>	<b>66</b>
<b>APPENDIX 12</b>	<b>STATISTICAL DATA ANALYSIS</b>	<b>67</b>
<b>APPENDIX 13</b>	<b>3-D PLOTS OF AROMATICS RESULTS</b>	<b>73</b>
<b>APPENDIX 14</b>	<b>COMPLEMENTARY TEST PROGRAMMES</b>	<b>81</b>

## SUMMARY

In view of the relationship between exhaust emissions from diesel engines and fuel quality, more stringent limits on diesel fuel specifications continue to be discussed. Much of the data to justify limits is based on studies using Euro-1 and Euro-2 engine technologies and test cycles. It was therefore important to conduct a study to quantify the impact of fuel quality in more modern diesel engines.

Three passenger cars and two heavy-duty engines, representing the range of typical Euro-3 technologies were tested. Fuel quality parameters were selected for evaluation in order to address two of the questions remaining from EPEFE, i.e. the impact on emissions of aromatics content (mono- versus poly-) and cetane number (natural versus additive-derived).

The Euro-3 MVEG test cycle was used for passenger cars and the European Steady-State Cycle (ESC) test was used for heavy-duty engines. Rigorous test protocols, based on EPEFE principles and refined following review with experts on advanced engines, were employed.

Fuel effects were generally found to be small compared to engine technology effects and test variability. Despite the rigorous test design, statistically significant fuel effects were difficult to identify.

Increasing cetane number had no significant effect on NO<sub>x</sub> or PM, but directionally reduced emissions of HC and CO, though these emissions were well below the Euro-3 limits. Cetane trends did not differentiate between natural and cetane.

Aromatics effects were small. In the heavy-duty engines, reducing aromatics reduced HC emissions but had no significant effect on PM, NO<sub>x</sub> or CO emissions. In the light-duty vehicles, aromatics effects varied between vehicles. Only one vehicle showed significant effects on PM and NO<sub>x</sub>; in this case NO<sub>x</sub> emissions decreased and PM emissions increased as aromatics were reduced. There were no consistent trends in HC emissions, but CO emissions tended to decrease with lower aromatics. As the total aromatics effects were small, it was not possible to quantify separately the relative contributions from mono- versus poly-aromatics.

## 1. INTRODUCTION

EPEFE [1] provided a thorough basis for understanding the interactions between diesel fuel quality and engine technologies for both the light-duty and heavy-duty diesel fleets. However, EPEFE was carried out in 1993-94 and so only included engine technologies up to Euro-2. Engine technologies continue to be developed in response to emissions legislation and the impact of more advanced (Euro-3) engine technologies needed evaluation.

Diesel passenger cars and heavy-duty engines complying with Euro-3 exhaust emissions limits were introduced into the marketplace in year 2000. Euro-4, the next stage of European emissions legislation, will take effect from 2005.

To achieve Euro-3 limits, improved hardware has been developed. This includes improved high pressure fuel injection equipment such as unit injectors, common rail injection and advanced electronically controlled rotary and in-line injection pumps. Better air-charging and intercooling, enhanced combustion, exhaust gas recirculation and exhaust gas after-treatment are also being introduced.

For this CONCAWE programme, examples of both light-duty (LD) vehicles and heavy-duty (HD) engines were selected. For heavy-duty, a 1-litre per cylinder and a 2-litre per cylinder engine were tested, one without and one with EGR, one with a high pressure in-line pump and one with unit injectors. For light-duty, three passenger cars were selected, equipped with common rail injection, unit injectors and an advanced rotary pump.

On fuel quality, the EPEFE test programme had evaluated in detail the influences of cetane number, poly-aromatics, density and back-end distillation (T95) on emissions. Following EPEFE, two important remaining diesel fuel quality questions were the difference (if any) between natural and additive-derived cetane and the influence of aromatics composition (mono- versus poly-). It was important to assess these effects in modern engine hardware.

## 2. OBJECTIVES

CONCAWE conducted a rigorous test programme to examine exhaust emissions from “Euro-3” technologies, using 3 light-duty vehicles and 2 heavy-duty engines. The programme was based on EPEFE principles, but with an enhanced test design, providing more long term repeats and with refinements to control test repeatability.

The main objectives of this programme were:

- To develop information on the relationships of diesel fuel aromatics and cetane levels with emissions from Euro-3 hardware when operated over the Euro-3 test cycles,
- To assess the specific impacts on emissions of:
  - Natural versus additive-derived cetane,
  - Aromatics composition (mono- versus poly-).

### 3. VEHICLE/ENGINE SELECTION

#### 3.1. LD VEHICLES

The three test vehicles were chosen on the basis of the following main criteria:

- to be representative of engine technologies that were likely to be adopted to meet Euro-3 emissions limits;
- to feature different engine technologies, especially with regard to the fuel injection systems;
- to meet Euro-3 emissions limits or not exceed them by more than 10%<sup>1</sup>;
- vehicle mileage in the range from 5000 km to 50,000 km.

At the time of vehicle selection, CONCAWE was of the opinion that Euro-3 LD engines would be based on direct injection technology and that they would feature advanced fuel injection systems, like common rail or unit injectors, non-cooled EGR for NO<sub>x</sub> reduction and enhanced oxidation catalysts for the reduction of HC, CO and PM. Passenger cars homologated for Euro-3 limits, now on the market, confirm that those forecasts were correct.

Almost all diesel vehicles currently marketed are equipped with direct injection engines due to their better fuel economy and CO<sub>2</sub> emissions performance in comparison to indirect injection engines. As a result of CO<sub>2</sub> emission reduction targets, direct injection has largely displaced indirect injection technology.

Direct injection engines have achieved significant advantages, in terms of emissions reduction and performance improvement, through the introduction of enhanced or new fuel injection systems. While conventional fuel injection systems like rotary pumps do not seem to be capable of further major improvements, the potential of new high pressure fuel injection systems like common rail or unit injectors still has to be fully exploited. As a consequence, the latter injection systems are likely to become more widespread.

On the basis of the above considerations, it was decided to include in the vehicle test fleet one passenger car model equipped with each of the fuel injection technologies (rotary pump, common rail and unit injectors), selecting the most advanced engine available at the time. Three different passenger cars (vehicles A, B and C) were selected and their main technical characteristics are reported in **Table 1**.

---

<sup>1</sup> At the time the test vehicles were selected, no LD diesel passenger cars homologated to Euro-3 standards were available.



**Table 1** Light-duty Vehicle Descriptions

Vehicle Type	Vehicle A	Vehicle B	Vehicle C
Displacement (cm <sup>3</sup> )	2151	1896	1995
Max. Power (kW @ rpm)	92 @ 4200	85 @ 4000	60 @ 4300
Inertia Class (kg)	1340	1440	1280
Cylinder	4	4	4
Valves per Cylinder	4	2	4
Max. Torque (Nm @ rpm)	300 @ 1800-2600	285 @ 1900	185 @ 1800 rpm
Compression Ratio	19:1	18:1	18.5:1
Aspiration	TC	TC	TC
Intercooler Y (yes) N (no)	Y	Y	N
Combustion Type	DI	DI	DI
Injection System	Common Rail	Unit Injector	Rotary Pump
EGR Y (yes) N (no)	Y	Y	Y
Oxidation Catalyst Y (yes) N (no)	Y ( 1 close coupled + 1 underfloor)	Y	Y

These vehicles were all homologated to Euro-2 but were understood from contacts with the manufacturers to be models which would meet Euro-3 and which would survive into the Euro-3 era. To be accepted into the programme, the vehicles had to meet Euro-3 emissions limits or exceed them by no more than 10%.

The initial mileage of the vehicles and their conditioning are summarised in **Table 2**.

**Table 2** Initial vehicle mileage and conditioning

	Registration Date	km as received	km at start of test
Vehicle A	07/07/99	25	5025
Vehicle B	09/04/99	4150	6550
Vehicle C	15/06/99	16,837	18,337

Reference tests were carried out on each vehicle to check the emission levels.

Prior to testing, the engine oil was replaced with fresh oil as specified in the operators' manual (the oil change procedure is given in **Appendix 1**). In order to eliminate the lighter fraction of the oil that could interfere with emission measurement, the oil was conditioned for 1500 km. The general condition of the cars was checked again prior to the start of emissions testing.

The vehicle exhaust systems were modified to sample raw exhaust gas pre- and post-catalyst and to measure exhaust gas temperature. The fuel systems were modified to facilitate fuel changes. In two cases (vehicles A and B) it was possible to use an external tank linked to the fuel system; the third vehicle (vehicle C) was fuelled by means of the original tank.

Using a suitable fuel change procedure the fuel was changed to the reference fuel (RF-73; properties are listed in **Appendix 2**). Emission tests with the reference fuel were then performed. Three cold-start year 2000, MVEG emissions tests were carried out on each vehicle according to the specified protocol.

The emissions test results obtained are reported in **Appendix 3**. Two of three vehicles met the Euro-3 emission limits; the third gave emissions higher than the Euro-3 limits but within the 10% acceptance criterion. As a consequence, the three vehicles were accepted for use in the test programme.

### 3.2. HD ENGINES

The HD test engines were selected using similar criteria to those used to select the LD vehicles. In particular, the test engines had to be representative of the technologies that would be adopted to meet Euro-3 emission limits and, if possible, to feature different emission control technologies. The number of the engines to be included in the test programme was dependent on the availability and on the range of technologies to be tested but a minimum of two engines was required.

At the time of selection, Euro-3 HD engines were not on the market. There was only one engine available at the production stage and a few others at the prototype stage. Due to the limited availability, it was decided to test only two engines, one in the 2 litres per cylinder range and the other in the 1 litre per cylinder range.

Euro-3 HD engines were expected to be equipped with turbocharger, intercooler, advanced high pressure injection systems, multi-valve cylinder head and electronic management systems; no aftertreatment devices were considered necessary. EGR system was not considered strictly necessary but it represents a viable option to improve fuel economy. Therefore, it was decided that at least one of the two engines should be equipped with EGR. The engines tested were prototype Euro-3 technologies as identified in **Table 3**:

**Table 3** Technical Characteristics of HD engines

	ENGINE 1	ENGINE 2
Engine Type	DI/TCI	DI/TCI
Displacement (l)	7.28	10.64
Cylinder	6	6
Valve/cylinder	2	4
FIE	In-line Pump	Unit Injector
EGR	No	Yes (Cooled)

To check the compliance of the two engines with Euro-3 limits, the new legislative tests for HD engines (ESC and ELR) were carried out on each engine, using a reference fuel meeting year 2000 specifications. The main properties of the reference fuel are given in **Appendix 4**.

The new legislative procedure for diesel HD engine emission testing has introduced three new test types:

- ESC cycle (European Steady-state Cycle);
- ELR cycle (dynamic load response test for smoke);
- ETC cycle (European Transient Cycle).

The cycle used to certify Euro-3 engines depends on the engine type:

- for conventional diesel engines, the ESC and ELR cycles have to be used;
- for diesel engines equipped with advanced aftertreatment systems (DeNOx catalysts, PM traps, etc.), ESC, ELR and ETC have to be used;
- for gas engines, only ETC is used.

On this basis, the two engines were tested according to the ESC and ELR procedures. Both engines met the Euro-3 emissions standards. The results of the reference tests are presented in **Appendix 5**.

## 4. DESIGN OF FUEL MATRIX

### 4.1. INTRODUCTION

In this study the impact of certain fuel parameters on emissions were to be evaluated, namely aromatics composition (mono- versus poly-) and cetane number (natural versus additive-derived). Two fuel matrices were designed to evaluate the possible impact of mono-, poly- and total aromatic hydrocarbon content and to allow discrimination between natural and enhanced cetane number. The matrices were designed to be orthogonal and de-correlated in the main test parameters while keeping all other properties as constant as possible. Values for other important properties such as density, sulphur and T95 were tightly controlled as outlined in **Table 4**. The other fuel parameters had to meet EN 590 requirements and were targeted as close as possible to the average fuel quality currently marketed.

**Table 4** Blending targets for density, sulphur and T-95

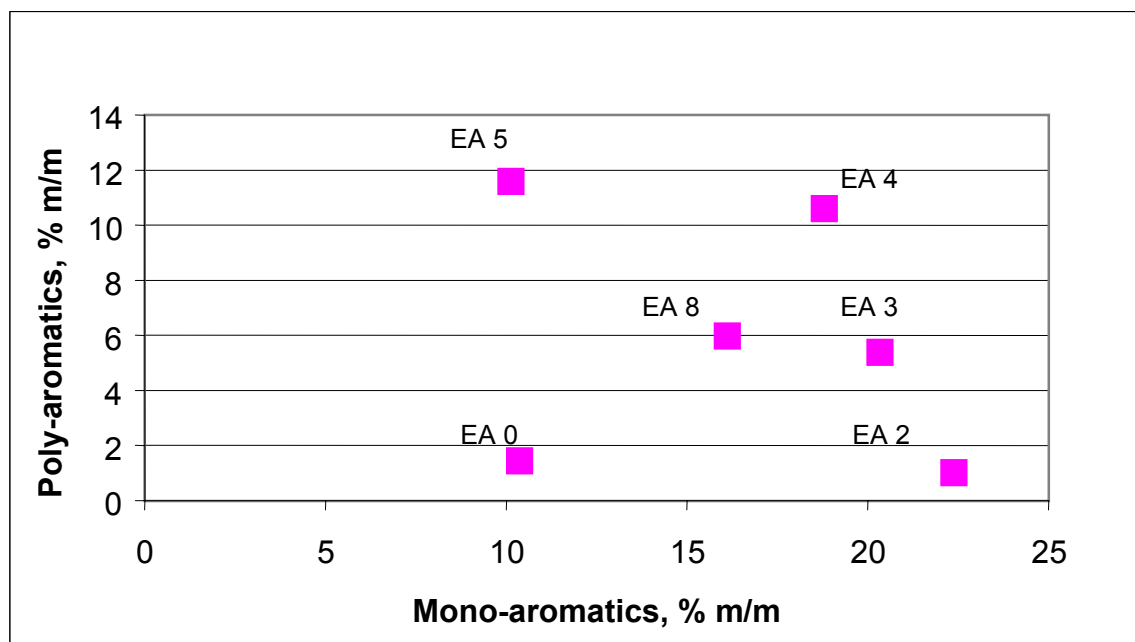
Property	Target	EN 590
Density, kg/m <sup>3</sup>	837 ± 1.5	820-845
Sulphur, mg/kg	300 ± 15	Max. 350
T 95, °C	355 ± 8	Max. 360

### 4.2. AROMATICS MATRIX

An orthogonal fuel matrix (mono- versus poly-aromatics) was planned, with the target to blend 4 corner fuels, plus a centre point fuel and one additional fuel with high mono-aromatics at the mid-point of poly-aromatics. The density, T95 and the sulphur level were kept constant as outlined in the **Table 4**. Within the aromatic matrix, the target was to maintain cetane number as constant as possible.

Producing perfectly orthogonal matrices is always a challenge to the blenders. **Figure 1** shows that the target aromatics levels were quite well achieved, considering all of the constraints that had to be met and the components available.

**Figure 1** Mono- and poly-aromatics in the aromatics fuel matrix.



All fuels were analysed by seven laboratories. The average results are given in **Table 5**, with more detail in **Appendix 6**. The blending targets for the fixed parameters were met for most parameters. An important exception was the cetane number of EA 0, which was significantly higher than for the other fuels, as a consequence of its low aromatic content.

**Table 5** Key properties of fuels from the aromatics matrix

Property	EA 0	EA2	EA3	EA 4	EA 5	EA8
Aromatic HC Distribution, IP 391/95						
Total Aromatics, %m/m	12.0	23.4	25.7	29.4	21.7	22.1
Mono-aromatics, %m/m	10.4	22.4	20.3	18.8	10.1	16.1
Poly-aromatics, %m/m	1.5	1.0	5.4	10.6	11.6	6.0
Cetane Number, ASTM D 613	58.3	51.4	53.3	51.1	52.7	52.4
Density @ 15°C, ASTM D 4052, kg/m <sup>3</sup>	836.1	836.5	837.9	837.4	837.8	838.4
T95, °C, ASTM D 86	363	355	357	346	349	355
Sulphur, ASTM D 2622, mg/kg	290	311	302	311	307	308

### 4.3. CETANE MATRIX

Cetane quality is defined by cetane number, which is measured in the cetane engine. The crude source and processing conditions determine the level of the cetane number. Cetane number can be enhanced by the use of cetane improver additives. For this study a distinction has been made between natural and cetane enhanced fuels.

As in the aromatic matrix, the other fuel parameters such as density, sulphur, T95 and aromatics were targeted to be kept constant.

Five fuels were blended covering cetane numbers between 49 and 58. Cetane improver (2-ethylhexylnitrate) was used in FC1, FC3 and FC5. In FC2 and FC4, no cetane improver was added. FC2 is the same fuel as EA3 in the aromatics matrix. FC3 and FC5 were obtained by adding cetane improver to FC2 and FC4 respectively. For FC1, the cetane improvement was calculated from the additive boost data generated during the blending stage. **Table 6** shows the final cetane number results and the additive-derived cetane boost.

**Table 6** Cetane matrix

	FC1	FC2	FC3	FC4	FC5
Final Cetane Number, ASTM D 613	49.4	53.3	54.9	54.5	58.2
Additive-derived cetane	4.7	0.0	1.6	0.0	3.7

As for the aromatics matrix, the fuel properties were analysed by seven laboratories. **Table 7** shows the average results for the fuels in the cetane matrix. The blending targets were met, except for a small deviation on sulphur on FC3. The mono- and poly-aromatic contents were judged to be within an acceptable blending range over the five fuels. More detailed analysis results are given in **Appendix 7**.

**Table 7** Key Properties of fuels from the cetane matrix

Property	FC1	FC2	FC3	FC4	FC5
Aromatic HC Distribution, IP 391/95					
Total Aromatics, %m/m	24.2	25.7	25.9	23.7	23.7
Mono-aromatics, %m/m	18.8	20.3	20.4	18.1	18.1
Poly-aromatics, %m/m	5.3	5.4	5.4	5.6	5.6
Cetane Number, ASTM D 613	49.4	53.3	54.9	54.5	58.2
Density @ 15°C, ASTM D 4052, kg/m <sup>3</sup>	837.8	837.9	837.9	836.5	836.5
T95, °C, ASTM D 86	358	357	358	359	359
Sulphur, ASTM D 2622, mg/kg	293	302	276	296	295

## 5. TEST METHODOLOGY

To improve test result acceptance, all tests were run according to the official test methods. These are the year 2000 MVEG cycle for passenger cars [2], and the revised European Steady-State Cycle (ESC) for the heavy-duty engines [3]. The European Load Response (ELR) Test was also run on the heavy-duty engines but is not analysed in this report. Tests were conducted in both Member Company and independent test laboratories.

Analysis of the test results was done with the help of a statistical expert, familiar with the methodology for handling similar emissions data sets, e.g. in the Auto Oil programmes.

### 5.1. LD TEST PROGRAMME

Emissions tests were carried out according to the year 2000, MVEG cycle [2]. Principles and procedures adopted were generally those defined in the EPEFE Vehicle and Engine Testing Protocol Manual, Annexe 1 of the EPEFE Report [1].

However, compared to the EPEFE test programme, an improved experimental design was used. In order to achieve more long term repeats, it was decided not to carry out “back-to-back” repeats on the same fuel and instead, to carry out three blocks of tests, one block consisting of a single test on each fuel (10 tests total). Each block had a different fuel order. This randomised block design minimises the risk of fuel effects being biased by unexpected effects such as carry-over or performance drift. Details are given in **Table 8**.

**Table 8** Test Sequence

	Fuel Order									
<b>Block 1</b>	FC1	FC3	FC4	FC5	EA0	EA2	EA3	EA4	EA5	EA8
<b>Block 2</b>	FC3	FC5	EA2	EA4	EA8	FC1	FC4	EA0	EA3	EA5
<b>Block 3</b>	EA8	EA5	EA4	EA3	EA2	EA0	FC5	FC4	FC3	FC1

As a consequence, at least three single tests were carried out on each fuel in each vehicle. Fuel change was required before every test. The acceptability of repeatability of the three tests on each fuel was developed based on EPEFE and refined by experts with knowledge of the emissions performance of Euro-3 engines. The following basis (**Table 9**) was used :- *Ratio: (Max. result)/(Min. result) < factor, where factors are as below:-*

**Table 9** Repeatability basis for LD tests

LD diesel (average of 3 measurements )	HC <0.05g/km	HC >0.05g/km	CO <0.10g/km	CO >0.10g/km	NOx	PM <0.06g/km	PM >0.06g/km
Factor	1.65	1.40	1.55	1.35	1.15	1.40	1.25

When the differences exceeded these limits, an additional test was run at the completion of the initially planned series of tests. The details of the LD test protocol, including the fuel change and conditioning procedure, are reported in **Appendices 8 and 9**.

## 5.2. HD TEST PROGRAMME

Emissions tests were carried out according to the new certification cycles prescribed for Euro-3 and beyond HD diesel engines [3]. Conventional HD diesel engines without advanced aftertreatment devices have to be tested both on the ESC (European Steady-state Cycle) cycle and the ELR (European Load Response) test.

The operating conditions to be used in the ESC cycle were defined according to the procedure and are reported in **Appendix 10**. For each test fuel, three different tests were carried out in the following order:

- 1 x Full Load test
- 1 x ELR
- 1 x ESC

As for the LD test programme, no “back-to-back” repeats on the same fuel were carried out and the same test sequence and fuel order was used (**Table 8**). Three blocks of tests were performed so that each fuel was tested at least three times.

The acceptability of repeatability of the three tests on each fuel was developed on the same principles as for the LD testing. The following basis was used: *Ratio: (Max. result)/(Min. result) < factor, where factors are as in Table 10.*

**Table 10** Repeatability basis for HD tests

HD diesel	HC	CO	NOx	PM
Factor	1.5	1.1	1.1	1.1

When the differences exceeded these limits, an additional test was planned to be run on completion of the initial series of tests. In practice, no repeats were needed. Details of the test protocol are given in **Appendix 11**.



## 6. STATISTICAL ANALYSIS METHODOLOGY

The test programme was constructed using the principles of statistical experimental design. Each of the 10 fuels was tested three times in each vehicle/engine using a randomised block design, the test order being described in **Table 8**.

Each fuel was tested once in each block of 10 tests minimising the risk of fuel comparisons being biased by any systematic trends in emissions over time. Provision was made for additional tests to be performed if the variation in the three results for a particular vehicle  $\times$  fuel combination was greater than expected (**Appendix 12**). Each emission (HC, CO, NO<sub>x</sub>, PM) was examined on a vehicle-by-vehicle (engine-by-engine) basis.

In the EPEFE gasoline project [1] and other previous emission studies [4,5,6], the variability in emissions measurements has typically been found to follow a log-normal distribution with the degree of scatter increasing as the emission level increases. Standard deviation vs. mean plots, e.g. **Figure A.12.1**, suggested that the present light-duty and heavy-duty diesel emissions data behaved similarly although this assumption was difficult to verify rigorously as the levels of emissions differed little from fuel to fuel in any particular vehicle (**Appendix 12**).

The data were examined for outliers and trends by plotting studentized residuals (on a log scale) against test number. There were some very strong trends in the data with certain emissions (e.g. HC for Vehicle C, see **Figure A.12.3**) showing either a consistent decrease or a consistent increase as time progressed. Such data sets were adjusted using analysis of covariance techniques to eliminate any bias that might be caused by such trends, see **Figure A.12.2**. Adjustments were only made for data sets where there was an unambiguous linear trend significant at  $P < 0.1\%$ .<sup>2</sup>

The particulate matter emissions from engine 1 followed a more complicated pattern, showing a strong linear decrease over tests 1 to 20 and then settling into a steady level of emissions, see **Figure A.12.3**. These emissions were adjusted to what they might have been had all tests been conducted in the period of steady emissions, see **Figure A.12.2**. Thus the adjusted emissions are somewhat lower than the unadjusted values.

The HC measurement in one test on engine 1 was rejected as an outlier due to calibration problems. One entire test on vehicle B was also considered suspect and rejected as the ambient temperature was outside the regulated range.

Analyses of both the adjusted and unadjusted data were carried out. Adjustments had little effect on the mean emissions for each fuel due to the robust randomised block experimental design used. Only the final corrected data-set was used for the final analysis described in this report.

In the tables and graphs in this report, simple arithmetic means are used to summarise the emissions for each vehicle  $\times$  fuel (or engine  $\times$  fuel) combination. Linear and multiple regression analyses are used to relate emissions to fuel properties on a vehicle-by-vehicle (or engine-by-engine) basis. Adjustments were made to the analysis to take into account the log-normality in the data using a similar methodology to that employed in the EPEFE programme [1] (**Appendix 12**).

---

<sup>2</sup>  $P < 0.1\%$  = The probability that such an effect could be observed by chance when no real effect exists is less than 0.1%. In other words 99.9% confidence that the effect is real.

The error bars in the figures in **Section 7** show the mean value  $\pm 1.4 \times \text{SE (mean)}$ .<sup>3</sup> These were constructed so that when two fuels are significantly different from one another at  $P < 5\%$ <sup>4</sup>, their error bars will not overlap.

---

<sup>3</sup> SE (mean) = standard error of the mean values.

<sup>4</sup>  $P < 5\%$  = 95% confidence.

## 7. RESULTS

Analysis of the light-duty fleet data was based on results from the MVEG test cycle. For heavy-duty, only the regulated emissions data from the ESC tests were analysed in detail. Smoke opacity levels measured in the ELR test were very low compared to the Euro-3 limits and were not considered further.

### 7.1. TEST VARIABILITY AND FUEL EFFECTS

The pooled standard deviations for emission measurements on each vehicle and engine are shown in **Table 11**, which shows that the test precision compares favourably with EPEFE.

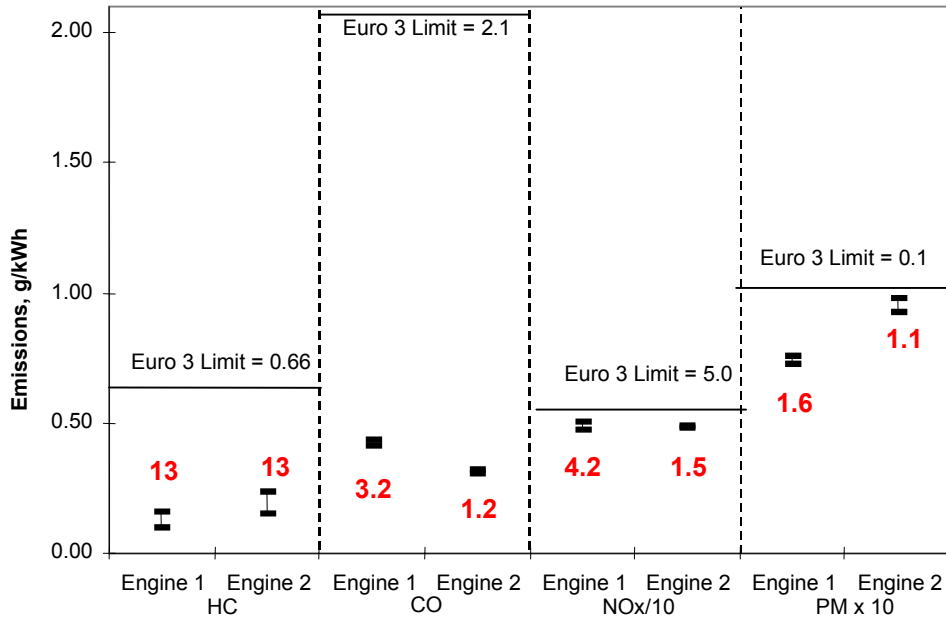
**Table 11** Standard deviation (SD) of sets of non-consecutive emission measurements on the same vehicle (or engine) × fuel combination (“long repeats”) expressed as a percentage of the measured emission.

	Light-duty		Heavy-duty	
	CONCAWE Euro-3 study	EPEFE	CONCAWE Euro-3 study	EPEFE
HC	9.0%	15.5%	3.5%	5.1%
CO	10.3%	13.2%	2.8%	5.6%
NOx	5.6%	4.0%	2.0%	1.3%
PM	9.7%	10.3%	3.9%	4.9%

The EPEFE SDs were obtained from a “variance components” analysis of log (emissions).

**Figures 2 and 3** show the maximum differences between fuels versus the test-to-test SD for the HD and LD tests respectively. The Euro-3 limit values are also shown.

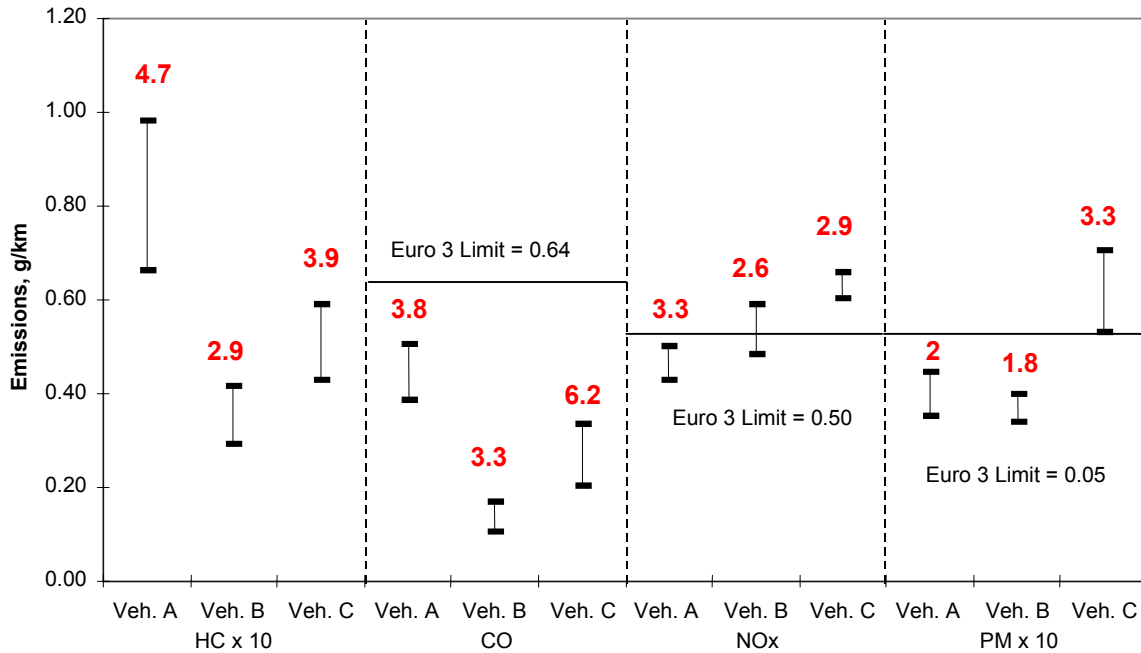
**Figure 2** Maximum differences between fuels and test-to-test SD; HD Engines



Notes: Bars indicate the range of fuel response.  
 Numbers indicate ratio of maximum fuel difference to test-to-test SD  
 The least significant difference at P < 5% is a factor of 1.7 times the SD if three tests are conducted for each vehicle(or engine)\*fuel combination.

NOx and PM emissions for the HD engines were close to the Euro-3 limits. The ratio of fuel response to test-to-test SD was small, indicating that fuel effects on PM and NOx emissions would be difficult to distinguish. For HC, the range of fuel variations was larger relative to the test-to-test SD. However, both HC and CO emissions were much lower than the regulated limits (HC <30%, CO <25% of the limits).

**Figure 3** Maximum differences between fuels versus test-to-test SD; LD vehicles



Notes: Bars indicate the range of fuel response.  
 Numbers indicate ratio of maximum fuel difference to test-to-test SD  
 The least significant difference at P < 5% is a factor of 1.7 times the SD if three tests are conducted for each vehicle(or engine)\*fuel combination.

As described in **Section 3**, two of the vehicles met the Euro-3 emissions limits and one (Vehicle C) slightly exceeded the Euro-3 limits when tested on the RF-73 reference fuel. Consistent with the heavy-duty engines, PM and NOx emissions from the light-duty vehicles were close to the Euro-3 limits, but fuel effects were small. Fuel differences were larger for HC and CO emissions but again these were not critical versus the Euro-3 limits.

**7.2. FUEL AND VEHICLE EFFECTS**

The emissions levels for the LD and HD fleets, calculated as the arithmetic means of results from each of the three vehicles and two engines across all the fuels, are shown in **Table 12** and compared with the average data for the EPEFE fleet.

**Table 12** Emissions results compared with the EPEFE fleet

HD, g/kWh	HC	CO	NOx	PM
Engine 1	0.129	0.427	4.95	0.074
Engine 2	0.198	0.313	4.86	0.096
EPEFE Fleet	0.253	0.610	6.59	0.122

LD, g/km	HC	CO	NOx	PM
Vehicle A	0.080	0.474	0.460	0.041
Vehicle B	0.035	0.139	0.537	0.036
Vehicle C	0.052	0.275	0.629	0.065
EPEFE Fleet	0.080	0.405	0.542	0.054

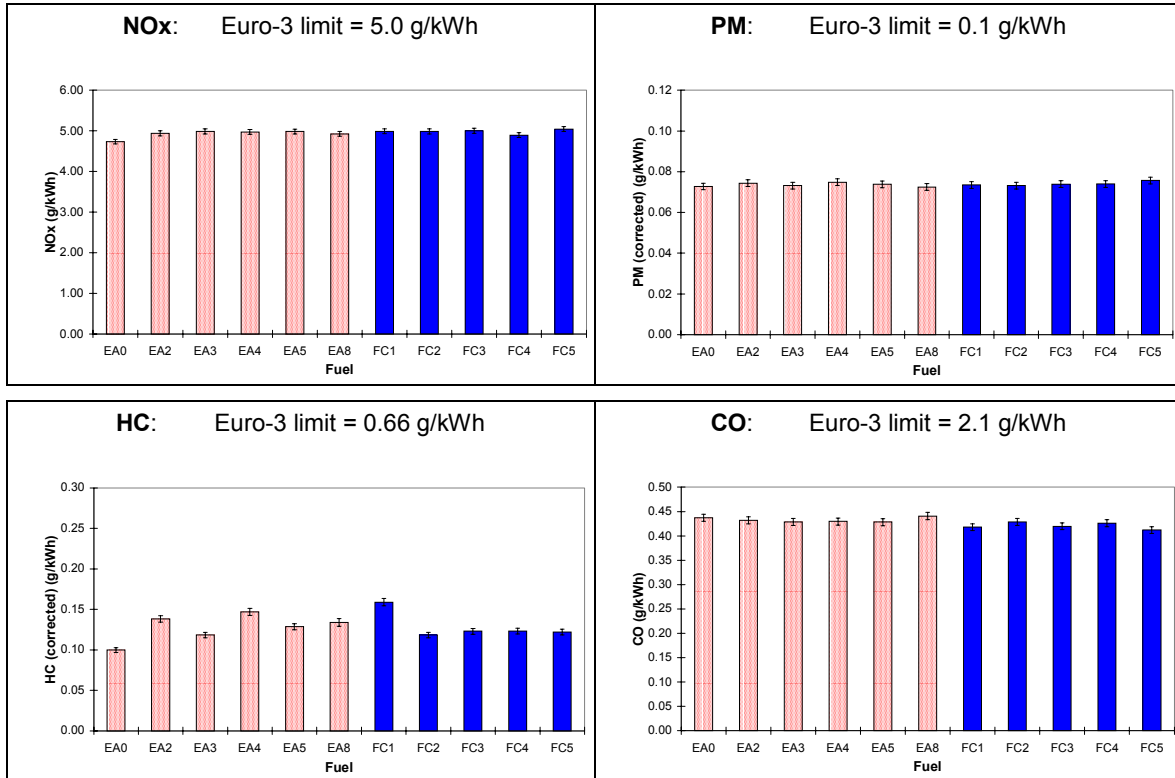
Compared with the EPEFE prototype Euro-2 fleet, emissions from the two HD engines tested here were 25-40% lower, with lower emissions for all four pollutants.

The LD vehicle fleet tested here averaged 25-30% lower HC and CO emissions, and about the same levels of PM and NOx emissions.

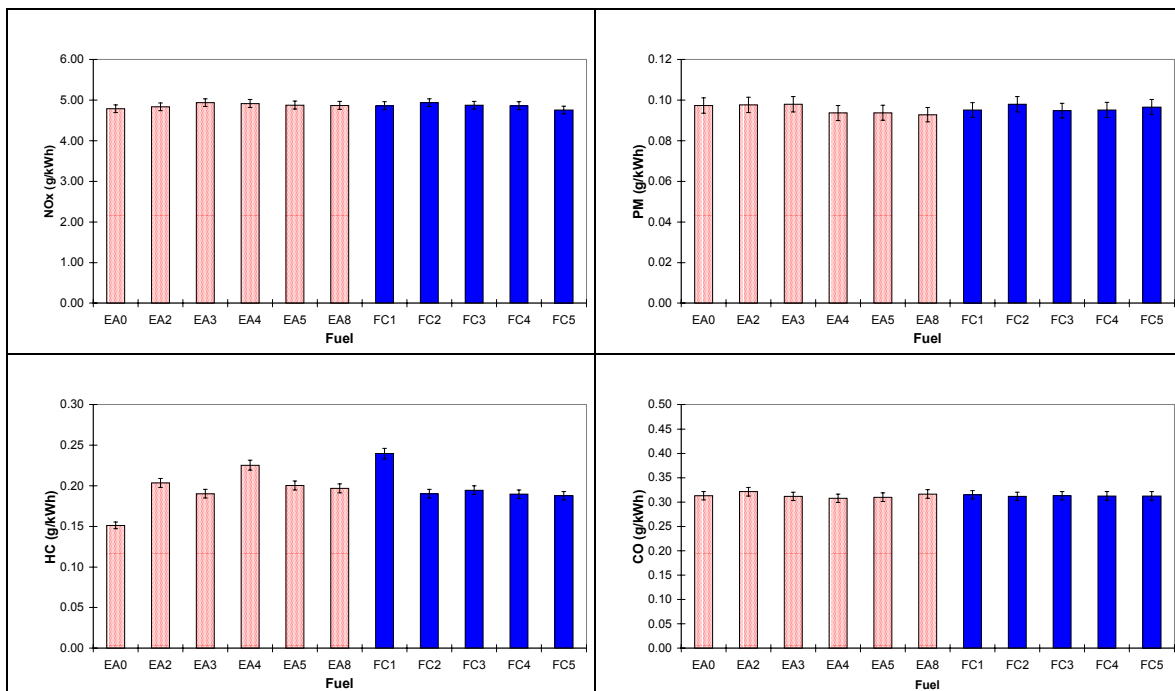
The mean emissions for each of the ten test fuels on each engine and vehicle are shown in **Figure 4**.

**Figure 4** Individual vehicle/engine results (arithmetic means)

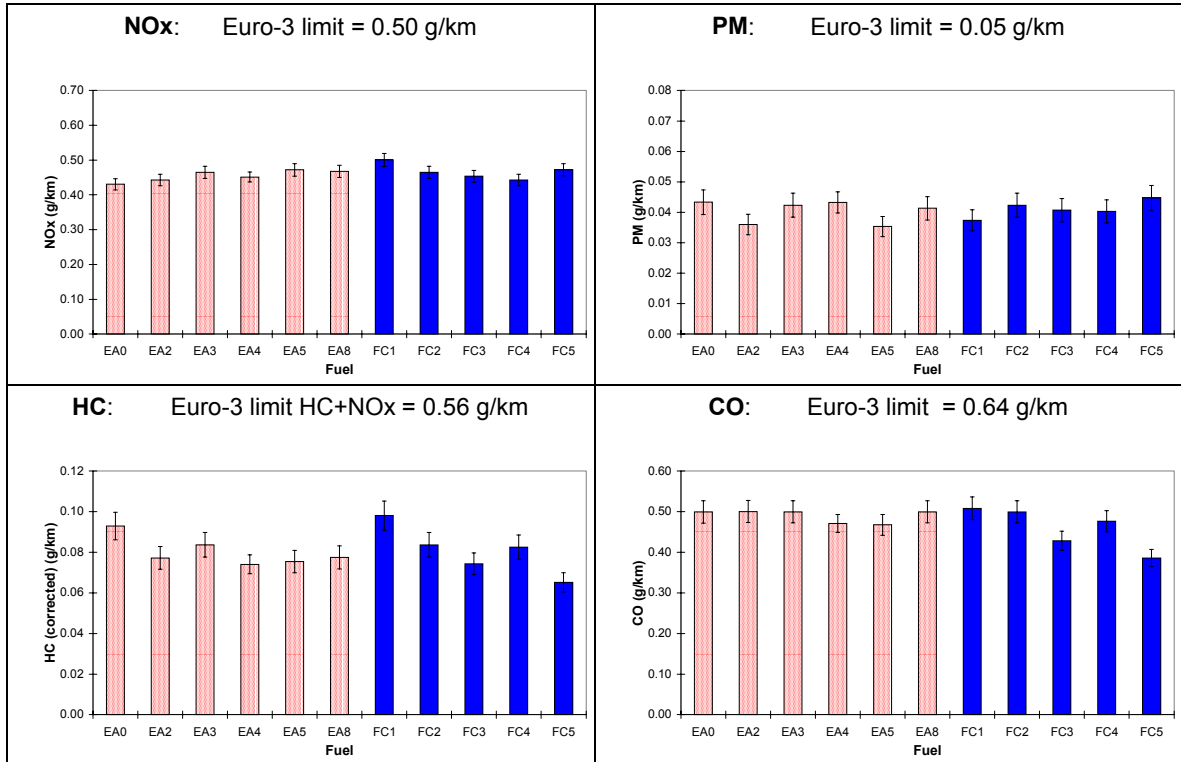
**Engine 1:**



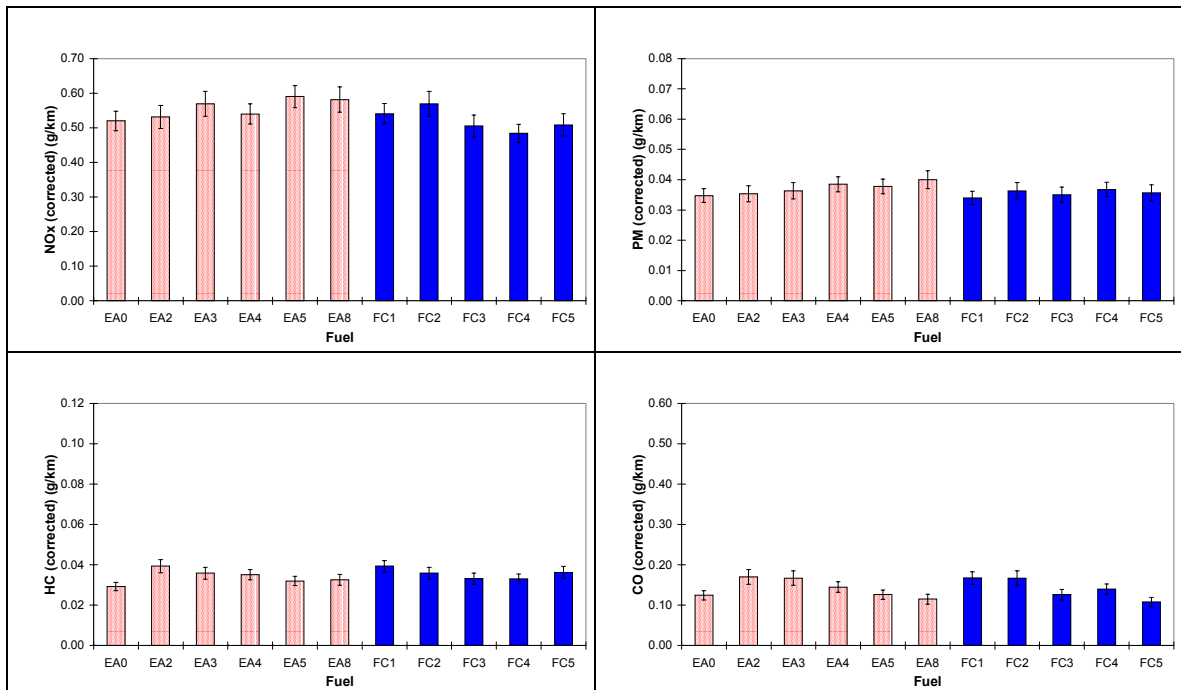
**Engine 2:**



**Vehicle A:**

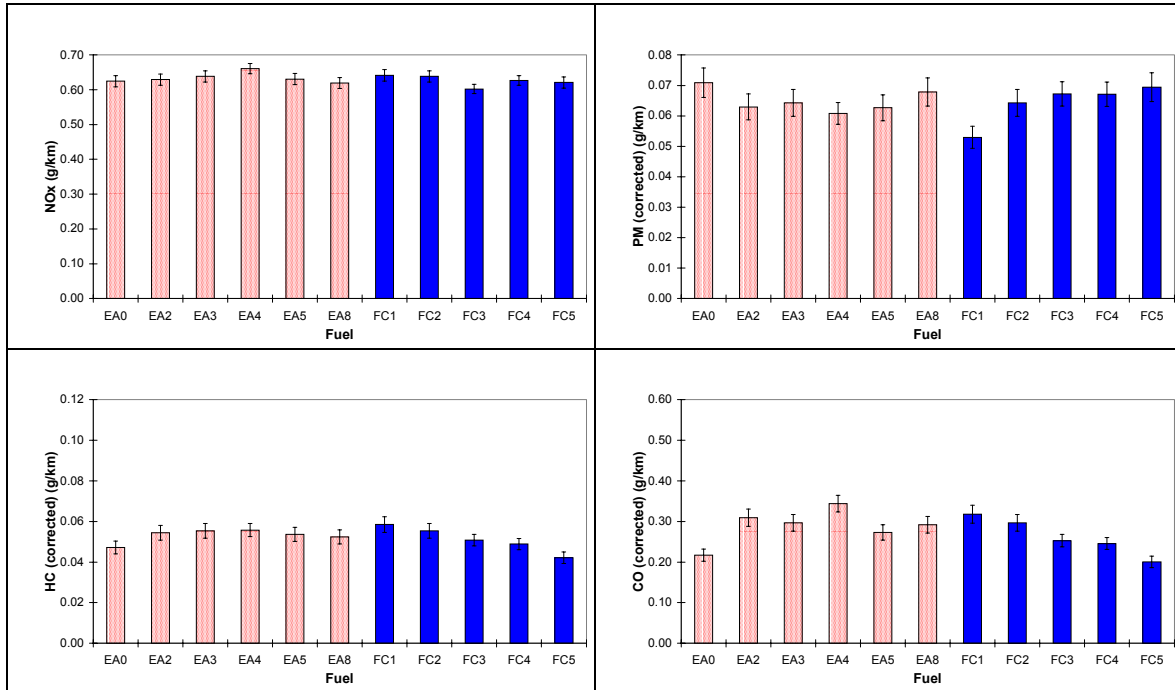


**Vehicle B:**





**Vehicle C:**



For the HD engines, fuel effects were only significant for HC emissions and these are discussed in later sections. The two engines responded to fuels in very similar ways in relative terms. Fuel effects on NOx emissions just failed to be significant at  $P < 5\%$  with fuel EA0 giving slightly lower emissions than the others. There were no significant fuel effects on CO and PM emissions.

For LD vehicles, fuel effects on HC and CO emissions were significant, with some differences in the patterns of response in the different vehicles. For example, fuel EA0 gave low HC and CO emissions in vehicles B and C but not in vehicle A. Fuel effects on NOx and PM emissions were smaller but still statistically significant in some cases.

Analysis of the fuel effects is discussed in **Sections 7.3 and 7.4.**

### 7.3. CETANE NUMBER (CN) EFFECTS

#### 7.3.1. Cetane Matrix Analysis

Before analysing the cetane results, the fuel matrix was studied carefully to determine its suitability to identify cetane effects free of influences from other variables. For the full cetane matrix (FC1-FC5) there were several strong correlations with CN. Such statistical correlations can be ignored if the range of variation in the correlating variable is small, but in the case of KV40, T50 and T10 the range was too large to ignore. The reason for the correlations is fuel FC1, which differs in several key parameters from the other fuels in the matrix. It was therefore decided to exclude this fuel from the cetane analysis and use only fuels FC2-FC5. The correlation matrix for this reduced fuel set is shown in **Table 13**.

**Table 13** Matrix of Correlation coefficients (R) for cetane fuels FC2-FC5

	Total aromatics	Mono-aromatics	Poly-aromatics	Cetane Index	Cetane Number	Density	T10	T50	T95	Sulphur	KV40
Total aromatics	1.00										
Mono-aromatics	1.00	1.00									
Poly-aromatics	-0.98	-0.98	1.00								
Cetane Index	-1.00	-1.00	0.99	1.00							
Cetane Number	-0.59	-0.61	0.70	0.58	1.00						
Density	1.00	1.00	-0.98	-1.00	-0.59	1.00					
T10	0.97	0.97	-0.96	-0.95	-0.76	0.96	1.00				
T50	-0.99	-0.99	1.00	1.00	0.64	-1.00	-0.96	1.00			
T95	-0.91	-0.92	0.97	0.92	0.84	-0.92	-0.95	0.95	1.00		
Sulphur	-0.38	-0.36	0.18	0.30	-0.13	-0.34	-0.35	0.26	0.05	1.00	
KV40	-1.00	-1.00	0.98	1.00	0.60	-1.00	-0.97	1.00	0.92	0.35	1.00

Although some correlations with cetane still appear, the range of variation in the correlated fuel properties is small (see below) and can be safely ignored.

- Poly-aromatics: 5.4 - 5.6% m/m
- T95: 357 – 359°C
- T10: 213 – 217°C

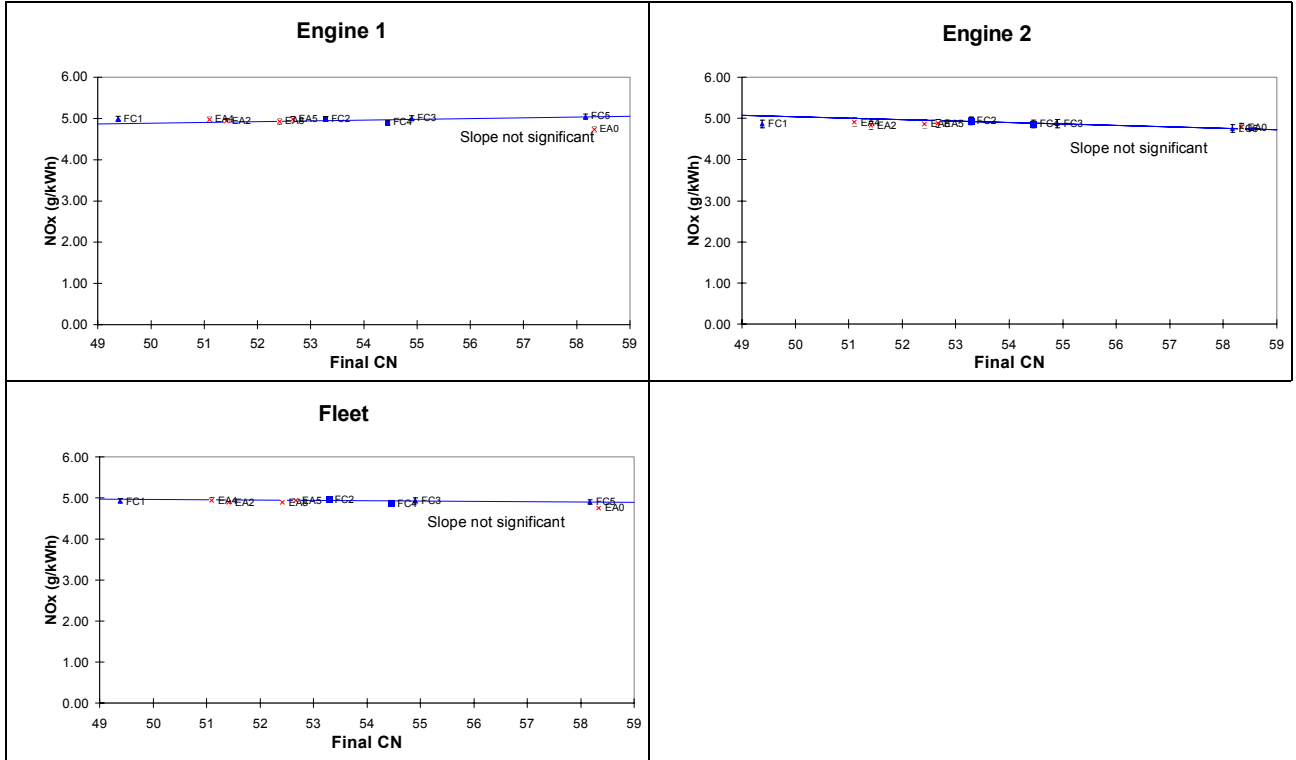
#### 7.3.2. Cetane Effects on Emissions

To show the effects of cetane number, results for each vehicle/engine, plus the LD and HD fleet averages are plotted in **Figure 5**. Regression lines are shown based on fuels FC2-FC5. Results for fuel FC1 and for the aromatics matrix fuels are also shown on the figures, but were not used in deriving the regression lines. By examining the cetane effects derived from fuels FC2-FC5 and comparing emissions with the other fuels we can evaluate:

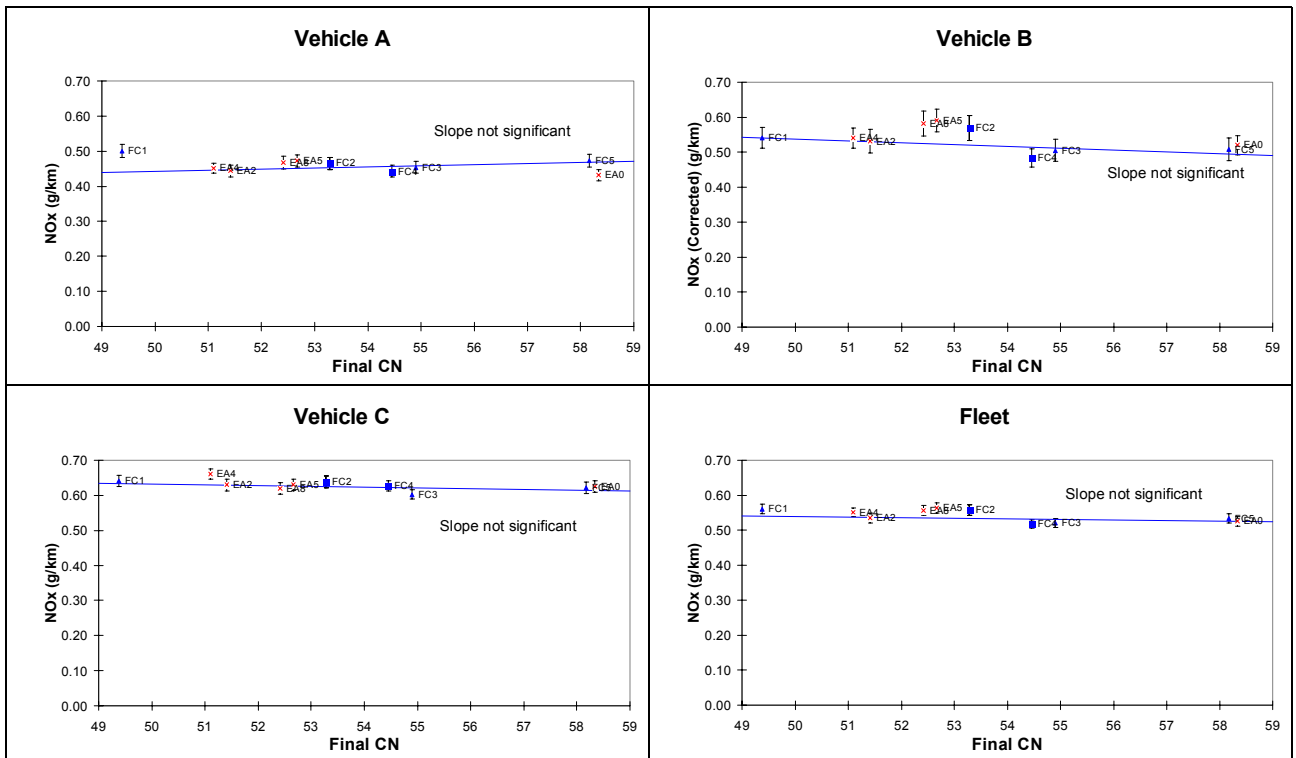
- the magnitude of the cetane effect, if any,
- any differences between natural and additive-derived cetane,
- the extent to which other fuel properties, reflected in the other fuels, affect emissions.

**Figure 5(a)** NOx Emissions vs. CN

**Heavy-duty**

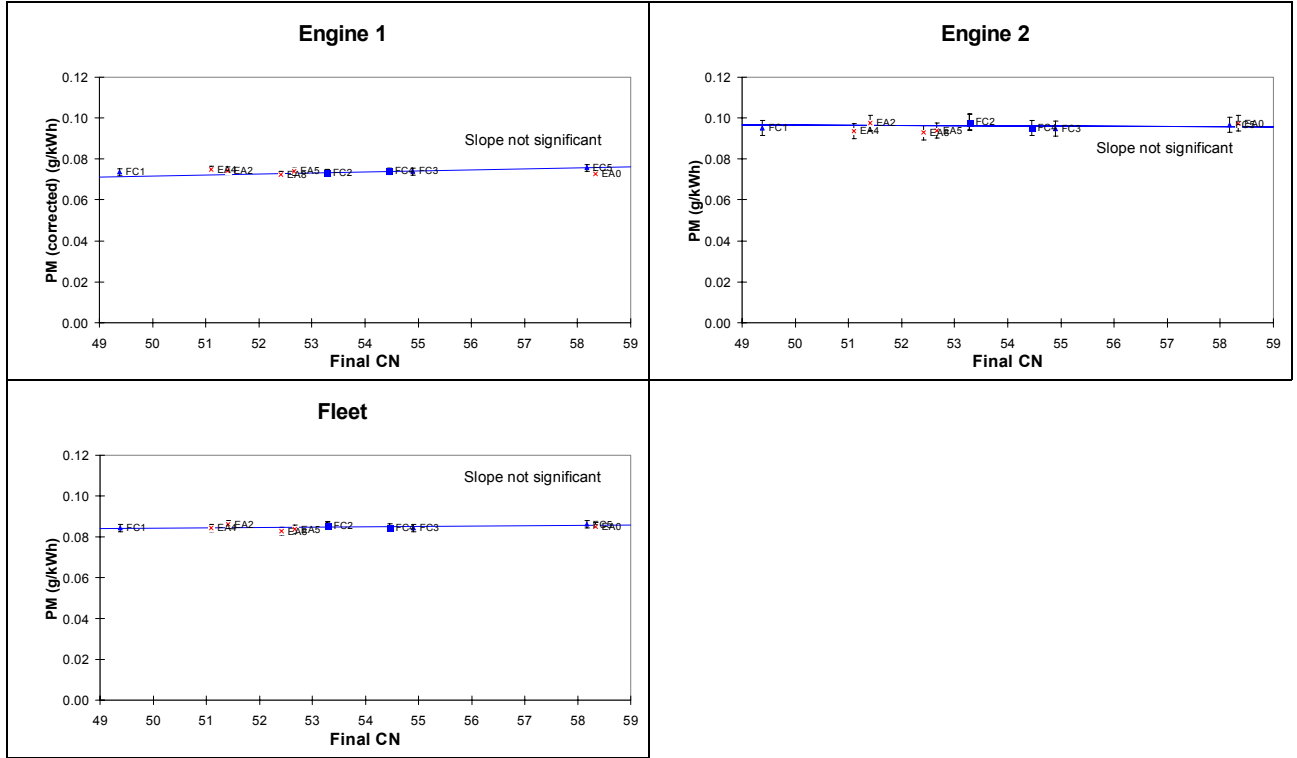


**Light-duty**



**Figure 5(b)** PM Emissions vs. CN

**Heavy-duty**



**Light-duty**

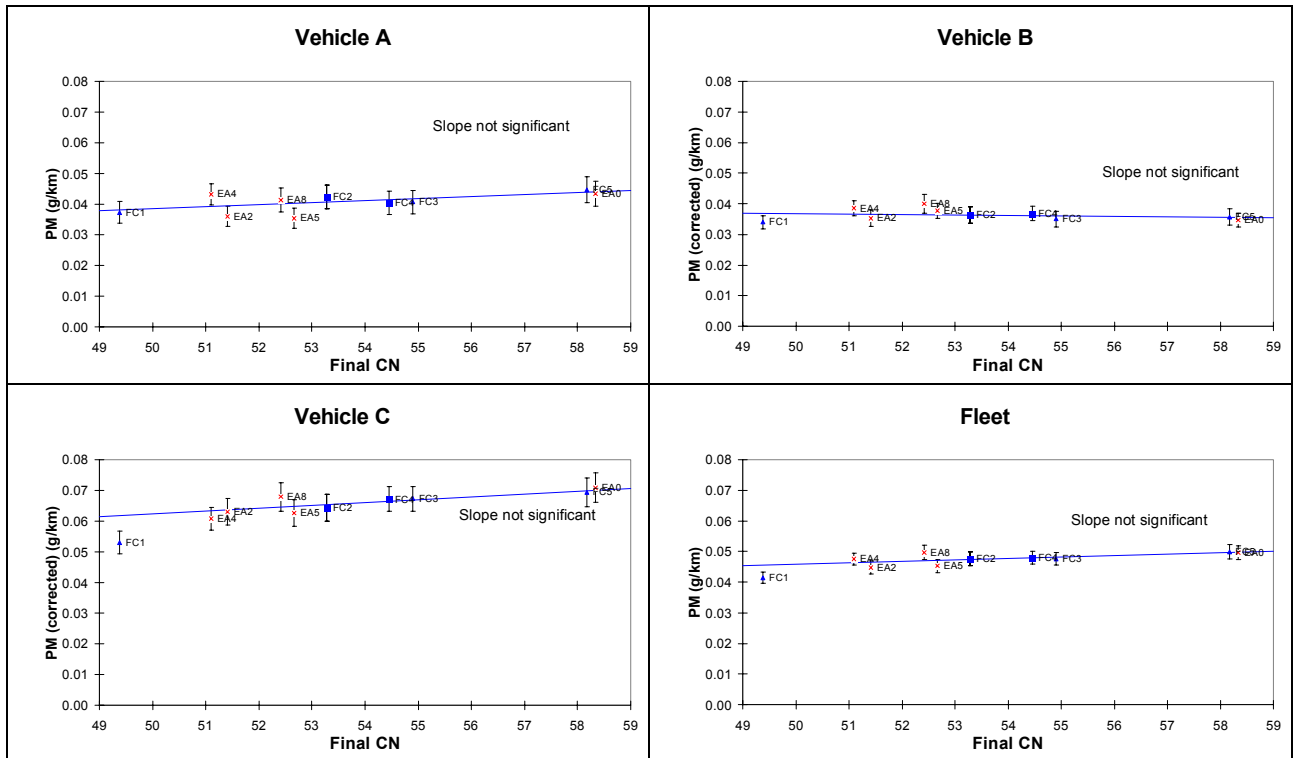
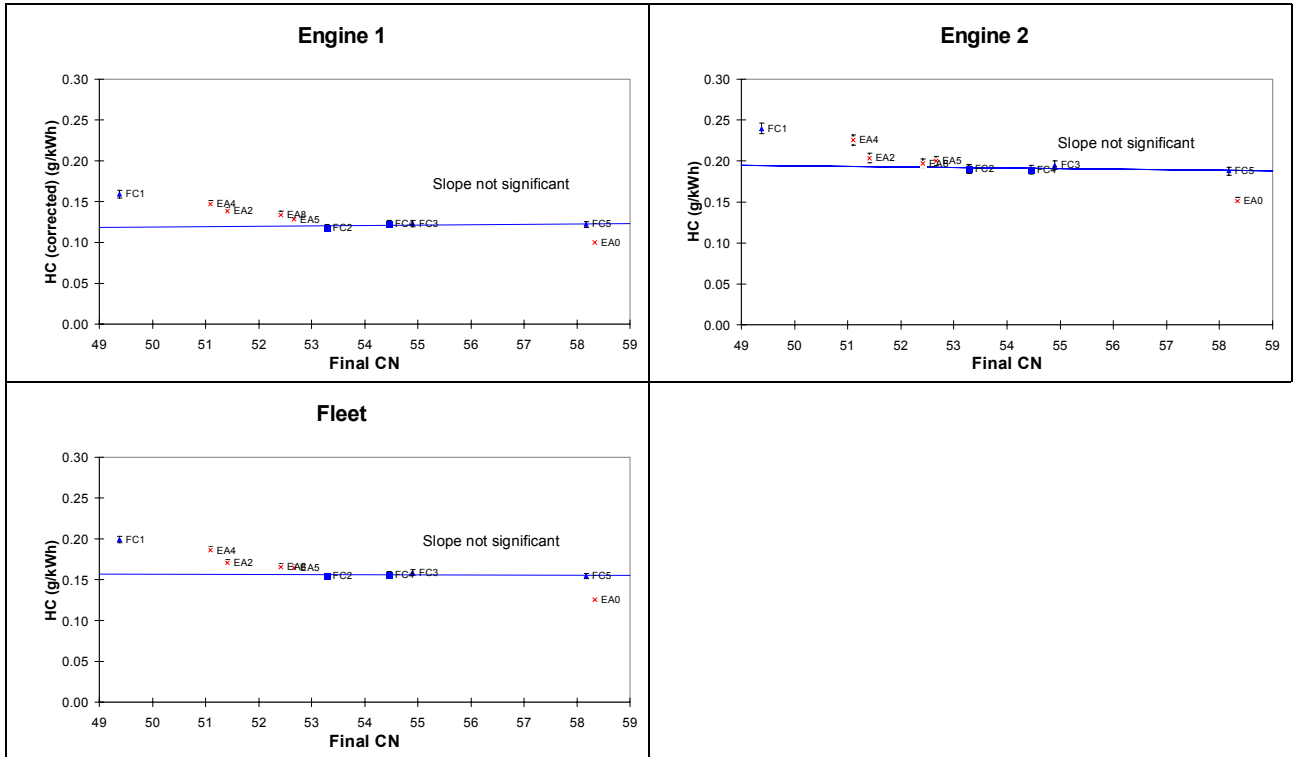
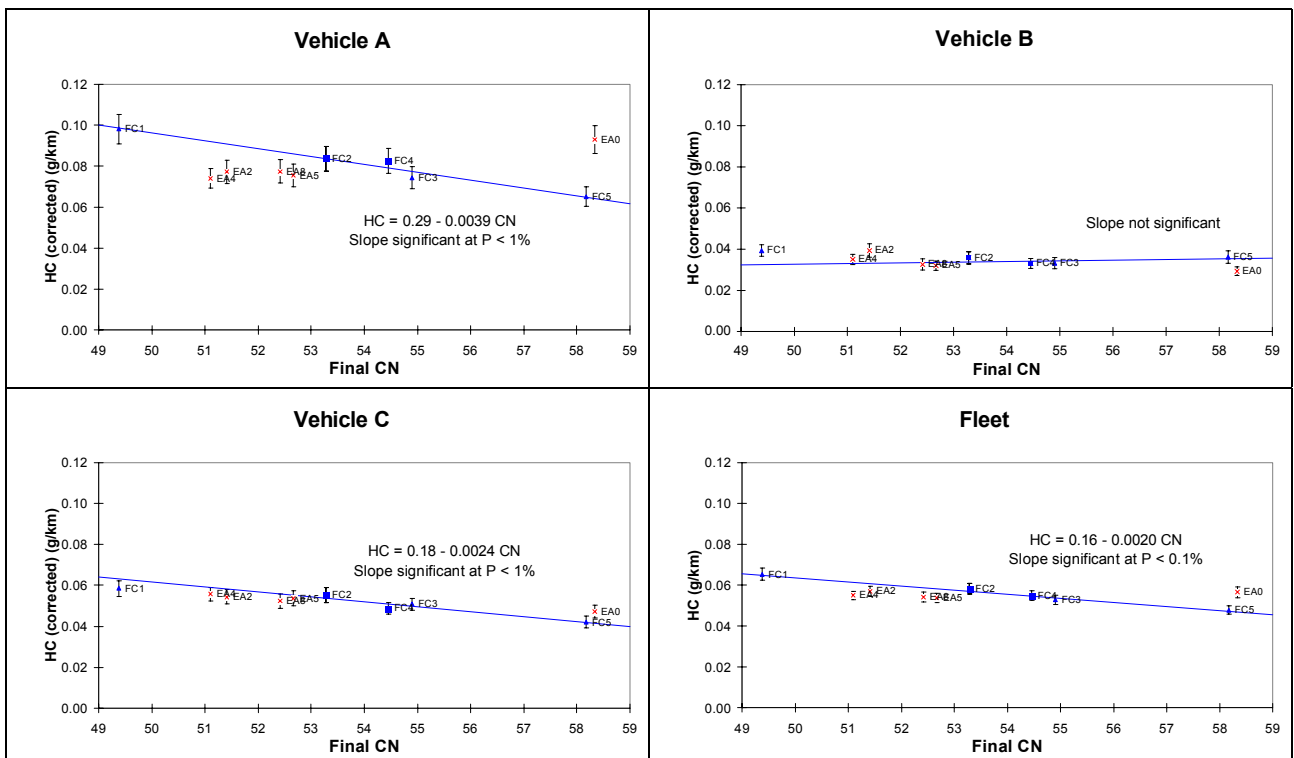


Figure 5(c) HC Emissions vs. CN

**Heavy-duty**

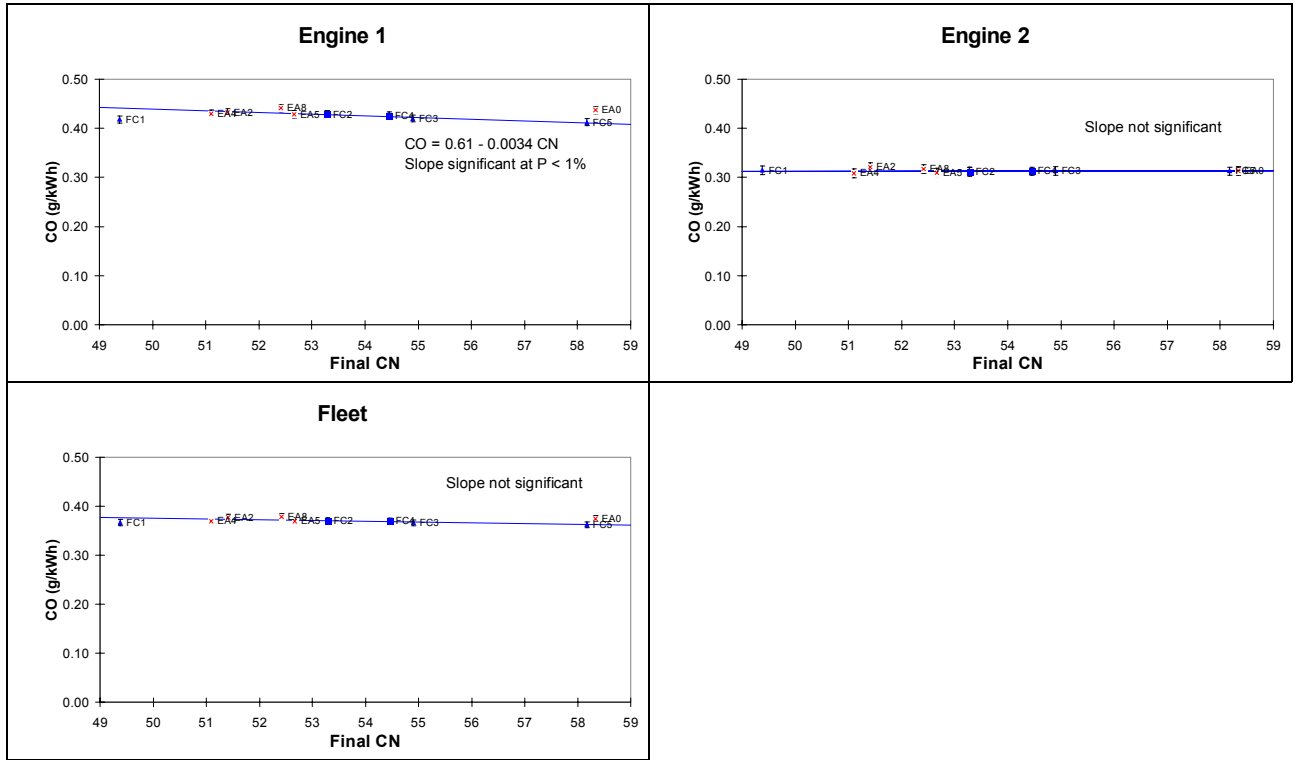


**Light-duty**

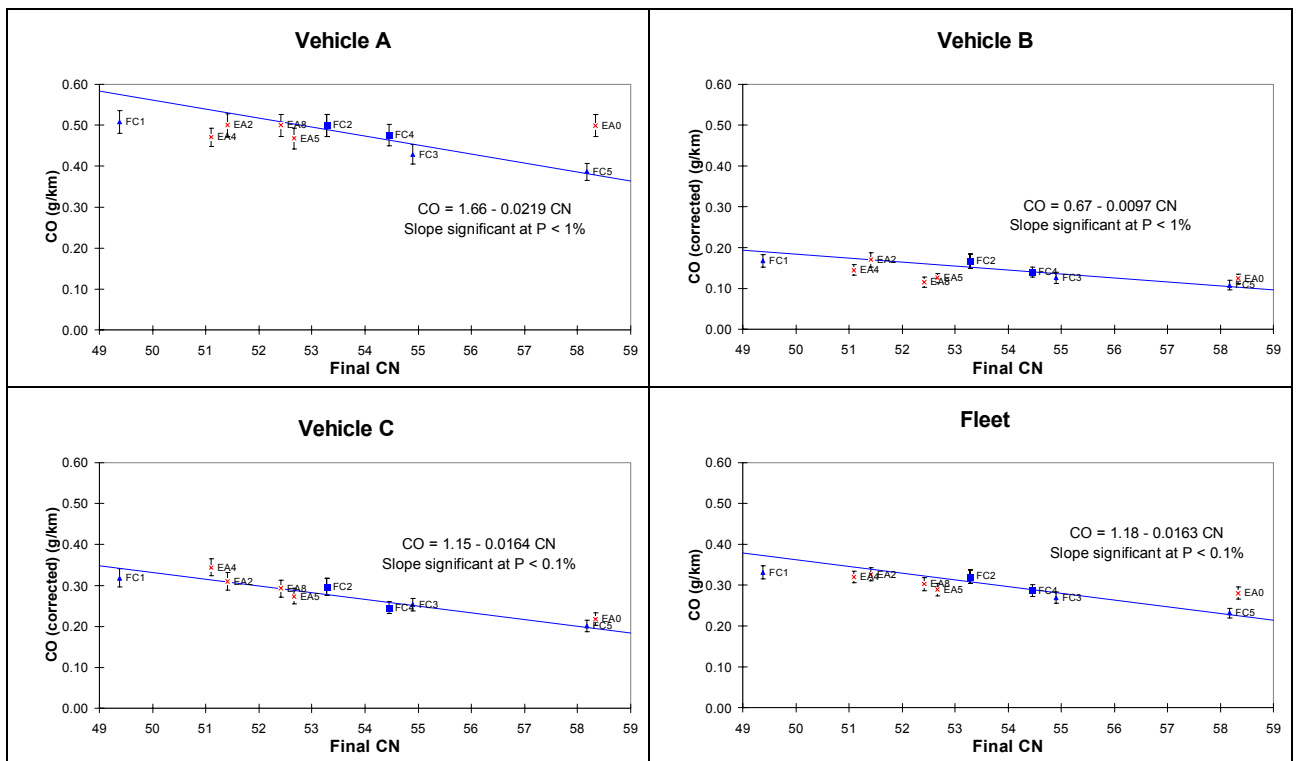


**Figure 5(d)** CO Emissions vs. CN

**Heavy-duty**



**Light-duty**



### 7.3.2.1. Summary of cetane effects

**NOx Emissions:** No significant effects of cetane number on NOx emissions were seen for any of the HD engines or LD vehicles.

**PM Emissions:** No significant effects of cetane number on PM emissions were observed for any of the HD engines or LD vehicles. However, in the light-duty vehicles, the tendency was to increase PM emissions with increasing cetane number.

**HC Emissions:** In the HD engines, the cetane number effect based on fuels FC2-FC5 was small and not significant in both engines. Fuel FC1 and the aromatics matrix fuels did not lie on the trend line, pointing to an impact of other fuel properties on HC emissions in these engines. Aromatics effects are considered in **section 7.4**.

Two of the LD vehicles showed significant reductions in HC emissions as the cetane number increased. In vehicle B there was no significant effect. For Vehicle C, the data for the aromatics fuels lie close to the cetane number trend line, suggesting that cetane number is the most influential fuel parameter for HC emissions in this vehicle. For Vehicle A, the aromatics fuels follow a different trend from the cetane fuels.

Fuel FC1 lies on or close to the cetane number trend line for the LD vehicles, but lies above the line for the HD engines. This suggests that the differences in KV40, T50 and T10 between FC1 and the other cetane matrix fuels are more important under the higher load test conditions in the HD engines.

**CO Emissions:** CO emissions in the HD engines were well below the Euro-3 limits, and the variations between fuels were small. Only engine 1 showed a significant cetane effect, CO emissions decreasing slightly at higher cetane number.

The LD vehicles showed a stronger response to cetane, with lower CO emissions at higher cetane number, and all three vehicles showing a significant effect.

For the other test fuels, only fuels FC1 and EA0 deviated from the CN trend line.

### 7.3.2.2. Natural versus additive-derived cetane

As described above, no significant effects of cetane number on NOx or PM emissions were observed in either the LD vehicles or HD engines tested. Increasing cetane number reduced HC and CO emissions in the LD vehicles, with statistically significant effects in all but one case. In the HD engines, cetane effects on HC emissions were not significant and only one engine showed a significant effect on CO emissions.

The data from fuel set FC2-FC5 was closely studied in order to assess any differences between natural and additive-derived cetane. This showed that there were no detectable differences in emissions between the natural cetane fuels and those where the cetane number was boosted using ignition improver additive (see **Figures 5(a)-5(d)**).

#### 7.4. AROMATICS EFFECTS

The aromatics matrix was designed to allow the effects of mono- and poly-aromatics to be separately evaluated (**Figure 1**). The matrix covered poly-aromatics from 1 to 12% m/m, and mono-aromatics from 10 to 22% m/m.

However, maintaining other fuel properties constant as aromatics vary is difficult, and study of the fuel matrix showed that fuel EA0 differed from the other fuels in terms of CN, T10, T50 and KV40. Leaving this fuel out of the matrix improves the correlations between the fuel properties, but reduces the range of aromatics variation.

Initial regressions using only fuels EA2-EA8 indicated that few of the mono- and poly-aromatics effects were statistically significant. Including EA0 in the analysis would maximise the chances of finding significant effects, but introduce uncertainty over whether observed effects were caused by aromatics or by the other properties that differ between EA0 and the other fuels.

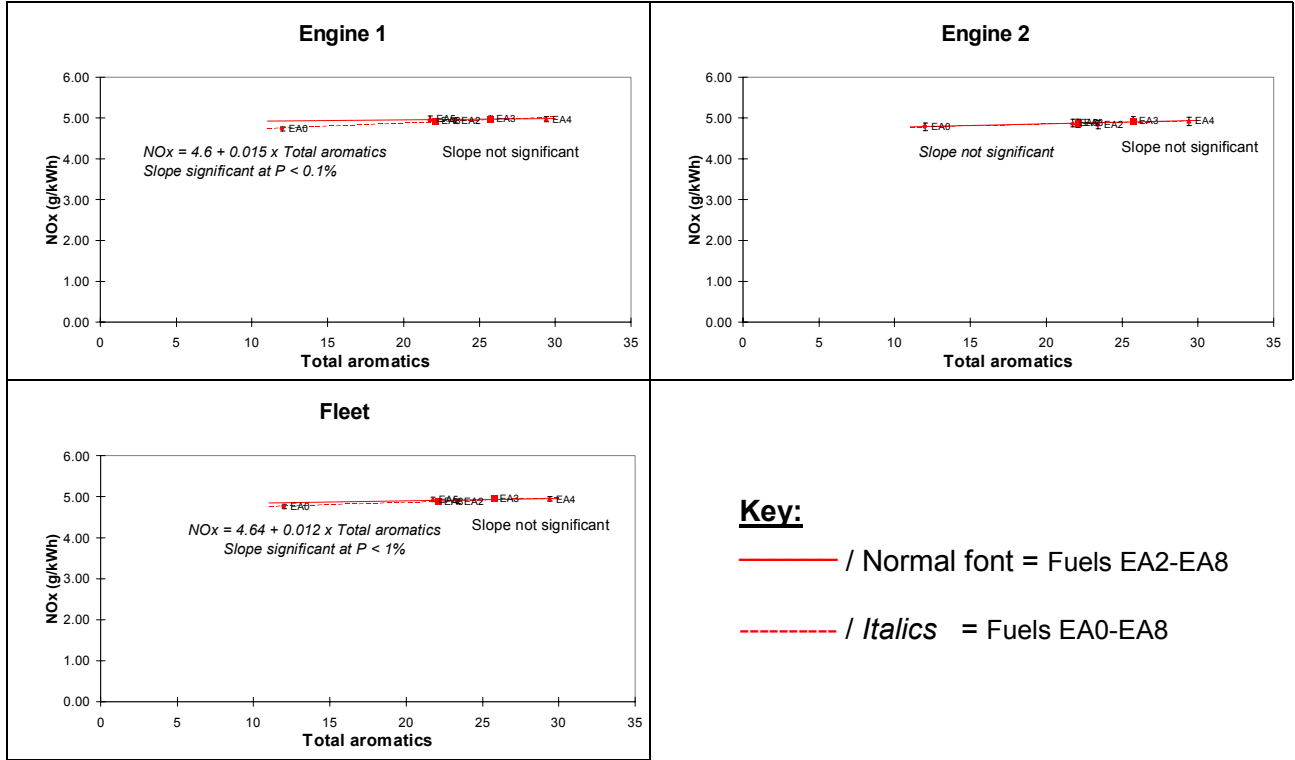
To overcome this difficulty, the results have been plotted first as a function of total aromatics. **Figure 6** shows the results for fuels EA0 to EA8, with regression lines calculated either using all the fuels (broken lines) or using fuels EA2-EA8 only, excluding fuel EA0 (solid lines). In this way the magnitude and significance of any aromatic effects can be assessed. Where the solid lines (fuels EA2-EA8) show a significant effect we can be confident that this is an aromatics effect. If inclusion of fuel EA0 has a strong effect on the slope of the line, this suggests that the trend line is influenced by non-aromatics effects caused by the differences between fuel EA0 and the rest of the matrix. Results are shown both for individual vehicles/engines, and for the HD and LD fleets.

The separate effects of mono- and poly-aromatics are considered later, in **Section 7.4.2** and illustrated in **Appendix 13**.

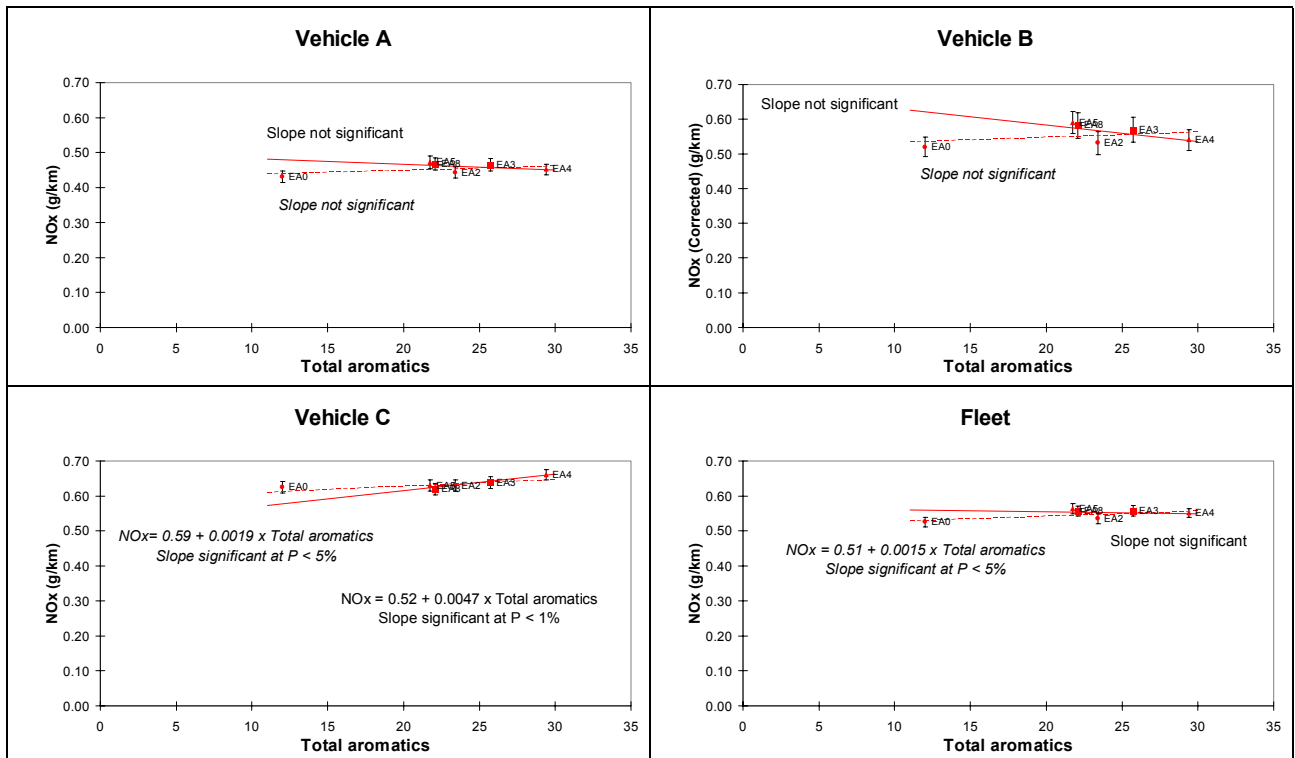


**Figure 6(a)** NOx Emissions vs. Total Aromatics (%m/m)

**Heavy-duty**

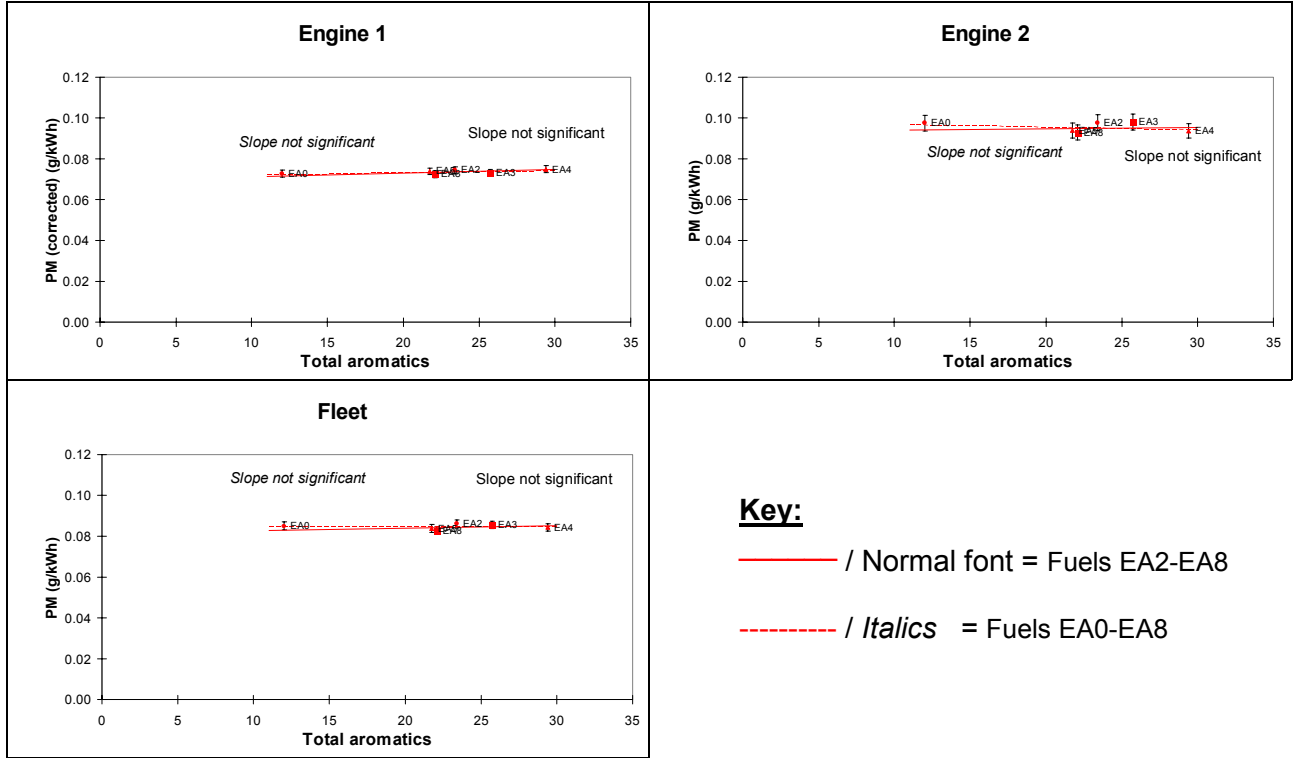


**Light-duty**

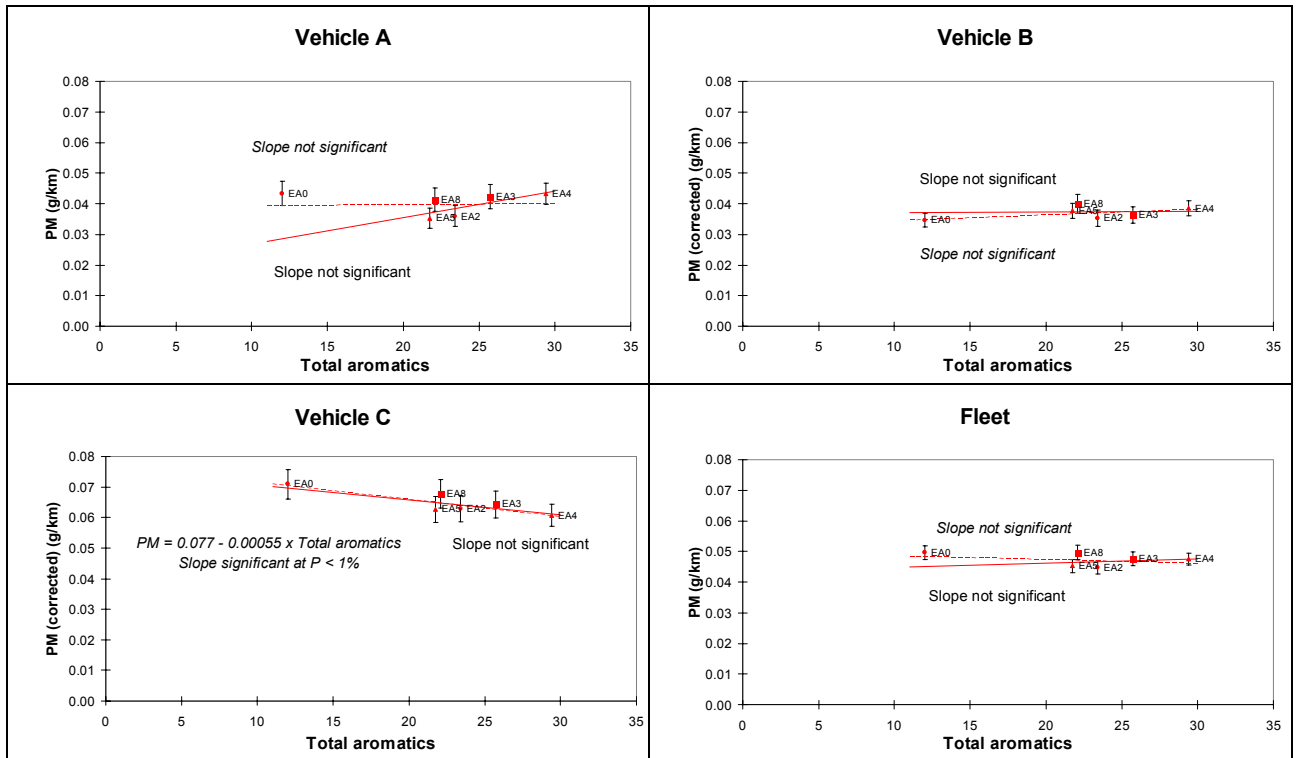


**Figure 6(b)** PM Emissions vs. Total Aromatics (%m/m)

**Heavy-duty**

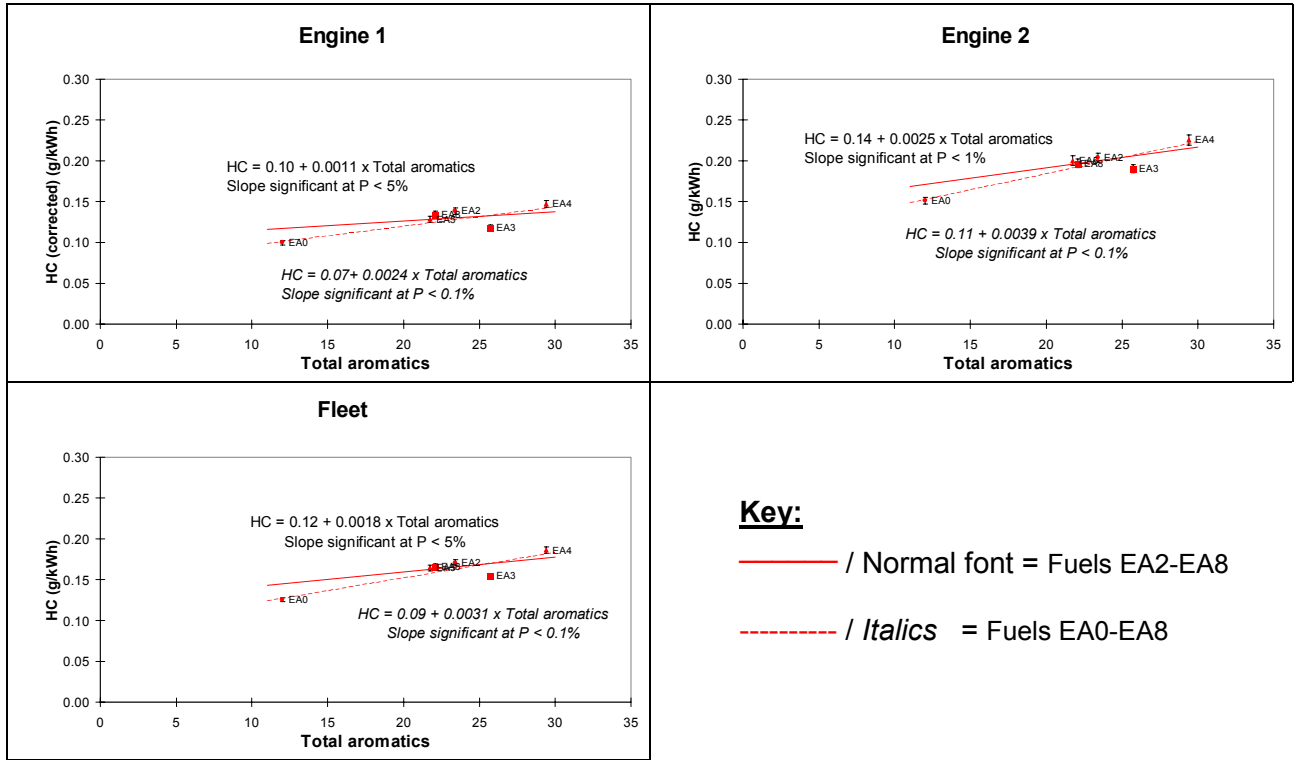


**Light-duty**

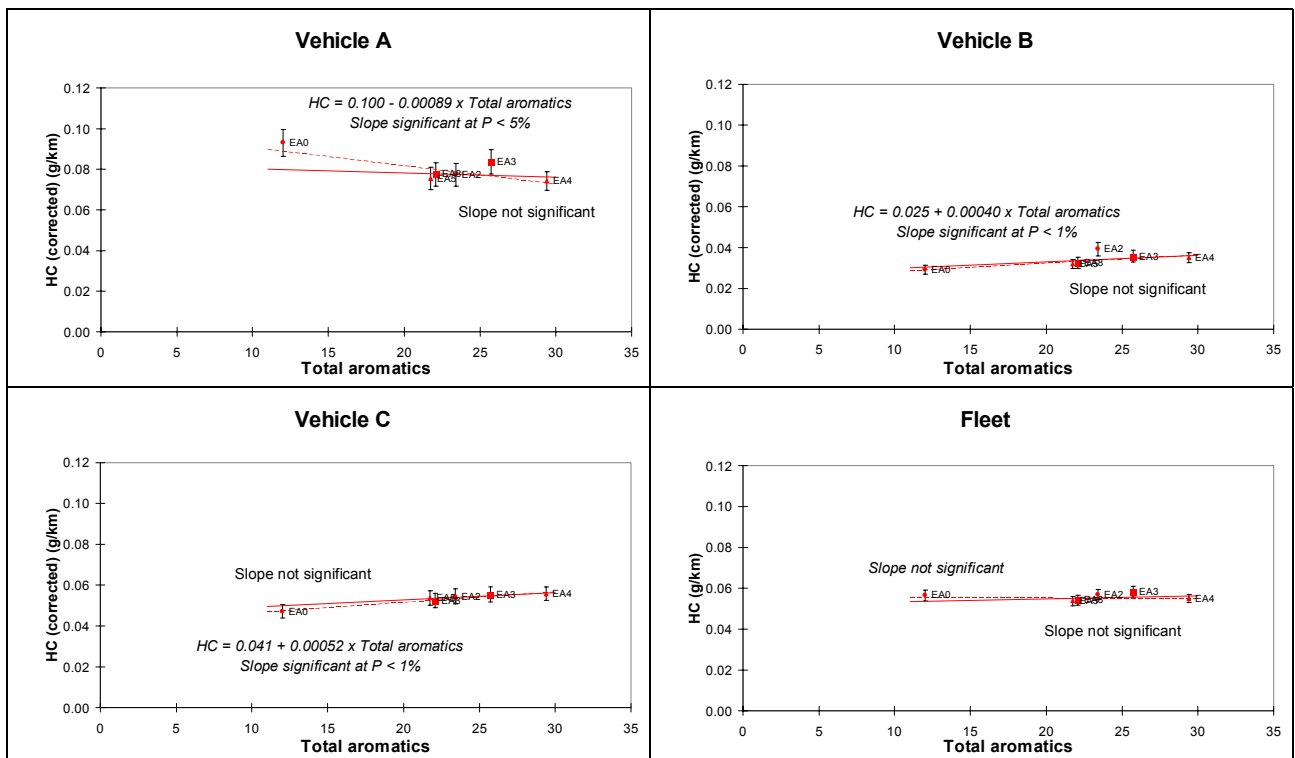


**Figure 6(c)** HC Emissions vs. Total Aromatics (%m/m)

**Heavy-duty**

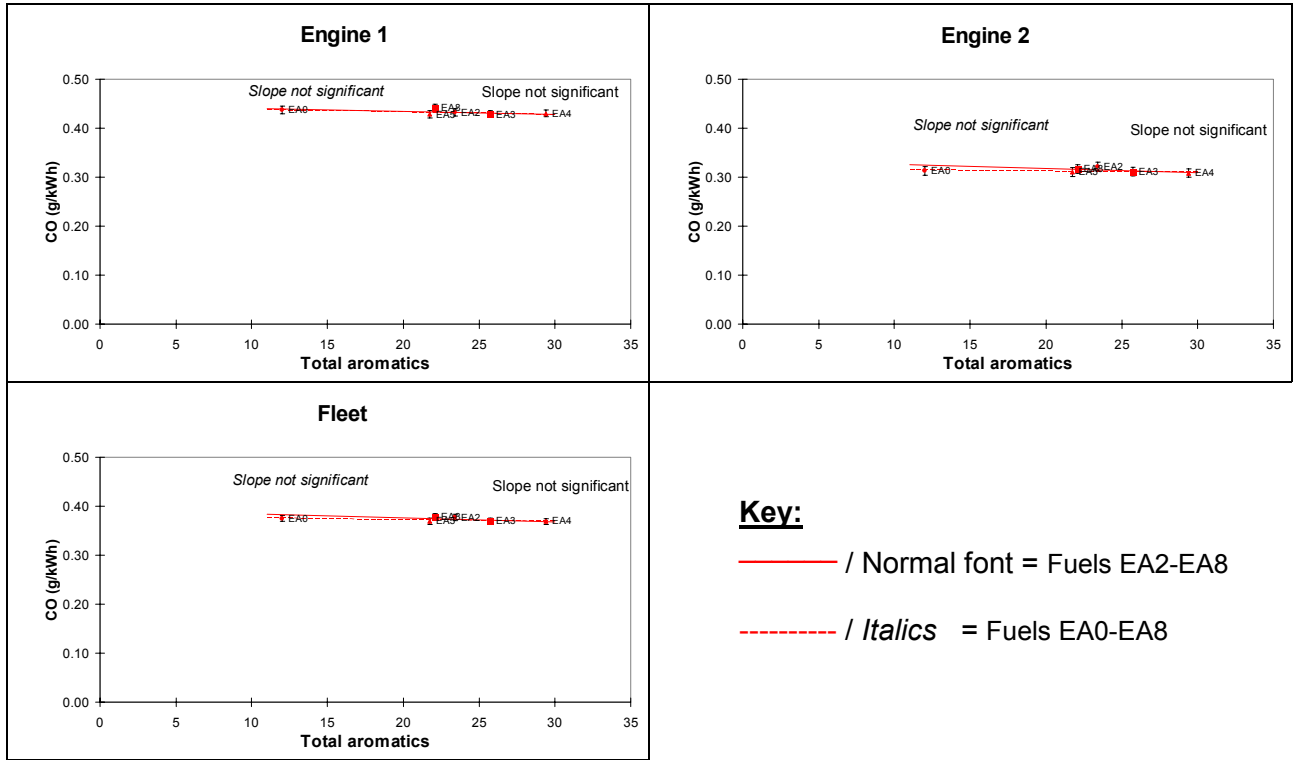


**Light-duty**

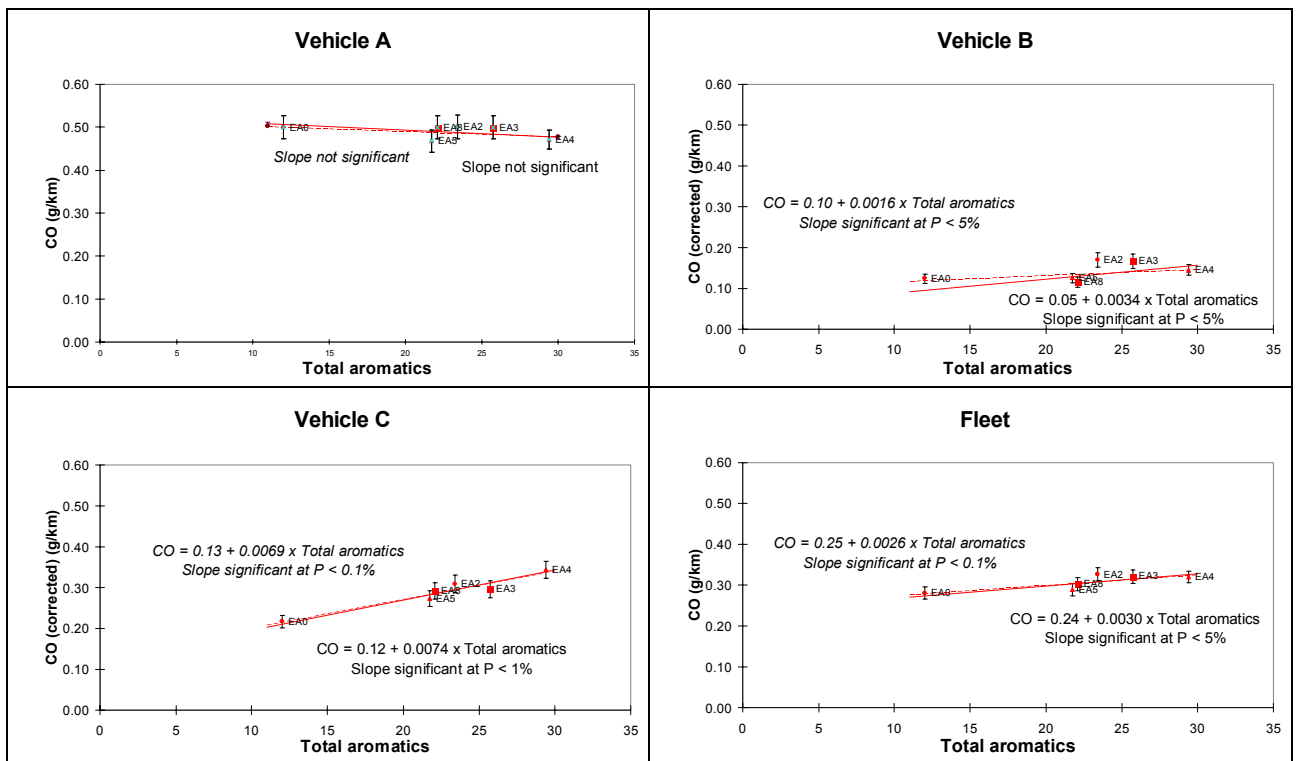


**Figure 6(d)** CO Emissions vs. Total Aromatics (%m/m)

**Heavy-duty**



**Light-duty**



#### 7.4.1. Total aromatics effects

**NO<sub>x</sub> Emissions:** For the HD engines, there were no significant effects of aromatics on NO<sub>x</sub> emissions when fuel EA0 was excluded. A small, but statistically significant effect was seen in engine 1 when EA0 was included.

For the LD vehicles, only vehicle C showed a significant trend, with NO<sub>x</sub> emissions decreasing with lower aromatics. Fuel EA0 lay above the trend line, suggesting that emissions may have been influenced by the higher T50 and KV40 of this fuel. For the other two vehicles, there was no significant effect of aromatics on NO<sub>x</sub>.

**PM Emissions:** For the HD engines, there were no significant effects of aromatics on PM emissions.

In the LD vehicles, vehicles A and B showed no effect of aromatics on emissions. Vehicle C showed a trend for increased PM emissions as aromatics levels were reduced. This trend was only statistically significant when EA0 was included.

**HC Emissions:** In the HD engines, reducing aromatics levels lowered HC emissions in both engines, although with considerable scatter in the data. Fuel EA3 fell significantly below the trend line in both engines. Including fuel EA0 in the regression changed the slope of the trend line, suggesting that other fuel parameters influence its performance.

For the LD vehicles, there was no significant effect of aromatics on HC emissions based on fuels EA2-EA8. Including fuel EA0 produced significant statistical effects, but the trend was to reduce HC emissions on vehicles B and C, but to increase HC emissions in vehicle A, as aromatics reduced. On a fleet average basis the effect was not significant.

**CO Emissions:** In the HD engines, aromatics effects on CO emissions were not significant.

For the LD vehicles, there were differences in behaviour between the three vehicles. Vehicle C showed the strongest effects, with CO emissions reducing at lower aromatic levels. The trend line was similar whether EA0 was included or omitted, suggesting that in this case other variations in fuel properties did not have a strong effect. Vehicle B produced more scatter in the data, but with a trend for lower CO emissions at lower aromatics. Vehicle A showed no sensitivity to aromatics changes.

#### 7.4.2. Mono- and Poly-aromatics effects

One key feature apparent from the analysis in **Section 7.4.1.**, is the lack of any strong and consistent fuel effects, even though rigorous statistical design and analysis techniques were used to maximise the visibility of such effects.

**Figure 7** shows the data from the current study, separately identifying poly-aromatic effects (by comparing fuels EA2 and EA3 with EA4), and mono-aromatic effects (by comparing fuels EA5 with EA4). Since other fuel parameters were successfully controlled between these fuels, we can be confident that the trends observed can be

attributed to aromatics, with the caution that no attempt has been made here to identify significant and non-significant effects.

The EPEFE programme [1], carried out with vehicles and engines designed to meet Euro-2 emission standards offers a valuable comparison with the current programme, although in EPEFE only poly-aromatics was varied, and there are no data on mono-aromatics effects. In addition, two other recent CONCAWE test programmes provide useful comparative data. In a recent CONCAWE study on PAH emissions [7], three Euro-2 cars were tested on a matrix designed to separate mono- and poly-aromatics effects. Further tests were also carried out on 2 additional cars which approached Euro-3 standards. These two studies used a different fuel matrix, but the non-aromatic fuel parameters were held constant so that the effects of mono and poly-aromatics could be separately evaluated. Further details of these tests are given in **Appendix 14**.

**Figure 8** shows the data from these complementary CONCAWE studies, presented in the same format as the current study to allow an easy comparison. Data from the three Euro-2 technology vehicles evaluated (A1, A2, A3) are shown by solid lines and data from the two newer Euro-3 technology vehicles (B1, B2) are shown by broken lines.

Figure 7(a) Relative mono and poly-aromatics effects in the HD engines

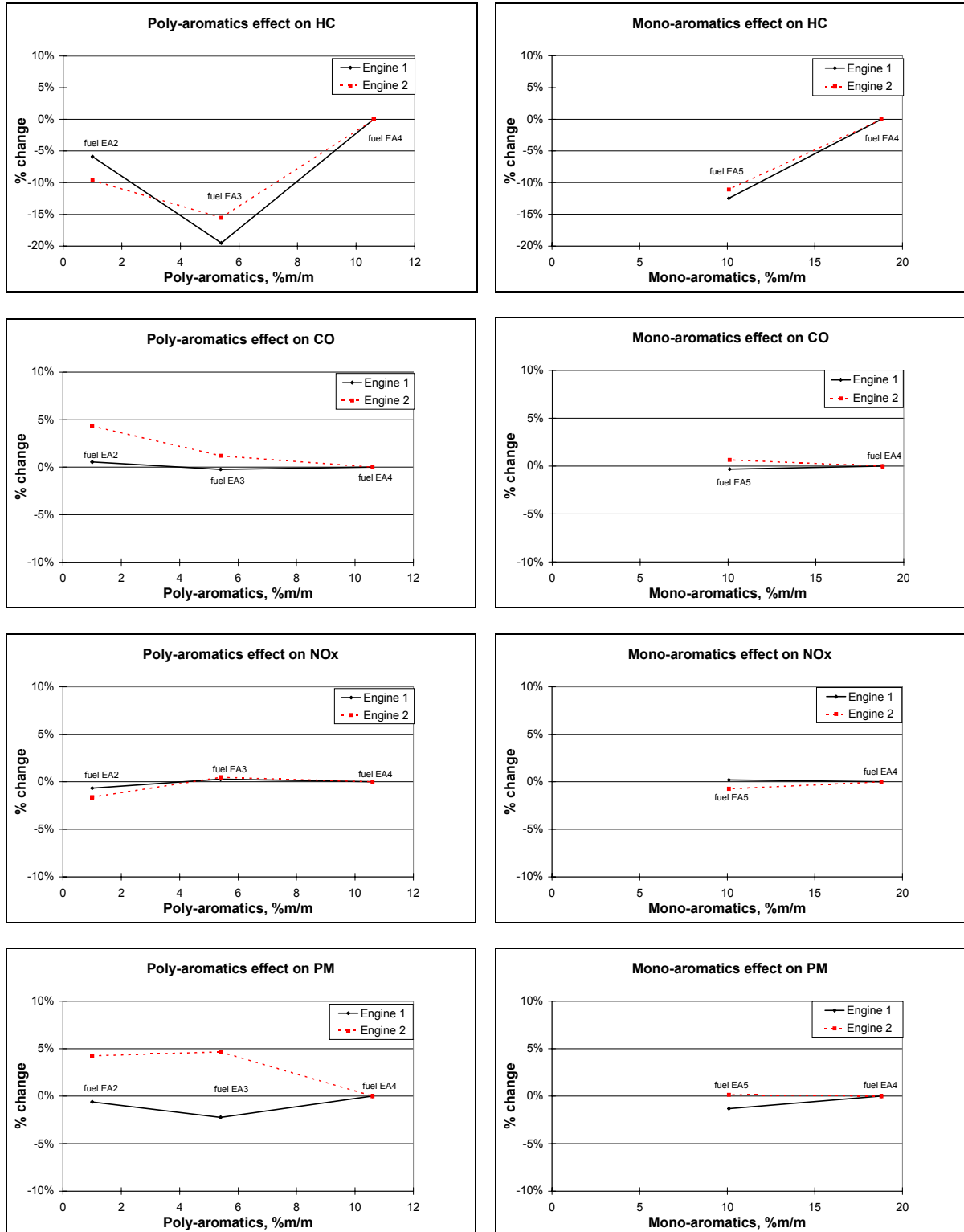
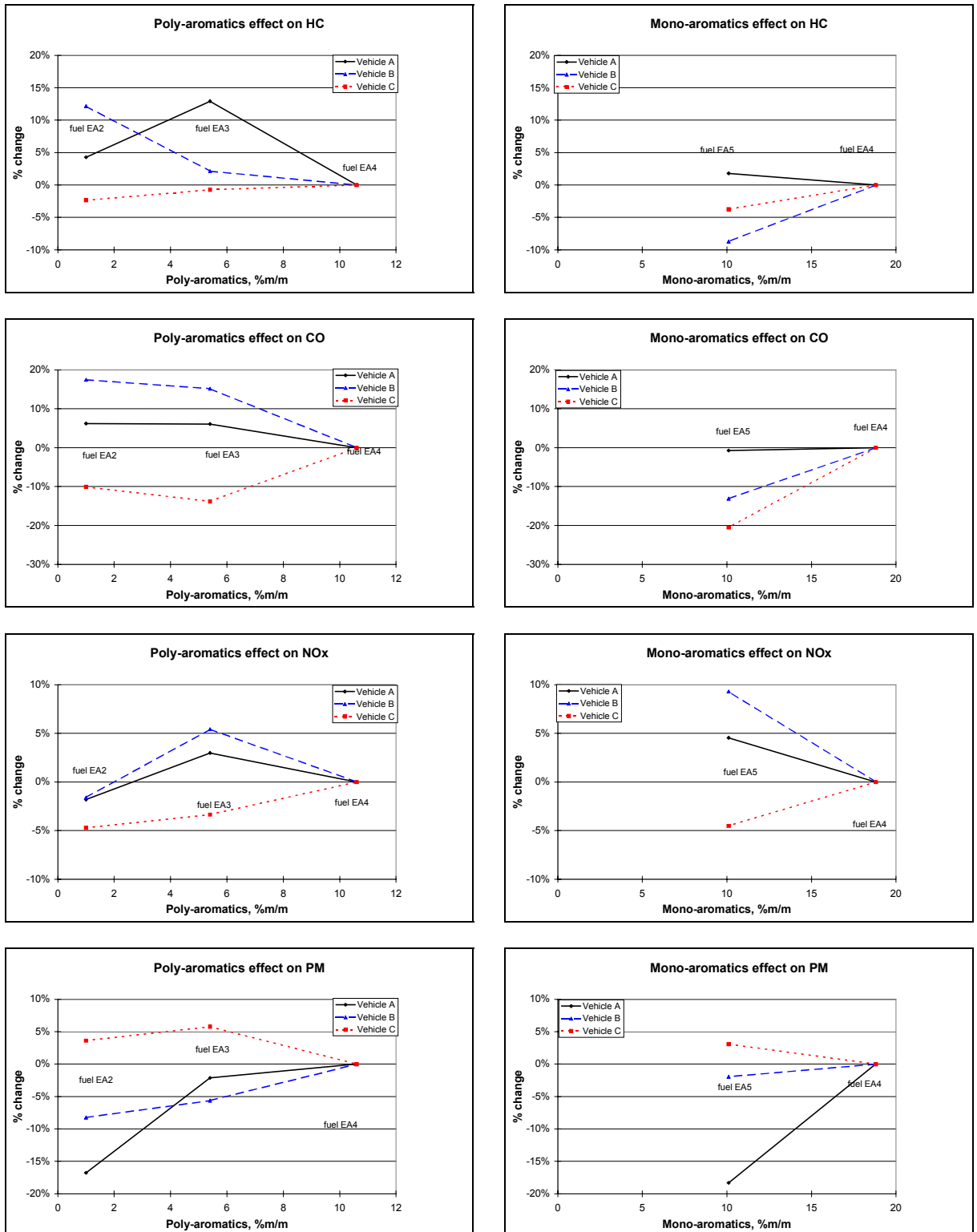
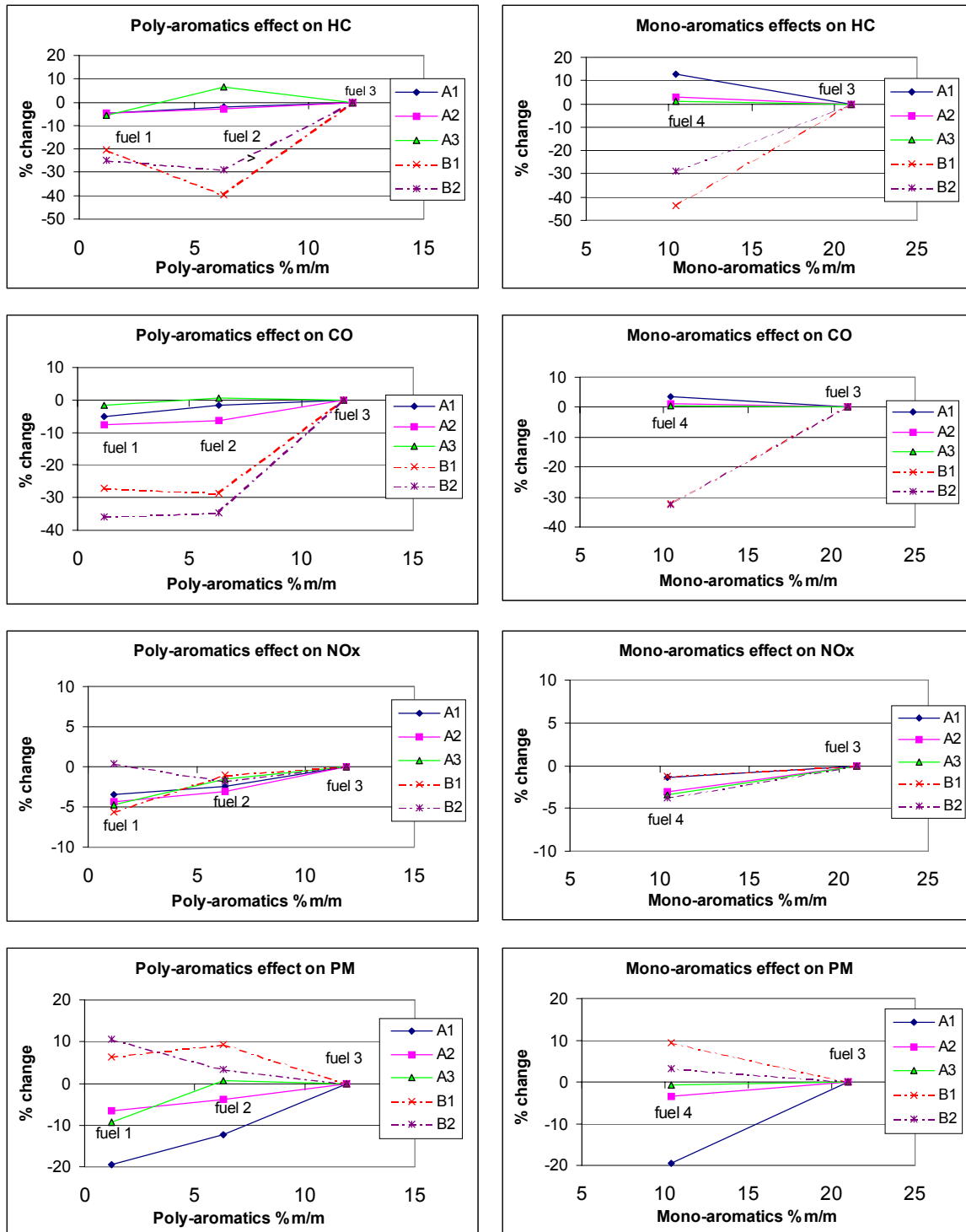


Figure 7(b) Mono and poly-aromatics effects in LD vehicles, current study





**Figure 8** Mono and poly-aromatics effects in LD vehicles, complementary CONCAWE studies



#### 7.4.2.1. Heavy-Duty

The heavy-duty plots in **Figure 7(a)** simply confirm the conclusions from **Section 7.4.1**, that the only significant effect was on HC emissions, which were found to decrease with reducing aromatics.

#### 7.4.2.2. Light-Duty

**HC/CO Emissions:** No consistent pattern emerges across all the vehicles tested. In some cases reducing mono-aromatics or poly-aromatics reduced HC and CO emissions, in other cases emissions increased.

In the complementary studies (**Figure 8**) there was a trend for the newer Euro-3 technology vehicles to respond in a different way from the Euro-2 vehicles. The older technology showed little or no benefit for lower aromatics fuels, but the Euro-3 vehicles gave substantial reductions in HC and CO emissions when aromatics were reduced.

In the current study (**Figure 7(b)**), these effects were not mirrored and the two newer vehicles showed higher emissions with lower poly-aromatics, whereas the older technology vehicle C tended towards lower emissions with lower poly-aromatics. Mono-aromatic effects were scattered, but with a general trend for lower HC/CO emissions with lower mono-aromatics.

**NOx Emissions:** In the complementary studies (**Figure 8**), there was no clear distinction between the older and newer technology vehicles. Although there were differences between the vehicles, the general trend was for lower NOx emissions as aromatics levels were reduced. The effect was small, with on average about 3% NOx reduction for a 10% reduction in either mono or poly-aromatics level.

The current study (**Figure 7(b)**) showed more scatter in the data with only the older technology vehicle C showing consistent small NOx reductions as aromatics levels were reduced.

**PM Emissions:** The complementary studies (**Figure 8**) show a scatter of results between the different vehicles, with some divergence between technology levels. The three Euro-2 level vehicles showed PM emission reductions when fuel aromatics were reduced, with the strongest response from vehicle A1. Conversely the two newer technology vehicles showed increased PM emissions on the lower aromatics fuels.

In the current study (**Figure 7b**), this trend was reversed, with the older technology vehicle C showing an increase in PM emissions as aromatics reduced and the newer technology vehicles A and B showing the opposite trend.

#### 7.4.2.3. Overall Evaluation

It is clear that aromatics effects are small and may vary between different vehicles. Drawing conclusions from programmes evaluating 2-3 vehicles is risky; different results may be seen when other vehicles are evaluated, or even when different examples of essentially similar vehicles are tested. This finding reinforces the value of the EPEFE programme, where 19 diesel LD vehicles were tested. Such a broad vehicle base maximises the opportunity to identify real fuel effects.

There is some evidence, however, that the newer Euro-3 generation of diesel cars may respond differently to fuel properties than the Euro-2 generation, so the EPEFE data must be interpreted with increasing caution.

## 7.5. LIGHT-DUTY MODAL EMISSIONS ANALYSIS

In an attempt to understand more on the interaction between fuel quality and LD vehicle technology, raw emissions data from modal measurements were analysed. Test fuels EA0 and FC1 gave differences in gaseous emissions and results from these fuels were used in the analysis. The modal data were validated against legislative CVS (Constant Volume Sampling System) bag values for NO<sub>x</sub>, CO and HC emissions. The results showed good agreement between the two methods, **Figure 9**. Exhaust flow rates from the three vehicles were also found to be very similar across all vehicles, **Figure 10**. This enabled a comparison of emission results between vehicles and between fuels.

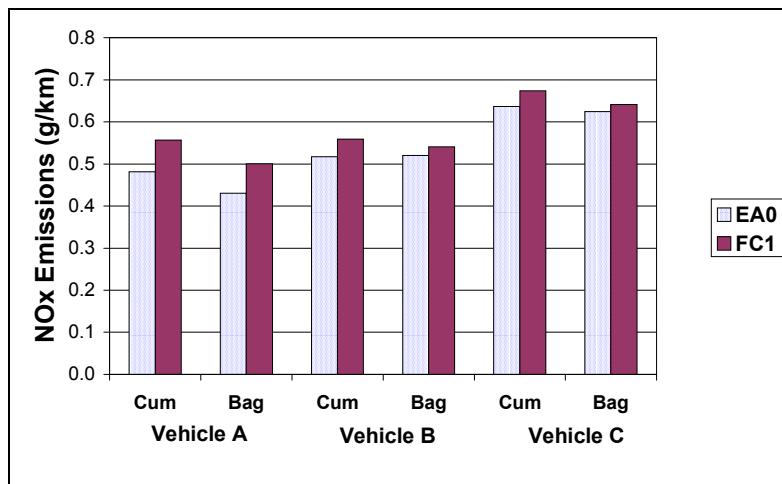
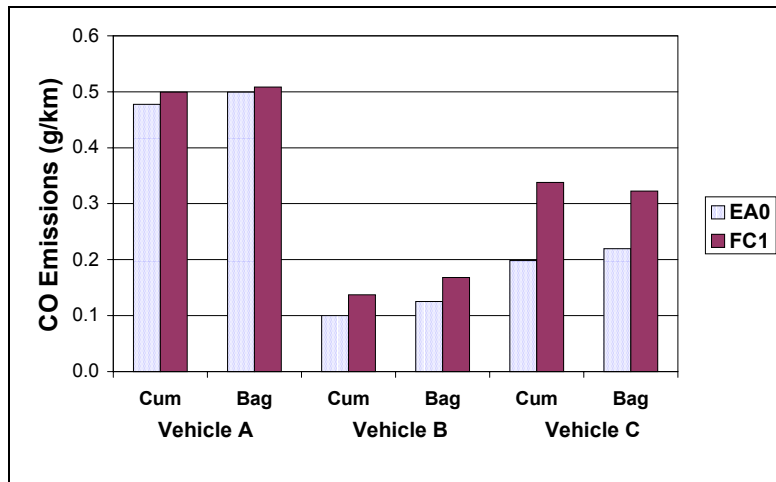
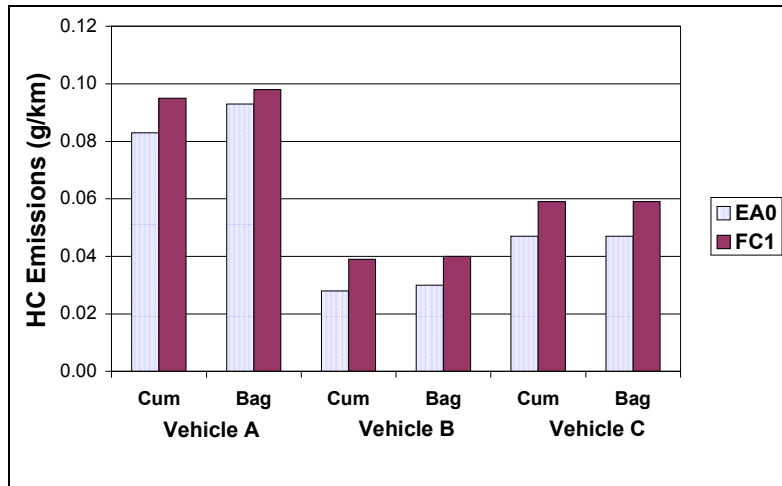
The second-by-second HC data offer the best results to determine if differences in emissions levels were due to changes in engine out emissions or catalyst efficiency. To check the effect on engine out emissions, modal data have been used to calculate the cumulative build-up of HC levels pre-catalyst throughout the test, **Figure 11**. All three vehicles show higher levels of HC emissions from test fuel FC1 compared to EA0. The reduction in HC over the catalyst was then calculated from modal pre- and post-catalyst data. **Figure 12** shows very little difference in percentage conversion efficiency between the two fuels. The fuel effect was therefore concluded to be on engine out emissions and not catalyst performance.

The change in engine out HC emissions due to fuel effects varied between 13% and 23% depending on which vehicle was considered, **Figure 11**. In contrast, the difference in engine out HC levels between vehicle A and the other two vehicles varied by 70% to 75%. The catalyst of vehicle A appeared to absorb/trap HC emissions at start-up (giving 90% reduction) and over the first 200 seconds gave conversion levels dipping to 75% and then rising to 95%, **Figure 12**. There was some indication that the other two vehicles absorbed HC during start-up but these vehicles had lower conversion levels of approximately 55% over the first 150 to 200 seconds and their best percentage reduction was 85 to 90%. These observations indicate that hydrocarbons were being stored on the catalyst during its warm-up period.

The main conclusions from this analysis are :

- The fuel effects observed were due to changes in engine-out emissions and not catalyst performance.
- The effect of fuel quality on engine-out HC emissions was between 13 and 23%. The difference in HC emissions between vehicles was much higher, up to 75%.
- Prior to catalyst light-off, HC conversion levels were relatively high for all vehicles and indicated HC storage on the catalyst during the initial warm-up phase.
- Catalyst conversion efficiency was the same for both fuels and the light-off time was unaffected by fuel quality.

**Figure 9** LD Emissions (CVS Bag v. Cumulative)



**Figure 10** Comparison of Raw Exhaust Gas Volumes

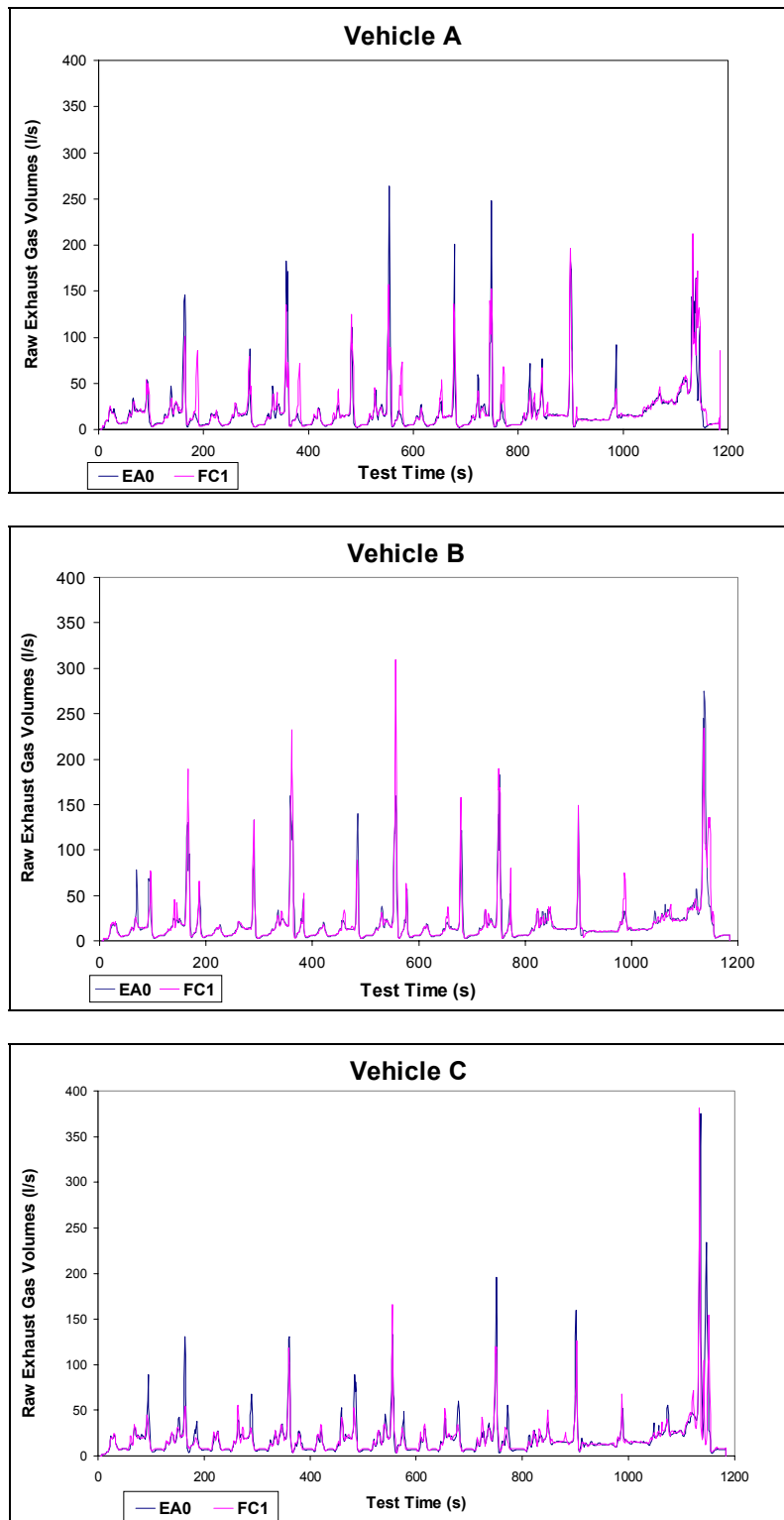


Figure 11 Pre Catalyst Cumulative HC Emissions

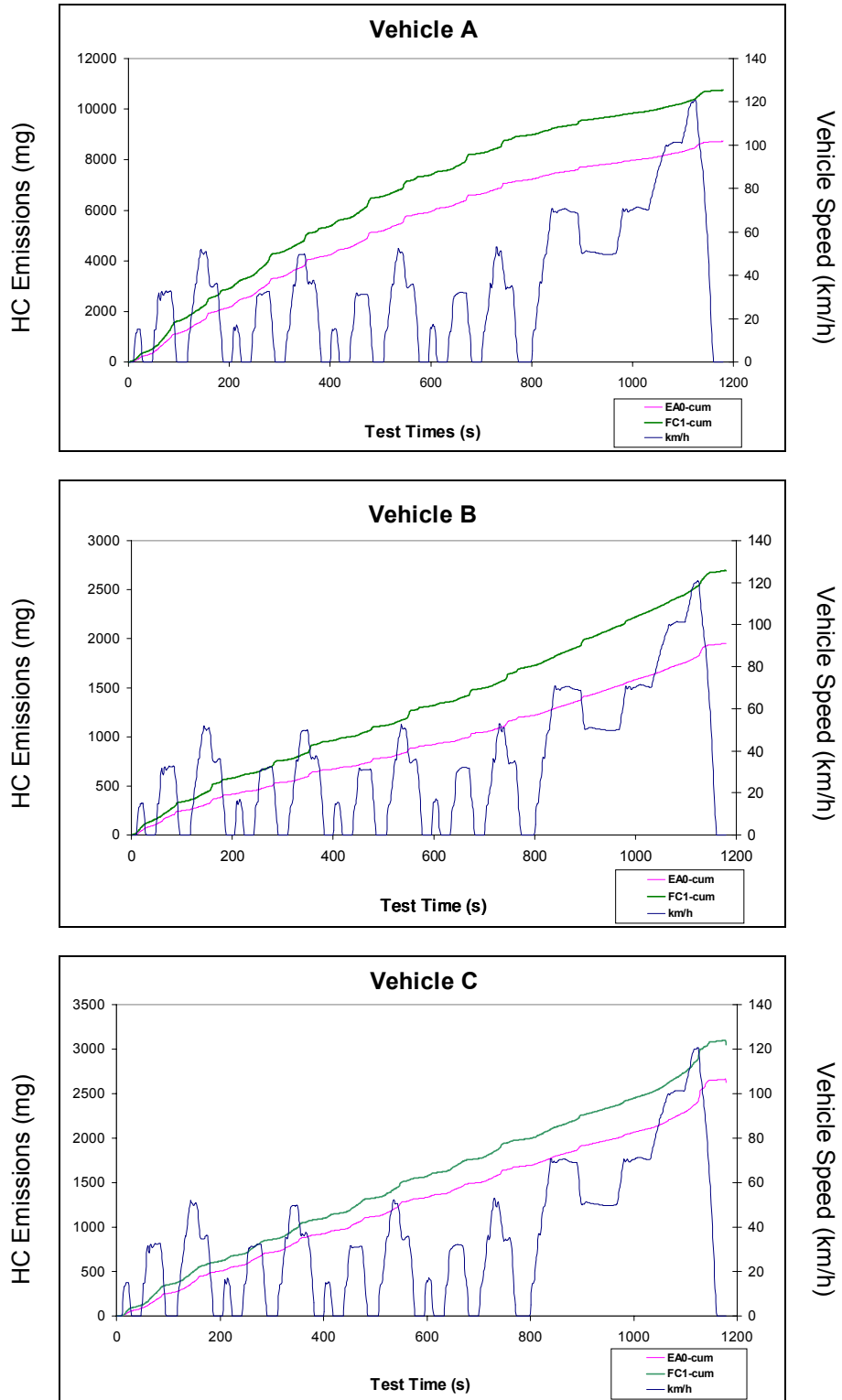
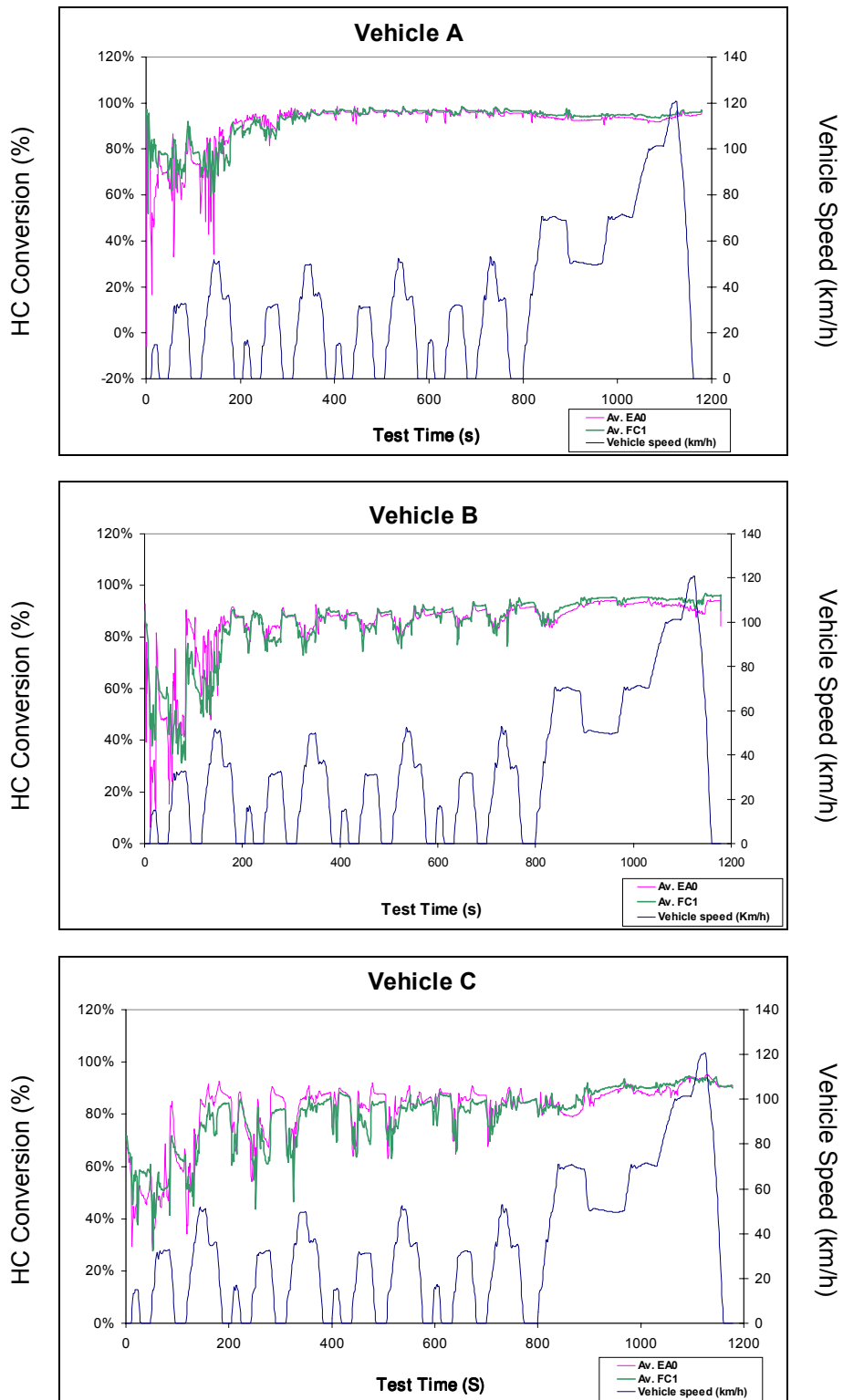


Figure 12 Percentage Hydrocarbon Reduction Over the Catalyst.



## 7.6. PARTICULATE FILTER ANALYSIS FOR LD FLEET

Some particulate samples collected during the emission tests carried out on the passenger cars were analysed in order to determine the particulate composition. In particular, the amount of fuel and oil-derived hydrocarbons adsorbed on the particulates and the amount of sulphates and nitrates were measured. The measurement methods used were IP 442/99 for the determination of fuel and oil-derived hydrocarbons and IP 416/96 for the determination of sulphates and nitrates.

In the first case, two portions of each filter were taken and, separately, placed into the sample injection tube of a suitable gas chromatograph equipped with a FID detector. The hydrocarbons present on the filter were thermally desorbed and quantified by comparison with analyses of oil and “topped” fuel.

The remaining portion of each filter was extracted with a 10% v/v solution of isopropanol in water according to the IP 416 method; the sulphates and nitrates in the extract were determined by ion chromatography.

The measured amount of fuel and oil-derived hydrocarbons (named VOF, Volatile Organic Fraction) and of the sulphates and nitrates was then subtracted from the total mass of the collected particulates; so this remaining part includes the inorganic carbon and other (ash, water, etc.).

The samples to be analysed were chosen among those generated in the emission tests carried out with the fuel EA0 and EA4; these were the extreme fuels in terms of total aromatic content. For each vehicle/fuel combination, two set of filters, corresponding to two different emission tests, were analysed; each set of filters comprised the ECE filter and the EUDC filter. When in the emission test it had been necessary to take into account the back-up filter, this was included in the analysis. A total of 24 filters were analysed.

The results are reported in **Table 14** and **Figure 13**.

The results showed no substantial influence of fuels on particulate composition. However, given that the fuels contained around 300 mg/kg sulphur, there were interesting differences between cars and test cycles in terms of sulphate production and consequent sulphate contribution to the particulate emissions.

Sulphate was generally only produced in the EUDC cycle and not in the ECE. On the EUDC cycle, vehicle B showed a range of sulphate content in the particulates from 18–29% and vehicle C a range from 12–20%, whereas vehicle A produced almost no sulphate even on the EUDC.

On the EUDC cycle, vehicle B showed a range of sulphate content in the particulates from 18–29% and vehicle C a range from 12–20%, whereas vehicle A produced almost no sulphate even on the EUDC.

These differences are believed to be due to catalyst temperature and are interesting in that vehicle A meets the Euro-3 limits with minimal sulphur sensitivity.

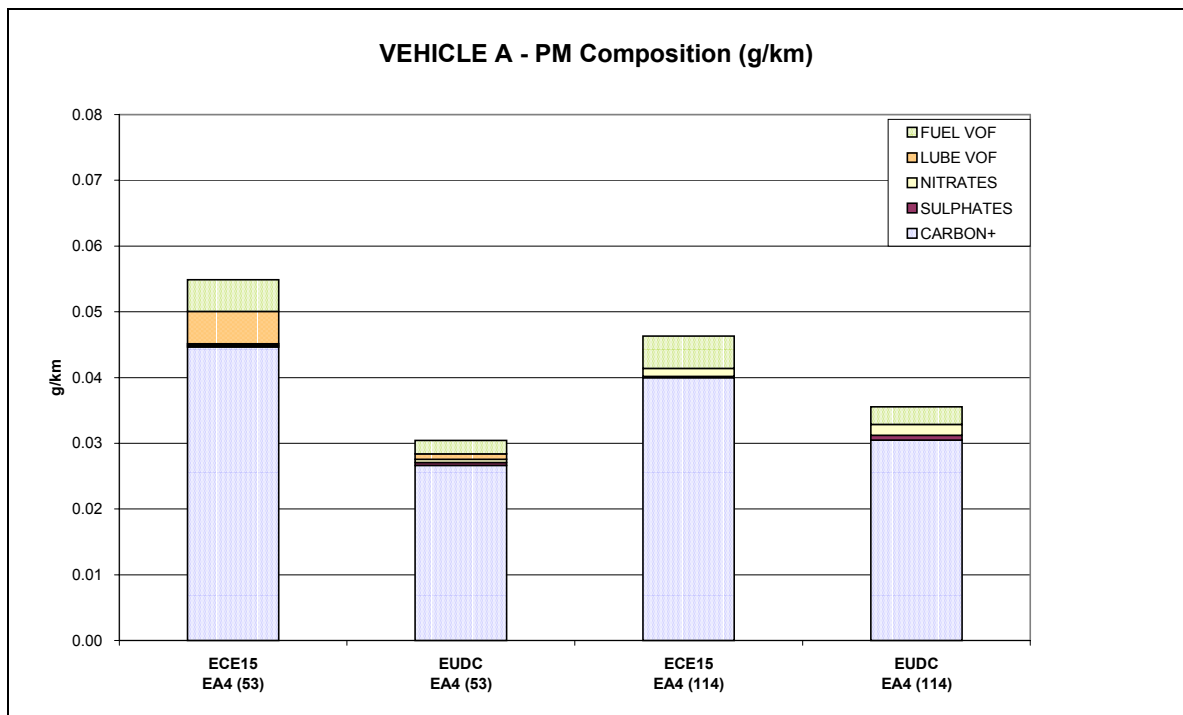
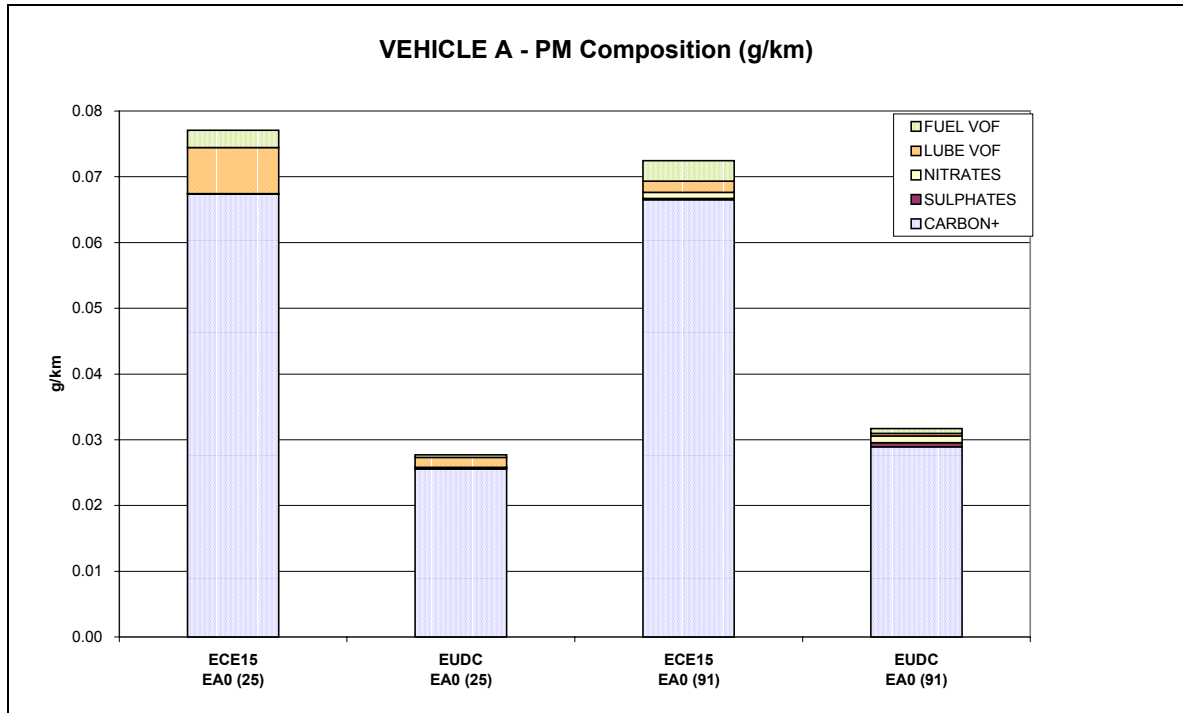


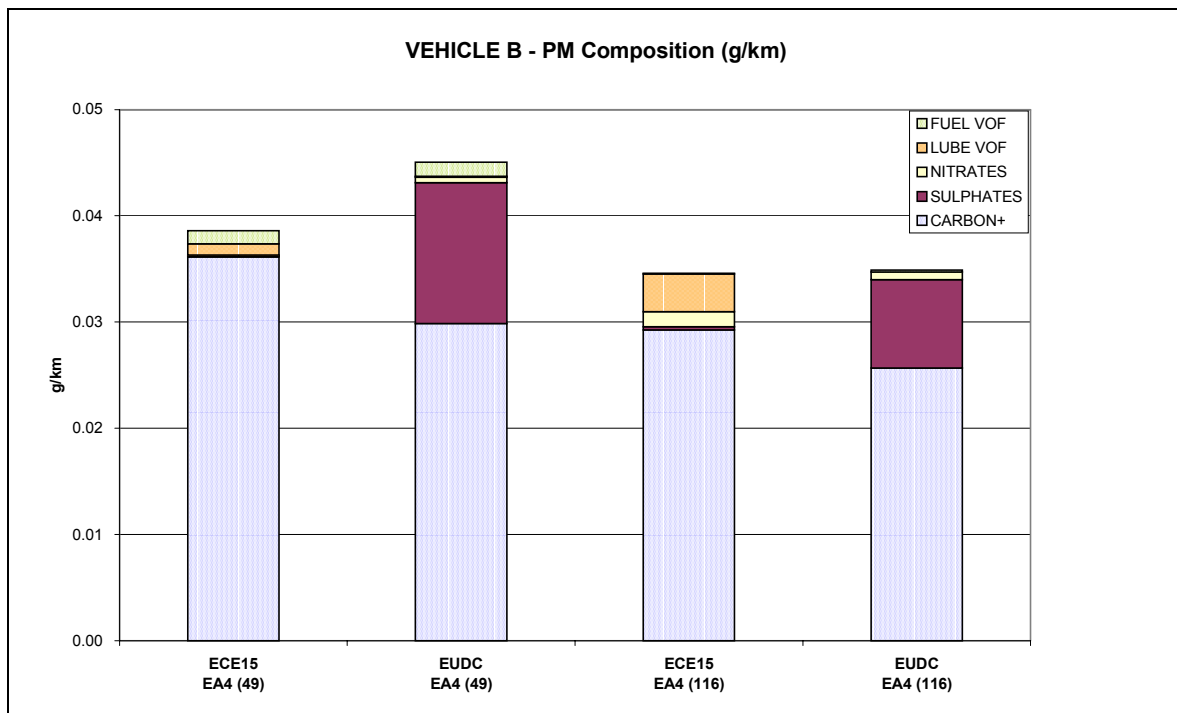
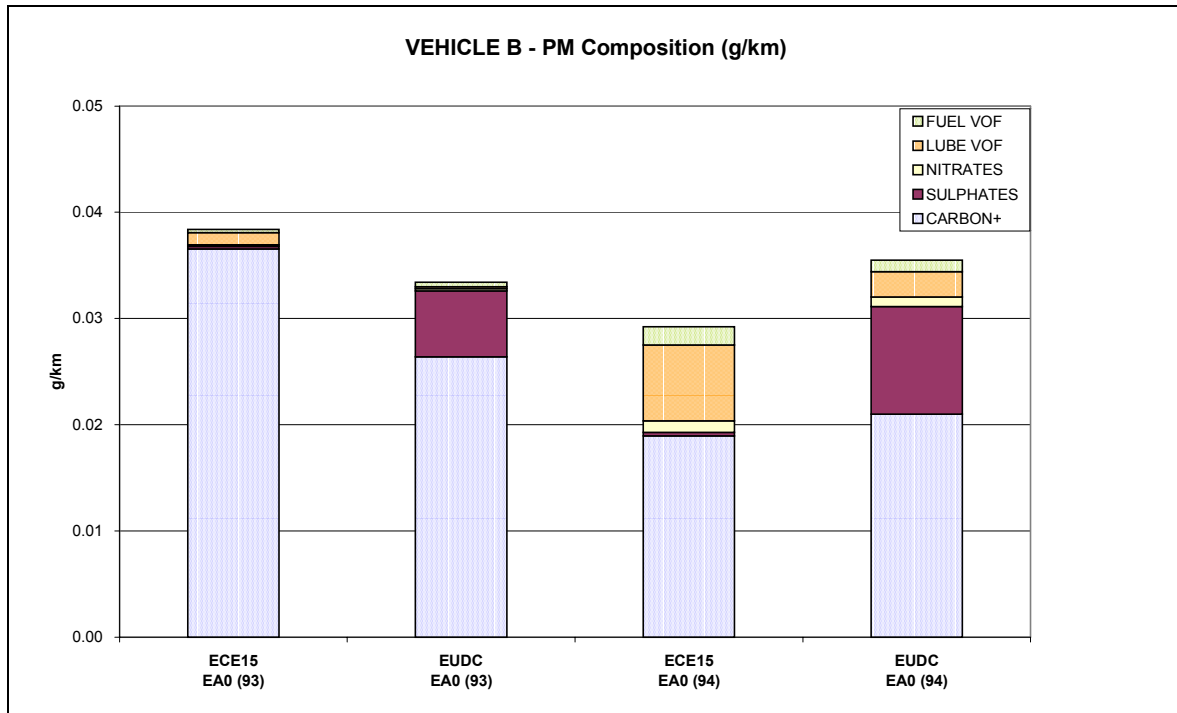
**Table 14** Particulate filter analyses – LD fleet

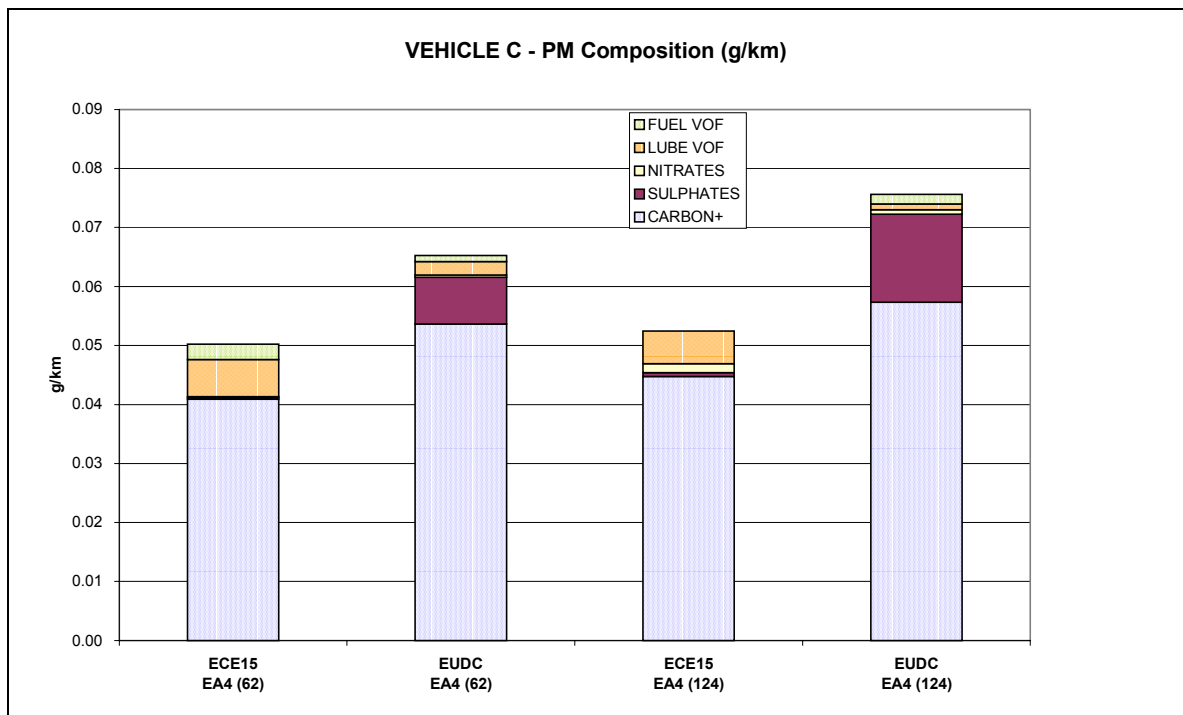
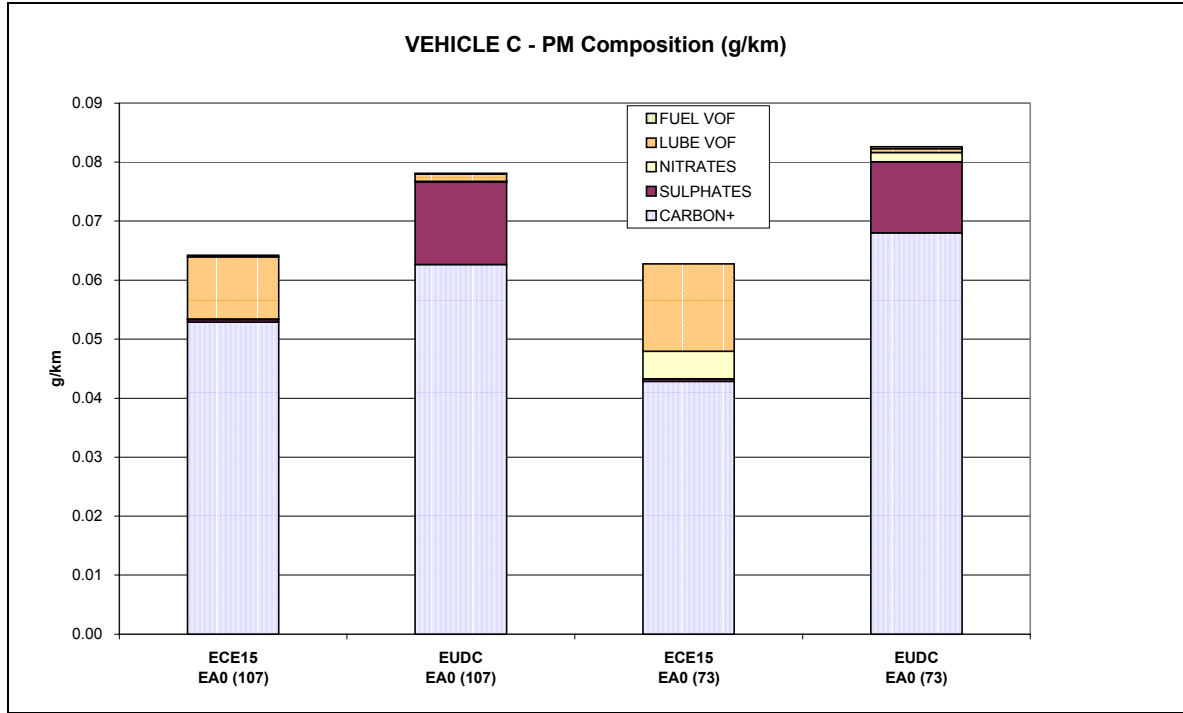
Vehicle	A	A	A	A	B	B	B	B	C	C	C	C
Test no.	25	25	53	53	49	49	93	93	107	107	62	62
Phase	ECE	EUDC	ECE	EUDC	ECE	EUDC	ECE	EUDC	ECE	EUDC	ECE	EUDC
Fuel	EA0	EA0	EA4	EA4	EA4	EA4	EA0	EA0	EA0	EA0	EA4	EA4
Carbon+ (mg/km)	67.39	25.55	44.68	26.62	36.13	29.86	36.55	26.39	52.89	62.62	40.92	53.64
Sulphates (mg/km)	0.05	0.19	0.18	0.43	0.10	13.26	0.24	6.21	0.43	13.99	0.21	7.95
Nitrates (mg/km)	0.00	0.08	0.27	0.50	0.08	0.52	0.16	0.21	0.13	0.14	0.16	0.35
Lube VOF (mg/km)	7.04	1.49	4.93	0.84	1.07	0.10	1.12	0.19	10.53	1.23	6.34	2.25
Fuel VOF (mg/km)	2.58	0.38	4.80	2.05	1.24	1.33	0.32	0.42	0.24	0.09	2.60	1.08

Vehicle	A	A	A	A	B	B	B	B	C	C	C	C
Test no.	91	91	114	114	116	116	94	94	73	73	124	124
Phase	ECE	EUDC	ECE	EUDC	ECE	EUDC	ECE	EUDC	ECE	EUDC	ECE	EUDC
Fuel	EA0	EA0	EA4	EA4	EA4	EA4	EA0	EA0	EA0	EA0	EA4	EA4
Carbon+ (mg/km)	66.51	28.90	39.97	30.45	29.26	25.68	18.96	21.01	42.86	68.04	44.75	57.33
Sulphates (mg/km)	0.22	0.67	0.19	0.77	0.29	8.31	0.32	10.11	0.40	11.10	0.61	14.94
Nitrates (mg/km)	0.87	1.03	1.23	1.65	1.44	0.74	1.09	0.92	4.66	1.60	1.58	0.74
Lube VOF (mg/km)	1.74	0.37	0.00	0.00	3.54	0.00	7.14	2.38	14.82	0.64	5.48	0.98
Fuel VOF (mg/km)	3.09	0.75	4.93	2.67	0.08	0.19	1.70	1.07	0.00	0.32	0.00	1.63

**Figure 13** Particulate filter analyses – LD fleet







## 8. CONCLUSIONS

### **GENERAL**

- The overall emissions levels from the Euro-3 engines were some 25-40% lower than the EPEFE fleet.
- The fuel effects studied (cetane and aromatics) were generally small compared to engine technology effects and test variability.
- No statistically significant fuel effects on the overall fleet emissions were found for those pollutants (PM and NO<sub>x</sub>) where the emissions limits are most difficult to meet.
- Where statistically significant effects were observed (HC and CO) the emissions levels were well below the Euro-3 limits.
- Different vehicles may respond to the same fuel changes in different ways.
- There is some evidence that the newer Euro-3 technology vehicles may respond to fuel changes differently than the Euro-2 technology vehicles evaluated in the EPEFE programme.

### **CETANE NUMBER EFFECTS**

- Increasing Cetane Number (from 53 to 58) had no significant effect on NO<sub>x</sub> or PM emissions in either the HD engines or LD vehicles tested.
- Increasing Cetane Number directionally reduced HC and CO emissions. In the HD engines, cetane effects on HC emissions were not significant, and only one engine showed a significant cetane effect on CO emissions. For the LD vehicles statistically significant reductions were seen in all but one case.
- No emissions differences were seen between natural cetane fuels and those where the cetane number was boosted using ignition improver additive.

### **AROMATICS EFFECTS**

- For the HD engines, reducing total aromatics reduced HC emissions in both engines tested. There were no significant effects on CO, NO<sub>x</sub> or PM emissions.
- For the LD vehicles tested in this study, only vehicle C showed significant effects for NO<sub>x</sub> and PM emissions. As aromatics levels reduced, this vehicle gave lower NO<sub>x</sub> and higher PM emissions. There were no consistent trends in HC emissions, but CO emissions tended to decrease with lower aromatics.
- As the total aromatics effects were small, it was not possible to separately quantify the relative contributions from mono- versus poly-aromatics.

### **AROMATICS EFFECTS IN COMPLEMENTARY LD VEHICLE STUDIES**

- HC and CO emissions showed no consistent pattern over the vehicles tested. In the complementary studies, the Euro-3 vehicles showed emission reductions at lower aromatics, whereas the older Euro-2 cars showed little or no benefit from lower aromatics.

- For NO<sub>x</sub>, fuel effects between the different vehicles, although still varying, were more consistent. On average, a 10% reduction in mono- or poly-aromatics reduced NO<sub>x</sub> emissions by around 3%. The relative impacts of mono- and poly-aromatics appeared similar.
- PM emission effects showed variation between the different vehicles. Differences in behaviour between Euro-2 and Euro-3 technology in the complementary studies were not mirrored in the results from the current study.

## **9. FURTHER WORK**

Further work will be needed to investigate the importance of fuel quality effects on emissions from Euro-4 and Euro-5 engine technologies, as these start to become available. It will be important to understand the level of emissions achieved by these engines and the relative impact of fuel properties at such low emissions levels.

CONCAWE plans to undertake such investigations as soon as examples of such advanced engine technologies become available.

**10. GLOSSARY**

CONCAWE	Conservation of Clean Air and Water in Europe (the oil companies' European organisation for environment, health and safety)
CR	Compression Ratio
CVS	Constant Volume Sampling System
DI	Direct Injection
EGR	Exhaust Gas Recirculation
ELR	European Load Response Test
EPEFE	European Programme on Emissions, Fuels and Engine Technologies
ESC	European Stationary Cycle
FIE	Fuel Injection Equipment
HD	Heavy-duty
IDI	Indirect Injection
KV40	Kinematic Viscosity at 40°C
LD	Light-duty
MVEG	Motor Vehicles Emissions Group
Significant	Statistically significant at >95% confidence
TCI	Turbo Charger Intercooler
T10	Temperature (°C) at which 10% v/v diesel is recovered
T50	Temperature (°C) at which 50% v/v diesel is recovered
T95	Temperature (°C) at which 95% v/v diesel is recovered
VOF	Volatile Organic Fraction



## 11. REFERENCES

1. EPEFE (1995) European programme on emissions, fuels and engine technologies. EPEFE Report on behalf of ACEA and EUROPIA
2. EU (1998) Directive 98/69/EC of the European Parliament and of the Council of 13 October 1998 relating to measures to be taken against air pollution by emissions from motor vehicles and amending Council Directive 70/220/EEC. Official Journal of the European Communities No. L350, 28.12.1998
3. EU Directive 1999/96/EC of the European Parliament and of the Council of 13 December 1999 on the approximation of the laws of the Member States relating to measures to be taken against the emission of gaseous and particulate pollutants from compression ignition engines for use in vehicles, and the emission of gaseous pollutants from positive ignition engines fuelled with natural gas or liquefied petroleum gas for use in vehicles and amending Council Directive 88/77/EEC. Official Journal of the European Communities No. L44, 16.02.2000
4. Hochhauser, A.M. and Benson, J.D. (1991) The effects of aromatics, MTBE, olefins and T90 on mass exhaust emissions from current and older vehicles - the auto/oil air quality improvement research program. SAE Paper No. 912322. Warrendale PA: Society of Automotive Engineers
5. Painter, L.J. and Rutherford, J.A. (1992) Statistical design and analysis methods for the auto/oil air quality research program. SAE Paper No. 920319. Warrendale PA: Society of Automotive Engineers
6. McArragher, J.S. et al (1994) The influence of heavy gasoline components on the exhaust emissions of European vehicles. Part I - regulated emissions. Report No. 94/59. Brussels: CONCAWE
7. CONCAWE (2001) Automotive emissions of polycyclic aromatic hydrocarbons. *CONCAWE Review* 10, 1, 9-12. Brussels: CONCAWE

## 12. **ACKNOWLEDGEMENTS**

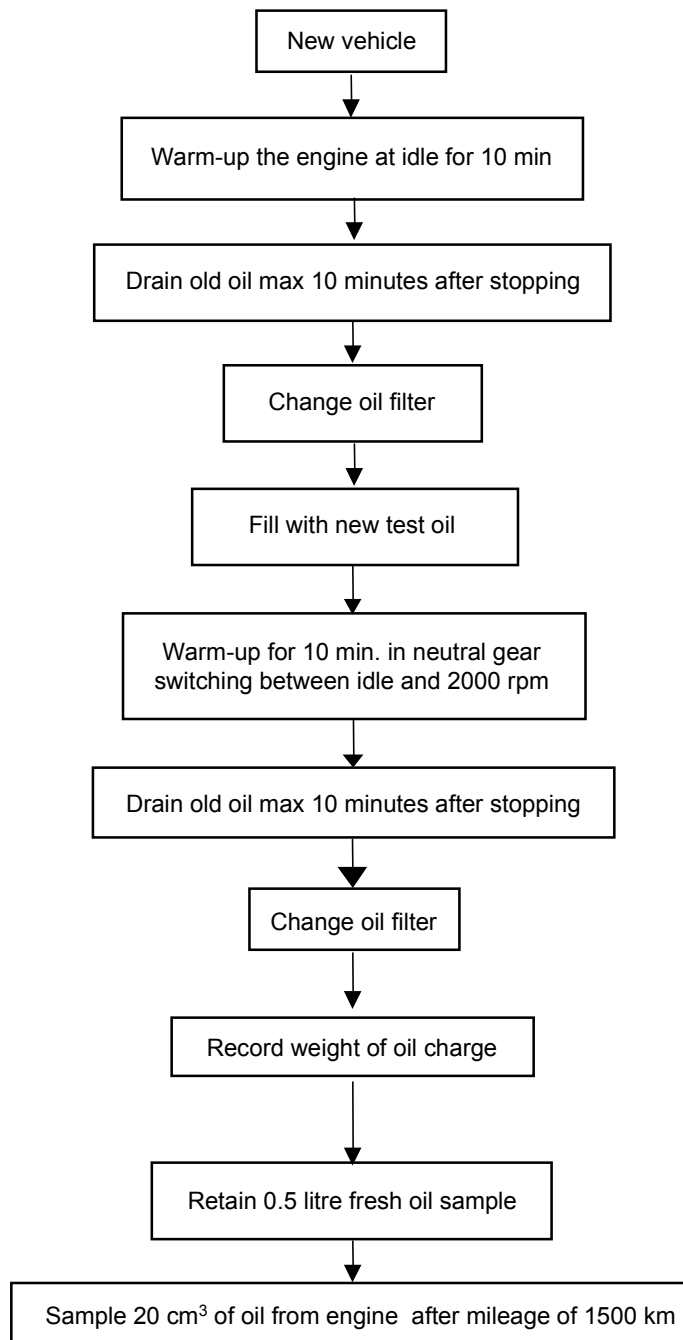
CONCAWE STF-18 would like to acknowledge the contributions of the following parties to this programme:

AVL, Graz for their assistance with the HD tests;

AgipPetroli CREA for their assistance with the LD tests;

Pete Zemroch (Shell Global Solutions) for statistical analysis, expertise and advice;

Peter Heinze (former CONCAWE Technical Coordinator) for his expertise and efforts in coordinating the programme.

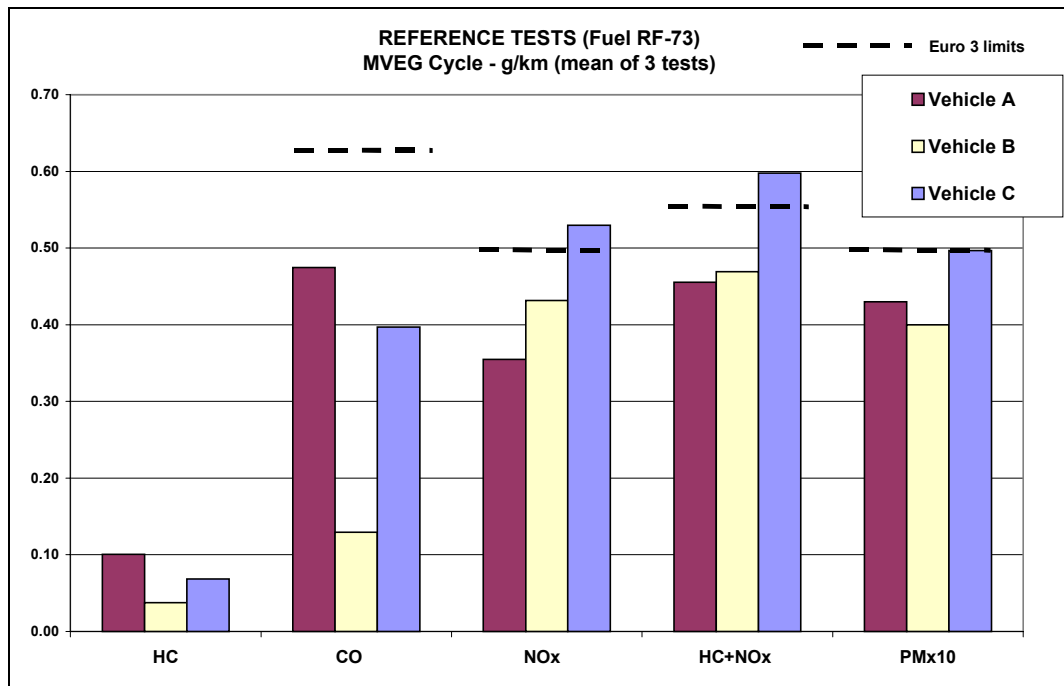
**APPENDICES****APPENDIX 1 OIL CHANGE PROCEDURE**

## APPENDIX 2 PROPERTIES OF TEST FUEL USED FOR LD VEHICLES INITIAL EMISSIONS COMPLIANCE

Properties	Unit	Fuel RF-73	Method
Density @ 15°C	kg/m <sup>3</sup>	838.2	ASTM D4052
Sulphur	mg/kg	435	ASTM D5453
Kinematic Viscosity @ 40°C	mm <sup>2</sup> /s	3.44	ASTM D445
CFPP	°C	-17	EN 116
Cloud Point	°C	-14	ASTM D2500
Flash Point	°C	76	ASTM D93
Cetane Index (4 Var.)	-	54	ASTM D4737
Cetane Number	-	51.2	ASTM D613
ASTM Distillation			ASTM D86
IBP	°C	210	
5% v/v recovered at	°C	236	
10% v/v recovered at	°C	244	
20% v/v recovered at	°C	256	
30% v/v recovered at	°C	266	
40% v/v recovered at	°C	274	
50% v/v recovered at	°C	281	
60% v/v recovered at	°C	289	
70% v/v recovered at	°C	298	
80% v/v recovered at	°C	309	
90% v/v recovered at	°C	325	
95% v/v recovered at	°C	339	
FBP	°C	354	
Recovered at 250°C	% v/v	14.4	
Recovered at 350°C	% v/v	96.8	
Aromatics			IP 391
Mono-aromatics	%m/m	14.7	
Di-aromatics	%m/m	2.2	
Tri-aromatics	%m/m	0.3	
Poly-aromatics	%m/m	2.5	
Total aromatics	%m/m	17.2	

### APPENDIX 3 EMISSIONS COMPLIANCE TEST RESULTS ON THE LD VEHICLES

Reference Emission Tests (average of 3 tests)						
	Fuel	HC (g/km)	CO (g/km)	NOx (g/km)	HC+NOx (g/km)	PM (g/km)
<b>[Euro-3 limits]</b>			[0.64]	[0.50]	[0.56]	[0.05]
<b>Vehicle A</b>	RF-73	0.101	0.475	0.355	0.456	0.043
<b>Vehicle B</b>	RF-73	0.038	0.129	0.432	0.469	0.040
<b>Vehicle C</b>	RF-73	0.068	0.397	<b>0.530</b>	<b>0.598</b>	0.050



#### APPENDIX 4 PROPERTIES OF TEST FUEL USED FOR HD ENGINE INITIAL EMISSIONS COMPLIANCE

Properties	Unit	Fuel RF-2000	Method
Density @ 15°C	kg/m <sup>3</sup>	833	ISO 3675
Sulphur	mg/kg	210	EN 24260
Kinematic Viscosity @ 40°C	mm <sup>2</sup> /s	2.92	ISO 3104
Cloud Point	°C	-18	DIN 51428
Cetane Index	-	54	ASTM D976
Cetane Number	-	53.4	ISO 5165
ASTM Distillation			ISO 3405
IBP	°C	178	
10% v/v recovered at	°C	214	
20% v/v recovered at	°C	230	
30% v/v recovered at	°C	242	
50% v/v recovered at	°C	272	
70% v/v recovered at	°C	300	
95% v/v recovered at	°C	352	
FBP	°C	364	
H/C Ratio		1.88	Calculated
Aromatics			IP 391
Mono-aromatics	% m/m	15.3	
Di-aromatics	% m/m	3.5	
Tri-aromatics	% m/m	1.4	
Poly-aromatics	% m/m	4.9	
Total aromatics	% m/m	20.2	

## APPENDIX 5 EMISSIONS COMPLIANCE TEST RESULTS ON THE HD ENGINES

### ENGINE 1: REFERENCE TESTS

The following tests on the reference fuel were carried out:

- 3 ESC Cycles
- 3 ELR Cycles

The results are given in **Tables A.5.1 and A.5.2**

**Table A.5.1** ESC test results

Test No	HC	CO	NOx	PM
	(g/kWh)			
1	0.13	0.41	4.85	0.082
2	0.13	0.41	4.79	0.081
3	0.13	0.41	4.83	0.086
Average	0.13	0.41	4.82	0.083
Euro-3 Limits	0.66	2.1	5.0	0.10

**Table A.5.2** ELR test results

Test Number	Opacity Total
	(m <sup>-1</sup> )
1	0.367
2	0.363
3	0.353
Average	0.361
Euro-3 Limit	0.8

### ENGINE 2: REFERENCE TESTS

The following test cycles were run on the reference fuel:

- 24 ESC Cycles (some of these tests were used for conditioning and to stabilise the engine; regulated emissions were measured in 7 cycles as shown below)
- 3 ELR Cycles

The results are given in **Table A.5.3 and A.5.4**

**Table A.5.3** ESC test results

Test No	HC	CO	NOx	PM
	(g/kWh)			
3	0.19	0.31	4.77	0.095
9	0.19	0.31	4.90	0.095
12	0.19	0.32	4.84	0.096
16	0.19	0.31	4.79	0.094
19	0.19	0.31	4.61	0.096
22	0.19	0.31	4.73	0.096
23	0.19	0.31	4.74	0.097
Average	0.19	0.31	4.77	0.096
Euro-3 Limits	0.66	2.1	5.0	0.10

**Table A.5.4** ELR test results

Test Number	Opacity Total
	(m <sup>-1</sup> )
1	0.318
2	0.323
3	0.324
Average	0.322
Euro-3 Limit	0.8



**APPENDIX 6 ANALYSIS RESULTS OF SAMPLES FROM AROMATICS MATRIX**

Property		EA 0	EA2	EA3	EA 4	EA 5	EA8
Aromatic HC Distr. IP 391/95							
Total Aromatics	%m/m	12.0	23.4	25.7	29.4	21.7	22.1
1-ring Aromatics	%m/m	10.4	22.4	20.3	18.8	10.1	16.1
2-ring Aromatics	%m/m	1.3	1.0	5.2	10.3	11.4	5.7
3-ring Aromatics	%m/m	0.1	0.0	0.2	0.3	0.2	0.3
Poly-aromatics	%m/m	1.5	1.0	5.4	10.6	11.6	6.0
Cetane Index	ASTM D 4737	60.6	51.7	53.5	49.4	51.8	51.5
Cetane Number	ASTM D 613	58.3	51.4	53.3	51.1	52.7	52.4
Cloud Point	ASTM D 2500 °C	-17.0	-24.6	-11.5	-8.0	-13.7	-9.8
Density @ 15°C	ASTM D 4052 kg/m <sup>3</sup>	836.1	836.5	837.9	837.4	837.8	838.4
Distillation ASTM D 86							
IBP	°C	197	187	191	177	188	195
End Point	°C	374	368	370	363	364	370
5% recovered at	°C	222	200	210	199	212	213
10% recovered at	°C	235	204	217	207	221	219
20% recovered at	°C	257	214	231	223	235	246
30% recovered at	°C	276	227	247	236	247	243
40% recovered at	°C	289	246	263	248	256	256
50% recovered at	°C	300	268	277	257	265	267
60% recovered at	°C	310	287	291	267	275	278
70% recovered at	°C	320	301	305	279	287	291
80% recovered at	°C	331	318	322	295	303	307
90% recovered at	°C	347	339	342	321	328	332
95% recovered at	°C	363	355	357	346	349	355
Total recovered	% v/v	98.2	98.3	98.3	98.3	98.4	98.0
Residue	% v/v	1.7	1.4	1.5	1.3	1.3	1.5
Loss	% v/v	0.1	0.3	0.2	0.3	0.3	0.5
Recovered @ 250 °C	% v/v	16	42	32	42	33	35
Recovered @ 350 °C	% v/v	90	93	92	95	95	94
Sulphur	ASTM D 2622 mg/kg	290	311	302	311	307	308
Kinematic Viscosity @ 40°C							
	ASTM D 445 mm <sup>2</sup> /s	4.1	2.5	2.9	2.3	2.7	2.8
Hydrogen	ASTM D 5291 %m/m	13.8	13.4	13.5	13.3	13.4	13.6
Carbon	ASTM D 5291 %m/m	86.1	86.6	86.6	86.7	86.6	86.2
CFPP	EN 116 °C	-21.2	-27.4	-17.0	-13.6	-17.8	-14.4
Lubricity	CEC F-06-A-96 µm	390	440	406	337	234	314
TAN	ASTM D 974 mg KOH/g	0.0	0.0	0.0	0.0	0.0	0.0
Water content	ASTM D 1744 mg/kg	16	19	21	27	21	17
Calorific Value ASTM D 240 MJ/kg							
Net		43.2	42.9	43.2	42.8	42.9	43.0
Gross		46.2	45.6	45.5	45.5	45.5	45.6

**APPENDIX 7 ANALYSIS RESULTS OF SAMPLES FROM CETANE MATRIX**

Property		FC1	FC2	FC3	FC4	FC5
Aromatic HC Distr. IP 391/95						
Total Aromatics	%m/m	24.3	25.7	25.9	23.7	23.7
1-ring Aromatics	%m/m	18.8	20.3	20.4	18.1	18.1
2-ring Aromatics	%m/m	4.4	5.2	5.3	4.9	4.9
3-ring Aromatics	%m/m	0.9	0.2	0.2	0.8	0.7
Poly-aromatics	%m/m	5.3	5.4	5.4	5.6	5.6
Cetane Index	ASTM D 4737	47.1	53.5	53.6	55.1	55.0
Cetane Number	ASTM D 613	49.4	53.3	54.9	54.5	58.2
Cloud Point	ASTM D 2500 °C	-15.8	-11.5	-10.8	1.8	1.8
Density @ 15°C	ASTM D 4052 kg/m <sup>3</sup>	837.8	837.9	837.9	836.5	836.5
Distillation ASTM D 86						
IBP	°C	157	191	193	180	180
End Point	°C	367	370	370	371	370
5% recovered at	°C	178	210	210	202	201
10% recovered at	°C	184	217	217	214	213
20% recovered at	°C	200	231	231	237	237
30% recovered at	°C	217	247	247	258	258
40% recovered at	°C	235	263	263	273	272
50% recovered at	°C	253	277	278	283	283
60% recovered at	°C	272	291	291	295	295
70% recovered at	°C	294	305	305	308	308
80% recovered at	°C	317	322	322	324	325
90% recovered at	°C	342	342	342	345	345
95% recovered at	°C	358	357	358	359	359
Total recovered	%v/v	98.5	98.3	98.5	98.6	98.4
Residue	%v/v	1.2	1.5	1.3	1.2	1.4
Loss	%v/v	0.3	0.2	0.2	0.3	0.2
Recovered @ 250 °C	%v/v	48	32	32	26	25
Recovered @ 350 °C	%v/v	92	92	92	91	91
Sulphur	ASTM D 2622 mg/kg	293	302	276	296	295
Kinematic Viscosity @ 40°C						
	ASTM D 445 mm <sup>2</sup> /s	2.3	2.9	2.9	3.0	3.0
Hydrogen	ASTM D 5291 %m/m	13.4	13.5	13.4	13.5	13.4
Carbon	ASTM D 5291 %m/m	86.4	86.6	86.5	86.2	86.5
CFPP	EN 116 °C	-17.5	-17.0	-16.3	-0.5	-0.8
Lubricity	CEC F-06-A-96 µm	284	406	387	320	359
Water content	ASTM D 1744 mg/kg	23	21	21	22	22
Calorific Value ASTM D 240 MJ/kg						
Net		42.9	43.2	42.8	42.9	42.9
Gross		45.6	45.5	45.5	45.5	45.7

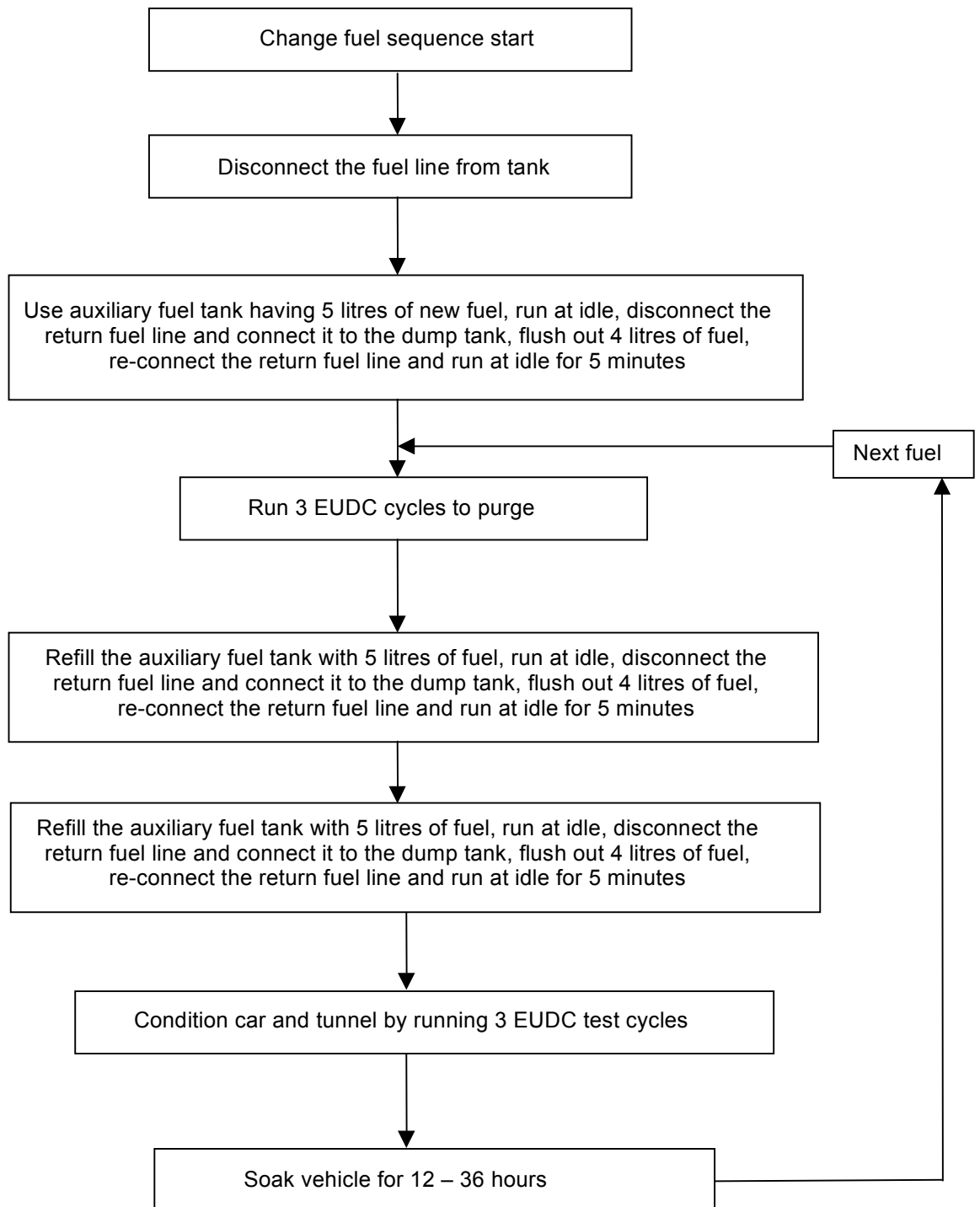
## APPENDIX 8 LD VEHICLE TEST PROTOCOL

1. Change fuel to next test fuel (as defined by test sequence), using suitable fuel change procedure (see **Appendix 9**)
2. Condition car and tunnel by running 3 x EUDC test cycles
3. Soak vehicle in designated area at 25°C (+/- 5°C) for 12 - 36 hours
4. Pre-condition dilution tunnel (As consistently no significant "blank" levels were observed, pre-conditioning was carried out once/day, prior to the first test.)
5. Carry out particulate measurements without vehicle until "blank" weight <0.025mg (adopted procedure as defined in EPEFE protocols)
6. Carry out cold-start "MVEG" test measuring gaseous bag (dilute) emissions and particulates by filter papers:
  - Bag 1 - ECE cycles 1-4 : gaseous emissions and particulates (filter paper 1)
  - Bag 2 - EUDC: gaseous emissions and particulates (filter paper 2)

In addition to the legislated emissions, the following measurements were carried out simultaneously:

- continuous second by second raw emissions, pre and post catalyst(s)
- exhaust gas temperature, pre and post catalyst(s).

**APPENDIX 9 FUEL CHANGE PROCEDURE FOR LD VEHICLES**



## APPENDIX 10 HEAVY-DUTY TEST OPERATING CONDITIONS

### ESC CYCLE - DEFINITION OF OPERATING CONDITIONS

$n_{low}$  = the lowest engine speed where 50% of the declared max. power occurs  
 $n_{high}$  = the highest engine speed where 70% of the declared max. power occurs

**ESC Test Speed A** :  $n_{low} + 25\% (n_{high} - n_{low})$   
**ESC Test Speed B** :  $n_{low} + 50\% (n_{high} - n_{low})$   
**ESC Test Speed C** :  $n_{low} + 75\% (n_{high} - n_{low})$

#### Engine 1

<b>Max power [kW] @ rpm [1/min]</b>	224 @ 2100
<b><math>n_{low}</math> [1/min] @ P [kW]</b>	1050 @ 112
<b><math>n_{high}</math> [1/min] @ P [kW]</b>	2400 @ 156.8

	<b>A</b>	<b>B</b>	<b>C</b>
<b>ESC Test Speed, 1/min</b>	1388	1725	2063
<b>BMEP, bar</b>	22.3	20.8	18.0

<b>Mode</b>	<b>Speed</b>	<b>Load</b>	<b>BMEP</b>	<b>Torque</b>	<b>Weighting Factor</b>
	1/min	%	bar	Nm	
1	630	0	0.0	0.0	0.15
2	1388	100	22.3	1290	0.08
3	1725	50	10.4	603	0.10
4	1725	75	15.6	904	0.10
5	1388	50	11.1	645	0.05
6	1388	75	16.7	967	0.05
7	1388	25	5.6	322	0.05
8	1725	100	20.8	1206	0.09
9	1725	25	5.2	301	0.10
10	2063	100	18	1046	0.08
11	2063	25	4.5	261	0.05
12	2063	75	13.5	784	0.05
13	2063	50	9.0	523	0.05

**Engine 2**

<b>Max power [kW] @ rpm [1/min]</b>	250 @ 1900
<b>n<sub>low</sub> [1/min] @ P [kW]</b>	950 @ 125
<b>n<sub>high</sub> [1/min] @ P [kW]</b>	2100 @ 175

	<b>A</b>	<b>B</b>	<b>C</b>
<b>ESC Test Speed, 1/min</b>	1238	1525	1813
<b>BMEP, bar</b>	18.9	17.6	15.4

<b>Mode</b>	<b>Speed</b>	<b>Load</b>	<b>BMEP</b>	<b>Torque</b>	<b>Weighting Factor</b>
	1/min	%	bar	Nm	
1	630	0	0.0	0.0	0.15
2	1238	100	18.9	1601	0.08
3	1525	50	8.8	745	0.10
4	1525	75	13.2	1118	0.10
5	1238	50	9.5	800	0.05
6	1238	75	14.2	1200	0.05
7	1238	25	4.7	400	0.05
8	1525	100	17.6	1490	0.09
9	1525	25	4.4	373	0.10
10	1813	100	15.4	1304	0.08
11	1813	25	3.9	326	0.05
12	1813	75	11.6	978	0.05
13	1813	50	7.7	652	0.05

## APPENDIX 11 HEAVY-DUTY TEST PROTOCOL DETAILS

1. Change fuel to next test fuel (as defined by test sequence), using suitable fuel change procedure
  - Empty fuel system completely (fuel system of the engine, fuel filter, fuel utility system)
  - Install a new fuel filter, flush the system with new test fuel, warm up and operate the engine for about 10 minutes at 1500 rpm/15 bar
  - Stop engine, install new fuel filter, warm up and operate the engine at 1500 rpm/15 bar for 5 minutes
2. Condition engine with the new test fuel
3. Check maximum torque (Full Load test)
4. Carry out ELR test
5. Carry out ESC test

In addition to the legislated emissions, particulate samples were analysed and split up into insoluble and soluble (SOF) fractions. The Soxhlet extraction method was used.

## APPENDIX 12 STATISTICAL DATA ANALYSIS

This appendix provides additional information on the statistical data analyses discussed in Section 6.

### **Criteria for extra tests**

Extra tests were required for a particular vehicle × fuel combination if the ratio of the largest to the smallest of the three results exceeded the following thresholds:

	<u>LD</u>	<u>HD</u>
HC	1.65 if <0.05 g/km 1.40 if >0.05 g/km	1.5
CO	1.55 if <0.10g/km 1.35 if >0.10g/km	1.1
NOx	1.15	1.1
PM	1.40 if <0.06g/km 1.25 if >0.06g/km	1.1

These values were set taking into account (i) the capabilities of the test laboratory, (ii) the actual variability in the EPEFE data and (iii) extra allowances as the variability was expected to be higher in relative terms at the lower absolute emission levels found in more modern Euro-3 vehicles/engines.

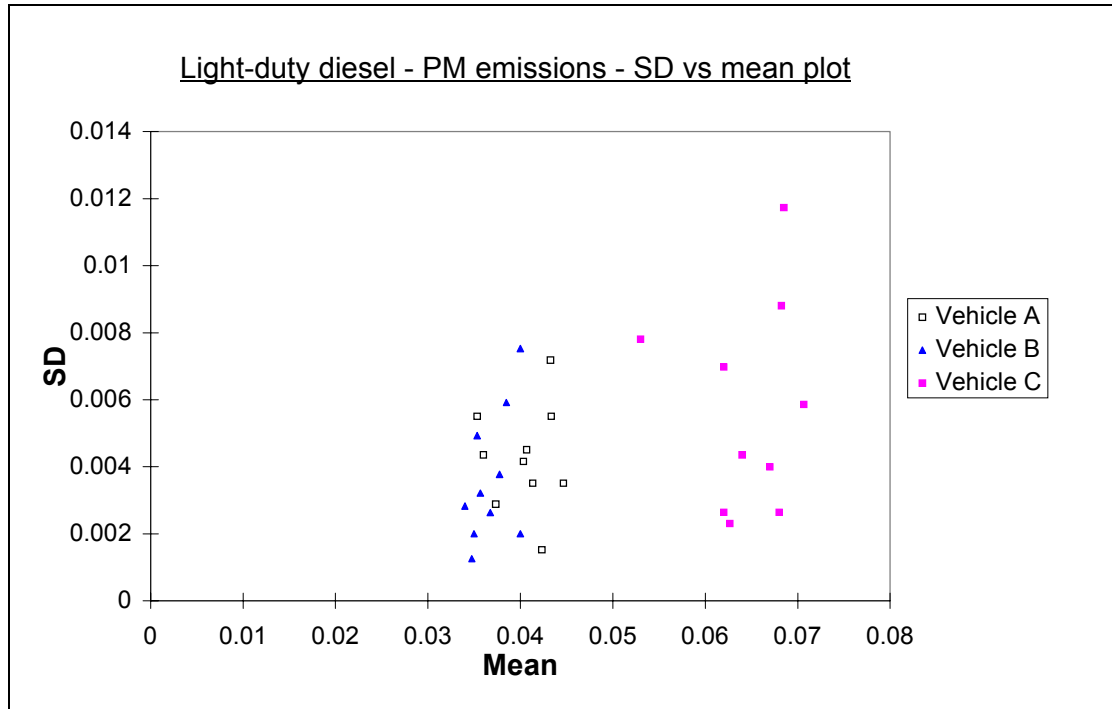
### **Standard deviation vs. mean plots**

The distributions of sets of repeat measurements of automotive emissions or atmospheric concentrations are typically asymmetric or “skewed” and bear little resemblance to the standard bell-shaped normal or “Gaussian” distribution. In the EPEFE gasoline project [1] and other previous emission studies [4,5,6] the variability in emissions measurements has been found to follow the log-normal distribution with the degree of scatter increasing as the emission level increases.

**Figure A.12.1** is a typical standard deviation vs. mean graph plotting the SD of the three PM measurements for each of the 30 light-duty vehicle × fuel combinations in the present study against the mean. Looking at each vehicle in turn, there is too little variation in mean emissions to determine whether the SD increases with the mean or is constant. In the absence of evidence to the contrary, it is assumed that the measurements in the present study do follow the log-normal distribution as mechanistically this is the most plausible model for emissions data.



**Figure A.12.1** Typical SD vs. mean plot.



**Outliers and trends**

The data were examined for outliers and trends by plotting “studentized” residuals (residuals divided by their standard error) on a log scale against test number. **Figure A.12.3** shows some typical examples of such plots.

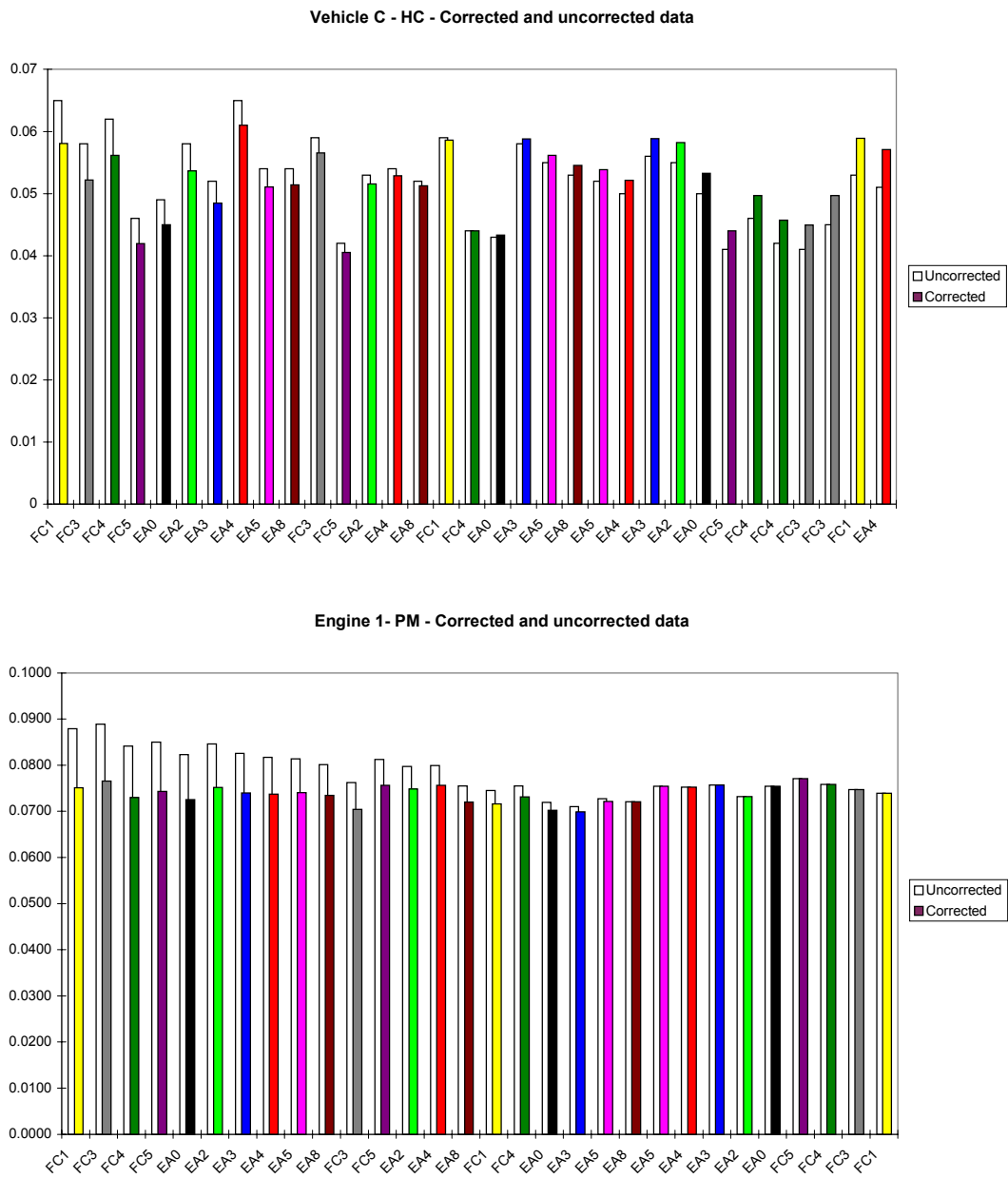
The engine 2 data showed no systematic trends and so no data correction was necessary. Vehicle C HC residuals, on the other hand, decreased with test number and so a linear correction was employed. The exact trend correction was calculated by analysis of covariance techniques (similar but not identical to the fitted line in **Figure A.12.3**). Examples of the observed and corrected values are compared in **Figure A.12.2**. Linear trend corrections were also applied to vehicle C CO and PM data and to the vehicle A HC results, with the trends being significant at  $P < 0.1\%$  in each case.

In the engine 1 PM data, we see a downwards linear trend over tests 1-20, before the engine settled into a steady state (**Figure A.12.3**). These emissions were adjusted to what they might have been had all the tests been conducted in the steady state period (Fig A.12.2). Thus the adjusted emissions are somewhat lower than the unadjusted values. One HC measurement in the engine 1 data set (test no. 15) was rejected as an outlier due to calibration problems.

Finally, in the vehicle B HC data, we see from **Figure A.12.3** that the first result on fuel EA3 is out of line with the rest which show a steady increase with time. Subsequent investigations revealed that the ambient temperature was only 21.7°C compared with 23-24°C in other tests. Therefore this entire test was considered suspect. Thus we adjusted the data by rejecting this test for all four emissions and then applying a linear trend correction to the HC data.

Analyses of both the adjusted and unadjusted data were carried out. Adjustments had little effect on the mean emissions for each fuel due to the robust randomised block experimental design used. Only the final corrected data-set was used for the final analysis described in this report.

**Figure A.12.2** Examples of trend corrections



### Arithmetic means and regression analysis

In this report, arithmetic means are used to summarise the average emissions using each fuel in each vehicle, in line with EPEFE [1]. Geometric means are sometimes used in emissions studies as they give excellent comparisons between fuels on a percentage basis. However, they have the disadvantage of underestimating total emissions to the atmosphere.

Weighted regression analysis had to be used to relate emissions statistically to fuel properties as the emissions measurements were assumed to have the log-normal distribution. Each emission measurement was thus assigned a weight equal to

$$\text{weight} = 1 / (\text{mean emission for that fuel and vehicle})^2$$

(see [1], Annex 05).

In several of the figures in this report, “error bars” are shown around the average emissions for the various fuels. These have been constructed so that when two fuels are significantly different from one another at  $P < 5\%$ , their error bars will not overlap, as in EPEFE. We can be 84% confident that the true mean lies within the limits shown.

**Figure A.12.3** Plots of studentized residuals against test number

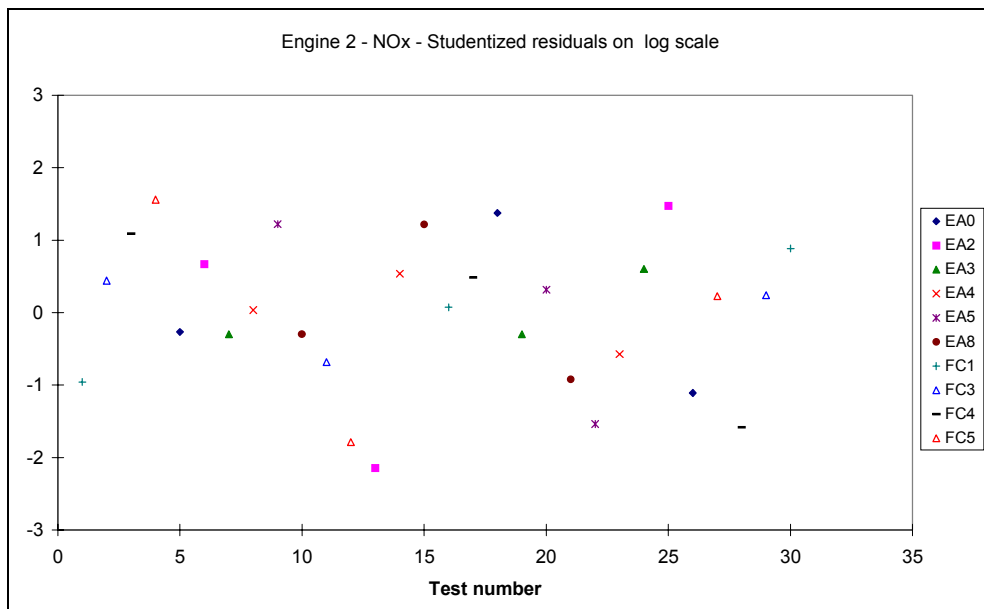
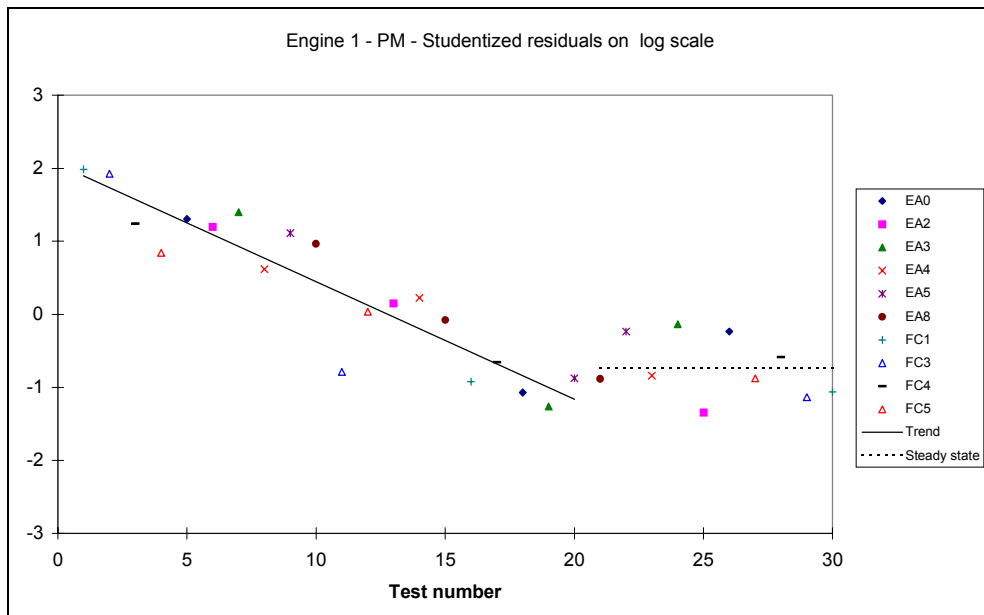
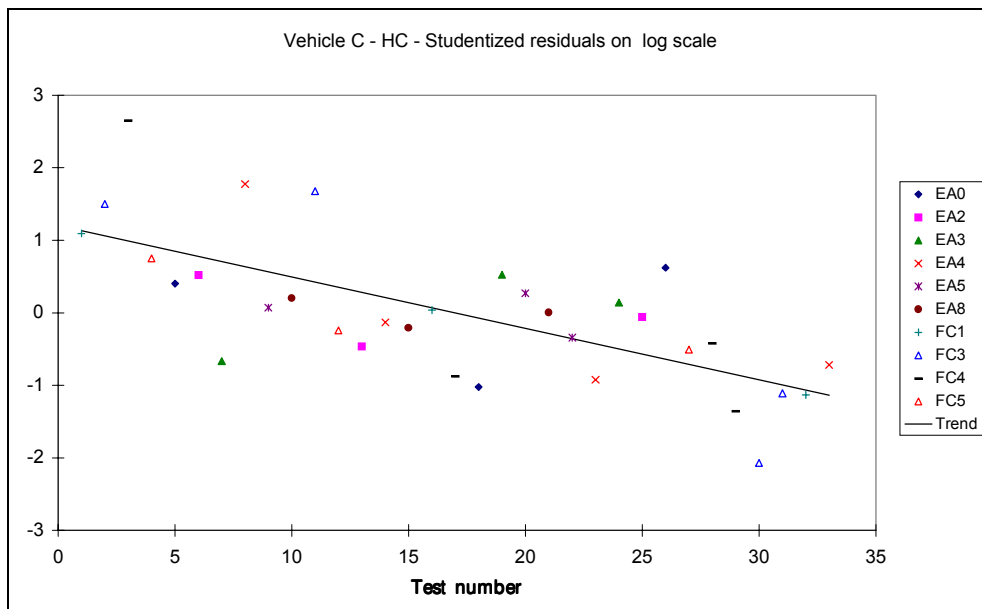
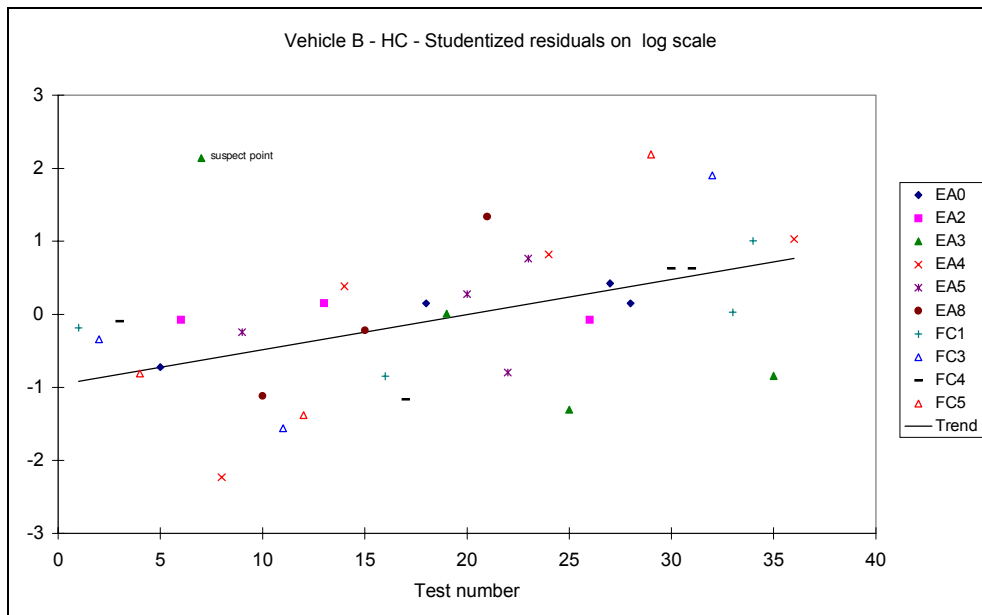
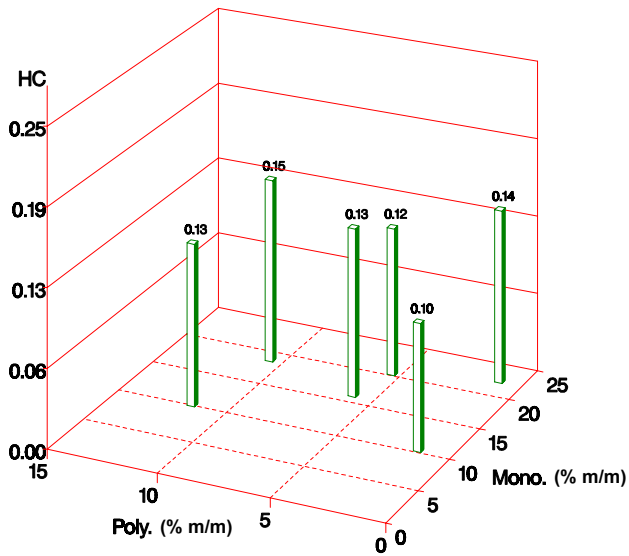


Figure A.12.3 Plots of studentized residuals against test number (cont.)

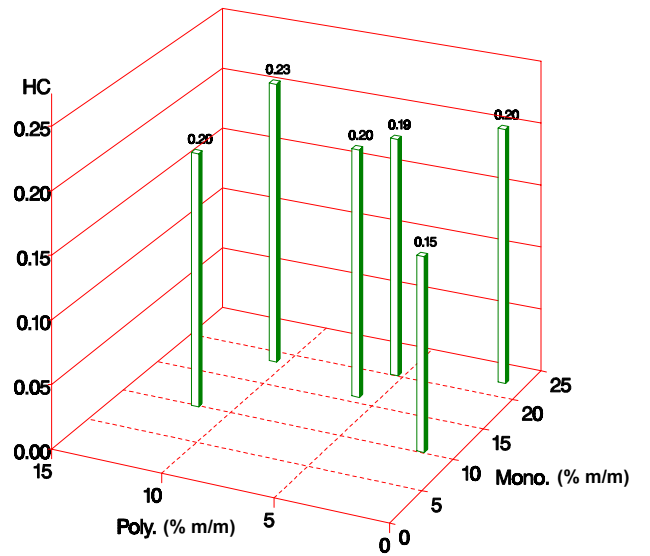


**APPENDIX 13 3-D PLOTS OF AROMATICS RESULTS**

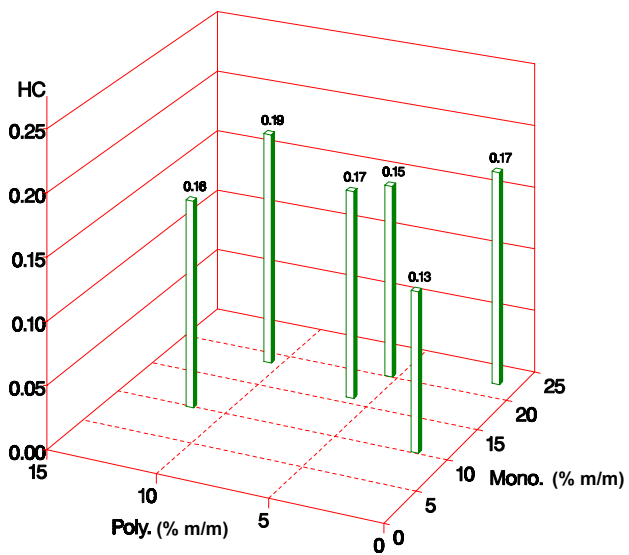
**Engine 1 – HC (g/kWh)**



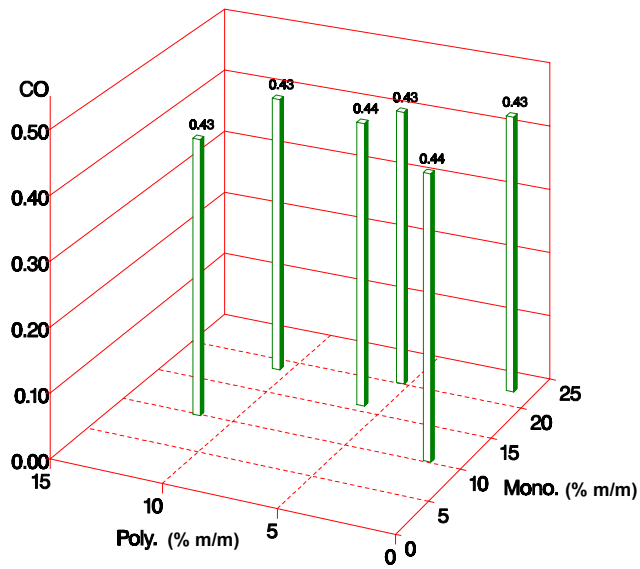
**Engine 2 – HC (g/kWh)**



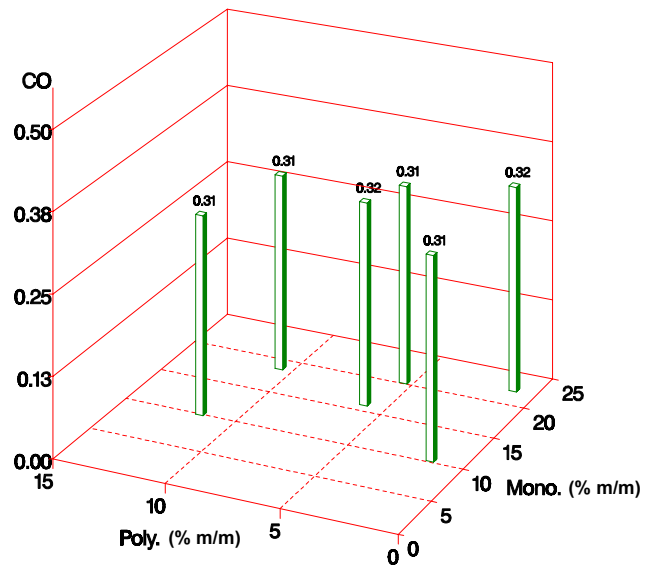
**HD fleet average – HC (g/kWh)**



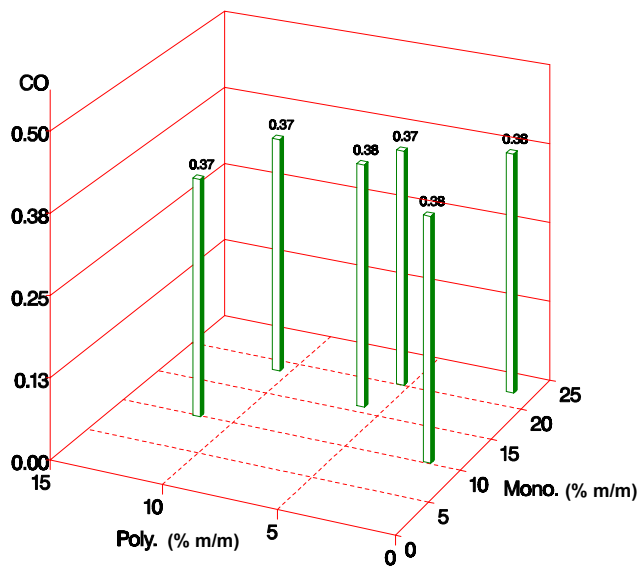
Engine 1 – CO (g/kWh)



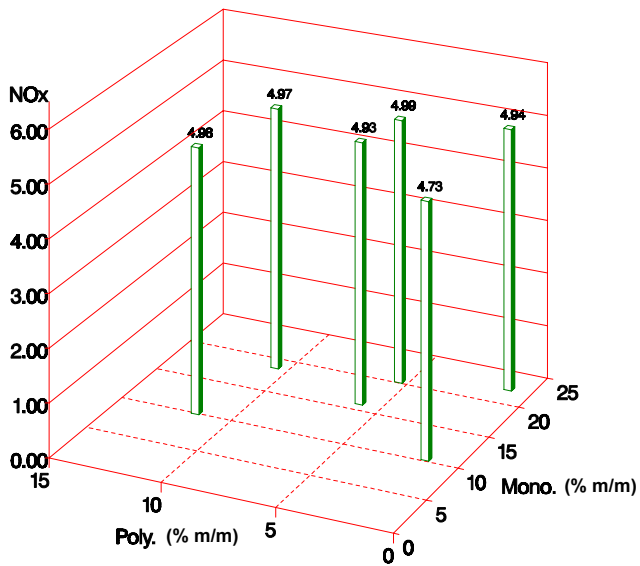
Engine 2 – CO (g/kWh)



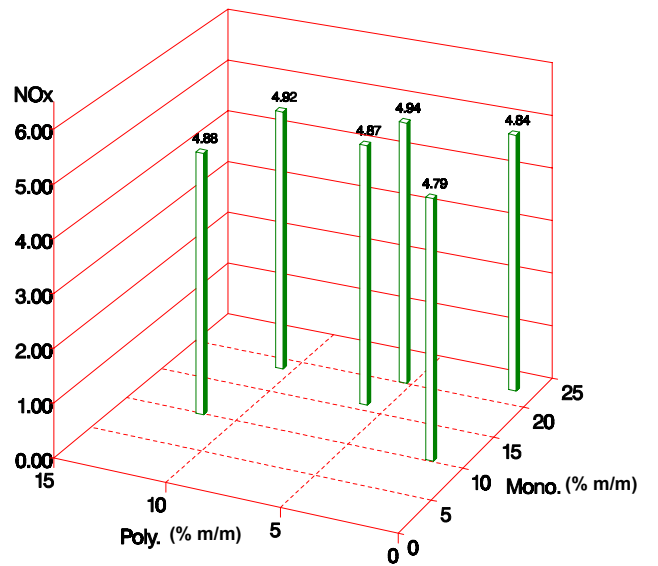
HD fleet average – CO (g/kWh)



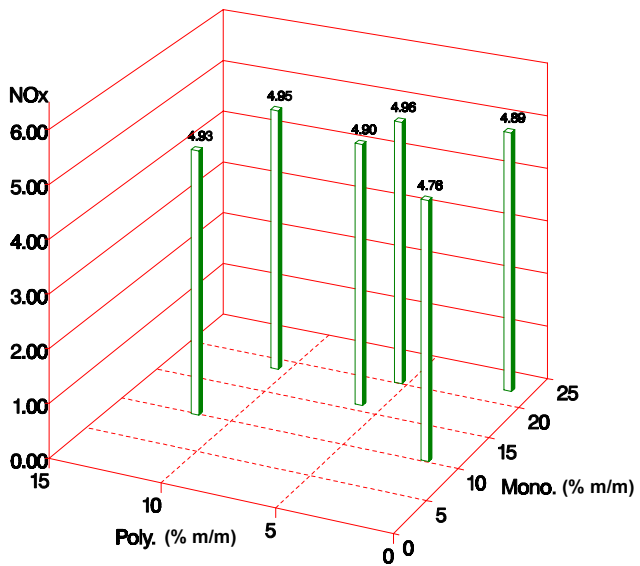
Engine 1 – NOx (g/kWh)



Engine 2 – NOx (g/kWh)

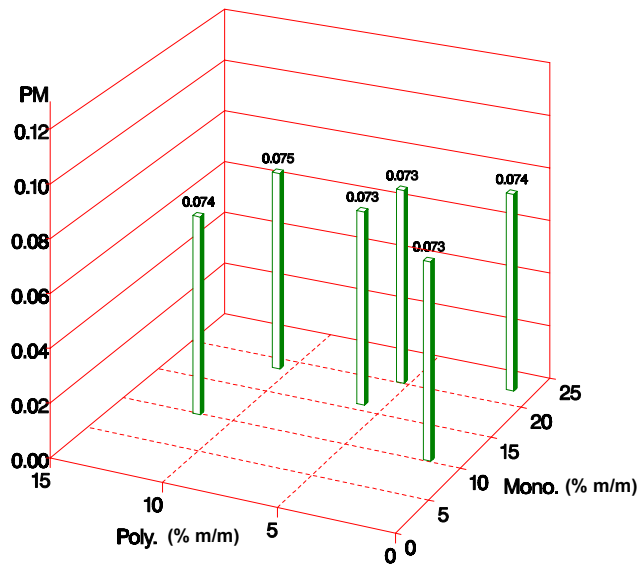


HD fleet average – NOx (g/kWh)

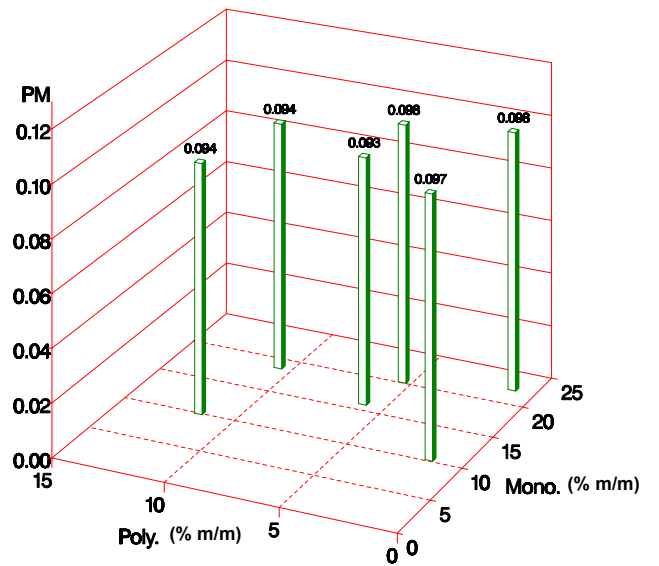




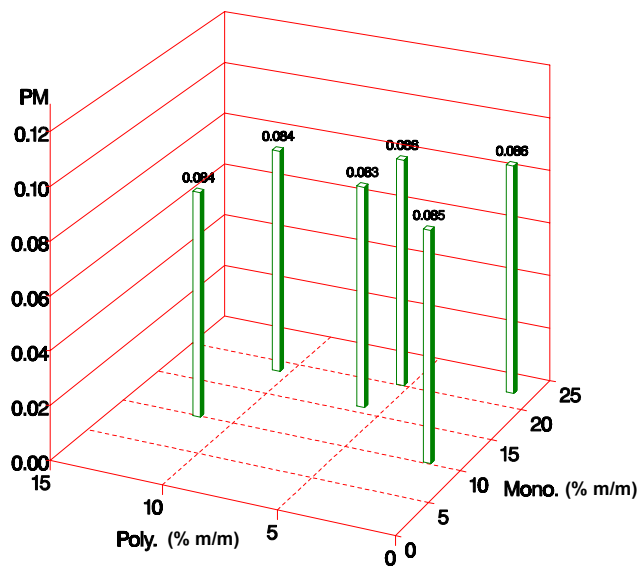
Engine 1 – PM (g/kWh)



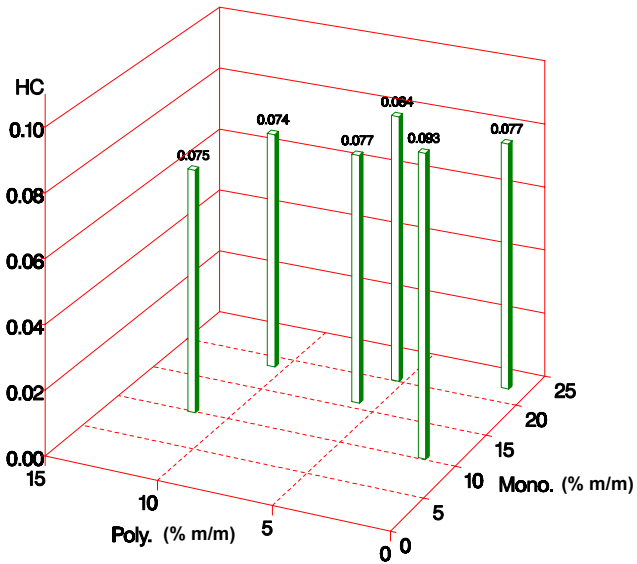
Engine 2 – PM (g/kWh)



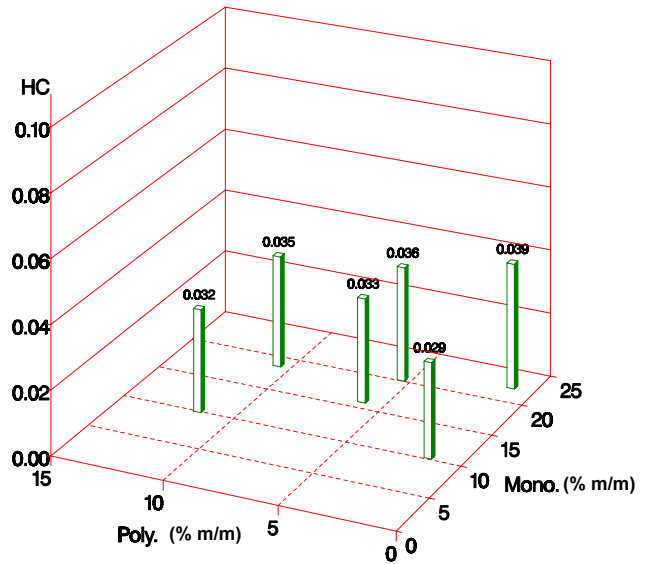
HD fleet average – PM (g/kWh)



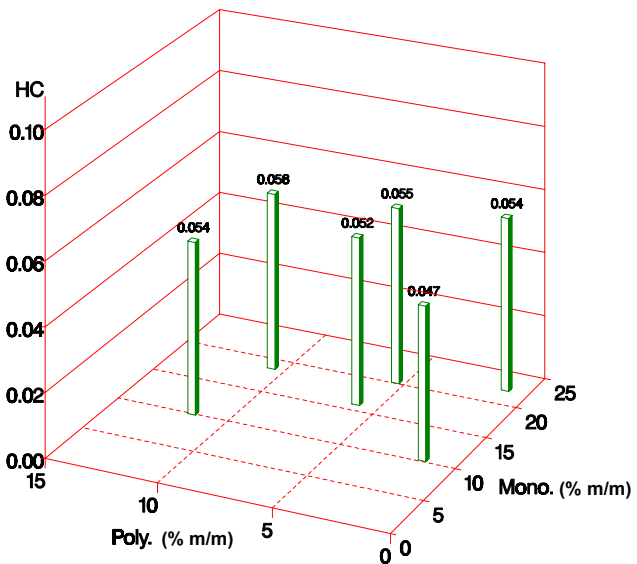
Vehicle A – HC (ECE+EUDC: g/km)



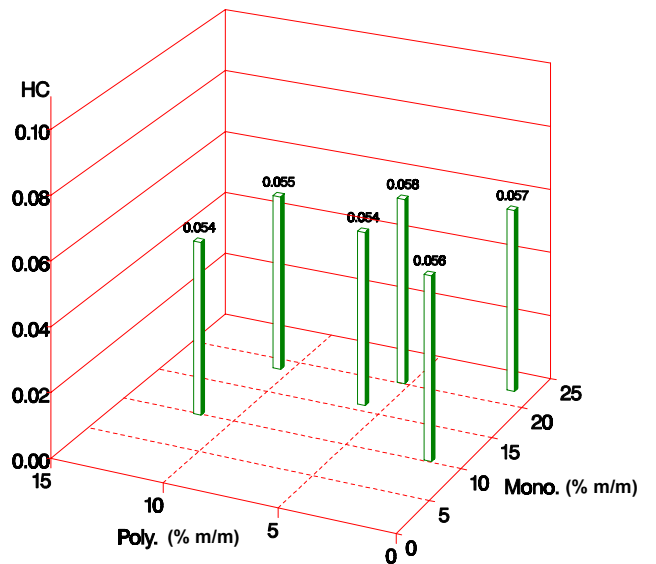
Vehicle B – HC (ECE+EUDC: g/km)



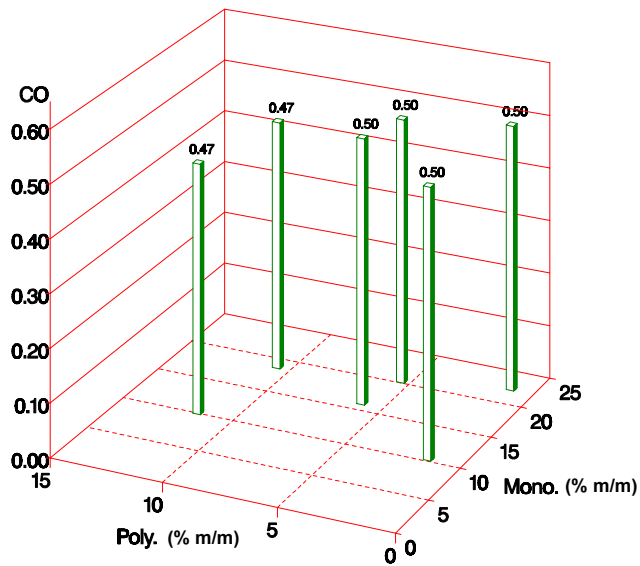
Vehicle C – HC (ECE+EUDC: g/km)



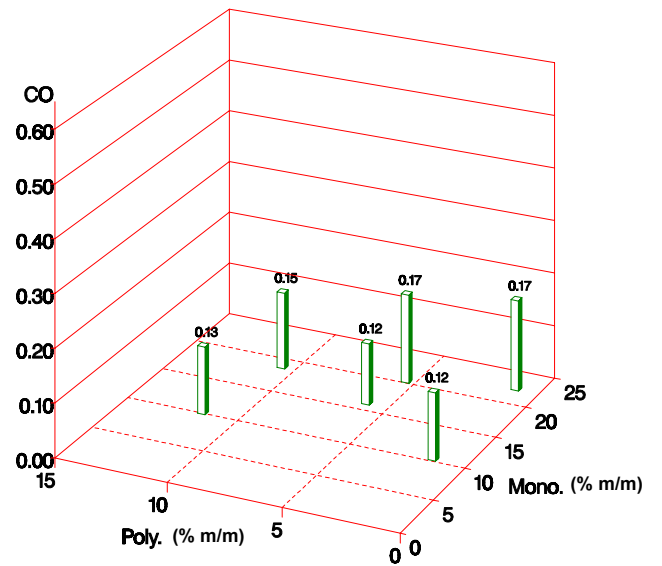
LD fleet average – HC (ECE+EUDC: g/km)



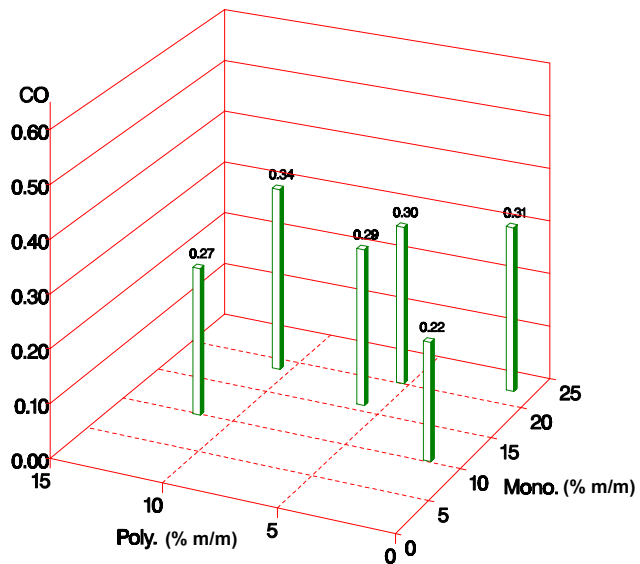
Vehicle A – CO (ECE+EUDC: g/km)



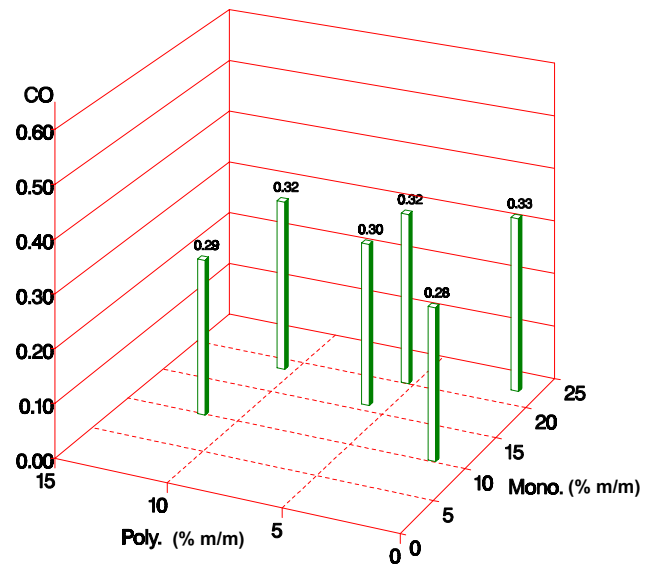
Vehicle B – CO (ECE+EUDC: g/km)



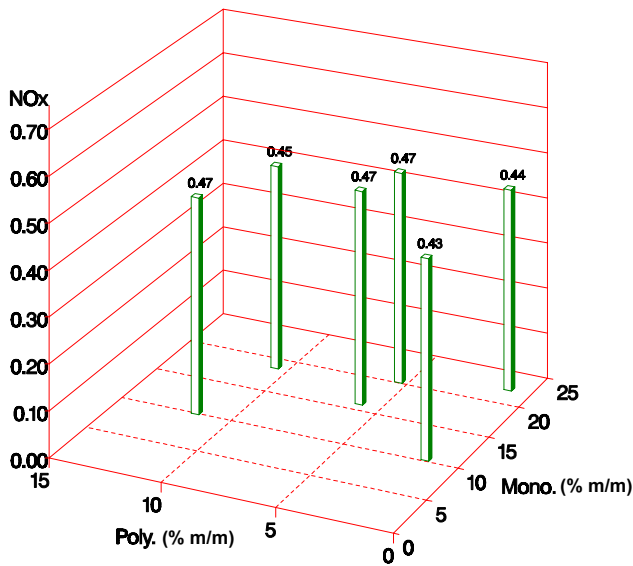
Vehicle C – CO (ECE+EUDC: g/km)



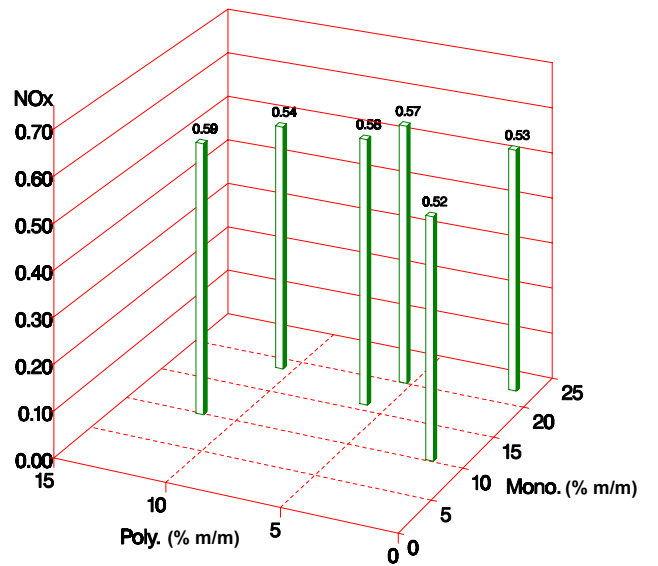
LD fleet average – CO (ECE+EUDC: g/km)



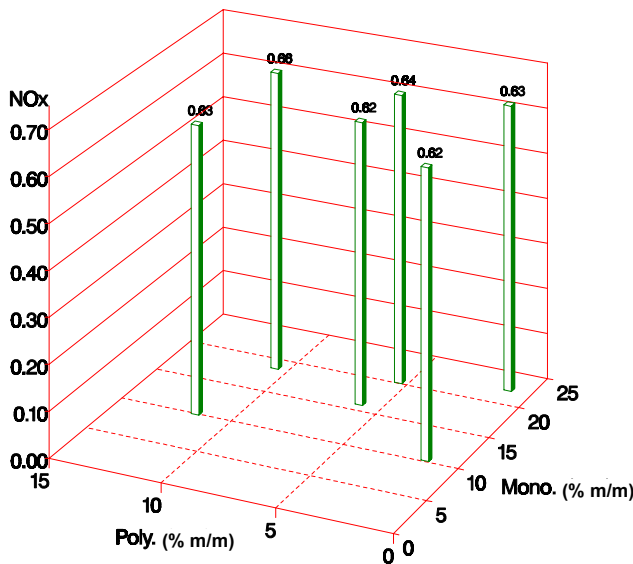
Vehicle A – NOx (ECE+EUDC: g/km)



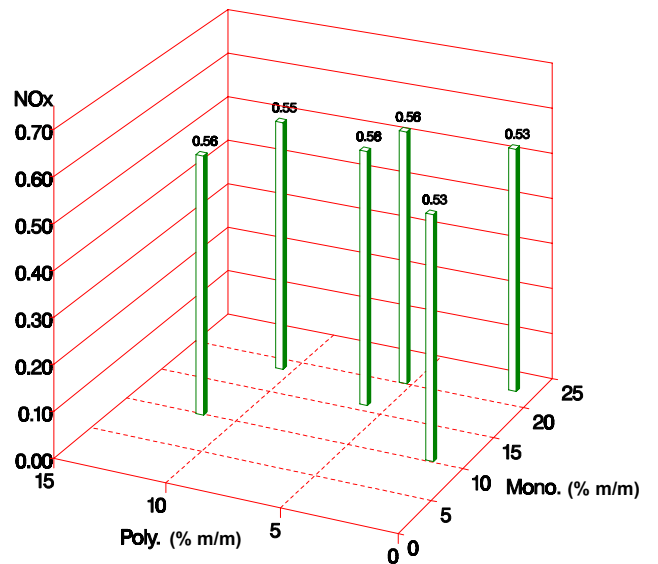
Vehicle B – NOx (ECE+EUDC: g/km)



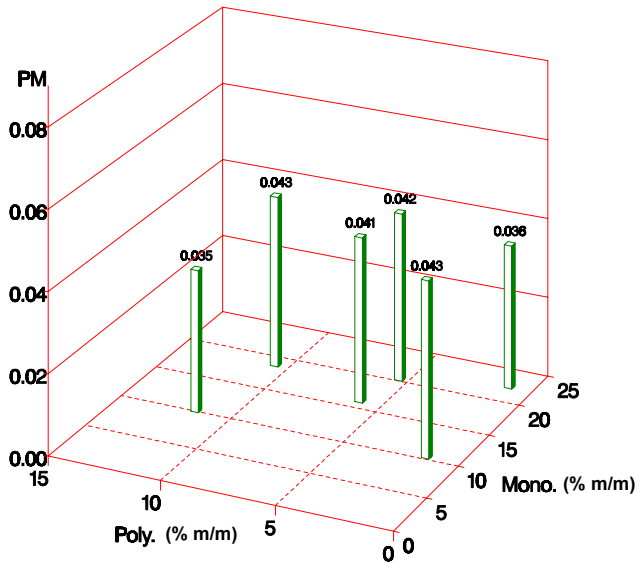
Vehicle C – NOx (ECE+EUDC: g/km)



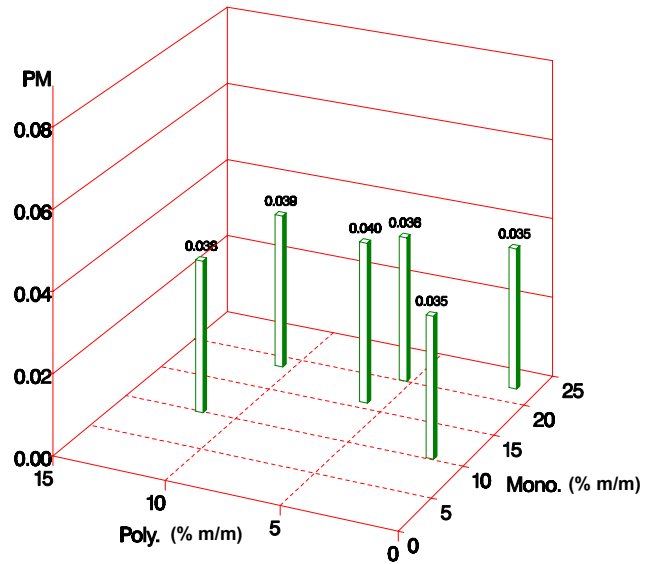
LD fleet average – NOx (ECE+EUDC: g/km)



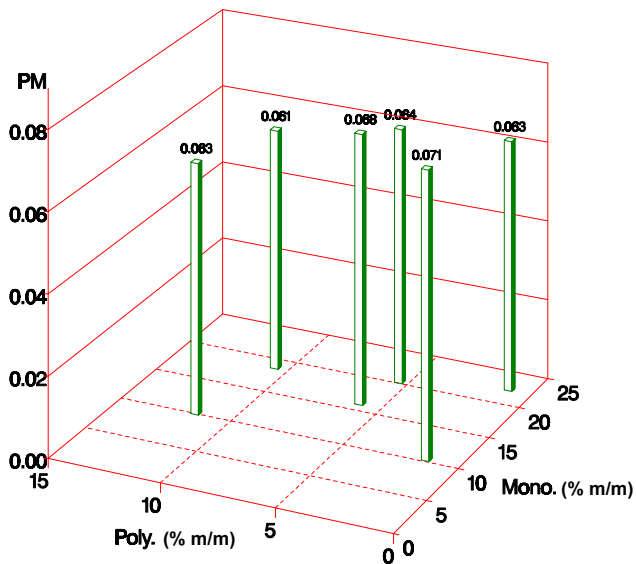
Vehicle A – PM (ECE+EUDC: g/km)



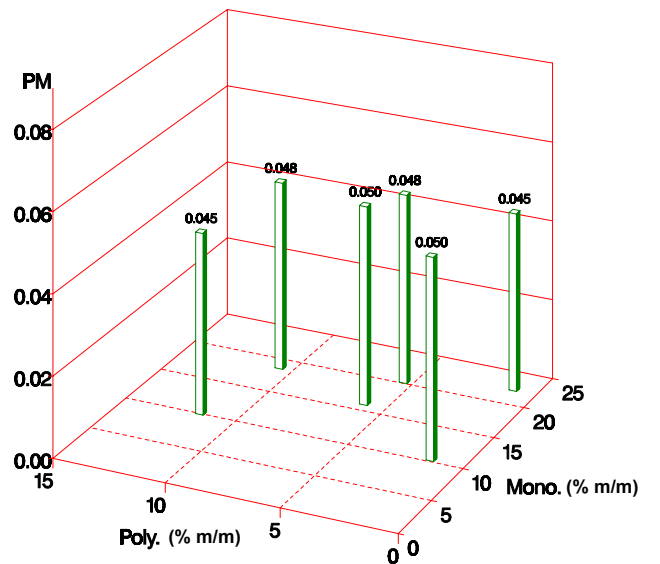
Vehicle B – PM (ECE+EUDC: g/km)



Vehicle C – PM (ECE+EUDC: g/km)



LD fleet average – PM (ECE+EUDC: g/km)



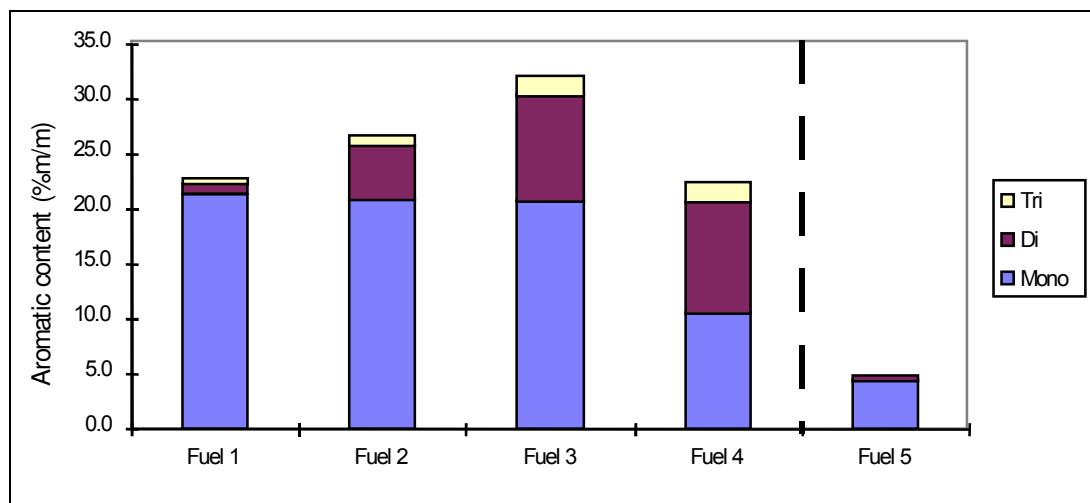
## APPENDIX 14 COMPLEMENTARY TEST PROGRAMMES

This appendix describes supplementary data on a different fuel matrix, with different vehicles, also with the objective of understanding fuel aromatic effects.

A CONCAWE study into the impact of diesel fuel aromatics content on exhaust PAH emissions has recently been carried out [7]. In the course of investigating PAH emissions, regulated emissions were also measured. To provide a comparison for the current study, these results on three Euro-2 cars are reported here to provide a comparison with the current study. In addition, the same set of fuels used for the PAH study was tested in two cars approaching Euro-3 emissions levels, prior to the current study. These tests are also described here.

Four fuels were blended to cover three levels of poly-aromatics and two levels of mono-aromatics. Other influential fuel parameters were successfully held constant. See fuels 1-4 in **Figure A14.1** and **Table A14.1**.

**Figure A14.1** Aromatics content of Diesel test fuels



**Table A14.1** Detailed Test Fuel Properties (Mean Values)

Property	Method of Analysis	Fuel 1	Fuel 2	Fuel 3	Fuel 4	Fuel 5	
		95061/98	95125/98	95039/98	95040/98	95038/98	
		Low P.A.	Medium P.A.	High P.A.	Low M.A.	Sw. Cl. 1	
Density	kg/m <sup>3</sup>	various methods	843.3	843.0	843.2	842.9	815.7
Sulphur	mg/kg	various methods	448	387	380	406	6
KV @ 40°C	cSt	ASTM D445/D446	2.85	2.72	2.65	2.84	2.03
Distillation	°C	ASTM D86					
IBP			174	185	199	208	186
5% recovered at °C			200	208	217	223	201
10% recovered at °C			211	217	223	230	206
20% recovered at °C			231	232	234	241	214
30% recovered at °C			252	249	248	252	222
40% recovered at °C			266	263	261	262	230
50% recovered at °C			276	274	272	270	237
60% recovered at °C			286	283	281	278	244
70% recovered at °C			296	293	290	286	251
80% recovered at °C			309	306	303	298	260
90% recovered at °C			328	325	323	319	272
95% recovered at °C			348	344	343	339	282
FBP			361	358	357	356	295
Total recovered	%		97.8	97.8	97.8	97.9	98.1
Residue	%		1.7	1.8	1.8	1.6	1.5
Loss	%		0.4	0.3	0.3	0.3	0.2
Cetane Number		ASTM D613	50.2	50.5	49.7	49.5	52.9
Cetane Index		ASTM D4737	50.5	50.7	50.9	51.3	52.7
Carbon	%m/m	various methods	85.5	85.8	86.5	85.9	85.0
Hydrogen	%m/m	various methods	13.4	13.3	12.9	13.0	14.0
Calorific Value	MJ/kg	various methods					
Net			42.8	42.8	42.8	42.8	43.2
Gross			45.5	45.5	45.5	45.7	46.2
Aromatics	% m/m	IP 391					
Mono			21.5	21.1	21.0	10.7	4.6
Di			1.1	5.3	10.0	10.4	0.2
Tri +			0.1	1.0	1.9	2.0	0.0
Di + Tri +			1.2	6.3	11.9	12.4	0.2
Total			22.7	27.3	32.9	23.1	4.7

In the first experiment (data generated in the course of the PAH study) three Euro-2 cars were tested, as shown in **Table A14.2**.

**Table A14.2** Vehicle Description, Fleet A

Code	Year	Fuel	Engine (litres)	Comb. System	Aspiration	Fuel Injection / Controls	EGR	Exhaust After-treatment
A1	1993	Diesel	2.5	IDI	Non-turbo	In-line / Mechanical	Yes	Oxidation Cat
A2	1997	Diesel	1.9	DI	Turbo (VG) Intercooler	Distributor / Electronic	Yes	Oxidation Cat (close coupled)
A3	1997	Diesel	1.9	IDI	Non-turbo	Distributor / mechanical	Yes	None

In the second set of tests preparatory to the current study, two cars approaching Euro-3 levels were tested, as shown in **Table A14.3**.

**Table A14.3** Vehicle Description, Fleet B

Vehicle Type	Vehicle B1	Vehicle B2
Displacement (cm <sup>3</sup> )	2151	1896
Max. Power (kW @ rpm)	92 @ 4200	85 @ 4000
Inertia Class (kg)	1340	1440
Cylinder	4	4
Valves per Cylinder	4	2
Max. Torque (Nm @ rpm)	300 @ 1800-2600	285 @ 1900
Compression Ratio	19:1	18:1
Aspiration	TC	TC
Intercooler Y (yes) N (no)	Y	Y
Combustion Type	DI	DI
Injection System	Common Rail	Unit Injector
EGR Y (yes) N (no)	Y	Y
Oxidation Catalyst Y (yes) N (no)	Y (1 close coupled + 1 underfloor)	Y

For the tests on Fleet A, six repeat tests were run on each fuel, using a fully randomised design of six blocks, each with a single test on each fuel. For Fleet B, three tests were performed on each fuel, using a similar fully randomised design.

Mono- and poly-aromatic effects were evaluated by examining the emissions for each of the 5 vehicles tested across the following sub-sets of the fuel matrix:

- Mono-aromatics - fuels 3 and 4
- Poly-aromatics - fuels 1, 2 and 3

**Figure 8, Section 7.4** shows the effects of reducing mono- and poly-aromatics on the HC, CO, NO<sub>x</sub> and PM emissions from each vehicle, expressed as a percentage change relative to the emissions from the high-aromatics fuel 3.