



## **GRUVLOK® STANDARD PRODUCTS**

Price Sheet GL-3-2008 | Effective: March 3, 2008 | Cancels Price Sheet GL-8-2007 of August 20, 2007

### **FREIGHT ALLOWANCE:**

All prices are F.O.B. point of shipment. On shipments weighing 2,500 pounds or more, rail freight or motor freight at the lowest published rate, is allowed to all continental U.S. rail points or all U.S. highway points listed in published tariffs (Alaska and Hawaii excluded). In no case will more than actual freight be allowed.

### **NOTE:**

All orders are accepted on the basis of prices in effect at the time of shipment.

### **NOTICE:**

To the prices and terms quoted, there will be added any manufacturers or sales tax payable on the transaction under any effective statute.

### **GENERAL**

- UPC numbers and SPIN commodity identification numbers are available upon request.
- To obtain current ISO certifications, listings, and other approvals, visit Anvil's Web site at [www.anvilintl.com](http://www.anvilintl.com).
- Pricing is subject to change without notice. Go to Anvil's Web site for the most current list price information, or contact your local Anvil representative.

### **LOSS OR DAMAGE CLAIMS:**

All goods are shipped at buyer's risk. Shipments should be carefully examined upon delivery and before the carrier's delivery receipt is signed. If any loss or damage is evident, the buyer should make an appropriate notation on the delivery receipt and insist that the carrier's driver initial such exception. The contents of all packages should be carefully examined for concealed damage as soon as possible after delivery, so that the carrier can be requested, within 48 hours after delivery, to arrange for prompt inspection of the damaged goods.

### **REVISIONS:**

**Page 30, Fig 7084: 2½" Painted: \$198.50 and 2½" Galvanized: \$325.00**

**EASTERN REGION**  
800-451-2935

**NORTHERN REGION**  
800-301-2701

**SOUTHERN REGION**  
800-451-4414

**WESTERN REGION**  
800-572-0051

## 1. CONTROLLING PROVISIONS:

These terms and conditions shall control with respect to any purchase order or sale of Seller's products. No waiver, alteration or modification of these terms and conditions whether on Buyer's purchase order or otherwise shall be valid unless the waiver, alteration or modification is specifically accepted in writing and signed by an authorized representative of Seller.

## 2. DELIVERY:

Seller will make every effort to complete delivery of products as indicated on Seller's acceptance of an order, but Seller assumes no responsibility or liability, and will accept no backcharge, for loss or damage due to delay or inability to deliver caused by acts of God, war, labor difficulties, accident, delays of carriers, by contractors or suppliers, inability to obtain materials, shortages of fuel and energy, or any other causes of any kind whatever beyond the control of Seller. Seller may terminate any contract of sale of its products without liability of any nature, by written notice to Buyer, in the event that the delay in delivery or performance resulting from any of the aforesaid causes shall continue for a period of sixty (60) days. Under no circumstances shall Seller be liable for any special or consequential damages or for loss, damage, or expense (whether or not based on negligence) directly or indirectly arising from delays or failure to give notice of delay.

## 3. WARRANTY:

Seller warrants for one year from the date of shipment Seller's manufactured products to the extent that Seller will replace those having defects in material or workmanship when used for the purpose and in the manner which Seller recommends. If Seller examination shall disclose to its satisfaction that the products are defective, and an adjustment is required, the amount of such adjustment shall not exceed the net sales price of the defective products only and no allowance will be made for labor or expense of repairing or replacing defective products or workmanship of damage resulting from the same. Seller warrants the products which it sells of other manufacturers to the extent of the warranties of their respective makers. Where engineering design or fabrication work is supplied. Buyer's acceptance of Seller's design or of delivery of work shall relieve Seller of all further obligation, other than expressed in Seller's product warranty. THIS IS SELLER'S SOLE WARRANTY. SELLER MAKES NO OTHER WARRANTY OF ANY KIND, EXPRESSED OR IMPLIED AND ALL IMPLIED WARRANTIES OF MERCHANTABILITY AND FOR A PARTICULAR PURPOSE WHICH EXCEED SELLER'S AFORESTATED OBLIGATION ARE HEREBY DISCLAIMED BY SELLER AND EXCLUDED FROM THIS WARRANTY. Seller neither assumes, nor authorizes any person to assume for it, any other obligation in connection with the sale of its engineering designs or products. This warranty shall not apply to any products or parts of products which (a) have been repaired or altered outside of Seller's factory, in any manner; (b) have been subjected to misuse, negligence or accidents; (c) have been used in a manner contrary to Seller's instructions or recommendations. Seller shall not be responsible for design errors due to inaccurate or incomplete information supplied by Buyer or its representatives.

## 4. SELLER'S LIABILITY:

Seller will not be liable for any loss, damage, cost of repairs, incidental or consequential damages of any kind, whether based upon warranty (except for the obligation accepted by Seller under "Warranty" above), contract or negligence, arising in connection with the design, manufacture, sale, use or repair of the products or of the engineering designs supplied to Buyer.

## 5. RETURNS:

Seller cannot accept return of any products unless its written permission has been first obtained, in which case same will be credited subject to the following (a) All material returned must, on its arrival at Seller's Plant, be found to be in first-class condition; if not, cost of putting in saleable condition will be deducted from credit memoranda; (b) A handling charge deduction of twenty percent (20%) will be made from all credit memoranda issued for material returned; (c) Transportation charges, if not prepaid will be deducted from credit memoranda.

## 6. SHIPMENTS:

All products sent out will be carefully examined, counted and packed. The cost of any special packing or special handling caused by Buyer's requirements or requests shall be added to the amount of the order. No claim for shortages will be allowed unless made in writing within ten (10) days of receipt of a shipment.

Claims for products damaged or lost in transit should be made on the carrier, as Seller's responsibility ceases, and title passes, on delivery to the carrier.

## 7. SPECIAL PRODUCTS:

Orders covering special or nonstandard products are not subject to cancellation except on such terms as Seller may specify on application.

## 8. PRICES AND DESIGNS:

Prices and designs are subject to change without notice. All prices are F.O.B. Point of shipment, unless otherwise stated.

## 9. TAXES:

The amount of any sales, excise or other taxes, if any, applicable to the products covered by this order, shall be paid by Buyer unless Buyer provides Seller with an exemption certificate acceptance to the taxing authorities.

## 10. NUCLEAR PLANTS:

Where the products, engineering design or fabrication is for nuclear plant applications. Buyer agrees (a) to take all necessary steps to add Seller as an insured under the American Nuclear Insurers' (ANI) pool and under the Mutual Atomic Energy Reinsurance Pool (MAERP) for property damage and liability insurance and if necessary steps could have been taken, but are not taken, Buyer shall hold Seller harmless against all such losses which could have been thus covered (b) Buyer agrees to hold Seller harmless with respect to any personal injury (or death), property damage or other loss in a nuclear incident which is caused directly or indirectly by defective design, material, workmanship furnished by Buyer (or which could be so covered but with respect to which Buyer has elected to self-insure), and further agrees to waive subrogation by its carriers of such insurance against Seller, and (c) as to nuclear hazards for which Buyer cannot obtain insurance coverage, the liability of Seller for any personal injury (or death), property damage or other loss directly caused by defective design, material, or workmanship furnished by Seller shall not exceed the value at the time of the loss occurrence.

## 11. MINIMUM INVOICE:

Domestic: \$100 plus transportation.  
International: \$500 plus transportation.

## 12. TERMS:

Cash, net 30 days unless otherwise specified.

NOTE: All orders are accepted on the basis of prices in effect at the time of shipment.

NOTICE: The prices and terms quoted, there will be added any manufacturers or sales tax payable on the transaction under any effective statute.

FREIGHT ALLOWANCE: All prices are F.O.B. point of shipment. On shipments weighing 2,500 pounds or more, rail freight or motor freight at the lowest published rate, is allowed to all continental U.S. rail points or all U.S. highway points listed in published tariffs (Alaska and Hawaii excluded). In no case will more than actual freight be allowed. Shipments (weighing less than 2,500 pounds) will be shipped prepaid. The buyer will be invoiced for freight costs at the applicable published class, exception or commodity rate(s) or charge(s). Anvil reserves the right to select the carrier for all shipments.

Your order must specify gasket grade

## Standard Gaskets

GRADE	TEMPERATURE RANGE	COMPOUND	COLOR CODE	*GENERAL SERVICE APPLICATION
E	-40°F to +230°F	EPDM	Green	Water, dilute acids, alkalis, salts, and many chemical services not involving hydrocarbons, oils, or gases. Excellent oxidation resistance. NOT FOR USE WITH HYDROCARBONS.
T	-20°F to +180°F	Nitrile (Buna-N)	Orange	Petroleum products, vegetable oils, mineral oils, and air contaminated with petroleum oils. NOT FOR USE IN HOT WATER SERVICES.

## Special Gaskets

GRADE	TEMPERATURE RANGE	COMPOUND	COLOR CODE	*GENERAL SERVICE APPLICATION
O	-20°F to +300°F	Fluoro Elastomer	Blue	High-temperature resistance to oxidizing acids, petroleum oils, hydraulic fluids, halogenated hydrocarbons, and lubricants.
L	-40°F to +350°F	Silicone	Red Gasket	Dry, hot air, and some high-temperature chemical services.
E (type A)	-40°F to +150°F		Violet	Wet and Dry (oil-free air) pipe fire protection sprinkler systems. For dry pipe systems, Gruvlok Xtreme™ Lubricant is required.

\*Contact Anvil for specific service recommendations. **Specify gasket grade when ordering.**  
Use Gruvlok lubricant on gaskets. Check gasket color code to be certain it is recommended for the service intended.  
Additional gasket compounds and configurations are available — contact an Anvil Representative.

LUBRICANTS	
STANDARD LUBRICANT	PRICE
4 1/2 oz. Tube	\$23.74/tube
Carton (w/12 Packs, 144 Tubes)	\$2,818.54/carton
1 Quart Can	\$121.85/can
5 Gallon Pail	\$1,029.72
QUICK DRY LUBRICANT	
1 Pint Can	\$92.87
1 Quart Can	\$130.64
1 Gallon Pail	\$221.50
XTREME LUBRICANT (SILICONE)	
10 oz. Tube (1 each)	\$60.37
2.2 lb. Tub (Gruvlok Lubricant)	\$212.53

STANDARD LUBRICANT USAGE GUIDE		
SIZE OF GASKET	NUMBER OF GASKETS	
	PERTUBE	PER QUART
2"	55	400
3"	45	300
4"	25	200
6"	20	130
8"	15	100
10"	10	85
12"	9	60
14"	7	50
16"	6	40
18"	5	35
20"	4	30
24"	3	20

XTREME LUBRICANT USAGE GUIDE	
SIZE OF GASKET	NUMBER OF GASKETS PER QUART
2"	1,200
3"	900
4"	600
6"	390
8"	300
10"	255
12"	180
14"	150
16"	120
18"	105
20"	90
24"	60

# Table of Contents

<b>Terms and Conditions</b> .....	<b>2</b>
<b>Gasket Selection</b> .....	<b>3</b>
Standard Gaskets.....	3
Special Gaskets.....	3
Lubricants .....	3
<b>Grooved-End Couplings</b> .....	<b>6-11</b>
Standard Coupling Fig. 7001 .....	6
Standard Coupling Fig. 7011 .....	6
Lightweight Flexible Coupling Fig. 7000 .....	7
Hingelok Coupling Fig. 7003 .....	7
Rigidlok™ Rigid Coupling Fig. 7401 .....	8
Reducing Coupling Fig. 7010 .....	8
Rigidlite® 300 PSI Coupling Fig. 7400.....	8
Outlet Couplings Fig. i7042F, i7042M and i7042G .....	9
Flange Adapter for HDPE Pipe Fig. 7312.....	10
HDPE Transition Coupling Fig. 7307 .....	10
HDPE Coupling Fig. 7305 .....	10
HPR Coupling Fig. 7004 HPR.....	10
End Guard Coupling Fig. 7004 EG.....	10
Gruvlok Flange Fig. 7012.....	11
Gruvlok 300# Flange Fig. 7013.....	11
<b>Fittings for Grooved-End Pipe</b> .....	<b>12-21</b>
90° Elbows Fig. 7050 .....	12
22Z\X° Elbows Fig. 7052.....	12
45° Elbows Fig. 7051 .....	12
11Z\V° Elbows Fig. 7053 .....	12
Tees Fig. 7060 .....	13
Tees with Threaded Branch Fig. 7063 .....	13
Reducing Tee Fig. 7061 .....	14
Reducing Tee with Threaded Branch Fig. 7064.....	15
Concentric Reducer Fig. 7072.....	16
Reducer Threaded Small End Fig. 7076 .....	17
Cap Fig. 7074 .....	17
Hose Nipple Fig. 7086.....	17
Eccentric Reducer Fig. 7073 & Fig. 7097 .....	18
90° Long Radius Elbows Fig. 7050LR (1Z\X"D).....	19
Reducing Base Support Elbows Fig. 7050RF Grooved x Flanged (GxF) .....	19
45° Long Radius Elbows Fig. 7051 LR (1Z\X"D) .....	19
Female Thread Adapter Fig. 7087.....	19
Bullhead Plug Fig.7075 .....	20
Lateral Fig. 7069.....	20
Tee WYE Fig. 7066.....	20
Steel Cross Fig. 7068 and True Y Fig. 7071 .....	21
Reducing Lateral – Fig. 7070.....	21
<b>Valves and Accessories</b> .....	<b>22-30</b>
Grooved-End Butterfly Valve Series 7700 .....	22
Gruvlok Butterfly Valves Fig. 8000GR .....	23
Gruvlok Ball Valves Fig. 7500 .....	23
Bronze Grooved-End Ball Valve Fig. 7500B .....	24
Grooved End Butterfly Valve Series 7600.....	24
Gruvlok Circuit Balancing Valves Sweat Four Turn Fig. GBV-S.....	24
Threaded Four Turn Fig. GBV-T.....	24
Grooved End Straight GBV-G & End Angle Fig. GBV-A.....	25
End Check Valve Fig. 7800 .....	25

# Table of Contents (continued)

Silent Check Valve Fig. 400G.....	25
Suction Diffuser Fig. 7250 .....	26
SF21-GG Grooved x Grooved Connectors .....	26
SF21-GF Grooved x Flange Connectors.....	26
SF21-FF Flange x Flange Connectors.....	26
Gruvlok Air Vent GAV-15 & GAV-30.....	27
Grooved-End "WYE" Strainer Fig. 768G .....	27
Grooved-End Strainer Fig. 7260.....	27
Fig. FTV-S (Straight) or Fig. FTV-A (Angle Body) .....	27
Clamp-T® Grooved Outlet Fig. 7046 .....	28
Clamp-T® Female Threaded Outlet Fig. 7045.....	28
Clamp-T® Cross Fig. 7047, Fig. 7048 and Fig. 7049 .....	29
Adapter Flanges Fig. 7084 (150 lb.) & Fig. 7085 (300 lb.) .....	30

## **Spare Parts .....30-32**

Flange Parts for Fig. 7012 & 7013 Gruvlok Flanges .....	30
Flange Gaskets for Fig. 7012 & 7013 Gruvlok Flanges.....	31
Standard Gaskets for Fig. 7005 & 7305 Couplings.....	31
Plated Trackhead Bolts and Nuts .....	31
Standard Gaskets.....	31
Gaskets for Fig. 7004 EG .....	31
Reducing Coupling Fig. 7010 (Gasket Only) .....	31
Clamp-T® Grooved Outlet Fig. 7046 (Gasket Only) .....	32
Clamp-T® Female Threaded Outlet Fig. 7045 (Gasket Only) .....	32

## **Plain-End.....32**

Plain-End Coupling Roughneck™ Coupling Fig. 7005 .....	32
--	----

## **Gruvlok Advanced Copper System .....33-35**

Rigidlite® 300 PSI Coupling Fig. 7400.....	33
Gruvlok Flange Fig. 7012.....	33
90° Elbows Fig. 7550 .....	33
45° Elbows Fig. 7551 .....	33
Tee Fig. 7560 .....	33
Copper Reducing Tee Fig. 7561A.....	34
Copper Reducing Tee Fig. 7564A (Gr. x Gr. x Cup) .....	34
Concentric Reducers Fig. 7572 (Gr. x Gr.).....	34
Cap Fig. 7574 .....	34
Reducing Adapters Fig. 7575 (Gr. x Cup) .....	35
Transition Fitting, Fig. 7582 (Cup x Gr.).....	35
DI-LOK® DI-Electric Nipple Fig. 7088 (Gr. x Th.) .....	35
DI-LOK® DI-Electric Nipple Fig. 7089 (Gr. x Gr.).....	35
DI-LOK® DI-Electric Nipple Fig. 7090 (Th. x Th.) .....	36
Bronze Grooved-End Ball Valve Fig. 7500B .....	36

## **Roll Groovers.....37**

Model 1007/3007 Roll Groover.....	37
Model 3006 (Steel Roll Groover) – For Ridgid® 300 Power Drive .....	37
Model 3006C (Copper Roll Groover) – For Ridgid® 300 Power Drive .....	37

## **Expansion Joints for Grooved-End Pipe.....38**

Gruvlok Fig. 7240 Expansion Joint.....	38
--	----

## **Cross Reference .....39-40**

## **Numerical Index.....41**

# Couplings for Grooved-End Pipe

## Standard Coupling Fig. 7001



For listing/approval details contact your Gruvlok Representative.

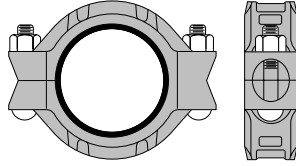

Sizes 1"-14"

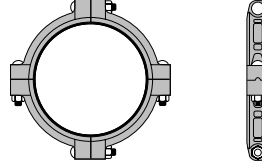

Sizes 16"-24"

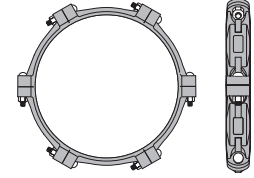

Sizes 28" and 30"

NOMINAL PIPE SIZE (INCHES)	PIPE OUTSIDE DIAMETER (INCHES)	APRX. WEIGHT EACH (LBS)	COUPLING COMPLETE WITH "E" OR "T" GASKET (PRICE EACH)		COUPLING COMPLETE WITH FLUSH GAP™ "E" OR "T" GASKET (PRICE EACH)		BOX QTY.	SPARE PARTS PLATED BOLT & NUT	
			PAINTED	GALV.	PAINTED	GALV.		QTY. NO.	SIZE (INCHES)
1	1.315	1.30	\$23.40	\$31.70	\$37.63	\$46.21	-	2	3/8 x 2 1/4
1 1/4	1.660	1.40	\$31.10	\$42.08	\$46.21	\$57.77	-	2	3/8 x 2 1/4
1 1/2	1.900	1.50	\$33.78	\$45.04	\$48.30	\$60.44	-	2	3/8 x 2 1/4
2	2.375	3.10	\$36.15	\$48.30	\$50.66	\$63.99	-	2	1/2 x 3
2 1/2	2.875	3.70	\$42.66	\$59.54	\$62.22	\$79.40	-	2	1/2 x 3
3	3.500	4.30	\$47.11	\$66.06	\$64.28	\$83.84	-	2	1/2 x 3
3 1/2	4.000	5.10	\$68.73	\$97.47	\$93.03	\$122.95	-	2	5/8 x 3 1/2
4	4.500	6.80	\$69.33	\$97.47	\$93.32	\$122.95	-	2	5/8 x 3 1/2
5	5.563	9.60	\$104.88	\$151.09	\$164.72	\$214.20	-	2	3/4 x 4 1/2
6	6.625	11.80	\$124.14	\$178.35	\$162.05	\$239.67	-	2	3/4 x 4 1/2
8	8.625	21.70	\$201.74	\$301.29	\$247.08	\$339.22	-	2	7/8 x 5 1/2
10	10.750	27.00	\$334.48	\$480.23	\$396.99	\$534.74	-	2	7/8 x 5 1/2
12	12.750	35.00	\$380.99	\$545.71	\$466.91	\$614.74	-	2	7/8 x 6
14	14.000	37.00	\$462.46	\$638.73	\$516.96	\$684.66	-	4	7/8 x 5 1/2
16	16.000	50.00	\$606.44	\$823.31	\$681.39	\$902.10	-	4	1 x 4
18	18.000	72.00	\$710.43	\$985.36	\$800.50	\$1,080.45	-	4	1 x 4
20	20.000	82.00	\$1,117.20	\$1,504.99	\$1,273.67	\$1,749.10	-	4	1 1/8 x 4 1/2
24	24.000	90.00	\$1,225.02	\$1,645.71	\$1,414.03	\$1,844.80	-	4	1 1/8 x 4 1/2
28	28.875	105.00	\$1,325.07	POA	POA	POA	-	6	1 x 5 1/2
30	31.000	137.00	\$1,390.46	POA	POA	POA	-	6	1 x 5 1/2

All bolts are oval-neck track head design to ASTM A-183, with heavy hex nuts to ASTM A-563, and are zinc plated to ASTM B-633.

Number of bolts equals housing segments.

Weights are approximate and subject to change.

Grade "O" or "L" gaskets are available. Contact your Anvil representative for more details.

## Standard Coupling Fig. 7011

†When ordering, refer to product as FP7400.

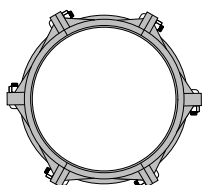

NOMINAL PIPE SIZE (INCHES)	PIPE OUTSIDE DIAMETER (INCHES)	APRX. WEIGHT EACH (LBS)	COUPLING COMPLETE WITH "E" EPDM GASKET (PRICE EACH) PAINTED	SPARE PARTS PLATED BOLT & NUT	
				QTY. NO.	SIZE (INCHES)
30 O.D.	30.000	200.00	\$1,637.71	6	1 1/4 x 4 3/8

Working pressure and end load values are for standard wall pipe.

## Lightweight Flexible Coupling Fig. 7000

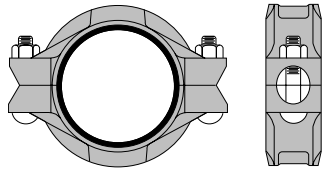

NOMINAL PIPE SIZE (INCHES)	PIPE OUTSIDE DIAMETER (INCHES)	APRX. WEIGHT EACH (LBS)	COUPLING COMPLETE WITH "E" OR "T" GASKET (PRICE EACH)		COUPLING COMPLETE WITH FLUSH GAP™ "E" OR "T" GASKET (PRICE EACH)		BOX QTY.	SPARE PARTS PLATED BOLT & NUT SIZE (INCHES)
			PAINTED	GALVANIZED	PAINTED	GALVANIZED		
1	1.315	1.30	\$23.71	\$29.92	\$38.52	\$45.63	-	3/8 x 2 1/4
1 1/4	1.660	1.40	\$24.59	\$31.70	\$40.29	\$48.59	-	3/8 x 2 1/4
1 1/2	1.900	1.50	\$29.92	\$37.63	\$44.73	\$53.33	-	3/8 x 2 1/4
2	2.375	3.10	\$30.52	\$38.52	\$45.92	\$54.51	-	3/8 x 2 1/4
2 1/2	2.875	2.30	\$35.26	\$44.73	\$44.73	\$64.89	-	3/8 x 2 1/4
3	3.500	2.90	\$40.89	\$51.85	\$58.07	\$70.21	-	1/2 x 2 3/4
3 1/2	4.000	3.10	\$57.48	\$75.25	\$83.25	\$101.91	-	1/2 x 3
4	4.500	4.60	\$57.48	\$75.25	\$83.25	\$101.91	-	1/2 x 3
5	5.563	6.10	\$82.95	\$82.95	\$142.80	\$170.94	-	5/8 x 3 1/2
6	6.625	8.10	\$99.54	\$130.06	\$161.17	\$199.68	-	5/8 x 3 1/2
8	8.625	14.20	\$156.14	\$208.57	\$203.83	\$258.93	-	3/4 x 4 1/2

All bolts are oval-neck track head design to ASTM A-183, with heavy hex nuts to ASTM A-563, and are zinc plated to ASTM B-633.  
Number of bolts equals housing segments.  
Weights are approximate and subject to change.  
Grade "O" or "L" gaskets are available. Contact your Anvil representative for more details.

## Hingelok Coupling Fig. 7003

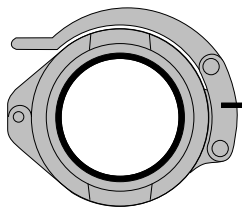

NOMINAL PIPE SIZE (INCHES)	PIPE OUTSIDE DIAMETER (INCHES)	APRX. WEIGHT EACH (LBS)	COUPLING COMPLETE WITH "E" OR "T" GASKET (PRICE EACH)		COUPLING COMPLETE WITH FLUSH GAP™ "E" OR "T" GASKET (PRICE EACH)		BOX QTY.
			PAINTED	GALV.	PAINTED	GALV.	
1 1/2	1.900	1.70	\$65.18	\$77.92	\$68.44	\$81.48	-
2	2.375	2.20	\$62.51	\$68.15	\$65.77	\$77.92	-
2 1/2	2.875	3.20	\$68.73	\$82.66	\$85.03	\$101.91	-
3	3.500	3.60	\$80.29	\$99.54	\$96.88	\$118.21	-
4	4.500	5.10	\$103.39	\$133.33	\$127.69	\$159.08	-
5	5.563	9.50	\$211.83	\$259.82	\$261.60	\$319.96	-
6	6.625	11.20	\$222.20	\$280.85	\$277.89	\$339.22	-
8	8.625	18.10	\$341.29	\$427.80	\$386.62	\$476.98	-

Contact Anvil for specific service recommendations. Specify gasket grade when ordering.  
Use Gruzlok lubricant on gaskets. Check gasket color code to be certain it is recommended for the service intended.

**Rigidlok™ Rigid Coupling Fig. 7401**



For listing/approval details contact your Gruvlok Representative.

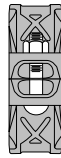
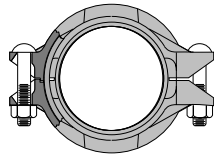

Sizes 1 1/2"-12"

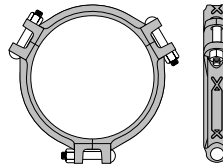

Sizes 14"-18"

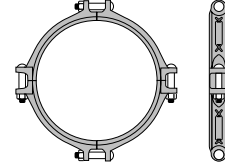

Sizes 20"-24"

NOMINAL PIPE SIZE (INCHES)	PIPE OUTSIDE DIAMETER (INCHES)	APRX. WEIGHT EACH (LBS)	COUPLING COMPLETE WITH "E" OR "T" GASKET (PRICE EACH)		COUPLING COMPLETE WITH FLUSH GAP™ "E" OR "T" GASKET (PRICE EACH)		BOX QTY.	SPARE PARTS PLATED BOLT & NUT	
			PAINTED	GALV.	PAINTED	GALV.		QTY. NO.	SIZE (INCHES)
1 1/2	1.900	1.80	\$32.59	\$40.89	\$46.82	\$55.99	-	2	3/8 x 2 1/4
2	2.375	2.40	\$33.18	\$42.95	\$48.00	\$58.07	-	2	3/8 x 2 1/2
2 1/2	2.875	2.90	\$38.21	\$49.47	\$58.67	\$69.02	-	2	3/8 x 2 3/4
3	3.500	3.60	\$44.73	\$58.07	\$61.62	\$76.14	-	2	1/2 x 3
4	4.500	5.00	\$63.41	\$82.36	\$87.70	\$107.84	-	2	1/2 x 3
5	5.563	6.90	\$81.77	\$107.25	\$138.65	\$245.59	-	2	5/8 x 3 1/2
6	6.625	7.90	\$109.32	\$141.91	\$164.43	\$200.87	-	2	5/8 x 3 1/2
8	8.625	15.90	\$171.83	\$223.97	\$217.16	\$271.97	-	2	3/4 x 4 1/2
10	10.750	25.60	\$307.22	\$410.62	\$369.44	\$470.46	-	2	1 x 6
12	12.750	30.50	\$343.36	\$460.68	\$420.68	\$541.56	-	2	7/8 x 6
14	14.000	36.10	\$448.53	\$575.63	\$509.27	\$575.63	-	2	7/8 x 5 1/2
16	16.000	40.80	\$584.82	\$746.28	\$668.71	\$746.28	-	3	7/8 x 5 1/2
18	18.000	51.60	\$676.07	\$875.74	\$780.52	\$875.74	-	4	1 x 4
20	20.000	68.30	\$804.63	\$1,052.02	\$956.98	\$1,052.02	-	4	1 x 4
24	24.000	89.30	\$1,185.03	\$1,501.14	\$1,393.01	\$1,501.14	-	4	1 x 4

All bolts are oval-neck track head design to ASTM A-183, with heavy hex nuts to ASTM A-563, and are zinc plated to ASTM B-633. Number of bolts equals housing segments. Weights are approximate and subject to change. Contact Anvil for specific service recommendations. Specify gasket grade when ordering. Use Gruvlok lubricant on gaskets. Check gasket color code to be certain it is recommended for the service intended.

**Rigidlite® 300 PSI Coupling Fig. 7400**

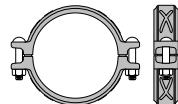

NOMINAL PIPE SIZE (INCHES)	PIPE OUTSIDE DIAMETER (INCHES)	APRX. WEIGHT EACH (LBS)	COUPLING COMPLETE WITH "E" OR "T" GASKET (PRICE EACH)		BOX QTY.	PLATED BOLT & NUT SIZE (INCHES)
			PAINTED	GALV.		
1	1.315	1.20	\$22.52	\$29.10	-	3/8 x 2 1/4
1 1/4	1.660	1.30	\$23.28	\$32.53	-	3/8 x 2 1/4
1 1/2	1.900	1.40	\$25.73	\$38.58	-	3/8 x 2 1/4
2	2.375	1.60	\$28.57	\$33.78	-	3/8 x 2 1/4
2 1/2	2.875	1.90	\$32.41	\$39.29	-	3/8 x 2 1/4
3	3.500	2.10	\$37.27	\$45.87	-	3/8 x 2 3/4
4	4.500	3.10	\$52.67	\$64.70	-	3/8 x 2 3/4
5	5.563	4.60	\$77.32	\$93.80	-	1/2 x 3
6	6.625	5.50	\$94.56	\$113.41	-	1/2 x 3
8	8.625	8.40	\$148.42	\$176.99	-	1/2 x 3

All bolts are oval-neck track head design to ASTM A-183, with heavy hex nuts to ASTM A-563, and are zinc plated to ASTM B-633. Contact Anvil for specific service recommendations. Specify gasket grade when ordering. Use Gruvlok lubricant on gaskets. Check gasket color code to be certain it is recommended for the service intended.

**Reducing Coupling Fig. 7010**

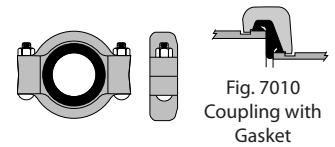

NOMINAL PIPE SIZE (INCHES)	APRX. WEIGHT EACH (LBS)	COUPLING COMPLETE WITH "E" OR "T" GASKET (PRICE EACH)		BOX QTY.	PLATED BOLT & NUT SIZE (INCHES)
		PAINTED	GALV.		
2 x 1 1/2	2.00	\$50.95	\$61.92	-	1/2 x 2 3/4
2 1/2 x 2	3.50	\$66.66	\$83.84	-	1/2 x 2 3/4
3 x 2	4.40	\$76.14	\$96.58	-	1/2 x 2 3/4
3 x 2 1/2	4.10	\$65.47	\$83.84	-	1/2 x 2 3/4
4 x 2	8.90	\$120.87	\$153.17	-	5/8 x 3 1/2
4 x 2 1/2	7.90	\$108.43	\$143.10	-	5/8 x 3 1/2
4 x 3	6.70	\$101.33	\$131.53	-	5/8 x 3 1/2
5 x 4	11.40	\$136.88	\$180.41	-	3/4 x 4 1/2
6 x 4	13.40	\$206.80	\$261.00	-	3/4 x 4 1/2
6 x 5	13.50	\$181.02	\$234.93	-	3/4 x 4 1/2
8 x 6	17.70	\$309.90	\$393.14	-	3/4 x 4 1/2

Note: Not recommended for Vacuum Service  
All bolts are oval-neck track head design to ASTM A-183, with heavy hex nuts to ASTM A-563, and are zinc plated to ASTM B-633. Weights are approximate and subject to change.



**Outlet Coupling Fig. i7042F, i7042M and i7042G**

  
For listing details contact  
your Gruvlok Representative.

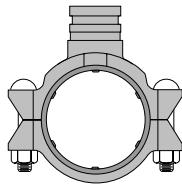

Grooved Outlet i7042G

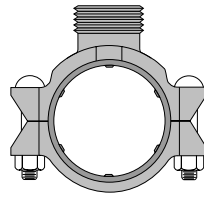

Male IPS Outlet i7042M

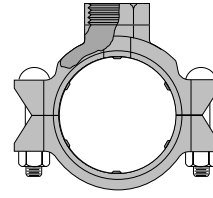

Female IPS Outlet i7042F

NOMINAL PIPE SIZE (INCHES)	i7042G & i7042M				i7042F			BOX QTY.
	BRANCH (INCHES)	APRX. WEIGHT EACH (LBS)	GROOVED & MALE THREADED BRANCH WITH "E" OR "T" GASKET (PRICE EACH)		APRX. WEIGHT EACH (LBS)	i7042F FEMALE THREADED BRANCH WITH "E" OR "T" GASKET (PRICE EACH)		
			PAINTED	GALV.		PAINTED	GALV.	
1½	x½	-	-	-	2.60	\$65.18	\$77.03	-
	x¾	-	-	-	2.60	\$65.18	\$77.03	-
	x1	-	-	-	2.60	\$65.18	\$77.03	-
2	x½	-	-	-	3.30	\$66.66	\$82.66	-
	x¾	-	-	-	3.30	\$66.66	\$82.66	-
	x1	3.30	\$73.89	\$98.01	3.30	\$66.66	\$82.66	-
2½	x½	-	-	-	4.80	\$103.39	\$127.69	-
	x¾	-	-	-	4.80	\$103.39	\$127.69	-
	x1	-	-	-	4.80	\$103.39	\$127.69	-
	x1¼	-	-	-	5.50	\$117.03	\$148.13	-
3	x¾	-	-	-	7.90	\$99.84	\$121.47	-
	x1	7.90	\$153.34	\$187.00	7.90	\$131.84	\$165.32	-
	x1½	8.60	\$153.34	\$187.00	-	-	-	-
4	x¾	-	-	-	9.90	\$146.65	\$182.50	-
	x1	9.90	\$148.25	\$196.78	-	-	-	-
	x1½	-	-	-	11.00	\$208.57	\$182.50	-
	2	11.00	\$211.23	\$286.55	-	-	-	-
6	x1	-	-	-	18.00	\$295.37	\$383.95	-
	x½	-	-	-	18.00	\$295.37	\$383.95	-
	x2	18.00	\$299.16	\$414.71	-	-	-	-

Contact Anvil for specific service recommendations. Specify gasket grade when ordering.  
Use Gruvlok lubricant on gaskets. Check gasket color code to be certain it is recommended for the service intended.

Grooved-End Couplings  
Fittings  
Valves and Accessories  
Spare Parts  
Plain-End  
Copper Method  
Tools

**HPR Coupling Fig. 7004 HPR  
(with Standard Gasket)**



For listing/approval details contact your Gruvlok Representative.

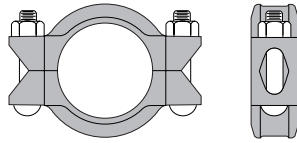

**End Guard Coupling Fig. 7004 EG  
(with End Guard Gasket)**

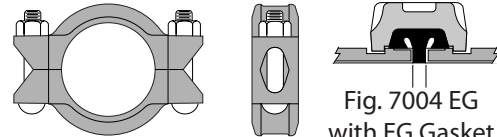

Fig. 7004 EG  
with EG Gasket

NOMINAL PIPE SIZE (INCHES)	PIPE OUTSIDE DIAMETER (INCHES)	APRX. WEIGHT EACH (LBS)	COUPLING COMPLETE WITH "E" OR "T" GASKET (PRICE EACH)		BOX QTY.	PLATED BOLT & NUT SIZE (INCHES)
			PAINTED	GALV.		
2	2.375	3.90	\$44.73	\$60.44	-	5/8 x 2 3/4
2 1/2	2.875	4.60	\$50.66	\$69.02	-	5/8 x 3 1/2
3	3.500	5.20	\$56.58	\$77.03	-	5/8 x 3 1/2
4	4.500	8.60	\$83.25	\$118.51	-	3/4 x 4 1/2
5	5.563	14.00	\$171.59	POA	-	7/8 x 5 1/2
6	6.625	15.50	\$150.50	\$217.46	-	7/8 x 5 1/2
8	8.625	25.60	\$242.04	\$348.11	-	1 x 5 1/2
10	10.750	32.30	\$447.94	\$613.55	-	1 x 6 1/2
12	12.750	43.90	\$653.84	\$875.45	-	1 x 6 1/2

All bolts are oval-neck track head design to ASTM A-183, with heavy hex nuts to ASTM A-563, and are zinc plated to ASTM B-633. Weights are approximate and subject to change. For pricing on spare parts see page 30.

NOMINAL PIPE SIZE (INCHES)	PIPE OUTSIDE DIAMETER (INCHES)	APRX. WEIGHT EACH (LBS)	COUPLING COMPLETE WITH "E" OR "T" GASKET (PRICE EACH)		BOX QTY.	PLATED BOLT & NUT SIZE (INCHES)
			PAINTED	GALV.		
2	2.375	4.10	\$59.85	\$80.34	-	5/8 x 2 3/4
2 1/2	2.875	5.10	\$69.92	\$95.46	-	5/8 x 3 1/2
3	3.500	5.50	\$78.51	\$107.89	-	5/8 x 3 1/2
4	4.500	9.00	\$111.10	\$157.19	-	3/4 x 4 1/2
6	6.625	15.50	\$192.57	\$350.59	-	7/8 x 5 1/2
8	8.625	26.50	\$297.44	\$423.35	-	1 x 5 1/2
10	10.750	32.30	\$559.33	\$778.09	-	1 x 6 1/2
12	12.750	43.90	\$705.69	\$983.87	-	1 x 6 1/2

All bolts are oval-neck track head design to ASTM A-183, with heavy hex nuts to ASTM A-563, and are zinc plated to ASTM B-633. Contact Anvil for specific service recommendations. Specify gasket grade when ordering. Use Gruvlok lubricant on gaskets. Check gasket color code to be certain it is recommended for the service intended.

**Couplings for HPDE Pipe**

**HDPE Coupling Fig. 7305**

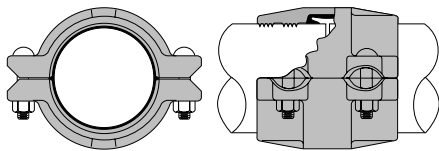

NOMINAL PIPE SIZE (INCHES)	PIPE OUTSIDE DIAMETER (INCHES)	APRX. WEIGHT EACH (LBS)	COMPLETE "E" OR "T" GASKET (PRICE EACH)	BOX QTY.
2	2.375	4.50	\$246.78	-
3	3.500	8.50	\$295.08	-
4	4.500	12.00	\$324.11	-
6	6.625	18.00	\$451.20	-
8	8.625	30.00	\$528.82	-
10	10.750	43.00	\$608.52	-
12	12.750	58.00	\$700.95	-

Weights are approximate and subject to change. UPC numbers and commodity identification numbers are available upon request. \*Contact your Anvil Representative for galvanized pricing.

**HDPE Transition Coupling Fig. 7307**

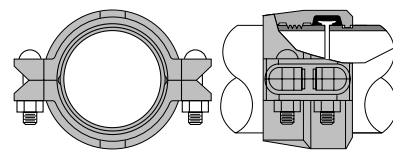

NOMINAL PIPE SIZE (INCHES)	PIPE OUTSIDE DIAMETER (INCHES)	APRX. WEIGHT EACH (LBS)	COUPLING "E" OR "T" GASKET (PRICE EACH)	BOX QTY.	BOLT SIZE
2	2.375	4.50	\$265.74	-	1/2 x 2 3/8
3	3.500	6.00	\$311.67	-	1/2 x 3
4	4.500	8.50	\$364.40	-	1/2 x 3
6	6.625	12.50	\$417.13	-	5/8 x 3 1/2
8	8.625	20.50	\$576.53	-	5/8 x 3 1/2
10	10.750	34.50	\$795.75	-	7/8 x 5 1/2
12	12.750	42.50	\$910.40	-	7/8 x 5 1/2

Weights are approximate and subject to change. UPC numbers and commodity identification numbers are available upon request. \*Contact your Anvil Representative for galvanized pricing.

**Flange Adapter for HDPE Pipe, Fig. 7312**  
**HDPE Flange Complete**

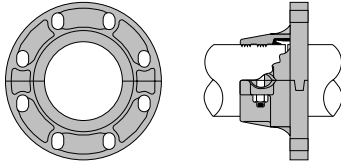

NOMINAL PIPE SIZE (INCHES)	APRX. WEIGHT EACH (LBS)	HDPE FLANGE COMPLETE WITH "E" OR "T" GASKET	BOX QTY.
4	15.00	\$378.02	-
6	22.00	\$532.08	-
8	26.00	\$623.62	-

HDPE Flange has ductile iron housing. Not supplied with flange bolts, nuts or gasket.  
\*Contact your Anvil Representative for galvanized pricing.

**Gruvlok Flange Fig. 7012**

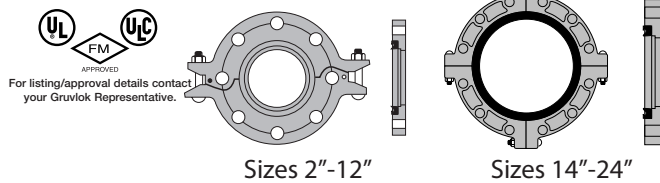

Sizes 2"-12"

Sizes 14"-24"

NOMINAL PIPE SIZE (INCHES)	PIPE OUTSIDE DIAMETER (INCHES)	APRX. WEIGHT EACH (LBS)	COUPLING COMPLETE WITH "E" OR "T" GASKET (PRICE EACH)		BOX QTY.
			PAINTED	GALV.	
<b>HINGED</b>					
2*Δ	2.375	4.60	\$147.24	\$177.76	-
2½*	2.875	6.20	\$182.79	\$225.16	-
3*Δ	3.500	6.60	\$197.32	\$244.72	-
4*Δ	4.500	9.30	\$264.27	\$327.66	-
5*	5.563	10.20	\$306.93	\$380.40	-
6*Δ	6.625	12.00	\$334.78	\$416.84	-
8*	8.625	15.60	\$378.02	\$485.28	-
10*	10.750	18.20	\$599.04	\$761.39	-
12*	12.750	29.90	\$783.91	\$1,007.56	-
<b>FOUR PIECE</b>					
14*	14.000	52.50	\$1,798.58	\$2,213.05	-
16*	16.000	67.00	\$2,086.84	\$2,586.92	-
18*	18.000	82.50	\$2,569.15	\$3,274.84	-
20*	20.000	106.50	\$3,091.75	\$3,956.53	-
24*	24.000	138.50	\$3,956.53	\$5,103.63	-

The Gruvlok Flange bolt hole pattern conforms to Class 150 steel and Class 125 cast iron flanges utilizing standard flange bolts.

\*Available with pn 10/16 bolt hole patterns.

Δ New Viton Gasket is POA – Please check with an Anvil Sales Rep for more Information.

Flange Sealing Rings are recommended for use between wafer/lug type valves and Gruvlok Flanges.

For applications with wafer valves a latch bolt is recommended on both sides of the flange. (request extra latch bolt) Use: 3/8 x 2 1/2 for 2"-6", 1/2 x 3 1/2 for 8"-12" sizes.

**Gruvlok 300# Flange Fig. 7013**

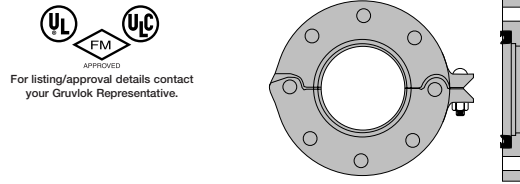

For listing/approval details contact your Gruvlok Representative.

NOMINAL PIPE SIZE (INCHES)	PIPE OUTSIDE DIAMETER (INCHES)	APRX. WEIGHT EACH (LBS)	COUPLING COMPLETE WITH "E" OR "T" GASKET (PRICE EACH)		BOX QTY.
			PAINTED	GALV.	
2	2.375	5.00	\$184.28	\$216.86	-
2½	2.875	6.90	\$213.31	\$255.67	-
3	3.500	9.40	\$292.12	\$346.63	-
4	4.500	14.40	\$389.29	\$471.94	-
5	5.563	18.30	\$442.62	\$535.35	-
6	6.625	24.90	\$515.19	\$631.62	-
8	8.625	35.40	\$591.04	\$745.38	-
10	10.750	54.00	\$942.09	\$1,171.10	-
12	12.750	74.80	\$1,005.79	\$1,297.61	-

The Gruvlok 300# Flange bolt hole pattern conforms to Class 300 steel, utilizing standard flange bolts.

\*\*Flange Sealing rings are recommended for use between wafer/lug type valves and Gruvlok flanges.

Flange Bolts, Nuts and Gaskets not provided.

Grooved-End Couplings  
Fittings  
Valves and Accessories  
Spare Parts  
Plain-End  
Copper Method  
Tools

## Fittings for Grooved-End Pipe

### 90° Elbows Fig. 7050

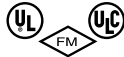

For listing/approval details contact your Gruvlok Representative.

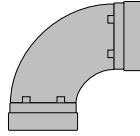

NOMINAL PIPE SIZE (INCHES)	APRX. WEIGHT EACH (LBS)	PRICE EACH		BOX QTY.
		PAINTED	GALV.	
1	0.60	\$43.85	\$58.07	-
1¼	1.00	\$43.85	\$58.07	-
1½	1.20	\$43.85	\$58.07	-
2	1.70	\$43.85	\$58.07	-
2½	2.60	\$43.85	\$58.07	-
3	4.00	\$77.63	\$97.47	-
3½	5.50	\$90.35	\$119.39	-
4	7.70	\$84.74	\$118.51	-
5	11.10	\$203.83	\$263.67	-
6	16.50	\$239.37	\$317.88	-
8	30.60	\$500.68	\$660.36	-
10	53.50	\$910.40	\$1,179.40	-
12	82.00	\$1,458.77	\$1,882.12	-
14*	169.00	\$2,658.15	\$3,674.37	-
16*	222.00	\$3,452.82	\$4,756.06	-
18*	280.00	\$4,380.40	\$5,816.97	-
20*	344.00	\$5,776.96	\$7,634.56	-
24*	490.00	\$8,365.96	\$11,092.06	-

### 45° Elbows Fig. 7051



For listing/approval details contact your Gruvlok Representative.

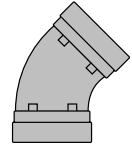

NOMINAL PIPE SIZE (INCHES)	APRX. WEIGHT EACH (LBS)	PRICE EACH		BOX QTY.
		PAINTED	GALV.	
1	0.50	\$43.85	\$54.81	-
1¼	0.70	\$43.85	\$54.81	-
1½	0.90	\$43.85	\$54.81	-
2	1.50	\$43.85	\$54.81	-
2½	1.90	\$43.85	\$54.81	-
3	3.30	\$77.63	\$91.84	-
3½	4.30	\$90.35	\$110.51	-
4	5.40	\$84.74	\$110.51	-
5	9.00	\$203.83	\$253.01	-
6	11.20	\$239.37	\$302.78	-
8	19.80	\$500.68	\$628.96	-
10	34.30	\$910.40	\$993.65	-
12	50.00	\$1,458.77	\$1,700.51	-
14*	92.00	\$1,990.19	\$2,714.56	-
16*	117.00	\$2,240.42	\$2,961.87	-
18*	146.00	\$2,626.03	\$3,426.87	-
20*	179.00	\$3,450.22	\$4,516.81	-
24*	255.00	\$5,298.92	\$6,878.03	-

\*Gruvlok fittings are full flow fittings made of ductile iron except those marked (\*) which are full flow 1½ D fabricated steel.

### 22½° Elbows Fig. 7052

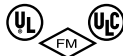

For listing/approval details contact your Gruvlok Representative.

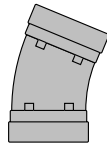

NOMINAL PIPE SIZE (INCHES)	APRX. WEIGHT EACH (LBS)	PRICE EACH		BOX QTY.
		PAINTED	GALV.	
1*	0.50	\$47.11	\$290.93	-
1¼*	0.70	\$47.11	\$60.44	-
1½	0.80	\$47.11	\$60.44	-
2	1.50	\$47.11	\$60.44	-
2½*	1.90	\$47.11	\$60.44	-
3	3.20	\$68.73	\$87.10	-
3½*	4.00	\$163.24	\$218.34	-
4	5.30	\$91.54	\$118.80	-
5*	7.20	\$283.22	\$342.18	-
6	8.20	\$258.63	\$330.04	-
8	17.80	\$540.67	\$671.91	-
10*	30.00	\$738.10	\$963.42	-
12*	40.40	\$1,002.53	\$1,243.70	-
14*	46.00	\$1,173.78	\$1,409.42	-
16*	52.20	\$1,407.81	\$1,708.40	-
18*	65.00	\$1,695.07	\$2,042.46	-
20*	80.00	\$2,015.68	\$2,443.59	-
24*	112.00	\$2,708.39	\$3,382.20	-

### 11¼° Elbows Fig. 7053



For listing/approval details contact your Gruvlok Representative.

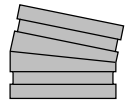

NOMINAL PIPE SIZE (INCHES)	APRX. WEIGHT EACH (LBS)	PRICE EACH		BOX QTY.
		PAINTED	GALV.	
1*	0.30	\$111.39	\$130.65	-
1¼*	0.50	\$47.11	\$60.44	-
1½*	0.70	\$47.11	\$60.44	-
2*	0.90	\$111.39	\$130.36	-
2½*	1.50	\$111.39	\$130.36	-
3*	2.00	\$68.73	\$85.61	-
3½*	2.80	\$163.24	\$192.57	-
4*	3.30	\$163.24	\$112.87	-
5*	5.00	\$283.22	\$333.59	-
6*	6.50	\$258.63	\$313.15	-
8*	10.00	\$461.87	\$549.27	-
10*	14.50	\$692.05	\$826.57	-
12*	18.70	\$1,016.23	\$1,209.02	-
14*	32.10	\$1,060.72	\$1,256.73	-
16*	42.00	\$1,307.69	\$1,592.50	-
18*	53.20	\$1,583.32	\$1,938.12	-
20*	65.70	\$1,853.27	\$2,246.28	-
24*	96.00	\$2,626.80	\$3,307.07	-

\*Gruvlok fittings are full flow fittings made of ductile iron except those marked (\*) which are full flow 1½ D fabricated steel.

**Tees Fig. 7060**

  
APPROVED  
For listing/approval details contact  
your Gruvlok Representative.

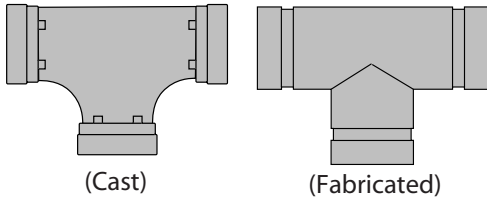

**Tees with Threaded Branch\*, Fig. 7063**

  
APPROVED  
For listing/approval details contact  
your Gruvlok Representative.

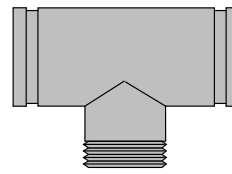

NOMINAL PIPE SIZE (INCHES)	APRX. WEIGHT EACH (LBS)	PRICE EACH		BOX QTY.
		PAINTED	GALV.	
1	0.90	\$67.54	\$88.87	-
1¼	1.50	\$67.54	\$88.87	-
1½	1.80	\$67.54	\$88.87	-
2	2.40	\$67.54	\$88.87	-
2½	4.00	\$67.54	\$88.87	-
3	5.80	\$94.22	\$129.17	-
3½	9.80	\$385.43	\$477.57	-
4	10.30	\$143.68	\$195.53	-
5	16.20	\$336.84	\$427.80	-
6	25.70	\$388.98	\$530.90	-
8	41.10	\$853.51	\$1,120.75	-
10	74.50	\$1,773.40	\$2,296.88	-
12	94.70	\$2,472.27	\$3,146.26	-
14*	118.00	\$2,619.81	\$3,262.68	-
16*	146.00	\$2,958.72	\$3,757.44	-
18*	218.00	\$3,698.48	\$4,768.56	-
20*	275.00	\$5,299.45	\$6,718.83	-
24*	379.00	\$8,079.83	\$10,480.11	-

\*Gruvlok fittings are full flow fittings made of ductile iron except those marked (\*) which are full flow fabricated steel.

NOMINAL PIPE SIZE (INCHES)	APRX. WEIGHT EACH (LBS)	PRICE EACH		BOX QTY.
		PAINTED	GALV.	
1*	0.90	\$100.73	\$125.91	-
1¼*	1.40	\$143.99	\$169.75	-
1½*	1.70	\$225.45	\$265.44	-
2*	2.90	\$143.99	\$169.75	-
2½*	4.70	\$191.68	\$229.90	-
3*	8.10	\$191.68	\$229.90	-
4*	13.50	\$299.52	\$412.39	-
5*	16.70	\$673.10	\$793.08	-
6*	25.60	\$770.27	\$907.44	-
8*	45.00	\$844.93	\$1,185.86	-
10*	73.00	\$1,344.01	\$1,936.58	-
12*	98.00	\$2,016.21	\$2,775.63	-

\*Gruvlok fittings are full flow fittings made of ductile iron except those marked (\*) which are full flow fabricated steel.

Grooved-End Couplings  
Fittings  
Valves and Accessories  
Spare Parts  
Plain-End  
Copper Method  
Tools

**Reducing Tees Fig. 7061**



For listing/approval details contact your Gruklok Representative.

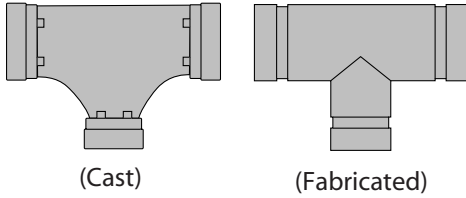

NOMINAL PIPE SIZE (INCHES)	BRANCH	APRX. WEIGHT EACH (LBS)	PRICE EACH		BOX QTY.
			PAINTED	GALV.	
1 1/4 x 1 1/4	x 1*	1.50	\$122.47	\$138.06	-
	x 1*	1.80	\$124.14	\$138.06	-
1 1/2 x 1 1/2	x 1 1/4*	1.80	\$127.69	\$138.06	-
	x 1	2.60	\$159.40	\$187.83	-
2 x 2	x 1 1/4*	1.70	\$145.17	\$172.43	-
	x 1 1/2	2.70	\$145.17	\$173.02	-
2 1/2 x 2 1/2	x 1*	4.10	\$145.17	\$185.76	-
	x 1 1/4*	4.20	\$219.83	\$172.43	-
	x 1 1/2*	4.30	\$145.17	\$173.02	-
	x 2*	4.40	\$145.17	\$173.02	-
3 x 3	x 1*	7.00	\$175.38	\$164.43	-
	x 1 1/4*	5.80	\$180.73	\$210.93	-
	x 1 1/2*	5.90	\$128.27	\$165.32	-
	x 2	5.50	\$128.27	\$165.32	-
4 x 4	x 2 1/2*	6.30	\$173.02	\$165.32	-
	x 1*	7.00	\$173.02	\$216.57	-
	x 1 1/4*	9.60	\$250.64	\$307.81	-
	x 1 1/2*	10.20	\$173.02	\$216.57	-
	x 2	10.20	\$173.02	\$227.82	-
5 x 5	x 2 1/2	11.20	\$173.02	\$227.82	-
	x 3	11.40	\$173.02	\$227.82	-
	x 1*	13.60	\$393.43	\$471.65	-
	x 1 1/4*	13.50	\$376.95	\$467.52	-
	x 1 1/2*	13.80	\$395.80	\$490.89	-
	x 2*	14.00	\$421.58	\$520.83	-
6 x 6	x 2 1/2*	14.30	\$342.77	\$432.24	-
	x 3*	14.60	\$342.77	\$432.24	-
	x 4*	17.90	\$371.51	\$469.86	-
	x 1*	20.50	\$461.87	\$566.45	-
	x 1 1/4*	21.00	\$454.54	\$580.10	-
	x 1 1/2*	21.00	\$477.27	\$609.11	-
8 x 8	x 2*	26.40	\$409.13	\$537.71	-
	x 2 1/2*	26.50	\$409.13	\$537.71	-
	x 3*	26.50	\$409.13	\$537.71	-
	x 4*	26.50	\$409.13	\$537.71	-
	x 5	28.00	\$409.13	\$540.97	-
8 x 8	x 1 1/2*	33.00	\$590.44	\$718.12	-
	x 2*	32.70	\$590.44	\$745.38	-
	x 2 1/2*	33.00	\$590.44	\$745.38	-
	x 3*	32.50	\$590.44	\$760.20	-
	x 4	50.00	\$853.51	\$1,103.26	-
	x 5*	34.70	\$853.51	\$1,110.97	-
	x 6	54.00	\$853.51	\$1,115.40	-

NOMINAL PIPE SIZE (INCHES)	BRANCH	APRX. WEIGHT EACH (LBS)	PRICE EACH		BOX QTY.
			PAINTED	GALV.	
10 x 10	x 1 1/2*	52.00	\$1,028.60	\$1,377.90	-
	x 2*	52.20	\$1,028.60	\$1,289.31	-
	x 2 1/2*	52.60	\$1,028.60	\$1,296.71	-
	x 3*	53.00	\$1,028.60	\$1,364.27	-
	x 4*	53.60	\$1,075.12	\$1,374.63	-
	x 5*	54.20	\$1,099.42	\$1,403.68	-
	x 6	55.00	\$1,099.42	\$1,421.74	-
	x 8	64.70	\$1,119.27	\$1,476.25	-
12 x 12	x 1*	77.00	\$1,404.39	\$1,815.94	-
	x 2*	80.00	\$1,404.39	\$1,839.11	-
	x 2 1/2*	78.00	\$1,404.39	\$1,874.72	-
	x 3*	74.60	\$1,404.39	\$1,788.50	-
	x 4*	75.10	\$1,505.04	\$1,906.42	-
	x 5*	75.60	\$1,590.97	\$2,201.36	-
	x 6*	76.20	\$1,587.95	\$2,057.81	-
	x 8*	76.30	\$1,632.39	\$2,105.21	-
	x 10*	77.60	\$1,708.23	\$2,202.97	-
14 x 14	x 4*	100.00	\$1,593.44	\$2,164.46	-
	x 6*	101.00	\$1,644.82	\$2,109.65	-
	x 8*	103.00	\$1,684.82	\$2,271.70	-
	x 10*	104.00	\$1,782.28	\$2,144.32	-
	x 12*	105.00	\$1,907.31	\$2,443.24	-
16 x 16	x 4*	126.00	\$1,907.18	\$2,648.37	-
	x 6*	127.00	\$2,033.51	\$2,627.81	-
	x 8*	128.00	\$2,142.24	\$2,715.80	-
	x 10*	129.00	\$2,314.96	\$2,933.55	-
	x 12*	130.00	\$2,361.47	\$2,999.91	-
	x 14*	132.00	\$2,764.97	\$3,699.90	-
18 x 18	x 4*	188.00	\$2,653.81	\$3,577.32	-
	x 6*	190.00	\$2,689.49	\$3,667.79	-
	x 8*	192.00	\$2,730.61	\$3,742.50	-
	x 10*	194.00	\$2,834.01	\$3,942.01	-
	x 12*	196.00	\$2,834.01	\$3,964.93	-
	x 14*	201.00	\$3,278.98	\$4,536.05	-
	x 16*	203.00	\$3,578.49	\$4,862.59	-
20 x 20	x 6*	240.00	\$3,145.90	\$4,514.49	-
	x 8*	242.00	\$3,574.35	\$5,106.59	-
	x 10*	244.00	\$3,622.34	\$5,165.43	-
	x 12*	246.00	\$4,052.81	\$5,567.45	-
	x 14*	248.00	\$4,365.36	\$5,978.72	-
	x 16*	250.00	\$4,682.65	\$6,385.71	-
	x 18*	252.00	\$5,149.25	\$7,005.07	-
24 x 24	x 8*	327.00	\$3,574.35	\$7,690.13	-
	x 10*	330.00	\$5,692.30	\$8,052.27	-
	x 12*	334.00	\$5,852.57	\$8,284.84	-
	x 14*	340.00	\$6,527.75	\$9,150.93	-
	x 16*	342.00	\$6,675.27	\$9,363.82	-
	x 18*	345.00	\$6,798.51	\$9,137.89	-
	x 20*	347.00	\$7,380.66	\$9,889.55	-

\*Gruklok fittings are full flow fittings made of ductile iron except those marked (\*) which are fabricated steel.

**Reducing Tee with Threaded Branch Fig. 7064**



For listing/approval details contact your Gruvlok Representative.

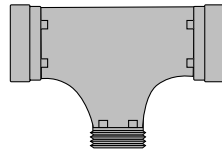

(Cast)

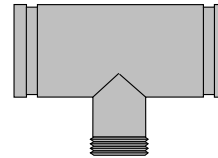

(Fabricated)

NOMINAL PIPE SIZE (INCHES)	BRANCH	APRX. WEIGHT EACH (LBS)	PRICE EACH		BOX QTY.
			PAINTED	GALV.	
2 x 2	x 3/4*	1.60	\$168.87	\$198.19	-
	x 1	2.60	\$153.76	\$180.41	-
	x 1 1/4*	1.70	\$153.76	\$180.41	-
	x 1 1/2	2.70	\$153.76	\$182.50	-
2 1/2 x 2 1/2	x 1*	4.10	\$153.76	\$180.41	-
	x 1 1/4*	3.50	\$146.44	\$173.80	-
	x 1 1/2*	4.30	\$153.76	\$182.50	-
	x 2*	4.40	\$153.76	\$183.98	-
3 x 3	x 3/4*	5.70	\$191.68	\$209.46	-
	x 1	7.00	\$153.76	\$192.27	-
	x 1 1/4*	6.00	\$146.44	\$184.25	-
	x 1 1/2*	5.30	\$153.76	\$193.45	-
	x 2*	5.50	\$153.76	\$193.45	-
4 x 4	x 2 1/2*	5.80	\$265.15	\$311.96	-
	x 3/4*	7.20	\$410.91	\$506.30	-
	x 1*	7.00	\$191.97	\$237.60	-
	x 1 1/4*	8.00	\$182.83	\$229.67	-
	x 1 1/2*	9.20	\$191.97	\$241.16	-
	x 2*	10.20	\$191.97	\$241.16	-
	x 2 1/2	11.20	\$191.97	\$248.27	-
5 x 5	x 3*	11.40	\$191.97	\$249.46	-
	x 2*	14.50	\$315.22	\$396.99	-
	x 2 1/2*	15.00	\$284.19	\$396.99	-
	x 3*	16.10	\$371.21	\$432.24	-
6 x 6	x 4*	17.90	\$371.21	\$469.86	-
	x 2*	26.40	\$481.72	\$600.51	-
	x 2 1/2*	26.50	\$481.72	\$600.51	-
	x 3*	26.50	\$481.72	\$600.51	-
	x 4*	26.50	\$481.72	\$600.51	-
8 x 8	x 5	28.00	\$481.72	\$600.51	-
	x 2*	37.50	\$590.44	\$760.20	-
	x 2 1/2*	37.90	\$562.32	\$760.20	-
	x 3*	38.70	\$696.50	\$760.20	-
	x 4*	50.00	\$853.51	\$1,103.26	-
	x 5*	41.00	\$853.51	\$1,109.79	-
	x 6*	54.00	\$853.51	\$1,115.40	-

NOMINAL PIPE SIZE (INCHES)	BRANCH	APRX. WEIGHT EACH (LBS)	PRICE EACH		BOX QTY.
			PAINTED	GALV.	
10 x 10	x 2*	61.80	\$1,028.31	\$1,275.99	-
	x 3*	63.00	\$1,028.31	\$1,275.99	-
	x 4*	64.00	\$1,075.12	\$1,374.63	-
	x 5*	65.10	\$945.36	\$1,403.68	-
	x 6*	55.00	\$1,099.42	\$1,421.74	-
	x 8*	64.70	\$1,119.27	\$1,476.25	-
12 x 12	x 3*	84.90	\$1,385.00	\$1,788.80	-
	x 4*	85.80	\$1,484.25	\$1,906.42	-
	x 5*	87.00	\$1,568.98	\$2,038.54	-
	x 6*	88.30	\$1,587.95	\$2,057.81	-
	x 8*	91.20	\$1,632.68	\$2,105.21	-
14 x 14	x 10*	94.80	\$1,708.23	\$2,108.17	-
	x 8	110.00	POA	POA	-
	x 10	114.00	POA	POA	-
16 x 16	x 12	117.00	POA	POA	-
	x 8	135.00	POA	POA	-
	x 10	139.00	POA	POA	-
18 x 18	x 12	142.00	POA	POA	-
	x 10	204.00	POA	POA	-
	x 12	209.00	POA	POA	-
24 x 24	x 14	211.00	POA	POA	-
	x 16	216.00	POA	POA	-
	x 8	334.00	POA	POA	-
	x 10	342.00	POA	POA	-
	x 12	349.00	POA	POA	-

\*Gruvlok fittings are full flow fittings made of ductile iron except those marked (\*) which are fabricated steel.

Grooved-End Couplings  
Fittings  
Valves and Accessories  
Spare Parts  
Plain-End  
Copper Method  
Tools

**Concentric Reducer Fig. 7072, Groove by Groove (Gr x Gr)**



For listing/approval details contact your Gruvlok Representative.

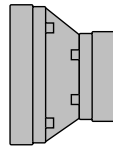

(Cast)

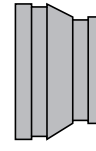

(Weld)

NOMINAL PIPE SIZE (INCHES)	APRX. WEIGHT EACH (LBS)	PRICE EACH		BOX QTY.
		PAINTED	GALV.	
1¼ x 1*	0.60	\$209.46	\$231.08	-
1½ x 1*	0.60	\$51.25	\$60.15	-
	x 1¼*	0.60	\$51.25	-
2 x 1*	0.80	\$51.25	\$60.15	-
	x 1¼	1.30	\$56.29	\$66.06
2½ x 1*	1.00	\$322.93	\$355.21	-
	x 1¼*	1.00	\$51.25	\$60.15
3 x 1*	1.20	\$56.29	\$68.44	-
	x 1¼*	1.30	\$321.14	\$360.24
3½ x 1*	1.30	\$61.62	\$75.55	-
	x 2	1.40	\$45.04	\$55.11
4 x 1*	1.30	\$61.62	\$74.66	-
	x 2½*	2.20	\$67.54	\$83.84
4 x 1¼*	2.20	\$530.60	\$594.30	-
	x 1½*	2.30	\$405.87	\$444.10
4 x 2	2.40	\$59.85	\$74.07	-
	x 2½	2.60	\$74.66	\$91.25
4 x 3	3.20	\$74.66	\$91.25	-
	x 3½	3.60	\$74.66	\$91.25
5 x 2*	4.60	\$746.57	\$824.79	-
	x 2½*	4.50	\$579.48	\$628.67
5 x 3*	4.40	\$87.10	\$107.55	-
	x 4	4.50	\$103.99	\$130.36
6 x 1*	6.80	\$138.06	\$172.12	-
	x 1½*	6.90	\$795.63	\$942.16
6 x 2	6.00	\$138.06	\$172.12	-
	x 2½*	6.00	\$153.76	\$189.02
6 x 3	5.40	\$138.06	\$172.12	-
	x 4	5.60	\$119.98	\$156.14
6 x 5	6.00	\$177.76	\$221.90	-

NOMINAL PIPE SIZE (INCHES)	APRX. WEIGHT EACH (LBS)	PRICE EACH		BOX QTY.	
		PAINTED	GALV.		
8	x 3*	12.00	\$246.20	\$307.52	-
	x 4	9.00	\$246.20	\$309.00	-
	x 5*	11.50	\$246.20	\$311.07	-
	x 6	10.60	\$313.74	\$393.14	-
10	x 4*	20.00	\$585.40	\$721.09	-
	x 5*	20.00	\$1,289.61	\$1,471.51	-
	x 6*	20.00	\$639.92	\$798.71	-
	x 8*	23.90	\$639.92	\$811.75	-
12	x 6*	29.00	\$763.45	\$943.57	-
	x 8*	29.00	\$1,146.21	\$1,354.20	-
14	x 10*	32.40	\$1,146.21	\$1,420.26	-
	x 6*	54.30	\$4,330.39	\$4,693.91	-
	x 8*	54.50	\$2,453.90	\$2,715.20	-
	x 10*	55.70	\$2,144.32	\$2,393.46	-
16	x 12*	57.30	\$2,347.83	\$2,647.06	-
	x 8*	65.40	\$3,515.69	\$3,834.46	-
	x 10*	66.70	\$3,377.62	\$3,442.80	-
	x 12*	68.10	\$3,423.56	\$3,856.09	-
18	x 14*	76.00	\$3,423.56	\$3,903.20	-
	x 10*	82.30	\$4,688.57	\$5,581.07	-
	x 12*	83.60	\$4,814.49	\$4,867.39	-
	x 14*	86.20	\$3,898.16	\$4,911.66	-
20	x 16*	87.20	\$3,898.16	\$4,911.66	-
	x 10*	123.00	\$5,131.00	\$6,337.96	-
	x 12*	125.00	\$5,320.91	\$6,340.56	-
	x 14*	129.00	\$4,819.22	\$5,777.68	-
24	x 16*	131.00	\$4,299.52	\$5,068.97	-
	x 18*	133.00	\$4,080.66	\$5,088.75	-
	x 10*	147.00	\$11,433.53	\$13,544.78	-
	x 12*	149.00	\$11,157.35	\$13,260.90	-
24	x 14*	152.00	\$9,700.54	\$11,181.76	-
	x 16*	153.00	\$9,700.54	\$11,181.76	-
	x 18*	154.00	\$8,491.34	\$9,838.36	-
	x 20*	155.00	\$7,862.56	\$9,105.89	-

\*Gruvlok fittings are full flow fittings made of ductile iron except those marked (\*) which are fabricated steel.



**Cap Fig. 7074**



For listing/approval details contact your Gruvlok Representative.

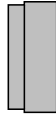

NOMINAL PIPE SIZE (INCHES)	APRX. WEIGHT EACH (LBS)	PRICE EACH		BOX QTY.
		PAINTED	GALV.	
1	0.30	\$36.44	\$44.14	-
1¼	0.40	\$36.44	\$44.14	-
1½	0.50	\$36.44	\$44.14	-
2	0.50	\$36.44	\$44.14	-
2½	0.70	\$36.44	\$44.14	-
3	1.10	\$36.44	\$44.14	-
3½	1.40	\$39.70	\$52.14	-
4	2.80	\$39.70	\$52.14	-
5	4.00	\$93.91	\$125.91	-
6	6.00	\$93.91	\$125.91	-
8	12.50	\$180.12	\$238.79	-
10	21.90	\$380.40	\$495.34	-
12	33.80	\$623.03	\$793.38	-
14*	40.00	\$1,344.11	\$1,539.06	-
16*	45.00	\$1,521.58	\$1,817.25	-
18*	58.00	\$1,761.85	\$2,081.51	-
20*	79.00	\$2,000.62	\$2,389.02	-
24*	100.00	\$2,724.39	\$3,150.71	-

\*Fabricated Steel

**Hose Nipple Fig. 7086**  
**Groove by Hose (Gr x Hose)**

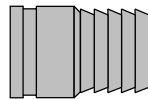

NOMINAL PIPE SIZE (INCHES)	APRX. WEIGHT EACH (LBS)	PRICE EACH		BOX QTY.
		PAINTED	GALV.	
1	0.40	\$87.99	\$111.10	-
1¼	0.70	\$87.99	\$111.10	-
1½	0.80	\$87.99	\$111.10	-
2	1.30	\$87.99	\$104.88	-
2½	2.10	\$87.99	\$104.88	-
3	3.30	\$126.50	\$152.87	-
4	5.50	\$221.30	\$266.63	-
5	8.10	\$334.78	\$401.73	-
6	13.20	\$398.17	\$486.46	-
8	24.00	\$827.44	\$1,068.08	-
10	29.00	\$843.45	\$1,095.44	-
12	46.00	\$923.38	\$1,221.30	-

**Concentric Reducer Fig. 7076**  
**Groove by Thread (Gr x Thd)**



For listing/approval details contact your Gruvlok Representative.

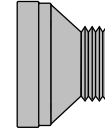

NOMINAL PIPE SIZE (INCHES)	APRX. WEIGHT EACH (LBS)	PRICE EACH		BOX QTY.	
		PAINTED	GALV.		
1½	x 1*	0.60	\$53.03	\$65.77	-
	x ¾*	1.00	\$53.03	\$65.77	-
	x 1	0.80	\$53.03	\$65.77	-
2	x 1¼	1.30	\$53.03	\$65.77	-
	x 1½	1.30	\$53.03	\$65.77	-
	x 1*	1.00	\$311.67	\$332.40	-
2½	x 1¼*	1.00	\$75.84	\$93.91	-
	x 1½*	1.30	\$79.40	\$93.91	-
	x 2	1.20	\$53.03	\$65.77	-
3	x ¾*	1.20	\$389.88	\$415.65	-
	x 1*	1.20	\$58.07	\$69.92	-
	x 1¼*	1.30	\$62.64	\$67.33	-
	x 1½*	1.30	\$65.77	\$78.81	-
	x 2	1.30	\$65.77	\$78.81	-
4	x 2½	1.50	\$79.40	\$93.91	-
	x 1*	2.20	\$75.25	\$91.25	-
	x 1¼*	2.20	\$382.91	\$392.69	-
	x 1½*	2.30	\$424.54	\$458.02	-
	x 2*	2.40	\$79.69	\$96.28	-
	x 2½	2.30	\$80.58	\$98.96	-
5	x 3	2.60	\$98.36	\$117.32	-
	x 4	4.50	\$565.86	\$615.63	-
	x 1*	6.00	\$153.76	\$189.02	-
	x 1¼*	6.00	\$138.39	\$189.02	-
	x 1½*	6.10	\$138.39	\$189.02	-
6	x 2	6.00	\$153.76	\$189.02	-
	x 3	6.00	\$153.76	\$189.02	-
	x 4	5.90	\$153.76	\$189.02	-
	x 5	5.80	\$153.76	\$203.64	-
	x 3*	9.30	\$251.52	\$334.54	-
8	x 4	10.40	\$251.52	\$334.54	-
	x 5*	11.60	\$251.52	\$338.50	-
	x 6	11.90	\$320.67	\$427.92	-
10	x 4*	19.70	\$598.91	\$786.03	-
	x 5	34.30	\$1,319.89	\$1,604.18	-
	x 6	20.00	\$654.85	\$870.47	-
12	x 8*	22.10	\$654.85	\$884.87	-
	x 4*	44.00	POA	POA	-
	x 6	24.60	POA	POA	-
	x 8*	52.00	POA	POA	-
12	x 10*	38.00	POA	POA	-

\*Fabricated Steel  
Reducer sizes not shown, will be priced on application.

Grooved-End Couplings  
Fittings  
Valves and Accessories  
Spare Parts  
Plain-End  
Copper Method  
Tools

**Eccentric Reducer Fig. 7073 and Figure 7097**



For listing/approval details contact your Gruklok Representative.

Fig. 7073  
GR x GR

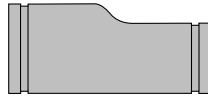

(Fabricated)

Fig. 7097  
GR x THD

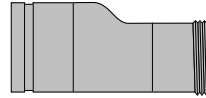

(Fabricated)

NOMINAL PIPE SIZE (INCHES)	APRX. WEIGHT EACH (LBS)	PRICE EACH		BOX QTY.	
		PAINTED	GALV.		
1¼	x 1	1.50	\$223.50	\$279.43	-
	x ¾	1.60	\$247.68	\$284.41	-
1½	x 1	1.70	\$223.50	\$279.43	-
	x 1¼	4.50	\$215.97	\$269.54	-
2	x ¾	2.10	\$474.61	\$558.04	-
	x 1	2.20	\$244.11	\$295.91	-
	x 1¼	2.40	\$266.92	\$317.95	-
2½	x 1½	2.50	\$223.68	\$279.14	-
	x 1	3.20	\$577.11	\$638.73	-
	x 1¼	3.40	\$335.65	\$380.69	-
3	x 1½	3.60	\$266.05	\$303.97	-
	x 2	4.00	\$107.55	\$147.54	-
	x 1	4.00	\$619.19	\$682.28	-
3½	x 1¼	4.30	\$560.52	\$617.70	-
	x 1½	4.50	\$307.52	\$359.36	-
	x 2	4.80	\$123.54	\$169.46	-
	x 2½	5.60	\$123.54	\$173.02	-
4	x 3	6.60	\$680.21	\$819.45	-
	x 1	5.90	\$1,254.36	\$1,344.72	-
	x 1½	6.40	\$769.09	\$819.45	-
	x 2	6.70	\$150.50	\$210.93	-
5	x 2½	7.30	\$150.50	\$210.93	-
	x 3	7.90	\$150.50	\$210.93	-
	x 2	9.30	\$836.63	\$977.17	-
	x 2½	9.90	\$712.80	\$853.41	-
6	x 3	10.70	\$688.50	\$829.53	-
	x 4	11.90	\$205.31	\$313.08	-
	x 1	12.00	\$1,300.27	\$1,411.67	-
	x 2	12.20	\$1,185.93	\$1,291.10	-
6	x 2½	12.80	\$1,411.67	\$1,537.27	-
	x 3	13.60	\$273.15	\$383.37	-
	x 4	14.90	\$239.08	\$351.95	-
	x 5	16.20	\$286.77	\$407.65	-

NOMINAL PIPE SIZE (INCHES)	APRX. WEIGHT EACH (LBS)	PRICE EACH		BOX QTY.	
		PAINTED	GALV.		
8	x 3	17.90	\$1,377.60	\$1,500.25	-
	x 4	19.70	\$1,204.29	\$1,373.45	-
	x 5	21.40	\$1,204.29	\$1,373.45	-
	x 6	23.20	\$484.09	\$659.47	-
10	x 4	29.70	\$2,209.19	\$2,649.73	-
	x 5	31.70	\$2,080.91	\$2,449.16	-
	x 6	34.00	\$1,569.57	\$1,860.49	-
	x 8	34.40	\$1,328.42	\$1,652.23	-
12	x 6	45.20	\$2,096.61	\$2,525.01	-
	x 8	47.70	\$2,042.70	\$2,445.31	-
	x 10	52.00	\$1,829.68	\$2,170.09	-
14	x 6	78.00	\$5,288.79	\$6,294.29	-
	x 8	80.00	\$4,004.51	\$4,569.18	-
	x 10	84.00	\$3,662.64	\$4,006.00	-
16	x 12	88.00	\$3,558.35	\$3,891.06	-
	x 8	91.00	\$5,841.02	\$6,782.88	-
	x 10	96.00	\$5,841.02	\$6,279.24	-
	x 12	99.00	\$5,308.64	\$5,806.06	-
18	x 14	104.00	\$5,195.17	\$6,137.33	-
	x 10	110.00	\$7,340.97	\$8,523.98	-
	x 12	113.00	\$6,893.32	\$7,863.99	-
	x 14	117.00	\$6,263.18	\$7,283.43	-
20	x 16	121.00	\$6,263.18	\$7,660.03	-
	x 10	145.00	\$9,913.07	\$11,875.37	-
	x 12	149.00	\$7,257.42	\$8,532.75	-
	x 14	152.00	\$7,201.67	\$8,388.53	-
24	x 16	156.00	\$6,693.58	\$7,817.46	-
	x 18	160.00	\$6,437.13	\$7,724.49	-
	x 12	174.00	\$14,202.95	\$16,636.46	-
	x 14	184.00	\$12,105.14	\$13,959.83	-
24	x 16	189.00	\$12,105.14	\$13,981.11	-
	x 18	194.00	\$11,418.00	\$13,170.31	-
	x 20	199.00	\$10,419.49	\$12,072.43	-

All fabricated steel.  
Reducer sizes not shown will be priced on application.

**90° Long Radius Elbows**  
**Fig. 7050 LR (1½"D)**



For listing/approval details contact your Gruvlok Representative.

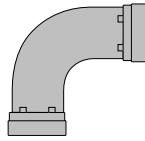

NOMINAL PIPE SIZE (INCHES)	APRX. WEIGHT EACH (LBS)	PRICE EACH		BOX QTY.
		PAINTED	GALV.	
1	0.09	\$17.78	\$25.83	-
1¼	1.30	\$18.90	\$27.50	-
1½	1.70	\$105.94	\$116.26	-
2	2.50	\$100.43	\$131.53	-
2½	4.90	\$290.03	\$311.37	-
3	6.50	\$100.43	\$131.53	-
3½	9.70	\$63.10	\$91.84	-
4	11.50	\$149.91	\$200.87	-
5	20.90	\$765.83	\$877.81	-
6	29.10	\$437.57	\$575.63	-
8	59.20	\$1,340.56	\$1,340.56	-
10	104.00	\$2,172.75	\$2,619.21	-
12	147.00	\$3,541.76	\$4,170.12	-
14	169.00	\$2,608.55	\$3,385.92	-
16	222.00	\$3,388.60	\$4,382.24	-
18	280.00	\$4,300.47	\$5,359.89	-
20	344.00	\$5,668.89	\$7,034.04	-
24	490.00	\$8,209.30	\$10,219.69	-

All fabricated steel fittings.

**45° Long Radius Elbows**  
**Fig. 7051 LR (1½"D)**



For listing/approval details contact your Gruvlok Representative.

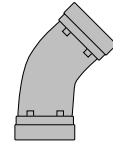

NOMINAL PIPE SIZE (INCHES)	APRX. WEIGHT EACH (LBS)	PRICE EACH		BOX QTY.
		PAINTED	GALV.	
1	0.70	\$16.01	\$23.35	-
1¼	1.00	\$16.35	\$23.88	-
1½	1.20	\$97.64	\$100.90	-
2	1.70	\$87.10	\$110.51	-
2½	2.90	\$279.96	\$315.81	-
3	4.30	\$87.10	\$110.51	-
3½	5.00	\$57.77	\$84.20	-
4	7.20	\$105.76	\$141.02	-
5	12.20	\$711.61	\$780.94	-
6	17.40	\$314.32	\$402.61	-
8	34.00	\$546.30	\$710.43	-
10	57.40	\$1,629.13	\$1,921.22	-
12	82.60	\$1,886.57	\$2,316.15	-
14	92.00	\$1,953.22	\$2,501.30	-
16	117.00	\$2,198.52	\$2,729.72	-
18	146.00	\$2,577.15	\$3,159.89	-
20	179.00	\$3,385.92	\$4,162.11	-
24	255.00	\$5,199.91	\$6,337.25	-

All fabricated steel fittings.

**Reducing Base Support Elbows**  
**Fig. 7050RF Grooved x Flanged (G x F)**

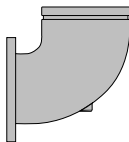

NOMINAL PIPE SIZE (INCHES)	APRX. WEIGHT EACH (LBS)	PRICE EACH BLACK	BOX QTY.
6 x 4	38.50	\$729.68	-
6 x 5	45.40	\$826.25	-
8 x 5	65.50	\$1,249.50	-
8 x 6	73.00	\$1,109.19	-
10 x 6	100.00	\$1,871.69	-
10 x 8	127.00	\$1,661.12	-
12 x 8	155.00	POA	-
12 x 10	186.00	POA	-

All fabricated steel fittings.

**Female Thread Adapter Fig. 7087**



NOMINAL PIPE SIZE (INCHES)	END TO END LENGTH (INCHES)	APRX. WEIGHT EACH (LBS)	PRICE EACH		BOX QTY.
			PAINTED	GALV.	
1	2½ <sub>16</sub>	0.70	\$246.49	\$264.56	-
1¼	2½ <sub>16</sub>	1.40	\$129.76	\$145.17	-
1½	2½ <sub>16</sub>	1.50	\$168.27	\$179.24	-
2	2½	1.60	\$78.81	\$78.81	-
2½	-	1.60	\$78.81	\$92.73	-
3	2¾	2.50	\$91.54	\$112.58	-
4	3¼	4.50	\$140.72	\$176.57	-

All fabricated steel fittings.

Grooved-End Couplings  
Fittings  
Valves and Accessories  
Spare Parts  
Plain-End  
Copper Method  
Tools

**Tee WYE Fig. 7066**



For listing/approval details contact your Gruvlok Representative.

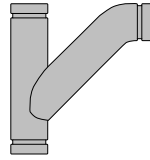

**Lateral Fig. 7069**



For listing/approval details contact your Gruvlok Representative.

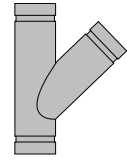

NOMINAL PIPE SIZE (INCHES)	LENGTH (INCHES)	APRX. WEIGHT EACH (LBS)	PRICE EACH		BOX QTY.
			PAINTED	GALV.	
2 x 2	x 2	6.40	\$464.53	\$553.71	-
2½ x 2½	x 2½	11.50	\$464.53	\$597.49	-
3 x 3	x 3	16.50	\$532.38	\$643.47	-
3½ x 3½	x 3½	22.00	\$697.56	\$898.48	-
4 x 4	x 3	23.00	\$642.29	\$777.68	-
	x 4	26.00	\$739.45	\$900.33	-
5 x 5	x 3	32.00	\$930.25	\$1,090.52	-
	x 4	35.00	\$1,071.57	\$1,197.17	-
	x 5	40.00	\$1,576.09	\$1,925.67	-
6 x 6	x 3	50.00	\$771.81	\$1,061.79	-
	x 4	55.00	\$928.17	\$1,160.74	-
	x 5	58.00	\$1,286.29	\$1,694.83	-
	x 6	60.50	\$1,413.45	\$1,747.92	-
8 x 8	x 3	100.00	\$906.84	\$1,318.36	-
	x 4	110.00	\$1,080.75	\$1,490.18	-
	x 5	111.00	\$1,450.89	\$2,034.28	-
	x 6	112.00	\$1,582.97	\$2,204.28	-
10 x 10	x 8	120.00	\$2,151.42	\$1,318.36	-
	x 3	130.00	\$1,250.21	\$1,733.41	-
	x 4	135.00	\$1,371.08	\$1,883.61	-
	x 5	140.00	\$1,752.07	\$2,481.82	-
	x 6	145.00	\$1,845.39	\$2,606.77	-
12 x 12	x 8	150.00	\$3,082.86	\$3,037.23	-
	x 10	190.00	\$3,082.86	\$3,953.56	-
	x 12	240.00	\$4,251.88	\$5,398.70	-

Gruvlok Tee Wyes and Reducing Tee Wye's are fabricated steel.

NOMINAL PIPE SIZE (INCHES)	APRX. WEIGHT EACH (LBS)	PRICE EACH		BOX QTY.
		PAINTED	GALV.	
1	1.50	\$270.13	\$352.79	-
1¼	2.50	\$270.13	\$352.79	-
1½	3.50	\$270.13	\$352.79	-
2	4.50	\$266.63	\$327.07	-
2½	10.00	\$266.63	\$327.07	-
3	11.00	\$294.48	\$371.51	-
3½	14.00	\$395.32	\$529.89	-
4	18.30	\$453.87	\$566.15	-
5	30.00	\$663.33	\$833.08	-
6	46.60	\$1,068.61	\$1,283.99	-
8	82.80	\$1,539.06	\$1,865.24	-
10	127.00	\$2,171.87	\$2,519.37	-
12	165.00	\$2,624.84	\$3,326.97	-
14	215.00	\$3,886.19	\$5,310.53	-
16	345.00	\$4,853.89	\$6,640.79	-
18	425.00	\$5,426.78	\$7,512.98	-
20	517.00	\$8,231.70	\$11,108.84	-
24	940.00	\$12,791.10	\$17,577.43	-

Gruvlok Laterals are fabricated steel.

**Bullhead Plug Fig. 7075**

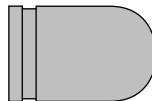

NOMINAL PIPE SIZE (INCHES)	APRX. WEIGHT EACH (LBS)	PRICE EACH BLACK	BOX QTY.
2	2.50	\$135.10	-
2½	3.10	\$135.10	-
3	4.40	\$197.61	-
4	7.40	\$255.38	-
5*	12.50	\$557.56	-
6	18.50	\$601.41	-

Galvanized and other sizes priced on application.  
\*Fabricated steel.

**Steel Cross Fig. 7068 & True Y Fig. 7071**

STEEL CROSS					TRUE Y			
NOMINAL PIPE SIZE (INCHES)	APRX. WEIGHT EACH (LBS)	PRICE EACH		BOX QTY.	APRX. WEIGHT EACH (LBS)	PRICE EACH		BOX QTY.
		PAINTED	GALV.			PAINTED	GALV.	
1	1.30	\$165.91	\$191.39	-	1.10	\$255.97	\$328.07	-
1¼	2.10	\$200.28	\$233.45	-	1.50	\$255.97	\$328.07	-
1½	2.50	\$215.68	\$250.33	-	1.80	\$255.97	\$303.97	-
2	2.90	\$122.35	\$146.05	-	2.30	\$255.97	\$303.97	-
2½	5.20	\$122.35	\$146.05	-	5.00	\$255.97	\$303.97	-
3	7.50	\$219.23	\$268.70	-	6.10	\$305.74	\$363.21	-
3½	9.80	\$441.43	\$527.04	-	8.30	\$331.57	\$454.94	-
4	12.20	\$364.40	\$448.53	-	10.50	\$400.54	\$482.31	-
5	17.60	\$743.61	\$897.07	-	15.00	\$573.85	\$690.28	-
6	28.30	\$956.03	\$1,159.86	-	21.60	\$710.12	\$864.18	-
8	48.00	\$1,259.10	\$1,558.02	-	36.00	\$1,022.09	\$1,256.73	-
10	70.00	\$2,146.99	\$2,655.66	-	51.00	\$1,763.92	\$2,160.91	-
12	110.00	\$3,098.27	\$3,860.83	-	160.00	\$1,948.48	\$2,465.15	-
14	140.00	\$3,255.45	\$4,243.72	-	136.00	\$2,256.24	\$3,015.25	-
16	170.00	\$4,258.47	\$5,522.84	-	166.00	\$2,930.53	\$3,913.97	-
18	260.00	\$5,219.82	\$6,870.86	-	234.00	\$3,352.16	\$4,578.07	-
20	320.00	\$7,395.01	\$9,623.16	-	281.00	\$4,861.71	\$6,505.05	-
24	585.00	\$11,416.23	\$15,585.27	-	523.00	\$7,558.54	\$10,311.42	-

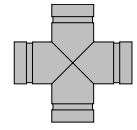

**Steel Cross Fig. 7068**

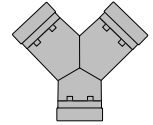

**True Y Fig. 7071**



For listing/approval details contact your Gruvlok Representative.

**Reducing Lateral -- Fig. 7070**



For listing/approval details contact your Gruvlok Representative.

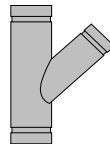

NOMINAL PIPE SIZE (INCHES)	LENGTH (INCHES)	APRX. WEIGHT EACH (LBS)	PRICE EACH		BOX QTY.
			PAINTED	GALV.	
3 x 3	x 2	9.80	\$230.49	\$288.25	-
	x 2½	11.50	\$230.49	\$315.46	-
4 x 4	x 2	15.50	\$453.87	\$540.97	-
	x 2½	17.00	\$453.87	\$559.62	-
	x 3	18.50	\$453.87	\$565.26	-
5 x 5	x 2	22.50	\$663.33	\$877.34	-
	x 3	26.50	\$663.33	\$823.01	-
	x 4	30.50	\$663.33	\$836.05	-
	x 3	37.00	\$856.77	\$1,071.87	-
6 x 6	x 4	40.00	\$856.77	\$1,079.56	-
	x 5	45.00	\$856.77	\$1,091.71	-
	x 4	59.60	\$1,236.59	\$1,569.87	-
8 x 8	x 5	68.00	\$1,236.59	\$1,583.80	-
	x 6	75.00	\$1,236.59	\$1,603.94	-
	x 4	83.00	\$1,405.16	\$1,846.88	-
10 x 10	x 5	100.00	\$1,541.43	\$2,128.02	-
	x 6	105.00	\$1,541.43	\$2,128.02	-
	x 8	116.00	\$1,570.17	\$2,096.92	-

NOMINAL PIPE SIZE (INCHES)	LENGTH (INCHES)	APRX. WEIGHT EACH (LBS)	PRICE EACH		BOX QTY.
			PAINTED	GALV.	
12 x 12	x 4	116.00	POA	POA	-
	x 5	137.00	\$1,822.58	\$2,420.72	-
	x 6	140.00	\$1,822.58	\$2,439.69	-
	x 8	147.00	\$1,846.28	\$2,494.78	-
	x 10	168.00	\$1,870.57	\$2,576.25	-
14 x 14	x 4	173.00	\$1,792.61	\$2,651.51	-
	x 6	185.00	\$1,912.93	\$2,835.25	-
	x 8	195.00	\$2,059.34	\$3,050.16	-
	x 10	223.00	\$2,256.29	\$3,352.50	-
16 x 16	x 12	240.00	\$2,432.45	\$3,615.24	-
	x 6	235.00	\$2,335.69	\$3,486.95	-
	x 8	250.00	\$2,436.54	\$3,648.60	-
	x 10	263.00	\$2,644.88	\$3,934.19	-
18 x 18	x 12	283.00	\$2,842.00	\$4,232.34	-
	x 14	307.00	\$3,252.85	\$4,794.63	-
	x 8	275.00	\$3,269.20	\$4,571.50	-
	x 8	306.00	\$3,399.27	\$4,799.13	-
20 x 20	x 10	321.00	\$3,817.88	\$5,753.80	-
	x 12	333.00	\$3,817.88	\$5,367.23	-
	x 14	358.00	\$4,572.03	\$6,332.50	-
	x 16	382.00	\$5,142.97	\$7,076.17	-
24 x 24	x 12	390.00	\$5,334.11	\$8,274.83	-
	x 14	410.00	\$6,222.59	\$8,445.00	-
	x 16	440.00	\$6,663.72	\$9,042.07	-
24 x 24	x 16	725.00	\$8,895.72	\$12,438.49	-
	x 20	785.00	\$10,771.87	\$14,786.15	-

## Valves for Grooved-End Pipe

### Grooved End Butterfly Valve Series 7700



### Valve with Nylon Coated Body (Grade "E" or Grade "T" Disc)

NOMINAL SIZE (INCHES)	(AN7721-3-"E") (AN7711-3-"T") 10 POSITION HANDLE WITH LATCH-LOCK MEMORY STOP	BOX QTY.	(AN7722-3-"E") (AN7712-3-"T") GEAR OPERATOR	BOX QTY.	GEAR OPERATOR WITH CHAINWHEEL
2	\$415.94	-	\$802.86	-	+
2½	\$512.54	-	\$904.47	-	+
3	\$534.74	-	\$927.88	-	+
4	\$639.33	-	\$1,038.09	-	+
5	\$1,139.99	-	\$1,566.31	-	+
6	\$1,203.10	-	\$1,618.46	-	+
8	\$1,610.40	-	\$2,000.04	-	+
10	\$2,429.97	-	\$2,865.11	-	+
12	\$2,737.59	-	\$3,177.66	-	+

+ Priced on Application. Contact your Anvil Representative for Engineering Assistance.

### Valve with Nylon Coated Body (Grade "O" Disc)

NOMINAL SIZE (INCHES)	(AN7731-3) 10 POSITION HANDLE WITH LATCH-LOCK MEMORY STOP	BOX QTY.	(AN7732-3) GEAR OPERATOR	BOX QTY.	GEAR OPERATOR WITH CHAINWHEEL
2	\$609.99	-	\$968.23	-	+
2½	\$759.13	-	\$1,117.49	-	+
3	\$809.79	-	\$1,169.63	-	+
4	\$934.28	-	\$1,292.16	-	+
5	\$1,504.33	-	\$1,862.51	-	+
6	\$1,631.55	-	\$1,989.79	-	+
8	\$2,302.57	-	\$2,660.75	-	+
10	\$3,633.90	-	\$3,965.71	-	+
12	\$4,098.73	-	\$4,429.64	-	+

+ Priced on Application. Contact your Anvil Representative for Engineering Assistance.

### Valve with Epoxy Coated Body (Grade "E" or Grade "T" Disc)



For listing/approval details contact your Gruvlok Representative.

NOMINAL SIZE (INCHES)	(AE7721-3-"E") (AE7711-3-"T") 10 POSITION HANDLE WITH LATCH-LOCK MEMORY STOP	BOX QTY.	(AE7722-3-"E") (AE7712-3-"T") GEAR OPERATOR	BOX QTY.	GEAR OPERATOR WITH CHAINWHEEL
2	\$453.28	-	\$829.46	-	+
2½	\$558.33	-	\$941.62	-	+
3	\$582.14	-	\$958.58	-	+
4	\$690.11	-	\$1,048.16	-	+
5	\$1,223.19	-	\$1,581.36	-	+
6	\$1,318.76	-	\$1,677.06	-	+
8	\$1,663.55	-	\$2,021.66	-	+
10	\$2,628.82	-	\$2,960.20	-	+
12	\$3,255.28	-	\$4,007.72	-	+

+ Priced on Application. Contact your Anvil Representative for Engineering Assistance.

### Valve with Epoxy Coated Body (Grade "O" Disc)

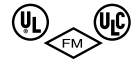

For listing/approval details contact your Gruvlok Representative.

NOMINAL SIZE (INCHES)	(AE7731-3) 10 POSITION HANDLE WITH LATCH-LOCK MEMORY STOP	BOX QTY.	(AE7732-3) GEAR OPERATOR	BOX QTY.	GEAR OPERATOR WITH CHAINWHEEL
2	\$640.52	-	\$1,016.65	-	+
2½	\$797.10	-	\$1,173.30	-	+
3	\$879.95	-	\$1,228.11	-	+
4	\$960.71	-	\$1,318.76	-	+
5	\$1,544.27	-	\$1,902.21	-	+
6	\$1,671.42	-	\$2,029.67	-	+
8	\$2,355.78	-	\$2,713.66	-	+
10	\$3,832.39	-	\$4,164.13	-	+
12	\$4,615.16	-	\$4,946.61	-	+

+ Priced on Application. Contact your Anvil Representative for Engineering Assistance.

## SERIES 7700 BUTTERFLY VALVES (Ordering Information)

### Order by Figure Number

List Exact Size  
2" thru 12" **8"**

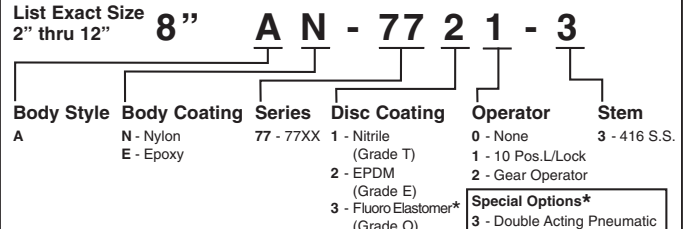

Special Options*	
3	- Double Acting Pneumatic
4	- Electric
5	- Spring Return Pneumatic (with Gear Operator)
6	- Square Nut (with Gear Operator)
7	- Chain wheel (with Gear)
A	- 10 Pos. Pushlock
B	- 2 Pos. Pushlock
C	- 2 Pos. L/Lock
D	- Inf. Pos. w/Memory Stop
E	- Silicone Free

\*Special Disc Coatings & Special Options - Call an Anvil Representative for pricing and availability.

Note: For operator safety, hand levers on 8" and larger valves are limited to applications with a 25 PSI maximum pressure for liquid media.

**Gruvlok<sup>®</sup> Butterfly Valve Fig. 8000GR**



**SERIES 8000GR BUTTERFLY VALVES (Ordering Information)**

SIZE: 14" - 24"

**18" G C - 8 2 8 2 - 6**

Valve Size	Body Style	Body Material	Series	Seat Material	Disc Material	Operator	Stem
14" - 24"	G - Grooved-End	C - Cast iron	8 - 8000	1 - Nitrile 2 - EPDM	0 - Nickel-Plated ductile iron 7 - 316 S.S. 8 - Bronze (Al-Brz)	0 - None 2 - Gear Operator 3 - Pneumatic 4 - Electric 5 - Spring Return Pneumatic 6 - Square Nut (with Gear Operator) 7 - Chain Wheel (with Gear)	6 - 416 S.S. with RTFE Bearing 7 - 316 S.S. with RTFE Bearing

\*Contact your Anvil Representative for Engineering Assistance

NOMINAL SIZE (INCHES)	APRX. WEIGHT (LBS.)		WITH GEAR OPERATOR	BOX QTY.
	VALVE ONLY	W/ GEAR OPERATOR		
14	354	378	\$8,013.17	-
16	428	452	\$11,587.22	-
18	524	548	\$14,253.54	-
20	704	728	\$18,220.96	-
24	10127	1097	\$24,402.27	-

**Gruvlok<sup>®</sup> Ball Valves Fig. 7500**

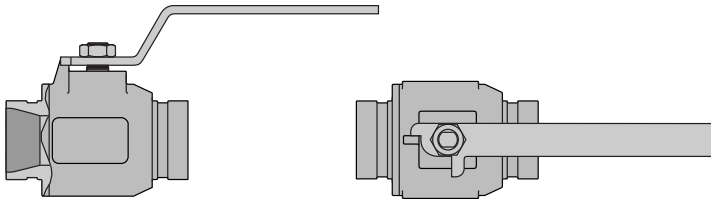

Fig. 7500 Sizes 2" - 4"

**GRUVLOK BALL VALVES SERIES 7500 (Ordering Information)**

SIZE: 2" - 4"

**4" G I - 75 1 2 - 2**

Valve Size	Configuration	Body/End	Series	Ball/Stem	Seat/Seals	Operator
2" - 4"	G - 2 way Grooved End	I - Ductile Iron ASTM A395	75 - 7500	1 - Chrome Plated Carbon Steel 2 - 316 Stainless	2 - RPTFE/Viton	1 - 2 pos. handle 2 - 2 pos. locking handle 3 - Bare Stem

Special Requirements  
X-Write on Order

**DI Body with Carbon Steel Trim**

(Example: GI 7512-2)

NOMINAL SIZE (INCHES)	APRX. WEIGHT EACH (LBS.)	WITH TWO POSITION HANDLE OR WITH TWO POSITION LOCKING HANDLE	BOX QTY.
2	8.00	\$333.59	-
3	18.00	\$1,083.72	-
4	38.00	\$1,673.15	-

**DI Body with Stainless Steel Trim**

(Example: GI 7522-2)

NOMINAL SIZE (INCHES)	APRX. WEIGHT EACH (LBS.)	WITH TWO POSITION HANDLE OR WITH TWO POSITION LOCKING HANDLE	BOX QTY.
2	8.00	\$492.62	-
3	18.00	\$1,519.33	-
4	38.00	\$2,577.73	-

Note: Stainless Steel available. See Stainless Steel Price Sheet for listing price.

## Valves and Accessories

### Bronze Grooved End Ball Valve, Fig. 7500B



Fig. 7500B

Fig. 7500B with  
Stem Extension

NOMINAL SIZE (INCHES)	APRX. WEIGHT EACH (LBS)	PRICE EACH	BOX QTY.
1½	3.50	\$347.39	12
2	4.50	\$482.49	10
2½	8.00	\$670.91	4
3	13.00	\$755.99	2
4	22.00	\$894.05	2

#### STEM EXTENSION KITS

NOMINAL SIZE (INCHES)	APRX. WEIGHT EACH (LBS)	PRICE EACH	BOX QTY.
1½	0.30	\$14.22	50
2	0.40	\$17.72	50
2½ - 4	0.50	\$22.04	25

### Gruvlok<sup>®</sup> Circuit Balancing Valves Sweat Four Turn Fig. GBV-S

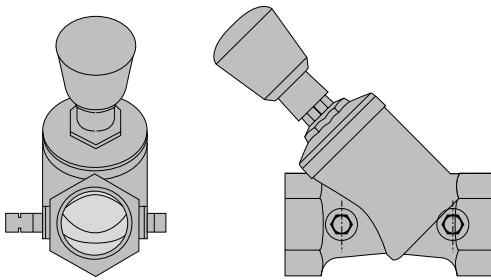

ITEM	APRX. WEIGHT EACH (LBS.)	LIST PRICE	BOX QTY.
½	2.00	\$70.75	10
¾	2.00	\$74.83	10
1	3.00	\$97.71	10
1¼	4.00	\$147.95	10
1½	4.50	\$170.47	10
2	5.50	\$256.38	5

### Grooved end Butterfly Valve, Series 7600

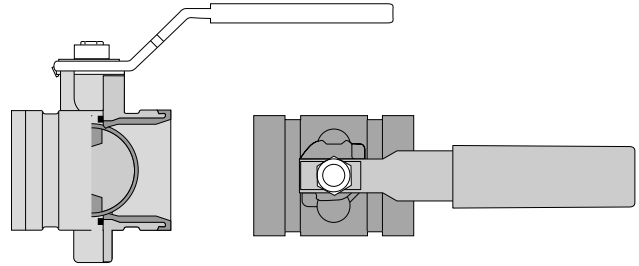

NOMINAL PIPE SIZE (INCHES)	TWO POSITION DETENT HANDLE APRX. WEIGHT EACH (LBS.)	PRICE EACH	BOX QTY.
2	3.30	\$376.78	-
2½	6.40	\$477.86	-
3	6.80	\$540.50	-
4	12.10	\$594.65	-
5	26.10	\$1,135.26	-
6	17.10	\$1,201.14	-

Epoxy coated body with EPDM Grade "E" or Nitrile Grade "T".

### Gruvlok<sup>®</sup> Circuit Balancing Valves Threaded Four Turn Fig. GBV-T

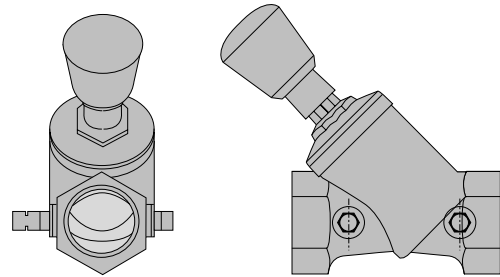

ITEM	APRX. WEIGHT EACH (LBS.)	LIST PRICE	BOX QTY.
½	2.00	\$68.62	10
¾	2.00	\$75.73	10
1	3.00	\$98.88	10
1¼	4.00	\$149.31	10
1½	4.50	\$173.44	5
2	5.50	\$259.34	5

Flanged valve prices available through your Anvil Representative.



**Gruvlok<sup>®</sup> Circuit Balancing Valves**  
**Grooved End Straight GBV-G &**  
**End Angle Fig. GBV-A**

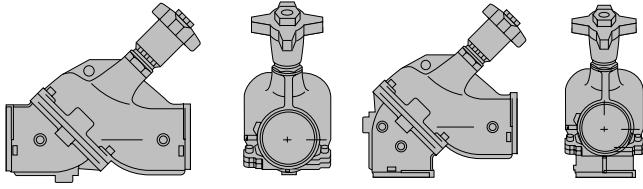

ITEM	APRX. WEIGHT EACH (LBS.)	LIST PRICE	BOX QTY.
2½	25.00	\$566.45	-
3	28.00	\$883.74	-
4	41.00	\$1,222.47	-
5	90.00	\$2,214.53	-
6	130.00	\$2,966.43	-
8	310.00	\$6,322.67	-
10	460.00	\$8,295.80	-
12	870.00	\$18,029.57	-

**Gruvlok<sup>®</sup> End Check Valve,**  
**Fig. 7800**



APPROVED  
For listing/approval details contact your Gruvlok Representative.

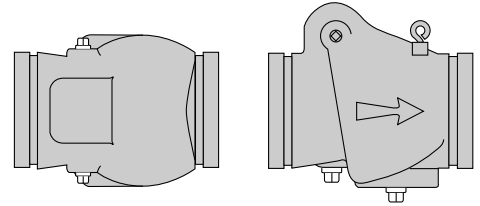

NOMINAL PIPE SIZE (INCHES)	APRX. WEIGHT EACH (LBS.)	LIST PRICE	BOX QTY.
2	7.50	\$408.83	-
2½	10.50	\$408.83	-
3	11.50	\$483.20	-
4	13.50	\$510.45	-
5	19.00	\$849.67	-
6	33.50	\$1,007.27	-
8	59.00	\$1,376.42	-
10	130.00	\$3,981.99	-
12	183.00	\$4,719.08	-

The series 7800 Gruvlok Check Valve come standard with cast ductile iron body, stainless steel seat ring, hinge pin and closure spring. Clapper seat facing of grade "E" EPDM or grade "T" (buna) Elastomer. NPT plugs in the body accommodate valve drain-down.

**Silent Check Valve Fig. 400G**

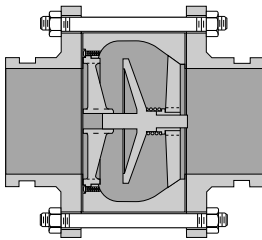

NOMINAL PIPE SIZE (INCHES)	APRX. WEIGHT EACH (LBS.)	LIST PRICE	BOX QTY.
2	12.00	\$667.77	-
2½	15.00	\$811.45	-
3	20.00	\$912.89	-
4	36.00	\$1,208.74	-
5	50.00	\$1,673.62	-
6	68.00	\$2,020.13	-
8	140.00	\$3,448.61	-
10	198.00	\$5,240.62	-

Grooved-End Couplings

Fittings

Valves and Accessories

Spare Parts

Plain-End

Copper Method

Tools

**Suction Diffuser Fig. 7250**

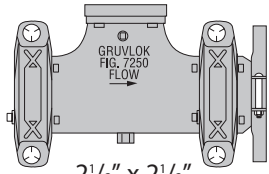

2 1/2" x 2 1/2"  
thru 10" x 8"

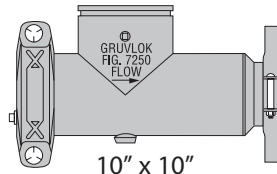

10" x 10"  
thru 16" x 14"

NOMINAL PIPE SIZE (INCHES)	LENGTH (INCHES)	GROOVED END INLET X FLANGE ADAPTER OUT-LET	APRX. WEIGHT EACH (LBS)	PRICE EACH PAINTED	BOX QTY.
2 1/2	x 2 1/2	2 1/2 x 2 1/2	36.00	\$2,020.71	-
	x 2	3 x 2	36.00	\$2,055.45	-
	x 3	3 x 2 1/2	36.00	\$1,477.15	-
3	x 3	3 x 3	37.00	\$1,496.99	-
	x 2	4 x 2	38.00	\$1,538.17	-
	x 2 1/2	4 x 2 1/2	38.00	\$1,623.20	-
4	x 3	4 x 3	38.00	\$1,751.18	-
	x 4	4 x 4	72.00	\$2,027.88	-
	x 4	5 x 4	74.00	\$2,260.74	-
5	x 5	5 x 5	75.00	\$2,375.40	-
	x 3	6 x 3	72.00	\$2,387.84	-
	x 4	6 x 4	72.00	\$2,410.35	-
6	x 5	6 x 5	74.00	\$2,883.18	-
	x 6	6 x 6	133.00	\$3,005.53	-
	x 5*	8 x 5	118.00	\$3,071.01	-
8	x 6	8 x 6	118.00	\$3,238.10	-
	x 8	8 x 8	190.00	\$5,572.30	-
	x 6	10 x 6	100.00	\$5,785.61	-
10	x 8	10 x 8	203.00	\$6,287.48	-
	x 10*	10 x 10	192.00	\$7,576.49	-
	x 8	12 x 8	196.00	\$7,933.19	-
12	x 10*	12 x 10	196.00	\$8,968.02	-
	x 12*	12 x 12	382.00	\$12,473.62	-
	x 10*	14 x 10	382.00	\$11,608.84	-
14	x 12*	14 x 12	382.00	\$12,967.79	-
	x 14*	14 x 14	467.00	\$15,747.57	-
	x 14*	16 x 14	467.00	\$16,207.95	-

\*Fabricated

The Fig. 7250 Gruzlok Suction Diffuser comes standard with type 304 stainless steel diffuser and pre-filter screen, ductile or malleable iron access cap and coupling with Grade "E" EPDM gasket, and plated bolts and nuts. NPT taps and plugs are provided in the body to accommodate drain and gauges.

**Groove x Groove Connectors • Class 150 (AF-21-GG)**

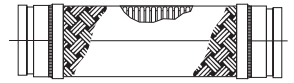

PIPE SIZE (INCHES)	ANVILFLEX AF-21-GG	ANVIL SF-21-GG	PRICE EACH	BOX QTY.
	END TO END (INCHES)	END TO END (INCHES)		
2	12	12	\$200.45	-
2 1/2	12	14	\$242.58	-
3	12	14	\$277.12	-
4	14	16	\$356.69	-
5	16	17	\$558.04	-
6	16	18	\$616.22	-
8	16	20	\$1,178.45	-
10	20	24	\$2,037.25	-
12	20	25	\$2,876.43	-

2 1/2 - 12" have different end to end dimensions.

**Groove x Flange Connectors • Class 150 (AF-21-GF)**



PIPE SIZE (INCHES)	ANVILFLEX AF-21-GF	ANVIL SF-21-GF	PRICE EACH	BOX QTY.
	END TO END (INCHES)	END TO END (INCHES)		
2	12	12	\$213.36	-
2 1/2	12	12	\$265.57	-
3	12	13	\$317.11	-
4	12	13	\$370.62	-
5	14	14	\$589.14	-
6	14	14	\$635.12	-
8	15	15	\$1,160.50	-
10	16	16	\$2,055.32	-
12	17	17	\$2,889.11	-

3" & 4" have different end to end dimensions.

**Flange x Flange Connectors • Class 150 (AF-21-FF)**

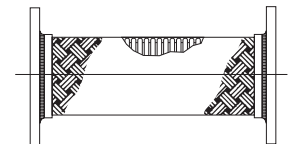

PIPE SIZE (INCHES)	ANVILFLEX AF-21-FF	ANVIL SF-21-FF	PRICE EACH	BOX QTY.
	END TO END (INCHES)	END TO END (INCHES)		
2	9	9	\$220.89	-
2 1/2	9	9	\$270.90	-
3	9	9	\$312.84	-
4	9	9	\$380.16	-
5	11	11	\$583.80	-
6	11	11	\$665.04	-
8	12	12	\$1,394.37	-
10	13	13	\$2,047.85	-
12	14	14	\$2,939.64	-

Reducing and combination flex connectors available. Contact your Anvil Rep.

**Gruvlok Air Vent GAV-15 & GAV-30**

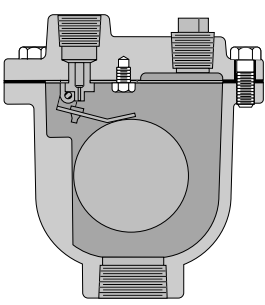

GAV-15

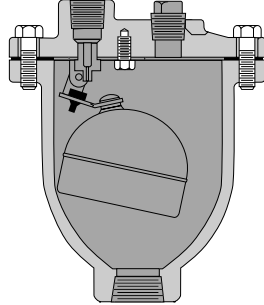

GAV-30

SIZE (INCHES)	PART NUMBER	APRX. WEIGHT EACH (LBS.)	INLET SIZE (INCHES)	PRICE EACH PAINTED	BOX QTY.
1/2	GAV-15	5.50	1/2	\$262.31	-
3/4	GAV-15	5.50	3/4	\$262.31	-
1	GAV-15	5.50	1	\$262.31	-
1/2	GAV-30	8.00	1/2	\$397.63	-
3/4	GAV-30	8.00	3/4	\$397.63	-

**Grooved-End Strainer Fig. 7260**

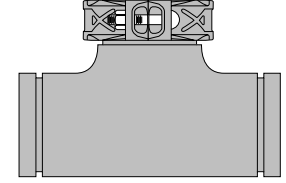
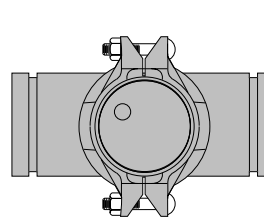

NOMINAL PIPE SIZE (INCHES)	APRX. WEIGHT EACH (LBS.)	PRICE EACH		BOX QTY.
		PAINTED	GALV.	
2	6.00	\$932.91	\$1,094.07	-
2 1/2	8.00	\$980.32	\$1,155.70	-
3	13.00	\$1,100.60	\$1,318.04	-
4	19.00	\$1,246.06	\$1,527.21	-
5	30.00	\$1,804.51	\$2,161.20	-
6	45.00	\$1,958.85	\$2,389.02	-
8	79.00	\$3,002.57	\$3,686.93	-
10	133.00	\$4,409.50	\$5,443.44	-
12	187.00	\$5,676.59	\$6,990.79	-
14	272.00	\$20,230.54	POA	-
16	350.00	\$25,143.67	POA	-
18	400.00	\$33,861.10	POA	-

The Fig. 7260 Gruvlok Strainer comes standard with type 304 stainless steel strainer screen, ductile iron access cap and coupling with Grade "E" EPDM gasket, and plated bolts and nuts. An NPT tap and plugs are provided in the access cap to accommodate a drain or blow-down valve.

Additional sizes available, contact your Anvil Rep. for engineering assistance.

**Grooved-End "WYE" Strainer Fig. 768G**

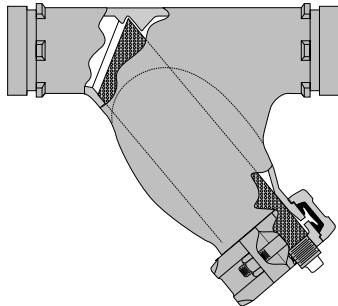

NOMINAL PIPE SIZE (INCHES)	APRX. WEIGHT EACH (LBS.)	PRICE EACH PAINTED	BOX QTY.
2	10.00	\$944.76	-
2 1/2	14.00	\$992.16	-
3	20.00	\$1,114.82	-
4	32.00	\$1,261.47	-
6	72.00	\$1,983.44	-
8	125.00	\$3,040.20	-
10	205.00	\$4,887.06	-
12	280.00	\$8,536.67	-

**Gruvlok Tri-Service Valve Fig. FTV-S (Straight) or Fig. FTV-A (Angle body)**

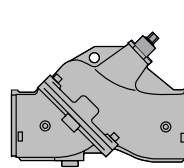

FTV-S (Straight)

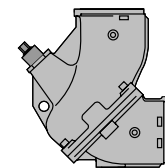
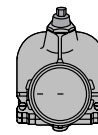

FTV-A (Angle)

NOMINAL PIPE SIZE (INCHES)	APRX. WEIGHT EACH (LBS.)	PRICE EACH	BOX QTY.
2	23.50	\$1,965.14	-
2 1/2	24.00	\$1,991.56	-
3	28.00	\$2,166.23	-
4	41.00	\$2,969.87	-
5	81.00	\$3,250.42	-
6	156.00	\$4,865.38	-
8	300.00	\$7,223.83	-
10	392.00	\$11,931.72	-
12	496.00	\$16,744.65	-

# Clamp-T<sup>®</sup> Outlets

## Mechanical Tee Product Fig. 7045 Clamp-T<sup>®</sup> Female Threaded Outlet



APPROVED  
For listing/approval details contact  
your Gruvlok Representative.

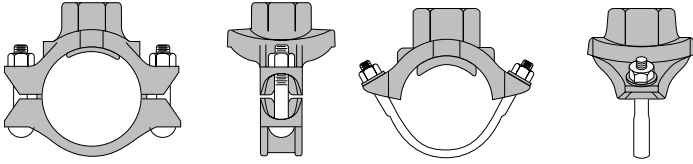

Fig. 7045 (U-Bolt)

NOMINAL PIPE SIZE RUN (INCHES)	OUTLET (INCHES)	APRX. WEIGHT EACH (LBS.)	COMPLETE CLAMP-T FEMALE THREADED OUTLET E OR T GASKET PRICE EACH			*BOLT AND NUT SIZE (INCHES)
			PAINTED	QTY	GALV.	
2	x 1/2**	3.00	\$42.66	-	\$53.62	- 1/2 U-Bolt
	x 3/4**	2.90	\$42.66	-	\$53.62	- 1/2 U-Bolt
	x 1**	2.90	\$42.66	-	\$53.62	- 1/2 U-Bolt
	x 1 1/4**	4.00	\$60.15	-	\$61.33	- 1/2 U-Bolt
	x 1 1/2**	3.90	\$60.15	-	\$61.33	- 1/2 U-Bolt
2 1/2	x 1/2**	3.00	\$42.66	-	\$53.62	- 1/2 U-Bolt
	x 3/4**	2.90	\$42.66	-	\$53.62	- 1/2 U-Bolt
	x 1**	2.90	\$42.66	-	\$53.62	- 1/2 U-Bolt
	x 1 1/4**	3.40	\$60.15	-	\$73.76	- 1/2 U-Bolt
	x 1 1/2**	3.40	\$60.15	-	\$73.76	- 1/2 U-Bolt
3	x 1/2**	2.80	\$49.18	-	\$59.85	- 1/2 U-Bolt
	x 3/4**	2.70	\$49.18	-	\$59.85	- 1/2 U-Bolt
	x 1**	2.70	\$49.18	-	\$59.85	- 1/2 U-Bolt
	x 1 1/4	3.40	\$62.80	-	\$78.81	- 1/2 x 2 3/4
	x 1 1/2	4.40	\$62.80	-	\$78.81	- 1/2 x 2 3/4
	x 2	4.60	\$72.28	-	\$90.35	- 1/2 x 2 3/4
4	x 1/2**	2.90	\$62.22	-	\$74.37	- 1/2 U-Bolt
	x 3/4**	2.80	\$62.22	-	\$74.37	- 1/2 U-Bolt
	x 1**	2.70	\$62.22	-	\$74.37	- 1/2 U-Bolt
	x 1 1/4	4.50	\$73.47	-	\$86.22	- 1/2 x 2 3/4
	x 1 1/2	4.60	\$76.14	-	\$96.28	- 1/2 x 2 3/4
	x 2	5.20	\$76.14	-	\$96.28	- 1/2 x 2 3/4
	x 2 1/2	5.20	\$79.40	-	\$103.99	- 1/2 x 2 3/4
5	x 3	6.50	\$85.03	-	\$109.62	- 1/2 x 3 1/2
	x 1 1/4	5.40	\$75.60	-	\$123.61	- 5/8 x 3 1/4
	x 1 1/2	5.50	\$93.32	-	\$118.80	- 5/8 x 3 1/4
	x 2	5.70	\$93.32	-	\$118.80	- 5/8 x 3 1/4
	x 2 1/2	7.00	\$98.65	-	\$125.91	- 5/8 x 3 1/4
6	x 3	8.70	\$105.17	-	\$135.98	- 5/8 x 3 1/4
	x 1 1/4	7.80	\$77.45	-	\$128.35	- 5/8 x 4 1/4
	x 1 1/2	7.80	\$95.40	-	\$123.24	- 5/8 x 4 1/4
	x 2	7.80	\$95.40	-	\$123.24	- 5/8 x 4 1/4
8	x 2 1/2	8.40	\$103.39	-	\$133.62	- 5/8 x 4 1/4
	x 3	9.60	\$109.91	-	\$141.91	- 5/8 x 4 1/4
	x 4	10.50	\$121.77	-	\$158.79	- 5/8 x 4 1/4

Clamp T's are available with grooved or female threaded outlet with Grade E or Grade T gasket. Weights are approximate and subject to change.

\*All bolts and nuts are of track head design and are zinc plated conforming to

physical properties of ASTM B-633.

\*\* Clamp-T supplied with U-Bolt lower housing.

\*\*\* Note: 8 x 2 is actually 8 x 2 1/2 bushed down.

NOMINAL PIPE SIZE RUN (INCHES)	OUTLET (INCHES)	APRX. WEIGHT EACH (LBS.)	COMPLETE CLAMP-T FEMALE THREADED OUTLET E OR T GASKET PRICE EACH			*BOLT AND NUT SIZE (INCHES)
			PAINTED	QTY	GALV.	
8	x 2***	10.90	\$168.57	-	\$213.31	- 3/4 x 4 1/4
	x 2 1/2	11.10	\$168.57	-	\$213.31	- 3/4 x 4 1/2
	x 3	13.00	\$178.05	-	\$226.04	- 3/4 x 4 1/2
	x 4	16.20	\$183.38	-	\$237.30	- 3/4 x 4 1/2

## Mechanical Tee Product Fig. 7046 Clamp-T<sup>®</sup> Grooved Outlet



APPROVED  
For listing/approval details contact  
your Gruvlok Representative.

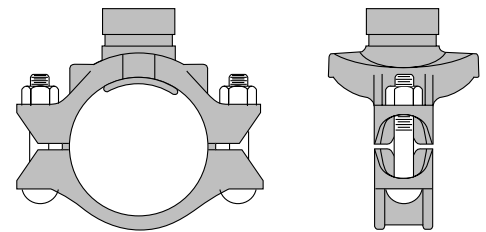

NOMINAL PIPE SIZE RUN (INCHES)	OUTLET (INCHES)	APRX. WEIGHT EACH (LBS.)	COMPLETE CLAMP-T GROOVED BRANCH* E OR T GASKET PRICE EACH			*BOLT AND NUT SIZE (INCHES)
			PAINTED	QTY	GALV.	
2 1/2**	x 1 1/4	3.40	\$60.15	-	\$73.76	- 1/2 U-Bolt
	x 1 1/2	3.40	\$60.15	-	\$73.76	- 1/2 U-Bolt
3	x 1 1/4	3.40	\$62.80	-	\$78.81	- 1/2 x 2 3/4
	x 1 1/2	4.40	\$62.80	-	\$78.81	- 1/2 x 2 3/4
	x 2	4.60	\$72.28	-	\$90.35	- 1/2 x 2 3/4
4	x 1 1/4	4.20	\$73.47	-	\$86.22	- 1/2 x 2 3/4
	x 1 1/2	4.30	\$76.14	-	\$96.28	- 1/2 x 2 3/4
	x 2	4.60	\$76.14	-	\$97.17	- 1/2 x 2 3/4
	x 2 1/2	5.00	\$79.40	-	\$103.99	- 1/2 x 2 3/4
5	x 3	5.60	\$85.03	-	\$109.62	- 1/2 x 3 1/2
	x 1 1/4	5.00	\$88.77	-	\$123.61	- 5/8 x 3 1/4
	x 1 1/2	5.60	\$93.32	-	\$118.80	- 5/8 x 3 1/4
6	x 2	5.50	\$93.32	-	\$118.80	- 5/8 x 3 1/4
	x 2 1/2	5.80	\$98.65	-	\$125.91	- 5/8 x 3 1/4
	x 3	7.10	\$105.17	-	\$135.98	- 5/8 x 3 1/4
	x 1 1/4	7.20	POA	-	POA	- 5/8 x 4 1/4
	x 1 1/2	7.20	\$95.40	-	\$123.24	- 5/8 x 4 1/4
	x 2	7.80	\$95.40	-	\$123.24	- 5/8 x 4 1/4
8	x 2 1/2	7.60	\$103.39	-	\$133.62	- 5/8 x 4 1/4
	x 3	8.00	\$109.91	-	\$141.91	- 5/8 x 4 1/4
	x 4	10.40	\$121.77	-	\$158.79	- 5/8 x 4 1/4
	x 2	10.40	\$168.57	-	\$213.31	- 3/4 x 4 1/4
8	x 2 1/2	10.60	\$168.57	-	\$213.31	- 3/4 x 4 1/2
	x 3	11.50	\$178.05	-	\$226.04	- 3/4 x 4 1/2
	x 4	16.20	\$183.38	-	\$237.30	- 3/4 x 4 1/2

Clamp T's are available with grooved Grade E or Grade T gasket.

Weights are approximate and subject to change.

\*All bolts and nuts are of track head design and are zinc plated conforming to physical properties of ASTM B-633.

\*\* Clamp-T supplied with U-Bolt lower housing.

**Mechanical Tee Product**

**Clamp-T<sup>®</sup> Cross Fig. 7047, Fig. 7048 and Fig. 7049**



APPROVED  
For listing/approval details contact your Gruvlok Representative.

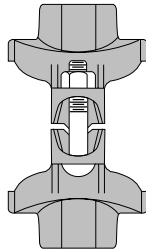
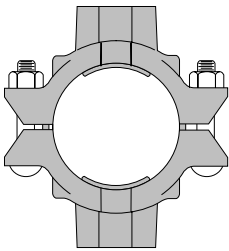

Fig. 7047 – Thread x Thread

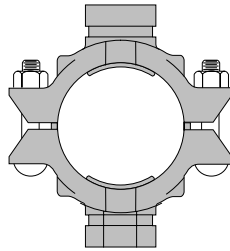

Fig. 7048 – Groove x Groove

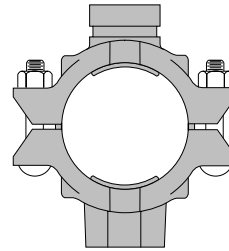
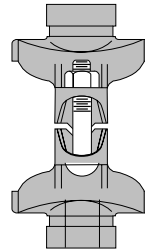
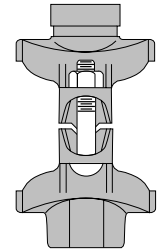

Fig. 7049 – Groove x Thread



NOMINAL PIPE SIZE RUN (INCHES) A	OUTLET (INCHES) B	COMPLETE CLAMP-T CROSS WITH "E" OR "T" GASKET PRICE EACH		BOX QTY.
		PAINTED	GALV.	
2½	1 x 1*	\$67.54	\$87.39	-
	1 x 1¼*	\$93.91	\$121.47	-
	1 x 1½*	\$93.91	\$121.47	-
	1¼ x 1¼*	\$93.91	\$121.47	-
	1½ x 1¼*	\$93.91	\$121.47	-
	1½ x 1½*	\$93.91	\$121.47	-
3	1 x 1*	\$76.14	\$98.65	-
	1 x 1¼	\$93.91	\$117.91	-
	1 x 1½	\$93.91	\$117.91	-
	1 x 2	\$109.56	\$145.81	-
	1¼ x 1¼	\$93.91	\$117.91	-
	1½ x 1¼	\$93.91	\$117.91	-
	1½ x 1½	\$93.91	\$117.91	-
	2 x 1¼	\$109.56	\$145.81	-
4	1 x 1	\$94.22	\$122.06	-
	1 x 1¼	\$110.39	\$152.04	-
	1 x 1½	\$115.31	\$158.61	-
	1 x 2	\$123.30	\$170.82	-
	1¼ x 1¼	\$114.06	\$143.68	-
	1½ x 1¼	\$114.06	\$143.68	-
	1½ x 1½	\$114.06	\$143.68	-
	2 x 1¼	\$114.06	\$144.87	-
	2 x 1½	\$122.06	\$144.87	-
	2 x 2	\$122.06	\$144.87	-
2½ x 2½	\$122.06	\$155.53	-	
3 x 3	\$127.69	\$164.72	-	

NOMINAL PIPE SIZE RUN (INCHES) A	OUTLET (INCHES) B	COMPLETE CLAMP-T CROSS WITH "E" OR "T" GASKET PRICE EACH		BOX QTY.
		PAINTED	GALV.	
5	1½ x 1½	\$139.54	\$178.05	-
	2 x 1½	\$139.54	\$178.05	-
	2 x 2	\$139.54	\$178.05	-
	2½ x 1½	\$149.14	\$203.47	-
	2½ x 2	\$149.14	\$203.47	-
	2½ x 2½	\$147.54	\$189.02	-
	3 x 1½	\$159.51	\$219.18	-
	3 x 2	\$159.51	\$219.18	-
6	3 x 2½	\$159.51	\$219.18	-
	3 x 3	\$157.91	\$203.23	-
	1½ x 1½	\$144.63	\$199.09	-
	2 x 1½	\$143.10	\$184.57	-
	2 x 2	\$144.63	\$199.09	-
	2½ x 2½	\$154.95	\$199.68	-
	3 x 2½	\$164.43	\$212.12	-
8	3 x 3	\$164.43	\$212.12	-
	4 x 2½	\$184.10	\$256.50	-
	4 x 3	\$184.10	\$256.50	-
	4 x 4	\$181.90	\$237.60	-
	2½ x 2½	\$252.41	\$319.37	-
	3 x 2½	\$269.77	\$365.70	-
	3 x 3	\$266.34	\$338.91	-
	4 x 2½	\$277.47	\$384.19	-
4 x 3	\$277.47	\$384.19	-	
4 x 4	\$274.92	\$355.81	-	

\*Available with Female Threaded outlet only.  
Always specify gasket grade when ordering.

Grooved-End Couplings  
Fittings  
Valves and Accessories  
Spare Parts  
Plain-End  
Copper Method  
Tools

# Adapter Flanges

## Flange Nipples, Fig. 7084 (150 lb) & Fig. 7085 (300 lb)

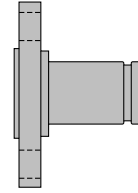

SIZE (INCHES)	END TO END (INCHES)	FIG. 7084 (150 LB) PRICE EACH		FIG. 7085 (300 LB) PRICE EACH		BOX QTY.
		PAINTED	GALV.	PAINTED	GALV.	
1	x 3	\$187.83	\$296.86	\$216.27	\$292.36	-
1¼	x 4	\$187.83	\$296.86	\$216.27	\$292.36	-
1½	x 4	\$187.83	\$296.86	\$216.27	\$254.55	-
2	x 4	\$187.83	\$296.86	\$231.08	\$271.37	-
2½	x 4	\$198.50	\$325.00	\$231.08	\$271.37	-
3	x 4	\$385.43	\$458.61	\$320.25	\$406.18	-
3½	x 4	\$263.08	\$349.35	POA	POA	-
4	x 6	\$439.94	\$641.10	\$605.25	\$692.95	-
5	x 6	\$608.81	\$844.03	\$619.48	\$636.65	-
6	x 6	\$619.48	\$855.59	\$619.48	\$936.47	-
8	x 6	\$767.31	\$1,143.26	\$1,268.87	\$1,509.14	-
10	x 8	\$1,204.59	\$1,806.28	\$1,633.56	\$1,923.60	-
12	x 8	\$1,575.20	\$2,382.20	\$2,451.83	\$2,887.92	-
14	x 8	\$2,902.44	POA	POA	POA	-
16	x 8	\$4,083.91	POA	POA	POA	-
18	x 8	POA	POA	POA	POA	-
20	x 8	POA	POA	POA	POA	-
24	x 8	POA	POA	POA	POA	-

Flange by concentric reducer configurations also available.  
 Contact your Anvil Rep. for more dimensions and weights or additional details.

## Spare Parts

### Flange Parts for Gruvlok Flange Fig. 7012

FLANGE SIZE (INCHES)	QTY. PER SET	MATING FLANGE BOLT AND NUT SIZE (INCHES)	PRICE PER SET PLATED	SEAL RING FIG. 7012	BOX QTY.
2	4	5/8 x 2¾	\$35.20	\$47.93	4
2½	4	5/8 x 2¾	\$35.20	\$49.95	4
3	4	5/8 x 2¾	\$35.20	\$59.01	4
4	8	5/8 x 2¾	\$70.16	\$68.97	8
5	8	¾ x 2⅞	\$75.49	\$84.13	8
6	8	¾ x 3⅛	\$75.49	\$95.52	8
8	8	¾ x 3¼	\$75.49	\$121.23	8
10	12	7/8 x 3½	\$171.24	\$168.87	12
12	12	7/8 x 3¾	\$171.24	\$218.46	12
14	12	1 x 4¼	\$285.24	\$238.31	12
16	16	1 x 4¼	\$380.81	\$424.54	16
18	16	1⅛ x 4¾	\$572.18	\$452.34	16
20	20	1⅛ x 4¾	\$732.29	\$519.51	20
24	20	1¼ x 5½	\$912.12	\$872.31	20

Note: items listed are non-cancellable and non-returnable

### Flange Parts for Gruvlok Flange Fig. 7013

FLANGE SIZE (INCHES)	QTY. PER SET	MATING FLANGE BOLT AND NUT SIZE (INCHES)	PRICE PER SET PLATED	SEAL RING FIG. 7013	BOX QTY.
2	8	5/8 x 3	\$35.20	\$48.17	8
2½	8	¾ x 3¼	\$35.20	\$49.95	8
3	8	¾ x 3½	\$35.20	\$59.01	8
4	8	¾ x 3¾	\$70.16	\$68.97	8
5	8	¾ x 4½	\$75.49	\$84.13	8
6	12	¾ x 4½	\$75.49	\$95.52	12
8	12	7/8 x 4¾	\$75.49	\$121.23	12
10	16	1 x 5	\$171.24	\$168.87	16
12	16	1⅛ x 5¾	\$171.24	\$218.46	16

**Flange Gaskets for Fig. 7012 & 7013 Gruvlok Flanges**

FLANGE SIZE (INCHES)	STANDARD GASKETS GRADE "E" OR "T" GASKET ONLY	BOX QTY.
2	\$18.07	-
2½	\$19.85	-
3	\$21.92	-
4	\$28.14	-
5	\$34.96	-
6	\$40.29	-
8	\$42.71	-
10	\$55.27	-
12	\$64.23	-
14	\$85.08	-
16	\$95.16	-
18	\$139.30	-
20	\$150.74	-
24	\$167.32	-

Note: items listed are non-cancellable and non-returnable.

**Standard Gaskets for Fig. 7005 & 7305 Couplings**

NOMINAL SIZE (INCHES)	STANDARD GASKETS GRADE "E" OR "T" GASKET ONLY	BOX QTY.
2	\$22.23	-
2½	\$23.40	-
3	\$25.78	-
4	\$38.21	-
5	\$45.33	-
6	\$55.11	-
8	\$72.58	-
10	\$93.03	-
12	\$113.46	-

**Fig. 7004EG Gasket (Use with 7004EG Housing)**

NOMINAL SIZE (INCHES)	EG GASKET GASKET ONLY	BOX QTY.
2	\$32.89	-
2½	\$40.59	-
3	\$40.59	-
4	\$54.81	-
6	\$99.84	-
8	\$104.28	-
10	\$134.20	-
12	\$159.98	-

Note: items listed are non-cancellable and non-returnable.

**Plated Trackhead Bolts and Nuts for Couplings**

BOLT AND NUT		
SIZE (INCHES)	PRICE EACH	BOX QTY.
¾ x 2¼	\$6.58	-
¾ x 2½	\$9.96	-
½ x 2¾	\$7.17	-
½ x 3	\$7.05	-
½ x 3½	\$10.72	-
⅝ x 2¾	\$8.59	-
⅝ x 3¼	\$9.13	-
⅝ x 3½	\$9.60	-
⅝ x 4¼	\$12.51	-
¾ x 4½	\$10.43	-
⅞ x 5	\$19.73	-
⅞ x 5½	\$23.52	-
⅞ x 6	\$17.49	-
1 x 5½	\$25.96	-
1 x 6	\$25.96	-
1 x 6½	\$27.19	-
1⅛ x 5½	\$35.67	-

Note: items listed are non-cancellable and non-returnable.

**Standard Gaskets**

NOMINAL SIZE (INCHES)	GRADE "E" EPDM OR GRADE "T" NITRILE	FLUSH SEAL GRADE "E"	GRADE "L" SILICONE	GRADE "O" FLUOROELASTOMER
1	\$15.40	\$30.52	\$58.07	\$194.94
1¼	\$15.40	\$32.00	\$84.32	\$186.34
1½	\$16.01	\$32.29	\$88.11	\$197.32
2	\$17.19	\$32.89	\$53.81	\$160.87
2½	\$20.75	\$40.59	\$62.51	\$181.90
3	\$22.52	\$40.59	\$67.67	\$201.16
4	\$28.14	\$54.81	\$98.72	\$330.62
5	\$28.14	\$98.36	\$196.24	\$354.33
6	\$39.99	\$99.84	\$215.02	\$434.32
8	\$54.51	\$104.28	\$229.48	\$485.86
10	\$69.92	\$134.20	\$299.64	\$648.22
12	\$81.18	\$159.98	\$353.73	\$960.77
14	\$112.00	\$167.38	-	-
16	\$154.66	-	-	-
18	\$186.65	-	-	-
20	\$287.07	-	-	-
22	POA	-	-	-
24	\$398.17	-	-	-

Note: items listed are non-cancellable and non-returnable.

**Reducing Coupling Fig. 7010 Loose Gasket**

NOMINAL PIPE SIZE (INCHES)	SPARE PARTS "E" OR "T" GASKET ONLY	BOX QTY.
2 x 1½	\$16.01	-
2½ x 2	\$21.04	-
3 x 2	\$24.88	-
3 x 2½	\$24.88	-
4 x 2	\$28.44	-
4 x 2½	\$28.74	-
4 x 3	\$30.23	-
5 x 4	\$35.26	-
6 x 4	\$40.29	-
6 x 5	\$43.85	-
8 x 6	\$48.59	-

**Clamp-T<sup>®</sup> Female Threaded Outlet**  
**Fig. 7045 (Gasket only)**

NOMINAL PIPE SIZE RUN (INCHES)	OUTLET (INCHES)	"E" OR "T" GASKET ONLY PRICE EACH	BOX QTY.
2	x 1/2	\$6.52	-
	x 3/4	\$6.52	-
	x 1	\$6.52	-
	x 1 1/4	\$8.00	-
	x 1 1/2	\$8.00	-
2 1/2	x 1/2	\$6.52	-
	x 3/4	\$6.52	-
	x 1	\$6.52	-
	x 1 1/4	\$8.00	-
	x 1 1/2	\$8.00	-
3	x 1/2	\$6.52	-
	x 3/4	\$6.52	-
	x 1	\$6.52	-
	x 1 1/4	\$8.00	-
	x 1 1/2	\$8.00	-
4	x 1/2	\$6.52	-
	x 3/4	\$6.52	-
	x 1	\$6.52	-
	x 1 1/4	\$8.00	-
	x 1 1/2	\$8.00	-

NOMINAL PIPE SIZE RUN (INCHES)	OUTLET (INCHES)	"E" OR "T" GASKET ONLY PRICE EACH	BOX QTY.
5	x 1 1/4	\$8.00	-
	x 1 1/2	\$8.00	-
	x 2	\$8.00	-
	x 2 1/2	\$9.19	-
	x 3	\$10.37	-
6	x 1 1/4	\$8.00	-
	x 1 1/2	\$8.00	-
	x 2	\$8.00	-
	x 2 1/2	\$9.19	-
	x 3	\$10.37	-
8	x 2	\$9.48	-
	x 2 1/2	\$9.48	-
	x 3	\$10.37	-
	x 4	\$14.22	-

**Clamp-T<sup>®</sup> Grooved Outlets**  
**Fig. 7046 Tee with Grooved Outlet**

NOMINAL PIPE SIZE RUN (INCHES)	OUTLET (INCHES)	"E" OR "T" GASKET ONLY PRICE EACH	BOX QTY.
2 1/2	x 1 1/4	\$8.00	-
	x 1 1/2	\$8.00	-
3	x 1 1/4	\$8.00	-
	x 1 1/2	\$8.00	-
4	x 2	\$8.00	-
	x 1 1/4	\$8.00	-
	x 1 1/2	\$8.00	-
	x 2	\$8.00	-
	x 2 1/2	\$9.19	-
5	x 3	\$10.37	-
	x 1 1/4	\$8.00	-
	x 1 1/2	\$8.00	-
	x 2	\$8.00	-
	x 2 1/2	\$9.19	-
6	x 3	\$10.37	-
	x 2	\$8.00	-
	x 2 1/2	\$9.19	-
	x 3	\$10.37	-
	x 4	\$14.22	-
8	x 2	\$9.48	-
	x 2 1/2	\$9.48	-
	x 3	\$10.37	-
	x 4	\$14.22	-

**Roughneck<sup>™</sup> Plain-End Products**
**Plain-End Coupling Roughneck<sup>™</sup> Coupling Fig. 7005**

NOMINAL PIPE SIZE (INCHES)	PIPE OUTSIDE DIAMETER (INCHES)	APRX. WEIGHT EACH (LBS.)	COUPLING COMPLETE W/ "E" OR "T" GASKET PRICE EACH		BOX QTY.	PLATED BOLT AND NUT SIZE (INCHES)
			PAINTED	GALV.		
2	2.375	5.30	\$93.32	\$121.47	-	5/8 x 3 1/4
2 1/2	2.875	5.70	\$93.32	\$121.47	-	5/8 x 3 1/4
3	3.500	8.70	\$137.46	\$180.41	-	3/4 x 4 1/2
4	4.500	12.80	\$159.08	\$212.12	-	3/4 x 4 1/2
5	5.563	17.30	\$226.94	\$302.18	-	7/8 x 5
6	6.625	23.20	\$277.00	\$377.44	-	1 x 6
8	8.625	37.20	\$490.60	\$656.80	-	7/8 x 5
10	10.750	48.20	\$637.84	\$855.59	-	1 x 6 1/2
12	12.750	60.00	\$800.19	\$1,104.16	-	1 x 6 1/2
14	14.000	88.00	\$1,136.44	\$1,475.06	-	1 x 6 1/2
16	16.000	95.00	\$1,555.65	\$1,985.82	-	1 x 6 1/2

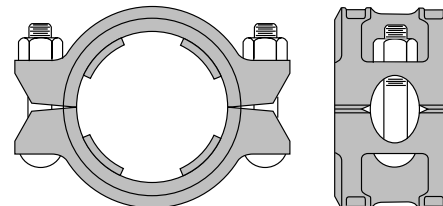

All bolts are oval-neck track head design to ASTM A-183, with heavy hex nuts to ASTM A-563, and are zinc plated to ASTM B-633. Weights are approximate and subject to change. Plain End Fittings are manufactured from fabricated steel. Other sizes available. Priced on application.



## Advanced Copper System

### Rigidlite<sup>®</sup> 300 PSI Coupling Fig. 7400

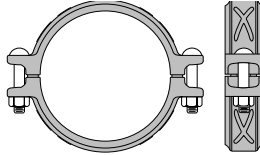

NOMINAL PIPE SIZE (INCHES)	PIPE OUTSIDE DIAMETER (INCHES)	APRX. WEIGHT EACH (LBS.)	COUPLING COMPLETE WITH "E" GASKET (PRICE EACH) PAINTED	BOX QTY.	PLATED BOLT AND NUT SIZE (INCHES)
2	2.375	1.60	\$28.57	-	3/8 x 2 1/4
2 1/2	2.875	1.90	\$32.41	-	3/8 x 2 1/4
3	3.500	2.10	\$37.27	-	3/8 x 2 3/4
4	4.500	3.10	\$52.67	-	3/8 x 2 3/4
5	5.563	4.60	\$77.32	-	1/2 x 3
6	6.625	5.50	\$94.56	-	1/2 x 3
8	8.625	8.40	\$148.42	-	1/2 x 3

All bolts are oval-neck track head design to ASTM A-183, with heavy hex nuts to ASTM A-563, and are zinc plated to ASTM B-633. Weights are approximate and subject to change. Two bolts per coupling.

### Gruvlok Flange Fig. 7012

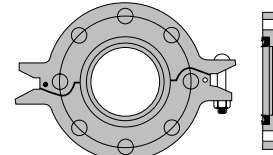

NOMINAL PIPE SIZE HINGED (INCHES)	PIPE OUTSIDE DIAMETER (INCHES)	APRX. WEIGHT EACH (LBS.)	COUPLING COMPLETE WITH "E" GASKET (PRICE EACH) PAINTED	BOX QTY.
2*	2.375	4.60	\$147.24	-
2 1/2*	2.875	6.20	\$182.79	-
3*	3.500	6.60	\$197.32	-
4*	4.500	9.30	\$264.27	-
5*	5.563	10.20	\$306.93	-
6*	6.625	12.00	\$334.78	-
8*	8.625	15.60	\$378.02	-

The Gruvlok Flange bolt hole pattern conforms to Class 150 steel and Class 125 cast iron flanges utilizing standard flange bolts.

Grade "E" Gasket recommended with copper piping.

\*Available with pn 10/16 bolt hole patterns.

Flange Sealing Rings are recommended for use between wafer/lug type valves and Gruvlok Flanges.

For applications with wafer valves a latch bolt is recommended on both sides of the flange. (request extra latch bolt) Use: 3/8 x 2 1/2 for 2"-6", 1/2 x 3 1/2 for 8"-12" sizes.

### 90° Elbows Fig. 7550

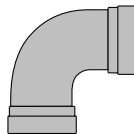

NOMINAL PIPE SIZE (INCHES)	APRX. WEIGHT EACH (LBS.)	PRICE EACH	BOX QTY.
2	0.90	\$49.75	8
2 1/2	1.50	\$54.00	3
3	2.40	\$76.00	3
4	5.50	\$176.25	1
5	9.30	\$502.00	1
6	17.60	\$801.75	1
8	29.40	\$1,506.50	-

8" fittings are copper coated stainless steel.

### 45° Elbows Fig. 7551

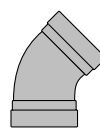

NOMINAL PIPE SIZE (INCHES)	APRX. WEIGHT EACH (LBS.)	PRICE EACH	BOX QTY.
2	0.60	\$49.75	10
2 1/2	1.10	\$54.00	5
3	1.60	\$76.00	3
4	3.50	\$172.25	1
5	6.10	\$502.00	1
6	11.70	\$801.75	2
8	19.40	\$1,506.50	-

8" fittings are copper coated stainless steel.

### Tee Fig. 7560

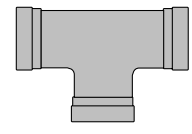

NOMINAL PIPE SIZE (INCHES)	APRX. WEIGHT EACH (LBS.)	PRICE EACH	BOX QTY.
2	1.70	\$82.50	5
2 1/2	2.50	\$87.75	1
3	3.50	\$130.75	2
4	7.30	\$288.00	1
5	7.90	\$809.00	1
6	13.40	\$1,000.00	1
8	41.70	\$1,786.75	-

8" fittings are copper coated stainless steel.

**Copper Reducing Tee Fig. 7561A**

  
For listing details contact your Gruvlok Representative.

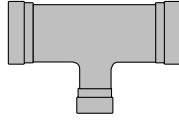

NOMINAL PIPE SIZE (INCHES)		APRX. WEIGHT EACH (LBS.)	PRICE EACH	BOX QTY.
2½ x 2½	x 2	1.95	\$131.25	10
3 x 3	x 2	3.00	\$169.00	8
	x 2½	3.10	\$223.00	8
4 x 4	x 2	5.50	\$379.25	3
	x 2½	5.60	\$379.25	3
	x 3	5.80	\$379.25	3
5 x 5	x 3	7.50	\$1,159.75	-
	x 4	7.80	\$1,159.75	-
6 x 6	x 2½	13.00	\$1,416.50	1
	x 3	13.50	\$1,416.50	1
8 x 8	x 4	14.00	\$1,416.50	1
	x 2½	-	POA	-
	x 3	18.20	POA	-
	x 4	-	POA	-
	x 5	-	POA	-
	x 6	-	POA	-

NOTE: Use Fig. 7400 Rigidlite coupling for the Gruvlok Advanced Copper System. Gruvlok copper fittings are WROT or fabricated copper. Contact Anvil for material specification.

\* Fittings are copper electroplated 316 SS. Additional sizes available, Contact Anvil for details.

**Copper Reducing Tee Fig. 7564A  
Gr x Gr x Cup**

  
For listing details contact your Gruvlok Representative.

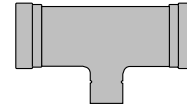

NOMINAL PIPE SIZE (INCHES)		APRX. WEIGHT EACH (LBS.)	PRICE EACH	BOX QTY.
2 x 2	x ¾	1.05	\$105.50	18
	x 1	1.10	\$105.50	18
	x 1¼	1.15	\$105.50	18
	x 1½	1.20	\$105.50	18
2½ x 2½	x ¾	1.80	\$135.00	10
	x 1	1.85	\$131.50	10
	x 1¼	1.90	\$131.50	10
	x 1½	1.95	\$131.50	10
3 x 3	x 2	2.00	\$144.14	10
	x 1	2.75	\$244.00	8
	x 1¼	2.80	\$244.00	8
	x 1½	2.90	\$244.00	8
4 x 4	x 2	2.95	\$244.00	8
	x ¾	5.10	\$288.50	3
	x 1	5.20	\$379.25	3
	x 1¼	5.30	\$379.25	3
	x 1½	5.40	\$379.25	3
	x 2	5.50	\$379.25	3

NOTE: Use Fig. 7400 Rigidlite coupling for the Gruvlok Advanced Copper System. Additional sizes available, Contact Anvil for details.

**Concentric Reducers Fig. 7572 (Gr x Gr)**

  
For listing details contact your Gruvlok Representative.

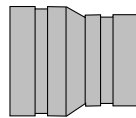

NOMINAL SIZE X BRANCH (INCHES)	OUTLET (INCHES)	END TO END (INCHES.)	APRX. WEIGHT EACH (LBS.)	PRICE EACH	BOX QTY.
2½	x 2	3.13	0.60	\$71.75	5
3	x 2	3.38	1.00	\$71.75	2
	x 2½	3.13	0.90	\$71.75	2
4	x 2	3.88	2.20	\$148.25	2
	x 2½	3.63	2.00	\$148.25	4
5	x 3	3.38	2.00	\$148.25	4
	x 4	3.88	2.80	\$419.50	2
6	x 3	3.38	3.30	\$419.50	2
	x 4	4.38	4.90	\$454.00	1
8	x 4	3.88	4.80	\$454.00	1
	x 5	3.38	5.20	\$454.00	-
	x 6	5.00	10.00	\$798.25	-

**Cap Fig. 7574**

  
For listing details contact your Gruvlok Representative.

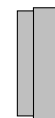

NOMINAL PIPE SIZE (INCHES)	APRX. WEIGHT EACH (LBS.)	PRICE EACH	BOX QTY.
2	1.20	\$34.00	10
2½	1.40	\$50.54	5
3	1.40	\$63.75	5
4	2.40	\$95.75	1
5	3.50	\$108.50	-
6	4.20	\$197.25	-
8	7.50	POA	-

8" fittings are copper coated stainless steel.

**Reducing Adapters Fig. 7575**  
(Gr. x Cup)



For listing details contact your Gruvlok Representative.

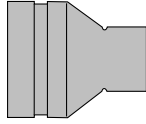

NOMINAL SIZE X BRANCH (INCHES)	OUTLET (INCHES)	END TO END (INCHES.)	CUP (INCHES)	APRX. WEIGHT EACH (LBS.)	PRICE EACH	BOX QTY.
2	x 1	2.70	0.91	0.40	\$59.50	10
	x 1¼	3.00	0.97	0.40	\$59.50	10
	x 1½	2.94	1.09	0.40	\$59.50	10
2½	x 1	3.25	0.91	0.60	\$73.00	5
	x 1¼	3.52	0.97	0.60	\$73.00	5
	x 1½	3.45	1.09	0.70	\$73.00	5
	x 2	3.30	1.34	0.70	\$73.00	5
3	x 1½	3.68	1.09	1.10	\$90.50	2
	x 2	4.10	1.34	1.00	\$90.50	2
4	x 2	4.75	1.34	2.20	\$169.50	2

**Transition Fitting Fig. 7582**  
(Cup x Gr.)



For listing details contact your Gruvlok Representative.

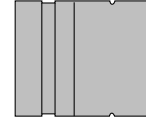

NOMINAL PIPE SIZE (INCHES)	APRX. WEIGHT EACH (LBS.)	PRICE EACH	BOX QTY.
2	0.40	\$22.33	5
2½	0.60	\$47.84	5
4	1.00	\$64.25	2
5	2.00	\$144.14	1
6	3.30	\$345.47	1
8	5.30	\$428.79	1

**DI-LOK<sup>®</sup> DI-Electric Nipple**  
Fig. 7088 (Gr. x Th.)

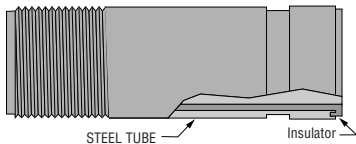

PIPE SIZE (INCHES)	NOMINAL LENGTH (INCHES)	APRX. WEIGHT EACH (LBS.)	PRICE EACH	BOX QTY.
1¼	4	0.6	\$77.50	-
1½	4	0.8	\$99.31	-
2	4	1.0	\$60.67	12
2½	6	1.6	\$83.13	-
3	6	2.0	\$150.74	-
4	6	4.5	\$202.59	6

**DI-LOK<sup>®</sup> DI-Electric Nipple**  
Fig. 7089 (Gr. x Gr.)

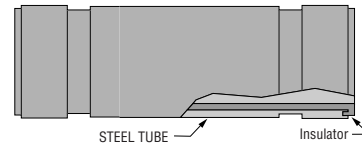

PIPE SIZE (INCHES)	NOMINAL LENGTH (INCHES)	APRX. WEIGHT EACH (LBS.)	PRICE EACH	BOX QTY.
2	4	1.00	\$60.67	-
2½	6	1.60	\$83.13	-
3	6	2.00	\$150.74	-
4	6	4.50	\$202.59	-
5	6	7.30	\$319.37	-
6	6	9.50	\$399.48	-

Grooved-End Couplings

Fittings

Valves and Accessories

Spare Parts

Plain-End

Copper Method

Tools

**DI-LOK<sup>®</sup> DI-Electric Nipple**  
**Fig. 7090 (Th. x Th.)**



PIPE SIZE (INCHES)	NOMINAL LENGTH (INCHES)	APRX. WEIGHT EACH (LBS.)	PRICE EACH	BOX QTY.
1/2	3	0.2	\$28.86	-
3/4	3	0.2	\$19.73	20
1	4	0.4	\$30.46	25
1 1/4	4	0.6	\$44.20	10
1 1/2	4	0.8	\$53.45	10
2	4	1.0	\$127.40	12
2 1/2	6	1.6	\$174.20	-
3	6	2.0	\$223.31	-

**Bronze Grooved End Ball Valve,**  
**Fig. 7500B**



Fig. 7500B

Fig. 7500B with Stem Extension

NOMINAL SIZE (INCHES)	APRX. WEIGHT EACH (LBS)	PRICE EACH	BOX QTY.
1 1/2	3.50	\$347.39	12
2	4.50	\$482.49	10
2 1/2	8.00	\$670.91	4
3	13.00	\$755.99	2
4	22.00	\$894.05	2

**STEM EXTENSION KITS**

NOMINAL SIZE (INCHES)	APRX. WEIGHT EACH (LBS)	PRICE EACH	BOX QTY.
1 1/2	0.30	\$14.22	50
2	0.40	\$17.72	50
2 1/2 - 4	0.50	\$22.04	25

Grooved-End Couplings

Fittings

Valves and Accessories

Spare Parts

Plain-End

Copper Method

Tools

## Roll Groovers

### Model 1007/3007 Roll Groover

ITEM	SHIPPING WEIGHT (LBS.)	PRICE	BOX QTY.	INCLUDES
1007 Roll Groover	550.00	\$17,501.46	-	Motorized Roll Groover with 2" - 12" Steel Rolls Closed Wood Crate
3007 Roll Groover	330.00	\$11,946.04	-	For Ridgid <sup>®</sup> 300 Power Drive Support Legs 2" - 12" Steel Closed Wood Crate
Options: Copper 2" - 6"	1.00	\$2,986.47	-	2" - 6" Copper Rolls M&L Guide Roll Assembly Universal Diameter Gauge
Copper "K" Plate	-	\$505.29	-	
Copper "DWV" Plate	-	\$505.29	-	
Universal Diameter Gauge	-	\$856.38	-	
14" - 16" Rolls	-	\$2,063.94	-	14" - 16" Steel Rolls Guide Roll Assembly

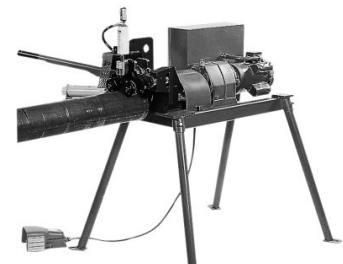

Fig. 1007



Fig. 3007

### Model 3006 (Steel Roll Groover) – for Ridgid<sup>®</sup> 300 Power Drive

ITEM	SHIPPING WEIGHT (LBS.)	PRICE	BOX QTY.	INCLUDES
3006 Roll Groover	170.00	\$7,546.63	-	2" - 12" Steel Rolls Hydraulic Pressure Gauge Support Legs Closed Wood Crate (1 set) Depth Gauges — 1" - 12"
Copper 2" - 6"	-	\$2,575.53	-	2" - 6" Copper Rolls M&L Guide Roll Assembly for M&L, K & DWV Pipe Universal Diameter Gauge
Universal Diameter Gauge	1.00	\$856.38	-	

### Model 3006 (Copper Roll Groover) – for Ridgid<sup>®</sup> 300 Power Drive

ITEM	SHIPPING WEIGHT (LBS.)	PRICE	BOX QTY.	INCLUDES
3006 Roll Copper	170.00	\$7,801.43	-	2" - 12" Copper Rolls Hydraulic Pressure Gauge Support Legs Guide Roll Assembly for M&L, K & DWV Pipe Universal Diameter Gauge Closed Wood Crate
2" - 12" Steel Rolls	-	\$2,320.74	-	Guide Roll Assembly for M&L, K & DWV Pipe
Universal Diameter Gauge	1.00	\$856.38	-	

For information regarding additional custom grooving tools, contact Anvil.

Grooved-End Couplings

Fittings

Valves and Accessories

Spare Parts

Plain-End

Copper Method

Tools

## Expansion Joints for Grooved-End Pipe

Fig. 7240 Expansion Joints

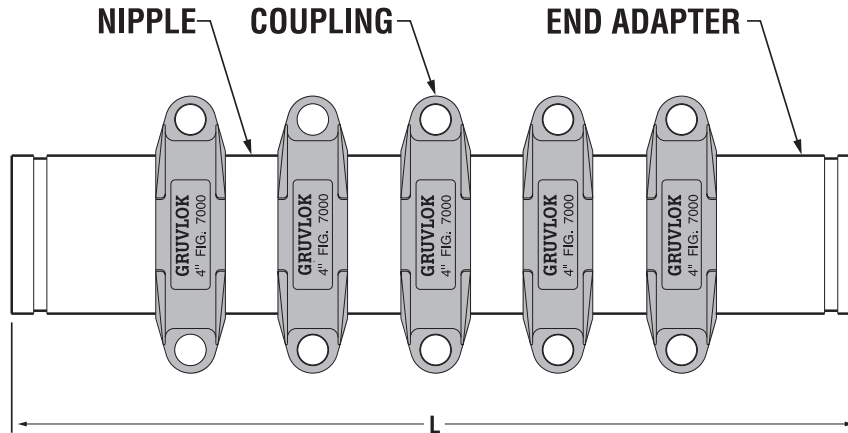

PERFORMANCE DATA (Inches)									
Pipe Size	Nominal Pipe O.D.	Coupling Figure	X	Y	Compressed Length L	Expanded Length L	Coupling Movement Capability	Number of Couplings	Total Movement Capability
2	2.375	7000	3 <sup>1</sup> / <sub>2</sub>	5 <sup>1</sup> / <sub>2</sub>	30	31 <sup>1</sup> / <sub>4</sub>	<sup>1</sup> / <sub>8</sub>	10	1 <sup>1</sup> / <sub>4</sub>
2 <sup>1</sup> / <sub>2</sub>	2.875	7000	4	5 <sup>3</sup> / <sub>4</sub>	30	31 <sup>1</sup> / <sub>4</sub>	<sup>1</sup> / <sub>8</sub>	10	1 <sup>1</sup> / <sub>4</sub>
3	3.500	7000	4 <sup>5</sup> / <sub>8</sub>	6 <sup>3</sup> / <sub>4</sub>	30	31 <sup>1</sup> / <sub>4</sub>	<sup>1</sup> / <sub>8</sub>	10	1 <sup>1</sup> / <sub>4</sub>
4	4.500	7000	5 <sup>7</sup> / <sub>8</sub>	8 <sup>1</sup> / <sub>8</sub>	17 <sup>1</sup> / <sub>2</sub>	18 <sup>3</sup> / <sub>4</sub>	<sup>1</sup> / <sub>4</sub>	5	1 <sup>1</sup> / <sub>4</sub>
5	5.562	7000	7	9 <sup>5</sup> / <sub>8</sub>	19	20 <sup>1</sup> / <sub>4</sub>	<sup>1</sup> / <sub>4</sub>	5	1 <sup>1</sup> / <sub>4</sub>
6	6.625	7000	8	11	19	20 <sup>1</sup> / <sub>4</sub>	<sup>1</sup> / <sub>4</sub>	5	1 <sup>1</sup> / <sub>4</sub>
8	8.625	7000	10 <sup>3</sup> / <sub>8</sub>	13 <sup>1</sup> / <sub>4</sub>	22 <sup>1</sup> / <sub>2</sub>	23 <sup>3</sup> / <sub>4</sub>	<sup>1</sup> / <sub>4</sub>	5	1 <sup>1</sup> / <sub>4</sub>
10	10.750	7001	12 <sup>7</sup> / <sub>8</sub>	17 <sup>1</sup> / <sub>2</sub>	23 <sup>1</sup> / <sub>2</sub>	24 <sup>3</sup> / <sub>4</sub>	<sup>1</sup> / <sub>4</sub>	5	1 <sup>1</sup> / <sub>4</sub>
12	12.750	7001	15	19 <sup>1</sup> / <sub>2</sub>	23 <sup>1</sup> / <sub>2</sub>	24 <sup>3</sup> / <sub>4</sub>	<sup>1</sup> / <sub>4</sub>	5	1 <sup>1</sup> / <sub>4</sub>

**When requesting a quotation or placing an order, please complete the following form and fax a copy to 717-684-2131 to the attention of Customer Service:**

- 1) Size and material of pipe to which the expansion joint will be connected: \_\_\_\_\_
- 2) Factory to preset the Expansion Joint to: \_\_\_\_\_ Full Expansion \_\_\_\_\_ Full Contraction \_\_\_\_\_  
Intermediate
- 3) Total overall movement while in service: \_\_\_\_\_ inches
- 4) Pipe material for Expansion Joint (standard is Sch. 40 steel): \_\_\_\_\_
- 5) Finish on pipe (standard is black): \_\_\_\_\_
- 6) Finish on couplings (standard is painted): \_\_\_\_\_
- 7) Gasket material (standard is Grade E EPDM): \_\_\_\_\_
- 8) Connecting pipe ends if different than standard roll or cut groove: \_\_\_\_\_

## Cross Reference

DESCRIPTION	VICTAULIC <sup>®</sup>	GRUVLOK <sup>®</sup>
Rigidlok Coupling	07	7401
Rigidlite Stainless Steel Coupling	08	7400 SS
90° Elbows	10	7050
3D Long Radius 90° Elbows	10-3D	7050-3D
5D Long Radius 90° Elbows	10-5D	7050-5D
6D Long Radius 90° Elbows	10-6D	7050-6D
90° Elbow	10-P	7050P
Reducing Base Support Elbows Grooved and Flanged (G x F)	R-10F	7050RF
45° Elbows	11	7051
3D Long Radius 45° Elbows	11-3D	7051-3D
5D Long Radius 45° Elbows	11-5D	7051-5D
6D Long Radius 45° Elbows	11-6D	7051-6D
45° Elbow	11-P	7051-P
22 <sup>1</sup> / <sub>2</sub> ° Elbows	12	7052
3D Long Radius 22 <sup>1</sup> / <sub>2</sub> ° Elbows	12-3D	7052-3D
5D Long Radius 22 <sup>1</sup> / <sub>2</sub> ° Elbows	12-5D	7052-5D
6D Long Radius 22 <sup>1</sup> / <sub>2</sub> ° Elbows	12-6D	7052-6D
11 <sup>1</sup> / <sub>4</sub> ° Elbow	13	7053
3D Long Radius 11 <sup>1</sup> / <sub>4</sub> ° Elbows	13-3D	7053-3D
5D Long Radius 11 <sup>1</sup> / <sub>4</sub> ° Elbows	13-5D	7053-5D
6D Long Radius 11 <sup>1</sup> / <sub>4</sub> ° Elbows	13-6D	7053-6D
3D Long Radius 60° Elbows	14-3D	7057-3D
5D Long Radius 60° Elbows	14-5D	7057-5D
6D Long Radius 60° Elbows	14-6D	7057-6D
3D Long Radius 30° Elbows	15-3D	7058-3D
5D Long Radius 30° Elbows	15-5D	7058-5D
6D Long Radius 30° Elbows	15-6D	7058-6D
90° Adapter Elbows	18	7055
45° Adapter Elbows	19	7056
Tees	20	7060
Tee	20-P	7060P
Type 316 Stainless Steel Tees	20SSLT, 20-SSSW	7060-SS16
Bullhead Tee	21	7062

DESCRIPTION	VICTAULIC <sup>®</sup>	GRUVLOK <sup>®</sup>
Header Tee	22 ES	7022
Cross Tee	35	7068
Reducing Tee	25	7061
Fabricated Steel Reducing Tees	25-P	7061P
Type 316 Stainless Steel Reducing Tee	25-SS	7061-SS16
Standpipe Tee	27	7065
Tees With Threaded Branch*	29M	7063
Reducing Tee With Threaded Branch	29T	7064
Lateral	30	7069
Lateral	30-P	7069P
Reducing Lateral	30R	7070
Tee WYE	32	7066
Reducing Tee WYE	32R	7067
90° True WYE	33	7071
True WYE	33-P	7071P
Cross	35	7068EG
Cross	35-P	7068P
Adapter Nipple – (Gr x MPT)	40	7081F
Seamless Adapter Nipples (Gr x MPT)	40	7081
Flanged Adapter (125 lb)	41	7083
Adapter Nipple – (Gr x Bev)	42	7082F
Seamless Adapter Nipples (Gr x Bev)	42	7082
Adapter Nipple – (Gr x Gr)	43	7080F
Seamless Adapter Nipples (Gr x Gr)	43	7080
Flanged Adapter (150 lb)	45	7084
Flanged Adapter (300 lb)	46	7085
DI-Electric Nipple (Gr x Th)	47	7088
DI-Electric Nipple (Gr x Gr)	47	7089
DI-Electric Nipple (Th x Th)	47	7090
Hose Nipple	48	7086
Concentric Reducer	50	7072
Concentric Reducers	50-SSLT	7072-SS16

## Cross Reference (continued)

DESCRIPTION	VICTAULIC <sup>®</sup>	GRUVLOK <sup>®</sup>
Eccentric Reducer	51	7073
Eccentric Reducers	51-SSLT	7073-SS16
Reducer Threaded Small End	52	7076
Steel Swaged Nipple	53	7077
Steel Plain End Swaged Nipple	53-P	7077P
Steel Swaged Nipple	54	7078
Steel Swaged Nipple	55	7079
Cap	60	7074
Type 316 Stainless Steel Cap	60-SS	7074-SS16
Bullhead Plug	61	7075
Bull Plug	61-P	7075P
Extra Heavy "EG" End Guard Fittings 90° Elbow	62 ES	7050 EG
Extra Heavy "EG" End Guard Fittings 45° Elbow	63 ES	7051 EG
Extra Heavy "EG" End Guard Fittings Tee	64 ES	7060 EG
Outlet Coupling	72	7042
Lightweight Coupling	75	7000
Standard Coupling	77	7001
Hingelok Coupling	78	7003
Female Thread Adapter	80	7087
Roughneck Coupling	99	7005
HDPE Flange Adapter	994	7312
Gruvlok HDPE Coupling	995	7305
Transition Coupling	997	7307
90° Long Radius Elbows	100	7050 LR
Type 316 Stainless Steel 90° Elbow	100-SS	7050-SS16
Type 316 Stainless Steel Long Radius Long Tangent 90° Elbow	100-SSLT	7050-SS16
45° Long Radius Elbow	110	7051 LR
Type 316 Stainless Steel 45° Elbow	110-SS	7051-SS16
Type 316 Stainless Steel Long Radius Long Tangent 45° Elbow	110-SSLT	7051-SS16
Gruvlok Butterfly Valve	300	7700

DESCRIPTION	VICTAULIC <sup>®</sup>	GRUVLOK <sup>®</sup>
90° Elbows Copper	610	7550
45° Elbows Copper	611	7551
Copper Tee	620	7560
Copper Reducing Tee (Gr x Gr x Gr)	625	7561 A
Copper Reducing Tee (Gr x Gr x Cup)	626	7564 A
Concentric Reducers (Gr x Gr)	650	7572
Reducing Adapters (Gr x Cup)	660	7575
Copper Cap	660	7574
Gruvlok Butterfly Valves	709	8000GR
Gruvlok End Check Valve	711, 715, 716	7800
Gruvlok Ball Valves	721	7500
Gruvlok Grooved End Butterfly Valve	709	7600
Grooved End Strainer	730	7260
Suction Diffuser	731	7250
Copper Transition Fitting	732	7582
Gruvlok Flange	741	7012
Gruvlok 300# Flange	743	7013
Reducing Coupling	750	7010
Clamp-T <sup>®</sup> Cross (Thd x Thd)	920 Cross	7047
Clamp-T <sup>®</sup> Cross (Gr x Gr)	920 Cross	7048
Clamp-T <sup>®</sup> Cross (Gr x Thd)	920 Cross	7049
Clamp-T <sup>®</sup> Grooved Outlet	921	7046
HPR Coupling (with Standard Gasket)	HP-70	7004 HPR
End Guard Coupling (with End Guard Gasket)	HP-70ES	7004 EG
Gruvlok Roll Groover	VE260	1007/3007
Gruvlok Steel Roll Groover for Ridgid <sup>®</sup> 300 Power Drive	VE226	3006
Gruvlok Copper Roll Groover for Ridgid <sup>®</sup> 300 Power Drive	VE226	3006 C



## Numerical Index

Fig. 400 G	Silent Check Valve . . . . .	25	Fig. 7400	Rigidlite <sup>®</sup> 300 PSI Coupling . . . . .	8
Fig. 7000	Lightweight Flexible Coupling . . . . .	7	Fig. 7400	Rigidlite <sup>®</sup> 300 PSI Coupling (Copper) . . . . .	33
Fig. 7001	Standard Coupling . . . . .	6	Fig. 7401	Rigidlok™ Rigid Coupling . . . . .	8
Fig. 7003	Hingelok Coupling . . . . .	7	Fig. 7500	Gruvlok Ball Valves . . . . .	23
Fig. 7004 EG	End Guard Coupling . . . . .	10	Fig. 7500B	Bronze Grooved End Ball Valves . . . . .	24
Fig. 7004 HPR	HPR Coupling . . . . .	10	Fig. 7500B	Bronze Grooved End Ball Valves (Copper) . . . . .	36
Fig. 7005	Plain-End Coupling . . . . .	32	Fig. 7550	90° Elbows . . . . .	33
Fig. 7010	Reducing Coupling . . . . .	8	Fig. 7551	45° Elbows . . . . .	33
Fig. 7011	Standard Coupling . . . . .	6	Fig. 7560	Tee . . . . .	33
Fig. 7012	Gruvlok Flange . . . . .	11	Fig. 7561A	Copper Reducing Tee . . . . .	34
Fig. 7012	Gruvlok Flange (Copper) . . . . .	33	Fig. 7564A	Copper Reducing Tee (Gr x Gr x Cup) . . . . .	34
Fig. 7013	Gruvlok 300# Flange . . . . .	11	Fig. 7572	Concentric Reducers (Gr x Gr) . . . . .	34
Fig. 7045	Clamp-T <sup>®</sup> Female Threaded Outlet . . . . .	28	Fig. 7574	Cap . . . . .	34
Fig. 7046	Clamp-T <sup>®</sup> Grooved Outlet . . . . .	28	Fig. 7575	Reducing Adapters (Gr x Cup) . . . . .	35
Fig. 7047	Clamp-T <sup>®</sup> Cross . . . . .	29	Fig. 768 G	Grooved-End "WYE" Strainer . . . . .	27
Fig. 7048	Clamp-T <sup>®</sup> Cross . . . . .	29	Fig. 7582	Transition Fitting (Cup x Gr) . . . . .	35
Fig. 7049	Clamp-T <sup>®</sup> Cross . . . . .	29	Fig. 7800	End Check Valve . . . . .	25
Fig. 7050	90° Elbows . . . . .	12	Fig. 8000GR	Gruvlok Butterfly Valves . . . . .	23
Fig. 7050 LR	90° Long Radius Elbows (1½"D) . . . . .	19	Fig. FTV-A	Angle Body Valve . . . . .	27
Fig. 7050RF	Reducing Base Support Elbows (G x F) . . . . .	19	Fig. FTV-S	Straight Body Valve . . . . .	27
Fig. 7051	45° Elbows . . . . .	12	Fig. GBV-A	Grooved End Angle Circuit Balancing Valves . . . . .	25
Fig. 7051 LR	45° Long Radius Elbows (1½"D) . . . . .	19	Fig. GBV-G	Grooved End Straight Balancing Valves . . . . .	25
Fig. 7052	22½° Elbows . . . . .	12	Fig. GBV-S	Sweat Four Turn Balancing Valves . . . . .	24
Fig. 7053	11¼° Elbow . . . . .	12	Fig. GBV-T	Threaded Four Turn Circuit Balancing Valves . . . . .	24
Fig. 7060	Tees . . . . .	13	Fig. i7042F	Outlet Couplings . . . . .	9
Fig. 7061	Reducing Tee . . . . .	14	Fig. i7042G	Outlet Couplings . . . . .	9
Fig. 7063	Tees With Threaded Branch . . . . .	13	Fig. i7042M	Outlet Couplings . . . . .	9
Fig. 7064	Reducing Tee With Threaded Branch . . . . .	15	Gaskets, Special . . . . .		4
Fig. 7066	Tee WYE . . . . .	20	Gaskets, Standard . . . . .		4
Fig. 7068	Steel Cross . . . . .	21	GAV-15	Gruvlok Air Vent . . . . .	27
Fig. 7069	Lateral . . . . .	20	GAV-30	Gruvlok Air Vent . . . . .	27
Fig. 7070	Reducing Lateral . . . . .	21	Lubricants . . . . .		4
Fig. 7071	True Y . . . . .	21	Model 1007	MRoll Groover . . . . .	37
Fig. 7072	Concentric Reducer . . . . .	16	Model 3006	For Ridgid <sup>®</sup> 300 Power Drive . . . . .	37
Fig. 7073	Eccentric Reducer . . . . .	18	Model 3006C	Copper Roll Groover – For Ridgid <sup>®</sup> 300 Power Drive . . . . .	37
Fig. 7074	Cap . . . . .	17	Model 3007	Model 1007/3007 Roll Groover . . . . .	37
Fig. 7075	Bullhead Plug . . . . .	20	Series 7600	Grooved End Butterfly Valve . . . . .	24
Fig. 7076	Reducer Threaded Small End . . . . .	17	Series 7700	Grooved End Butterfly Valve . . . . .	22
Fig. 7084	Flange Nipples (150 lbs) . . . . .	30	SF21-FF	SF21-FF Flange x Flange Connectors . . . . .	26
Fig. 7085	Flange Nipples (300 lbs) . . . . .	30	SF21-GF	SF21-GF Grooved x Flange Connectors . . . . .	26
Fig. 7086	Hose Nipple . . . . .	17	SF21-GG	SF21-GG Grooved x Grooved Connectors . . . . .	26
Fig. 7087	Female Thread Adapter . . . . .	19	Spare Parts . . . . .		
Fig. 7088	DI-LOK <sup>®</sup> DI-Electric Nipple (Gr. x MPT) . . . . .	35	Fig. 7004 EG , Standard Gaskets . . . . .		31
Fig. 7089	DI-LOK <sup>®</sup> DI-Electric Nipple (Gr. x Gr.) . . . . .	35	Fig. 7005 & 7305, Standard Gaskets . . . . .		31
Fig. 7090	DI-LOK <sup>®</sup> DI-Electric Nipple (MPT x MPT) . . . . .	36	Fig. 7010 Gasket . . . . .		31
Fig. 7097	Eccentric Reducer . . . . .	18	Fig. 7012 & 7013, Flange Parts . . . . .		30
Fig. 7240	Expansion Joint . . . . .	38	Fig. 7012 & 7013, Flange Gaskets . . . . .		31
Fig. 7250	Suction Diffuser . . . . .	26	Fig. 7045 (Gasket Only), Clamp-T <sup>®</sup> Female Threaded Outlet . . . . .		32
Fig. 7260	Grooved End Strainer . . . . .	27	Fig. 7046 (Gasket Only), Clamp-T <sup>®</sup> Grooved Outlet . . . . .		32
Fig. 7305	HDPE Coupling . . . . .	10	Plated Trackhead Bolts and Nuts . . . . .		31
Fig. 7307	HDPE Transition Coupling . . . . .	10			
Fig. 7312	Flange Adapter for HDPE Pipe . . . . .	10			

- NOTES -

- NOTES -



### Corporate Offices

110 Corporate Drive, Suite 10  
P.O. Box 3180  
Portsmouth, NH 03802-3180  
Tel: 603-422-8000  
Fax: 603-422-8033  
E-mail: [webmaster@anvilintl.com](mailto:webmaster@anvilintl.com)

### Anvil International Worldwide Customer Service Center

Tel: 708-534-1414  
Fax: 708-534-5441

## U.S. REGIONAL SERVICE CENTERS

### Eastern Region

**SERVICING:** Connecticut, Delaware, Florida, Georgia, Maine, Maryland, Massachusetts, New Hampshire, New Jersey, New York, North and South Carolina, East Pennsylvania, Rhode Island, Vermont, Virginia

800 Malleable Road  
Columbia, PA 17512

Tel: 800-451-2935  
Fax: 800-272-2983  
Toll-Free: 1-800-301-2701

### Northern Region

**SERVICING:** Illinois, Indiana, Iowa, Kentucky, Michigan, Minnesota, Nebraska, North and South Dakota, Ohio, West Pennsylvania, West Virginia, Wisconsin

750 Central Avenue  
University Park, IL 60466

Tel: 708-534-1414  
Fax: 708-534-5441  
Toll-Free: 1-800-301-2701

### Southern Region

**SERVICING:** Alabama, Arkansas, Kansas, Louisiana, Mississippi, Missouri, Oklahoma, Tennessee, Texas

1313 Avenue R  
Grand Prairie, TX 75050

Tel: 972-343-9206  
Fax: 972-641-8946  
Toll-Free: 1-800-451-4414

### Western Region

**SERVICING:** Alaska, Arizona, California, Colorado, Hawaii, Idaho, Montana, Nevada, New Mexico, Oregon, Utah, Washington, Wyoming

1385 Greg Street  
Sparks, NV 89431

Tel: 775-331-7029  
Fax: 775-331-5075  
Toll-Free: 1-800-572-0051

## CANADA SERVICE CENTERS

### Corporate

390 Second Avenue  
Simcoe, Ontario N3Y 4K9  
Tel: (519) 426-4551

### Western

5506-48 St. NW  
Edmonton, Alberta, T6B 2Z1  
Tel: (780) 413-8274

### Central

390 Second Avenue  
Simcoe, Ontario N3Y 4K9  
Tel: (519) 426-4551

### Eastern

2615-25 Brabant-Marineau. (Saint-Laurent)  
Montreal, Quebec, H4S 1R8  
Tel: (514) 745-3835

## INTERNATIONAL SALES

### Europe & Middle East Region

Rick van Meesen, Director of Sales  
The Netherlands  
Tel: +31-53-5725570  
Fax: +31-53-5725579

U.S. Customer Service  
Tel: +1-708-534-1414  
Fax: +1-708-534-5441

### Latin America

Abraham Quijada, Sales Manager  
Tel: +1-281-590-4600  
U.S. Customer Service  
Tel: +1-708-534-1414  
Fax: +1-708-534-5441

### Puerto Rico

R.R. Barril, Inc.  
Tel: +1-787-982-1550  
Fax: +1-787-982-1570  
U.S. Customer Service  
Tel: +1-708-534-1414  
Fax: +1-708-534-5441

### Mexico

Abraham Quijada, Sales Manager  
Tel: +1-281-590-4600  
U.S. Customer Service  
Tel: +1-708-534-1414  
Fax: +1-708-534-5441

#612 / Printed in USA / 7.07 / ©2008

B U I L D I N G   C O N N E C T I O N S   T H A T   L A S T



[www.anvilintl.com](http://www.anvilintl.com)