

**HOUSING AUTHORITY OF THE CITY OF  
WILMINGTON NORTH CAROLINA (WHA)**

***INVITATION FOR BIDS (IFB)***

**PLAYGROUND/HARDSCAPE (TOT LOT) PROJECT  
AT HOUSTON MOORE DEVELOPMENT  
SOLICITATION NO.: CFPo8.05**

**SUBMISSION DATE: JULY 7, 2011  
9:30 A.M. Eastern Standard Time**

**Prepared By:**

**Wilmington Housing Authority  
Procurement and Contracts Department  
1524 S. 16<sup>th</sup> Street  
Wilmington, NC 28401**

- PUBLISHED ADVERTISEMENT
- NOTICE TO BIDDERS
- INSTRUCTIONS TO BIDDERS FOR CONTRACTS/PUBLIC AND INDIAN HOUSING PROGRAMS (HUD FORM-5369)
- REPRESENTATIONS, CERTIFICATIONS, AND OTHER STATEMENTS OF BIDDERS/PUBLIC AND INDIAN HOUSING PROGRAMS (HUD FORM 5369-A) (require bidder's signature)
- WAGE DETERMINATION
- FORM OF PROPOSAL
- FORM OF BID BOND (*All Contract Work Exceeding \$24,999*)
- PERFORMANCE BOND AND PAYMENT BOND (*All Contract Work Exceeding \$99,999*)
- PROJECT COMPLETION REFERENCE FORM
- NON-COLLUSIVE AFFIDAVIT OF PRIME BIDDER (*All Contract Work Exceeding \$49,999*)
- SECTION 3 DOCUMENTS
  - Contractor Certification of Compliance (require bidder's signature)
  - Section 3 Definitions (signature required)
  - Section 3 Compliance Plan
- SAMPLE FORM OF CONSTRUCTION CONTRACT
- GENERAL CONDITIONS OF CONTRACT FOR CONSTRUCTION/PUBLIC HOUSING AND INDIAN HOUSING PROGRAMS HUD FORM-5370EZ)
- SUPPLEMENT OF GENERAL CONDITIONS
- SCOPE OF WORK (NARRATIVE) & PLANS
- VALYUE ENGINEERING

INVITATION FOR BIDS

HOUSING AUTHORITY OF THE CITY OF  
WILMINGTON NORTH CAROLINA

PLAYGROUND/HARDSCAPE (TOT LOT) PROJECT  
AT HOUSTON MOORE DEVELOPMENT  
1601 SOUTH 13<sup>TH</sup> STREET

Sealed bids will be accepted at the Housing Authority of the City of Wilmington North Carolina (WHA Central Office), until date and time noted below. Bids will be publicly opened and recorded immediately thereafter at the Central Office (CO), 1524 South 16<sup>th</sup> Street, Wilmington, NC 28401.

- Co - Pre Bid Conference and Site Tour will be held: Tuesday, June 28, 2011 at 9:30 a.m.
- CO - Bid Opening: Thursday, July 7 at 9:30 a.m.
- Specifications/Plans will be available for pickup beginning Friday, June 17 at the Central Office.
- Packet pickup fee is \$15.00 non-refundable.
- Download Project Manual from our WHA website at [www.wha.net](http://www.wha.net).
- E-mail your questions no later than July 5 to [l.corbyons@wha.net](mailto:l.corbyons@wha.net).
- Point of contact Ms. Laurette Corbyons.

Upon written request to the Chief Executive Officer, bids will be available after contract award. NO BIDS SHALL BE ACCEPTED AFTER THE DEADLINE. FAXED NEITHER COPIES WILL BE ACCEPTED.

The WHA does not discriminate based on race, sex, age, color, national origin, religion, or disability in its employment opportunities, programs, services, or activities.

WHA reserves the right to reject any or all bids.

## NOTICE TO BIDDERS

The Housing Authority of the City of Wilmington North Carolina (“WHA”) is soliciting sealed bids from contractors for **PLAYGROUND/HARDSCAPE (TOT LOT) PROJECT AT HOUSTON MOORE DEVELOPMENT**.

Prospective bidders are strongly encouraged to attend the Pre-bid Conference and Tour scheduled for Tuesday, June 28, 2011 at 9:30 a.m., at Housing Authority’s Central Office located at 1524 South 16<sup>th</sup> Street, then proceed to the site where work will be preformed.

Project Manual explaining bid requirements will be available on our website at [www.wha.net](http://www.wha.net) beginning Friday, June 16, 2011. Documents can also be picked up at the Housing Authority’s Central Office between the hours of 8:30 a.m. and 4:00 p.m., Monday through Friday. E-mail question(s) no later than June 9 via e-mail [l.corbyons@wha.net](mailto:l.corbyons@wha.net).

Bids will be received until 9:30 a.m. Thursday, July 7, 2011 and publicly opened forthwith at WHA, Central Office. The outer-most label of all submittals must be conspicuously marked: **“PLAYGROUND/HARDSCAPE (TOT LOT) PROJECT”**.

The bid price(s) shall be included as provided in the Project Manual. Unless otherwise specified in the Project Manual, all prices shall be on a **firm-fixed price** basis and are not subject to adjustment. Late bids will be handled in accordance with form HUD-5369.

Based on your bid proposal, a five percent (5%) Bid Bond will be required for bids greater than \$24,999. Certified payrolls and employee interviews will be required by WHA staff. The Bid Bond shall be executed by an acceptable surety, cashier’s check, or bank draft payable to the Housing Authority of the City of Wilmington North Carolina, and will be returned with in 15 days after contract awarded. THERE WILL BE A 10% RETAINAGE. The Contractor shall pay to WHA as liquidated damages, the sum of Two Hundred and Fifty Dollars (\$250) for each day of delay.

All Contractors are required to have General Contractor License in order to perform this project, and the ability to pull permits, if applicable. **No EXCEPTIONS!** All contractors must submit certification that firm is not debarred, suspended or otherwise prohibited from professional practice by any Federal State or local agency.

The WHA does not discriminate on the basis of race, sex, age, color, national origin, religion, or disability in its employment opportunities, programs, services, or activities.

WHA reserves the right to reject any or all bids or to waive informalities in the bidding. Upon written request, bids will be available for review after contract award. Please address letter to the Chief Executive Officer.

## SUPPLEMENT INSTRUCTIONS TO BIDDERS

Proposals must be in accordance with the following instructions, requirements, and procedures to be eligible for consideration:

### 1. LICENSE:

When stipulated in the Notice to Bidders, all Bidders are hereby notified that they must have proper license under applicable State and Local Laws governing their respective trades at the time of submittal of bids.

Bidders are further notified that applicable provisions of Chapter 87, Article 1, NC General Statutes shall be observed in receiving bids and awarding Contracts.

### 2. SINGLE CONTRACT PROPOSALS:

Proposals for the Project Work shall be submitted under a Single GENERAL CONTRACT Proposal.

### 3. DEFINITIONS:

Owner: Housing Authority of the City of Wilmington North Carolina (WHA)

Designer: Operations Department, Housing Authority of the City of Wilmington or, Licensed Professional engaged by WHA, as identified in the Project Manual.

Project Manager: Designated representative of WHA Operations Department.

Presiding: Project Manager of WHA or Contracted Designer

### 4. EXAMINATION OF PLANS, SPECIFICATIONS, AND SITE OF WORK:

Each bidder shall carefully examine the site and premises of the proposed work, the Form of Proposal, the plans, specifications, and special provisions of the Contract Documents before submitting a bid. The submittal of a bid shall be considered full evidence that the bidder has made such necessary examinations, that he knows, and understands the conditions relating to the performance of the work required by the Contract Documents. The bidder has made every provision to operate under existing and stipulated conditions and has included all necessary items for the proper execution of work required by the Contract Documents.

The Owner and Designer shall conduct a pre-bid conference and tour of the Project on the Date and Time specified in the Notice to Bidders. Prospective Bidders are strongly encouraged to attend due to the nature, restrictions, and details of the work.

Other inspections of the Project Site shall be made only during normal business hours and only by appointment, arranged minimum 48 hours in advance. Bidders shall not disrupt Owner's operations or residents' privacy in the course of such inspections.

The Project Site is a residential community of the Housing Authority of the City of Wilmington, and visiting bidders shall adhere to security policies and cooperate fully with instructions of WHA management officials. To arrange site visits

**Contact: Mr. Chad Rivers, Operation Project Manager  
Housing Authority of the City of Wilmington North Carolina  
(910) 341-7700, ext. 234**

5. UTILITY CHARGES:

No service or connection charges or fees by serving utility companies are anticipated in connection with the Project work. Coordination and scheduling of work to be performed by serving utilities, if required for relocation or temporary disconnection, shall be the responsibility of the Contractor.

6. CLARIFICATION OF DOCUMENTS/ INTERPRETATIONS:

Should any bidder be in doubt about the precise meaning or intent of any part of the plans, specifications or other contract documents, or find discrepancies or omissions therein, he shall immediately notify the Designer and request a clarification. Prospective bidders shall request such clarification no later than ten (10) days before the date for submittal of bids.

The Designer shall issue a clarification or correction by written addendum to all known bidders and to offices where Bid Documents are exhibited for inspection, no later than seven (7) days before the date for submittal of bids. The bidder in the spaces provided on the Form of Proposal shall acknowledge receipt of such addenda.

***Neither the Owner nor the Designer shall be responsible for any oral instructions.***

7. PROPOSAL FORMS/ PREPARATION OF PROPOSALS:

Proposals shall be made in strict accordance with the Standard Form of Proposal bound in with these documents, and shall be submitted on the supplied forms.

**PROPOSAL DOCUMENTS:** The following forms shall constitute the Proposal Documents:

<b>Form of Proposal</b>
<b>Form of Bid Bond (\$25,000 and greater)</b>
<b>Form of Performance and Payment Bond (\$100,000 and greater)</b>
<b>Form HUD-5369A–Representations, Certifications and Statements of Bidders</b>
<b>Form Non Collusive (\$50,000 and greater)</b>
<b>Form WHA- Comparable Project Completion References Form.</b>
<b>Section 3 Documents:</b>
<ul style="list-style-type: none"><li>• <b>Compliance Certification</b></li></ul>
<ul style="list-style-type: none"><li>• <b>Definition</b></li></ul>

***All required forms shall be completely filled out and properly executed.***

The forms shall not be detached from these documents. However, bids may be submitted on a separate, exact copy of the Form of Proposal and related documents listed above, and shall be given full consideration and will have the same force and effect as if bound thereto.

Fill in all appropriate blank spaces provided for Amounts, Contract Time, Alternates, Unit Prices, and Addenda as applicable.

Failure to furnish requested itemized prices or alternates may disqualify the proposal.

State the total amount bid in figures and in narrative in the proper spaces on the proposal form.

No lineation, erasures, adjustments, or alterations shall be made to the printed Form of Proposal. In receiving the bids, the Owner and the Designer will assume that no such alterations have been made, and if any such modifications become apparent afterwards they shall not be binding upon either of them.

Changes in any entry shall be made by marking through the initial entry and by inserting the corrected entry adjacent thereto. An authorized representative of the Bidder shall initial each such correction.

**8. EXECUTION OF PROPOSALS:** Proposal Documents shall be executed in the following manner:

- A. If by Sole Proprietor, state by adding "Owner" after the name of the person executing the documents
- B. If by a Partnership, state by adding "Partner" after the name of the person executing the documents.

- C. If by a Corporation, indicate if by the President or by Vice-President and attest by the Secretary. Identify the title of office of the executing entities and impress the corporate seal on each signature page of the documents.
- D. If the proposal is made by a Joint Venture, it shall be executed by each member of the Joint Venture in the above format for sole Owner, Partner, or Corporation, whichever format is applicable.
- E. If a person other than an Owner, Partner, or Officer of a firm holds the Contractor's license, then the Licensee shall also sign and be a party to the proposal. The title "Licensee" shall be indicated under such signature.

**All signatures shall be properly witnessed and sealed.**

9. BID SECURITY: Bid Security in an amount not less than five percent (5%) of the base bid amount shall accompany each bid, for bids exceeding \$25,000, or as stipulated in Notice to Bidders. The bid guarantee shall be a negotiable certified check, bank draft, or bid bond, payable to the Owner.

10. SUBMITTAL OF PROPOSALS: Enclose bid documents in an opaque, sealed envelope of sufficient size to accommodate the documents without folding. Identify the envelope in the upper left hand corner as follows:

**EXAMPLE: PROPOSAL FOR: PLAYGROUND/HARDSCAPE (TOT LOT) PROJECT**

**AT HOUSTON MOORE**

Housing Authority of the City of Wilmington, NC

Name of Bidder \_\_\_\_\_

COMPANY NAME \_\_\_\_\_

Address \_\_\_\_\_

Bidder's Lic. No. \_\_\_\_\_

Address proposals to:

**Ms. Laurette Corbyons, Coordinator  
Contracts/Compliance Department  
Housing Authority of the City of Wilmington  
1524 South 16<sup>th</sup> Street  
Wilmington, NC 28401**

Label the envelope on both sides "**SEALED BID ENCLOSED- DO NOT OPEN!**"

Deliver or mail proposals to be received by the WHA Director of Redevelopment at the address specified above and before the stated time for bid opening as specified in the Notice to Bidders.



11. **MODIFICATION/WITHDRAWAL OF PROPOSALS:** Submitted Bids may be withdrawn or modified only by written request and authorization of the bidder, delivered to the specified address for submittal of bids before the time established for bid opening.

Modifications shall be made as follows:

Changes in any entry shall be made by marking through the initial entry and by inserting the corrected entry adjacent thereto. An authorized representative of the Bidder shall initial and date each such correction.

No proposal may be withdrawn or modified after the scheduled time for opening of bids for a period of thirty- (30) days except as provided by NC General Statute G.S. 143-129.1.

Negligence, omissions or errors on the part of the bidder in preparing his bid shall not entitle him to withdraw or modify his bid after bids have been opened, except as provided by State Statutes, G.S. 143-129.1.

12. **RECEIPT/OPENING OF PROPOSALS:** At the time and place established for the receipt of bids in the Notice to Bidders, every Proposal for the specified work received by the Owner within the time specified shall be opened, acknowledged, and read, regardless of any irregularities therein. Applicable NC General Statutes shall be observed in receiving, opening and evaluating bids, and awarding contracts if award is made.

***The Owner reserves the right to reject any or all proposals and to waive informalities.***

13. **PROTESTS/OBJECTIONS:** Prior to the opening of bids, a bidder shall be allowed to change or withdraw his bid as provided above. In the event of objections or protests before or after opening of bids, contentions shall be addressed in the following manner:

The Presiding Officer shall attempt to satisfy the objection or protest;

or

Obtain complete information with regard to the protest/objection and proceed with the bid opening under protest, for later disposition by proper authority;

or

Rule the objection as informality and proceed with the bid opening, and refer the results to Redevelopment Director.

or

Postpone the bid opening to a later date to allow sufficient time for the objection to be reconciled;

or

Declare the bid opening invalid and reject all bids.

14. **AWARD OF CONTRACT:** If the Owner elects to award a Contract based on bids received, the Contract will be awarded to the responsible, responsive bidder submitting the lowest proposal taking into consideration standards of quality, performance and the contract time specified in the proposal documents.

- The award shall be made as soon as practicable after the receipt of proposals as provided elsewhere in these Instructions.
- Should the successful bidder fail to execute an agreement within 10 days, the contract may be offered to the responsible, responsive bidder submitting the next lowest proposal, at the Owner's discretion.
- The award may be made to other than the lowest bidder under the following conditions: Failure of the apparent low bidder to provide required qualification statements listed below; the apparent low bid is deemed unreasonably low; determination by virtue of qualification statements that the apparent low bidder is not the lowest responsible, responsive bidder.

15. **BIDDER QUALIFICATION:** Before awarding a contract, the Owner reserves the right to require the apparent low bidder to qualify himself to be the responsible bidder by furnishing such relevant information, which may include any or all of the following:

- Permanent name, address, and telephone of place of business.
- Length of time the organization has been in business under its present name and trade, and the number of regular employees with proper qualifications for the required work.
- **Financial statement** indicating assets and liabilities of the organization, immediately of the date of bid receipt or other financial information satisfactory to the Owner, upon request.
- Proof of satisfactory performance of projects of similar scope, requiring specialized skills, and experience and workmanship standards required for the work specified.
- List of names and license numbers of organization members or employees who hold trade or professional licenses or credentials.
- The name and home office address of the Surety proposed and identification of its authorized agent licensed in North Carolina.
- List of principal materials and identification of suppliers and sub-contractors entering into the proposed contract work.
- **Any other information the Owner may deem relevant** to the bidder's qualifications for the performance of the work required by the terms of the Contract Documents.

Such list shall be subject to approval or rejection by the Owner and Designer in accordance with provisions of General and Supplementary Conditions of the Contract.

Should the Owner adjudge that the apparent low bidder is not the lowest **responsible bidder** by virtue of the above qualifications, which bidder will be so notified and his bid security shall be returned to him without prejudice.

**16. NOTIFICATION OF AWARD:** The Owner will notify the successful bidder in Writing that his bid has been accepted and of the intent to award the contract, which shall constitute the Notice of Award.

The Notice of Award, if an award were made, will be issued within sixty days (60) after the receiving of bids, except that the Owner reserves the right to request from the successful Bidder an extension of the decision to award the contract for such reasonable time beyond the stated 45 days as may be mutually agreeable to both parties.

**17. EXECUTION OF CONTRACT:** Following the issuance of the Notice of Award and approval of the Materials and Sub-Contractor List, two (2) counterparts of the prepared Contract Documents will be sent to the successful Bidder for execution.

The Bidder shall promptly execute all counterparts of the contract and return them, together with the specified Bonds and Insurance Certificates and Power of Attorney attached to each counterpart, to the Designer for review within ten (10) days.

As soon as practicable after receipt of the executed, verified documents, the Owner shall complete the execution of the Contract and return to the Contractor his counterpart of the Documents.

Should the successful bidder fail to execute an agreement, the contract may be offered to the responsible bidder submitting the next lowest proposal, at the Owner's discretion.

***The official Contract Forms, Bond Forms, Insurance Forms, and related documents are included in the Project Manual.***

END SUPPLEMENTARY INSTRUCTIONS TO BIDDERS



1524 South 16th Street, Wilmington, NC 28401 • V 910.341.7700 • F 910.341.7760 • TDD 910.341.7740 • <http://wha.net>

**WAGE DETERMINATION**

**THE PRIMARY CONTRACTOR AND HIS SUB-CONTRACTORS ARE REQUIRED TO PAY MINIMUM RATES OF PAY IN ACCORDANCE WITH PARAGRAPHS 39 AND 40 OF THE GENERAL CONDITIONS AS ESTABLISHED BY THE U.S. DEPARTMENT OF LABOR.**

**A COPY OF THE APPLICABLE MINIMUM RATES OF PAY IS REQUIRED TO BE POSTED AT THE JOB SITE UNTIL PROJECT COMPLETION.**

General Decision Number: NC100029 03/12/2010 NC29

General Decision Number: NC100029 03/12/2010 NC29

Superseded General Decision Number: NC20080029

State: North Carolina

Construction Type: Residential

Counties: Brunswick, New Hanover and Pender Counties in North Carolina.

RESIDENTIAL CONSTRUCTION PROJECTS (consisting of single family homes and apartments up to including 4 stories)

Modification Number    Publication Date  
0                    03/12/2010

SUNC1981-005 08/01/1981

	Rates	Fringes
Air conditioning mechanic.....	\$ 7.25	
Bricklayer.....	\$ 7.25	
Carpenter.....	\$ 7.25	
Cement mason/concrete finisher.....	\$ 7.25	
Electrician.....	\$ 7.25	
Glazier.....	\$ 7.25	
Insulator/asbestos worker.....	\$ 7.25	
Laborer, general.....	\$ 7.25	
Painter, brush.....	\$ 7.25	
Plumber/pipefitter.....	\$ 7.25	

Power equipment operators:	
_ Backhoe.....	\$ 7.25
_ Bulldozer.....	\$ 7.25
_ Grader.....	\$ 7.25
_ Loader.....	\$ 7.25
_ Tractor.....	\$ 7.25
Roofer.....	\$ 7.25
Sheet metal worker.....	\$ 7.25
Tile setter.....	\$ 7.25
Truck driver.....	\$ 7.25
Drywall hanger.....	\$ 7.25
Drywall Finisher/Taper.....	\$ 7.25

---

WELDERS - Receive rate prescribed for craft performing operation to which welding is incidental.

---

Unlisted classifications needed for work not included within the scope of the classifications listed may be added after award only as provided in the labor standards contract clauses (29CFR 5.5 (a) (1) (ii)).

---

In the listing above, the "SU" designation means that rates listed under the identifier do not reflect collectively bargained wage and fringe benefit rates. Other designations indicate unions whose rates have been determined to be prevailing.

---

#### WAGE DETERMINATION APPEALS PROCESS

1.) Has there been an initial decision in the matter? This can be:

- \* an existing published wage determination
- \* a survey underlying a wage determination
- \* a Wage and Hour Division letter setting forth a position on a wage determination matter
- \* a conformance (additional classification and rate) ruling

On survey related matters, initial contact, including requests for summaries of surveys, should be with the Wage and Hour Regional Office for the area in which the survey was conducted because those Regional Offices have responsibility for the Davis-Bacon survey program. If the response from this initial contact is not satisfactory, then the process described in 2.) and 3.) should be followed.

With regard to any other matter not yet ripe for the formal process described here, initial contact should be with the Branch of Construction Wage Determinations. Write to:

Branch of Construction Wage Determinations  
Wage and Hour Division  
U.S. Department of Labor  
200 Constitution Avenue, N.W.  
Washington, DC 20210

2.) If the answer to the question in 1.) is yes, then an interested party (those affected by the action) can request review and reconsideration from the Wage and Hour Administrator (See 29 CFR Part 1.8 and 29 CFR Part 7). Write to:

Wage and Hour Administrator  
U.S. Department of Labor  
200 Constitution Avenue, N.W.  
Washington, DC 20210

The request should be accompanied by a full statement of the interested party's position and by any information (wage payment data, project description, area practice material, etc.) that the requestor considers relevant to the issue.

3.) If the decision of the Administrator is not favorable, an interested party may appeal directly to the Administrative Review Board (formerly the Wage Appeals Board). Write to:

Administrative Review Board

U.S. Department of Labor  
200 Constitution Avenue, N.W.  
Washington, DC 20210

4.) All decisions by the Administrative Review Board are final.

=====

END OF GENERAL DECISION



FORM OF PROPOSAL FOR: GENERAL CONSTRUCTION CONTRACT  
SOLICITATIONNO.: CFP08.05

PROJECT: **PLAYGROUND/HARDSCAPE (TOT LOT) PROJECT @ HOUSTON MOORE DEV.**  
Housing Authority OF THE CITY OF ID Code: NC001  
Wilmington North Carolina

SUBMITTED TO: Laurette Corbyons, Coordinator  
Contract/Compliance Department  
Wilmington Housing Authority  
1524 South 16th Street  
Wilmington NC 28401

SUBMITTED BY: Bidder's Company Name: \_\_\_\_\_  
Name: \_\_\_\_\_  
Address: \_\_\_\_\_

E-mail Address: \_\_\_\_\_

- License No. : \_\_\_\_\_ (as applicable)
- TELEPHONE: \_\_\_\_\_
- FAX NO.: \_\_\_\_\_ Date: \_\_\_\_\_

In compliance with the request for proposals issued by the Wilmington Housing Authority, the undersigned as Bidder hereby proposes to furnish all labor and materials, equipment, operations and incidentals, and to perform all work for the complete execution of the construction entering into the GENERAL CONTRACT for **PLAYGROUND/HARDSCAPE (TOT LOT) PROJECT AT HOUSTON MOORE** in Wilmington, North Carolina, in strict accordance with Plans (if applicable), Specifications, Contract Documents, applicable codes and regulations to the full and entire satisfaction of the Owner for the consideration of the following amount:

**BASE BID:** \_\_\_\_\_

Bid Security in the sum of \_\_\_\_\_ Dollars (\$ \_\_\_\_\_) in the form of \_\_\_\_\_, equal to not less than five percent (5%) of the Base Bid Amount is submitted herewith in accordance with provisions of Instructions to Bidders.

TIME OF COMPLETION shall be as specified in the Supplementary General Conditions, Supplement Clause 25, and **Contract** Period.

The Undersigned, as Bidder, hereby declares that the only person or persons interested in this proposal, as principal or principals, is or are named herein, and that no other party or

parties than those herein identified have any interest in this proposal or in the contract which may be entered into as a result of acceptance of this proposal; and that this proposal is made without connection with any person, company, corporation or parties making a bid or proposal; and that this proposal is in all respects fair and in good faith without collusion or fraud.

The Bidder further declares that he has examined the Site of the Work and informed himself fully with all conditions pertaining to the place where the Work is to be performed; that he has examined the Drawings, Specifications and Instructions for the Work and the Contract Documents relative thereto, and has read all special provisions furnished prior to the Opening of Bids; and that he fully understands and has made every provision to operate under the conditions relative to the Work required by the Contract Documents.

The undersigned further states that he is a duly licensed contractor in the State of North Carolina under applicable statutes governing his trade, and that all fees, licenses, permits, and charges pertinent to the submission of this Bid have been paid in full.

If written notice of the acceptance of this Bid is delivered to the undersigned within forty five (45) days after the date of Opening of the Bids, or any time thereafter before the specified time for retention of the Bids expires, the undersigned will, within ten (10) days after the date of such notice, execute and deliver a contract in the Form of Contract bound in with the Specifications, and provide Performance and Payment Bonds and Certificates of Insurance in accordance with the requirements prescribed in the Supplementary General Conditions.

The undersigned further agrees that in the case of failure on his part to execute the said Contract, Bonds and required Certificates of Insurance within ten (10) consecutive calendar days after written notice being given of the Award of the Contract, the submitted proposal shall be disqualified, and the Bid Security in the form of cash, certified check or bid bond shall be paid into the funds of the Owner's account set aside for the project as liquidated damages for such failure, and a contract may be offered to the bidder submitting the next lowest proposal at the discretion of the Owner; otherwise the Bid Security accompanying this proposal shall be returned to the undersigned.

The Bidder further proposes and agrees hereby to commence work under his Contract on a date to be specified in a written order of the Owner and to, fully complete all work required by the Contract within the consecutive calendar days stated in this proposal, from and including said date. For each day in excess, thereof applicable liquidated damages shall be assessed as stipulated in Supplementary General Conditions.

In submitting this bid, it is understood that the Owner reserves the unqualified right to reject any and all proposals, and to waive informalities or irregularities in the bids.

Respectfully submitted this \_\_\_\_\_ day of \_\_\_\_\_, 2011

Witness:

\_\_\_\_\_  
Firm or Corporation making bid

\_\_\_\_\_  
(Partnership/Proprietorship)

By: \_\_\_\_\_

Attest:

Title: \_\_\_\_\_

(Owner, Partner, or Corp.  
Pres. or Vice-Pres. Only)

\_\_\_\_\_  
(Corp. Sec. or Asst. Sec. Only)

\_\_\_\_\_  
Address:

(Corporate Seal)

\_\_\_\_\_  
License No.:

The Bidder declares that he has received, reviewed, and complied with all instructions issued in the following addenda:

Addenda Received and Considered in Preparing the Bid: (Initial as appropriate)

Addendum No. _____	Date _____	Initial _____
Addendum No. _____	Date _____	Initial _____
Addendum No. _____	Date _____	Initial _____

**BID BOND**

KNOW ALL MEN BY THESE PRESENTS, That we the undersigned,

\_\_\_\_\_  
(Name of Principal)

as PRINCIPAL, and \_\_\_\_\_  
(Name of Surety)

as SURETY, are held and firmly bound unto the Housing Authority of the City of  
Wilmington, NC, P. O. Box 899, or 1524 South 16<sup>th</sup> Street, Wilmington, NC hereunder called  
the "Local Authority", in the penal sum of \_\_\_\_\_ Dollars,

lawful money of the United States, for the payment of which sum well and truly be made,  
we bind ourselves, our heirs, executors, administrators, successors and assigns, jointly  
and severally, firmly by these presents.

THE CONDITION OF THIS OBLIGATION IS SUCH, that whereas, the Principal has submitted  
the accompanying bid, dated \_\_\_\_\_, 2011, for

**CONTRACT No.: CFP08.05  
PLAYGROUND/HARDSCAPE (TOT LOT) PROJECT @ HOUSTON MOORE  
WILMINGTON, NC 28401**

NOW, THEREFORE, if the Principal shall not withdraw said bid within the period specified  
therein after the opening of the same, or, if no period be specified, within sixty (60) days  
after the said opening, and shall within the period specified therefore, or, if no period be  
specified within ten (10) days after the prescribed forms are presented to him for  
signature, enter into a written Contract with Local Authority in accordance with the bid as  
accepted, and give bond with good and sufficient surety or sureties, as may be required,  
for the faithful performance and proper fulfillment of such Contract; or in the event of the  
withdrawal of said bid within the period specified, or the failure to enter into such  
Contract and give such bond within the time specified, if the Principal shall pay the Local  
Authority the difference between the amount specified in said bid and the amount of  
which the Local Authority may procure the required work or supplies or both, if the latter

amount be in excess of the former, then the above obligation shall be void and of no effect, otherwise to remain in full force and virtue.

IN WITNESS WHEREOF, the above bound parties have executed this instrument under their several seals this \_\_\_\_\_ day of \_\_\_\_\_, 2011, the name and corporate seal of each corporate party being hereto affixed and these presents duly signed by its undersigned representative, pursuant to authority of its governing body.

In presence of:

\_\_\_\_\_  
(Individual Principal) (SEAL)

\_\_\_\_\_  
(Business Address) (SEAL)

\_\_\_\_\_  
(Individual Principal) (SEAL)

\_\_\_\_\_  
(Business Address) (SEAL)

ATTEST:

\_\_\_\_\_  
(Secretary or Treasurer) (President or Vice-President)

\_\_\_\_\_  
(Business Address)

By: \_\_\_\_\_  
(Affix Corporate Seal)

ATTEST:

\_\_\_\_\_  
(Corporate Surety)

By: \_\_\_\_\_  
(Affix Corporate Seal)

Power-of-Attorney for person signing for Surety Company must be attached to bond.

**BID BOND**

**(CONTINUED)**

CERTIFICATE AS TO CORPORATE PRINCIPAL

I, \_\_\_\_\_, certify that I am the \_\_\_\_\_ of the Corporation named as Principal in the within bond; that \_\_\_\_\_, who signed the said bond on behalf of the Principal was then \_\_\_\_\_ of said Corporation; that I know his signature, and his signature thereto is genuine; and that said bond was duly signed, sealed, and attested to for and in behalf of said corporation by authority of its governing body.

**(Corporate Seal)**

*End of Bid Bond*



1524 South 16th Street Wilmington, NC 28401 • **V** 910.341.7700 • **F** 910.341.7760 • **TDD** 910.341.7740 • <http://wha.net>

FOR PROJECTS GREATER THAN  
\$99,999, A PERFORMANCE AND  
PAYMENT BONDS ARE REQUIRED  
WITHIN TEN (10) DAYS AFTER  
CONTRACT AWARD.

PROJECT COMPLETION REFERENCE FORM

**PLAYGROUND/HARDSCAPE (TOT LOT) PROJECT AT HOUSTON MOORE**

**CPF008.05**

(To be completed as a part of this bid for all contract work)

NAME OF PROJECT	LOCATION	Est. Value	REFERENCE
1. _____ _____	\$ _____		NAME: _____ ADDRESS: _____ Year: _____ PHONE: ( ) _____
2. _____ _____	\$ _____		NAME: _____ ADDRESS: _____ PHONE: ( ) _____
3. Year: _____ _____	\$ _____		PHONE: ( ) _____ NAME: _____ ADDRESS: _____ PHONE: ( ) _____
4. _____ _____	\$ _____	NAME: _____	ADDRESS: _____ PHONE: ( ) _____
5. Year: _____ _____	\$ _____		NAME: _____ ADDRESS: _____ PHONE: ( ) _____



NON-COLLUSIVE AFFIDAVIT OF PRIME BIDDER  
(To be completed for all Contract Work exceeding \$49,000)

PROJECT: **PLAYGROUND/HARDSCAPE (TOT LOT) PROJECT AT HOUSTON MOORE**  
SOLICITATION NO.: CPFo8.05

**Housing Authority of the  
City of Wilmington North Carolina  
P.O. Box 899  
Wilmington, NC 28402**

State of \_\_\_\_\_

County of \_\_\_\_\_

\_\_\_\_\_, being first

duly sworn, deposes and says: That he is

\_\_\_\_\_  
(a Partner or Officer of the Firm of, etc.)

the party making the foregoing proposal or bid, that such proposal or bid is genuine and not collusive or sham; that said bidder has not colluded, conspired, connived, or agreed directly or indirectly, with any bidder or person, to put in a sham bid or to refrain from bidding, and has not in any manner, directly or indirectly, sought by agreement or collusion, or communication or conference, with any person, to fix the bid price of affiant or any other bidder, or to fix any overhead, profit or cost element of said bid price, or that of any other bidder or to secure any advantage against the Housing Authority of the City of Wilmington, NC or any person interested in the proposed contract; and that all statements in said proposal or bid are true.

\_\_\_\_\_  
(Signature of Bidder, if Bidder is an Individual)

\_\_\_\_\_  
(Signature of Partner, if Bidder is a Partnership)

**(SEAL)**

\_\_\_\_\_  
(Signature of Officer, if Bidder is a Corporation)

**NOTARY**

Subscribed and sworn to before me this \_\_\_\_ day of \_\_\_\_\_, 2011

My Commission expires: \_\_\_\_\_

**SAMPLE**  
**Contract for \_\_\_\_\_**  
**(Contract No.: \_\_\_\_\_)**

This **Contract for \_\_\_\_\_** (the “Contract”) made this the \_\_\_\_ day of \_\_\_\_\_, 2010 by and between the HOUSING AUTHORITY OF THE CITY OF WILMINGTON, NORTH CAROLINA (the “Authority”), whose address is 1524 S. 16<sup>th</sup> Street, Wilmington, North Carolina and \_\_\_\_\_ (“Contractor”) whose address is \_\_\_\_\_

**Recitals**

WHEREAS, the Authority is a public body and body corporate and politic organized under the laws of the State of North Carolina;

WHEREAS, the Authority has selected the Contractor to perform the services describe in this Contract in accordance with the Authority’s procurement policy;

WHEREAS, the Contractor has the knowledge and experience required to fully perform the scope of work herein;

NOW, THEREFORE, in consideration of the mutual covenants contained herein, and other good valuable consideration hereby acknowledged, the parties hereto agree as follows:

**Section 1. Contract Performance**

The Contractor shall perform all tasks set forth in the "Scope of Work" attached as Exhibit A and the Project Manual attached as Exhibit B.

**Section 2. Statement of Work**

The Contractor shall furnish all labor, material, tools, equipment, transportation, supervision and related services to perform and complete all work required under this Contract. All work shall be in strict conformance with the Contract, as amended.

In its performance of the work under the Contract, the Contractor shall perform all work in a prompt and efficient manner, as well as use its best efforts **to** minimize disturbance **to** residents at the Authority’s premises.

**Section 3. Changes**

The Authority may at any time, by written order, and without notice to the sureties, if any, make changes within the scope of the Contract (including the Scope of Work and Project Manual in the services to be performed or supplies to be delivered by the Contractor.

If any such change causes an increase or decrease in the hourly rate or the time required for performance of any part of the work under the Contract, or otherwise affects the conditions under which the Contract shall be performed by the Contractor, the Authority shall make an equitable adjustment in the hourly rate, the delivery schedule, or other affected terms, and shall modify the Contract accordingly.

The Contractor must assert its right to an equitable adjustment under this Section within thirty (30) days from the date of receipt of the written order for change. However, if the Authority decides that the facts justify it, the Authority may receive and act upon a proposal submitted before final payment of the contract.

Failure to agree to any adjustment shall be a dispute which shall be resolved under Section 18. However, nothing in this clause shall excuse the Contractor from proceeding with the Contract as changed.

No services for which an additional cost or fee will be charged by the Contractor shall be furnished without the prior written consent of the Authority.

#### Section 4. Contract Price

Prices for the Contract shall be as follows:

- A. For CONSTRUCTION work as specified in the Scope of Work and Project Manual, Contractor shall be paid in the amount \_\_\_\_\_ for such services.

#### Section 5. Contract Term

The Contract shall commence on \_\_ \_\_\_\_, 2010 and end on \_\_ 20\_\_, with an option exercisable by the Authority to extend the Contract for two (2) additional one (1) year periods unless terminated sooner by either party in accordance with the provisions of the Contract.

After the Contract has been executed by the Authority and delivered to the Contractor, the Contractor shall deliver a fully-executed original of the Contract to the Authority no later than ten (10) days after delivery by the Authority. If the fully executed original Contract is not delivered to the Authority within the time specified above, the Authority may in its discretion cancel the award and nullify the Contract.

#### Section 6. Insurance Requirements

Before work begins, the Contractor shall procure from a reputable insurance company authorized to do business in the State of North Carolina the following insurance policies that provide (at a minimum) the following coverage:

- A. Commercial General Liability - \$500,000 per occurrence combined single limit with a \$1,000,000 annual aggregate for bodily injury liability and property damage liability, including premises and/or operations, independent contractors, products and/or completed operations, broad form property damage and commercial umbrella coverage, and a contractual liability endorsement.
- B. Business Auto Policy - \$1,000,000 each occurrence combined for bodily injury liability and property damage liability, including owned vehicles, hired and non-owned vehicles, and employee non-ownership.
- C. Worker's Compensation and Employers' Liability – coverage for all employees to the statutory limits in compliance with state and federal law; employer's liability of \$500,000 each accident; \$500,000 bodily injury by disease each employee; \$500,000 bodily injury by disease policy limit.

The Authority shall be named as an additional insured on the contractor's commercial general liability and business auto liability. Current, valid insurance meeting the requirements shall be maintained during the entire duration of the Contract. Renewal certificates shall be sent to the Authority thirty (30) days prior to any expiration date. The Authority shall be provided written notification in the event of cancellation or modification by either Contractor or Contractor's insurer of any coverage required under the Contract no less than thirty (30) days prior to such cancellation or modification.

The Contractor shall furnish the Authority with a Certificate(s) of Insurance evidencing the coverage required hereunder. It shall be unacceptable for any Certificate of Insurance to contain language or wording to the effect that the insurer shall have no liability for failure to provide the prior notices required hereunder.

It shall be the responsibility of the Contractor to insure that any agreements between Contractor and sub-contractors contain the same insurance requirements as set forth in the Contract.

#### Section 7. Payment and Performance Bonds Requirements, if applicable.

The Contractor shall provide to the Authority payment and performance bonds naming the Authority as a dual obligee in an amount not less than the full value of the Contract. The Contractor shall not have done or permitted anything to be done that would affect the coverage of any performance or labor and material payment bonds required by the terms of the Contract and, upon demand of the Authority, the Contractor shall have

obtained a written statement from the bonding company or companies assuring that such coverage continues in full force and effect.

#### Section 8. Billing and Payment

The Contractor shall submit an original copy of each invoice to the Authority at P.O. Box 899, Attn: Finance Department. All invoices shall contain the following information: Brief description of project. The Authority shall pay the Contractor within 30 calendar days following receipt of an acceptable invoice.

#### Section 9. License

During the term of the Contract, the Contractor shall maintain the proper license(s) under applicable state and local laws as required by the Authority, to perform all work under the Contract.

#### Section 10. Termination for Convenience

The Authority may terminate the Contract, in whole or in part, for the Authority's convenience. The Authority shall terminate by delivering to the Contractor a written notice of termination specifying the nature, extent, and effective date of the termination. Upon receipt of the notice, the Contractor shall: (a) immediately discontinue all services affected (unless the notice directs otherwise); and (b) deliver to the Authority all information, reports, papers, and other materials accumulated or generated in performing the Contract, whether completed or in process.

Upon termination for the convenience by the Authority, the Authority shall be liable to the Contractor for reasonable and proper costs resulting from such termination (and upon the receipt by the Authority of a properly presented claim setting out in detail) including: (i) the total cost of the work performed to date of termination less the total amount of contract payments made to the Contractor; (ii) the cost of settling and paying claims under subcontracts and material orders for any work performed and materials and supplies delivered to the site, payment for which has not been made by the Authority to the Contractor; (iii) the cost of preserving and protecting the work already performed (provided that such work was approved by the Authority), until the Authority or a party designated by the Authority takes possession thereof or assumes responsibility therefore.

#### Section 11. Termination for Cause

The Authority may terminate the Contract, in whole or in part, for cause. "Cause" shall include, but not be limited to: (a) failure of the Contractor to fulfill its obligations under the Contract; (b) falsification by any officer, employee or agent of the Contractor of any document or information submitted by the Contractor past or present in connection with

the subject matter of the Contract; (c) Contractor's bankruptcy, insolvency, assignment for the benefit of creditors, marshaling of assets, or other such events; or (d) occurrences reasonably justifying the Authority's opinion that the Contractor is about to become unable to meet its obligations under the Contract.

The Authority shall terminate the Contractor for cause by delivering to the Contractor a written notice of termination specifying the nature, extent, and effective date of the termination. Upon receipt of the notice, the Contractor shall: (i) immediately discontinue all services affected (unless the notice directs otherwise); and (ii) deliver to the Authority all information, reports, papers, and other materials accumulated or generated in performing the Contract, whether completed or in process.

If the termination is for cause, the Authority may (1) require the Contractor to deliver to it, in the manner and to the extent directed by the Authority, any work as described in Subsection 11. (ii) above, and compensation be determined in accordance with the provisions set forth in Section 3 above; (2) take over the work and prosecute the same to completion by contract or otherwise, and the Contractor shall be liable for any additional cost incurred by the Authority; and/or (3) withhold any payments to the Contractor, for the purpose of off-set or partial payment, as the case may be, of amounts owed to the Authority by the Contractor.

#### Section 12. Reports and Records

The Contractor shall provide all reports pertaining to its performance of the Contract reasonably required by the Authority.

The Authority, HUD, or Comptroller General of the United States, or any of their duly authorized representatives shall, until three (3) years after final payment under the Contract, be provided access to and the right to examine any of the Contractor's directly pertinent books, documents, papers, or other records involving transactions related to the Contract for the purpose of making audit, examination, excerpts, and transcriptions.

#### Section 13. Assignment

The Contractor shall not assign or otherwise transfer any of its obligations or interest under the Contract without the prior written consent of the Authority.

#### Section 14. Equal Opportunity

The Contractor shall comply with the provisions of any federal, state, or local laws prohibiting discrimination on the grounds of race, color, sex, age, creed, national origin, marital status or handicap, including Title VI of the Civil Rights Act of 1964 (Public Law 88352,78 Stat. 241), Title VII of the Civil Rights Act of 1968 and Section 504 of the Rehabilitation Act of 1973.

#### Section 15. Authority's Waiver of Claim

In the event of the suspension or termination of the Contract, the Contractor shall remit to the Authority any unexpended balance of payments made by the Authority under this Agreement. The Authority's acceptance of the Contract remittance shall not constitute a waiver of any claim that the Authority might have against the Contractor.

#### Section 16. Indemnification

The Contractor shall protect, defend, indemnify and hold the Authority, its commissioners, officers, employees and agents free and harmless from and against any and all losses, penalties, damages, settlements, costs, charges, professional fees or other expenses or liabilities of every kind and character arising out of or relating to any and all claims, liens, demands, obligations, actions, proceedings, or causes of action of every kind in connection with or arising out of the Contract and/or the performance hereunder that are due to the omission, negligence or action of the Contractor, its officers, employees, or agents. The Contractor further agrees to investigate, handle, respond to, provide defense for, and defend the same at its sole expense and agrees to bear all other costs and expenses related thereto.

#### Section 17. Third Party Relationships

The Contract shall not be construed to create any relationship of third-party beneficiary involving the Authority. The Contractor shall include in all contracts, subcontracts, or other agreements with other parties relating to the Contract an acknowledgment by those parties that this Contract does not create any relationship of third-party beneficiary.

#### Section 18. Dispute Resolution

All disputes arising under or relating to the Contract in connection with the Contractor's claims, except for disputes arising under provisions contained in Section II of the General Conditions for Non-Construction (Form HUD-5370-C) which is attached to the Contract as Exhibit E, including any claims for damages for the alleged breach thereof which are not disposed of by agreement, shall be resolved under this Section.

All claims by the Contractor shall be made in writing and submitted to the Authority. A claim by the Authority against the Contractor shall be subject to a written decision by the Authority.

The Authority shall, with reasonable promptness, but in no event in no more than sixty (60) days, render a decision concerning any claim hereunder. Unless the Contractor, within thirty (30) days after receipt of the Authority's decision, shall notify the Authority in writing that it takes exception to such decision, the decision shall be final and conclusive.

Provided the Contractor has (i) given the notice within the time stated above, (ii) excepted its claim relating to such decision from the final release; and (iii) brought suit against the Authority not later than one (1) year after receipt of final payment, or if final payment has not been made, not later than one (1) year after the Contractor has had a reasonable time to respond to a written request by the Authority that it submit a final voucher and release, whichever is earlier, then the Authority 's decision shall not be final or conclusive, but the dispute shall be determined on the merits by a court of competent jurisdiction.

The Contractor shall proceed diligently with performance of the Contract, pending final resolution of any request for relief, claim, appeal, or action arising under the Contract, and comply with any decision of the Authority.

Section 19. Notices, Demands, Approvals and Verifications.

All notices required to be given hereunder shall be in writing and shall be deemed served at the earlier of (i) receipt; (ii) the business day following deposit with a naturally recognized overnight courier service, postage prepaid for overnight delivery and addressed to the parties at their applicable addresses; or (iii) four (4) business days after deposit in registered, certified or first-class United States mail, postage pre-paid, return receipt requested and addressed to the parties at their applicable addresses.

For purposes of notice, the following addresses, or such other addresses as may from time to time be designated by written notice given as herein required shall be the parties' applicable addresses:

The Contractor:

\_\_\_\_\_  
Attn: \_\_\_\_\_

The Authority:

Housing Authority of the City of Wilmington, North Carolina

1524 South 16 Street  
Wilmington, NC 28402  
Attention: CEO

Section 20. Section 3

The work performed under this Contract is subject to the requirements of Section 3 of the Housing and Urban Development Act of 1986, as amended, 12 U.S.C. 1701u ("Section 3"). The purpose of Section 3 is to ensure that employment and other economic opportunities



generated by HUD assistance or HUD-assisted projects covered by Section 3 shall to the greatest extent feasible be directed to low and very low income person, particularly persons who are recipients of HUD assistance for housing.

The parties agree to comply with HUD regulations in 24 CFR part 135 which implement Section 3. As evidenced by its execution of the Contract, the Contractor certifies that it is under no contractual or other impediment that would prevent them from complying with the part 135 regulations.

#### Section 21. Independent Contractor

The Contractor agrees that it is an independent contractor, and this Agreement shall not be construed as establishing a joint venture, partnership, or, any principal-agent relationship between the Authority and the Contractor. Employees of the Contractor shall remain subject to the exclusive control and supervision of the Contractor, which is solely responsible for their compensation and any claims arising there from.

#### Section 22. Compliance with Laws

The Contractor shall comply with all laws, ordinances, rules and regulations pertaining to performance of work under or in connection with the Contract, and shall hold the Authority harmless against any fine, penalty, or damage for any actual negligent failure on the part of the Contractor to comply therewith.

#### Section 23. Entire Agreement

The Contract constitutes the entire agreement between the Authority and the Contractor and supersedes all prior oral and written agreements, if any, between the parties.

#### Section 24. Contract Documents

The Contract shall consist of the following components, which are incorporated herein by reference:

- A. Scope of Work (Exhibit A)
- B. The Project Manual dated May 27, 2011 (Exhibit B)
- C. Instructions to Bidders for Contract (Form HUD-5369) (Exhibit C)
- D. Representations, Certifications and Other Statements of Bidders (Form HUD-5369A)
- E. The Invitation For Bids (CFP09.07) including all amendments and addenda, (provided, however, in the event that any provision in the Contract is inconsistent or conflicts with any provision in the Invitation For Bids, the provision in the Contract shall govern)

- F. The Contractor's bid form dated *July 7, 2011* (provided, however, in the event that any provision in the Contract is inconsistent or conflicts with any provision in the Contractor's bid form, the provision in the Contract shall govern)
- G. General Conditions for Construction Contracts (Form HUD-5370EZ) (Exhibit E)
- H. Certification Regarding Debarment and Suspension (Form HUD-2992) (Exhibit F)
- I. Equal Employment Opportunity Certification (Form HUD-92010) (Exhibit G)
- J. Section 3 Compliance Certification (Exhibit H)
- K. Section 3 Compliance Plan (Exhibit I)
- L. Value Engineering ((Exhibit J)
- M. Notice to Proceed (Exhibit K)

IN WITNESS WHEREOF, the parties thereto have caused this instrument to be executed in three (3) original counterparts as of the day and the year first above written.

AUTHORITY:

HOUSING AUTHORITY OF THE CITY OF WILMINGTON, NORTH CAROLINA

By: \_\_\_\_\_  
Michael J. Krause, CEO

CONTRACTOR:

\_\_\_\_\_

By: \_\_\_\_\_  
Name :  
Title:

**Exhibit A**  
**Scope of Work**

## SCOPE OF WORK PLAYGROUND/HARDSCAPE (TOT LOT) PROJECT

### **Staking Plan revision summary:**

-A portion of the existing sidewalk is to be removed to accommodate the new tricycle track.

-No detail will be provided for the electrical connection for power for the gate. For bidding purposes the electrical panel that will be tied into is approximately 100 feet from the gate and access into the building will be made through the soffit material and above an existing acoustic tile ceiling.

-Note on toddler scale fountain has been revised to include a “freeze proof” equipment. Additionally, connection to existing water lines can be made approximately 25 feet from the fountain.

-Note 10: “All landscaping by others. “ To clarify, all shrubs and tree plantings have been removed from this scope and have been shown for reference purposes only.

-Note 8 should reference the northeast corner of the project not the northwest.

-The note for the play surface under the equipment should say “Poured in place or pre-manufactured play surface with a minimum fall protection of 48”.

### **Planting Plan revision summary:**

-Bermuda sod shall be used where sod is specified.

-Again, all shrubs and trees have been removed from the scope of work and are shown for reference only.

-The area under the oak tree was changed from “PROPOSED 4” SHREDDED PINE BARK MULCH” to “AREA TO BE LEFT AS CURRENTLY EXISTS: SAND”.

-The area under the playground equipment has been changed from “PROPOSED 8” DEEP ENGINEERED MULCH” to reference the foam surface.

**Exhibit B**

**Project Manual**  
(DATED JUNE 15, 2011)

**Exhibit C**

**Instructions to Bidders for Contract (Form HUD-5369)**

(See Attached)

**Exhibit D**

**Representations, Certifications and Other Statements of Bidders (Form HUD-5369A)**  
(See Attached – Fill-in & Signature Required)



**Exhibit E**

**General Conditions for Construction Contracts (Form HUD-5370EZ)**

(See Attached)

**Exhibit F**

**Certification Regarding Debarment**  
(See Attached – Signature Required)

**Exhibit G**

**Equal Employment Opportunity**  
(See Attached – Signature Required)

**Exhibit H**  
**Section 3 Certification**  
(See Attached – Signature Required)

**CONTRACTOR'S Section 3 COMPLIANCE CERTIFICATION**

The undersigned makes this certification with full knowledge that its contents will be used in the expenditure of funds provided by the United States Government. Under penalty of perjury I hereby state:

1. I am the \_\_\_\_\_ of \_\_\_\_\_,  
(Owner, Partner, Officer, Representative, Agent)  
the Bidder that has submitted the attached Bid; and

2. My company adheres to Section 3 of the Housing and Urban Development (HUD) Act of 1968, as amended, 12 U.S.C. 1701u which requires, to the greatest extent feasible, that a "good faith effort" is given to identifying small businesses located within the boundaries of the Section 3 service area, making them aware of contracting opportunities, encouraging their participation and actually awarding contracts to Section 3 business concerns.

3. Efforts will be made to undertake outreach activities intended to encourage participation by Section 3 residents in training and employment opportunities, to include but not limited to:

A. Advertising in local media;

B. Distributing flyers on training and job opportunities to public housing sites and posting flyers in common areas;

C. Informing labor organizations and private job training agencies of potential jobs and contract opportunities;

D. Participation in job information meetings and workshops to help Section 3 residents complete applications and learn interviewing techniques.

Signature of Authorized Certifying Official: \_\_\_\_\_

Title: \_\_\_\_\_ Date: \_\_\_\_\_

Company

Name: \_\_\_\_\_

## **SECTION 3 DEFINITIONS:**

### **A. Section 3 Resident:**

A public housing resident **or** a low- or very low-income person who resides in the Wilmington Metropolitan Statistical Area (MSA) in which Section 3 covered assistance is expended. Wilmington MSA consists of New Hanover and Brunswick Counties.

### **B. Section 3 Business Concern:**

A business concern that is:

1. Fifty one percent (51%) or more owned by Section 3 residents; **or**
2. Whose permanent, full-time employees include persons, at least thirty percent (30%) of whom are currently Section 3 residents, or were Section 3 residents within three years of the date of first employment with the business concern; **or**
3. That provides evidence of a commitment to subcontract in excess of twenty five percent (25%) of the total bid/proposal price awarded to business concerns that meet the qualifications set forth in paragraphs 1 or 2 in this definition of a Section 3 business concern.

### **C. Section 3 Covered Assistance:**

1. Public and Indian housing development assistance provided pursuant to Section 5 of the 1937 Act;
2. Public and Indian housing operating assistance provided pursuant to Section 9 of the 1937 Act;
3. Public and Indian housing modernization assistance provided pursuant to Section 14 of the 1937 Act;
4. Assistance provided under any HUD housing or community development program. Assistance expended for housing rehabilitation (including reduction and abatement of lead-based paint hazards, but excluding routine maintenance, repair and replacement), housing construction or other public construction projects.

D. Section 3 Covered Contract:

A contract or subcontract (including a professional service contract) awarded by a recipient or contractor for work generated by the expenditure of Section 3 covered assistance, or for work arising in connection with a Section 3 covered project. "Section 3 covered contracts" do not include contracts awarded under HUD's procurement program, which are governed by the Federal Acquisition Regulation System (see 48 CFR Chapter 1). "Section 3 covered contracts" also do not include contracts for the purchase of supplies and materials. However, whenever a contract for materials includes the installation of the materials, the contract constitutes a Section 3 covered contract. For example, a contract for the purchase and installation of a furnace would be a Section 3 covered contract because the contract is for work (i.e. the installation of the furnace) and is thereby covered by Section 3.

II. ORDER OF PROVIDING PREFERENCES

**A. Section 3 Residents**

Efforts shall be directed to providing training and employment opportunities to Section 3 residents in the following order of priority:

1. Residents of the Wilmington Housing Authority development or developments for which the Section 3 covered assistance is expended (category 1 residents).
2. Residents of other Wilmington Housing Authority developments managed by the Wilmington Housing Authority (category 2 residents).
3. Participants in HUD Youthbuild programs being carried out in the Wilmington MSA (category 3 residents).
4. Other Section 3 residents of New Hanover County (category 4 residents).
5. Other Section 3 residents of Brunswick County (category 5 residents).

A Section 3 resident seeking employment provided by this part shall certify, in a form suitable to the Wilmington Housing Authority, that they are a Section 3 resident as defined in paragraph I.A. of this document.

## **B. Section 3 Business Concerns**

Efforts shall be directed to award contracts to Section 3 business concerns in the following order of priority.

1. Business concerns that are fifty one percent (51%) or more owned by residents of the Wilmington Housing Authority developments for which the Section 3 covered assistance is expended, or whose full-time, permanent work force includes thirty percent (30%) of these persons as employees (category 1 business);
2. Business concerns that are fifty one percent (51%) or more owned by residents of other Wilmington Housing Authority developments where Section 3 covered assistance is expended, or whose full-time, permanent work force includes thirty percent (30%) of these persons as employees (category 2 business);
3. DOT Youthbuild programs being carried out in the MSA in which the Section 3 covered assistance is expended (category 3 business); and
4. Business concerns that are fifty one percent (51%) or more owned by Section 3 residents or whose permanent, full-time work force includes no less than thirty percent (30%) Section 3 residents or that subcontracts in excess of twenty five percent (25%) of the total amount of subcontracts to business concerns identified in paragraphs (1) and (2) of this section. (category 4 business).

A business concern seeking to qualify for a Section 3 contracting preference shall certify, in a form suitable to Wilmington Housing Authority, that the business concern is a Section 3 concern as defined in paragraph I.B. of this document.

## **III. SECTION 3 GOALS**

### **Employment Opportunities**

Thirty percent (30%) of the aggregate number of new hires for the one year period beginning in FY 1997 (October 1, 1996 through September 30, 1997), and continuing each year thereafter.

### **Contracting Goals**

At least ten percent (10%) of the total dollar amount of all Section 3 Covered contracts for building trades work, for maintenance, repair, modernization or development of public housing, or for



building trades work arising in connection with housing rehabilitation, housing construction and other public construction; and At least three percent (3%) of the total dollar amount of all other Section 3 covered contracts.

### **Good Faith Effort**

Each contractor and subcontractor seeking to establish that a good faith effort, as required by Section 3 of the Housing and Urban Development Act of 1968, as amended, 12 U.S.C. 1701u, has been made to fill all training positions with lower income area residents; and fill all employment positions identified during this project, and shall attempt to recruit from the appropriate areas, the necessary number of lower income residents through local advertising media, signs placed at the proposed site, and community organizations, and public and private institutions operating within or serving the service area.

*End of Section 3 Definition*

**Exhibit I**  
**Section 3 Compliance Plan**  
(See Attached – Fill-in & Signature Required)

### SECTION 3 COMPLIANCE PLAN

(Return to Contract Dept., after completion of project)

Project Name \_\_\_\_\_ Date \_\_\_\_\_

Company Name \_\_\_\_\_

Contact \_\_\_\_\_

Phone Number \_\_\_\_\_ Email \_\_\_\_\_

This Compliance Plan is to be completed by the General Contractor as a part of the bid process.

The general contractor and each subcontractor will be required before the final payment is disbursed to complete a *Section 3 Employment & Contracting Report* for any contract that is a) over \$100,000 or b) for a project at one of the Authority's public housing "WHA" properties.

**Purpose** Section 3 is a clause in the Housing and Urban Development Act of 1968. Its intent is to provide job training and employment opportunities from programs that receive HUD funding to local low income residents and the businesses they own or that employ them.

**Goals** Section 3 residents will comprise of 30% of new hires and Section 3 business concern contracts will comprise of 10% of construction contract dollar amounts, and 3 % of non-construction contract dollar amounts. The contractor must provide documentation of how new employment and business opportunities were directed to the greatest extent feasible to Section 3 residents and business concerns to achieve these goals.

**Contractor Responsibilities** The General Contractor is to ensure their subcontractors are aware of and follow their Section 3 responsibilities.

Document attempts by all contractors to recruit potential Section 3 residents for employment opportunities and Section 3 business concerns for any subcontracting opportunities through methods such as: Washington County Workforce Center website posting, local advertising, mailings, signs placed at the project site, and local community organizations.

#### **New Hires**

Any new full time employment opportunity must be directed to Section 3 residents,

Or

A Section 3 resident is defined as 1) a public housing resident; or 2) a HUD defined low- or very low-income person residing in the New Hanover County metro area. For current fiscal year income limits see HUD Program Income Limits at: <http://www.huduser.org/portal/datasets/il.html>

Or

To be qualified as a Section 3 resident, an applicant must complete a *Section 3 Resident Certification* form.

Contractors will post any new employment opportunities at the **North Carolina Employment Security Exchange** job search website titled as a \_\_\_\_\_.

Maintain a list of all qualified Section 3 residents who apply for employment and a copy of their completed *Section 3 Resident Certification* form(s).

When considering employment of a Section 3 resident, to use the order of priority that gives preference to residents.

Properly document any new hires to complete *Section 3 Employment & Contracting Report*.

Total Number of New Hires \_\_\_\_\_ x 30% = Section 3 Goal \_\_\_\_\_

\*Note: if number equals 1 then the goal should be 1

Describe in the space below the strategies you will implement to hire Section 3 residents.

### **Sub-Contracting Opportunities**

Any subcontracting opportunity must be directed to local Section 3 business concerns,

Or

Section 3 business concerns are businesses that can provide evidence that they meet one of the following:

51 percent or more owned by Section 3 residents;

Or

At least 30 percent of its full time employees include persons that are currently Section 3 residents, or within three years of the date of first employment with the business concern were Section 3 residents;

Or

Provides evidence, as required, of a commitment to subcontract in excess of 25 percent of the dollar award of all subcontracts to be awarded to business concerns that meet the qualifications in either paragraph above.

Or

To be qualified as a Section 3 business concern, a contractor must complete the attached *Section 3 Business Concern Certification* form.

Document any Section 3 business concerns that expressed interest in the sub contracting opportunity and a copy of their completed *Section 3 Business Concern Certification* form.

When considering the award of contracts to business concerns, to use the order of priority as outlined in the Authority's Section 3 Plan that gives preference to businesses that are owned or employ Section 3 residents and is available on HRA website.

To use the *Section 3 Clause* in any subcontract

Properly document any subcontractor bids to complete *Section 3 Employment Compliance Report*.

Construction subcontract total \$ \_\_\_\_\_ x 10% = Section 3 Goal  
\$ \_\_\_\_\_

Non-construction contract total \$ \_\_\_\_\_ x 3% = Section 3 Goal  
\$ \_\_\_\_\_

Describe in the space below the strategies you will implement to hire Section 3 business concerns.

I certify that I had read this Section 3 Compliance Plan and will work to implement all aspects of this program, if feasible.

Signature: \_\_\_\_\_

Print Name: \_\_\_\_\_

Date: \_\_\_\_\_

**Exhibit J**

**Value Engineering**  
(See Attached)

**Value Engineering**  
*of*  
***Playground/Hardscape (Tot Lot) Project***  
*at*  
***Houston Moore***

**Modifications to drawings by Cole Jenest & Stone:**

1. The \$20,000 allowance has been removed from the project and playground boulder (by Rockwerx Inc.) has been specified. The estimated cost of this boulder is \$8,000.

Boulder specifications: Extra Large Boulder by Createk Stone playground Equipment (by Rockwerx Inc.) Boulder size shall be 6' wide X 8' long x 3.5' high and in an arch shape. Item # is customized PBXL1.

Contact information:

Paul Fritz - Paul@srws.com  
Corporate: www.rockwerxclimbing.com  
Toll Free: 877-595-4155 Cell: 443-871-2031 Fax: 410-238-1914

2. 54" Wrought iron fencing has been changed to 48" curved ornamental aluminum fencing.
3. Change foam padding surrounding the play equipment (boulder) to chocolate pine bark mulch.
4. Remove 6" concrete curbing around play area.
5. Changing letters in concrete to painted on concrete.
6. Changing stamped concrete pad to colored concrete and change colored concrete colors to readily available colors (example tan and red.)

**Exhibit K**  
**Notice to Proceed**  
(Provide at Pre Construction Meeting)



**U.S. Department of Housing and  
Urban Development**  
Office of Public and Indian Housing

**Instructions to Bidders for Contracts  
Public and Indian Housing Programs**

# Instructions to Bidders for Contracts

## Public and Indian Housing Programs

### Table of Contents

Clause	Page
1. Bid Preparation and Submission	1
2. Explanations and Interpretations to Prospective Bidders	1
3. Amendments to Invitations for Bids	1
4. Responsibility of Prospective Contractor	1
5. Late Submissions, Modifications, and Withdrawal of Bids	1
6. Bid Opening	2
7. Service of Protest	2
8. Contract Award	2
9. Bid Guarantee	3
10. Assurance of Completion	3
11. Preconstruction Conference	3
12. Indian Preference Requirements	3

### 1. Bid Preparation and Submission

(a) Bidders are expected to examine the specifications, drawings, all instructions, and, if applicable, the construction site (see also the contract clause entitled **Site Investigation and Conditions Affecting the Work** of the *General Conditions of the Contract for Construction*). Failure to do so will be at the bidders' risk.

(b) All bids must be submitted on the forms provided by the Public Housing Agency/Indian Housing Authority (PHA/IHA). Bidders shall furnish all the information required by the solicitation. Bids must be signed and the bidder's name typed or printed on the bid sheet and each continuation sheet which requires the entry of information by the bidder. Erasures or other changes must be initialed by the person signing the bid. Bids signed by an agent shall be accompanied by evidence of that agent's authority. (Bidders should retain a copy of their bid for their records.)

(c) Bidders must submit as part of their bid a completed form HUD-5369-A, "Representations, Certifications, and Other Statements of Bidders."

(d) All bid documents shall be sealed in an envelope which shall be clearly marked with the words "Bid Documents," the Invitation for Bids (IFB) number, any project or other identifying number, the bidder's name, and the date and time for receipt of bids.

(e) If this solicitation requires bidding on all items, failure to do so will disqualify the bid. If bidding on all items is not required, bidders should insert the words "No Bid" in the space provided for any item on which no price is submitted.

(f) Unless expressly authorized elsewhere in this solicitation, alternate bids will not be considered.

(g) Unless expressly authorized elsewhere in this solicitation, bids submitted by telegraph or facsimile (fax) machines will not be considered.

(h) If the proposed contract is for a Mutual Help project (as described in 24 CFR Part 905, Subpart E) that involves Mutual Help contributions of work, material, or equipment, supplemental information regarding the bid advertisement is provided as an attachment to this solicitation.

### 2. Explanations and Interpretations to Prospective Bidders

(a) Any prospective bidder desiring an explanation or interpretation of the solicitation, specifications, drawings, etc., must request it at least 7 days before the scheduled time for bid opening. Requests may be oral or written. Oral requests must be confirmed in writing. The only oral clarifications that will be provided will be those clearly related to solicitation procedures, i.e., not substantive technical information. No other oral explanation or interpretation will be provided. Any information given a prospective bidder concerning this solicitation will be furnished promptly to all other prospective bidders as a written amendment to the solicitation, if that information is necessary in submitting bids, or if the lack of it would be prejudicial to other prospective bidders.

(b) Any information obtained by, or provided to, a bidder other than by formal amendment to the solicitation shall not constitute a change to the solicitation.

### 3. Amendments to Invitations for Bids

(a) If this solicitation is amended, then all terms and conditions which are not modified remain unchanged.

(b) Bidders shall acknowledge receipt of any amendment to this solicitation (1) by signing and returning the amendment, (2) by identifying the amendment number and date on the bid form, or (3) by letter, telegram, or facsimile, if those methods are authorized in the solicitation. The PHA/IHA must receive acknowledgement by the time and at the place specified for receipt of bids. Bids which fail to acknowledge the bidder's receipt of any amendment will result in the rejection of the bid if the amendment(s) contained information which substantively changed the PHA's/IHA's requirements.

(c) Amendments will be on file in the offices of the PHA/IHA and the Architect at least 7 days before bid opening.

### 4. Responsibility of Prospective Contractor

(a) The PHA/IHA will award contracts only to responsible prospective contractors who have the ability to perform successfully under the terms and conditions of the proposed contract. In determining the responsibility of a bidder, the PHA/IHA will consider such matters as the bidder's:

- (1) Integrity;
- (2) Compliance with public policy;
- (3) Record of past performance; and
- (4) Financial and technical resources (including construction and technical equipment).

(b) Before a bid is considered for award, the bidder may be requested by the PHA/IHA to submit a statement or other documentation regarding any of the items in paragraph (a) above. Failure by the bidder to provide such additional information shall render the bidder nonresponsible and ineligible for award.

## 5. Late Submissions, Modifications, and Withdrawal of Bids

(a) Any bid received at the place designated in the solicitation after the exact time specified for receipt will not be considered unless it is received before award is made and it:

(1) Was sent by registered or certified mail not later than the fifth calendar day before the date specified for receipt of offers (e.g., an offer submitted in response to a solicitation requiring receipt of offers by the 20th of the month must have been mailed by the 15th);

(2) Was sent by mail, or if authorized by the solicitation, was sent by telegram or via facsimile, and it is determined by the PHA/IHA that the late receipt was due solely to mishandling by the PHA/IHA after receipt at the PHA/IHA; or

(3) Was sent by U.S. Postal Service Express Mail Next Day Service - Post Office to Addressee, not later than 5:00 p.m. at the place of mailing two working days prior to the date specified for receipt of proposals. The term "working days" excludes weekends and observed holidays.

(b) Any modification or withdrawal of a bid is subject to the same conditions as in paragraph (a) of this provision.

(c) The only acceptable evidence to establish the date of mailing of a late bid, modification, or withdrawal sent either by registered or certified mail is the U.S. or Canadian Postal Service postmark both on the envelope or wrapper and on the original receipt from the U.S. or Canadian Postal Service. Both postmarks must show a legible date or the bid, modification, or withdrawal shall be processed as if mailed late. "Postmark" means a printed, stamped, or otherwise placed impression (exclusive of a postage meter machine impression) that is readily identifiable without further action as having been supplied and affixed by employees of the U.S. or Canadian Postal Service on the date of mailing. Therefore, bidders should request the postal clerk to place a hand cancellation bull's-eye postmark on both the receipt and the envelope or wrapper.

(d) The only acceptable evidence to establish the time of receipt at the PHA/IHA is the time/date stamp of PHA/IHA on the proposal wrapper or other documentary evidence of receipt maintained by the PHA/IHA.

(e) The only acceptable evidence to establish the date of mailing of a late bid, modification, or withdrawal sent by Express Mail Next Day Service-Post Office to Addressee is the date entered by the post office receiving clerk on the "Express Mail Next Day Service-Post Office to Addressee" label and the postmark on both the envelope or wrapper and on the original receipt from the U.S. Postal Service. "Postmark" has the same meaning as defined in paragraph (c) of this provision, excluding postmarks of the Canadian Postal Service. Therefore, bidders should request the postal clerk to place a legible hand cancellation bull's eye postmark on both the receipt and Failure by a bidder to acknowledge receipt of the envelope or wrapper.

(f) Notwithstanding paragraph (a) of this provision, a late modification of an otherwise successful bid that makes its terms more favorable to the PHA/IHA will be considered at any time it is received and may be accepted.

(g) Bids may be withdrawn by written notice, or if authorized by this solicitation, by telegram (including mailgram) or facsimile machine transmission received at any time before the exact time set for opening of bids; provided that written confirmation of telegraphic or facsimile withdrawals over the signature of the bidder is mailed and postmarked prior to the specified bid opening time. A bid may be withdrawn in person by a bidder or its authorized representative if, before the exact time set for opening of bids, the identity of the person requesting withdrawal is established and the person signs a receipt for the bid.

## 6. Bid Opening

All bids received by the date and time of receipt specified in the solicitation will be publicly opened and read. The time and place of opening will be as specified in the solicitation. Bidders and other interested persons may be present.

## 7. Service of Protest

(a) Definitions. As used in this provision:

"Interested party" means an actual or prospective bidder whose direct economic interest would be affected by the award of the contract.

"Protest" means a written objection by an interested party to this solicitation or to a proposed or actual award of a contract pursuant to this solicitation.

(b) Protests shall be served on the Contracting Officer by obtaining written and dated acknowledgement from —

[Contracting Officer designate the official or location where a protest may be served on the Contracting Officer]

(c) All protests shall be resolved in accordance with the PHA's/IHA's protest policy and procedures, copies of which are maintained at the PHA/IHA.

## 8. Contract Award

(a) The PHA/IHA will evaluate bids in response to this solicitation without discussions and will award a contract to the responsible bidder whose bid, conforming to the solicitation, will be most advantageous to the PHA/IHA considering only price and any price-related factors specified in the solicitation.

(b) If the apparent low bid received in response to this solicitation exceeds the PHA's/IHA's available funding for the proposed contract work, the PHA/IHA may either accept separately priced items (see 8(e) below) or use the following procedure to determine contract award. The PHA/IHA shall apply in turn to each bid (proceeding in order from the apparent low bid to the high bid) each of the separately priced bid deductible items, if any, in their priority order set forth in this solicitation. If upon the application of the first deductible item to all initial bids, a new low bid is within the PHA's/IHA's available funding, then award shall be made to that bidder. If no bid is within the available funding amount, then the PHA/IHA shall apply the second deductible item. The PHA/IHA shall continue this process until an evaluated low bid, if any, is within the PHA's/IHA's available funding. If upon the application of all deductibles, no bid is within the PHA's/IHA's available funding, or if the solicitation does not request separately priced deductibles, the PHA/IHA shall follow its written policy and procedures in making any award under this solicitation.

(c) In the case of tie low bids, award shall be made in accordance with the PHA's/IHA's written policy and procedures.

(d) The PHA/IHA may reject any and all bids, accept other than the lowest bid (e.g., the apparent low bid is unreasonably low), and waive informalities or minor irregularities in bids received, in accordance with the PHA's/IHA's written policy and procedures.

(e) Unless precluded elsewhere in the solicitation, the PHA/IHA may accept any item or combination of items bid.

(f) The PHA/IHA may reject any bid as nonresponsive if it is materially unbalanced as to the prices for the various items of work to be performed. A bid is materially unbalanced when it is based on prices significantly less than cost for some work and prices which are significantly overstated for other work.

(g) A written award shall be furnished to the successful bidder within the period for acceptance specified in the bid and shall result in a binding contract without further action by either party.

#### **9. Bid Guarantee (applicable to construction and equipment contracts exceeding \$25,000)**

All bids must be accompanied by a negotiable bid guarantee which shall not be less than five percent (5%) of the amount of the bid. The bid guarantee may be a certified check, bank draft, U.S. Government Bonds at par value, or a bid bond secured by a surety company acceptable to the U.S. Government and authorized to do business in the state where the work is to be performed. In the case where the work under the contract will be performed on an Indian reservation area, the bid guarantee may also be an irrevocable Letter of Credit (see provision 10, Assurance of Completion, below). Certified checks and bank drafts must be made payable to the order of the PHA/IHA. The bid guarantee shall insure the execution of the contract and the furnishing of a method of assurance of completion by the successful bidder as required by the solicitation. Failure to submit a bid guarantee with the bid shall result in the rejection of the bid. Bid guarantees submitted by unsuccessful bidders will be returned as soon as practicable after bid opening.

#### **10. Assurance of Completion**

(a) Unless otherwise provided in State law, the successful bidder shall furnish an assurance of completion prior to the execution of any contract under this solicitation. This assurance may be [Contracting Officer check applicable items] —

[ ] (1) a performance and payment bond in a penal sum of 100 percent of the contract price; or, as may be required or permitted by State law;

[ ] (2) separate performance and payment bonds, each for 50 percent or more of the contract price;

[ ] (3) a 20 percent cash escrow;

[ ] (4) a 25 percent irrevocable letter of credit; or,

[ ] (5) an irrevocable letter of credit for 10 percent of the total contract price with a monitoring and disbursements agreement with the IHA (applicable only to contracts awarded by an IHA under the Indian Housing Program).

(b) Bonds must be obtained from guarantee or surety companies acceptable to the U.S. Government and authorized to do business in the state where the work is to be performed. Individual sureties will not be considered. U.S. Treasury Circular Number 570, published annually in the Federal Register, lists companies approved to act as sureties on bonds securing Government contracts, the maximum underwriting limits on each contract bonded, and the States in which the company is licensed to do business. Use of companies listed in this circular is mandatory. Copies of the circular may be downloaded on the U.S. Department of Treasury website <http://www.fms.treas.gov/c570/index.html>, or ordered for a minimum fee by contacting the Government Printing Office at (202) 512-2168.

(c) Each bond shall clearly state the rate of premium and the total amount of premium charged. The current power of attorney for the person who signs for the surety company must be attached to the bond. The effective date of the power of attorney shall not precede the date of the bond. The effective date of the bond shall be on or after the execution date of the contract.

(d) Failure by the successful bidder to obtain the required assurance of completion within the time specified, or within such extended period as the PHA/IHA may grant based upon reasons determined adequate by the PHA/IHA, shall render the bidder ineligible for award. The PHA/IHA may then either award the contract to the next lowest responsible bidder or solicit new bids. The PHA/IHA may retain the ineligible bidder's bid guarantee.

#### **11. Preconstruction Conference (applicable to construction contracts)**

After award of a contract under this solicitation and prior to the start of work, the successful bidder will be required to attend a preconstruction conference with representatives of the PHA/IHA and its architect/engineer, and other interested parties convened by the PHA/IHA. The conference will serve to acquaint the participants with the general plan of the construction operation and all other requirements of the contract (e.g., Equal Employment Opportunity, Labor Standards). The PHA/IHA will provide the successful bidder with the date, time, and place of the conference.

#### **12. Indian Preference Requirements (applicable only if this solicitation is for a contract to be performed on a project for an Indian Housing Authority)**

(a) HUD has determined that the contract awarded under this solicitation is subject to the requirements of section 7(b) of the Indian Self-Determination and Education Assistance Act (25 U.S.C. 450e(b)). Section 7(b) requires that any contract or subcontract entered into for the benefit of Indians shall require that, to the greatest extent feasible

(1) Preferences and opportunities for training and employment (other than core crew positions; see paragraph (h) below) in connection with the administration of such contracts or subcontracts be given to qualified "Indians." The Act defines "Indians" to mean persons who are members of an Indian tribe and defines "Indian tribe" to mean any Indian tribe, band, nation, or other organized group or community, including any Alaska Native village or regional or village corporation as defined in or established pursuant to the Alaska Native Claims Settlement Act, which is recognized as eligible for the special programs and services provided by the United States to Indians because of their status as Indians; and,

(2) Preference in the award of contracts or subcontracts in connection with the administration of contracts be given to Indian organizations and to Indian-owned economic enterprises, as defined in section 3 of the Indian Financing Act of 1974 (25 U.S.C. 1452). That Act defines "economic enterprise" to mean any Indian-owned commercial, industrial, or business activity established or organized for the purpose of profit, except that the Indian ownership must constitute not less than 51 percent of the enterprise; "Indian organization" to mean the governing body of any Indian tribe or entity established or recognized by such governing body; "Indian" to mean any person who is a member of any tribe, band, group, pueblo, or community which is recognized by the Federal Government as eligible for services from the Bureau of Indian Affairs and any "Native" as defined in the Alaska Native Claims Settlement Act; and Indian "tribe" to mean any Indian tribe, band, group, pueblo, or community including Native villages and Native groups (including

corporations organized by Kenai, Juneau, Sitka, and Kodiak) as defined in the Alaska Native Claims Settlement Act, which is recognized by the Federal Government as eligible for services from the Bureau of Indian Affairs.

(b) (1) The successful Contractor under this solicitation shall comply with the requirements of this provision in awarding all subcontracts under the contract and in providing training and employment opportunities.

(2) A finding by the IHA that the contractor, either (i) awarded a subcontract without using the procedure required by the IHA, (ii) falsely represented that subcontracts would be awarded to Indian enterprises or organizations; or, (iii) failed to comply with the contractor's employment and training preference bid statement shall be grounds for termination of the contract or for the assessment of penalties or other remedies.

(c) If specified elsewhere in this solicitation, the IHA may restrict the solicitation to qualified Indian-owned enterprises and Indian organizations. If two or more (or a greater number as specified elsewhere in the solicitation) qualified Indian-owned enterprises or organizations submit responsive bids, award shall be made to the qualified enterprise or organization with the lowest responsive bid. If fewer than the minimum required number of qualified Indian-owned enterprises or organizations submit responsive bids, the IHA shall reject all bids and readvertise the solicitation in accordance with paragraph (d) below.

(d) If the IHA prefers not to restrict the solicitation as described in paragraph (c) above, or if after having restricted a solicitation an insufficient number of qualified Indian enterprises or organizations submit bids, the IHA may advertise for bids from non-Indian as well as Indian-owned enterprises and Indian organizations. Award shall be made to the qualified Indian enterprise or organization with the lowest responsive bid if that bid is -

(1) Within the maximum HUD-approved budget amount established for the specific project or activity for which bids are being solicited; and

(2) No more than the percentage specified in 24 CFR 905.175(c) higher than the total bid price of the lowest responsive bid from any qualified bidder. If no responsive bid by a qualified Indian-owned economic enterprise or organization is within the stated range of the total bid price of the lowest responsive bid from any qualified enterprise, award shall be made to the bidder with the lowest bid.

(e) Bidders seeking to qualify for preference in contracting or subcontracting shall submit proof of Indian ownership with their bids. Proof of Indian ownership shall include but not be limited to:

(1) Certification by a tribe or other evidence that the bidder is an Indian. The IHA shall accept the certification of a tribe that an individual is a member.

(2) Evidence such as stock ownership, structure, management, control, financing and salary or profit sharing arrangements of the enterprise.

(f) (1) All bidders must submit with their bids a statement describing how they will provide Indian preference in the award of subcontracts. The specific requirements of that statement and the factors to be used by the IHA in determining the statement's adequacy are included as an attachment to this solicitation. Any bid that fails to include the required statement shall be rejected as nonresponsive. The IHA may require that comparable statements be provided by subcontractors to the successful Contractor, and may require the Contractor to reject any bid or proposal by a subcontractor that fails to include the statement.

(2) Bidders and prospective subcontractors shall submit a certification (supported by credible evidence) to the IHA in any instance where the bidder or subcontractor believes it is infeasible to provide Indian preference in subcontracting. The acceptance or rejection by the IHA of the certification shall be final. Rejection shall disqualify the bid from further consideration.

(g) All bidders must submit with their bids a statement detailing their employment and training opportunities and their plans to provide preference to Indians in implementing the contract; and the number or percentage of Indians anticipated to be employed and trained. Comparable statements from all proposed subcontractors must be submitted. The criteria to be used by the IHA in determining the statement(s)'s adequacy are included as an attachment to this solicitation. Any bid that fails to include the required statement(s), or that includes a statement that does not meet minimum standards required by the IHA shall be rejected as nonresponsive.

(h) Core crew employees. A core crew employee is an individual who is a bona fide employee of the contractor at the time the bid is submitted; or an individual who was not employed by the bidder at the time the bid was submitted, but who is regularly employed by the bidder in a supervisory or other key skilled position when work is available. Bidders shall submit with their bids a list of all core crew employees.

(i) Preference in contracting, subcontracting, employment, and training shall apply not only on-site, on the reservation, or within the IHA's jurisdiction, but also to contracts with firms that operate outside these areas (e.g., employment in modular or manufactured housing construction facilities).

(j) Bidders should contact the IHA to determine if any additional local preference requirements are applicable to this solicitation.

(k) The IHA [ ] does [ ] does not [Contracting Officer check applicable box] maintain lists of Indian-owned economic enterprises and Indian organizations by specialty (e.g., plumbing, electrical, foundations), which are available to bidders to assist them in meeting their responsibility to provide preference in connection with the administration of contracts and subcontracts.



1524 South 16th Street Wilmington, NC 28401 • V 910.341.7700 • F 910.341.7760 • TDD 910.341.7740 • <http://wha.net>

## SCOPE OF WORK PLAYGROUND/HARDSCAPE (TOT LOT) PROJECT

### **Staking Plan revision summary:**

- A portion of the existing sidewalk is to be removed to accommodate the new tricycle track.
- No detail will be provided for the electrical connection for power for the gate. For bidding purposes the electrical panel that will be tied into is approximately 100 feet from the gate and access into the building will be made through the soffit material and above an existing acoustic tile ceiling.
- Note on toddler scale fountain has been revised to include a “freeze proof” equipment. Additionally, connection to existing water lines can be made approximately 25 feet from the fountain.
- Note 10: “All landscaping by others. “ To clarify, all shrubs and tree plantings have been removed from this scope and have been shown for reference purposes only.
- Note 8 should reference the northeast corner of the project not the northwest.
- The note for the play surface under the equipment should say “Poured in place or pre-manufactured play surface with a minimum fall protection of 48”.

### **Planting Plan revision summary:**

- Bermuda sod shall be used where sod is specified.
- Again, all shrubs and trees have been removed from the scope of work and are shown for reference only.
- The area under the oak tree was changed from “PROPOSED 4” SHREDDED PINE BARK MULCH” to “AREA TO BE LEFT AS CURRENTLY EXISTS: SAND”.
- The area under the playground equipment has been changed from “PROPOSED 8” DEEP ENGINEERED MULCH” to reference the foam surface.

# Supplementary Conditions of the Contract for Construction

U.S. Department of Housing  
and Urban Development  
Office of Housing  
Federal Housing Commissioner

OMB Approval No. 2502-0470  
(Expires 5/31/2010)

Public reporting burden for this collection of information is estimated to average 30 minutes per response, including the time for reviewing instructions, searching existing data sources, gathering and maintaining the data needed, and completing and reviewing the collection of information. This information is required to obtain benefits and voluntary. HUD may not collect this information, and you are not required to complete this form, unless it displays a currently valid OMB control number.

This information collection is necessary to ensure that viable projects are developed. It is important to obtain information from applicants to assist HUD in determining if nonprofit organizations initially funded continue to have the financial and administrative capacity needed to develop a project and that the project design meets the needs of the residents. The Department will use this information to set forth the obligations of the contractor or subcontractor performing under the covered contract. This information is required in order to obtain benefits. This information is considered non-sensitive and no assurance of confidentiality is provided.

## Article 1 – Labor Standards

### Instructions

Whenever only FHA mortgage insurance is involved, use paragraph (A) and (C) of Article 1 – Labor Standards. Whenever any direct form of assistance (Section 8, Section 202/811 Capital Advance, grants etc.) is involved, use paragraphs (A) and (B) and (C) of Article 1 – Labor Standards.

### Applicability

The Project or Program to which the construction work covered by this contract pertains is being assisted or insured by the United States of America and the following Federal Labor Standards Provisions are included in this Contract or related instrument pursuant to the provisions applicable to such Federal assistance or insurance.

**A. 1. (i) Minimum Wages.** All laborers and mechanics employed or working upon the site of the work (or under the United States Housing Act of 1937 or under the Housing Act of 1949 in the construction or development of the project), will be paid unconditionally and not less often than once a week, and without subsequent deduction or rebate on any account (except such payroll deductions as are permitted by regulations issued by the Secretary of Labor under the Copeland Act (29 CFR Part 3), the full amount of wages and bona fide fringe benefits (or cash equivalents thereof) due at time of payment computed at rates not less than those contained in the wage determination of the Secretary of Labor which is attached hereto and made a part hereof, regardless of any contractual relationship which may be alleged to exist between the contractor and such laborers and mechanics. Contributions made or costs reasonably anticipated for bona fide fringe benefits under Section 1(b)(2) of the Davis-Bacon Act on behalf of laborers or mechanics are considered wages paid to such laborers or mechanics, subject to the provisions of 29 CFR 5.5(a)(1)(iv); also, regular contributions made or costs incurred for more than a weekly period (but not less often than quarterly) under plans, funds, or programs, which cover the particular weekly period, are deemed to be constructively made or incurred during such weekly period.

Such laborers and mechanics shall be paid the appropriate wage rate and fringe benefits on the wage determination for the classification of work actually performed, without regard to skill, except as provided in 29 CFR Part 5.5(a)(4). Laborers or mechanics performing work in more than one classification may be compensated at the rate specified for each classification for the time actually worked therein: Provided, That the employer's payroll records accurately set forth the time spent in each classification in which work is performed. The wage determination (including any additional classification and wage rates conformed under 29 CFR Part 5.5(a)(1)(ii) and the Davis-Bacon poster (WH-1321) shall be posted at all times by the contractor and its subcontractors at the site of the work in a prominent and accessible place where it can be easily seen by the workers.

(ii) (a) Any class of laborers or mechanics which is not listed in the wage determination and which is to be employed under the contract shall be classified in conformance with the wage determination. HUD shall approve an additional classification and wage rate and fringe benefits therefore only when the following criteria have been met:

(1) The work to be performed by the classification

requested is not performed by a classification in the wage determination; and

(2) The classification is utilized in the area by the construction industry; and

(3) The proposed wage rate, including any bona fide fringe benefits, bears a reasonable relationship to the wage rates contained in the wage determination.

(b) If the contractor and the laborers and mechanics to be employed in the classification (if known), or their representatives, and HUD or its designee agree on the classification and wage rate (including the amount designated for fringe benefits where appropriate), a report of the action taken shall be sent by HUD or its designee to the Administrator of the Wage and Hour Division, Employment Standards Administration, U.S. Department of Labor, Washington, D.C. 20210. The Administrator, or an authorized representative, will approve, modify, or disapprove every additional classification action within 30 days of receipt and so advise HUD or its designee or will notify HUD or its designee within the 30-day period that additional time is necessary. (Approved by the Office of Management and Budget under OMB control number 1215-0140.)

(c) In the event the contractor, the laborers or mechanics to be employed in the classification or their representatives, and HUD or its designee do not agree on the proposed classification and wage rate (including the amount designated for fringe benefits, where appropriate), HUD or its designee shall refer the questions, including the views of all interested parties and the recommendation of HUD or its designee, to the Administrator for determination. The Administrator, or an authorized representative, will issue a determination within 30 days of receipt and so advise HUD or its designee or will notify HUD or its designee within the 30-day period that additional time is necessary. (Approved by the Office of Management and Budget under OMB Control Number 1215-0140.)

(d) The wage rate (including fringe benefits where appropriate) determined pursuant to subparagraphs A.1.(ii)(b) or (c) of this paragraph, shall be paid to all workers performing work in the classification under this contract from the first day on which work is performed in the classification.

(iii) Whenever the minimum wage rate prescribed in the contract for a class of laborers or mechanics includes a fringe benefit which is not expressed as an hourly rate, the contractor shall either pay the benefit as stated in the wage determination or shall pay another bona fide fringe benefit or an hourly cash equivalent thereof.

(iv) If the contractor does not make payments to a trustee or other third person, the contractor may consider as part of the wages of any laborer or mechanic the amount of any costs reasonably anticipated in providing bona fide fringe benefits under a plan or program, Provided, That the Secretary of Labor has found, upon the written request of the contractor, that the applicable standards of the Davis-Bacon Act have been met. The Secretary of Labor may require the contractor to set aside in a separate account assets for the meeting of obligations under the plan or program. (Approved by the Office of Management and Budget under OMB Control Number 1215-0140.)

**2. Withholding.** HUD or its designee shall upon its own action or upon written request of an authorized representative of the Department of Labor withhold or cause to be withheld from the contractor under this contract or any other Federal contract with the

same prime contractor, or any other Federally-assisted contract subject to Davis-Bacon prevailing wage requirements, which is held by the same prime contractor so much of the accrued payments or advances as may be considered necessary to pay laborers and mechanics, including apprentices, trainees and helpers, employed by the contractor or any subcontractor the full amount of wages required by the contract. In the event of failure to pay any laborer or mechanic, including any apprentice, trainee or helper, employed or working on the site of the work (or under the United States Housing Act of 1937 or under the Housing Act of 1949 in the construction or development of the project), all or part of the wages required by the contract, HUD or its designee may, after written notice to the contractor, sponsor, applicant, or owner, take such action as may be necessary to cause the suspension of any further payment, advance, or guarantee of funds until such violations have ceased. HUD or its designee may, after written notice to the contractor, disburse such amounts withheld for and on account of the contractor or subcontractor to the respective employees to whom they are due. The Comptroller General shall make such disbursements in the case of direct Davis-Bacon Act contracts.

**3. (i) Payrolls and basic records.** Payrolls and basic records relating thereto shall be maintained by the contractor during the course of the work and preserved for a period of three years thereafter for all laborers and mechanics working at the site of the work (or under the United States Housing Act of 1937, or under the Housing Act of 1949, in the construction or development of the project). Such records shall contain the name, address, and social security number of each such worker, his or her correct classification, hourly rates of wages paid (including rates of contributions or costs anticipated for bona fide fringe benefits or cash equivalents thereof of the types described in Section 1(b)(2)(B) of the Davis-Bacon Act), daily and weekly number of hours worked, deductions made and actual wages paid. Whenever the Secretary of Labor has found under 29 CFR 5.5(a)(1)(iv) that the wages of any laborer or mechanic include the amount of any costs reasonably anticipated in providing benefits under a plan or program described in Section 1(b)(2)(B) of the Davis-Bacon Act, the contractor shall maintain records which show that the commitment to provide such benefits is enforceable, that the plan or program is financially responsible, and that the plan or program has been communicated in writing to the laborers or mechanics affected, and records which show the costs anticipated or the actual cost incurred in providing such benefits. Contractors employing apprentices or trainees under approved programs shall maintain written evidence of the registration of apprenticeship programs and certification of trainee programs, the registration of the apprentices and trainees, and the ratios and wage rates prescribed in the applicable programs. (Approved by the Office of Management and budget under OMB Control Numbers 1215-0140 and 1215-0017.)

**(ii) (a)** The contractor shall submit weekly for each week in which any contract work is performed a copy of all payrolls to HUD or its designee if the agency is a party to the contract, but if the agency is not such a party, the contractor will submit the payrolls to the applicant, sponsor, or owner, as the case may be, for transmission to HUD or its designee. The payrolls submitted shall set out accurately and completely all of the information required to be maintained under 29 CFR Part 5.5(a)(3)(i). This information may be submitted in any form desired. Optional Form WH-347 is available for this purpose and may be purchased from the Superintendent of Documents (Federal Stock Number 029-005-00014-1), U.S. Government Printing Office, Washington, D.C. 20402. The prime contractor is responsible for the submission of copies of payrolls by all subcontractors. (Approved by the Office of Management and Budget under OMB Control Number 1215-0149.)

**(b)** Each payroll submitted shall be accompanied by a "Statement of Compliance," signed by the contractor or subcontractor or his or her agent who pays or supervises the payment of the persons employed under the contract and shall certify the following:

- (1)** That the payroll for the payroll period contains the information required to be maintained under 29 CFR Part 5.5(a)(3)(i) and that such information is correct and complete;
- (2)** That each laborer or mechanic (including each

helper, apprentice, and trainee) employed on the contract during the payroll period has been paid the full weekly wages earned, without rebate, either directly or indirectly, and that no deductions have been made either directly or indirectly from the full wages earned, other than permissible deductions as set forth in 29 CFR Part 3;

**(3)** That each laborer or mechanic has been paid not less than the applicable wage rates and fringe benefits or cash equivalents for the classification of work performed, as specified in the applicable wage determination incorporated into the contract.

**(c)** The weekly submission of a properly executed certification set forth on the reverse side of Optional Form WH-347 shall satisfy the requirement for submission of the "Statement of Compliance" required by paragraph A.3.(ii)(b) of this section.

**(d)** The falsification of any of the above certifications may subject the contractor or subcontractor to civil or criminal prosecution under Section 1001 of Title 18 and Section 231 of Title 31 of the United States Code.

**(iii)** The contractor or subcontractor shall make the records required under paragraph A.3.(i) of this section available for inspection, copying, or transcription by authorized representatives of HUD or its designee or the Department of Labor, and shall permit such representatives to interview employees during working hours on the job. If the contractor or subcontractor fails to submit the required records or to make them available, HUD or its designee may, after written notice to the contractor, sponsor, applicant, or owner, take such action as may be necessary to cause the suspension of any further payment, advance, or guarantee of funds. Furthermore, failure to submit the required records upon request or to make such records available may be grounds for debarment action pursuant to 29 CFR Part 5.12.

**4. (i) Apprentices and Trainees. Apprentices.** Apprentices will be permitted to work at less than the predetermined rate for the work they performed when they are employed pursuant to and individually registered in a bona fide apprenticeship program registered with the U.S. Department of Labor, Employment and Training Administration, Bureau of Apprenticeship and Training, or with a State Apprenticeship Agency recognized by the Bureau, or if a person is employed in his or her first 90 days of probationary employment as an apprentice in such an apprenticeship program, who is not individually registered in the program, but who has been certified by the Bureau of Apprenticeship and Training or a State Apprenticeship Agency (where appropriate) to be eligible for probationary employment as an apprentice. The allowable ratio of apprentices to journeymen on the job site in any craft classification shall not be greater than the ratio permitted to the contractor as to the entire work force under the registered program. Any worker listed on a payroll at an apprentice wage rate, who is not registered or otherwise employed as stated above, shall be paid not less than the applicable wage rate on the wage determination for the classification of work actually performed. In addition, any apprentice performing work on the job site in excess of the ratio permitted under the registered program shall be paid not less than the applicable wage rate on the wage determination for the work actually performed. Where a contractor is performing construction on a project in a locality other than that in which its program is registered, the ratios and wage rates (expressed in percentages of the journeyman's hourly rate) specified in the contractor's or subcontractor's registered program shall be observed. Every apprentice must be paid at not less than the rate specified in the registered program for the apprentice's level of progress, expressed as a percentage of the journeymen hourly rate specified in the applicable wage determination. Apprentices shall be paid fringe benefits in accordance with the provisions of the apprenticeship program. If the apprenticeship program does not specify fringe benefits, apprentices must be paid the full amount of fringe benefits listed on the wage determination for the applicable classification. If the Administrator determines that a different practice prevails for the applicable apprentice classification, fringes shall be paid in accordance with that determination. In the event the Bureau



of Apprenticeship and Training, or a State Apprenticeship Agency recognized by the Bureau, withdraws approval of an apprenticeship program, the contractor will no longer be permitted to utilize apprentices at less than the applicable predetermined rate for the work performed until an acceptable program is approved.

**(ii) Trainees.** Except as provided in 29 CFR 5.16, trainees will not be permitted to work at less than the predetermined rate for the work performed unless they are employed pursuant to and individually registered in a program which has received prior approval, evidenced by formal certification by the U.S. Department of Labor, Employment and Training Administration. The ratio of trainees to journeymen on the job site shall not be greater than permitted under the plan approved by the Employment and Training Administration. Every trainee must be paid at not less than the rate specified in the approved program for the trainee's level of progress, expressed as a percentage of the journeyman's hourly rate specified in the applicable wage determination. Trainees shall be paid fringe benefits in accordance with the provisions of the trainee program. If the trainee program does not mention fringe benefits, trainees shall be paid the full amount of fringe benefits listed on the wage determination unless the Administrator of the Wage and Hour Division determines that there is an apprenticeship program associated with the corresponding journeyman wage rate on the wage determination which provides for less than full fringe benefits for apprentices. Any employee listed on the payroll at a trainee rate who is not registered and participating in a training plan approved by the Employment and Training Administration shall be paid not less than the applicable wage rate on the wage determination for the classification of work actually performed. In addition, any trainee performing work on the job site in excess of the ratio permitted under the registered program shall be paid not less than the applicable wage rate on the wage determination for the work actually performed. In the event the Employment and Training Administration withdraws approval of a training program, the contractor will no longer be permitted to utilize trainees at less than the applicable predetermined rate for the work performed until an acceptable program is approved.

**(iii) Equal employment opportunity.** The utilization of apprentices, trainees and journeymen under this part shall be in conformity with the equal employment opportunity requirements of Executive Order 11246, as amended, and 29 CFR Part 30.

**5. Compliance with Copeland Act Requirements.** The contractor shall comply with the requirements of 29 CFR Part 3 which are incorporated by reference in this contract.

**6. Subcontracts.** The contractor or subcontractor will insert in any subcontracts the clauses contained in 29 CFR 5.5(a)(1) through (10) and such other clauses as HUD or its designee may be appropriate instructions require, and also a clause requiring the subcontractors to include these clauses in any lower tier subcontracts. The prime contractor shall be responsible for the compliance by any subcontractor or lower tier subcontractor with all the contract clauses in 29 CFR Part 5.5.

**7. Contract termination; debarment.** A breach of the contract clauses in 29 CFR 5.5 may be grounds for termination of the contract, and for debarment as a contractor and a subcontractor as provided in 29 CFR 5.12.

**8. Compliance with Davis-Bacon and Related Act Requirements.** All rulings and interpretations of the Davis-Bacon and Related Acts contained in 29 CFR Parts 1, 3, and 5 are herein incorporated by reference in this contract.

**9. Disputes concerning labor standards.** Disputes arising out of the labor standards provisions of this contract shall not be subject to the general disputes clause of this contract. Such disputes shall be resolved in accordance with the procedures of the Department of Labor set forth in 29 CFR Parts 5, 6, and 7. Disputes within the meaning of this clause include disputes between the contractor (or any of its subcontractors) and HUD or its designee, the U.S. Department of Labor, or the employees or their representatives.

**10. (i) Certification of Eligibility.** By entering into this contract the contractor certifies neither it (nor he or she) nor any person or firm who has an interest in the contractor's firm is a person or firm

ineligible to be awarded Government contracts by virtue of Section 3(a) of the Davis-Bacon Act or 29 CFR 5.12(a)(1) or to be awarded HUD contracts or participate in HUD programs pursuant to 24 CFR Part 24.

**(ii)** No part of this contract shall be subcontracted to any person or firm ineligible for award of a Government contract by virtue of Section 3(a) of the Davis-Bacon Act or 29 CFR 5.12(a)(1) or to be awarded HUD contracts or participate in HUD programs pursuant to 24 CFR Part 24.

**(iii)** The penalty for making false statements is prescribed in the U.S. Criminal Code, 18 U.S.C. 1001. Additionally, U.S. Criminal Code, Section 1010, Title 18, U.S.C., "Federal Housing Administration transactions", provides in part: "Whoever, for the purpose of . . . influencing in any way the action of such Administration . . . makes, utters or publishes any statement, knowing the same to be false . . . shall be fined not more than \$5,000 or imprisoned not more than two years, or both."

**B. Contract Work Hours and Safety Standards Act.** As used in this paragraph, the terms "laborers" and "mechanics" include watchmen and guards.

**1. Overtime requirements.** No contractor or subcontractor contracting for any part of the contract work which may require or involve the employment of laborers or mechanics shall require or permit any such laborer or mechanic in any workweek in which he or she is employed on such work to work in excess of forty hours in such workweek unless such laborer or mechanic receives compensation at a rate not less than one and one-half times the basic rate of pay for all hours worked in excess of forty hours in such workweek.

**2. Violation; liability for unpaid wages, liquidated damages.** In the event of any violation of the clause set forth in subparagraph (1) of this paragraph, the contractor and any subcontractor responsible therefore shall be liable for the unpaid wages. In addition, such contractor and subcontractor shall be liable to the United States (in the case of work done under contract for the District of Columbia or a territory, to such District or to such territory), for liquidated damages. Such liquidated damages shall be computed with respect to each individual laborer or mechanic, including watchmen and guards, employed in violation of the clause set forth in subparagraph (1) of this paragraph, in the sum of \$10 for each calendar day on which such individual was required or permitted to work in excess of the standard workweek of forty hours without payment of the overtime wages required by the clause set forth in subparagraph (1) of this paragraph.

**3. Withholding for unpaid wages and liquidated damages.** HUD or its designee shall upon its own action or upon written request of an authorized representative of the Department of Labor withhold or cause to be withheld, from any moneys payable on account of work performed by the contractor or subcontractor under any such contract or any other Federal contract with the same prime contractor, or any other Federally-assisted contract subject to the Contract Work Hours and Safety Standards Act, which is held by the same prime contractor such sums as may be determined to be necessary to satisfy any liabilities of such contractor or subcontractor for unpaid wages and liquidated damages as provided in the clause set forth in subparagraph (2) of this paragraph.

**4. Subcontracts.** The contractor or subcontractor shall insert in any subcontracts the clauses set forth in subparagraph (1) through (4) of this paragraph and also a clause requiring the subcontractors to include these clauses in any lower tier subcontracts. The prime contractor shall be responsible for compliance by any subcontractor or lower tier subcontractor with the clauses set forth in subparagraphs (1) through (4) of this paragraph.

**C.** The Contractor will be required to execute FHA Form No. 2403-A, Contractor's Prevailing Wage Certificate, as a condition precedent to insurance by the Federal Housing Administration of that certain mortgage loan, or an advance thereof, made or to be made by the mortgagee in connection with the construction of the project.

## Article 2 – Equal Employment Opportunity

The applicant hereby agrees that it will incorporate or cause to be

incorporated into any contract for construction work, or modification thereof, as defined in the regulations of the Secretary of Labor at 41 CFR Chapter 60, which is paid for in whole or in part with funds obtained from the Federal Government or borrowed on the credit of the Federal Government pursuant to a grant, contract, loan insurance, or guarantee, or undertaken pursuant to any Federal program involving such grant, contract, loan, insurance, or guarantee, the following equal opportunity clause:

During the performance of this contract, the Contractor agrees as follows:

**A.** The Contractor will not discriminate against any employee or applicant for employment because of race, color, religion, sex, or national origin. The Contractor will take affirmative action to ensure that applicants are employed, and that employees are treated during employment without regard to their race, color, religion, sex or national origin. Such action shall include, but not be limited to the following: Employment, upgrading, demotion, or transfer; recruitment or recruitment advertising; layoff or termination; rates of pay or other forms of compensation; and selection for training including apprenticeship. The Contractor agrees to post in conspicuous places available to employees and applicants for employment notices to be provided setting forth the provisions of this nondiscrimination clause.

**B.** The Contractor will, in all solicitations or advertisements for employees placed by or on behalf of the Contractor state that all qualified applicants will receive consideration for employment without regard to race, color, religion, sex, or national origin.

**C.** The Contractor will send to each labor union or representative of workers with which it has a collective bargaining agreement or other contract or understanding a notice to be provided advising the said labor union or workers representatives of the Contractor's commitments hereunder, and shall post copies of the notice in conspicuous places available to employees and applicants for employment.

**D.** The Contractor will comply with all provisions of Executive Order 11246 of September 24, 1965 and of the rules, regulations, and relevant orders of the Secretary of Labor.

**E.** The Contractor will furnish all information and reports required by Executive Order 11246 of September 24, 1965, and by rules, regulations, and orders of the Secretary of Labor, or pursuant thereto, and will permit access to its books, records, and accounts by the Secretary of Labor for purposes of investigation to ascertain compliance with such rules, regulations, and orders.

**F.** In the event of the Contractor's noncompliance with the nondiscrimination clauses of this contract or with any of the said rules, regulations, or orders, this contract may be canceled, terminated, or suspended in whole or in part and the Contractor may be declared ineligible for further government contracts or federally assisted construction contracts in accordance with procedures authorized in Executive Order 11246 of September 24, 1965, and such other sanctions may be imposed and remedies invoked as provided in Executive Order 11246 of September 24, 1965, or by rule, regulations or order of the Secretary of Labor, or as otherwise provided by law.

**G.** The Contractor will include the portion of the sentence immediately preceding paragraph A and the provisions of paragraphs A through G in every subcontract or purchase order unless exempted by rules, regulations, or orders of the Secretary of Labor issued pursuant to Section 204 of Executive Order 11246 of September 24, 1965, so that such provisions will be binding upon each subcontractor or vendor. The Contractor will take such action with respect to any subcontract or purchase order as the Secretary of Housing and Urban Development or the Secretary of Labor may direct as a means of enforcing such provisions, including sanctions for noncompliance. *Provided, however,* that in the event the Contractor becomes involved in, or is threatened with, litigation with a subcontractor or vendor as a result of such direction by the Secretary of Housing and Urban Development or the Secretary of Labor, the Contractor may request the United States to enter into such litigation to protect the interests of the United States.

**H.** The applicant further agrees that it will be bound by the above equal opportunity clause with respect to its own employment practices when it participates in federally assisted construction work:

*Provided, That* if the applicant so participating is a State or local government, the above equal opportunity clause is not applicable to any agency, instrumentality or subdivision of such government which does not participate in work on or under the contract.

**I.** The applicant agrees that it will assist and cooperate actively with the administering agency and the Secretary of Labor in obtaining the compliance of contractors and subcontractors with the equal opportunity clause and the rules, regulations, and relevant orders of the Secretary of Labor, that it will furnish the administering agency and the Secretary of Labor such information as they may require for the supervision of such compliance, and that it will otherwise assist the administering agency in the discharge of the agency's primary responsibility for securing compliance.

**J.** The applicant further agrees that it will refrain from entering into any contract or contract modification subject to Executive Order 11246 of September 24, 1965, with a contractor debarred from, or who has not demonstrated eligibility for, Government contracts and federally assisted construction contracts pursuant to the Executive order and will carry out such sanctions and penalties for violation of the equal opportunity clause as may be imposed upon contractors and subcontractors by the administering agency or the Secretary of Labor pursuant to Part II, Subpart D of the Executive order. In addition, the applicant agrees that if it fails or refuses to comply with these undertakings, the administering agency may take any or all of the following actions: Cancel, terminate, or suspend in whole or in part this grant (contract, loan, insurance, guarantee); refrain from extending any further assistance to the applicant under the program with respect to which the failure or refund occurred until satisfactory assurance of future compliance has been received from such applicant; and refer the case to the Department of Justice for appropriate legal proceedings.

### **Article 3 – Equal Opportunity for Businesses and Lower Income Persons Located Within the Project Area**

(Applicable to Section 236 projects, where the estimated replacement cost of the project as determined by the Secretary of Housing and Urban Development exceeds \$500,000, and to all projects, including Section 236 regardless of estimated replacement cost, receiving rent supplement assistance under Title I, Section 101 of the Housing and Urban Development Act of 1965.)

**A.** The work to be performed under this contract is on a project assisted under a program providing direct Federal financial assistance from the Department of Housing and Urban Development and is subject to the requirements of Section 3 of the Housing and Urban Development Act of 1968, as amended, 12 U.S.C. 1701u. Section 3 requires that to the greatest extent feasible opportunities for training and employment be given lower income residents of the unit of local government or the metropolitan area (or nonmetropolitan county) as determined by the Secretary of Housing and Urban Development in which the projects located and contracts for work in connection with the project be awarded to business concerns which are located in, or owned in substantial part by persons residing in the same metropolitan area (or nonmetropolitan county) as the project.

### **Article 4 – Health and Safety**

**A.** No laborer or mechanic shall be required to work in surroundings or under working conditions which are unsanitary, hazardous, or dangerous to his health and safety as determined under construction safety and health standards promulgated by the Secretary of Labor by regulation.

**B.** The Contractor shall comply with all regulations issued by the Secretary of Labor pursuant to Title 29 Part 1926 (formerly part 1518) and failure to comply may result in imposition of sanctions pursuant to the Contract Work Hours and Safety Standards Act (Public Law 91-54, 83 Stat. 96).

**C.** The Contractor shall include the provisions of this Article in every subcontract so that such provisions will be binding on each subcontractor. The Contractor shall take such action with respect to any subcontract as the Secretary of Housing and Urban Development of the Secretary of Labor shall direct as a means of enforcing such provisions.

# General Contract Conditions for Small Construction/Development Contracts

U.S. Department of Housing and Urban Development  
Office of Public and Indian Housing  
OMB Approval No. 2577-0157 (exp. 3/31/2010)

**Applicability.** The following contract clauses are applicable and must be inserted into small construction/development contracts, greater than \$2,000 but not more than \$100,000.

## 1. Definitions

Terms used in this form are the same as defined in form HUD-5370

## 2. Prohibition Against Liens

The Contractor is prohibited from placing a lien on the PHA's property. This prohibition shall apply to all subcontractors at any tier and all materials suppliers. The only liens on the PHA's property shall be the Declaration of Trust or other liens approved by HUD.

## 3. Disputes

- (a) Except for disputes arising under the **Labor Standards** clauses, all disputes arising under or relating to this contract, including any claims for damages for the alleged breach thereof which are not disposed of by agreement, shall be resolved under this clause.
- (b) All claims by the Contractor shall be made in writing and submitted to the Contracting Officer for a written decision. A claim by the PHA against the Contractor shall be subject to a written decision by the Contracting Officer.
- (c) The Contracting Officer shall, within 30 days after receipt of the request, decide the claim or notify the Contractor of the date by which the decision will be made.
- (d) The Contracting Officer's decision shall be final unless the Contractor (1) appeals in writing to a higher level in the PHA in accordance with the PHA's policy and procedures, (2) refers the appeal to an independent mediator or arbitrator, or (3) files suit in a court of competent jurisdiction. Such appeal must be made within 30 days after receipt of the Contracting Officer's decision.
- (e) The Contractor shall proceed diligently with performance of this contract, pending final resolution of any request for relief, claim, appeal, or action arising under or relating to the contract, and comply with any decision of the Contracting Officer.

## 4. Default

- (a) If the Contractor refuses or fails to prosecute the work, or any separable part thereof, with the diligence that will insure its completion within the time specified in this contract, or any extension thereof, or fails to complete said work within this time, the Contracting Officer may, by written notice to the Contractor, terminate the right to proceed with the work (or separable part of the work) that has been delayed. In the event, the PHA may take over the work and complete it by contract or otherwise, and may take possession of and use any materials, equipment, and plant on the work site necessary for completing the work. The Contractor and its sureties shall be liable for any damage to the PHA resulting from the Contractor's refusal or failure to complete the work within the specified time, whether or not the Contractor's right to proceed with the work is terminated. This liability includes any increased costs incurred by the PHA in completing the work.

- (b) The Contractor's right to proceed shall not be terminated or the Contractor charged with damages under this clause if –
  - (1) The delay in completing the work arises from unforeseeable causes beyond the control and without the fault or negligence of the Contractor; and
  - (2) The Contractor, within 10 days from the beginning of such delay notifies the Contracting Officer in writing of the causes of delay. The Contracting Officer shall ascertain the facts and the extent of the delay. If, in the judgment of the Contracting Officer, the findings of Fact warrant such action, time for completing the work shall be extended by written modification to the contract. The findings of the Contracting Officer shall be reduced to a written decision which shall be subject to the provisions of the **Disputes** clause of this contract.
- (c) If, after termination of the Contractor's right to proceed, it is determined that the Contractor was not in default, or that the delay was excusable, the rights and obligation of the parties will be the same as if the termination had been for convenience of the PHA.

## 5. Termination for Convenience

- (a) The Contracting Officer may terminate this contract in whole, or in part, whenever the Contracting Officer determines that such termination is in the best interest of the PHA. Any such termination shall be effected by delivery to the Contractor of a Notice of Termination specifying the extent to which the performance of the work under the contract is terminated, and the date upon which such termination becomes effective.
- (b) If the performance of the work is terminated, either in whole or in part, the PHA shall be liable to the Contractor for reasonable and proper costs resulting from such termination upon the receipt by the PHA of a properly presented claim setting out in detail: (1) the total cost of the work performed to date of termination less the total amount of contract payments made to the Contractor; (2) the cost (including reasonable profit) of settling and paying claims under subcontracts and material orders for work performed and materials and supplies delivered to the site, payment for which has not been made by the PHA to the Contractor or by the Contractor to the subcontractor or supplier; (3) the cost of preserving and protecting the work already performed until the PHA or assignee takes possession thereof or assumes responsibility therefore; (4) the actual or estimated cost of legal and accounting services reasonably necessary to prepare and present the termination claim to the PHA; and (5) an amount constituting a reasonable profit on the value of the work performed by the Contractor.
- (c) The Contracting Officer will act on the Contractor's claim within days (60 days unless otherwise indicated) of receipt of the Contractor's claim.
- (d) Any disputes with regard to this clause are expressly made subject to the provisions of the Disputes clause of this contract.

## 6. Insurance

- (a) Before commencing work, the Contractor and each subcontractor shall furnish the PHA with certificates of insurance showing the following insurance is in force and will insure all operations under the Contract:

---

(1) Workers' Compensation, in accordance with state or Territorial Workers' Compensation laws.

(2) Commercial General Liability with a combined single limit for bodily injury and property damage of not less than \$1,000,000 [Contracting Officer insert amount] per occurrence to protect the Contractor and each subcontractor against claims for bodily injury or death and damage to the property of others. This shall cover the use of all equipment, hoists, and vehicles on the site(s) not covered by Automobile Liability under (3) below. If the Contractor has a "claims-made" policy, then the following additional requirements apply: the policy must provide a "retroactive date" which must be on or before the execution date of the Contract; and the extended reporting period may not be less than five years following the completion date of the Contract.

(3) Automobile Liability on owned and non-owned motor vehicles used on the site(s) or in connection therewith for a combined single limit for bodily injury and property damage of not less than \$1,000,000 [Contracting Officer insert amount] per occurrence.

(b) Before commencing work, the Contractor shall furnish the PHA with a certificate of insurance evidencing that Builder's Risk (fire and extended coverage) Insurance on all work in place and/or materials stored at the building site(s), including foundations and building equipment, is in force. The Builder's Risk Insurance shall be for the benefit of the Contractor and the PHA as their interests may appear and each shall be named in the policy or policies as an insured. The Contractor in installing equipment supplied by the PHA shall carry insurance on such equipment from the time the Contractor takes possession thereof until the Contract work is accepted by the PHA. The Builder's Risk Insurance need not be carried on excavations, piers, footings, or foundations until such time as work on the superstructure is started. It need not be carried on landscape work. Policies shall furnish coverage at all times for the full cash value of all completed construction, as well as materials in place and/or stored at the site(s), whether or not partial payment has been made by the PHA. The Contractor may terminate this insurance on buildings as of the date taken over for occupancy by the PHA. The Contractor is not required to carry Builder's Risk Insurance for modernization work which does not involve structural alterations or additions and where the PHA's existing fire and extended coverage policy can be endorsed to include such work.

(c) All insurance shall be carried with companies which are financially responsible and admitted to do business in the State in which the project is located. If any such insurance is due to expire during the construction period, the Contractor (including subcontractors, as applicable) shall not permit the coverage to lapse and shall furnish evidence of coverage to the Contracting Officer. All certificates of insurance, as evidence of coverage, shall provide that no coverage may be canceled or non-renewed by the insurance company until at least 30 days prior written notice has been given to the Contracting Officer.

## 7. Contract Modifications

(a) Only the Contracting Officer has authority to modify any term or condition of this contract. Any contract modification shall be authorized in writing.

(b) The Contracting Officer may modify the contract unilaterally (1) pursuant to a specific authorization stated in a contract clause (e.g., Changes); or (2) for administrative matters which

do not change the rights or responsibilities of the parties (e.g., change in the PHA address). All other contract modifications shall be in the form of supplemental agreements signed by the Contractor and the Contracting Officer.

(c) When a proposed modification requires the approval of HUD prior to its issuance (e.g., a change order that exceeds the PHA's approved threshold), such modification shall not be effective until the required approval is received by the PHA.

## 8. Changes

(a) The Contracting Officer may, at any time, without notice to the sureties, by written order designated or indicated to be a change order, make changes in the work within the general scope of the contract including changes:

(1) In the specifications (including drawings and designs);

(2) In the method or manner of performance of the work;

(3) PHA-furnished facilities, equipment, materials, services, or site; or,

(4) Directing the acceleration in the performance of the work.

(b) Any other written order or oral order (which, as used in this paragraph (b), includes direction, instruction, interpretation, or determination) from the Contracting Officer that causes a change shall be treated as a change order under this clause; provided, that the Contractor gives the Contracting Officer written notice stating (1) the date, circumstances and source of the order and (2) that the Contractor regards the order as a change order.

(c) Except as provided in this clause, no order, statement or conduct of the Contracting Officer shall be treated as a change under this clause or entitle the Contractor to an equitable adjustment.

(d) If any change under this clause causes an increase or decrease in the Contractor's cost of, or the time required for the performance of any part of the work under this contract, whether or not changed by any such order, the Contracting Officer shall make an equitable adjustment and modify the contract in writing. However, except for an adjustment based on defective specifications, no proposal for any change under paragraph (b) above shall be allowed for any costs incurred more than 20 days (5 days for oral orders) before the Contractor gives written notice as required. In the case of defective specifications for which the PHA is responsible, the equitable adjustment shall include any increased cost reasonably incurred by the Contractor in attempting to comply with the defective specifications.

(e) The Contractor must assert its right to an adjustment under this clause within 30 days after (1) receipt of a written change order under paragraph (a) of this clause, or (2) the furnishing of a written notice under paragraph (b) of this clause, by submitting a written statement describing the general nature and the amount of the proposal. If the facts justify it, the Contracting Officer may extend the period for submission. The proposal may be included in the notice required under paragraph (b) above. No proposal by the Contractor for an equitable adjustment shall be allowed if asserted after final payment under this contract.

(f) The Contractor's written proposal for equitable adjustment shall be submitted in the form of a lump sum proposal supported with an itemized breakdown of all increases and decreases in the contract in at least the following details:

(1) Direct Costs. Materials (list individual items, the quantity and unit cost of each, and the aggregate cost); Transportation and delivery costs associated with materials; Labor

breakdowns by hours or unit costs (identified with specific work to be performed); Construction equipment exclusively necessary for the change; Costs of preparation and/ or revision to shop drawings resulting from the change; Worker's Compensation and Public Liability Insurance; Employment taxes under FICA and FUTA; and, Bond Costs - when size of change warrants revision.

- (2) Indirect Costs. Indirect costs may include overhead, general and administrative expenses, and fringe benefits not normally treated as direct costs.
- (3) Profit. The amount of profit shall be negotiated and may vary according to the nature, extent, and complexity of the work required by the change.

The allowability of the direct and indirect costs shall be determined in accordance with the Contract Cost Principles and Procedures for Commercial Firms in Part 31 of the Federal Acquisition Regulation (48 CFR 1-31), as implemented by HUD Handbook 2210.18, in effect on the date of this contract. The Contractor shall not be allowed a profit on the profit received by any subcontractor. Equitable adjustments for deleted work shall include a credit for profit and may include a credit for indirect costs. On proposals covering both increases and decreases in the amount of the contract, the application of indirect costs and profit shall be on the net-change in direct costs for the Contractor or subcontractor performing the work.

- (g) The Contractor shall include in the proposal its request for time extension (if any), and shall include sufficient information and dates to demonstrate whether and to what extent the change will delay the completion of the contract in its entirety.
- (h) The Contracting Officer shall act on proposals within 30 days after their receipt, or notify the Contractor of the date when such action will be taken.
- (i) Failure to reach an agreement on any proposal shall be a dispute under the clause entitled Disputes herein. Nothing in this clause, however, shall excuse the Contractor from proceeding with the contract as changed.
- (j) Except in an emergency endangering life or property, no change shall be made by the Contractor without a prior order from the Contracting Officer.

#### **9. Examination and Retention of Contractor's Records**

The HA, HUD, or Comptroller General of the United States, or any of their duly authorized representatives shall, until three years after final payment under this contract, have access to and the right to examine any of the Contractor's directly pertinent books, documents, papers, or other records involving transactions related to this contract for the purpose of making audit, examination, excerpts, and transcriptions.

#### **10. Rights in Data and Patent Rights (Ownership and Proprietary Interest)**

The HA shall have exclusive ownership of, all proprietary interest in, and the right to full and exclusive possession of all information, materials, and documents discovered or produced by Contractor pursuant to the terms of this Contract, including but not limited to reports, memoranda or letters concerning the research and reporting tasks of this Contract.

#### **11. Energy Efficiency**

The Contractor shall comply with all mandatory standards and policies relating to energy efficiency which are contained in the energy conservation plan issued in compliance with the Energy Policy and Conservation Act (Pub.L. 94-163) for the State in which the work under this contract is performed.

#### **12. Procurement of Recovered Materials**

- (a) In accordance with Section 6002 of the Solid Waste Disposal Act, as amended by the Resource Conservation and Recovery Act, the Contractor shall procure items designated in guidelines of the Environmental Protection Agency (EPA) at 40 CFR Part 247 that contain the highest percentage of recovered materials practicable, consistent with maintaining a satisfactory level of competition. The Contractor shall procure items designated in the EPA guidelines that contain the highest percentage of recovered materials practicable unless the Contractor determines that such items: (1) are not reasonably available in a reasonable period of time; (2) fail to meet reasonable performance standards, which shall be determined on the basis of the guidelines of the National Institute of Standards and Technology, if applicable to the item; or (3) are only available at an unreasonable price.
- (b) Paragraph (a) of this clause shall apply to items purchased under this contract where: (1) the Contractor purchases in excess of \$10,000 of the item under this contract; or (2) during the preceding Federal fiscal year, the Contractor: (i) purchased any amount of the items for use under a contract that was funded with Federal appropriations and was with a Federal agency or a State agency or agency of a political subdivision of a State; and (ii) purchased a total of in excess of \$10,000 of the item both under and outside that contract.

#### **13. Training and Employment Opportunities for Residents in the Project Area** (Section 3, HUD Act of 1968; 24 CFR 135)

- (a) The work to be performed under this contract is subject to the requirements of section 3 of the Housing and Urban Development Act of 1968, as amended, 12 U.S.C. 1701u (section 3). The purpose of section 3 is to ensure that employment and other economic opportunities generated by HUD assistance or HUD-assisted projects covered by section 3, shall, to the greatest extent feasible, be directed to low- and very low-income persons, particularly persons who are recipients of HUD assistance for housing.
- (b) The parties to this contract agree to comply with HUD's regulations in 24 CFR Part 135, which implement section 3. As evidenced by their execution of this contract, the parties to this contract certify that they are under no contractual or other impediment that would prevent them from complying with the Part 135 regulations.
- (c) The contractor agrees to send to each labor organization or representative of workers with which the contractor has a collective bargaining agreement or other understanding, if any, a notice advising the labor organization or workers' representative of the contractor's commitments under this section 3 clause, and will post copies of the notice in conspicuous places at the work site where both employees and applicants for training and employment positions can see the notice. The notice shall describe the section 3 preference, shall set forth minimum number and job titles subject to hire, availability of apprenticeship and training positions, the

---

qualifications for each; and the name and location of the person(s) taking applications for each of the positions; and the anticipated date the work shall begin.

- (d) The contractor agrees to include this section 3 clause in every subcontract subject to compliance with regulations in 24 CFR Part 135, and agrees to take appropriate action, as provided in an applicable provision of the subcontract or in this section 3 clause, upon a finding that the subcontractor is in violation of the regulations in 24 CFR Part 135. The contractor will not subcontract with any subcontractor where the contractor has notice or knowledge that the subcontractor has been found in violation of the regulations in 24 CFR Part 135.
- (e) The contractor will certify that any vacant employment positions, including training positions, that are filled (1) after the contractor is selected but before the contract is executed, and (2) with persons other than those to whom the regulations of 24 CFR Part 135 require employment opportunities to be directed, were not filled to circumvent the contractor's obligations under 24 CFR Part 135.
- (f) Noncompliance with HUD's regulations in 24 CFR Part 135 may result in sanctions, termination of this contract for default, and debarment or suspension from future HUD assisted contracts.

#### **14. Labor Standards - Davis-Bacon and Related Acts**

##### **(a) Minimum Wages.**

(1) All laborers and mechanics employed under this contract in the construction or development of the project(s) involved will be paid unconditionally and not less often than once a week, and without subsequent deduction or rebate on any account (except such payroll deductions as are permitted by regulations issued by the Secretary of Labor under the Copeland Act (29 CFR Part 3)), the full amount of wages and bona fide fringe benefits (or cash equivalents thereof) due at time of payment computed at rates not less than those contained in the wage determination of the Secretary of Labor which is attached hereto and made a part hereof, regardless of any contractual relationship which may be alleged to exist between the Contractor and such laborers and mechanics. Contributions made or costs reasonably anticipated for bona fide fringe benefits under Section 1(b)(2) of the Davis-Bacon Act on behalf of laborers or mechanics are considered wages paid to such laborers or mechanics, subject to the provisions of 29 CFR 5.5(a)(1)(iv); also, regular contributions made or costs incurred for more than a weekly period (but not less often than quarterly) under plans, funds, or programs which cover the regular weekly period, are deemed to be constructively made or incurred during such weekly period. Such laborers and mechanics shall be paid the appropriate wage rate and fringe benefits in the wage determination for the classification of work actually performed, without regard to skill, except as provided in 29 CFR 5.5(a)(4). Laborers or mechanics performing work in more than one classification may be compensated at the rate specified for each classification for the time actually worked therein; provided, that the employer's payroll records accurately set forth the time spent in each classification in which work is performed. The wage determination (including any additional classification and wage rates conformed under 29 CFR 5.5(a)(1)(ii) and the Davis-Bacon poster (WH-1321) shall be posted at all times by the Contractor and its subcontractors at the site of the work in

a prominent and accessible place where it can be easily seen by the workers.

- (2) (i) Any class of laborers or mechanics, including helpers, which is not listed in the wage determination and which is to be employed under the contract shall be classified in conformance with the wage determination. HUD shall approve an additional classification and wage rate and fringe benefits therefor only when all the following criteria have been met:
  - (a) The work to be performed by the classification requested is not performed by a classification in the wage determination; and
  - (b) The classification is utilized in the area by the construction industry; and
  - (c) The proposed wage rate, including any bona fide fringe benefits, bears a reasonable relationship to the wage rates contained in the wage determination.
- (ii) If the Contractor and the laborers and mechanics to be employed in the classification (if known), or their representatives, and HUD or its designee agree on the classification and wage rate (including the amount designated for fringe benefits where appropriate), a report of the action shall be sent by HUD or its designee to the Administrator of the Wage and Hour Division, Employee Standards Administration, U.S. Department of Labor, Washington, DC 20210. The Administrator, or an authorized representative, will approve, modify, or disapprove every additional classification action within 30 days of receipt and so advise HUD or its designee or will notify HUD or its designee within the 30-day period that additional time is necessary.
- (iii) In the event the Contractor, the laborers or mechanics to be employed in the classification or their representatives, and HUD or its designee do not agree on the proposed classification and wage rate (including the amount designated for fringe benefits, where appropriate), HUD or its designee shall refer the questions, including the views of all interested parties and the recommendation of HUD or its designee, to the Administrator of the Wage and Hour Division for determination. The Administrator, or an authorized representative, will issue a determination within 30 days of receipt and so advise HUD or its designee or will notify HUD or its designee within the 30-day period that additional time is necessary.
- (iv) The wage rate (including fringe benefits where appropriate) determined pursuant to subparagraphs (a)(2)(ii) or (iii) of this clause shall be paid to all workers performing work in the classification under this contract from the first day on which work is performed in the classification.
- (3) Whenever the minimum wage rate prescribed in the contract for a class of laborers or mechanics includes a fringe benefit which is not expressed as an hourly rate, the Contractor shall either pay the benefit as stated in the wage determination or shall pay another bona fide fringe benefit or an hourly cash equivalent thereof.
- (4) If the Contractor does not make payments to a trustee or other third person, the Contractor may consider as part

---

of the wages of any laborer or mechanic the amount of any costs reasonably anticipated in providing bona fide fringe benefits under a plan or program; *provided*, that the Secretary of Labor has found, upon the written request of the Contractor, that the applicable standards of the Davis-Bacon Act have been met. The Secretary of Labor may require the Contractor to set aside in a separate account assets for the meeting of obligations under the plan or program.

- (b) **Withholding of Funds.** HUD or its designee shall, upon its own action or upon written request of an authorized representative of the Department of Labor, withhold or cause to be withheld from the Contractor under this contract or any other Federal contract with the same prime Contractor, or any other Federally-assisted contract subject to Davis-Bacon prevailing wage requirements, which is held by the same prime Contractor, so much of the accrued payments or advances as may be considered necessary to pay laborers and mechanics, including apprentices, trainees, and helpers, employed by the Contractor or any subcontractor the full amount of wages required by the contract. In the event of failure to pay any laborer or mechanic, including any apprentice, trainee, or helper, employed or working in the construction or development of the project, all or part of the wages required by the contract, HUD or its designee may, after written notice to the Contractor, take such action as may be necessary to cause the suspension of any further payment, advance, or guarantee of funds until such violations have ceased. HUD or its designee may, after written notice to the Contractor, disburse such amounts withheld for and on account of the Contractor or subcontractor to the respective employees to whom they are due.

(c) **Payrolls and Basic Records.**

- (1) Payrolls and basic records relating thereto shall be maintained by the Contractor during the course of the work and preserved for a period of three years thereafter for all laborers and mechanics working in the construction or development of the project. Such records shall contain the name, address, and social security number of each such worker, his or her correct classification, hourly rates of wages paid (including rates of contributions or costs anticipated for bona fide fringe benefits or cash equivalents thereof of the types described in section 1(b)(2)(B) of the Davis-Bacon Act), daily and weekly number of hours worked, deductions made, and actual wages paid. Whenever the Secretary of Labor has found, under 29 CFR 5.5(a)(1)(iv), that the wages of any laborer or mechanic include the amount of costs reasonably anticipated in providing benefits under a plan or program described in section 1(b)(2)(B) of the Davis-Bacon Act, the Contractor shall maintain records which show that the commitment to provide such benefits is enforceable, that the plan or program is financially responsible, and that the plan or program has been communicated in writing to the laborers or mechanics affected, and records which show the costs anticipated or the actual cost incurred in providing such benefits. Contractors employing apprentices or trainees under approved programs shall maintain written evidence of

the registration of apprenticeship programs and certification of trainee programs, the registration of the apprentices and trainees, and the ratios and wage rates prescribed in the applicable programs.

- (2) (i) The Contractor shall submit weekly for each week in which any contract work is performed a copy of all payrolls to the Contracting Officer for transmission to HUD or its designee. The payrolls submitted shall set out accurately and completely all of the information required to be maintained under subparagraph (c)(1) of this clause. This information may be submitted in any form desired. Optional Form WH-347 (Federal Stock Number 029-005-00014-1) is available for this purpose and may be purchased from the Superintendent of Documents, U.S. Government Printing Office, Washington, D.C. 20402. The prime Contractor is responsible for the submission of copies of payrolls by all subcontractors. (Approved by the Office of Management and Budget under OMB Control Number 1214-0149.)
- (ii) Each payroll submitted shall be accompanied by a "Statement of Compliance," signed by the contractor or subcontractor or his or her agent who pays or supervises the payment of the persons employed under the contract and shall certify the following:
- (A) That the payroll for the payroll period contains the information required to be maintained under paragraph (c)(1) of this clause and that such information is correct and complete;
- (B) That each laborer or mechanic (including each helper, apprentice, and trainee) employed on the contract during the payroll period has been paid the full weekly wages earned, without rebate, either directly or indirectly, and that no deductions have been made either directly or indirectly from the full wages earned, other than permissible deductions as set forth in 29 CFR Part 3; and
- (C) That each laborer or mechanic has been paid not less than the applicable wage rates and fringe benefits or cash equivalents for the classification of work performed, as specified in the applicable wage determination incorporated into the contract.
- (iii) The weekly submission of a properly executed certification set forth on the reverse side of Optional Form WH-347 shall satisfy the requirements for submission of the "Statement of Compliance" required by subparagraph (c)(2)(ii) of this clause.
- (iv) The falsification of any of the above certifications may subject the Contractor or subcontractor to civil or criminal prosecution under Section 1001 of Title 18 and Section 3729 of Title 31 of the United States Code.
- (3) The Contractor or subcontractor shall make the records required under subparagraph (c)(1) available for inspection, copying, or transcription by authorized representatives of HUD or its designee, the Contracting Officer, or the Department of Labor and shall permit such representatives to interview employees during working hours on the job. If the Contractor or subcontractor fails to submit the required records or to make them available, HUD or its designee may, after written notice to the Contractor, take such action as may be necessary to cause the suspension of any further payment, advance, or guarantee of funds. Furthermore, failure to submit the required records upon request or to make such records available may be grounds for debarment action pursuant to 29 CFR 5.12.

(d) **Apprentices.** Apprentices will be permitted to work at less than the predetermined rate for the work they performed when they are employed pursuant to and individually registered in a bona fide apprenticeship program registered with the U.S. Department of Labor, Employment and Training Administration, Office of Apprenticeship Training, Employer and Labor Services (OATELS), or with a State Apprenticeship Agency recognized by OATELS, or if a person is employed in his or her first 90 days of probationary employment as an apprentice in such an apprenticeship program, who is not individually registered in the program, but who has been certified by OATELS or a State Apprenticeship Agency (where appropriate) to be eligible for probationary employment as an apprentice.

The allowable ratio of apprentices to journeymen on the job site in any craft classification shall not be greater than the ratio permitted to the Contractor as to the entire work force under the registered program. Any worker listed on a payroll at an apprentice wage rate, who is not registered or otherwise employed as stated in this paragraph, shall be paid not less than the applicable wage rate on the wage determination for the classification of work actually performed. In addition, any apprentice performing work on the job site in excess of the ratio permitted under the registered program shall be paid not less than the applicable wage rate on the wage determination for the work actually performed. Where a contractor is performing construction on a project in a locality other than that in which its program is registered, the ratios and wage rates (expressed in percentages of the journeyman's hourly rate) specified in the Contractor's or subcontractor's registered program shall be observed. Every apprentice must be paid at not less than the rate specified in the registered program for the apprentice's level of progress, expressed as a percentage of the journeyman hourly rate specified in the applicable wage determination. Apprentices shall be paid fringe benefits in accordance with the provisions of the apprenticeship program. If the apprenticeship program does not specify fringe benefits, apprentices must be paid the full amount of fringe benefits listed on the wage determination for the applicable classification. If the Administrator of the Wage and Hour Division determines that a different practice prevails for the applicable apprentice classification, fringes shall be paid in accordance with that determination. In the event OATELS, or a State Apprenticeship Agency recognized by OATELS, withdraws approval of an apprenticeship program, the Contractor will no longer be permitted to utilize apprentices at less than the applicable predetermined rate for the work performed until an acceptable program is approved.

(e) **Trainees.** Except as provided in 29 CFR 5.16, trainees will not be permitted to work at less than the predetermined rate for the work performed unless they are employed pursuant to and individually registered in a program which has received prior approval, evidenced by formal certification by the U.S. Department of Labor, Employment and Training Administration. The ratio of trainees to journeymen on the job site shall not be greater than permitted under the plan approved by the Employment and Training Administration. Every trainee must be paid at not less than the rate specified in the approved program for the trainee's level of progress, expressed as a percentage of the journeyman hourly rate

specified in the applicable wage determination. Trainees shall be paid fringe benefits in accordance with the provisions of the trainee program. If the trainee program does not mention fringe benefits, trainees shall be paid the full amount of fringe benefits listed in the wage determination unless the Administrator of the Wage and Hour Division determines that there is an apprenticeship program associated with the corresponding journeyman wage rate in the wage determination which provides for less than full fringe benefits for apprentices. Any employee listed on the payroll at a trainee rate who is not registered and participating in a training plan approved by the Employment and Training Administration shall be paid not less than the applicable wage rate in the wage determination for the classification of work actually performed. In addition, any trainee performing work on the job site in excess of the ratio permitted under the registered program shall be paid not less than the applicable wage rate in the wage determination for the work actually performed. In the event the Employment and Training Administration withdraws approval of a training program, the Contractor will no longer be permitted to utilize trainees at less than the applicable predetermined rate for the work performed until an acceptable program is approved.

- (f) **Equal Employment Opportunity.** The utilization of apprentices, trainees, and journeymen under this clause shall be in conformity with the equal employment opportunity requirements of Executive Order 11246, as amended, and 29 CFR Part 30.
- (g) **Compliance with Copeland Act Requirements.** The Contractor shall comply with the requirements of 29 CFR Part 3, which are hereby incorporated by reference in this contract.
- (h) **Contract Termination; Debarment.** A breach of the labor standards clauses in this contract may be grounds for termination of the contract and for debarment as a Contractor and a subcontractor as provided in 29 CFR 5.12.
- (i) **Compliance with Davis-Bacon and related Act Requirements.** All rulings and interpretations of the Davis-Bacon and related Acts contained in 29 CFR Parts 1, 3, and 5 are herein incorporated by reference in this contract.
- (j) **Disputes Concerning Labor Standards.** Disputes arising out of the labor standards provisions of this clause shall not be subject to the general disputes clause of this contract. Such disputes shall be resolved in accordance with the procedures of the Department of Labor set forth in 29 CFR Parts 5, 6, and 7. Disputes within the meaning of this clause include disputes between the Contractor (or any of its subcontractors) and the PHA, HUD, the U.S. Department of Labor, or the employees or their representatives.
- (k) **Certification of Eligibility.**
- (1) By entering into this contract, the Contractor certifies that neither it (nor he or she) nor any person or firm who has an interest in the Contractor's firm is a person or firm ineligible to be awarded contracts by the United States Government by virtue of section 3(a) of the Davis-Bacon Act or 29 CFR 5.12(a)(1).
  - (2) No part of this contract shall be subcontracted to any person or firm ineligible for award of a United States Government



**U.S. Department of Housing  
and Urban Development**  
Office of Public and Indian Housing

**Representations, Certifications,  
and Other Statements of Bidders**  
**Public and Indian Housing Programs**

# Representations, Certifications, and Other Statements of Bidders

## Public and Indian Housing Programs

### Table of Contents

Clause	Page
1. Certificate of Independent Price Determination	1
2. Contingent Fee Representation and Agreement	1
3. Certification and Disclosure Regarding Payments to Influence Certain Federal Transactions	1
4. Organizational Conflicts of Interest Certification	2
5. Bidder's Certification of Eligibility	2
6. Minimum Bid Acceptance Period	2
7. Small, Minority, Women-Owned Business Concern Representation	2
8. Indian-Owned Economic Enterprise and Indian Organization Representation	2
9. Certification of Eligibility Under the Davis-Bacon Act	3
10. Certification of Nonsegregated Facilities	3
11. Clean Air and Water Certification	3
12. Previous Participation Certificate	3
13. Bidder's Signature	3

### 1. Certificate of Independent Price Determination

(a) The bidder certifies that--

(1) The prices in this bid have been arrived at independently, without, for the purpose of restricting competition, any consultation, communication, or agreement with any other bidder or competitor relating to (i) those prices, (ii) the intention to submit a bid, or (iii) the methods or factors used to calculate the prices offered;

(2) The prices in this bid have not been and will not be knowingly disclosed by the bidder, directly or indirectly, to any other bidder or competitor before bid opening (in the case of a sealed bid solicitation) or contract award (in the case of a competitive proposal solicitation) unless otherwise required by law; and

(3) No attempt has been made or will be made by the bidder to induce any other concern to submit or not to submit a bid for the purpose of restricting competition.

(b) Each signature on the bid is considered to be a certification by the signatory that the signatory--

(1) Is the person in the bidder's organization responsible for determining the prices being offered in this bid or proposal, and that the signatory has not participated and will not participate in any action contrary to subparagraphs (a)(1) through (a)(3) above; or

(2) (i) Has been authorized, in writing, to act as agent for the following principals in certifying that those principals have not participated, and will not participate in any action contrary to subparagraphs (a)(1) through (a)(3) above.

\_\_\_\_\_ [insert full name of person(s) in the bidder's organization responsible for determining the prices offered in this bid or proposal, and the title of his or her position in the bidder's organization];

(ii) As an authorized agent, does certify that the principals named in subdivision (b)(2)(i) above have not participated, and will not participate, in any action contrary to subparagraphs (a)(1) through (a)(3) above; and

(iii) As an agent, has not personally participated, and will not participate in any action contrary to subparagraphs (a)(1) through (a)(3) above.

(c) If the bidder deletes or modifies subparagraph (a)2 above, the bidder must furnish with its bid a signed statement setting forth in detail the circumstances of the disclosure.

[ ] [Contracting Officer check if following paragraph is applicable]

(d) Non-collusive affidavit. (applicable to contracts for construction and equipment exceeding \$50,000)

(1) Each bidder shall execute, in the form provided by the PHA/IHA, an affidavit to the effect that he/she has not colluded with any other person, firm or corporation in regard to any bid submitted in response to this solicitation. If the successful bidder did not submit the affidavit with his/her bid, he/she must submit it within three (3) working days of bid opening. Failure to submit the affidavit by that date may render the bid nonresponsive. No contract award will be made without a properly executed affidavit.

(2) A fully executed "Non-collusive Affidavit" [ ] is, [ ] is not included with the bid.

### 2. Contingent Fee Representation and Agreement

(a) Definitions. As used in this provision:

"Bona fide employee" means a person, employed by a bidder and subject to the bidder's supervision and control as to time, place, and manner of performance, who neither exerts, nor proposes to exert improper influence to solicit or obtain contracts nor holds out as being able to obtain any contract(s) through improper influence.

"Improper influence" means any influence that induces or tends to induce a PHA/IHA employee or officer to give consideration or to act regarding a PHA/IHA contract on any basis other than the merits of the matter.

(b) The bidder represents and certifies as part of its bid that, except for full-time bona fide employees working solely for the bidder, the bidder:

(1) [ ] has, [ ] has not employed or retained any person or company to solicit or obtain this contract; and

(2) [ ] has, [ ] has not paid or agreed to pay to any person or company employed or retained to solicit or obtain this contract any commission, percentage, brokerage, or other fee contingent upon or resulting from the award of this contract.

(c) If the answer to either (a)(1) or (a)(2) above is affirmative, the bidder shall make an immediate and full written disclosure to the PHA/IHA Contracting Officer.

(d) Any misrepresentation by the bidder shall give the PHA/IHA the right to (1) terminate the contract; (2) at its discretion, deduct from contract payments the amount of any commission, percentage, brokerage, or other contingent fee; or (3) take other remedy pursuant to the contract.

### 3. Certification and Disclosure Regarding Payments to Influence Certain Federal Transactions (applicable to contracts exceeding \$100,000)

(a) The definitions and prohibitions contained in Section 1352 of title 31, United States Code, are hereby incorporated by reference in paragraph (b) of this certification.

(b) The bidder, by signing its bid, hereby certifies to the best of his or her knowledge and belief as of December 23, 1989 that:

(1) No Federal appropriated funds have been paid or will be paid to any person for influencing or attempting to influence an officer or employee of any agency, a Member of Congress, an officer or employee of Congress, or an employee of a Member of Congress on his or her behalf in connection with the awarding of a contract resulting from this solicitation;

(2) If any funds other than Federal appropriated funds (including profit or fee received under a covered Federal transaction) have been paid, or will be paid, to any person for influencing or attempting to influence an officer or employee of any agency, a Member of Congress, an officer or employee of Congress, or an employee of a Member of Congress on his or her behalf in connection with this solicitation, the bidder shall complete and submit, with its bid, OMB standard form LLL, "Disclosure of Lobbying Activities;" and

(3) He or she will include the language of this certification in all subcontracts at any tier and require that all recipients of subcontract awards in excess of \$100,000 shall certify and disclose accordingly.

(c) Submission of this certification and disclosure is a prerequisite for making or entering into this contract imposed by section 1352, title 31, United States Code. Any person who makes an expenditure prohibited under this provision or who fails to file or amend the disclosure form to be filed or amended by this provision, shall be subject to a civil penalty of not less than \$10,000, and not more than \$100,000, for each such failure.

(d) Indian tribes (except those chartered by States) and Indian organizations as defined in section 4 of the Indian Self-Determination and Education Assistance Act (25 U.S.C. 450B) are exempt from the requirements of this provision.

#### 4. Organizational Conflicts of Interest Certification

The bidder certifies that to the best of its knowledge and belief and except as otherwise disclosed, he or she does not have any organizational conflict of interest which is defined as a situation in which the nature of work to be performed under this proposed contract and the bidder's organizational, financial, contractual, or other interests may, without some restriction on future activities:

- (a) Result in an unfair competitive advantage to the bidder; or,
- (b) Impair the bidder's objectivity in performing the contract work.

[ ] In the absence of any actual or apparent conflict, I hereby certify that to the best of my knowledge and belief, no actual or apparent conflict of interest exists with regard to my possible performance of this procurement.

#### 5. Bidder's Certification of Eligibility

(a) By the submission of this bid, the bidder certifies that to the best of its knowledge and belief, neither it, nor any person or firm which has an interest in the bidder's firm, nor any of the bidder's subcontractors, is ineligible to:

(1) Be awarded contracts by any agency of the United States Government, HUD, or the State in which this contract is to be performed; or,

(2) Participate in HUD programs pursuant to 24 CFR Part 24.

(b) The certification in paragraph (a) above is a material representation of fact upon which reliance was placed when making award. If it is later determined that the bidder knowingly rendered an erroneous certification, the contract may be terminated for default, and the bidder may be debarred or suspended from participation in HUD programs and other Federal contract programs.

#### 6. Minimum Bid Acceptance Period

(a) "Acceptance period," as used in this provision, means the number of calendar days available to the PHA/IHA for awarding a contract from the date specified in this solicitation for receipt of bids.

(b) This provision supersedes any language pertaining to the acceptance period that may appear elsewhere in this solicitation.

(c) The PHA/IHA requires a minimum acceptance period of [Contracting Officer insert time period] calendar days.

(d) In the space provided immediately below, bidders may specify a longer acceptance period than the PHA's/IHA's minimum requirement. The bidder allows the following acceptance period: calendar days.

(e) A bid allowing less than the PHA's/IHA's minimum acceptance period will be rejected.

(f) The bidder agrees to execute all that it has undertaken to do, in compliance with its bid, if that bid is accepted in writing within (1) the acceptance period stated in paragraph (c) above or (2) any longer acceptance period stated in paragraph (d) above.

#### 7. Small, Minority, Women-Owned Business Concern Representation

The bidder represents and certifies as part of its bid/ offer that it --

(a) [ ] is, [ ] is not a small business concern. "Small business concern," as used in this provision, means a concern, including its affiliates, that is independently owned and operated, not dominant in the field of operation in which it is bidding, and qualified as a small business under the criteria and size standards in 13 CFR 121.

(b) [ ] is, [ ] is not a women-owned business enterprise. "Women-owned business enterprise," as used in this provision, means a business that is at least 51 percent owned by a woman or women who are U.S. citizens and who also control and operate the business.

(c) [ ] is, [ ] is not a minority business enterprise. "Minority business enterprise," as used in this provision, means a business which is at least 51 percent owned or controlled by one or more minority group members or, in the case of a publicly owned business, at least 51 percent of its voting stock is owned by one or more minority group members, and whose management and daily operations are controlled by one or more such individuals. For the purpose of this definition, minority group members are:

(Check the block applicable to you)

- |                        |                              |
|------------------------|------------------------------|
| [ ] Black Americans    | [ ] Asian Pacific Americans  |
| [ ] Hispanic Americans | [ ] Asian Indian Americans   |
| [ ] Native Americans   | [ ] Hasidic Jewish Americans |

#### 8. Indian-Owned Economic Enterprise and Indian Organization Representation (applicable only if this solicitation is for a contract to be performed on a project for an Indian Housing Authority)

The bidder represents and certifies that it:

(a) [ ] is, [ ] is not an Indian-owned economic enterprise. "Economic enterprise," as used in this provision, means any commercial, industrial, or business activity established or organized for the purpose of profit, which is at least 51 percent Indian owned. "Indian," as used in this provision, means any person who is a member of any tribe, band, group, pueblo, or community which is recognized by the Federal Government as eligible for services from the Bureau of Indian Affairs and any "Native" as defined in the Alaska Native Claims Settlement Act.

(b) [ ] is, [ ] is not an Indian organization. "Indian organization," as used in this provision, means the governing body of any Indian tribe or entity established or recognized by such governing body. Indian "tribe" means any Indian tribe, band, group, pueblo, or

community including Native villages and Native groups (including corporations organized by Kenai, Juneau, Sitka, and Kodiak) as defined in the Alaska Native Claims Settlement Act, which is recognized by the Federal Government as eligible for services from the Bureau of Indian Affairs.

**9. Certification of Eligibility Under the Davis-Bacon Act** (applicable to construction contracts exceeding \$2,000)

(a) By the submission of this bid, the bidder certifies that neither it nor any person or firm who has an interest in the bidder's firm is a person or firm ineligible to be awarded contracts by the United States Government by virtue of section 3(a) of the Davis-Bacon Act or 29 CFR 5.12(a)(1).

(b) No part of the contract resulting from this solicitation shall be subcontracted to any person or firm ineligible to be awarded contracts by the United States Government by virtue of section 3(a) of the Davis-Bacon Act or 29 CFR 5.12(a)(1).

(c) The penalty for making false statements is prescribed in the U. S. Criminal Code, 18 U.S.C. 1001.

**10. Certification of Nonsegregated Facilities** (applicable to contracts exceeding \$10,000)

(a) The bidder's attention is called to the clause entitled **Equal Employment Opportunity** of the General Conditions of the Contract for Construction.

(b) "Segregated facilities," as used in this provision, means any waiting rooms, work areas, rest rooms and wash rooms, restaurants and other eating areas, time clocks, locker rooms and other storage or dressing areas, parking lots, drinking fountains, recreation or entertainment areas, transportation, and housing facilities provided for employees, that are segregated by explicit directive or are in fact segregated on the basis of race, color, religion, or national origin because of habit, local custom, or otherwise.

(c) By the submission of this bid, the bidder certifies that it does not and will not maintain or provide for its employees any segregated facilities at any of its establishments, and that it does not and will not permit its employees to perform their services at any location under its control where segregated facilities are maintained. The bidder agrees that a breach of this certification is a violation of the Equal Employment Opportunity clause in the contract.

(d) The bidder further agrees that (except where it has obtained identical certifications from proposed subcontractors for specific time periods) prior to entering into subcontracts which exceed \$10,000 and are not exempt from the requirements of the Equal Employment Opportunity clause, it will:

- (1) Obtain identical certifications from the proposed subcontractors;
- (2) Retain the certifications in its files; and
- (3) Forward the following notice to the proposed subcontractors (except if the proposed subcontractors have submitted identical certifications for specific time periods):

**Notice to Prospective Subcontractors of Requirement for Certifications of Nonsegregated Facilities**

A Certification of Nonsegregated Facilities must be submitted before the award of a subcontract exceeding \$10,000 which is not exempt from the provisions of the Equal Employment Opportunity clause of the prime contract. The certification may be submitted either for each subcontract or for all subcontracts during a period (i.e., quarterly, semiannually, or annually).

**Note:** The penalty for making false statements in bids is prescribed in 18 U.S.C. 1001.

**11. Clean Air and Water Certification** (applicable to contracts exceeding \$100,000)

The bidder certifies that:

(a) Any facility to be used in the performance of this contract [ ] is, [ ] is not listed on the Environmental Protection Agency List of Violating Facilities:

(b) The bidder will immediately notify the PHA/IHA Contracting Officer, before award, of the receipt of any communication from the Administrator, or a designee, of the Environmental Protection Agency, indicating that any facility that the bidder proposes to use for the performance of the contract is under consideration to be listed on the EPA List of Violating Facilities; and,

(c) The bidder will include a certification substantially the same as this certification, including this paragraph (c), in every nonexempt subcontract.

**12. Previous Participation Certificate** (applicable to construction and equipment contracts exceeding \$50,000)

(a) The bidder shall complete and submit with his/her bid the Form HUD-2530, "Previous Participation Certificate." If the successful bidder does not submit the certificate with his/her bid, he/she must submit it within three (3) working days of bid opening. Failure to submit the certificate by that date may render the bid nonresponsive. No contract award will be made without a properly executed certificate.

(b) A fully executed "Previous Participation Certificate" [ ] is, [ ] is not included with the bid.

**13. Bidder's Signature**

The bidder hereby certifies that the information contained in these certifications and representations is accurate, complete, and current.

\_\_\_\_\_  
(Signature and Date)

\_\_\_\_\_  
(Typed or Printed Name)

\_\_\_\_\_  
(Title)

\_\_\_\_\_  
(Company Name)

\_\_\_\_\_  
(Company Address)

# Certification Regarding Debarment and Suspension

## Certification A: Certification Regarding Debarment, Suspension, and Other Responsibility Matters - Primary Covered Transactions

1. The prospective primary participant certifies to the best of its knowledge and belief that its principals;

a. Are not presently debarred, suspended, proposed for debarment, declared ineligible, or voluntarily excluded from covered transactions by any Federal debarment or agency;

b. Have not within a three-year period preceding this proposal, been convicted of or had a civil judgment rendered against them for commission of fraud or a criminal offense in connection with obtaining, attempting to obtain, or performing a public (Federal, State, or local) transaction or contract under a public transaction; violation of Federal or State antitrust statutes or commission of embezzlement, theft, forgery, bribery, falsification, or destruction of records, making false statements, or receiving stolen property;

c. Are not presently indicted for or otherwise criminally or civilly charged by a governmental entity (Federal, State, or local) with commission of any of the offenses enumerated in paragraph (1)(b) of this certification; and

d. Have not within a three-year period preceding this application/proposal had one or more public transactions (Federal, State, or local) terminated for cause or default.

2. Where the prospective primary participant is unable to certify to any of the statements in this certification, such prospective participant shall attach an explanation to this proposal.

### Instructions for Certification (A)

1. By signing and submitting this proposal, the prospective primary participant is providing the certification set out below.

2. The inability of a person to provide the certification required below will not necessarily result in denial of participation in this covered transaction. The prospective participant shall submit an explanation of why it cannot provide the certification set out below. The certification or explanation will be considered in connection with the department or agency's determination whether to enter into this transaction. However, failure of the prospective primary participant to furnish a certification or an explanation shall disqualify such person from participation in this transaction.

3. The certification in this clause is a material representation of fact upon which reliance was placed when the department or agency determined to enter into this transaction. If it is later determined that the prospective primary participant knowingly rendered an erroneous certification, in addition to other remedies available to the Federal Government, the department or agency may terminate this transaction for cause of default.

4. The prospective primary participant shall provide immediate written notice to the department or agency to whom this proposal is submitted if at any time the prospective primary participant learns that its certification was erroneous when submitted or has become erroneous by reason of changed circumstances.

5. The terms **covered transaction, debarred, suspended, ineligible, lower tier covered transaction, participant, person, primary covered transaction, principal, proposal, and voluntarily excluded**, as used in this clause, have the meanings set out in the Definitions and Coverage sections of the rules implementing Executive Order 12549. You may contact the department or agency to which this proposal is being submitted for assistance in obtaining a copy of these regulations.

6. The prospective primary participant agrees by submitting this proposal that, should the proposed covered transaction be entered into, it shall not knowingly enter into any lower tier covered transaction with a person who is debarred, suspended, declared ineligible, or voluntarily excluded from participation in this covered transaction, unless authorized by the department or agency entering into this transaction.

7. The prospective primary participant further agrees by submitting this proposal that it will include the clause titled "Certification Regarding Debarment, Suspension, Ineligibility and Voluntary Exclusion - Lower Tier Covered Transaction," provided by the department or agency entering into this covered transaction, without modification, in all lower tier covered transactions and in all solicitations for lower tier covered transactions.

8. A participant in a covered transaction may rely upon a certification of a prospective participant in a lower tier covered transaction that it is not debarred, suspended, ineligible, or voluntarily excluded from the covered transaction, unless it knows that the certification is erroneous. A participant may decide the method and frequency by which it determines this eligibility of its principals. Each participant may, but is not required to, check the Nonprocurement List.

9. Nothing contained in the foregoing shall be construed to require establishment of a system of records in order to render in good faith the certification required by this clause. The knowledge and information of a participant is not required to exceed that which is normally possessed by a prudent person in the ordinary course of business dealings.

10. Except for transactions authorized under paragraph (6) of these instructions, if a participant in a covered transaction knowingly enters into a lower tier covered transaction with a person who is suspended, debarred, ineligible, or voluntarily excluded from participation in this transaction, in addition to other remedies available to the Federal Government, the department or agency may terminate this transaction for cause of default.

**Certification B: Certification Regarding Debarment, Suspension, Ineligibility and Voluntary Exclusion - Lower Tier Covered Transactions**

1. The prospective lower tier participant certifies, by submission of this proposal, that neither it nor its principals is presently debarred, suspended, proposed for debarment, declared ineligible, or voluntarily excluded from participation in this transaction by any Federal department or agency.

2. Where the prospective lower tier participant is unable to certify to any of the statements in this certification, such prospective participant shall attach an explanation to this proposal.

**Instructions for Certification (B)**

1. By signing and submitting this proposal, the prospective lower tier participant is providing the certification set out below.

2. The certification in this clause is a material representation of fact upon which reliance was placed when this transaction was entered into. If it is later determined that the prospective lower tier participant knowingly rendered an erroneous certification, in addition to other remedies available to the Federal Government, the department or agency with which this transaction originated may pursue available remedies, including suspension and/or debarment.

3. The prospective lower tier participant shall provide immediate written notice to the person to which this proposal is submitted if at any time the prospective lower tier participant learns that its certification was erroneous when submitted or has become erroneous by reason of changed circumstances.

4. The terms **covered transaction, debarred, suspended, ineligible, lower tier covered transaction, participant, person, primary covered transaction, principal, proposal, and voluntarily excluded**, as used in this clause, have the meanings set out in the Definitions and Coverage sections of rules implementing Executive Order 12549. You may contact the person to which this proposal is submitted for assistance in obtaining a copy of these regulations.

5. The prospective lower tier participant agrees by submitting this proposal that, should the proposed covered transaction be entered into, it shall not knowingly enter into any lower tier covered transaction with a person who is debarred, suspended, declared ineligible, or voluntarily excluded from participation in this covered transaction, unless authorized by the department or agency with which this transaction originated.

6. The prospective lower tier participant further agrees by submitting this proposal that it will include this clause titled "Certification Regarding Debarment, Suspension, Ineligibility and Voluntary Exclusion - Lower Tier Covered Transaction," without modification, in all lower tier covered transactions and in all solicitations for lower tier covered transactions.

7. A participant in a covered transaction may rely upon a certification of a prospective participant in a lower tier covered transaction that it is not debarred, suspended, ineligible, or voluntarily excluded from the covered transaction, unless it knows that the certification is erroneous. A participant may decide the method and frequency by which it determines the eligibility of its principals. Each participant may, but is not required to, check the Nonprocurement List.

8. Nothing contained in the foregoing shall be construed to require establishment of a system of records in order to render in good faith the certification required by this clause. The knowledge and information of a participant is not required to exceed that which is normally possessed by a prudent person in the ordinary course of business dealings.

9. Except for transactions authorized under paragraph (5) of these instructions, if a participant in a lower covered transaction knowingly enters into a lower tier covered transaction with a person who is suspended, debarred, ineligible, or voluntarily excluded from participation in this transaction, in addition to other remedies available to the Federal Government, the department or agency with which this transaction originated may pursue available remedies including suspension and/or debarment.

Applicant		Date
Signature of Authorized Certifying Official		Title

**Equal Employment  
Opportunity Certification**  
Excerpt From 41 CFR §60-1.4(b)

U.S. Department of Housing  
and Urban Development  
Office of Housing  
Federal Housing Commissioner

Department of Veterans Affairs

The applicant hereby agrees that it will incorporate or cause to be incorporated into any contract for construction work, or modification thereof, as defined in the regulations of the Secretary of Labor at 41 CFR Chapter 60, which is paid for in whole or in part with funds obtained from the Federal Government or borrowed on the credit of the Federal Government pursuant to a grant, contract, loan insurance, or guarantee, or undertaken pursuant to any Federal program involving such grant, contract, loan, insurance, or guarantee, the following equal opportunity clause:

During the performance of this contract, the contractor agrees as follows:

- (1) The contractor will not discriminate against any employee or applicant for employment because of race, color, religion, sex, or national origin. The contractor will take affirmative action to ensure that applicants are employed, and that employees are treated during employment without regard to their race, color, religion, sex, or national origin, such action shall include, but not be limited to the following: Employment, upgrading, demotion, or transfer; recruitment or recruitment advertising; layoff or termination; rates of pay or other forms of compensation; and selection for training, including apprenticeship. The contractor agrees to post in conspicuous places, available to employees and applicants for employment, notices to be provided setting forth the provisions of this nondiscrimination clause.
- (2) The contractor will, in all solicitations or advertisements for employees placed by or on behalf of the contractor, state that all qualified applicants will receive considerations for employment without regard to race, color, religion, sex, or national origin.
- (3) The contractor will send to each labor union or representative of workers with which it has a collective bargaining agreement or other contract or understanding, a notice to be provided advising the said labor union or workers' representatives of the contractor's commitments under this section, and shall post copies of the notice in conspicuous places available to employees and applicants for employment.
- (4) The contractor will comply with all provisions of Executive Order 11246 of September 24, 1965, and of the rules, regulations and relevant orders of the Secretary of Labor.
- (5) The contractor will furnish all information and reports required by Executive Order 11246 of September 24, 1965, and by rules, regulations, and orders of the Secretary of Labor, or pursuant thereto, and will permit access to its books, records, and accounts by the administering agency and the Secretary of Labor for purposes of investigation to ascertain compliance with such rules, regulations, and orders.

- (6) In the event of the contractor's noncompliance with the nondiscrimination clauses of this contract or with any of the said rules, regulations, or orders, this contract may be canceled, terminated, or suspended in whole or in part and the contractor may be declared ineligible for further Government contracts or federally assisted construction contracts in accordance with procedures authorized in Executive Order 11246 of September 24, 1965, and such other sanctions may be imposed and remedies invoked as provided in Executive Order 11246 of September 24, 1965, or by rule, regulation, or order of the Secretary of Labor, or as otherwise provided by law.
- (7) The contractor will include the portion of the sentence immediately preceding paragraph (1) and the provisions of paragraphs (1) through (7) in every subcontract or purchase order unless exempted by rules, regulations, or orders of the Secretary of Labor issued pursuant to section 204 of Executive Order 11246 of September 24, 1965, so that such provisions will be binding upon each subcontractor or vendor. The contractor will take such action with respect to any subcontract or purchase order as the administering agency may direct as a means of enforcing such provisions, including sanctions for noncompliance: **Provided, however,** That in the event a contractor becomes involved in, or is threatened with, litigation with a subcontractor or vendor as a result of such direction by the administering agency the contractor may request the United States to enter into such litigation to protect the interests of the United States.

The applicant further agrees that it will be bound by the above equal opportunity clause with respect to its own employment practices when it participates in federally assisted construction work:

**Provided,** That if the applicant so participating is a State or local government, the above equal opportunity clause is not applicable to any agency, instrumentality or subdivision of such government which does not participate in work on or under the contract.

The applicant agrees that it will assist and cooperate actively with the administering agency and the Secretary of Labor in obtaining the compliance of contractors and subcontractors with the equal opportunity clause and the rules, regulations, and relevant orders of the Secretary of Labor, that it will furnish the administering agency and the Secretary of Labor such information as they may require for the supervision of such compliance, and that it will otherwise assist the administering agency in the discharge of the agency's primary responsibility for securing compliance.

The applicant further agrees that it will refrain from entering into any contract or contract modification subject to Executive Order 11246 of September 24, 1965, with a contractor debarred from, or who has not demonstrated eligibility for, Government contracts and Federally-assisted construction contracts pursuant to the Executive order and will carry out such sanctions and penalties for violation of the equal opportunity clause as may be imposed

Firm Name and Address

By

Title

upon contractors and subcontractors by the administering agency or the Secretary of Labor pursuant to Part II, Subpart D of the Executive order. In addition, the applicant agrees that if it fails or refuses to comply with these undertakings, the administering agency may take any or all of the following actions: Cancel, terminate, or suspend in whole or in part this grant (contract, loan, insurance, guarantee); refrain from extending any further assistance to the applicant under the program with respect to which the failure or refund occurred until satisfactory assurance of future compliance has been received from such applicant; and refer the case to the Department of Justice for appropriate legal proceedings.

#### **Excerpt from HUD Regulations**

200.410 Definition of term "applicant".

- (a) In multifamily housing transactions where controls over the mortgagor are exercised by the Commissioner either through the ownership of corporate stock or under the provisions of a regulatory agreement, the term "applicant" as used in this subpart shall mean the mortgagor.
- (b) In transactions other than those specified in paragraph(a) of this section, the term "applicant" as used in this subpart shall mean the builder, dealer or contractor performing the construction, repair or rehabilitation work for the mortgagor or other borrower.

200.420 Equal Opportunity Clause to be included in contracts and subcontracts.

- (a) The following equal opportunity clause shall be included in each contract and subcontract which is not exempt:

During the performance of this contract, the contractor agrees as follows:

(1) The contractor will not discriminate against any employee or applicant for employment because of race, creed, color, or national origin. The contractor will take affirmative action to ensure that applicants are employed, and that employees are treated during employment without regard to their race, creed, color, or national origin. Such action shall include, but not be limited to the following: employment, upgrading, demotion or transfer; recruitment or recruitment advertising; layoff or termination; rates of pay or other forms of compensation; and selection for training, including apprenticeship. The contractor agrees to post in conspicuous places, available to employees and applicants for employment, notices to be provided setting forth the provisions of the nondiscrimination clause.

(2) The contractor will in all solicitations or advertisements for employees placed by or on behalf of the contractor, state that all qualified applicants will receive consideration for employment without regard race, creed, color, or national origin.

(3) The contractor will send to each labor union or representative of workers with which he has a collective bargaining agreement or other contract or understanding, a notice, to be provided, advising the said labor union or workers' representative of the contractor's commitments under this section, and shall post copies of the notices in conspicuous places available to employees and applicants for employment.

(4) The contractor will comply with all provisions of Executive Order 10925 of March 6 1961, as amended, and of the regulations, and relevant orders of the President's Committee on Equal Employment Opportunity created thereby.

(5) The contractor will furnish all information and reports required by Executive Order 10925 of March 6, 1961, as amended, and by the regulations, and orders of the said Committee, or pursuant thereto, and will permit access to his books, records, and accounts by HUD and the Committee for purposes of investigation to ascertain compliance with such regulations, and orders.

(6) In the event of the contractor's non-compliance with the nondiscrimination clause of this contract or with any of the said regulations, or orders, this contract may be cancelled, terminated or suspended in whole or in part and the contractor may be declared ineligible for further Government contracts or Federally-assisted construction contracts in accordance with procedures authorized in Executive Order 10925 of March 6, 1961, as amended, and such other sanctions may be imposed and remedies invoked provided in the said Executive Order or by regulations, or order of the President's Committee on Equal Employment Opportunity, or as otherwise provided by law.

(7) The contractor will include the provisions of Paragraphs(1) through (7) in every subcontract or purchase order unless exempted by regulations, or orders of the President's Committee on Equal Employment Opportunity issued pursuant to Section 303 of Executive Order 10925 of March 6, 1961, as amended, so that such provisions will be binding upon each subcontractor or vendor. The contractor will take such action with respect to any subcontract or purchase orders as HUD may direct as a means of enforcing such provisions, including sanctions for noncompliance: Provided, however, that in the event the contractor becomes involved in, or is threatened with, litigation with a subcontractor or vendor as a result of such direction by HUD, the contractor may request the United States to enter into such litigation to protect the interests of the United States.

- (b) Except in subcontracts for the performance of construction work at the site of construction, the clause is not required to be inserted in subcontracts below the second tier. Subcontracts may incorporate by reference to the equal opportunity clause.

200.425 Modification in and exemptions from the regulations in this subpart.

- (a) The following transactions and contracts are exempt from the regulations in this subpart:

(1) Loans, mortgages, contracts and subcontracts not exceeding \$10,000.

(2) Contract and subcontracts not exceeding \$100,000 for standard commercial supplies or raw material;

(3) Contracts and subcontracts under which work is to be or has been performed outside the United States and where no recruitment of workers within the United States is involved. To the extent that work pursuant to such contracts is done within the United States, the equal opportunity clause shall be applicable;

(4) Contracts for the sale of Government property where no appreciable amount of work is involved; and

(5) Contracts and subcontracts for an indefinite quantity which are not to extend for more than one year if the purchaser determines that the amounts to be ordered under any such contract or subcontract are not reasonably expected to exceed \$100,000 in the case of contracts or subcontracts for standard commercial supplies and raw materials, or \$10,000 in the case of all other contracts and subcontracts.



---

contract by virtue of section 3(a) of the Davis-Bacon Act or 29 CFR 5.12(a)(1).

(3) The penalty for making false statements is prescribed in the U. S. Criminal Code, 18 U.S.C. 1001.

(l) **Subcontracts.** The Contractor or subcontractor shall insert in any subcontracts all the provisions contained in this clause, and such other clauses as HUD or its designee may by appropriate instructions require, and also a clause requiring the subcontractors to include these provisions in any lower tier subcontracts. The prime Contractor shall be responsible for the compliance by any subcontractor or lower tier subcontractor with all these provisions.

(m) **Non-Federal Prevailing Wage Rates.** Any prevailing wage rate (including basic hourly rate and any fringe benefits), determined under State law to be prevailing, with respect to any employee in any trade or position employed under the contract, is inapplicable to the contract and shall not be enforced against the Contractor or any subcontractor, with respect to employees engaged under the contract whenever such non-Federal prevailing wage rate exceeds:

- (i) the applicable wage rate determined by the Secretary of Labor pursuant to the Davis-Bacon Act (40 U.S.C. 3141 et seq.) to be prevailing in the locality with respect to such trade;
- (ii) an applicable apprentice wage rate based thereon specified in an apprenticeship program registered with the U.S. Department of Labor (DOL) or a DOL-recognized State Apprenticeship Agency; or
- (iii) an applicable trainee wage rate based thereon specified in a DOL-certified trainee program.

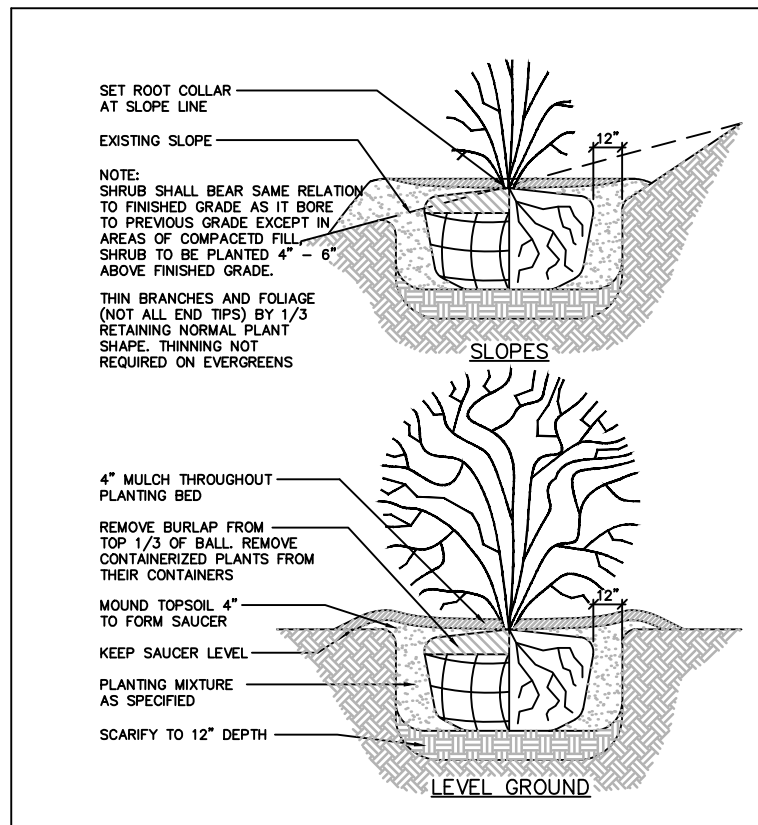

SHRUB PLANTING N.T.S. 8

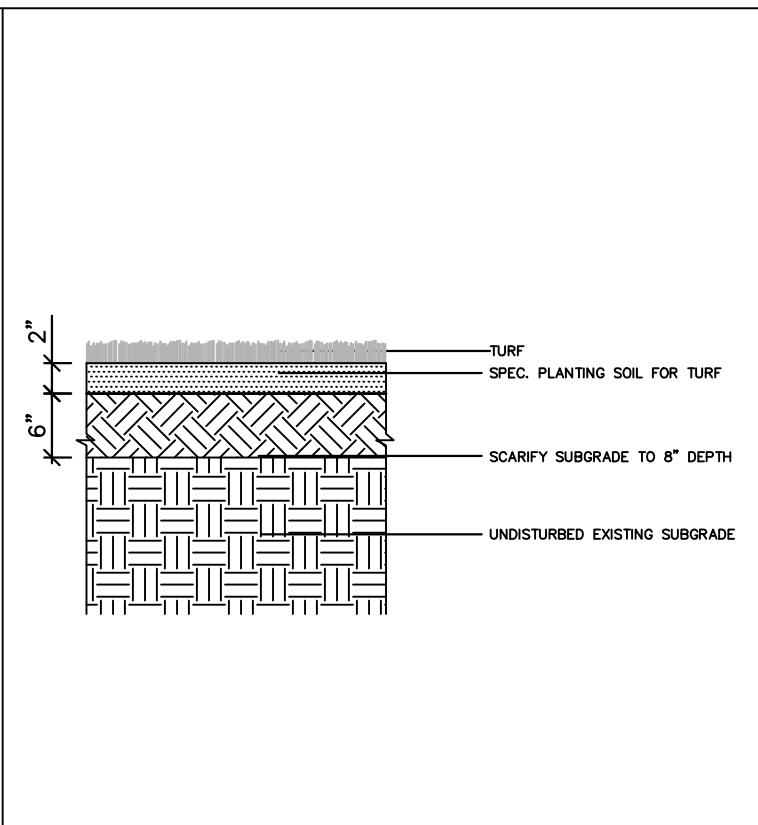

SOD N.T.S. 6

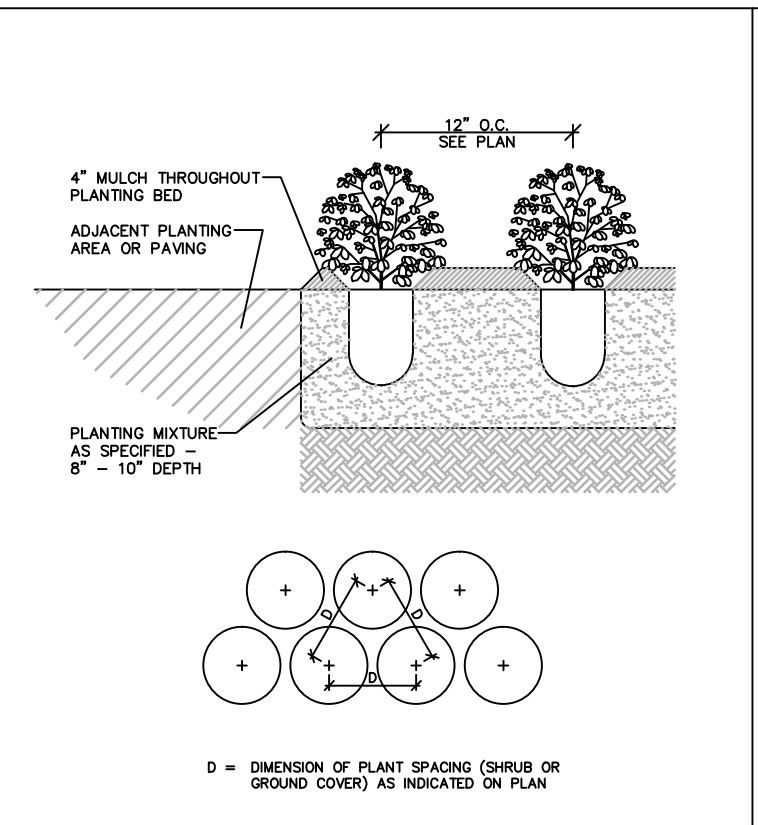

GROUNDCOVER/PLANT SPACING N.T.S. 4

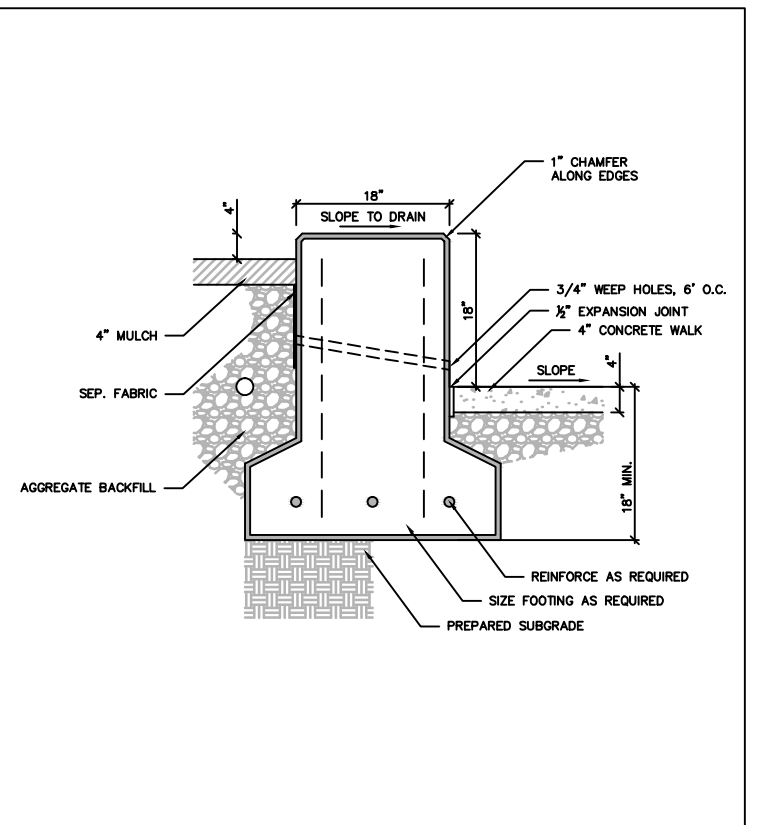

CONCRETE SEAT WALL SECTION N.T.S. 2

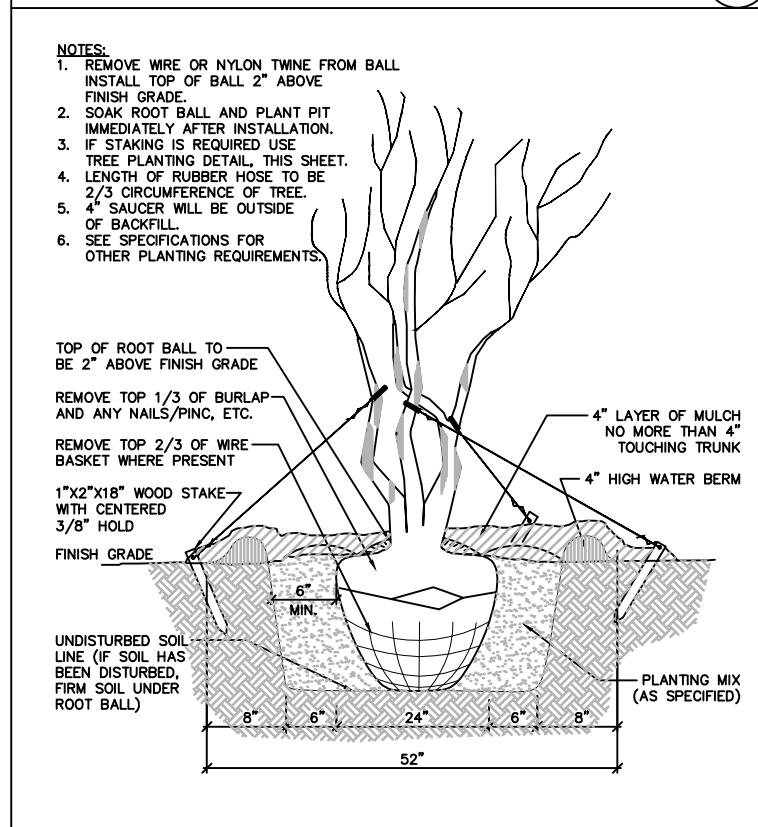

TREE PLANTING N.T.S. 7

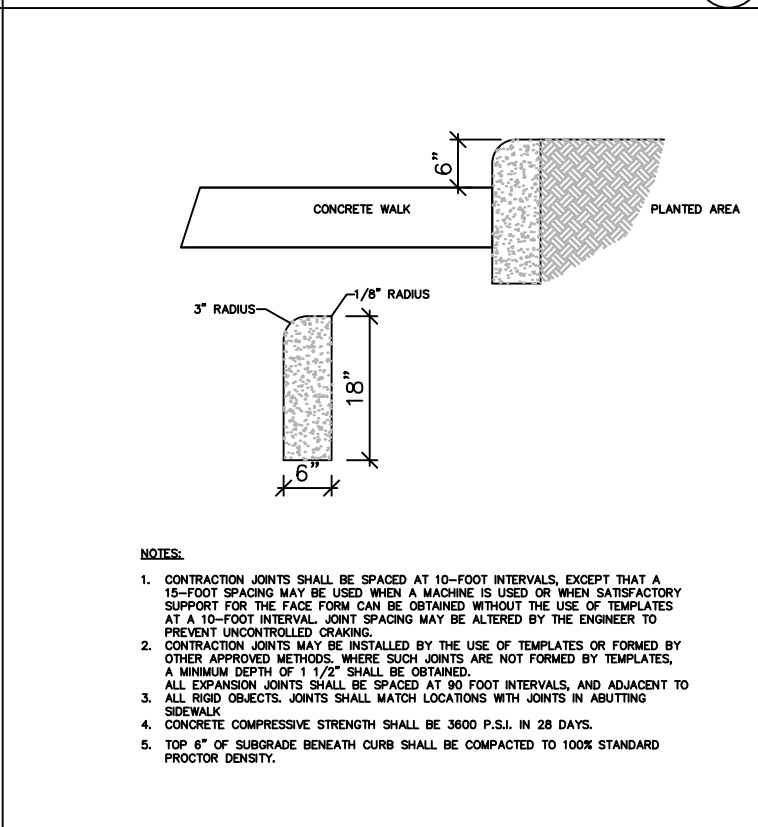

6" CONCRETE LANDSCAPE CURB N.T.S. 5

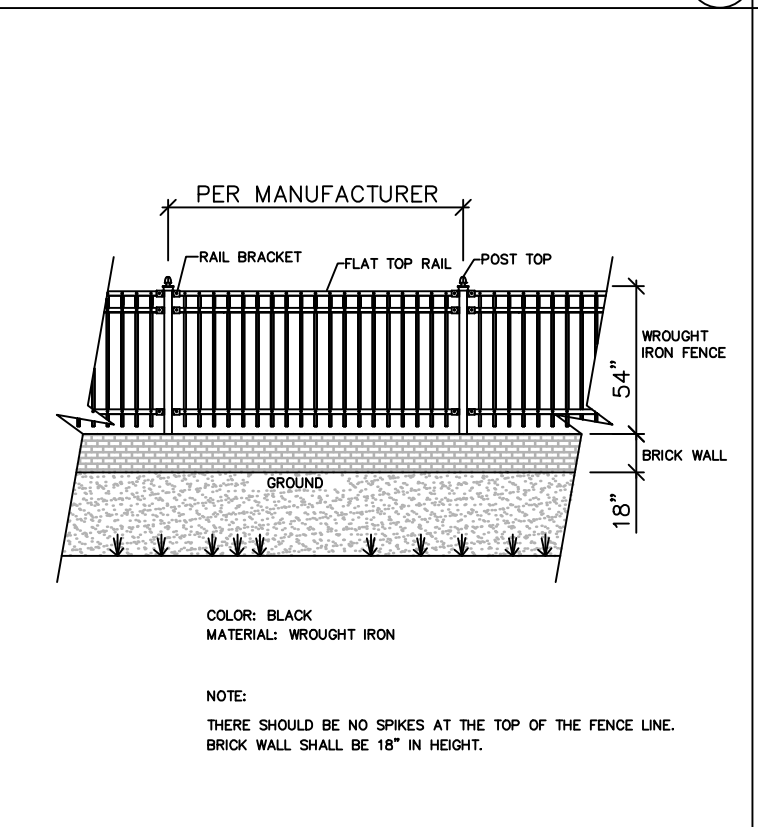

DECORATIVE FENCE N.T.S. 3

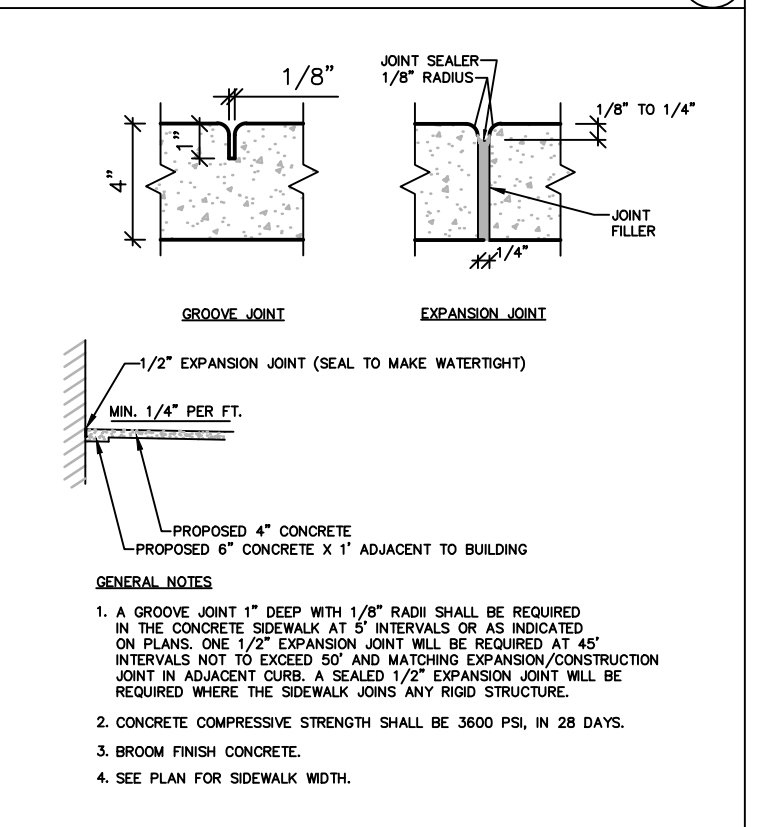

CONCRETE SIDEWALK N.T.S. 1

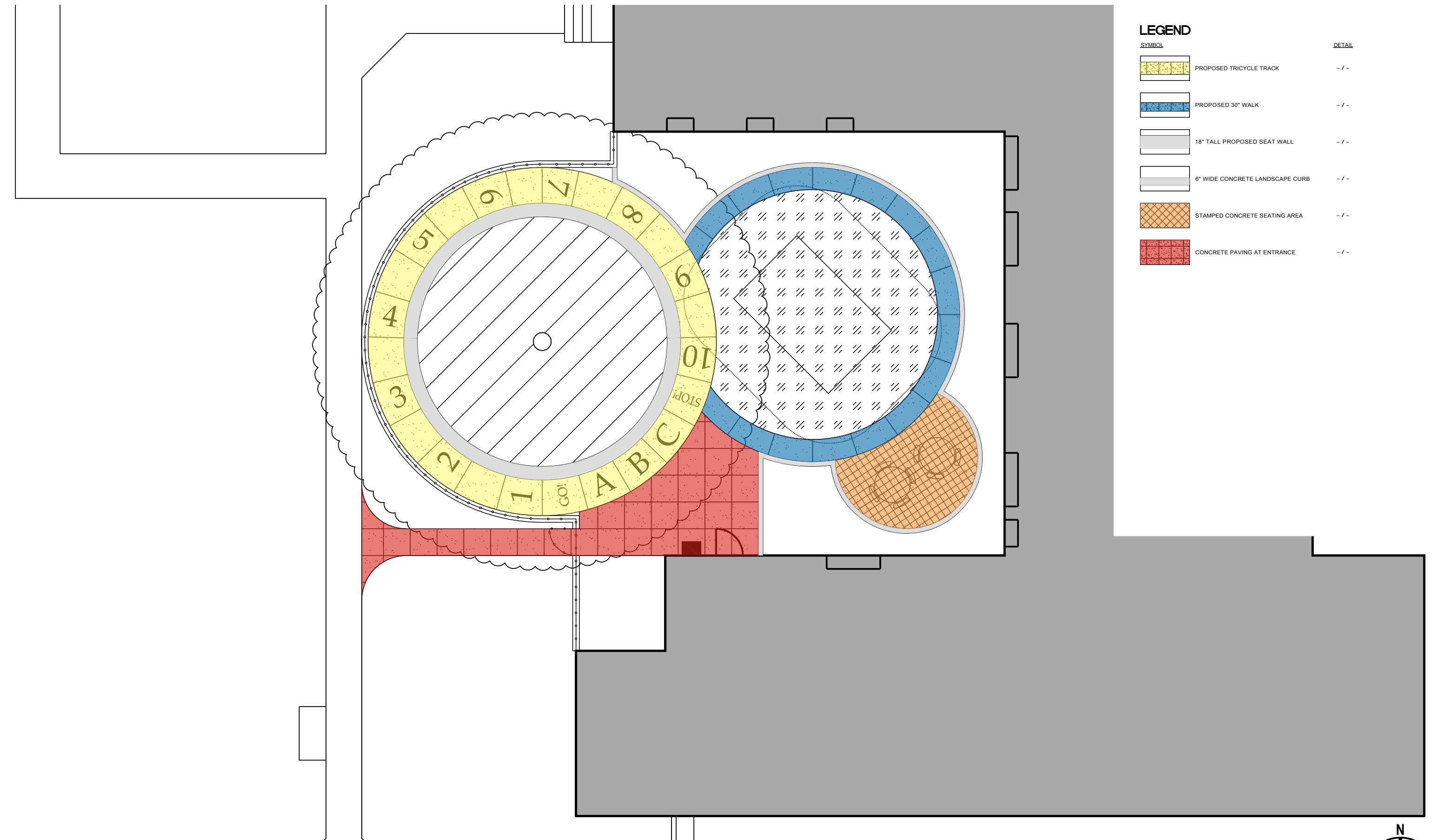

**LEGEND**

SYMBOL	DETAIL
	PROPOSED TRICYCLE TRACK - / -
	PROPOSED 30" WALK - / -
	18" TALL PROPOSED SEAT WALL - / -
	6" WIDE CONCRETE LANDSCAPE CURB - / -
	STAMPED CONCRETE SEATING AREA - / -
	CONCRETE PAVING AT ENTRANCE - / -



TOT LOT DESIGN  
 AXIOM ARCHITECTURE

Project No. 60127 Issued 01.26.11 SCALE: 1"=10'

CONCRETE COLORS

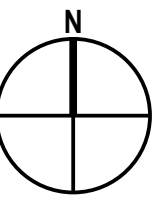
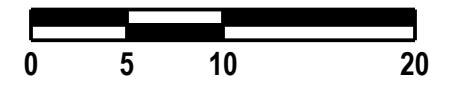

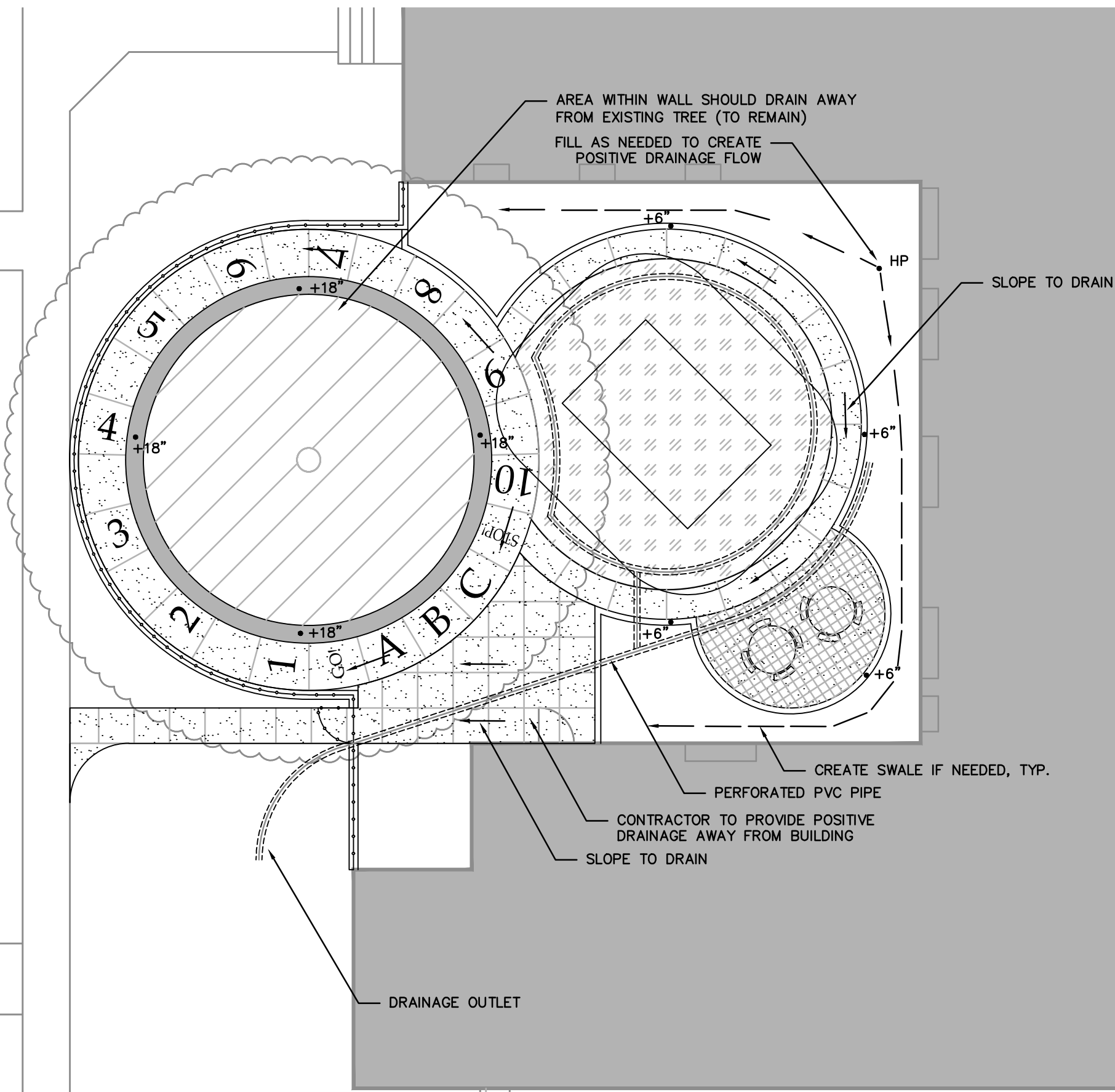

LEGEND		DETAIL
SYMBOL		
	PROPOSED SIDEWALK	-/-
	PROPOSED SPOT ELEVATION	-/-
	PROPOSED HIGH POINT	-/-
	PROPOSED DRAINAGE SWALE	-/-
	PROPOSED PERFORATED PVC PIPE	-/-

- NOTES:**
1. ALL SIDEWALKS, STOOPS, TERRACES AND OTHER PAVED AREAS SHALL SLOPE AWAY FROM BUILDING(S) AT 2.0% MAXIMUM.
  2. CONTRACTOR SHALL CONTACT INSPECTOR 48 HOURS BEFORE CONSTRUCTION.
  3. FOR SLOPE CONSTRUCTION 3:1 AND STEEPER THE CONTRACTOR SHALL COORDINATE WITH A GEOTECHNICAL ENGINEER ON THE SUITABILITY OF SOILS PLANNED FOR THESE SLOPES AND FOLLOW RECOMMENDATIONS SET FORTH BY THE GEOTECHNICAL ENGINEER FOR SLOPE CONSTRUCTION. ALL SLOPES SHOULD BE TRACKED TOP TO BOTTOM AND STABILIZED WITH NORTH AMERICAN GREEN S150, OR APPROVED OTHER, STAKED TO MANUFACTURER'S RECOMMENDATIONS. TOP SOIL PLACEMENT ON SLOPES SHALL BE INSTALLED IN A BENCHED PATTERN.
  4. PROVIDE ADEQUATE WEEP HOLES/DRAINAGE FOR SEAT WALL AND CURB.



TOT LOT DESIGN  
 AXIOM ARCHITECTURE

Project No. 60127 Issued 01.31.11 SCALE: 1"=10'

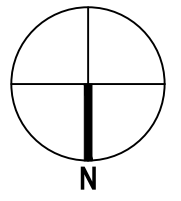
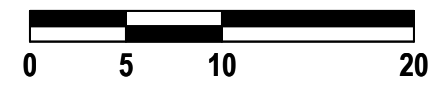

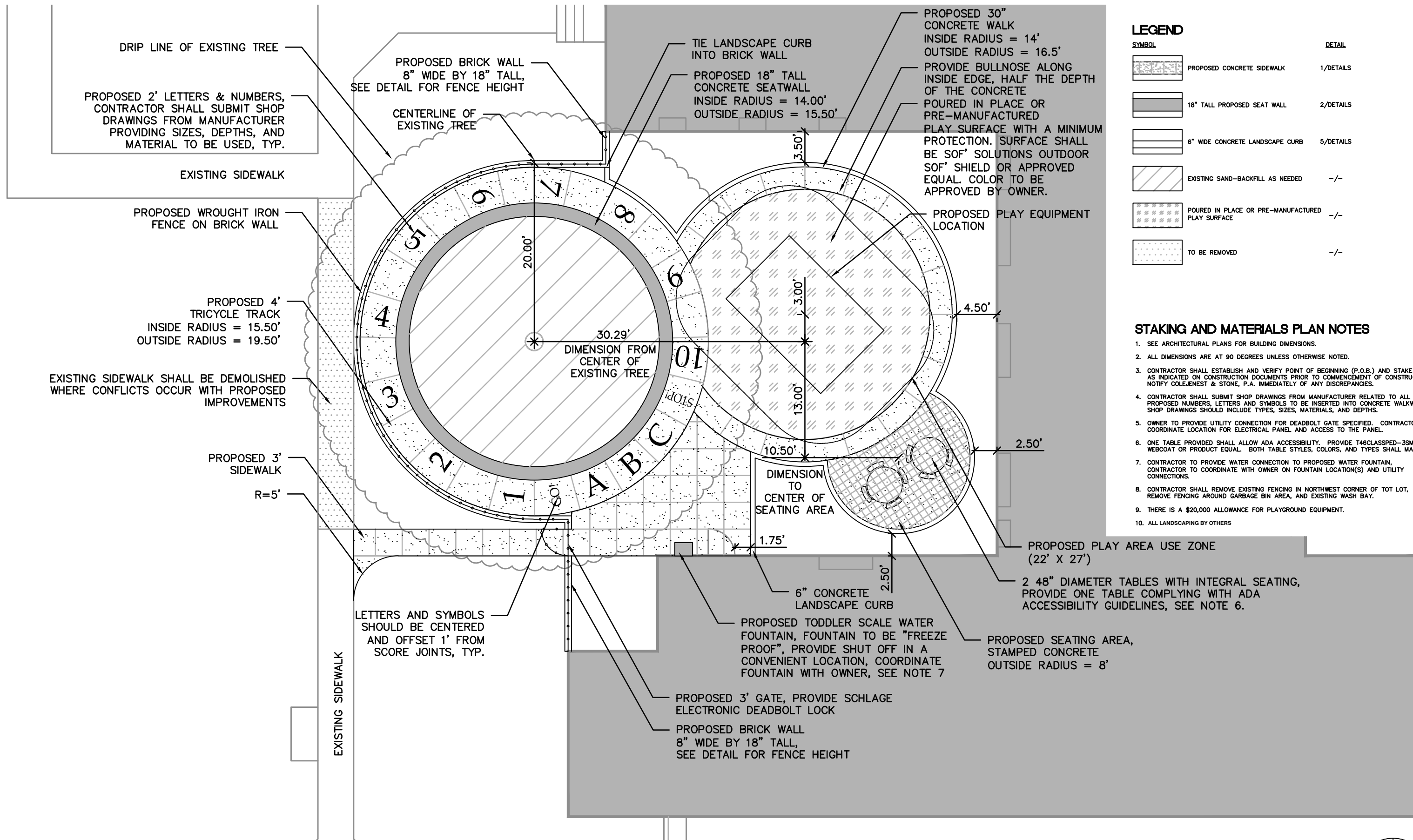

**LEGEND**

SYMBOL	DETAIL
[Pattern: Dotted]	PROPOSED CONCRETE SIDEWALK 1/DETAILS
[Pattern: Horizontal Lines]	18" TALL PROPOSED SEAT WALL 2/DETAILS
[Pattern: Vertical Lines]	6" WIDE CONCRETE LANDSCAPE CURB 5/DETAILS
[Pattern: Diagonal Lines]	EXISTING SAND-BACKFILL AS NEEDED -/-
[Pattern: Grid]	POURED IN PLACE OR PRE-MANUFACTURED PLAY SURFACE -/-
[Pattern: Dotted]	TO BE REMOVED -/-

- STAKING AND MATERIALS PLAN NOTES**
- SEE ARCHITECTURAL PLANS FOR BUILDING DIMENSIONS.
  - ALL DIMENSIONS ARE AT 90 DEGREES UNLESS OTHERWISE NOTED.
  - CONTRACTOR SHALL ESTABLISH AND VERIFY POINT OF BEGINNING (P.O.B.) AND STAKE SITE AS INDICATED ON CONSTRUCTION DOCUMENTS PRIOR TO COMMENCEMENT OF CONSTRUCTION. NOTIFY COLEJENEST & STONE, P.A. IMMEDIATELY OF ANY DISCREPANCIES.
  - CONTRACTOR SHALL SUBMIT SHOP DRAWINGS FROM MANUFACTURER RELATED TO ALL PROPOSED NUMBERS, LETTERS AND SYMBOLS TO BE INSERTED INTO CONCRETE WALKWAYS. SHOP DRAWINGS SHOULD INCLUDE TYPES, SIZES, MATERIALS, AND DEPTHS.
  - OWNER TO PROVIDE UTILITY CONNECTION FOR DEADBOLT GATE SPECIFIED. CONTRACTOR TO COORDINATE LOCATION FOR ELECTRICAL PANEL AND ACCESS TO THE PANEL.
  - ONE TABLE PROVIDED SHALL ALLOW ADA ACCESSIBILITY. PROVIDE T46CLASSPED-3SM BY WEBCOAT OR PRODUCT EQUAL. BOTH TABLE STYLES, COLORS, AND TYPES SHALL MATCH.
  - CONTRACTOR TO PROVIDE WATER CONNECTION TO PROPOSED WATER FOUNTAIN, CONTRACTOR TO COORDINATE WITH OWNER ON FOUNTAIN LOCATION(S) AND UTILITY CONNECTIONS.
  - CONTRACTOR SHALL REMOVE EXISTING FENCING IN NORTHWEST CORNER OF TOT LOT, REMOVE FENCING AROUND GARBAGE BIN AREA, AND EXISTING WASH BAY.
  - THERE IS A \$20,000 ALLOWANCE FOR PLAYGROUND EQUIPMENT.
  - ALL LANDSCAPING BY OTHERS



TOT LOT DESIGN  
AXIOM ARCHITECTURE

Project No. 60127 Issued 01.31.11 SCALE: 1"=10'

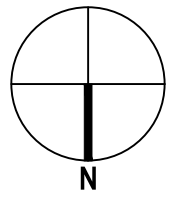

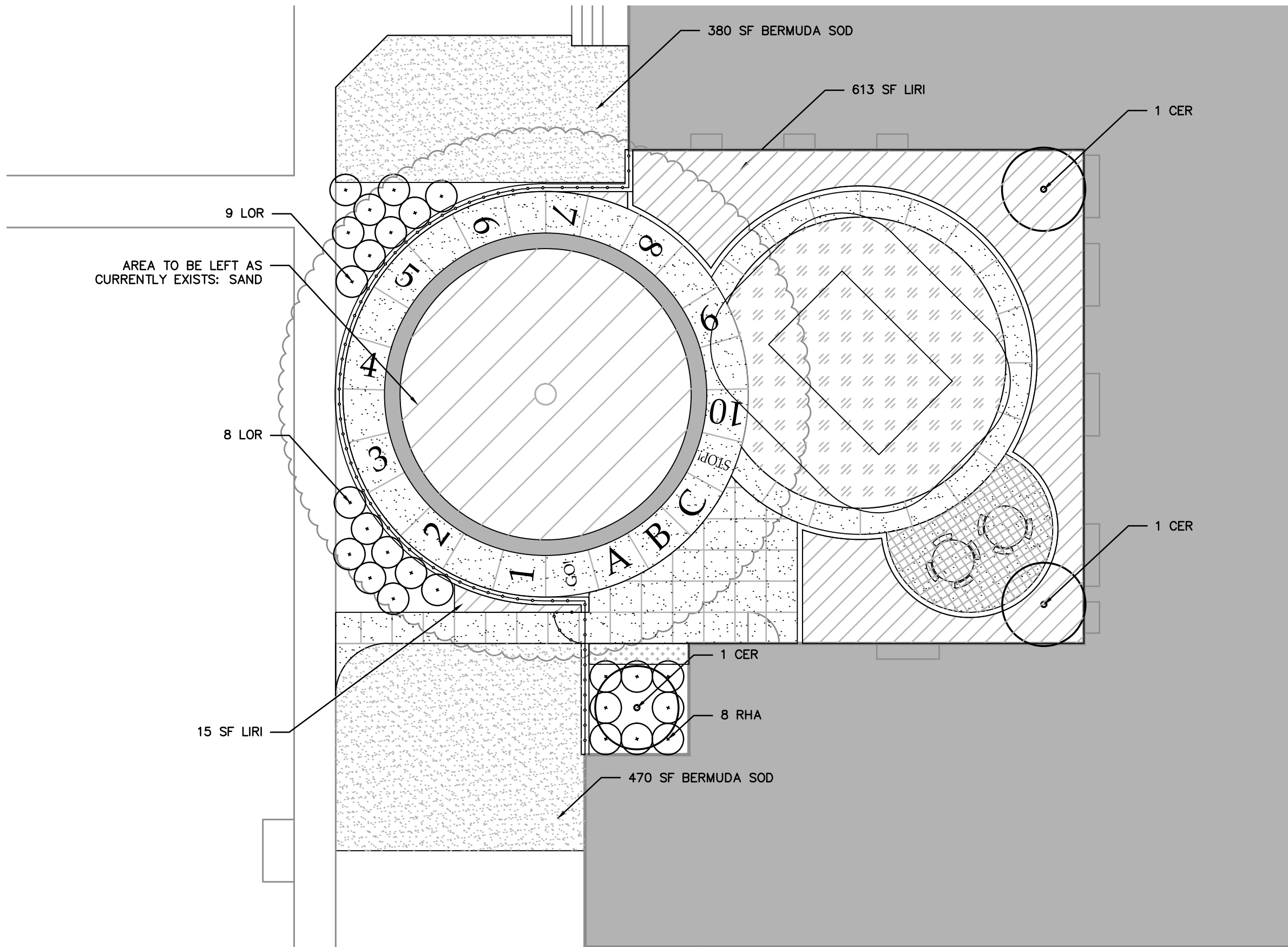

**LEGEND**

SYMBOL	DETAIL	QUANT.
	PROPOSED TREE	7/DETAILS 1
	EXISTING TREE	-/- 2
	PROPOSED SHRUBS	8/DETAILS 25
	PROPOSED SOD (BERMUDA)	6/DETAILS 850 SF
	PROPOSED GROUNDCOVER (LIRIOPE)	4/DETAILS 628 SF
	PROPOSED ANNUALS	-/- 20 SF

**PLANT SCHEDULE**

#	SYM	SCIENTIFIC NAME	COMMON NAME	SIZE
17	LOR	LOROPETALUM CHINENSIS 'PURPLE PIXIE'	PURPLE PIXIE LOROPETALUM	3 GAL.
8	RHA	RHAPHIOLEPSIS INDICA	INDIAN HAWTHORNE	3 GAL.
3	CER	CERCIS CANADENSIS 'FOREST PANSY'	FOREST PANSY REDBUD	12'-15' HEIGHT
509	LIRI	LIRIOPE MUSCARI	LIRIOPE	1 GAL.
	SOD	BERMUDA	BERMUDA	

**NOTES**

1. SIZE AND GRADING STANDARDS OF PLANT MATERIAL SHALL CONFORM TO THE LATEST EDITION OF "USA STANDARDS FOR NURSERY STOCK", BY THE AMERICAN ASSOCIATION OF NURSERYMAN, INC.
2. HEIGHT AND WIDTH SPECIFICATIONS INDICATED ON PLANT SCHEDULE SHALL TAKE PRECEDENCE OVER CONTAINER SIZE AND CALIPER.
3. CONTRACTOR SHALL MULCH ALL SHRUB BEDS WITH 4" AGED SHREDDED HARDWOOD BARK.
4. ALL DISTURBED AREAS NOT INDICATED TO RECEIVE SOD OR MULCH SHALL BE SEEDED BY THE CONTRACTOR.
5. CONTRACTOR SHALL REMOVE ALL HARD LUMPS OF CLAY, STONES OVER 1" IN DIAMETER, AND ALL CONSTRUCTION DEBRIS INCLUDING GRAVEL, ROOTS, LIMBS AND OTHER DELETERIOUS MATTER WHICH WOULD BE HARMFUL, OR PREVENT PROPER ESTABLISHMENT AND/OR MAINTENANCE OF LAWN AND PLANTING AREAS.
6. IN AREAS WHERE CONSTRUCTION GRAVEL IS EMBEDDED IN THE SOIL, CONTRACTOR SHALL REMOVE CONTAMINATED SOIL TO A DEPTH OF 8" AND FILL WITH CLEAN TOPSOIL. CONTRACTOR SHALL IMPORT TOPSOIL AT NO CHARGE TO OWNER IF REQUIRED TO FILL THESE EXCAVATIONS.
7. CONTRACTOR SHALL RESEED/RESOD LAWN AREAS DAMAGED DUE TO PLANT MATERIAL INSTALLATION.
8. FOR NEW PLANTING AREAS, CONTRACTOR SHALL REMOVE ALL PAVEMENT, GRAVEL SUB-BASE AND CONSTRUCTION DEBRIS; REMOVE COMPACTED SOIL AND ADD 24" NEW TOPSOIL, OR AMEND THE TOP 24" OF EXISTING SOIL TO MEET SPECIFIED TOPSOIL/PLANTING MIX STANDARDS FOR TREES (WITHIN ENTIRE MINIMUM AREA OF 274 SQUARE FEET PER TREE)
9. MINIMUM TREE SIZE AT PLANTING SHALL BE 3 INCH CALIPER FOR LARGE MATURING TREES AND 2 INCH CALIPER FOR SMALL MATURING TREES. ALL MULTI-STEM PLANTS SHALL BE TREE FORM, MAXIMUM THREE TO FIVE TRUNKS, AND A MINIMUM EIGHT FEET TALL.
10. THESE CONSTRUCTION DOCUMENTS WERE PREPARED WITHOUT THE BENEFIT OF A FIELD SURVEY, ADJUSTMENTS TO THE LOCATION OF PLANT MATERIAL MAY BE REQUIRED. NOTIFY COLEJENEST & STONE, P.A. IF DISCREPANCIES OCCUR.
11. A PERMANENT AUTOMATIC WATERING SYSTEM WILL BE INSTALLED FOR PROPOSED VEGETATION. ALL SODDED AREAS SHALL RECEIVE SPRAY IRRIGATION. ALL PLANT BEDS SHALL RECEIVE DRIP IRRIGATION.



TOT LOT DESIGN  
AXIOM ARCHITECTURE

Project No. 60127 Issued 01.31.11 SCALE: 1"=10'

