



US006141666A

# United States Patent [19]

[11] Patent Number: **6,141,666**

Tobin

[45] Date of Patent: **Oct. 31, 2000**

[54] **METHOD AND SYSTEM FOR CUSTOMIZING MARKETING SERVICES ON NETWORKS COMMUNICATING WITH HYPERTEXT TAGGING CONVENTIONS**

[75] Inventor: **William J. Tobin**, Stamford, Conn.

[73] Assignee: **Internet Consultants LLC**, Stamford, Conn.

[21] Appl. No.: **08/785,321**

[22] Filed: **Jan. 21, 1997**

### Related U.S. Application Data

[60] Provisional application No. 60/017,229, Jan. 22, 1996, and provisional application No. 60/010,372, May 22, 1996.

[51] Int. Cl.<sup>7</sup> ..... **G06F 17/21; G06F 17/60**

[52] U.S. Cl. .... **707/513; 705/27; 709/218**

[58] Field of Search ..... 705/1, 14, 26, 705/27; 709/203, 217, 218, 219; 707/513, 10

### [56] References Cited

#### U.S. PATENT DOCUMENTS

5,576,951	11/1996	Lockwood	395/227
5,649,186	7/1997	Ferguson	395/610
5,706,434	1/1998	Kremen et al.	395/200.09
5,710,887	1/1998	Chelliah et al.	395/226
5,712,979	1/1998	Graber et al.	
5,717,860	2/1998	Graber et al.	
5,740,430	4/1998	Rosenberg et al.	707/200
5,768,510	6/1998	Gish	709/202
5,794,207	8/1998	Walker et al.	705/1
5,796,393	8/1998	MacNaughton et al.	345/329
5,796,952	8/1998	Davis et al.	705/1
5,799,285	8/1998	Klingman	705/26
5,839,117	11/1998	Cameron et al.	705/27
5,852,809	12/1998	Abel et al.	705/26

5,855,008	12/1998	Goldhaber et al.	705/14
5,864,822	1/1999	Baker, III	705/14
5,870,718	2/1999	Spector	705/26
5,890,175	3/1999	Wong et al.	707/505
5,897,622	4/1999	Blinn et al.	705/26
5,907,830	5/1999	Engel et al.	705/14
5,918,214	6/1999	Perkowski	705/27
5,933,811	8/1999	Angles et al.	705/14
6,009,413	12/1999	Webber et al.	705/26
6,029,142	5/2000	Hill	705/27
6,061,057	5/2000	Knowlton et al.	705/26 X

### OTHER PUBLICATIONS

Kohda et al, Ubiquitous Advertising on the WWW: . . . 5th Int'l WWW conference, Paris, 1996, <www5conf.inria.fr/fich<sub>13</sub>.html/slides/smesforum/PS17/P52/All.html>, May 1996.

Primary Examiner—Joseph H. Feild  
Attorney, Agent, or Firm—Arthur L. Plevy; Buchanan Ingersoll PC

### [57] ABSTRACT

The present server based communications system provides dynamic customization of hypertext tagged documents presented to clients accessing the system. The customization, which pertains to the content of the documents, is based on the specific requirements of a class to which the client belongs to. The class may be defined by the identity of the source which refers the client to the system. The system utilizes a database which dynamically retrieves stored data in response to a server software tool which configures the data into hypertext tagged documents. The system utilizes a dynamic token scheme to pass the identity of the referring network site from document to document to eventual purchase document accessed by the client through the hypertext tags.

**42 Claims, 39 Drawing Sheets**

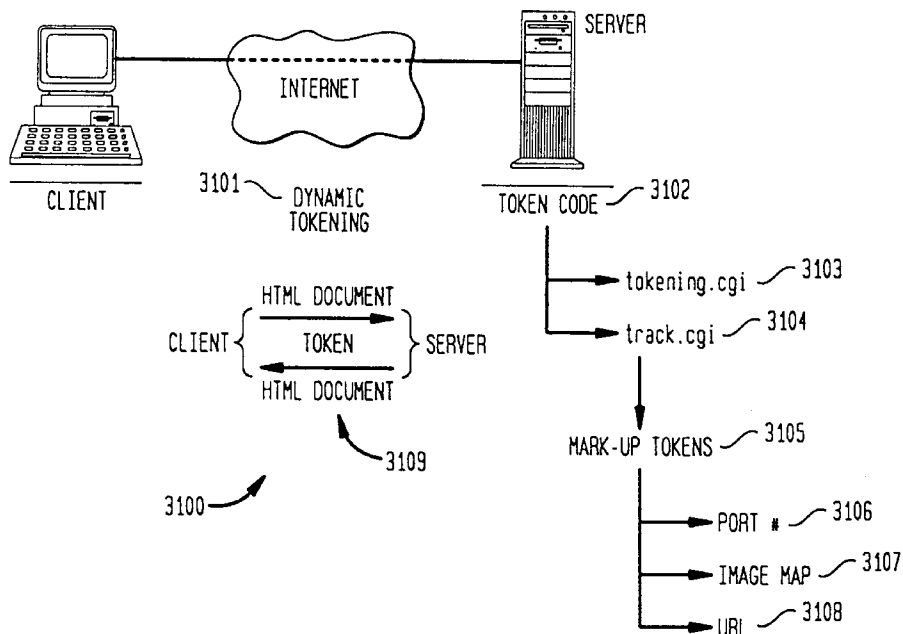

FIG. 1A

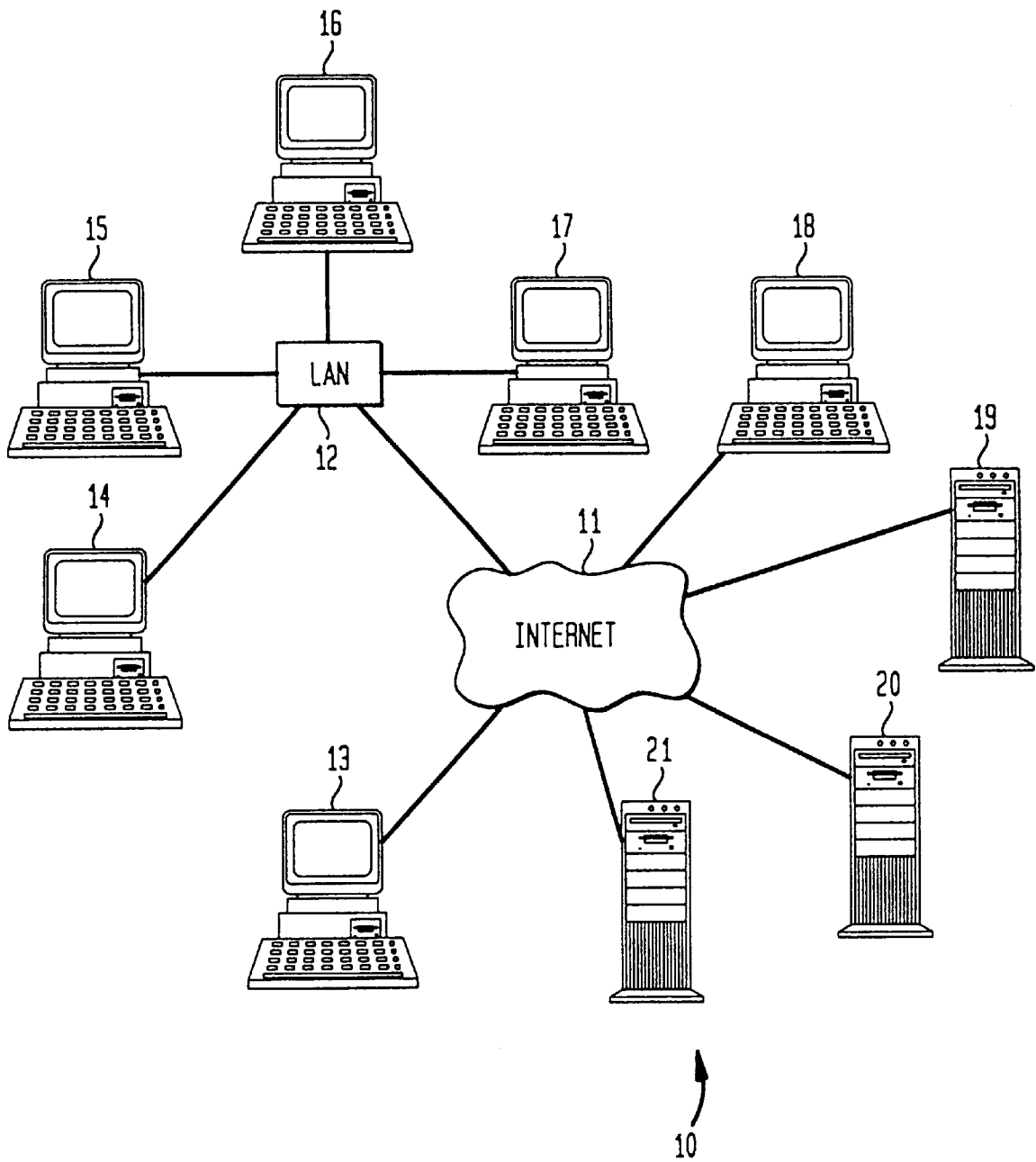

FIG. 1B

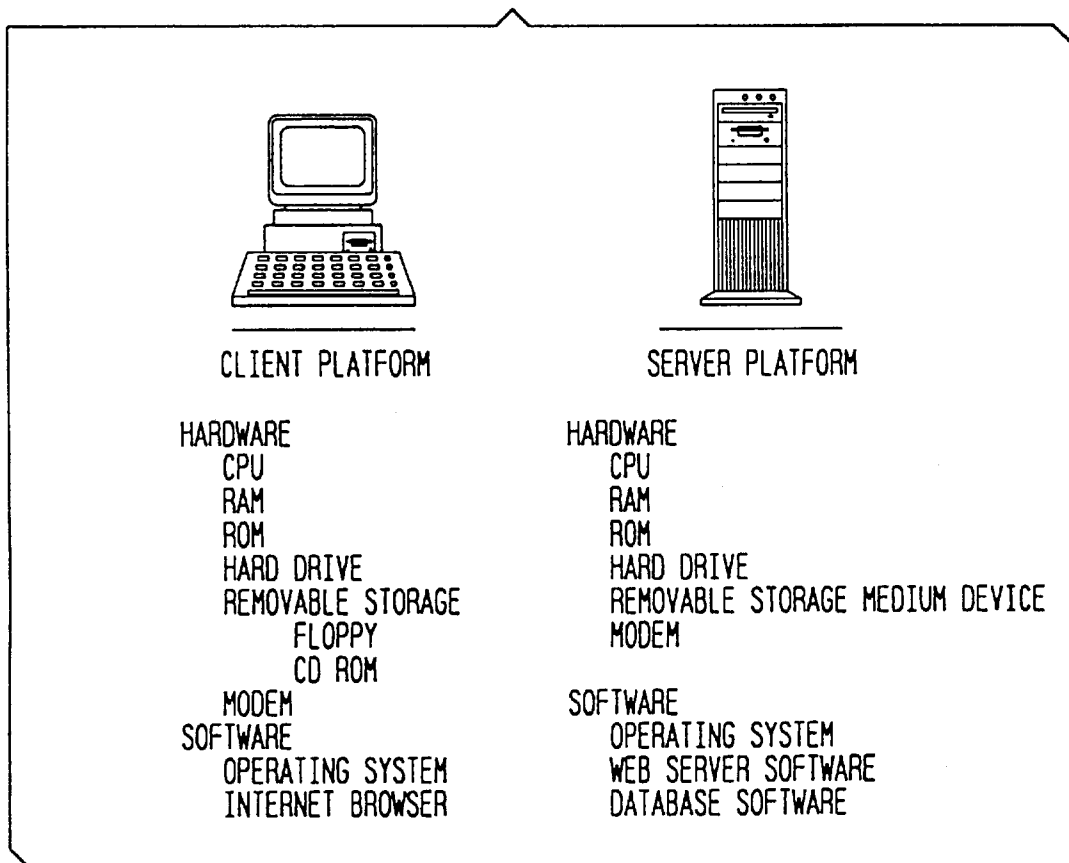

FIG. 1C

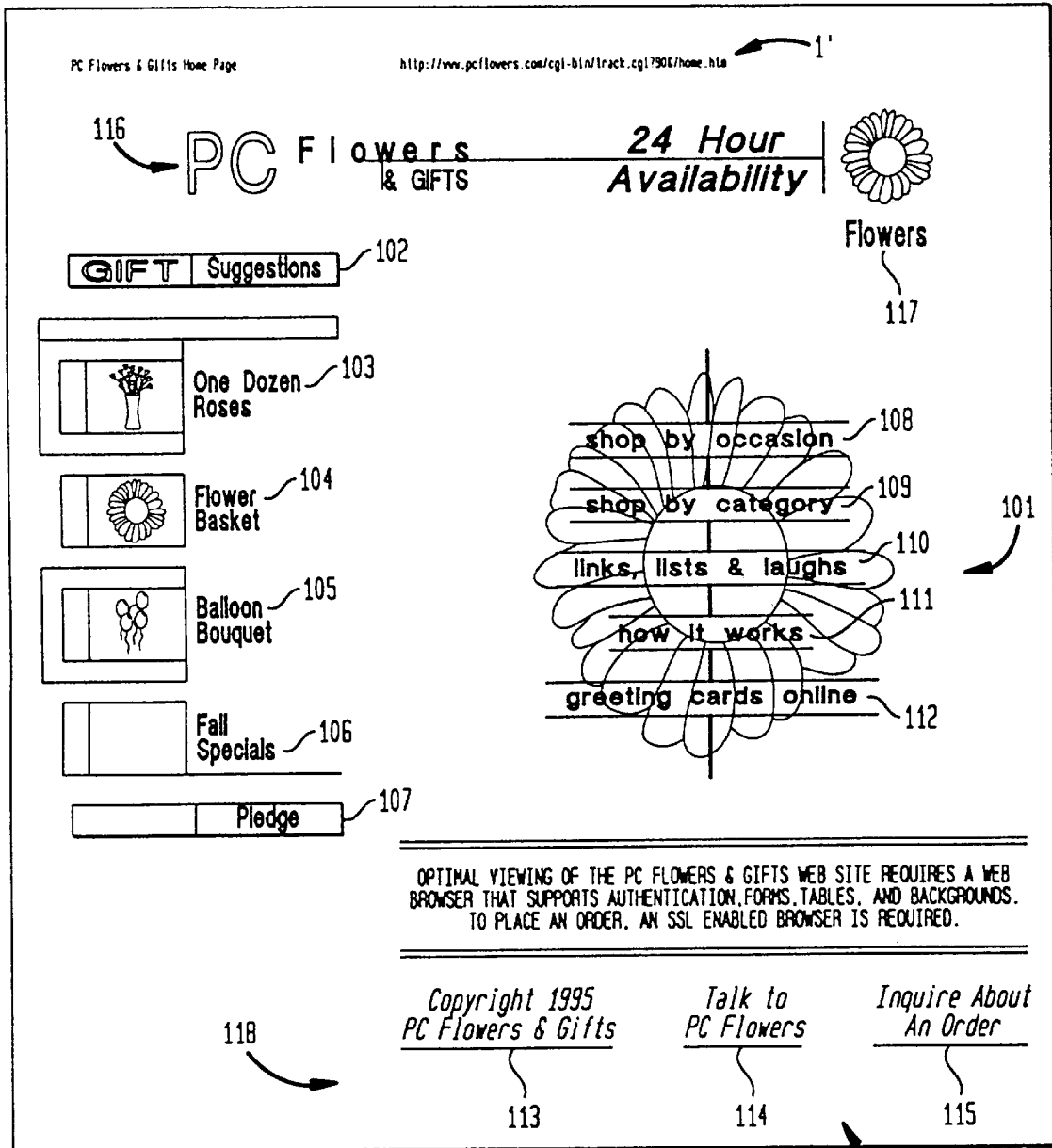

FIG. 2

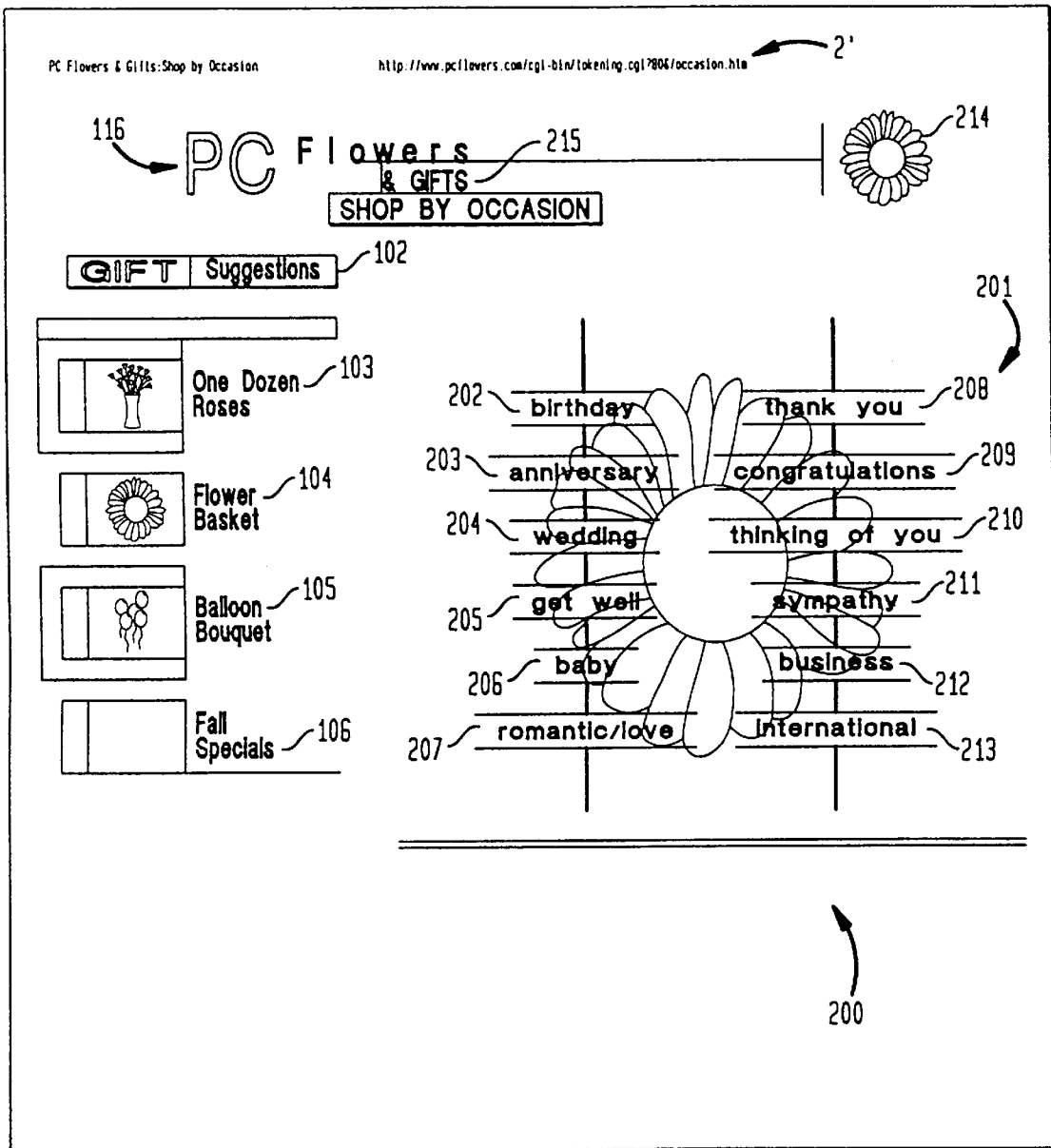

FIG. 3

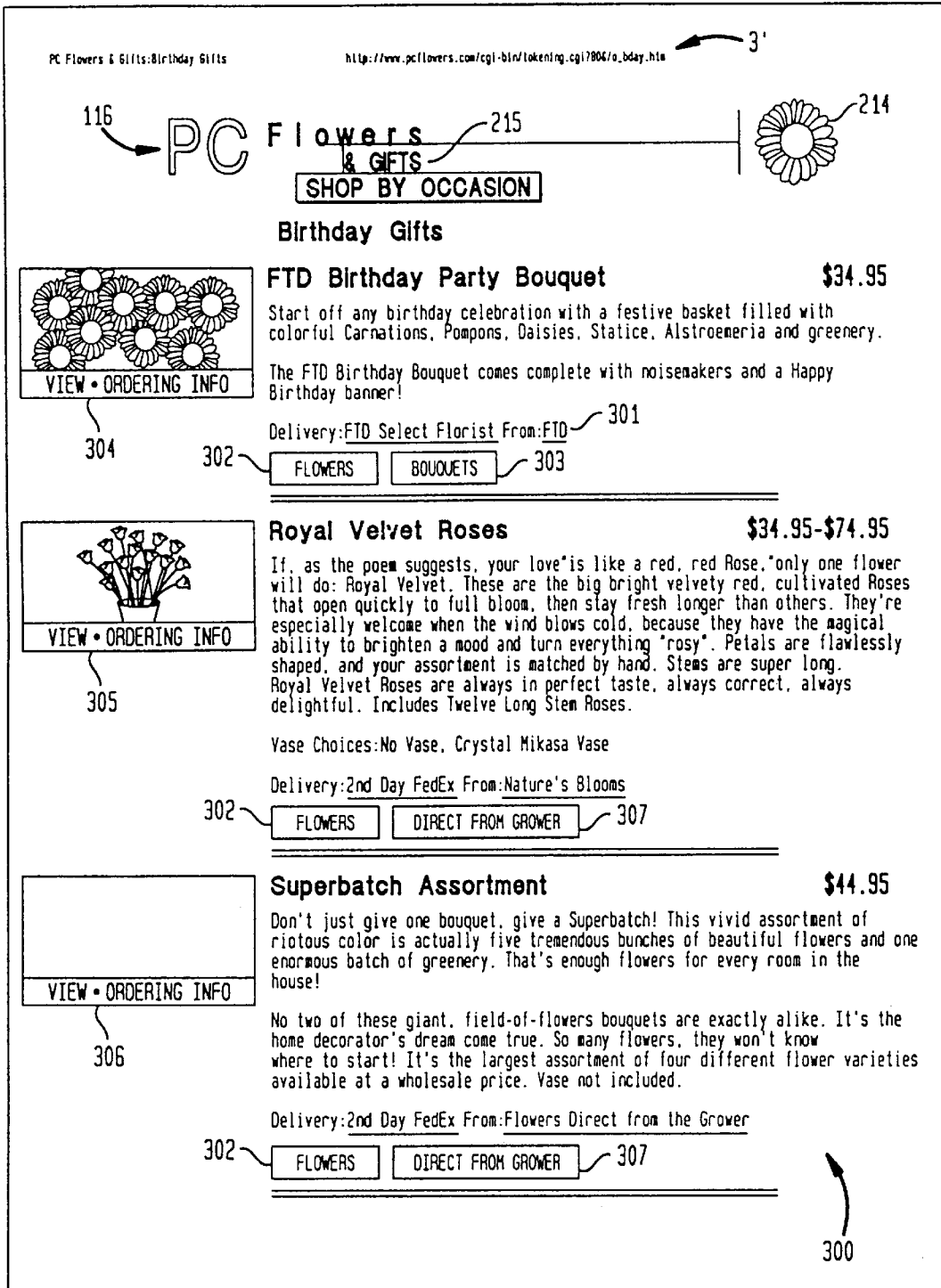

FIG. 4

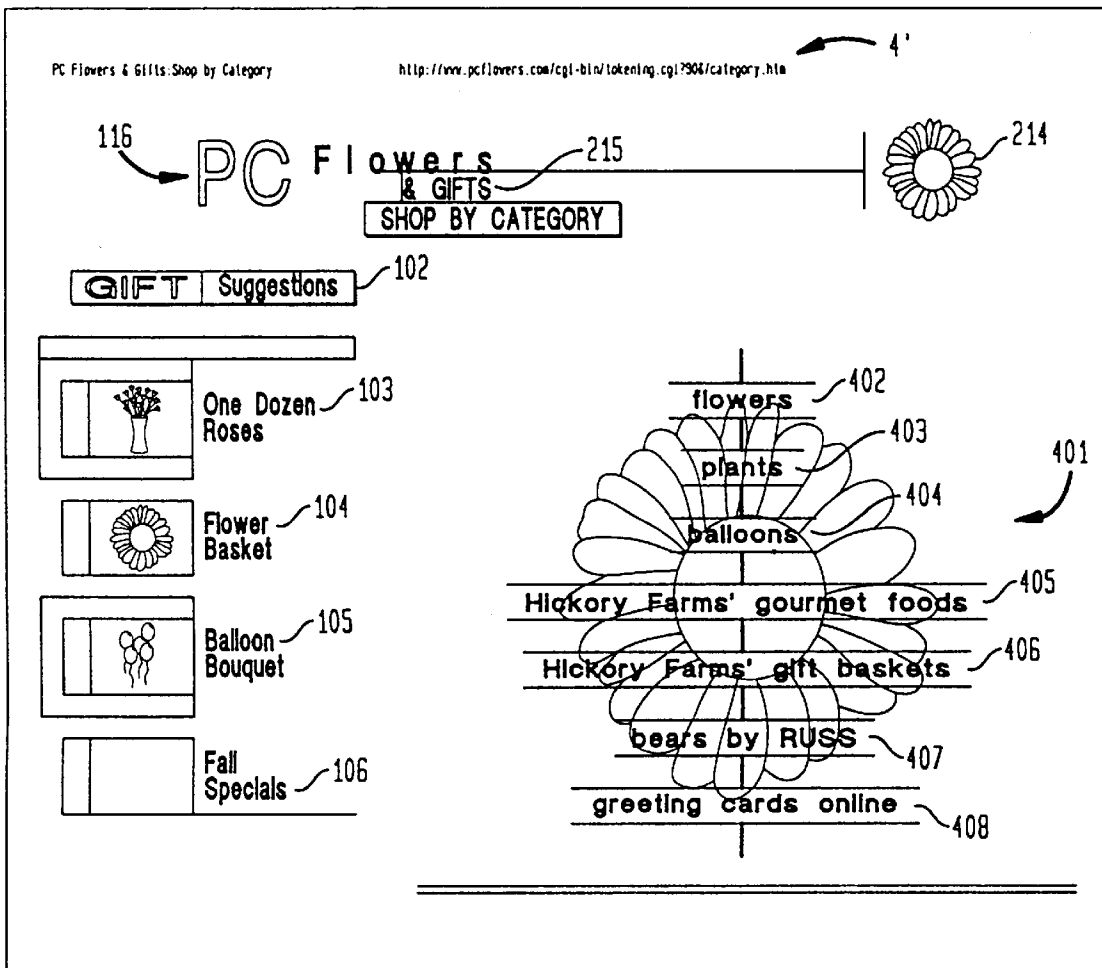

FIG. 5

PC Flowers & Gifts: Balloons http://www.pcflowers.com/cgi-bin/tokening.cgi?806/vendor03/balloons.htm 5'

116 **PC Flowers & GIFTS** 214

**SHOP BY CATEGORY**

---

**Balloons**

**12 Latex Balloons** **\$19.95**

Balloon bouquets make any festive occasion a celebration!

Choose latex balloons in a rainbow of colors for bouquets that last several hours.

Delivery: FTD Select Florist From: FTD

Some Suggested Occasions Include:

**3 Mylar & 6 Latex Balloons** **\$24.95**

Balloon bouquets make any festive occasion a celebration!

Choose latex balloons in a rainbow of colors that last several hours and shimmery printed mylar balloons that last a few weeks.

Mylar Balloon Choices: Baby Boy, Baby Girl, Congratulations, Get Well, Happy Birthday, Happy Anniversary, I Love You, Thank You, Thinking of You

Delivery: FTD Select Florist From: FTD

Some Suggested Occasions Include:

**6 Mylar Balloons** **\$29.95**

Balloon bouquets make any festive occasion a celebration!

Choose shimmery printed mylar balloons for bouquets that last a few weeks.

Mylar Balloon Choices: Baby Boy, Baby Girl, Congratulations, Get Well, Happy Birthday, Happy Anniversary, I Love You, Thank You, Thinking of You

Delivery: FTD Select Florist From: FTD

Some Suggested Occasions Include:

500



FIG. 6

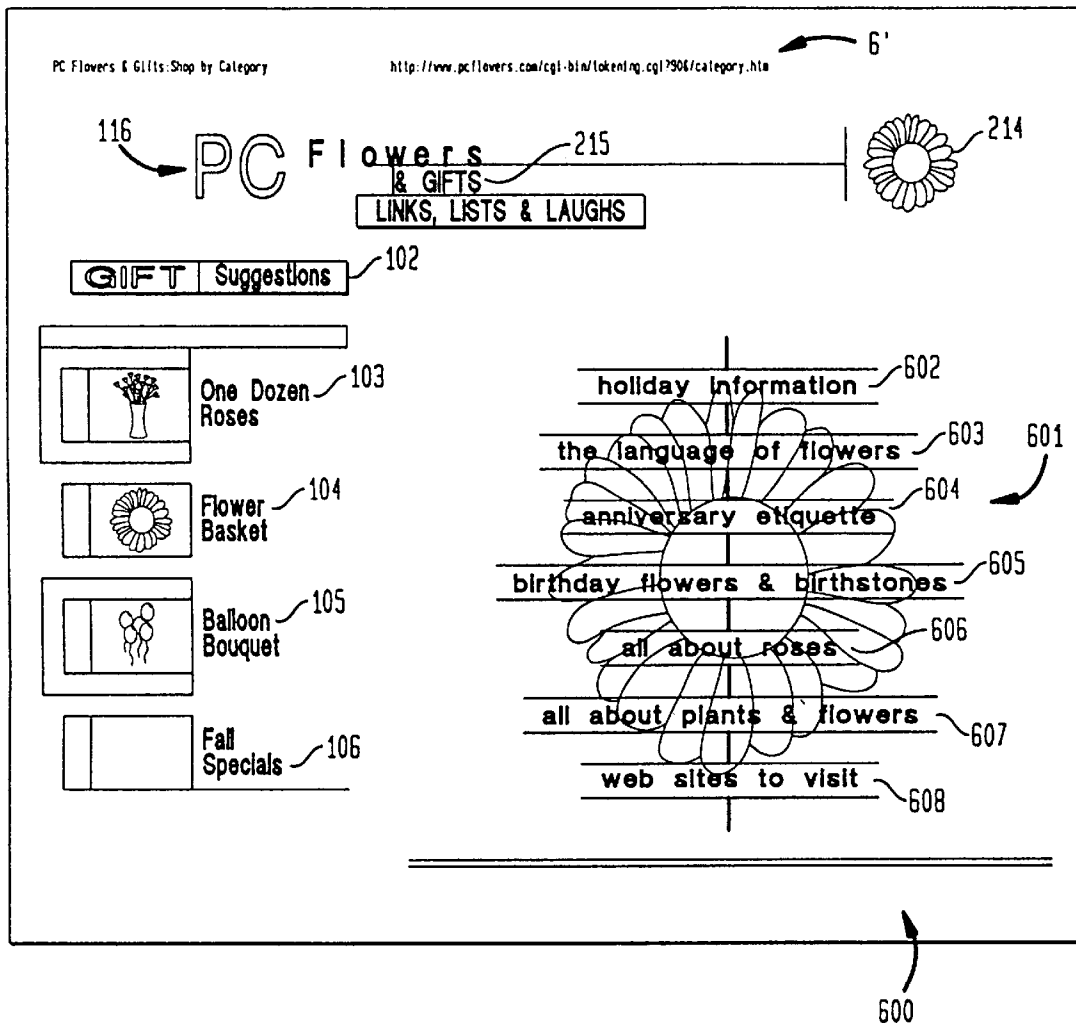

FIG. 7

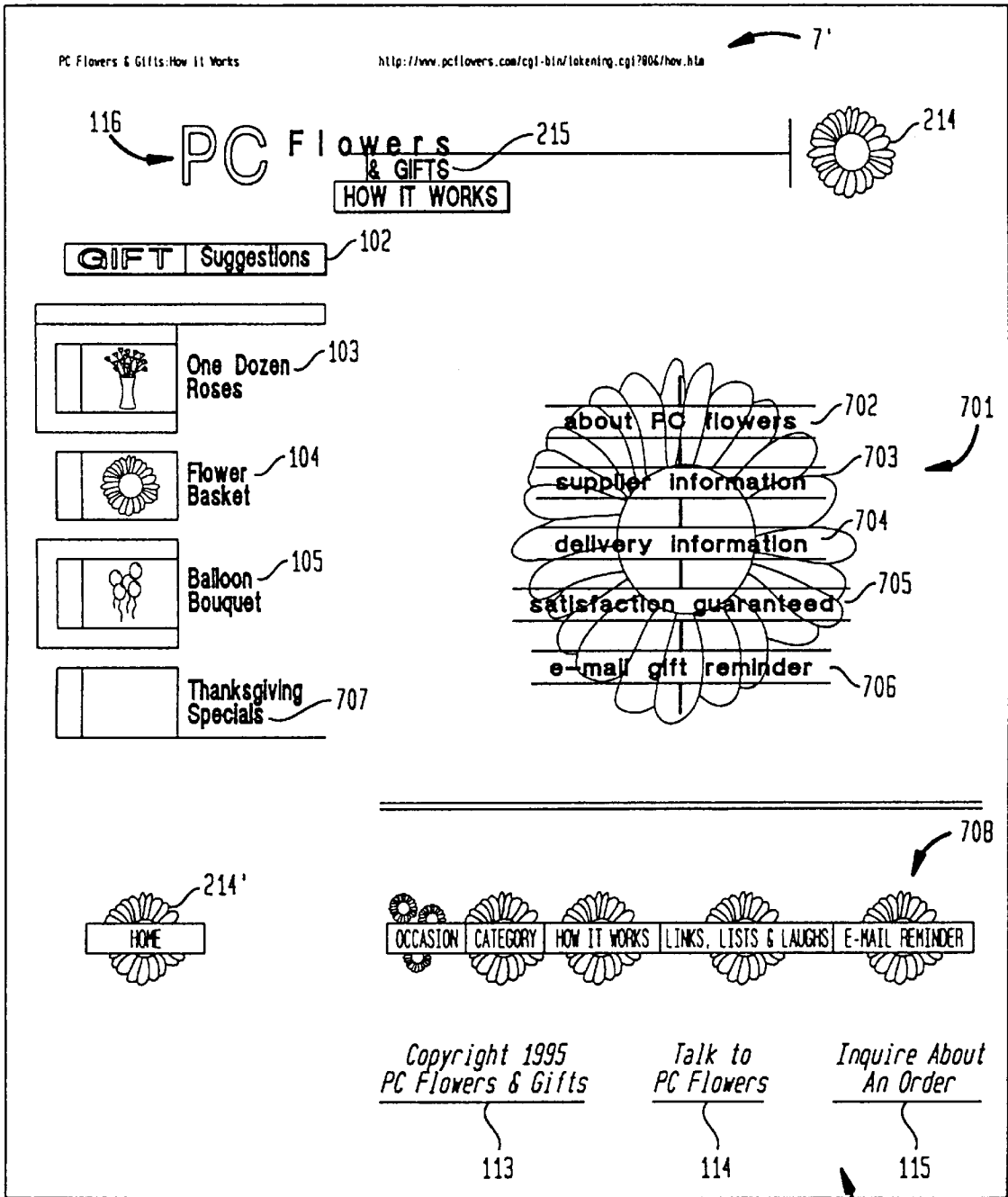

FIG. 8

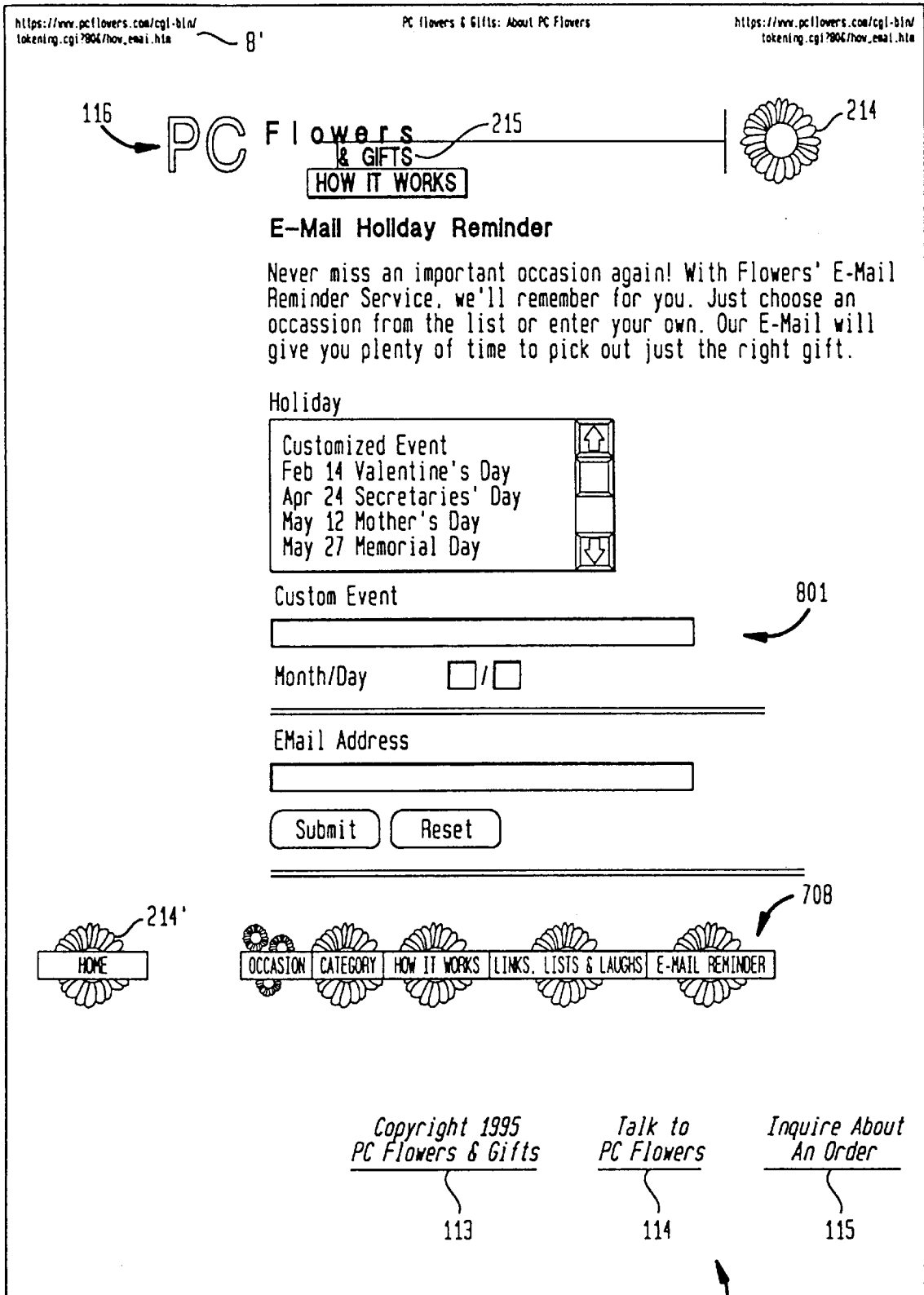

FIG. 9

http://www.pcflowers.com/cgi-bin/tokening.cgi?cg  
 1-bin/tokening.cgi?906/vendor93/FR12.htm 91

PC flowers & Gifts: Item Information

http://www.pcflowers.com/cgi-bin/tokening.cgi?cg  
 1-bin/tokening.cgi?906/vendor93/FR12.htm

116 → **PC Flowers & GIFTS**

**ITEM INFORMATION**

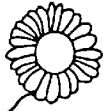
214 

**Royal Velvet Roses**

**\$34.95-\$74.95**

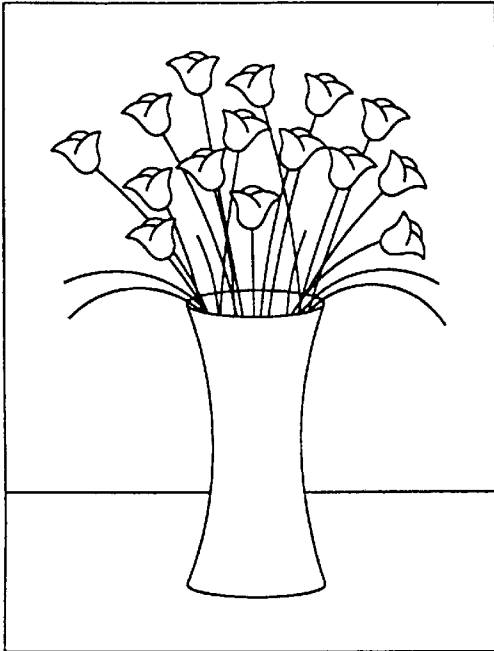

If, as the poem suggests, your love 'is like a red, red Rose,' only one flower will do: Royal Velvet. These are the big bright velvety red, cultivated Roses that open quickly to full bloom, then stay fresh longer than others. They're especially welcome when the wind blows cold, because they have the magical ability to brighten a mood and turn everything 'rosy.' Petals are flawlessly shaped, and your assortment is matched by hand. Stems are super long. Royal Velvet Roses are always in perfect taste, always correct, always delightful. Includes Twelve Long Stem Roses.

Delivery: 2nd Day FedEx  
 From: Nature's Blooms

Choose Vase:

No Vase (\$34.95):

**PLACE ORDER \$34.95** 901

Crystal Mikasa Vase (\$74.95):

**PLACE ORDER \$74.95** 902

**FLOWERS**

**DIRECT FROM GROWER**

**BIRTHDAY**

**ANNIVERSARY**





**ROMANTIC LOVE**

**CONGRATULATIONS**

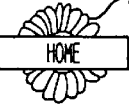
**THINKING OF YOU** 900

---

214'  **HOME**

 **OCCASION**  **CATEGORY**  **HOW IT WORKS**  **LINKS, LISTS & LAUGHS**  **E-MAIL REMINDER** 708

*Copyright 1995*  
**PC Flowers & Gifts** 113

*Talk to*  
**PC Flowers** 114

*Inquire About*  
**An Order** 115

FIG. 10

https://www.pcflovers.com/cgi-bin/order\_gen.cgi?906RR1206/render03/ 101 PC (lovers & Gifts): Order Form https://www.pcflovers.com/cgi-bin/order\_gen.cgi?906RR1206/render03/

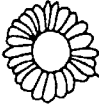
**PC Flowers & GIFTS**  214

**Order Form**

**Personalization**

Receiver's Name

Personalization Text

Closing

Sender's Name

**Receiver Information**

Name

Address1

Address2

City  State  Zip

Daytime Phone

**Sender Information**

Name

Address1

Address2

City  State  Zip

Daytime Phone

It is imperative that we receive your E-mail address in order to guarantee the successful processing of your order.

E-mail Address

**Delivery Information**

Delivery Date  /  /  (Month/Day/Year)

Special Instructions

**Credit Card Information**

MasterCard  Visa  American Express  Discover

Cardholder's Name

Card Number

Expiration Date  /  (Month/Year)

1001

FIG. 11A

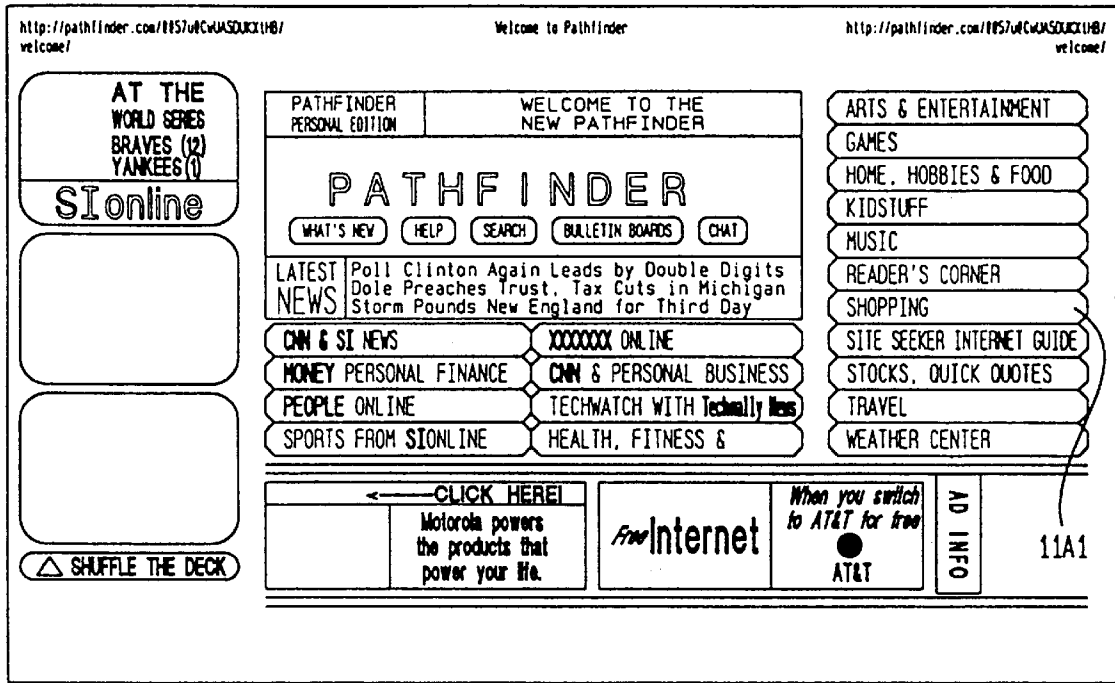

11A0

FIG. 11B

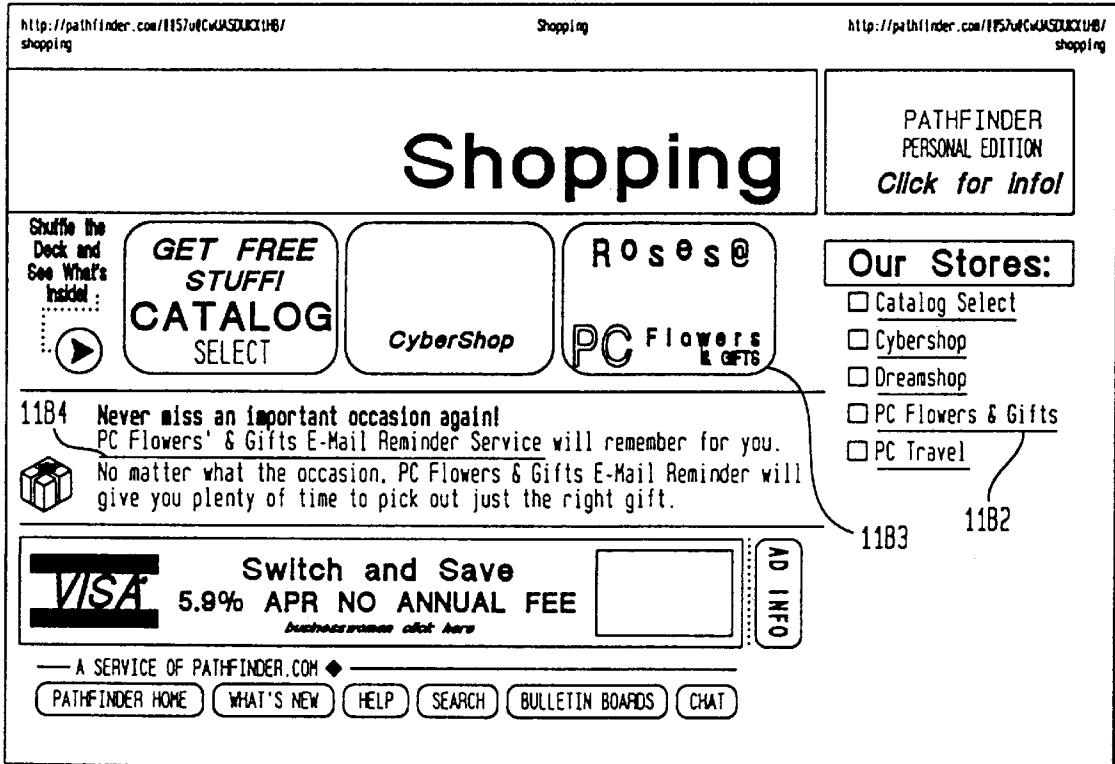

11B0

FIG. 11C

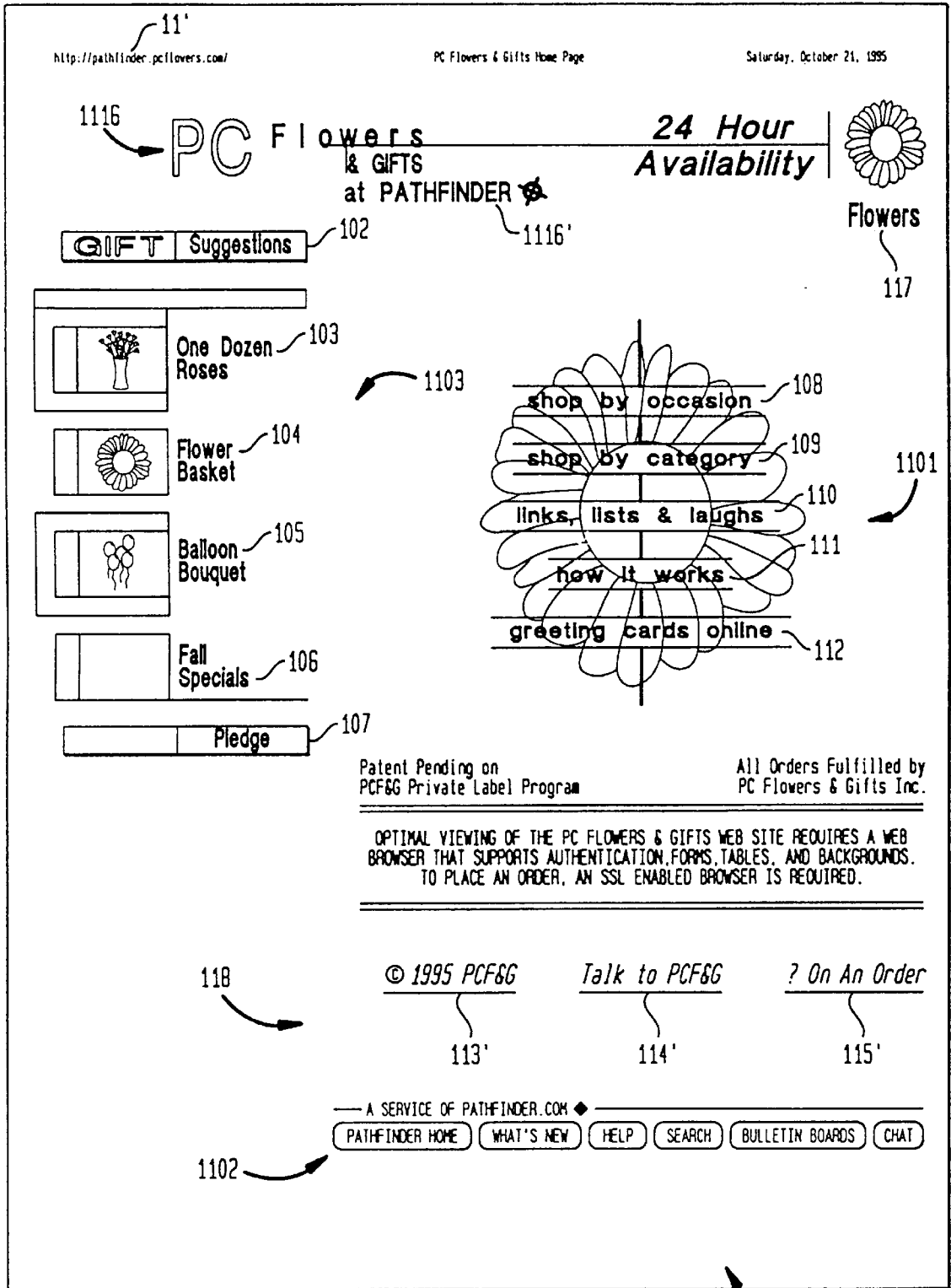

FIG. 12

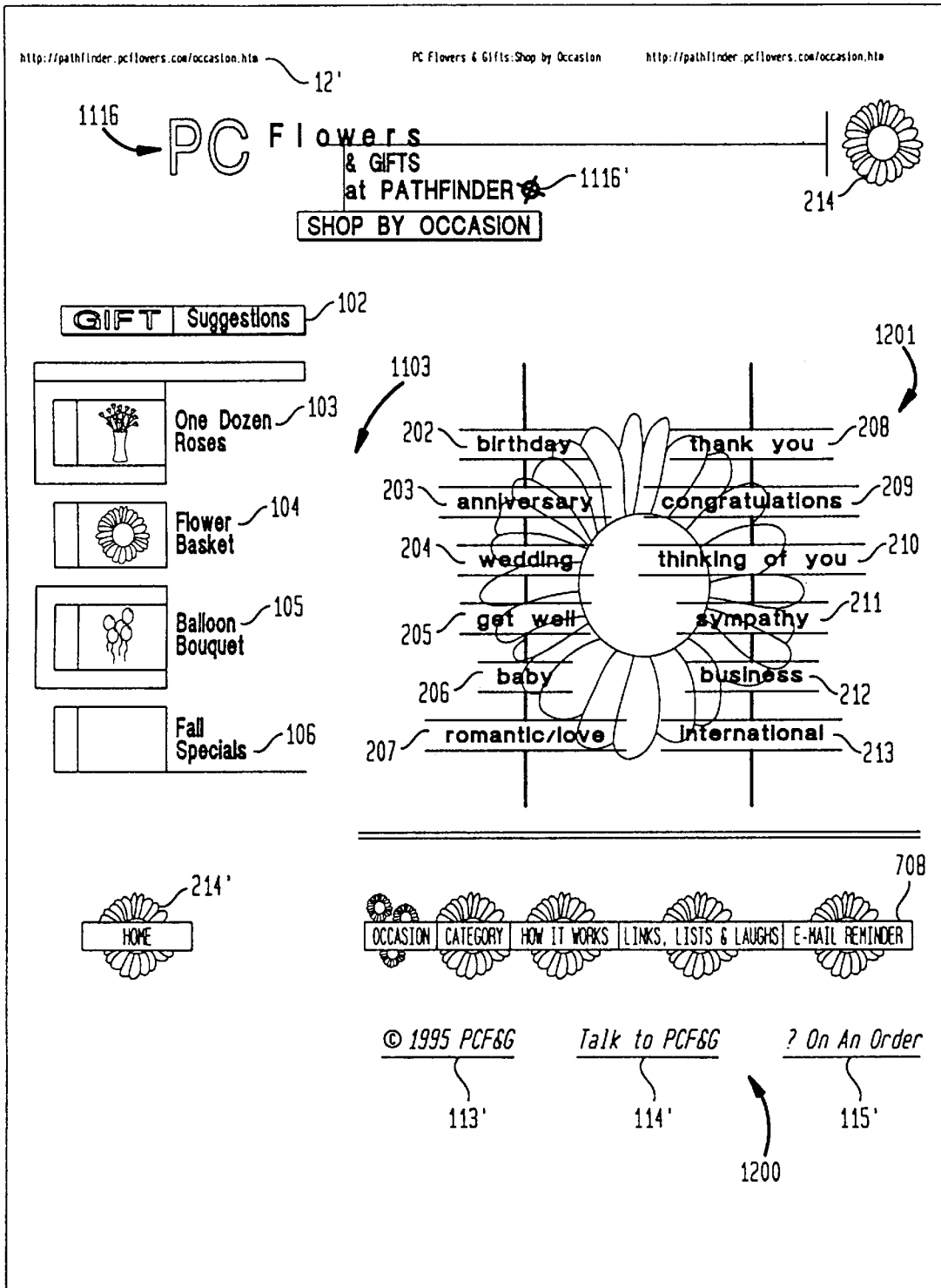





FIG. 13

http://pathfinder.pcflovers.com/o\_bday.htm PC Flowers & Gifts: Birthday Gifts http://pathfinder.pcflovers.com/o\_bday.htm

1116 **PC Flowers** & GIFTS at PATHFINDER 1116'  214

**SHOP BY OCCASION**

**Birthday Gifts**

---

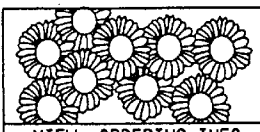

VIEW • ORDERING INFO

304

**FTD Birthday Party Bouquet** **\$34.95**

Start off any birthday celebration with a festive basket filled with colorful Carnations, Pompons, Daisies, Statice, Alstroemeria and greenery.

The FTD Birthday Bouquet comes complete with noisemakers and a Happy Birthday banner!

Delivery: FTD Select Florist From: FTD 301

302 FLOWERS BOUQUETS 303

---



VIEW • ORDERING INFO

305

**Royal Velvet Roses** **\$34.95-\$74.95**

If, as the poem suggests, your love is like a red, red Rose, only one flower will do: Royal Velvet. These are the big, bright, velvety red, cultivated Roses that open quickly to full bloom, then stay fresh longer than others. They're especially welcome when the wind blows cold, because they have the magical ability to brighten a mood and turn everything "rosy". Petals are flawlessly shaped, and your assortment is matched by hand. Stems are super long. Royal Velvet Roses are always in perfect taste, always correct, always delightful. Includes Twelve Long Stem Roses.

Vase Choices: No Vase, Crystal Mikasa Vase

Delivery: 2nd Day FedEx From: Nature's Blooms

302 FLOWERS DIRECT FROM GROWER 307

---



VIEW • ORDERING INFO

306

**Superbatch Assortment** **\$44.95**

Don't just give one bouquet, give a Superbatch! This vivid assortment of riotous color is actually five tremendous bunches of beautiful flowers and one enormous batch of greenery. That's enough flowers for every room in the house!

No two of these giant, field-of-flowers bouquets are exactly alike. It's the home decorator's dream come true. So many flowers, they won't know where to start! It's the largest assortment of four different flower varieties available at a wholesale price. Vase not included.

Delivery: 2nd Day FedEx From: Flowers Direct from the Grower

302 FLOWERS DIRECT FROM GROWER 307

1300

FIG. 14

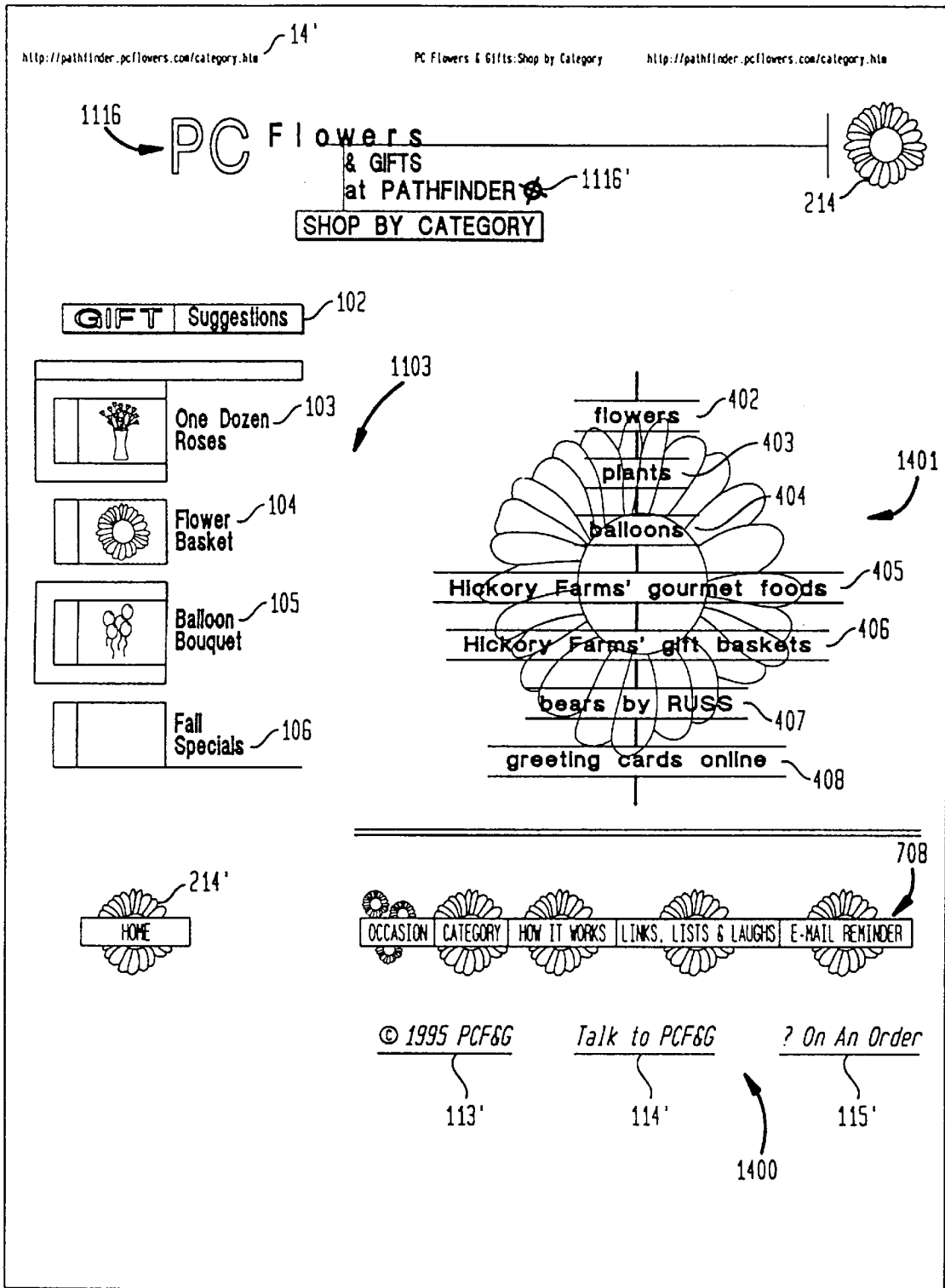

FIG. 15

15'

<http://pathfinder.pcflowers.com/vendor03/balloons.htm> PC Flowers & Gifts-Balloons <http://pathfinder.pcflowers.com/vendor03/balloons.htm>

1116 **PC Flowers & GIFTS** at PATHFINDER 1116' 214

**SHOP BY CATEGORY**

**Balloons**

**12 Latex Balloons** **\$19.95**

Balloon bouquets make any festive occasion a celebration!

Choose latex balloons in a rainbow of colors for bouquets that last several hours.

Delivery: FTD Select Florist From: FTD

Some Suggested Occasions Include:

504

---

**3 Mylar & 6 Latex Balloons** **\$24.95**

Balloon bouquets make any festive occasion a celebration!

Choose latex balloons in a rainbow of colors that last several hours and shimmering printed mylar balloons that last a few weeks.

Mylar Balloon Choices: Baby Boy, Baby Girl, Congratulations, Get Well, Happy Birthday, Happy Anniversary, I Love You, Thank You, Thinking of You

Delivery: FTD Select Florist From: FTD

Some Suggested Occasions Include:

502

1500

FIG. 16

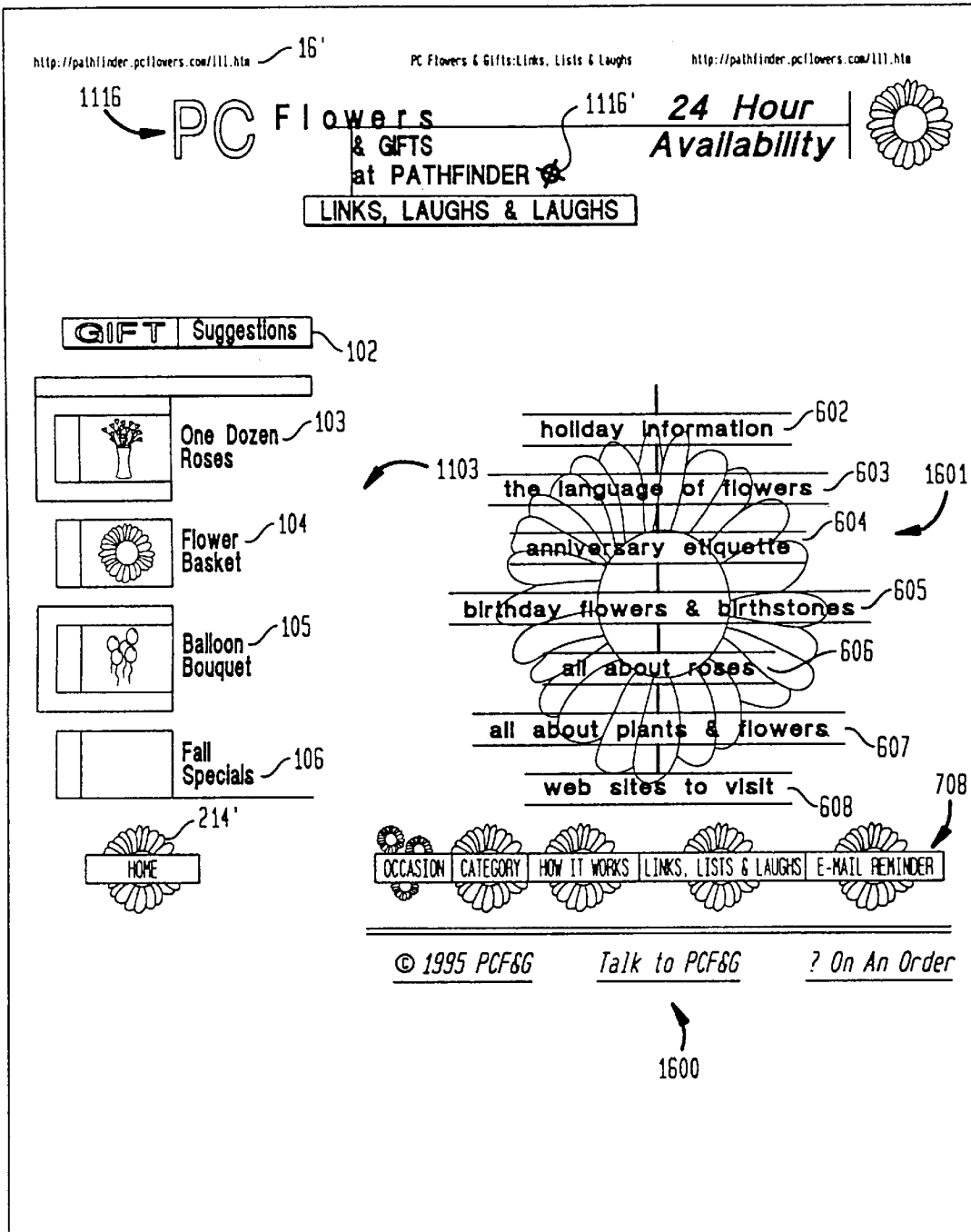

FIG. 17

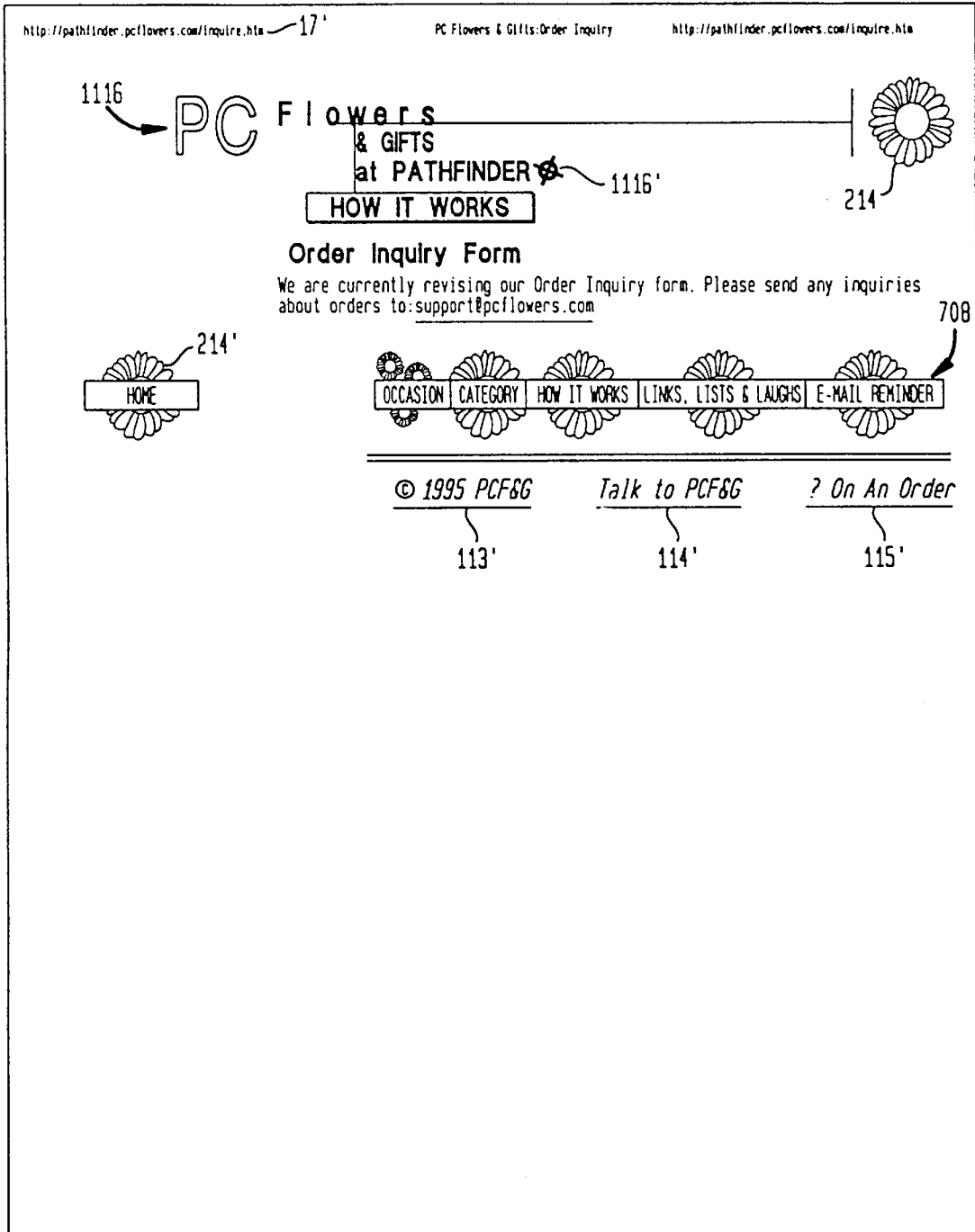

FIG. 18

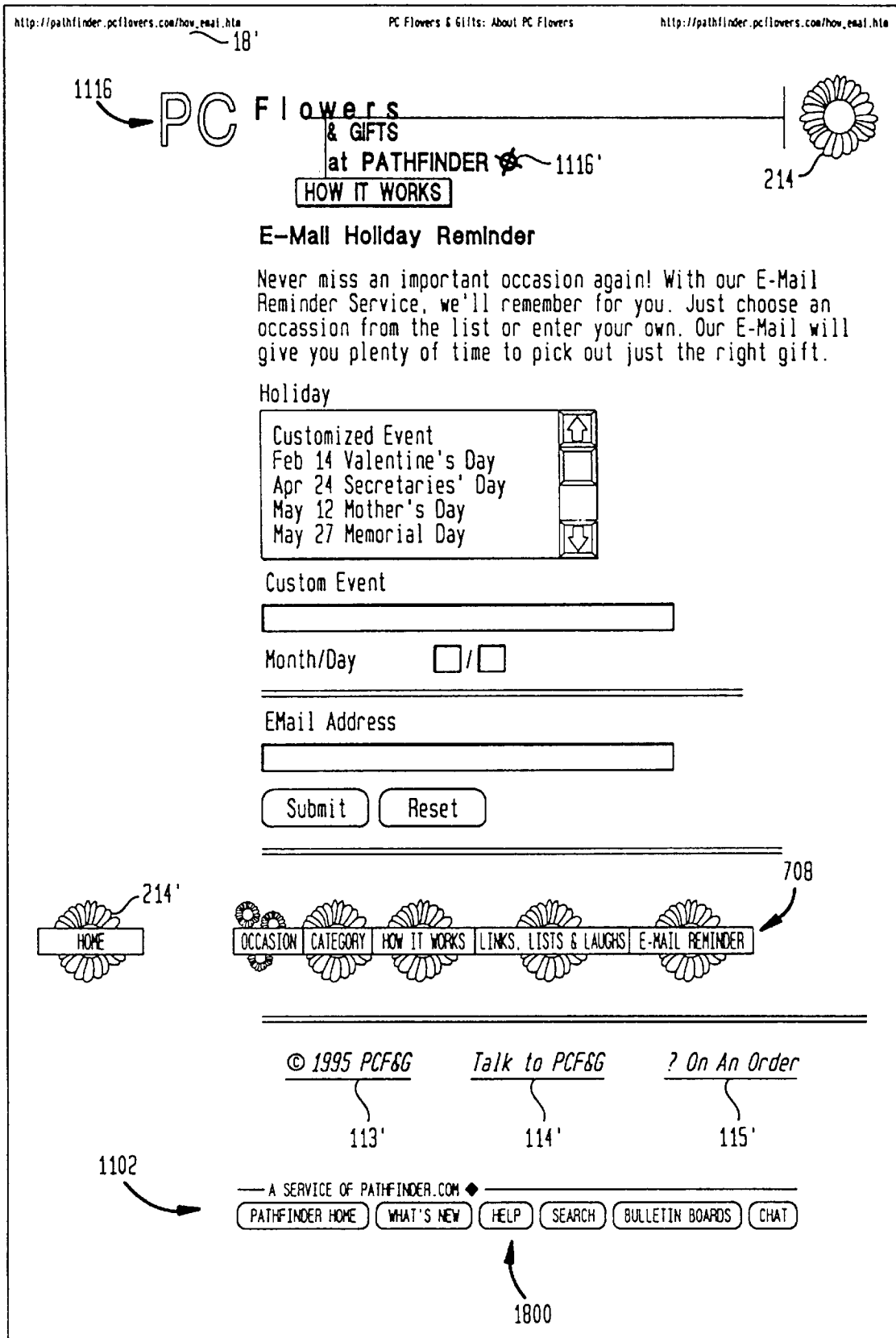
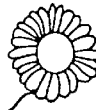
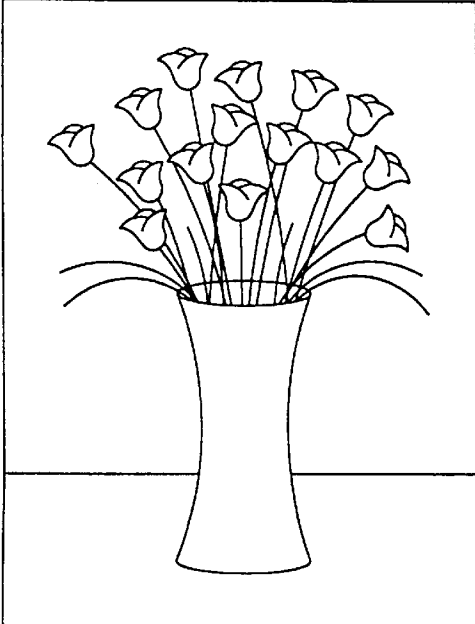

FIG. 19A

PC Flowers & Gifts: Item Information 19' <http://pathfinder.pcflowers.com/vendor03/RR12.htm>

1116 **PC Flowers & GIFTS** 214   
 at PATHFINDER 1116'  
**ITEM INFORMATION**

**Royal Velvet Roses** **\$34.95-\$74.95**



If, as the poem suggests, your love is like a red, red Rose, only one flower will do: Royal Velvet. These are the big bright velvety red, cultivated Roses that open quickly to full bloom, then stay fresh longer than others. They're especially welcome when the wind blows cold, because they have the magical ability to brighten a mood and turn everything "rosy." Petals are flawlessly shaped, and your assortment is matched by hand. Stems are super long. Royal Velvet Roses are always in perfect taste, always correct, always delightful. Includes Twelve Long Stem Roses.

Delivery: 2nd Day FedEx  
 From: Nature's Blooms

Choose Vase:

No Vase: (\$34.95): 901  
PLACE ORDER \$34.95

Crystal Mikasa Vase (\$74.95): 902  
PLACE ORDER \$74.95

FLOWERS

DIRECT FROM GROWER

BIRTHDAY

ANNIVERSARY

ROMANTIC/LOVE

CONGRATULATIONS

THINKING OF YOU 1900

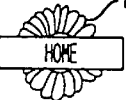
214' 

HOME

 OCCASION CATEGORY HOW IT WORKS LINKS, LISTS & LAUGHS E-MAIL REMINDER 708

FIG. 19B

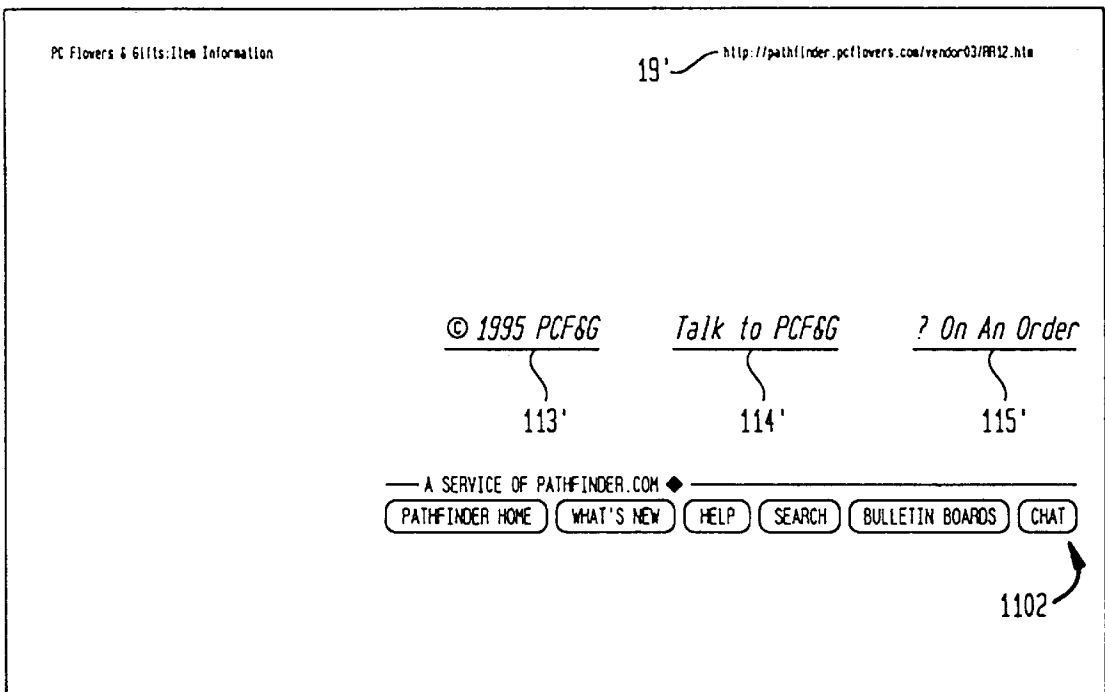





FIG. 20

[https://www.pcflovers.com/cgi-bin/order\\_gen.cgi?124623-3664/vendor03/](https://www.pcflovers.com/cgi-bin/order_gen.cgi?124623-3664/vendor03/)
PC Flowers & Gifts: Order Form
20' [https://www.pcflovers.com/cgi-bin/order\\_gen.cgi?124623-3664/vendor03/](https://www.pcflovers.com/cgi-bin/order_gen.cgi?124623-3664/vendor03/)

---

1116
**PC Flowers**
214 

& GIFTS
at PATHFINDER
1116'

### Order Form

**Personalization**

Receiver's Name

Personalization Text

Closing

Sender's Name

**Receiver Information**

Name

Address1

Address2

City  State  Zip

Daytime Phone

**Sender Information**

Name

Address1

Address2

City  State  Zip

Daytime Phone

It is imperative that we receive your E-mail address in order to guarantee the successful processing of your order.

E-mail Address

**Delivery Information**

Delivery Date  /  /  (Month/Day/Year)

Special Instructions

**Credit Card Information**

MasterCard
  Visa
  American Express
  Discover

Cardholder's Name

Card Number

Expiration Date  /  (Month/Year)

2000

FIG. 21A

http://homearts.com/ Welcome to HomeArts

Win a Sony  
Maximum  
Television  
System!



Your  
Computer Screen  
Wants You  
To Click Here.

---

A
H
o
m
e
A
r
t
s

n e t w o r k

search

Station	R & R	Bloom!	Runway	Planet Lunch
Family Time	Late	Kiss.Net	Body & Soul	Newsstand

talk to others

October 21, 1996

Today's Stories 

**REDBOOK**

Good Housekeeping

CountryLiving

Popular  
Mechanics

 YOUR QUESTIONS ANSWERED  
By Dr. Joyce Brothers

 ODE TO THE BLACK STUFF  
It takes a patient soul to drink a pint of Guinness Extra Stout

 PET RESCUE CLEARINGHOUSE  
Why buy a pet when you can adopt one?

 ROCKING HORSES  
And other collectibles



WINNING&LOSING  
Week two of your diet plan that will have you thinner in three weeks

21A1



more stories

---

21A0 

FIG. 21B

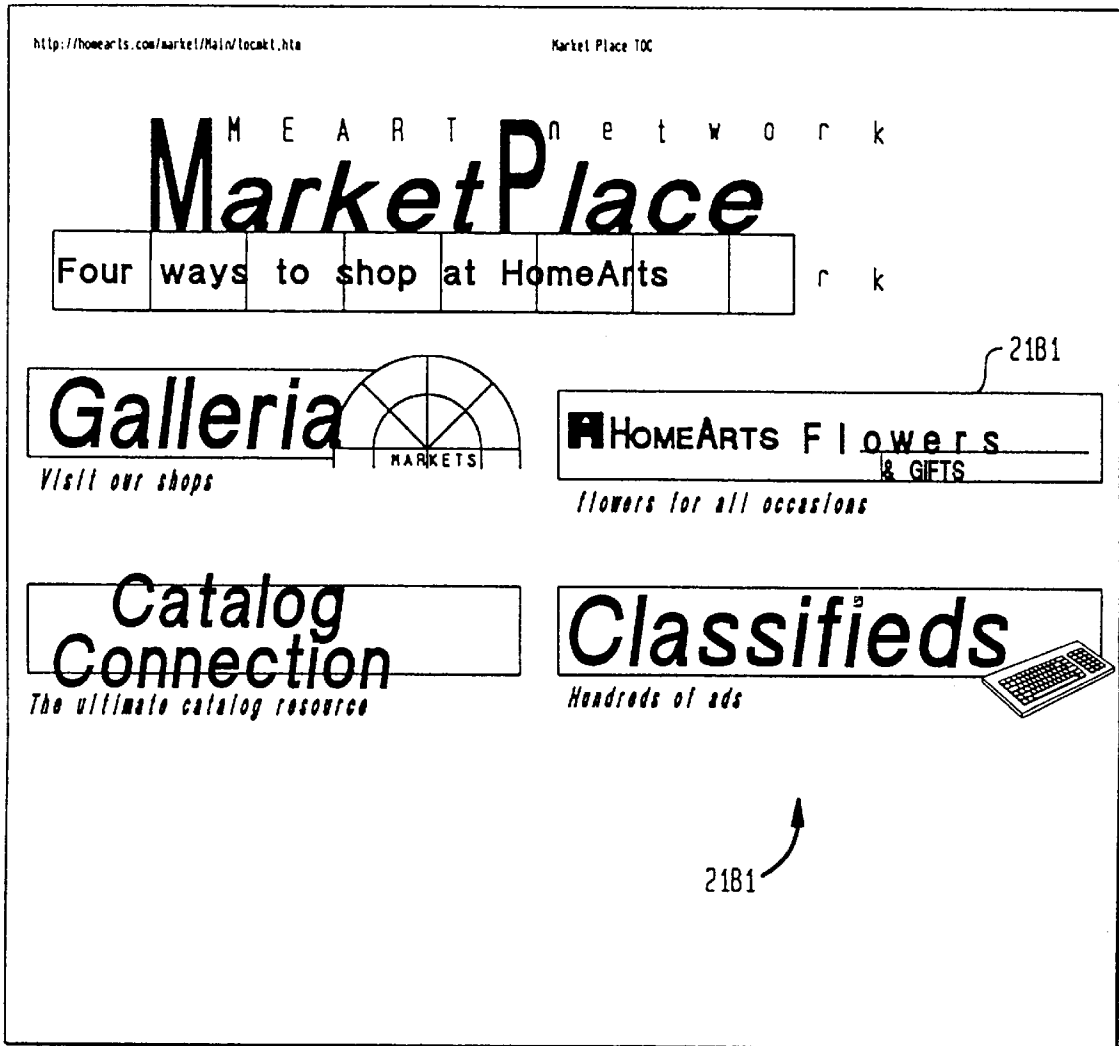

FIG. 21C

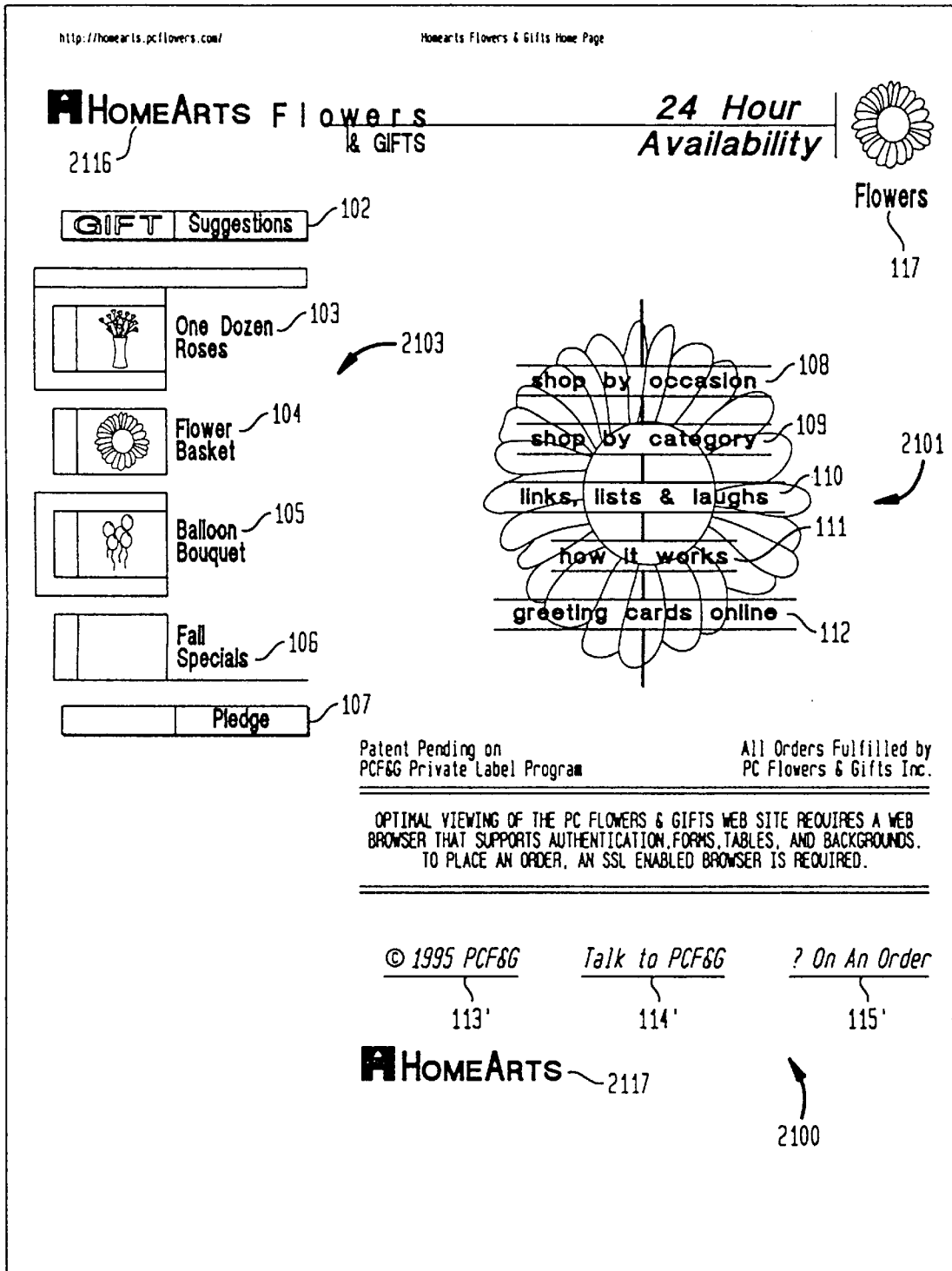

FIG. 22

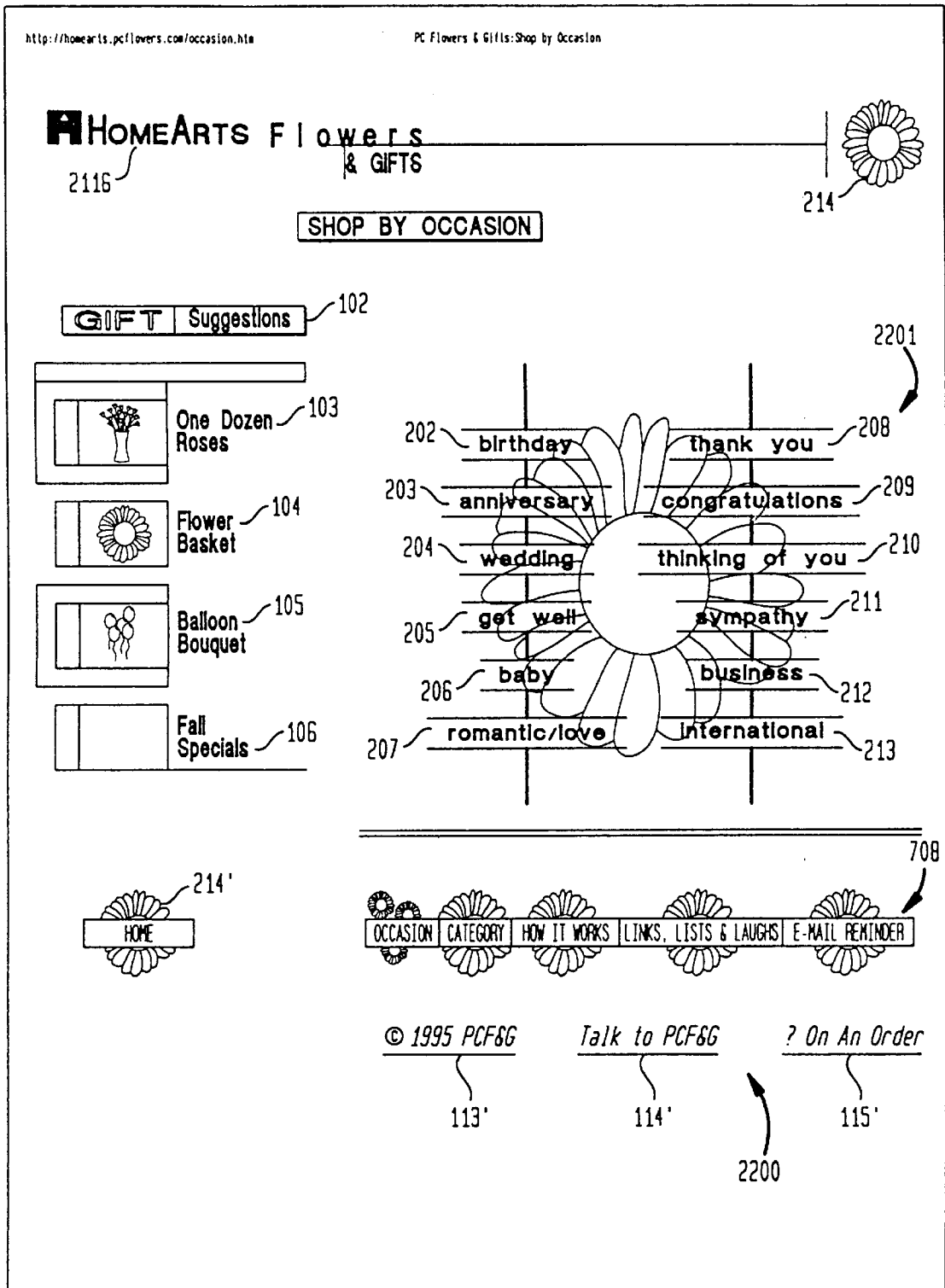

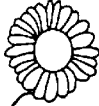

FIG. 23

http://homearts.pcflowers.com/o\_bday.htm PC Flowers & Gifts Birthday Gifts



2116



214

SHOP BY OCCASION

### Birthday Gifts

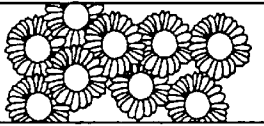

304

**FTD Birthday Party Bouquet** **\$34.95**

Start off any birthday celebration with a festive basket filled with colorful Carnations, Pompons, Daisies, Statice, Alstroemeria and greenery.

The FTD Birthday Bouquet comes complete with noisemakers and a Happy Birthday banner!

Delivery: FTD Select Florist From: FTD 301

302

FLOWERS

BOUQUETS

303

---



305

**Royal Velvet Roses** **\$34.95-\$74.95**

If, as the poem suggests, your love is like a red, red Rose, only one flower will do: Royal Velvet. These are the big bright velvety red, cultivated Roses that open quickly to full bloom, then stay fresh longer than others. They're especially welcome when the wind blows cold, because they have the magical ability to brighten a mood and turn everything "rosy". Petals are flawlessly shaped, and your assortment is matched by hand. Stems are super long. Royal Velvet Roses are always in perfect taste, always correct, always delightful. Includes Twelve Long Stem Roses.

Vase Choices: No Vase, Crystal Mikasa Vase

Delivery: 2nd Day FedEx From: Nature's Blooms

302

FLOWERS

DIRECT FROM GROWER

307

---



306

**Superbatch Assortment** **\$44.95**

Don't just give one bouquet, give a Superbatch! This vivid assortment of riotous color is actually five tremendous bunches of beautiful flowers and one enormous batch of greenery. That's enough flowers for every room in the house!

No two of these giant, field-of-flowers bouquets are exactly alike. It's like home decorator's dream come true. So many flowers, they won't know where to start! It's the largest assortment of four different flower varieties available at a wholesale price. Vase not included.

Delivery: 2nd Day FedEx From: Flowers Direct from the Grower

302

FLOWERS

DIRECT FROM GROWER

307

2300

FIG. 24

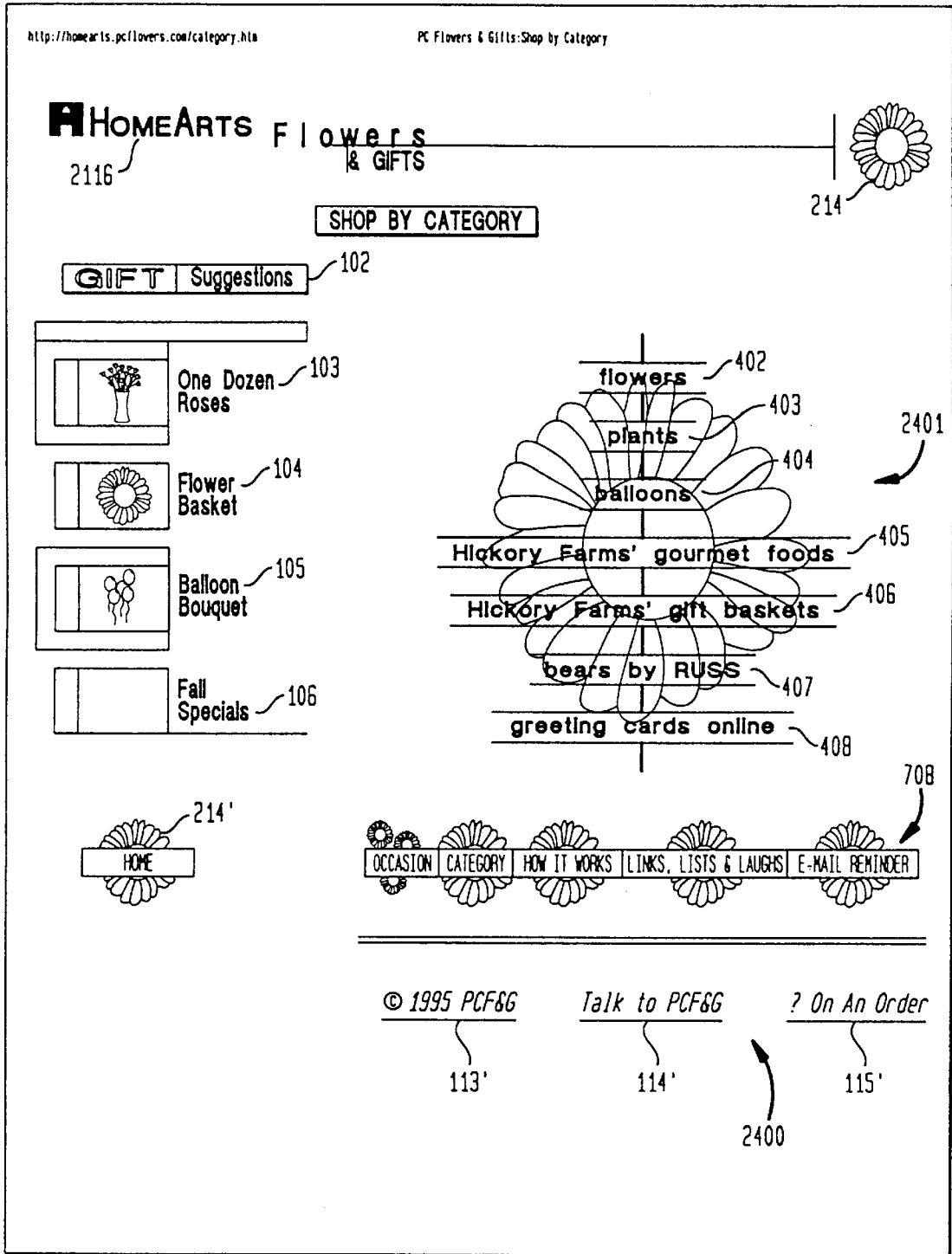



FIG. 25

http://homearts.pcflowers.com/vendor03/balloons.htm PC Flowers & Gifts: Balloons



**HOMEARTS**  
2116

**Flowers**  
& GIFTS

**SHOP BY CATEGORY**



214

---

**Balloons**

**12 Latex Balloons** **\$19.95**

Balloon bouquets make any festive occasion a celebration!

Choose latex balloons in a rainbow of colors for bouquets that last several hours.

Delivery: FTD Select Florist From: FTD

Some Suggested Occasions Include:

BIRTHDAY

ANNIVERSARY

GET WELL

ROMANTIC LOVE

THINKING OF YOU

VIEW • ORDERING INFO

504

**3 Mylar & 6 Latex Balloons** **\$24.95**

Balloon bouquets make any festive occasion a celebration!

Choose latex balloons in a rainbow of colors that last several hours and shimmering printed mylar balloons that last a few weeks.

Mylar Balloon Choices: Baby Boy, Baby Girl, Congratulations, Get Well, Happy Birthday, Happy Anniversary, I Love You, Thank You, Thinking of You

Delivery: FTD Select Florist From: FTD

Some Suggested Occasions Include:

GET WELL

BABY

ROMANTIC LOVE

THANK YOU

THINKING OF YOU

BUSINESS

VIEW • ORDERING INFO

505

**6 Mylar Balloons** **\$29.95**

Balloon bouquets make any festive occasion a celebration!

Choose shimmering printed mylar balloons for bouquets that last a few weeks.

Mylar Balloon Choices: Baby Boy, Baby Girl, Congratulations, Get Well, Happy Birthday, Happy Anniversary, I Love You, Thank You, Thinking of You

Delivery: FTD Select Florist From: FTD

Some Suggested Occasions Include:

BIRTHDAY

ANNIVERSARY

GET WELL

ROMANTIC LOVE

BUSINESS

VIEW • ORDERING INFO

506

501

502

503

2500



FIG. 26

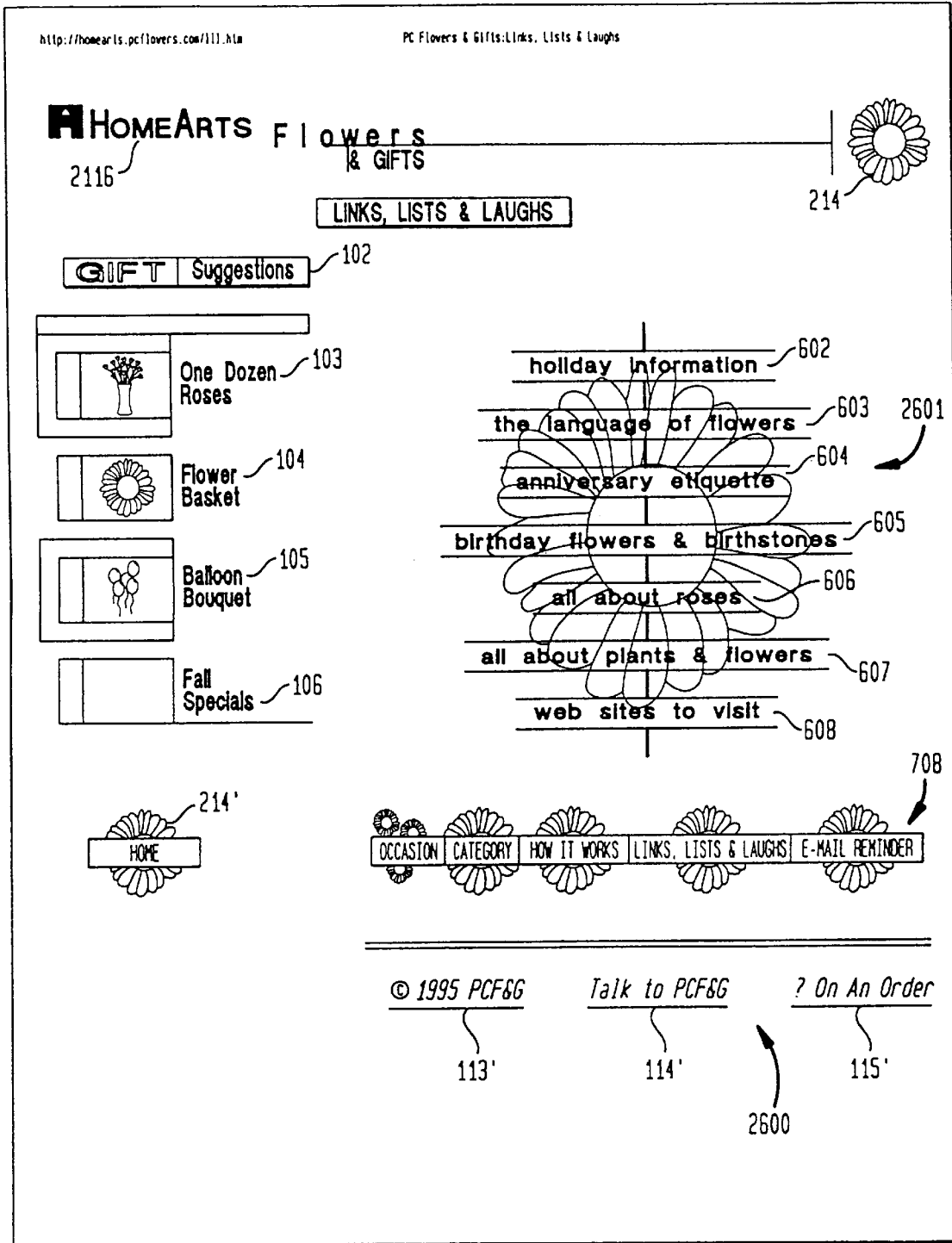

FIG. 27

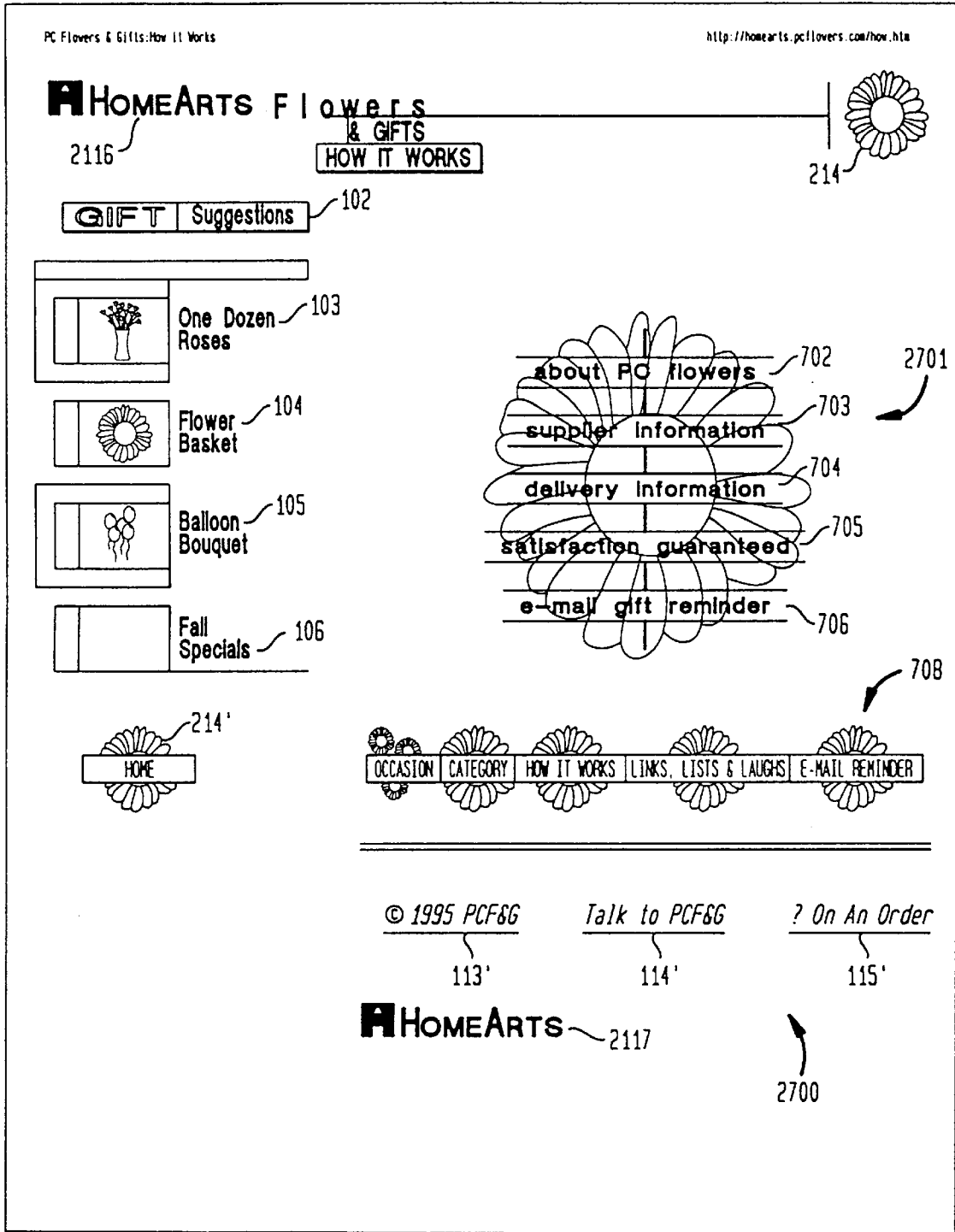



FIG. 28

http://homearts.pcflovers.com/how.hla\_email.htm PC Flowers & Gifts: About PC Flowers



**HOMEARTS Flowers & GIFTS**  214

2116 **HOW IT WORKS**

### E-Mail Holiday Reminder

Never miss an important occasion again! With our E-Mail Reminder Service, we'll remember for you. Just choose an occasion from the list or enter your own. Our E-Mail will give you plenty of time to pick out just the right gift.

Holiday

Customized Event	
Feb 14 Valentine's Day	<input type="checkbox"/>
Apr 24 Secretaries' Day	<input type="checkbox"/>
May 12 Mother's Day	<input type="checkbox"/>
May 27 Memorial Day	







Custom Event 801

Month/Day  /

---

Email Address

---

---

© 1995 PCF&G Talk to PCF&G ? On An Order

113' 114' 115'

**HOMEARTS** 2117 2800

FIG. 29A

PC Flowers & Gifts: Item Information http://homearts.pcflowers.com/vendor03/RR12.htm

**HOMEARTS** Flowers  
& GIFTS

2116



214

**ITEM INFORMATION**

**Royal Velvet Roses**

**\$34.95-\$74.95**

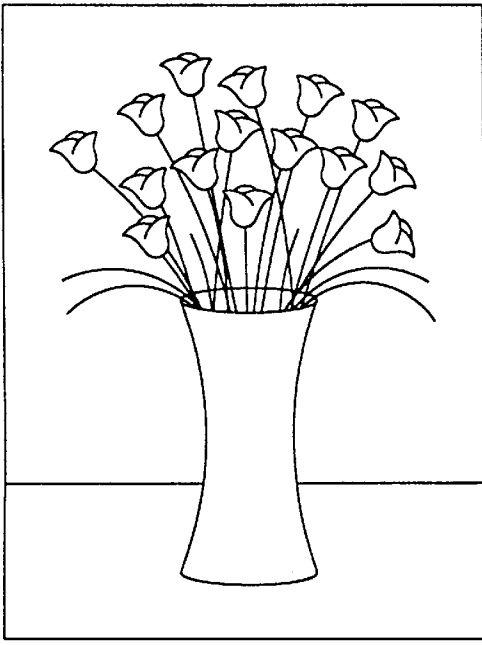

If, as the poem suggests, your love is like a red, red Rose, only one flower will do: Royal Velvet. These are the big bright velvety red, cultivated Roses that open quickly to full bloom, then stay fresh longer than others. They're especially welcome when the wind blows cold, because they have the magical ability to brighten a mood and turn everything "rosy." Petals are flawlessly shaped, and your assortment is matched by hand. Stems are super long. Royal Velvet Roses are always in perfect taste, always correct, always delightful. Includes Twelve Long Stem Roses.

Delivery: 2nd Day FedEx  
From: Nature's Blooms

Choose Vase:

No Vase: (\$34.95):

Crystal Mikasa Vase (\$74.95):

**PLACE ORDER \$34.95** 901

**PLACE ORDER \$74.95** 902

**FLOWERS**

**DIRECT FROM GROWER**

**BIRTHDAY**

**ANNIVERSARY**

**ROMANTIC LOVE**

**CONGRATULATIONS**

**THINKING OF YOU**



HOME

OCCASION | CATEGORY | HOW IT WORKS | LINKS, LISTS & LAUGHS | E-MAIL REMINDER

2900

708

FIG. 29B

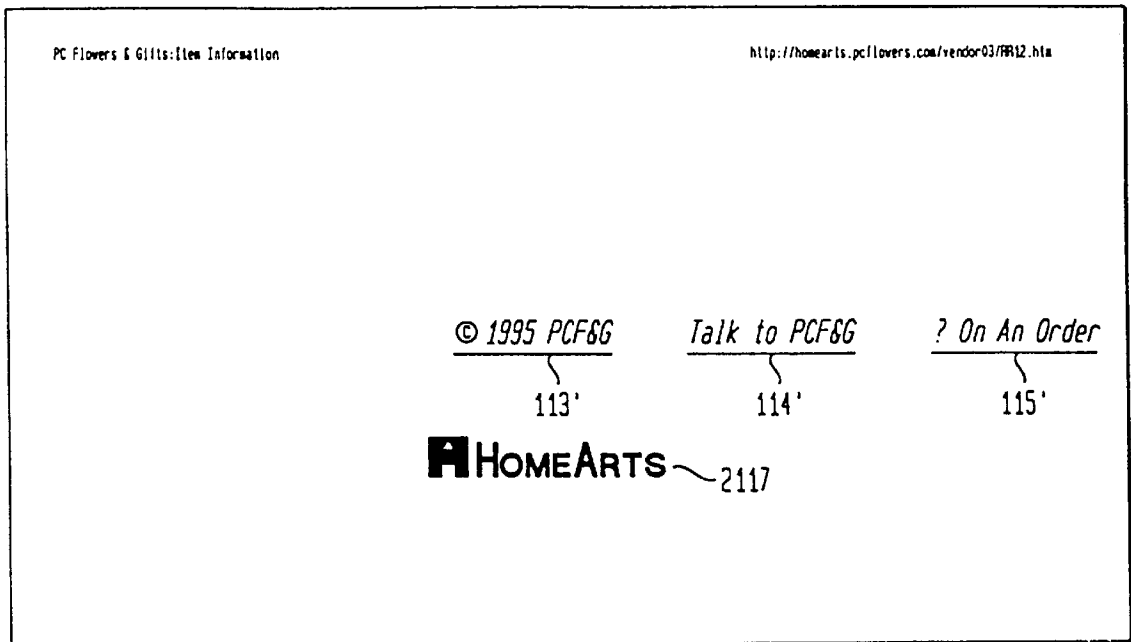

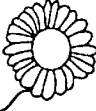

FIG. 30

https://www.pcflowers.com/cgi-bin/order\_gen.cgi?12423-36646/vendor03/ PC Flowers & Gifts: Order Form



2116



214

## Order Form

**Personalization**

Receiver's Name

Personalization Text

Closing

Sender's Name

**Receiver Information**

Name

Address1

Address2

City  State  Zip

Daytime Phone

**Sender Information**

Name

Address1

Address2

City  State  Zip

Daytime Phone

It is imperative that we receive your E-mail address in order to guarantee the successful processing of your order.

E-mail Address

**Delivery Information**

Delivery Date  /  /  (Month/Day/Year)

Special Instructions

**Credit Card Information**

MasterCard    Visa    American Express    Discover

Cardholder's Name

Card Number

Expiration Date  /  (Month/Year)

 3000

FIG. 31

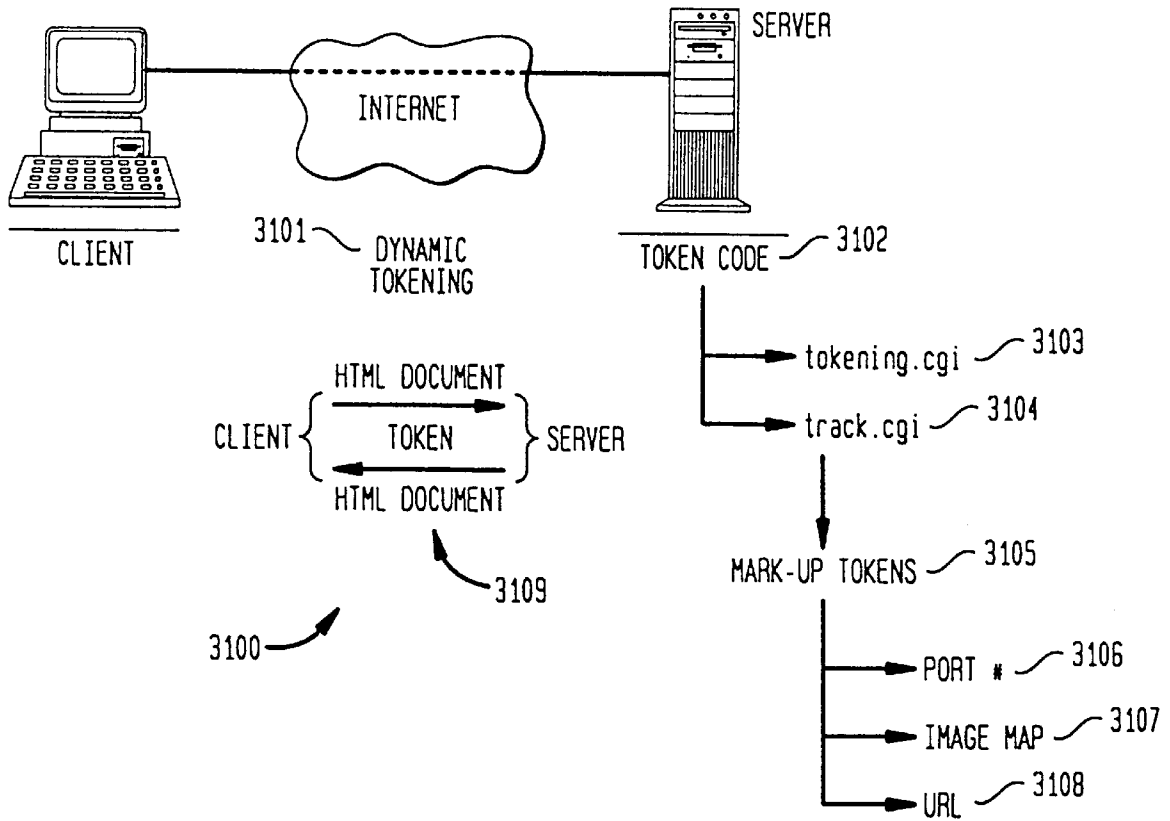

FIG. 32

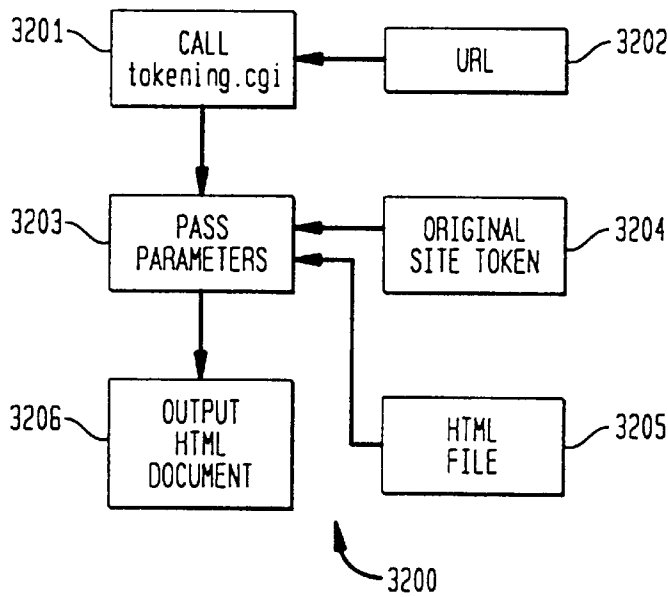

FIG. 33

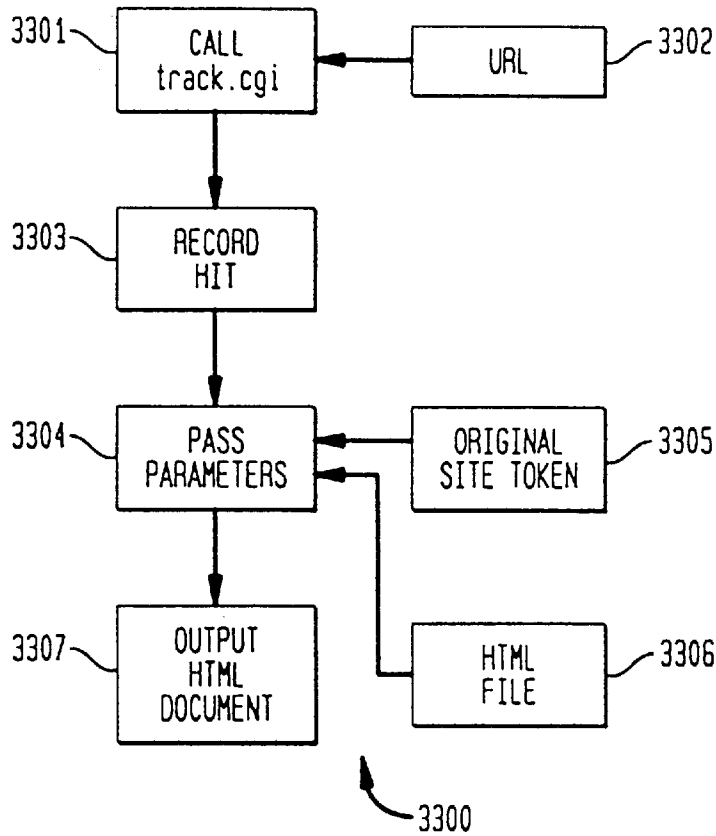
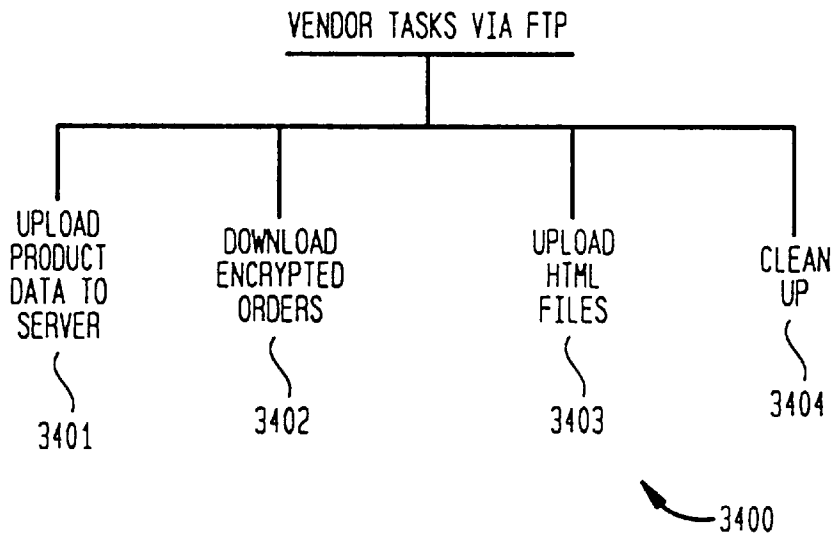

FIG. 34





**METHOD AND SYSTEM FOR  
CUSTOMIZING MARKETING SERVICES ON  
NETWORKS COMMUNICATING WITH  
HYPERTEXT TAGGING CONVENTIONS**

CLAIM FOR PRIORITY UNDER 35 U.S.C. 119  
(e)

Applicant hereby claims priority under 35 U.S.C. 119(e) for the present application based on a first provisional application, U.S. Ser. No. 60/017,229, filed Jan. 22, 1996, entitled METHOD FOR MARKETING AN INTERNET CONSUMER SERVICE AND AUTOMATICALLY TRACKING THE INTERNET SITE ENTRY, and a second provisional application, U.S. Ser. No. 60/010,372, filed May 22, 1996, entitled METHOD FOR CUSTOMIZING MARKETING SERVICES ON INTERNET SITES, both to the inventor William J. Tobin, Stamford, Conn.

**FIELD OF THE INVENTION**

The invention relates generally to computer based client/server communications, and more particularly, to dynamically customizing the content on server Web site pages in response to distinct classes of clients for hypertext tagging based communications on a network.

**BACKGROUND OF THE INVENTION**

The NET or Internet, as is commonly referred to, is basically a network of various types of computers, connected over telecommunication lines, communicating with each other through a protocol known as Transmission Control Protocol/Internet Protocol (TCP/IP) for the purpose of exchanging information. Being "connected to the Internet" can mean anything from sending a simple message to a colleague across the state, to logging into another computer halfway around the world to search and retrieve text, graphics, sounds and even movies. Accessing the Internet requires a computer which has TCP/IP communication capabilities and is physically connected to the Internet with an identifiable Internet address. Many Internet service providers, such as Prodigy, America On Line, and CompuServe, offer access to the Internet through their TCP/IP compatible UNIX computers already connected to the Internet. A subscriber to one of these service providers need only have a personal computer and modem to make a telecommunication connection to the service provider's UNIX computer.

Various information exchanges on the Internet are available through functions such as electronic message exchange (E-mail) and File Transfer Protocol (FTP or ftp.). Electronic mail is a service that allows two people to send messages to each other in a near real time manner. Messages can be sent to one address or multiple addresses. E-mail can also be used to retrieve documents from other computers on the Internet. FTP refers to moving files from one place to another on the Internet. The files may contain electronic documents, images, sounds, etc. Anything stored on the computer can be moved with FTP.

In recent years, a new mode of navigating through the Internet called the World Wide Web (WWW) has emerged which provides a hypertext interface to information on the Internet. The WWW uses the client-server model of computer interaction, with the server being a computer on the Internet providing information, and the client being a computer retrieving the information. The normal way to navigate through the Internet is by moving through directory trees of

information, whereby moving from node to node requires providing an address for each node. Likewise if the nodes are Internet sites, computers on the Internet, movement from one site to another requires providing an address for each site. In contrast, with the hypertext interface information can be stored and retrieved in a non-hierarchical structure. In essence, one can "jump" from one place of information on the Internet to another through a series of "hypertext links" created by someone. A hypertext link can literally allow one to simply select a word, using a mouse or key command, and immediately be transported to another document on the Internet halfway around the world.

In a hypertext interface all the technical aspects of moving from computer to computer are hidden, leaving the client free to explore without interference. Communication through the WWW function is by a HyperText Transport Protocol (HTTP) which uses a HyperText Markup Language (HTML). The HTML uses Uniform Resource Locators (URLs), which are a way of specifying the location of something on the Internet, to make the hypertext links. A standard form of URL address for accessing a particular word 26 marked by HTML, in a chapter called Web-chapter, in a book stored on a hard drive in a WWW server is: [http://dgf21.xpr.cs.wvu/book/Web-chapter.html#word 26](http://dgf21.xpr.cs.wvu/book/Web-chapter.html#word_26). The http connection at the beginning identifies this address to the Internet as a WWW server.

Access to the WWW requires a software tool typically referred to as a client or browser, which is installed on the computer used to access the Internet, or installed on an Internet service provider's computer on the Internet that offers access to the WWW browser. Browsers may be text based line browsers or, graphical based browsers such as Mosaic or Netscape.

The Internet is being increasingly used for commerce by companies, with Internet sites or services, providing opportunities to consumers to make purchases. In addition to automated secured transactions, commerce on the Internet requires development of software based marketing tools unique to the Internet structure. Typically, when a client's Web browser points to another Web server via a hypertext link, the URL address of the Web server will display the address of the transferee Internet site that the Web browser will jump to if the hypertext link transfer is executed. As a result, consumers may feel a reluctance to conduct transactions through a transferee Internet site they have not directly signed on with, have not had a long standing relationship with, or have not developed a comfort level with the transferee Internet site's label, brand and Web site content.

Accordingly, there is a need for customized marketing of consumer services through hypertext based communications wherein the content of the hypertext based communications is dynamically customized to take advantage of a consumer's existing familiarity with a specific Internet site marketing partner.

**SUMMARY OF THE INVENTION**

The present invention is a server based communications system operable in a network environment. The system employs a server software tool for presenting HTML tagged information which is customized according to a particular class to which a client, accessing the system, belongs to. The class of the client may be clients referred to the system by a particular network site. The system also includes a database responsive to the server which dynamically retrieves data stored on the system, in accordance with stored requirements which define the customization for the particular class

of clients, to provide customized content on HTML documents. Lastly, the system includes a processing subsystem for manipulating the server and database software tools in response to the HTML tagged requests from the client.

Preferably, the server based communications system the server software tool is a Netscape Commerce Server which responds to hypertext protocol and tagging conventions such as HTTP and HTML. Preferably, the database software operating in conjunction with the server software tool is a commercially available database tool, known as RDBMS, which is produced by Oracle software company. It is understood that other commercially available web server and database software tools may be employed as described herein within the scope and intent of the present invention.

In accordance with the present invention the sever based communications system is utilized to market consumer services, such as floral and gift services, via HTML documents presented to a client that has accessed the system by referral from another network site. The referral network site can be a partner participating with the host of the server based communications system or a participant seeking to utilize the server based communications to develop its own marketing position.

The system presents HTML documents which contain hypertext links, presented as single links or image maps, i.e., grouped links, which are anchored to data that is dynamically retrieved by the database means in response to the particular class to which the client belongs to, i.e., based on the identity of the network site referring the client to the system's server. Such a dynamic retrieval of data facilitates dynamic configuration of content on all anchored HTML documents so as to meet specific requirements of a marketing participant. Customization can be either a co-branded format, whereby content includes both the host's brand name and the participant's brand name, or a private label format, whereby only the marketing participant's brand name is displayed on the HTML documents presented to clients.

The present invention employs a dynamic tokening scheme whereby a token, indicative of the identity of the referring network site, is passed between successive HTML documents so as to track the necessary customization requirements for all HTML documents presented to the client. This dynamic tokening scheme relies on software executables including tokening.cgi and track.cgi, and markup tags such as PORT#, URL, and IMAGEMAP.

The server based communications system provides a participating vendor with the ability to supply the system with HTML documents wherein the vendor has access into the system for control over the HTML documents supplied by the vendor. Moreover, the vendor has the ability to transfer HTML documents pertaining to product data, and receiving from the system encrypted files containing orders.

The server based communications system can be operated in an Internet environment or an Intranet environment where hypertext protocol and tagging conventions are utilized for communications between a client and server. The Intranet environment can be localized to an America Online group of clients designated as Digital City, or a geographic area, or a corporate grouping of employees. In either type of locality, the system can customize the content on HTML documents presented in the intranet environment in accordance with the specific requirements of the localized Intranet group.

#### BRIEF DESCRIPTION OF THE DRAWINGS

The invention will be better understood with reference to the following illustrative and non-limiting drawings, wherein like graphic elements or features are like numbered, in which:

FIG. 1A is a schematic of a typical communications network including single client stations, a local area network (LAN) of client stations and servers interconnected across the Internet.

FIG. 1B is tabular display of typical hardware elements for a client and a server, and respective software elements which configure the hardware elements.

FIG. 1C is a PC Flowers & Gifts home page Web site providing internet consumers a variety of floral and gift purchasing opportunities through hyper graphic or text based links.

FIG. 2 is a PC Flowers & Gifts Web site page, shop by occasion, accessible via a hypertext link from the home page Web site depicted in FIG. 1.

FIG. 3 is a PC Flowers & Gifts Web site page, birthday gifts, accessible via a hypertext link from the Web site page depicted in FIG. 2.

FIG. 4 is a PC Flowers & Gifts Web site page, shop by category, accessible via a hypertext link from the home page Web site depicted in FIG. 1.

FIG. 5 is a PC Flowers & Gifts Web site page, balloons, accessible via a hypertext link from the Web site page depicted in FIG. 4.

FIG. 6 is a PC Flowers & Gifts Web site page, link, lists, and laughs, accessible via a hypertext link from the home page Web site depicted in FIG. 1.

FIG. 7 is a PC Flowers & Gifts Web site page, how it works, accessible via a hypertext link from the home page Web site depicted in FIG. 1.

FIG. 8 is a PC Flowers & Gifts Web site page, e-mail holiday reminder, accessible via a hypertext link from the Web site page depicted in FIG. 7.

FIG. 9 is a PC Flowers & Gifts Web site page, item information, accessible via a hypertext link from the home page depicted in FIG. 1 or the Web site page depicted in FIG. 3.

FIG. 10 is a PC Flowers & Gifts Web site page, order form, accessible via a hypertext link from the Web site page depicted in FIG. 9.

FIG. 11A is a Web site page of a marketing co-partner, Pathfinder.

FIG. 11B is a Pathfinder Web site page which is accessible via a hypertext link from the Web site page depicted in FIG. 11A.

FIGS. 11C, 12-18, 19A-19B, and 20 show co-branded Web site pages that correlate to the PC Flowers & Gifts Web site pages depicted in FIGS. 1C-10 which are customized with both the PC Flowers & Gifts and Pathfinder brands.

FIG. 21A is a Web site page of a marketing partner, Homearts.

FIG. 21B is a Homearts Web site page which is accessible via a hypertext link from the Web site page depicted in FIG. 21A.

FIGS. 21C, 22-28, 29A-29B, and 30 show private label Web site pages that correlate to the PC Flowers & Gifts Web site pages depicted in FIGS. 1C-10 which are customized solely with the Homearts brand.

FIG. 31 is a schematic highlighting key dynamic tokening features in accordance with the present invention.

FIG. 32 is a block diagram of the principal process features of the executable tokening.cgi.

FIG. 33 is a block diagram of the principal process features of the executable track.cgi.

FIG. 34 illustrates vendor tasks.

## DETAILED DESCRIPTION OF THE INVENTION

Although the present invention can be used in many applications which can utilize customization marketing tools unique to client/server communications across variety of communication network structures, the present invention is described in its application to PC Flowers & Gifts, an Internet site providing floral and gift services through Web site pages which are dynamically customized to the requirements of other Internet sites referring clients, i.e., consumers, to the PC Flowers & Gifts Web site pages. Accordingly, the present invention will be described in its application to the PC Flowers & Gifts Internet based marketing program whereby participating Internet Service providers or Web sites display PC Flowers & Gifts Web site pages customized to the requirements of the participating Internet Service provider or Web site.

The PC Flowers & Gifts marketing program comprising the floral and gift Web site pages are dynamically customized in accordance with the participating Internet site's requirements which may be co-branded, private label or, a program of labeling unique to the participating Web site. More specifically, the PC Flowers & Gifts Web site pages are customized in both a graphic and a content format to take advantage of the consumers familiarity with the participating Internet site's position in the marketplace, the consumer's trust in the participating Internet site's established brand name, or the consumer's existing relationship with the participating Web site.

Marketing on the Internet presents problems as to how to customize the participating Web sites marketing services to take advantage of an established market presence on the Internet. Typically, when browsing on a Web site which is pointing to a Web server, the URL of the Web server appears, rather than the URL of the pointing Web site, which clearly indicates that the consumer will be dealing with a different Internet site, possibly an Internet site the consumer is unfamiliar with. Moreover, a method is needed whereby the identity of an Internet site participating in the marketing program or, an Internet site referring a client or user to the PC Flowers & Gifts Web site, is tracked. The automatic tracking of the participating or referring Internet sites is crucial to transparently customizing Web site pages to take advantage of brand name recognition and customer loyalty.

To resolve the problem of dynamic customization of Internet sites participating in the PC Flowers & Gifts program of marketing services, PC Flowers & Gifts has completely redesigned its Web site pages to be extremely user friendly and its hypertext links to be configured in a database format. The database format of hypertext links enables development of "private label" and "co-branded" floral and gift services that can be customized for many of the major Web sites on the Internet and online services. For, example, if a consumer were to visit one of the private label floral and gift services home page of the Internet site "Homearts", all the graphics and product categories on each of the PC Flowers & Gifts Web site pages, available through a hypertext link from a Homearts Web site, are fully customized in graphic and content format to reflect only the Homearts brand name. As another example, all the graphics and product categories on each of the PC Flowers & Gifts Web site pages, available through a hypertext link from a Pathfinder Web site, are partially customized in graphic and content format to reflect both the PC Flowers & Gifts and Pathfinder brand names. This unique database format of server files accessed through the hypertext links permits a

participating Internet site to host floral and gift services so as to take advantage of the consumer's familiarity with the participating Internet site.

The advantages of a floral and gift service customized to the various participating Web sites and online services are among the following: building the brand name and identity of participant's own floral and gift service; taking advantage of the event driven nature of the floral and gift business on a monthly basis to promote the participant's own site and to generate traffic; and, utilizing the content of the PC Flowers & Gifts floral and gift service to the participant's own marketing advantages. In addition, the participating Web sites and online services can utilize the unique capabilities of the PC Flowers & Gifts service such as the e-mail gift reminder service, which is part of the content of the PC Flowers & Gifts service, in order to develop a close relationship with their consumers and gain permission to enter the consumers mailbox in order to place reminders of various upcoming gift events.

Referring now to FIG. 1A there is shown a schematic of a typical communications network 10 including single client stations 13 and 18, a local area network (LAN) 12 of client stations 15, 16 and 17, and servers 19, 20, and 21 interconnected across the Internet 11. A client station may directly transfer into a server or be pointed to one server by another sever. More specifically, assuming for the sake of explanation that server 21 is the PC Flowers & Gifts Web server, the clients may directly transfer across the Internet 11 and communicate with the Web server 21, or the clients may initially transfer across the Internet 11 and communicate with server 18 or 19 which provide a hypertext link to server 21. It is noted that via the hypertext links on server 18 or 19, the client attains the IP address to server 21 and the Web site location on the Web server residing in server 21.

Referring now to FIG. 1B, there is shown a tabular display of typical hardware elements for a client and a server, and respective software elements which configure the hardware elements for operation in accordance with the present invention. A typical client platform includes hardware such as a central processing unit (CPU), e.g. a Pentium microprocessor, RAM, ROM, hard drive storage, modem, and optional removable storage devices such as a floppy drive or a CD ROM drive. The client hardware is configured by software including an operating system, e.g. Windows 95 or NT, and an Internet browser such as Netscape's "Navigator" or Microsoft's "Internet Explorer". A typical server platform includes hardware such as a CPU, e.g. Pentium microprocessor, RAM, ROM, hard drive, modem, and optional removable storage devices, e.g., floppy or CD ROM drive. The server hardware is configured by software including an operating system, e.g. Windows 95 or NT, Web server software, e.g., Netscape Commerce Server, and database software, e.g. Oracle RDBMS.

### Non Customized Web Site Pages

Referring now to FIG. 1C there is shown a PC Flowers & Gifts home page Web site page 100 providing Internet consumers a variety of floral and gift purchasing opportunities through graphic based hypertext links. It is noted that the references to Web site page(s) and HTML document are used interchangeably in the art and herein. The graphic link 102 provides a jump to a Web site page detailing gift suggestions while links 103 to 106 provide jumps to Web site pages detailing specific gift offerings. Essentially, these links 103 to 106 are anchored to database server files which are called up by the server to form Web site pages that are customized to the requirements of any participating Internet site. Link 107 provides a jump to a Web site page disclosing

a pledge of quality of service and, the footer **118** includes link hypertext link **113**, a copyright notice, hypertext link **114**, a “Talk To PC Flowers” link, and hypertext link **115**, an inquiry link. The flower link **117** is a link to a “shop by occasion” Web site page which is also is accessible through link **109**. It is noted that the header **116** is solely a PC Flowers & Gifts label which indicates that the client has accessed the Web site page **100** without any hypertext links through a participating Web site requiring “private label” or “co-branded” customizing, more fully discussed with respect to FIGS. **11C–20** and **21C–30**.

A key feature of the present invention involves the image map **101** which is a grouping of hypertext links **108–112**. Hypertext links **108–112** provide jumps to Web site pages indicated, respectively, as “shop by occasion”, “shop by category”, “links, lists and laughs”, “how it works”, and “greeting cards”. Essentially the hypertext links contain anchors to web site pages which are created from combinations of server files. For customizing web site pages which the hypertext links are anchored to, in accordance with the present invention, a database process is used to access different combinations of files for configuring the customized content on the web site pages the client or user eventually sees when a hypertext link is executed. The image map **101** entails two components, the client’s xy coordinate pointer position and the matching of server database files as discussed above. The server calls out appropriate database files to configure the eventual web site page displayed, such as web site page **200**. The database files called out depends on variables such as a particular vendor, date, particular occasion, etc.

Referring now to FIG. **2** there is shown a PC Flowers & Gifts Web site page **200**, denoted as “shop by occasion”, accessible via the hypertext link **108** from the home page Web site **100** depicted in FIG. **1**. The Web site page **200** contains an occasion map **201** which includes hypertext links **202** through **213** which provide jumps to Web site pages indicated, respectively, as “birthday”, “anniversary”, “wedding”, “get well”, “baby”, “romantic/love”, “thank you”, “congratulations”, “thinking of you”, “sympathy”, “business”, and “international”. For the occasion map **201**, like the home page image map **101**, a database process is used to dynamically select the files used to configure a Web site page that a particular hypertext link points to. Also on the Web site page **200** is a sun flower **214** which is a hypertext link to the home page **100**.

Referring now to FIG. **3** there is shown a PC Flowers & Gifts Web site page **300**, denoted as “birthday gifts”, accessible via a hypertext link **202** from the Web site page **200** depicted in FIG. **2**. Various Web site pages providing information on purchasing options are available through hypertext links **301–303**, and **307**. Specific Web site pages with ordering information are available through hypertext links **304–306**.

Referring now to FIG. **4** there is shown a PC Flowers & Gifts Web site page **400**, denoted as “shop by category”, accessible via a hypertext link **109** from the home page Web site **100** depicted in FIG. **1**. The distinguishing content on this Web site page **400** is that the category image map **401** includes hypertext links **402–408** which provide jumps to Web site pages indicated, respectively, as “flowers”, “plants”, “balloons”, “Hickory Farms gourmet foods”, “bears by Russ”, and “greeting cards on-line”. As noted for the discussion pertaining to the home page image map **101**, the category image map **401** includes hypertext links which point to Web site pages that are dynamically created as needed by a database process.

Referring now to FIG. **5**, there is shown a PC Flowers & Gifts Web site page **500**, denoted as “balloons”, accessible via a hypertext link **404** from the Web site page **400** depicted in FIG. **4**. Web site pages detailing some suggested occasions for purchasing varieties are available through hypertext link groupings **501** through **503**. Hypertext links **504** through **506** provide jumps to Web site pages providing a more detailed view of product options and associated ordering information.

Referring now to FIG. **6**, there is shown a PC Flowers & Gifts Web site page **600**, denoted as “link, lists, and laughs”, accessible via a hypertext link **110** from the home page Web site depicted in FIG. **1**. The distinguishing content on this Web site page **600** is that the links, lists, and laughs map **601**, which includes hypertext links **602–608**, provide jumps to Web site pages indicated, respectively, as “holiday information”, “the language of flowers”, “anniversary etiquette”, “birthday flowers & birthstones”, “all about roses”, “all about plants & flowers”, and s “Web sites to visit”. As noted for the discussion pertaining to the home page image map **101**, the hypertext “links of the lists and laughs” image map **601** point to web site pages which are dynamically created by a database process retrieving appropriate server files.

Referring now to FIG. **7**, there is shown a PC Flowers & Gifts Web site page **700**, how it works, accessible via a hypertext link **111** from the home page Web site page **100** depicted in FIG. **1**. The distinguishing content on this Web site page **700** is the “how it works” image map **701** which includes hypertext links **702–708** which provide jumps to Web site pages indicated, respectively, as “about PC Flowers”, “supplier information”, “delivery information”, “satisfaction guaranteed”, and “e-mail gift reminders”. As noted for the discussion pertaining to the home page image map **101**, the hypertext links of the “how it works” image map **701** point to web site pages that are dynamically created. The Web site page **700** also contains a hypertext link **707** to a Web site page offering Thanksgiving specials and a grouping of hypertext links **708** providing jumps to the same Web site pages as the home image map **101**.

Referring now to FIG. **8** there is shown a PC Flowers & Gifts Web site page **800**, denoted as an e-mail holiday reminder, accessible via a hypertext link **706** from the Web site page depicted in FIG. **7**. The Web site page **800** affords potential clients, i.e., Web browser users, an opportunity to provide their e-mail address and request that a gift reminder be sent to that e-mail address prior to one of many holidays or a custom event such as an anniversary, birthday, or special event **801**. The e-mail holiday marketing program **801** is unique in that clients provide personal information, i.e., email addresses, and allow the server to automatically direct marketing based content to the personal e-mail address provided by the client or user.

Referring now to FIG. **9**, there is shown a PC Flowers & Gifts Web site page **900**, denoted as item information, accessible via a hypertext link **111** on the home page depicted in FIG. **1** or the hypertext link **305** on the Web site page depicted in FIG. **3**. A client is afforded an opportunity to view the product, herein a dozen long stem roses, and ordering options **901**, without a vase, and **902**, with a crystal vase. Executing a jump under one of the hypertext links **901** or **902** leads the client to Web site page **1001**, denoted as order form and shown in FIG. **10**. The Web server tracks the particular product being ordered by the particular hypertext link **901** or **902** that the client jumps from onto the order form Web site page **1001**. It is noted that encryption is employed respecting transmission of sensitive information

transmitted across the Internet. The details of the encryption and exchange of ordering information with vendors offering goods and services is further discussed in greater detail herein below.

#### Co-Branded Customization

Referring now to FIG. 11A there is shown a Web site page 11A0 of a marketing co-partner, Pathfinder. A hypertext link 11A1 provides a jump to a Web site page 11B0, shown in FIG. 11B, which provides shopping opportunities to the client. The Web site page 11B0 contains hypertext links, 11B2, 11B3, and 11B4, which provide jumps to Web site pages, related to the PC Flowers and Gifts marketing program for floral and gift services, which are co-branded with the participating Web site partner, in this instance Pathfinder.

FIGS. 11C–20 show co-branded Web site pages that correlate to the PC Flowers & Gifts Web site pages depicted in FIGS. 1C–10. The Web site pages of FIGS. 11C–20 are customized with both the PC Flowers & Gifts and the marketing partners brand, Pathfinder. Referring to the Web site page 1100, shown in FIG. 11C, the header 1116 is a modified version of header 116 with the additional pathfinder label 1116'. In addition, the client's familiarity with the marketing partner's brand is reinforced through the retention of the marketing partner's navigational features via the hypertext link grouping 1102. The modified header 1116 with the pathfinder co-brand 1116' is shown on Web site pages 1200, 1300, 1400, 1500, 1600, 1700, 1800, 1900 and 2000. In addition, the navigational features 1102 of the marketing partner is utilized on Web site pages 1800 and 1900.

Still referring to FIG. 11C, like the home page image map 101 discussed above, the home page image map 1101 herein is a grouping of the hypertext links 108–112, which point to Web site pages that are dynamically created to reflect preferences of the marketing partner, which in this instance is Pathfinder. Accordingly, all the server Web site pages accessed through the home page image map 1101 lead to PC Flowers & Gifts Web site pages that have been customized with graphic, text, or navigational features according to Pathfinder's preferences. For example, the header 1116 is customized to include the Pathfinder brand 1116', and the navigational features 1102 of the Pathfinder Internet site are retained. Such a co-branding of Web site pages takes advantage of the client's existing relationship and familiarity with the marketing partner, Pathfinder. In addition, the hypertext link grouping 1103 retains the links 102–107 of the PC Flowers & Gifts Web site pages, however, like the home page image map 1101, the hypertext link grouping 1103 provides jumps to PC Flowers and Web site pages that are dynamically created to be co-branded with the Pathfinder name brand.

#### Private Label Customization

Referring to FIG. 21A there is shown a Web site page 21A0 of a marketing partner, Homearts, which prefers a "private label" customization of the PC Flowers & Gifts Web site pages depicted in FIGS. 1C–10. The Web site page 21A0 includes a hypertext link 21A1 to a Homearts' Web site page 21B1 shown in FIG. 21B, which offers marketing services to clients. The hypertext link 21B1 provides a jump to the PC Flowers & Gifts Web site pages depicted in FIGS. 1C–10, but which have been customized in accordance with the marketing partner's private label requirements.

FIGS. 21C–30 show private label Web site pages that correlate to the PC Flowers & Gifts Web site pages depicted in FIGS. 1C–10. However, the Web site pages of FIGS. 21C–30 are customized with only the marketing partner's brand, Pathfinder. Referring to the Web site page 2100,

shown in FIG. 21C, the client's familiarity with the marketing partner's brand is reinforced through the use of a fully customized header 2116, "Homearts Flowers & Gifts", and a fully customized footer 2117, "Homearts". The fully customized header 1116 and footer 2117 are also used on Web site pages 2200, 2300, 2400, 2500, 2600, 2700, 2800, 2900 and 3000.

Still referring to FIG. 21C, like the home page image map 101 discussed above, the home page image map 2101 herein is a grouping of the hypertext links 108–112, wherein the sever files for the linked Web site pages are dynamically created to reflect preferences of the marketing partner, which in this instance is a private label customizing for Homearts. Accordingly, all the server Web site pages accessed through the home page image map 2101 are anchored to PC Flowers & Gifts Web site pages that are dynamically created with fully customized graphic and text features according to Homearts' preferences. Such a private label customization of the Web site pages takes advantage of the client's existing relationship and familiarity with the marketing partner, Homearts. In addition, the hypertext link grouping 2103 retains the links 102–107 of the PC Flowers & Gifts Web site pages, however, like the home page image map 2101, the hypertext link grouping 2103 provides jumps to PC Flowers and Web site pages that are fully customized with the private label Homearts.

#### Dynamic Tokening

Referring now to FIG. 31, there is shown a schematic 3100 graphically illustrating a dynamic tokening structure that configures the server platform in accordance with the present invention. It is noted that the present invention technique of dynamically customizing Web site pages employs, among other techniques, dynamic tokening wherein HTML files, i.e., Web site pages, contain special markup tags or tokens. Note that the reference to HTML document is synonymous with the reference to Web site page(s) referred to elsewhere herein. An HTML document is a document which contains HTML coding that provides the hypertext jump capabilities to other HTML documents. When an HTML based document is accessed, an executable is actually called with this HTML document as a parameter. Instead of directly outputting the document, the executable instead reads in the document and scans for special mark-up tags (tokens). Non-token text is simply output to the client, i.e., user. Tokens, however, are dynamically substituted for. This allows information such as where the user's request (i.e., what WWW site) originated from to be passed along as the user navigates through the site.

The idea behind the tokening system is to track the location of the source of orders placed. For example, if Web site A, i.e., a client, agrees to link to Web site B, i.e., a server based Web site, which is selling products on the Web, then the following is possible: Web site B can track the number of orders placed by customers through this link. Web site A can then be paid on a percentage basis of sales generated by this link.

To implement dynamic tokening, every HTML page is read in by the server and output back to the user 3109. As the pages are output, the site 'token' can be appended as a parameter to all of the links. When these modified links are then selected by the user, the page being referenced is read in by the system and output back to the user. Once again, the 'token', which was passed to the original link as a parameter, is appended to all links of this newly referenced page.

Each hypertext link is a call to an executable which performs the function of reading in the page and outputting it back to the user with tokening information passed as

parameters. This executable also takes the file name of the page being referenced as a parameter so the executable knows which file to read in, modify, and output. The tokening code **3102** includes the following executables or programs: tokening.cgi **3103**, and track.cgi **3104**, as shown in the block schematic **3100** of FIG. **31**. The software token code and mark up tokens **3105** preferably reside on the server platform which the client is communicating with.

Referring now to FIG. **32** there is shown a block diagram **3200** of the key process features of the executable tokening.cgi. Upon a call via a hypertext link **3201**, the executable tokening.cgi dynamically outputs an HTML page **3206**, substituting in information on the original source (the site token) of the system access for special mark-up tokens in the HTML. Note that a call to the tokening.cgi appears in the browser's display of the URL. The tokening.cgi process enables the site token information to be passed from page to page **3206** and to be recorded when an order is eventually placed. Both the source of the access (the site token) **3204** and the HTML file **3205** to be output are passed to "tokening.cgi" as parameters **3203**. In HTML, an action field or link calling the tokening executable would appear as: "tokening?site\_token&file\_name" where "site\_token" is a string identifier corresponding to a Web site and "file\_name" is the HTML file being accessed. For example, referring to FIG. **2**, the URL **2'** address contains a similar field "tokening.cgi?80&/occasion.htm".

Referring now to FIG. **33** there is shown a block diagram **3300** of the key process features of the executable track.cgi. Under the executable track.cgi, a hit or Web site entry is recorded **3303** in the global database for the given site token, the current date, and the vendor of the home page being accessed. The code then dynamically outputs the home page, substituting in the original source (the site token) of the system access for special mark-up tokens in the HTML (as is similarly done in the tokening executable). Both the source of the access (the site token) **3305** and the HTML file **3306** to be output are passed to "track.cgi" as parameters **3304**. The tracking program is preferably called **3301** as an URL **3302** to enter the PC Flowers and Gifts system from other Web sites. The program "track.cgi" records a hit and then dynamically outputs the HTML page **3307** which is referenced by the second parameter to the executable. A call **3301** to the program would appear as: "track.cgi?site\_token&file\_name" where "site\_token" is a string identifier corresponding to a Web site and "file\_name" is the HTML file being output. For example, referring to FIG. **1C**, the URL **1'** contains such a field "track.cgi?90&/homehtm".

#### Mark-Up Tokens

Rather than have the user repetitively enter in the tokening executable name and to also to keep the tokening mechanism as transparent as possible, a special "HTML extension" mark-up tag is defined. This mark-up token **3105** appears in links of the static HTML files. This tag is searched for by the tokening executable and, when found, is substituted in with a call to itself (the tokening executable) with the same site token passed along as a parameter. To accommodate the functionality of the above dynamic tokening, the present invention utilizes, among others, mark-up tokens **3105**: Port# **3106** and, IMAGEMAP **3107** and URL **3108**.

The PORT# **3106** mark-up tag or token is defined as an HTML extension and is embedded within the HTML pages that the server accesses. The PORT# token **3106** is the original token defined to perform the task of dynamically passing site information from HTML page to page, i.e., Web site page to Web site page such as from FIG. **1C** to FIG. **2**. This token **3106** will therefore appear most often in the site's

HTML pages. This token should appear as follows in all links to the site's HTML pages, other than order forms, image maps, and form action fields. Order forms, image maps, and form action fields are handled separately with other tokens. Also note that references to graphics should \*not\* contain this token since graphics do not directly contain links and graphic files are in binary and not text. Regular links (see above) will appear as:

```
<a href="~PORT#~html_page_path_name"></a,
```

where the "html\_page\_path\_name" is specified from the document root. The system will dynamically append the document root's path name if needed. It is noted that the token PORT# **3106** appears immediately before the path name with no white space or other characters in between the two, and that quotation marks surround the token/path name. For example, the PORT# **80** is carried through in URLs **1'-10'** of FIGS. **1C** through **10**, respectively.

As one can ascertain an implementation of the system is divided into two main portions, designated as the product selection area and the checkout area.

#### Product Selection Area

The product selection area must support several design goals:

- It must easily reflect changes in product descriptions;
- It must accommodate changes to prices and shipping methods.

There are principally two approaches to creating such a web site. The first method involves creating individual web pages with hypertext pointers to the Check-Out area with product selection encoded. The second method involves the use of a database and a program to create the individual web pages dynamically. This method is currently substantially slower, and in a highly successful web site would cause unacceptable performance. In practice, the product descriptions, prices, images, and shipping information change infrequently and can be scheduled to occur at off-peak hours. The PCFlowers site takes an innovative approach to the problem.

In addition, each Product Selection area has 4 key components:

- Private label home page;
- Private label collection selector page;
- Private label collection page;
- Private label product detail page.

#### Private Label Home Page

Each private label web site has on each page a custom icon that hyperlinks back to the private label partner's web site, a navigation bar that hyperlinks to areas within the private label partner's web site and maintains the look and feel of the partner's web site.

#### Private Label Collection Selector Page

The private label collection selector page is an aggregation of hyperlinks to the private label collection pages. The hyperlinks are accessed through a graphical client-side image map. In order to support the preferences of the vendors and private label partners, the graphic and map coordinates are automatically generated. In this manner, if a partner does not wish to offer products from a particular vendor, the appropriate values are set in the partner database.

#### Private Label Collection Page

By designing a web site generator based on an Abstract Syntax Notation (ASN) that mimics an object-oriented database, the sites' Product Selection Areas can be generated as web pages, while retaining the individual character of each site. The ASN analyzes the creation date of each constituent element of the web page, analyzes the depen-

dencies that exist in creating the resulting web page, and determine if the page needs to be updated. If so, the ASN parser applies the object-oriented method appropriate to that object, and creates the resulting web page element. The elements are assembled into a final web page.

Private Label Product Detail Page

The design of the product detail page employs an object-oriented method related to the private label collection page. Check Out

The check-out area of the site has the following components:

- Order page;
- Order error page;
- Order confirmation page.

Order Page

The order is arrived at from any one of the product detail pages. The site ID, product ID, and any product options are encoded in the hypertext access. The order page prompts the user for sender, recipient, personalization, and payment information. In addition, if any custom offerings are currently in place for this partner site, they are presented at this time. Customizations occur in two ways. First, the user interface may be modified to capture additional customer information such as a coupon number. Each partner can have a separate mechanism for validating coupon numbers, that is invoked at the time the order page is generated. The second customization area is not seen directly by the user, but manifests in pricing incentives, discounts by percentage or fixed dollar amount. When the order page is filled, the custom discount pricing is transmitted to the order confirmation page. The page maintains the look and feel conventions of the partner site by accessing the site ID information encoded in the access. Upon completing the form, the user submits the information, and is transported to either the order confirmation page or the order error page, in the event of missing or improperly formatted data.

Order Error Page

The order error page is generated in the event of missing or malformed data. In this event, the user is offered input areas to correct the missing elements, along with a textual description and explanation of the missing information. The look and feel of the private label partner is maintained on the order error page.

Order Confirmation Page

The order confirmation page is generated upon successful completion of the Order Page or Order Error Page. The user has displayed a summary of the transaction. At this time, the system also generates an e-mail version of the confirmation information.

Image Map Dynamics

Referring back to FIG. 1C, it is noted that the image map **101** is a grouping of hypertext links **108–112**, that provide jumps to Web site pages indicated, respectively, as “shop by occasion”, “shop by category”, “links, lists and laughs”, “how it works”, and “greeting cards”. This grouping of hypertext links **108–112** is an image mapping of server files which are created dynamically at the time the client or user jumps onto the home page **100**. Configuration of the image map **101** entails two components, the clients xy coordinate pointer position and the matching of server database files. The server calls out database map files based on variables such as a particular vendor, date, particular occasion, etc.

Respecting the IMAGEMAP **3107** and URL **3108** mark up tokens, the dynamic tokening scheme necessitates special handling of image maps, such as **101**, **1101**, etc., since image maps contain anchors to other pages. The implementation of image maps makes use of the PORT# **3106** token as well as

the tokens: URL **3108** and IMAGEMAP **3107**. The URL token **3108** appears in a map template file while the IMAGEMAP token **3107** appears in the anchor for the image map. The assumption is that image maps are handled in a manner similar to the Netscape Commerce Server’s handling. Specifically, Netscape servers reference image maps with the following line: a href=“image map path name”> <img src=“graphic path name” ISMAP></a>. This differs from NCSA base servers where an actual entry in the image map configuration file must exist for each image map.

Dynamic image maps, such as **101** or **1101**, work in a similar manner to the other tokening mechanisms except for the handling of the map files themselves. The reference (i.e. the anchor) to the image map should appear as: <a href=“IMAGEMAP”> <img src=“graphic path name” ISMAP></a>. This line is essentially the same as an image map reference without the dynamic tokening system. The only difference is that instead of a path name of the image map file, the token IMAGEMAP appears (inside of quotation marks).

In the same directory as the file with the above image map file reference, there must be a file name of the same name but with the file extension “.map”. For instance, if there is an image map reference in the file “XXX.htm”, then in the same directory there must be a file “XXX.map. This file is a generalized version of a standard image map file. In each line of this image map file, the URL should be replaced with the URL token **3108** immediately followed by the HTML file that should be displayed. The HTML file should be specified from the document root, i.e., do not include the “/document\_root” portion of the full path name. Static image map files are created from this template file for each token as they are encountered. For example, the following lines illustrate a “.map” file.

```
default~URL~/error.htm
poly~URL~/vendor03/index01.htm 127,3 193,3 217,51
193,101 127,101 102,51
poly~URL~/vendor05/index03.htm 223,54 208,54 313,
103 288,151 223,151
poly~URL~/vendor03/index02.htm 31,56 96,56 120,104
95,151 31,151 6,104
poly~URL~/vendor04/index04.htm 31,158 96,158 119,
206 95,255 31,255 6,206
poly~URL~/vendor04/giftbskt.htm 225,156 293,156 319,
207 293,259 225,259
poly~URL~/vendor02/home.htm 127,208 192,208 217,
258 192,306 127,306
poly~URL~/vendor03/special.htm 126,106 194,104 221,
154 193,204 124,204
```

When a file “XXX.htm” with an image map link is referenced from “port” YYY and the IMAGEMAP token is encountered, then the following occurs: The system looks in the same directory as the file “XXX.htm” and searches for a file named “YYYXXX.map”. If the file already exists, then it is used as the image map file. If the file does not exist, then the system searches the same directory that the file “XXX.htm” appears in for a file named “XXX.map”. If this file is not present, the system returns an error. Otherwise, the system generates a file named “YYYXXX.map” from the template file and this file is then used as the map file for the access (and all subsequent accesses from port YYY). The reason that the image map files are created dynamically is that the number and names of ports (i.e. site tokens) are not known ahead of time. With this scheme, hard-coded additions do not need to be made every time a port token is added.

Since an image map must have a corresponding “.map” file with the same name and in the same directory as the file



the image map reference appears in, this scheme allows only one image map per file. In addition a Netscape server (or a server which handles image maps in a similar manner to a Netscape server) must be used. For the NCSA server, for example, each image map must have an entry in an image map configuration file as well as an image map file. These entries can not be created dynamically easily since the file can only be edited as 'root' and since the daemon would have to be stopped and restarted (as 'root').

#### Vendor Participation

Regarding vendor related functions, the overall server set-up is configured in such a manner that the individual vendors have near complete control over their HTML pages and the pulling of their orders (as long as system conventions are adhered to). Despite this control, the system also has standardized, centralized order processing, gift reminders, and system HTML pages. The vendor control, as well as system protection from inadvertent or malicious vendor actions, is provided by individual databases for each vendor as well as restricted accounts and access to directories for each vendor.

A vendor is given a number between 02 and 99. This number identifies the vendor throughout the system and is included in the naming of the vendor database, the vendor FTP and Netscape id's, and the location of vendor files off of the document root to name a few things. For instance, vendor 02 has a database named "vdb02", login id's "guest02", and HTML files located at "/document\_root/vendor02". See FIG. 5 where the URL 5' string displays ". . . /vendor03/ . . .", which indicates that the vendor's number is 03.

In addition, order numbers are pre-pended with vendor number. So, order number '12' for vendor 02 is referred to as order number '0212' outside of the system. Note that internally though, the order number is stored only as order number '12'. This is due to the fact that the vendor number is implicit in the vendor database in which the order resides. For this example, order number '12' would be stored in database "vdb02". The vendor number '00' is sometimes used as a default for the global database 'globaldb' (e.g. hits and gift reminders) and therefore can not be used for a vendor. The vendor number '01' is reserved for the plants and roses FAQ section. These vendor database files are automatically generated and uploaded to the server via the 'guest01' account.

Vendor's can access the server via FTP and a browser interface. Each vendor has an FTP only account with the id: "guestXX" where XX is the vendor number. The home directory is: /document\_root/vendorXX/vendorXX. As shown by the schematic 3400 of FIG. 34, vendors FTP to the server to perform the following tasks: 1) Upload "prod.dat" file 3401. The "prod.dat" needs to be the vendor's home directory so that the preprocessor code can locate it. The preprocessor will also place the corresponding "prod.imp" and "prod.log" files which it generates in the vendor's home directory; 2) Download encrypted files containing orders 3402. When a vendor pulls orders from his database, the orders are placed in an encrypted file in the vendor's home directory; 3) Upload HTML files 3403. The vendor's HTML files should reside in the directory "/document\_root/vendorXX" (one directory up from the vendor's home directory). Sub-directories from this directory may exist but they obviously must be specified in all of the paths found in the actual HTML; and 4) Clean-up 3404 (removing old order files or old HTML files).

When orders are pulled from a database by a vendor, they are placed in a file and the file is encrypted. This encryption

of order files is mainly intended to protect credit card numbers from being obtained as the order batch files are transferred across the Internet. Credit card numbers do sit unencrypted in the database. Protection of these numbers is achieved through the use of db2 access permissions as well as restricted FTP and telnet access to the server itself.

#### Encryption

A commercially available encryption software, Via-Crypt's PGP software, is used to do this public encryption in the following manner: (1) Vendor's are typically create their own public/private key pair and to send the public key to ISSC via means they see appropriate. (2) A military grade key pair is preferred (1024 bit key); ISSC creates its own public/private key pair to be used as the "system administrator's" key, preferably a military grade key pair is selected (1024 bit key). It is noted that for vendors, only the public key resides on the server, whereas for ISSC the private key sits on the server but the pass phrase does not. ISSC also stores its private key on a local development server and the vendors store their keys locally on their PC's. (3) ISSC signs the vendor keys when they are received, in this way the id cannot be changed maliciously in the future by someone who shouldn't be editing the key. 4) When orders are pulled from the database by the cgi programs run by the vendors, the orders are placed in a file and encrypted with both the vendor's public key and the system administrator's key. The latter key is used so that the encrypted data can be recovered by ISSC if a vendor does something fatal (like forgetting his pass phrase!). 5) Orders are encrypted with the wipe option (-w) so that the data file is written over with random data and then deleted. 6) Digital signatures are not used.

#### ALTERNATIVE EMBODIMENTS

It should be noted that application of the key features of the present invention disclosed herein may be practiced with client/server based communications across "Intranets". In simple terms, Intranet is a descriptive term being used for the implementation of Internet technologies within a locally defined group of clients or users, rather than for the external connection to the global Internet. The main technology components of the Internet are:—communications protocol, i.e., TCP/IP, providing the ability to connect and communicate between networks and individual desktop devices; the ability to transfer files between point-to-point locations; the ability to provide direct point-to-point communication between individuals or groups; the ability to provide access to information on a one to many basis, on demand; the ability to access existing infrastructure applications; and the ability to deliver the increasing technical complexity to the desktop in a transparent, seamless and intuitive manner.

During the evolution of the Internet, a series of applications have been created to meet the specific needs of each component area. Within each of these areas the survival of the fittest has brought several specific best-of-breed applications and standards. For example, the FTP protocol standard for file transfer, the Mosaic technology for Web browsing, the MIME standard for transparent distribution of all file formats, the HTML syntax as the language of the Web, etc.

The present invention features of marketing through dynamic customization of Web site based HTML tagged documents, as described herein, are readily applicable to Intranets defined by geographic regions such as cities or states. Alternatively, the Intranet can be defined by a particular class of online customers such as "Digital City" customers which are a part of America Online's service. Moreover, several distinct Intranets can be defined by group-



ing Digital City customers according to geographic areas such as cities. In accordance with the present invention features disclosed herein, the content on the PC Flowers & Gifts Web pages can be customized for each distinct Intranet.

It should be understood that the embodiment described herein is merely exemplary and that a person skilled in the art may make many variations and modifications to these embodiment(s) utilizing functionally equivalent elements to those described herein. Any and all such variations or modifications as well as others which may become apparent to those skilled in the art, are intended to be included within the scope of the invention as defined by the appended claims.

What is claimed is:

1. A network server for marketing consumer services by dynamically presenting HTML documents that are customized with content indicative of existing brand name familiarity; said network server comprising:

modem means for receiving input signals to and transmitting output signals from said network server in response to a client having communications access to said network server;

server means for presenting said HTML documents responsive to requests received by said server means across a network to said client as Web site documents which are at least partially customized in response to an identity of a source which referred said client to said network server; said server means being responsive to said modem means;

database means for dynamically configuring data stored in said network server in response to said identity of said source which referred said client; said database means operating in response to said server means; and

processing means for manipulating said modem means, server means and database means to cooperate and present said HTML documents.

2. The network server in accordance with claim 1, wherein said server means comprises hypertext based tools to permit said network server to operate in an Internet based network environment.

3. The network server in accordance with claim 1, wherein said server means comprises hypertext based tools to permit said network server to operate in an Intranet based network environment.

4. The network server in accordance with claim 3, wherein said Intranet based network environment comprises a plurality of said client belonging to a distinct class and said HTML documents are customized with local content intended for said distinct class.

5. The network server in accordance with claim 4, wherein said distinct class comprises a group of customers having a given designation.

6. The network server in accordance with claim 1, wherein said server means comprises a Web server software tool configured to present HTML documents which are customized to market consumer services in response to said source which referred said client to said network server.

7. The network server in accordance with claim 6, wherein said server means comprises dynamic tokening means for passing said identity of said source which referred said client to said network server for dynamically customizing all successive HTML documents anchored to a current one of said HTML documents.

8. The network server in accordance with claim 7, wherein said HTML documents comprise hypertext links

which are anchored to further HTML documents that are dynamically customized as needed to present to said client in response to said distinct class of client.

9. The network server in accordance with claim 1, wherein said distinct class of client is based on a referring source selected from the group consisting of an Internet service provider and a Web site.

10. The network server in accordance with claim 1, wherein said server means includes commercially available software that runs at least some main functions of an online storefront and said database means includes commercially available database software.

11. The network server in accordance with claim 1, wherein said server means presents HTML documents having content dynamically customized in one of a co-branded and private label format.

12. The network server in accordance with claim 11, wherein said co-branded format comprises said content including said network server's host brand name and a brand name of said identity of said source which referred said client to said network server.

13. The network server in accordance with claim 11, wherein said private label format comprises said content being fully customized with brand name and navigation feature requirements set forth by said source which referred said client to said network server.

14. The network server in accordance with claim 1, wherein said server means comprises dynamic tokening means for passing said identity of said source which referred said client to said network server for dynamically customizing as needed said HTML documents presented to said client through hypertext links on any one of said HTML documents.

15. The network server in accordance with claim 14, wherein said hypertext links are grouped as an image map which is anchored to HTML documents that are dynamically created as needed in a customized format that complies with requirements set forth by said source which referred said client to said network server.

16. The network server in accordance with claim 14, wherein said dynamic tokening means comprises an executable tokening means for dynamically outputting, without any input from said client, one of said HTML documents which includes a site token indicative of said identity of said source which referred said client to said network server.

17. The network server in accordance with claim 14, wherein said dynamic tokening means comprises an executable track means for recording an access to said network server from said source referring said client to said network server.

18. The network server in accordance with claim 1, wherein said server means comprises vendor means for presenting to said client vendor based HTML documents dynamically customized in response to said source to allow said client to make purchases and track said source referring said client through any purchases.

19. In a method for marketing consumer services via client/server based network communications wherein a client is presented by a server with documents which contain HTML tags anchored to other HTML documents, the improvement therewith comprising the steps of:

passing dynamically through said HTML tags the identity of a source which refers said client to said server for presentation of said documents containing said HTML tags; and,

customizing dynamically the content of all said documents presented to said client through said HTML tags in response to the identity of said source utilizing said server.

20. The method in accordance with claim 19, wherein said step of passing dynamically comprises a PORT# indicative of said source which is an HTML extension that is embedded within said HTML documents that said server accesses.

21. The method in accordance with claim 20, wherein said step of passing dynamically comprises calling a tokening executable which searches for said PORT#, and when found substitutes said PORT# with a call to said tokening executable with said PORT# passed as a parameter.

22. The method in accordance with claim 20, wherein said step of passing dynamically comprises calling a tracking executable which records an entry onto one of aid HTML documents.

23. The method in accordance with claim 19, wherein said HTML tags are configured as an image map grouping of said HTML tags which are anchored to said other HTML documents which are created dynamically in response to said source when a particular one of said HTML tags is executed as a hypertext transfer.

24. The method in accordance with claim 19, wherein said step of customizing comprises the step of providing co-branded content on said documents with labeling indicative of both a brand name of said source which refers said client to said server and a brand name of a host of said server.

25. The method in accordance with claim 24, wherein said co-branded content comprises headers and footers placed on said documents presented to said server.

26. The method in accordance with claim 19, wherein said step of customizing comprises private labeled content on said documents with labeling indicative only of said source which refers said client to said server.

27. The method in accordance with claim 26, wherein said private labeled content on said documents comprises headers and footers indicative only of said source which refers said client to said server.

28. The method in accordance with claim 19, wherein said step of customizing dynamically comprises configuring content on said documents in accord with requirements set forth by said source which refers said client to said server.

29. The method in accordance with claim 19, wherein said step of customizing dynamically comprises presenting an e-mail reminder HTML document permitting said server to subsequently send a reminder e-mail message to said client.

30. The method in accordance with claim 29, wherein said e-mail reminder HTML document permits event driven reminders selected from the group consisting of holidays, anniversaries, birthdays and a personal event date selected by said client.

31. The method in accordance with claim 19, further comprising the step accepting into said server HTML documents supplied by a vendor wherein said vendor has control over said HTML documents supplied by said vendor.

32. The method in accordance with claim 31, wherein said control by said vendor comprises steps of transferring HTML documents pertaining to product data, and receiving from said server encrypted files containing orders.

33. A method for providing customized information over a computer network to a plurality of clients in response to requests from said plurality of clients, each of said clients being associated with at least one of a plurality of classes, said method comprising:

- storing first data being associated with said requests such that it is available over said network;
- storing second data associated with said classes such that it is available over said network;
- receiving a request over said network from a requesting client;

automatically identifying at least one of said plurality of classes to which said requesting client is associated with;

selecting a portion of said first data associated with said received request and a portion of said second data associated with said identified at least one class; and, transmitting said selected portions of said first and second data as a single transmission sequence and in a format including hypertext protocol and tagging conventions to enable display of a complete and customized electronic document upon receipt of said transmission.

34. A server based communications system operable to present information in response to requests from clients, said server based communications system comprising:

server means for presenting information responsive to requests received by said server means, a portion of said presented information being customized according to a particular class to which said client belongs to and in a format including hypertext protocol and tagging conventions;

database means for retrieving data stored on said server based communications system in accordance with stored requirements which define the customization for said particular class, said database means being responsive to said server means; and

processing means for manipulating said server means and said database means in response to said requests from said client, said server means, database means and processor means being mutually responsive to one another;

wherein said server means comprises a Web server which communicates via said hypertext protocol and tagging conventions and said particular class of client is defined by a particular Web site that referred said client to said server based communications system.

35. A server based communications system operable to present information in response to requests from clients, said server based communications system comprising:

server means for presenting information responsive to requests received by said server means, a portion of said presented information being customized according to a particular class to which said client belongs to and in a format including hypertext protocol and tagging conventions;

database means for retrieving data stored on said server based communications system in accordance with stored requirements which define the customization for said particular class, said database means being responsive to said server means; and

processing means for manipulating said server means and said database means in response to said requests from said client, said server means, database means and processor means being mutually responsive to one another;

wherein said server means customizes the presented information in one of a co-branded format and a private label format.

36. The server based communications system in accordance with claim 35, wherein said co-branded format comprises web site pages with headers and footers including both the referring Web site brand name and the host web site brand name.

37. The server based communications system in accordance with claim 35, wherein said private label format comprises web site pages with headers and footers including only the referring Web site's brand name.

21

38. A server based communications system operable to present information in response to requests from clients, said server based communications system comprising:

server means for presenting information responsive to requests received by said server means, a portion of said presented information being customized according to a particular class to which said client belongs to and in a format including hypertext protocol and tagging conventions;

database means for retrieval of data stored on said server based communications system in accordance with stored requirements which define the customization for said particular class, said database means being responsive to said server means; and

processing means for manipulating said server means and said database means in response to said requests from said client, said server means, database means and processor means being mutually responsive to one another;

wherein said server means comprises dynamic tokening means for tracking said particular class with said hypertext tagging conventions and influencing the customization of the information presented to said client.

22

39. The server based communications system in accordance with claim 38, wherein said dynamic tokening means comprises executable tokening means for dynamically outputting an HTML page which includes substituting in information on the site token of the original source by which said client accessed said server based communications system.

40. The server based communications system in accordance with claim 38, wherein said dynamic tokening means comprises executable track means for recording a Web site entry under a particular site token indicative of the source from which said client entered said server based communications system.

41. The server based communications system in accordance with claim 38, wherein said dynamic tokening comprises a PORT# means for dynamically passing web site information from HTML document to HTML document successively present to said client.

42. The server based communications system in accordance with claim 41, wherein said dynamic tokening comprises IMAGEMAP means for dynamically anchoring image based hypertext links to data stored in said database means in response to said PORT# indicative of said particular class of said client.

\* \* \* \* \*

UNITED STATES PATENT AND TRADEMARK OFFICE  
**CERTIFICATE OF CORRECTION**

PATENT NO. : 6,141,666  
DATED : October 31, 2000  
INVENTOR(S) : William J. Tobin

Page 1 of 2

It is certified that error appears in the above-identified patent and that said Letters Patent is hereby corrected as shown below:

Title page,

Item [60], change "Provisional application No. 60/017,229, Jan 22, 1996 and provisional application No. 60/010,372, May 22, 1996" to read -- Provisional application No. 60/017,229, May 9, 1996 and provisional application No. 60/010,372, Jan. 22, 1996 --.

Column 1,

Line 10, "60/017,229" should read -- 60/010,372 --.  
Line 14, "60/010,372" should read -- 60/017,229 --.  
Line 15, "22" should read -- 9 --.

Column 3,

Line 5, cancel "the server based communications system".  
Line 14, "sever" should read -- server --.  
Line 60, "intranet" should read -- Intranet --.

Column 4,

Line 9, "internet" should read -- Internet --.

Column 5,

Line 5, after "across" insert -- a --.  
Line 26, "consumers" should read -- consumer's --.

Column 6,

Line 18, "consumers" should read -- consumer's --.  
Line 26, "sever" should read -- server --.  
Line 31, cancel "18" and insert -- 20 --.  
Line 32, cancel "18" and insert -- 20 --.

Column 7,

Line 5, cancel "is".  
Line 63, after "line" insert -- " --.

Column 8,

Line 19, delete "s".  
Line 22, "point" should read -- points --.  
Line 51, "email" should read -- e-mail --.

UNITED STATES PATENT AND TRADEMARK OFFICE  
**CERTIFICATE OF CORRECTION**

PATENT NO. : 6,141,666  
DATED : October 31, 2000  
INVENTOR(S) : William J. Tobin

Page 2 of 2

It is certified that error appears in the above-identified patent and that said Letters Patent is hereby corrected as shown below:

Column 9,

Line 67, cancel "Pathfinder" and insert -- Homearts--.

Column 10,

Line 11, "sever" should read -- server --.

Column 13,

Line 63, "mark" should read -- mark --.

Column 14,

Line 65, after "to" insert -- be --.

Column 15,

Line 32, after "with" insert -- the --.

Column 16,

Line 10, cancel "are".

Line 11, after "and" cancel "to".

Column 19,

Line 12, "aid" should read -- said --.

Signed and Sealed this

Sixteenth Day of October, 2001

Attest:

*Nicholas P. Godici*

Attesting Officer

NICHOLAS P. GODICI  
Acting Director of the United States Patent and Trademark Office