

Ma

KEY STAGE

3

TIER

6–8

Mathematics test

Paper 1

Calculator not allowed

First name _____

Last name _____

School _____

Remember

- The test is 1 hour long.
- You **must not** use a calculator for any question in this test.
- You will need: pen, pencil, rubber, ruler and a pair of compasses.
- Some formulae you might need are on page 2.
- This test starts with easier questions.
- Try to answer all the questions.
- Write all your answers and working on the test paper – do not use any rough paper. Marks may be awarded for working.
- Check your work carefully.
- Ask your teacher if you are not sure what to do.

For marker's use only

TOTAL MARKS

<http://www.SATs-Papers.co.uk>

2008

Instructions

Answers



This means write down your answer or show your working and write down your answer.

Calculators



You **must not** use a calculator to answer any question in this test.

Formulae

You might need to use these formulae

Trapezium

$$\text{Area} = \frac{1}{2}(a + b)h$$

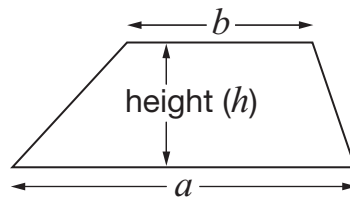

Prism

area of cross-section

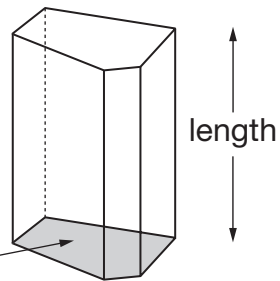

$$\text{Volume} = \text{area of cross-section} \times \text{length}$$

1. Match each expression on the left with the equivalent expression on the right.
The first one is done for you.



$3d + d$	3
$3d - d$	$2d$
$3d \times d$	$3d$
$3d \div d$	$4d$
	$2d^2$
	$3d^2$
	$2d^3$

A line connects the box containing $3d + d$ to the box containing $4d$.

2 marks



2. Look at the two triangular prisms.

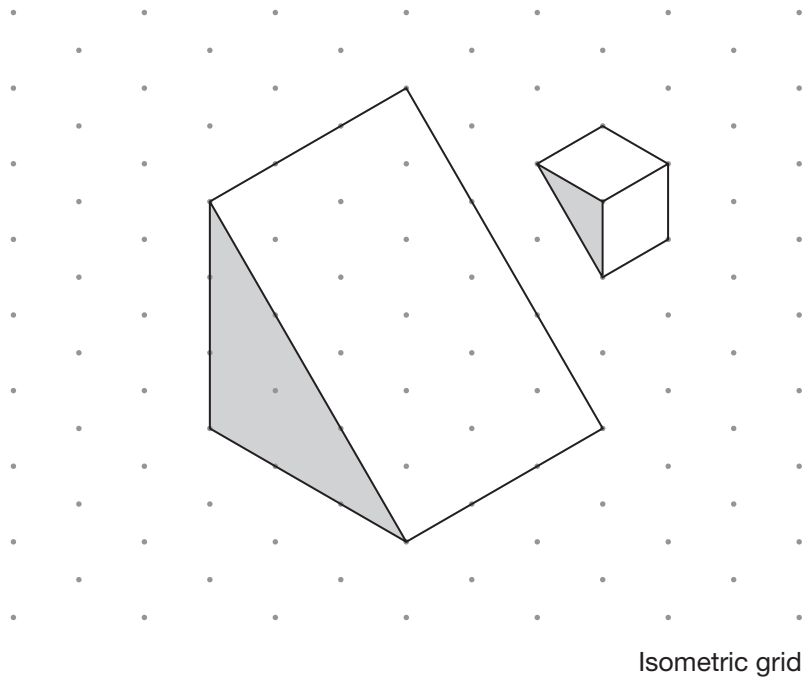

They are joined to make the new shape below.

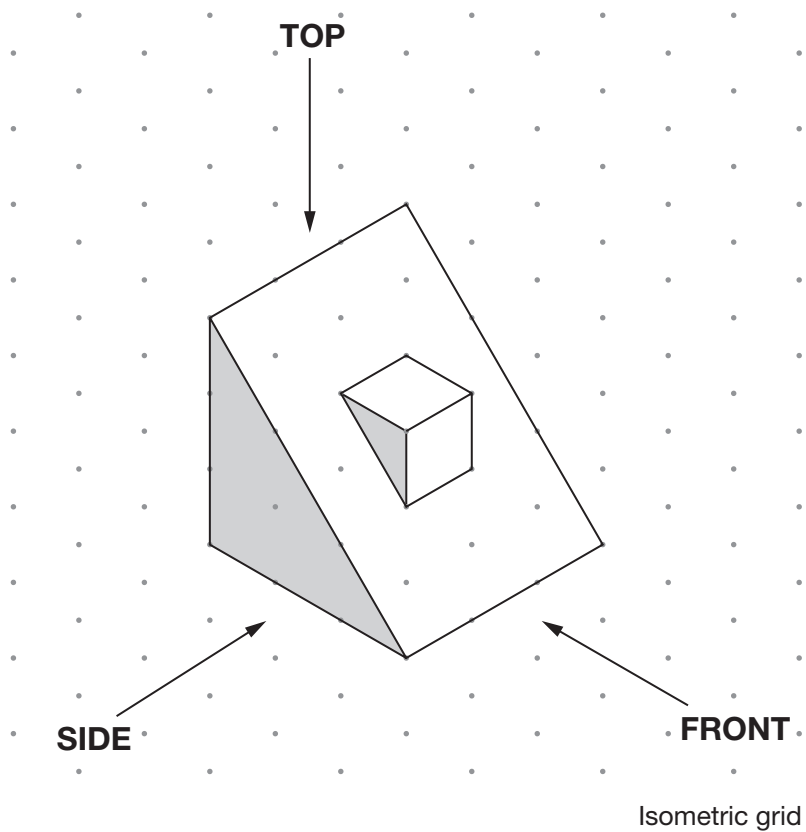

Complete the views of the new shape on the grid.

The first one is done for you.

View from the **TOP** View from the **FRONT** View from the **SIDE**

Square grid

2 marks

3. I am thinking of a number.

My number is a **multiple of 6**

What **three other numbers** must my number be a multiple of?



_____, _____ and _____

1 mark



4. There are **25 pupils** in a class.

The table shows information about their test results in maths and English.

		English		
		Level 5	Level 6	Level 7
maths	Level 5	0	1	1
	Level 6	2	7	0
	Level 7	2	1	4
	Level 8	0	1	6

- (a) How many pupils had the **same level** in both maths and English?



1 mark

- (b) How many pupils had a **higher level** in **maths** than in English?



1 mark

5. The diagram shows a square with a **perimeter** of **12cm**.



Not drawn accurately

Six of these squares fit together to make a rectangle.



Not drawn accurately

What is the **area** of the **rectangle**?

You **must** give the correct unit with your answer.

1 mark



1 mark



6. The table shows whether pupils in a class walk to school.

	Walk to school	Do not walk to school
Boys	2	8
Girls	5	10

- (a) What percentage of the **boys** walk to school?



_____ %

_____ 1 mark

- (b) What percentage of the **pupils** in this class walk to school?



_____ %

_____ 2 marks

7. A pupil recorded the times of **23** people running the 100 metres.
The stem-and-leaf diagram shows the results.

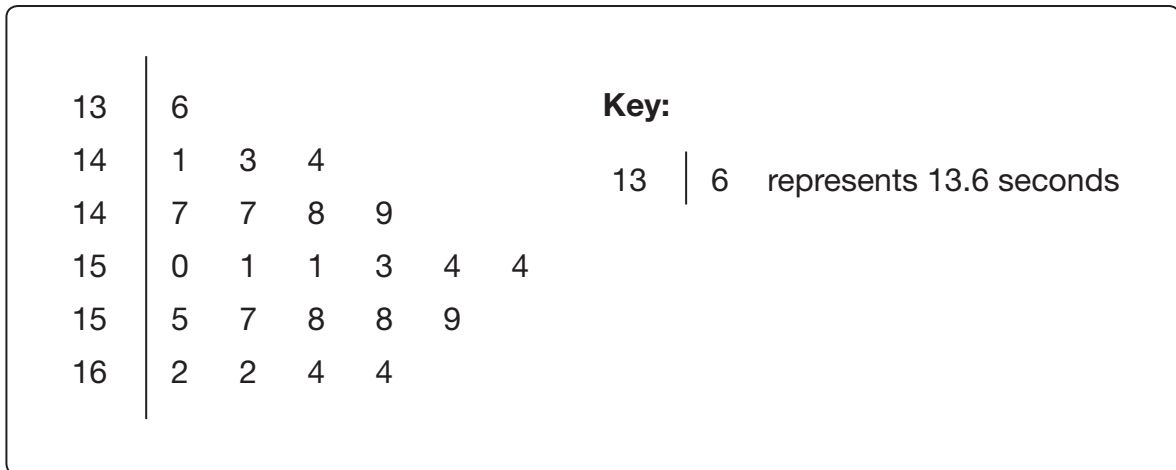

- (a) Two of the people ran the 100 metres in **14.7 seconds**.

How many of them ran the 100 metres **faster** than this?



_____ people

1 mark

- (b) What was the **range** of times?



seconds

2 marks

- (c) What was the **median** time?



seconds

1 mark



8. (a) For each sequence below, tick (✓) the correct box to show if it is **increasing**, **decreasing** or **neither**.



				increasing	decreasing	neither
$\frac{1}{2}$	$\frac{1}{3}$	$\frac{1}{4}$	$\frac{1}{5}$	<input type="checkbox"/>	<input type="checkbox"/>	<input type="checkbox"/>
$\frac{6}{13}$	$\frac{7}{12}$	$\frac{8}{11}$	$\frac{9}{10}$	<input type="checkbox"/>	<input type="checkbox"/>	<input type="checkbox"/>
$\frac{1}{2}$	$\frac{2}{4}$	$\frac{3}{6}$	$\frac{4}{8}$	<input type="checkbox"/>	<input type="checkbox"/>	<input type="checkbox"/>
$\frac{3}{2}$	$\frac{4}{3}$	$\frac{5}{4}$	$\frac{6}{5}$	<input type="checkbox"/>	<input type="checkbox"/>	<input type="checkbox"/>

2 marks

- (b) A different sequence has this expression for the n th term:

$$\frac{1}{(n + 1)^2}$$

Work out the first four terms in the sequence.



1 mark

9. Find the value of x

$$6 + 2x = x - 6$$



$$x = \underline{\hspace{2cm}}$$

2 marks

10. Work out



$$\frac{1 \times 2 \times 3 \times 4 \times 5}{1 \times 2 \times 3} = \underline{\hspace{2cm}}$$

1 mark



$$\frac{(1 \times 2 \times 3 \times 4 \times 5)^2}{(1 \times 2 \times 3)^2} = \underline{\hspace{2cm}}$$

1 mark



11. This map of part of America shows Chicago and New York.
The scale is **1cm to 100 miles**.



Atlanta is further south than both Chicago and New York.
It is **710 miles** from Chicago and **850 miles** from New York.
Use accurate construction to show Atlanta on the map.
You **must** leave in your construction lines.

2 marks

12. Point A has coordinates (4, 3) and point B has coordinates (10, 3)

They lie on a horizontal line.

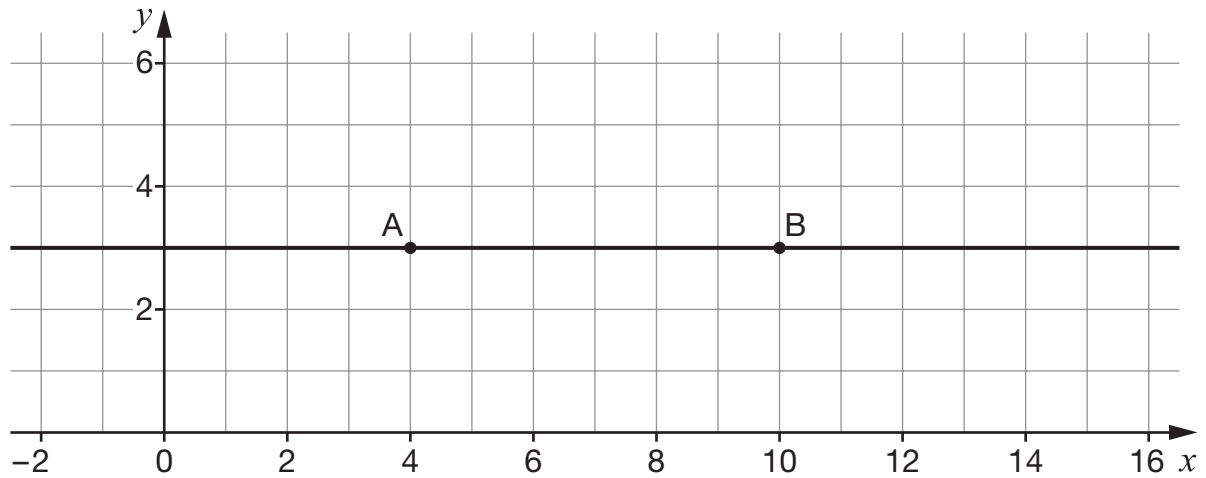

Another point, P, lies on the **same** horizontal line.

P is **twice as far from A** as it is from B.

What could the coordinates of point P be?

There are two possible answers. Give them both.



(_____ , _____) or (_____ , _____)

2 marks



13. In this question, consider only positive values of x

Look at this function.

$$p = 3x$$

As x increases, p increases.

For each function below, tick (✓) the correct box.



$$q = x - 2$$

As x increases, q increases q decreases

$$r = \frac{1}{2}x$$

As x increases, r increases r decreases

$$s = 2 - x$$

As x increases, s increases s decreases

$$t = \frac{1}{x}$$

As x increases, t increases t decreases

2 marks

14. In a bag, there are **red** and **blue** cubes in the ratio **4 : 7**

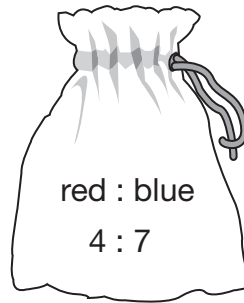

I add **10 more red cubes** to the bag.

Now there are **red** and **blue** cubes in the ratio **6 : 7**

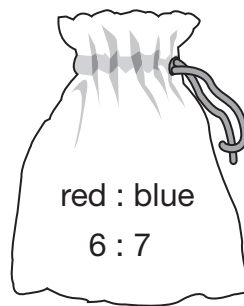

How many **blue** cubes are in the bag?



2 marks



15. (a) A straight line goes through the points (0, 1), (2, 5) and (4, 9)

The equation of the straight line is $y = 2x + 1$

Is the point (7, 12) on this straight line?



Yes

No

Explain your answer.



1 mark

- (b) A **different** straight line goes through the points (0, 1), (2, 7) and (4, 13)

Write the equation of this straight line.



1 mark

16. (a) Explain why $\sqrt{89}$ must be between 9 and 10



_____ 1 mark

(b) $\sqrt{389}$ is also between two consecutive whole numbers.

What are the two numbers?



_____ and _____

_____ 1 mark

17. Here are the rules of a game.

Each person chooses heads or tails at random, then a coin is thrown.
 People who choose the side shown by the coin are left in the game.
 The rest are out of the game.

If a group of **1000 people** are going to play this game, how many people might you expect to be left in the game after **5 throws**?



_____ people

_____ 2 marks



18. The diagram shows the net of a cube made of 6 squares.

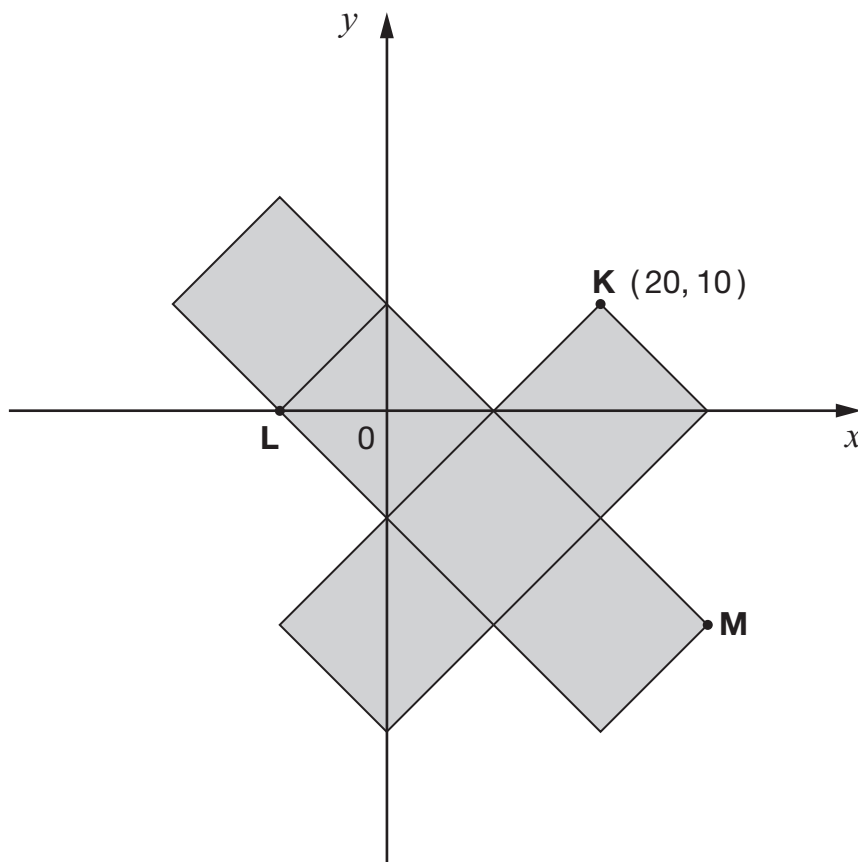

Not drawn
accurately

K is the point **(20, 10)**

What are the coordinates of the points **L** and **M**?



L is (_____ , _____)

1 mark



M is (_____ , _____)

1 mark

19. (a) Ed writes:

$$\frac{1}{2} \text{ of } 10^3 = 5^3$$

Show why Ed is **wrong**.



1 mark

(b) Sasha writes:

$$\frac{1}{2} \text{ of } 6 \times 10^8 = 3 \times 10^4$$

Show why Sasha is **wrong**.



1 mark

(c) Work out $\frac{1}{2}$ of 1.65×10^6

Give your answer in **standard form**.



2 marks



20. Jane and Delia work together.

Delia's pay is exactly **twice** as much as Jane's.

They are each going to get a pay increase.

(a) If they each get a **pay increase of £2000**, tick (✓) the true statement below.



- Delia's pay will be more than twice as much as Jane's.
- Delia's pay will be exactly twice as much as Jane's.
- Delia's pay will be less than twice as much as Jane's.
- There is not enough information to tell.

1 mark

(b) If instead they each get a **5% pay increase**, tick (✓) the true statement below.



- Delia's pay will be more than twice as much as Jane's.
- Delia's pay will be exactly twice as much as Jane's.
- Delia's pay will be less than twice as much as Jane's.
- There is not enough information to tell.

1 mark

21. Look at this factorisation.

$$x^2 + 5x + 6 = (x + 2)(x + 3)$$

Write numbers to make a correct factorisation below.



$$x^2 + 7x + \underline{\hspace{2cm}} = (x + \underline{\hspace{2cm}})(x + \underline{\hspace{2cm}})$$

 1 mark

Now write **different** numbers to make a correct factorisation.



$$x^2 + 7x + \underline{\hspace{2cm}} = (x + \underline{\hspace{2cm}})(x + \underline{\hspace{2cm}})$$

 1 mark



22. Dario has five cards showing different shapes.

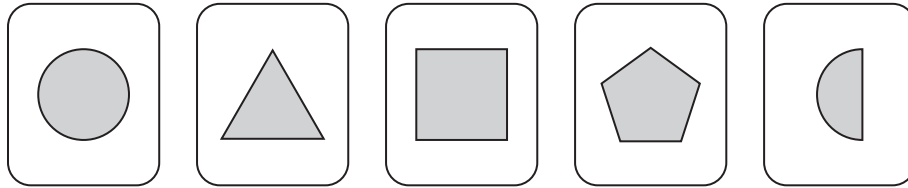

He is going to mix them up, then take out one card at random.

Then he is going to take out a second card without replacing the first card.

- (a) What is the probability that he will take out **the square first and then the circle**?



2 marks

- (b) What is the probability that he will take out the **square** and the **circle**, in **either order**?



1 mark

23. The graph shows the straight line with equation $y = \frac{1}{2}x + 1$

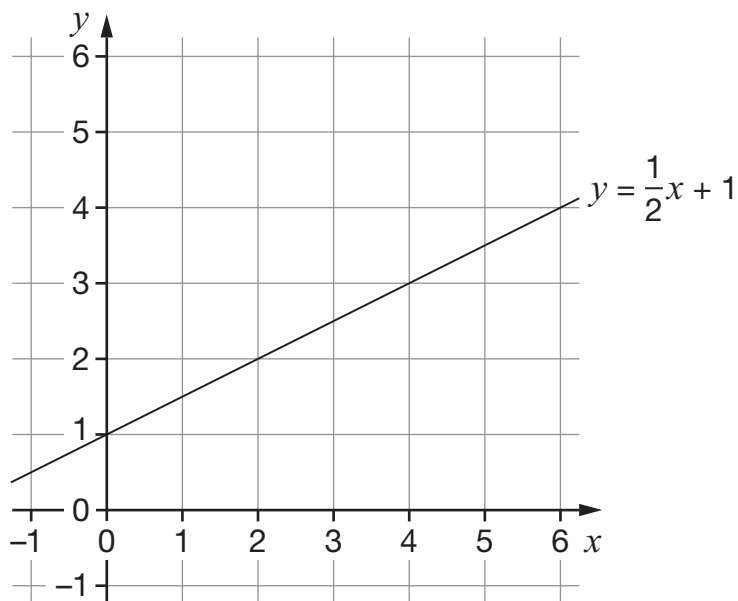

- (a) For each point in the table, tick (✓) the correct box to show if it is **above** the line, **on** the line or **below** the line.

The first one is done for you.

Point	Above the line	On the line	Below the line
(6, 3)			✓
(8, 5)			
(100, 60)			
(-4, -3)			

2 marks

- (b) Write the equation of a different straight line that is always **below** the line with equation $y = \frac{1}{2}x + 1$



1 mark



24. Each expression below represents either a length, an area or a volume.

a , b and c all represent lengths.

For each expression, tick (✓) the correct one.

The first one is done for you.

$$2a + c$$

length area volume

$$3ab$$



length area volume

$$4a(b + c)$$



length area volume

$$a^2b$$



length area volume

2 marks

25. The cumulative frequency diagram shows the speeds of cars on a motorway on a Monday and a Thursday.

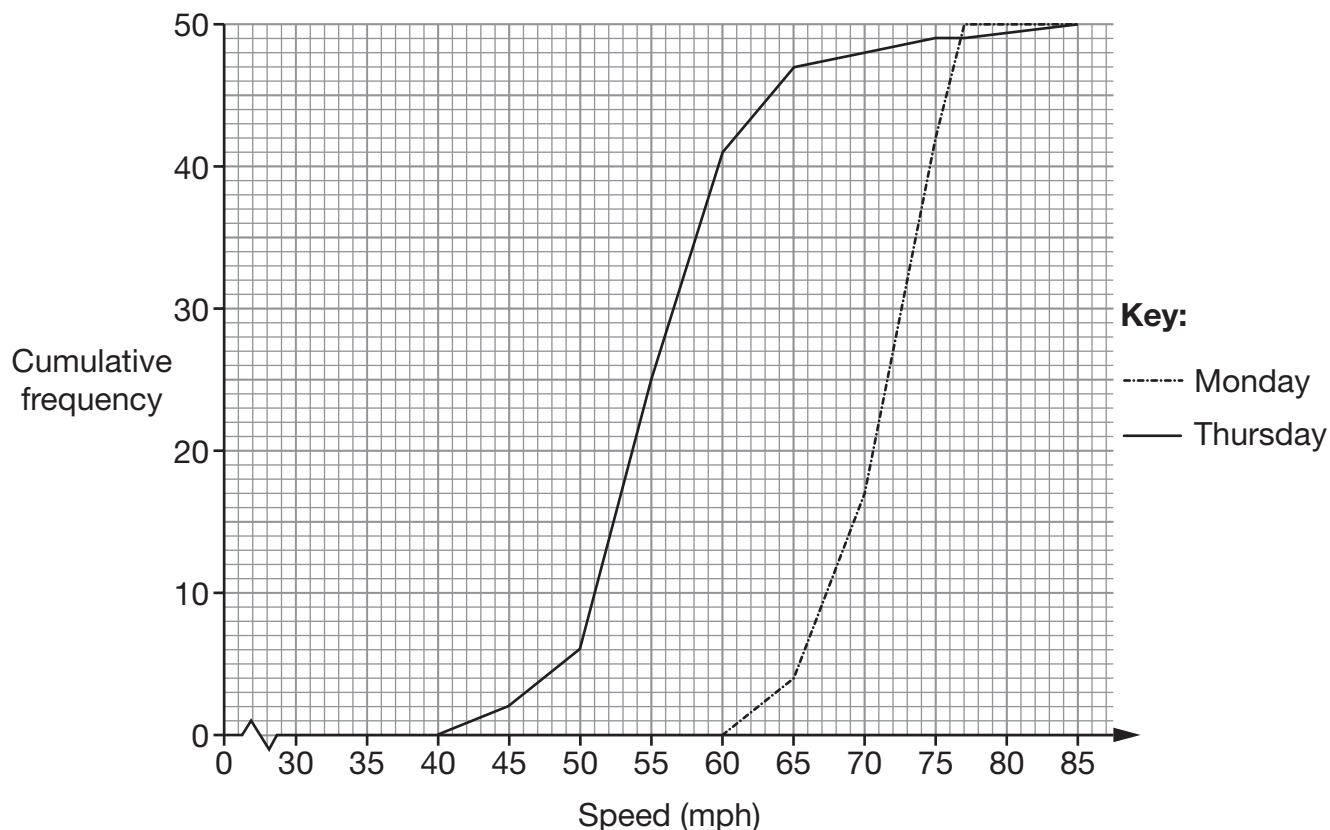

- (a) The speed limit is **70mph**.

On **Monday**, about what proportion of these cars were going faster than the speed limit?



1 mark

- (b) On one of the days, it rained all day.

Which day is this more likely to be?



Monday

Thursday

Explain your answer.



1 mark



26. Look at this information about a pair of numbers, k and n

$$k < n$$

and

$$k^2 > n^2$$

Give an example of what the numbers could be.



$k = \underline{\hspace{2cm}} \quad n = \underline{\hspace{2cm}}$

1 mark

27. I think of two numbers, x and y

$x - y$ is **half** of $x + y$

Write x in terms of y



$x = \underline{\hspace{2cm}}$

2 marks

END OF TEST



END OF TEST