

Panasonic®

Owner's Manual DVD Home Theater Sound System

Model No. SC-XH170



Thank you for purchasing this product.
For optimum performance and safety, please read these instructions carefully.
Please keep this manual for future reference.

If you have any questions, contact: 1-800-211-PANA (7262)

- The illustrations shown may differ from your unit.
- Operations in these instructions are described mainly with the remote control, but you can perform the operations on the main unit if the controls are the same.

System		SC-XH170
Main unit		SA-XH170
Speaker system	Front speakers	SB-HF171
	Center speaker	SB-HC171
	Surround speakers	SB-HS171
Subwoofer		SB-HW190

Accessories



Please check and identify the supplied accessories. Use numbers indicated in parentheses when asking for replacement parts. (Product numbers are correct as of November 2011. These may be subject to change.)

To order accessories, refer to “Accessory Purchases (United States and Puerto Rico)” on page 23.

- 1 Remote control (N2QAYB000702)
- 1 Remote control battery
- 1 FM indoor antenna (RSAX0002)



- 5 Speaker cables
(REEX1266A-J: RED)
(REEX1267A-J: WHITE)
(REEX1268-J: GREEN)
(REEX1269-J: GRAY)
(REEX1270-J: BLUE)
- 1 AC power supply cord (K2CB2YY00059)
- 1 Sheet of speaker cable stickers

IMPORTANT SAFETY INSTRUCTIONS

Read these operating instructions carefully before using the unit. Follow the safety instructions on the unit and the applicable safety instructions listed below. Keep these operating instructions handy for future reference.

- 1 Read these instructions.
- 2 Keep these instructions.
- 3 Heed all warnings.
- 4 Follow all instructions.
- 5 Do not use this apparatus near water.
- 6 Clean only with dry cloth.
- 7 Do not block any ventilation openings. Install in accordance with the manufacturer's instructions.
- 8 Do not install near any heat sources such as radiators, heat registers, stoves, or other apparatus (including amplifiers) that produce heat.
- 9 Do not defeat the safety purpose of the polarized or grounding-type plug. A polarized plug has two blades with one wider than the other. A grounding-type plug has two blades and a third grounding prong. The wide blade or the third prong are provided for your safety. If the provided plug does not fit into your outlet, consult an electrician for replacement of the obsolete outlet.
- 10 Protect the power cord from being walked on or pinched particularly at plugs, convenience receptacles, and the point where they exit from the apparatus.
- 11 Only use attachments/accessories specified by the manufacturer.
- 12 Use only with the cart, stand, tripod, bracket, or table specified by the manufacturer, or sold with the apparatus. When a cart is used, use caution when moving the cart/apparatus combination to avoid injury from tip-over.
- 13 Unplug this apparatus during lightning storms or when unused for long periods of time.
- 14 Refer all servicing to qualified service personnel. Servicing is required when the apparatus has been damaged in any way, such as power-supply cord or plug is damaged, liquid has been spilled or objects have fallen into the apparatus, the apparatus has been exposed to rain or moisture, does not operate normally, or has been dropped.



WARNING

Unit

- To reduce the risk of fire, electric shock or product damage,
 - Do not expose this unit to rain, moisture, dripping or splashing.
 - Do not place objects filled with liquids, such as vases, on this unit.
 - Use only the recommended accessories.
 - Do not remove covers.
 - Do not repair this unit by yourself. Refer servicing to qualified service personnel.

Power cord

- Install this unit so that the power cord can be unplugged from the socket outlet immediately if any problem occurs.

CAUTION

Unit

- This unit utilizes a laser. Use of controls or adjustments or performance of procedures other than those specified herein may result in hazardous radiation exposure.
- Do not place sources of naked flames, such as lighted candles, on this unit.

Placement

- To reduce the risk of fire, electric shock or product damage,
 - Do not install or place this unit in a bookcase, built-in cabinet or in another confined space. Ensure this unit is well ventilated.
 - Do not obstruct this unit's ventilation openings with newspapers, tablecloths, curtains, and similar items.

Batteries

- Danger of explosion if battery is incorrectly replaced. Replace only with the type recommended by the manufacturer.
- Mishandling of batteries can cause electrolyte leakage and may cause a fire.
 - Do not heat or expose to flame.
 - Do not leave the battery(ies) in a car exposed to direct sunlight for a long period of time with doors and windows closed.
 - Do not take apart or short circuit.
 - Do not recharge alkaline or manganese batteries.
 - Do not use batteries if the covering has been peeled off.
 - Remove the battery if you do not intend to use the remote control for a long period of time. Store in a cool, dark place.
 - When disposing the batteries, please contact your local authorities or dealer and ask for the correct method of disposal.

	CAUTION RISK OF ELECTRIC SHOCK DO NOT OPEN	
<p>CAUTION: TO REDUCE THE RISK OF ELECTRIC SHOCK, DO NOT REMOVE SCREWS. NO USER-SERVICEABLE PARTS INSIDE. REFER SERVICING TO QUALIFIED SERVICE PERSONNEL.</p>		



The lightning flash with arrowhead symbol, within an equilateral triangle, is intended to alert the user to the presence of uninsulated “dangerous voltage” within the product's enclosure that may be of sufficient magnitude to constitute a risk of electric shock to persons.



The exclamation point within an equilateral triangle is intended to alert the user to the presence of important operating and maintenance (servicing) instructions in the literature accompanying the appliance.

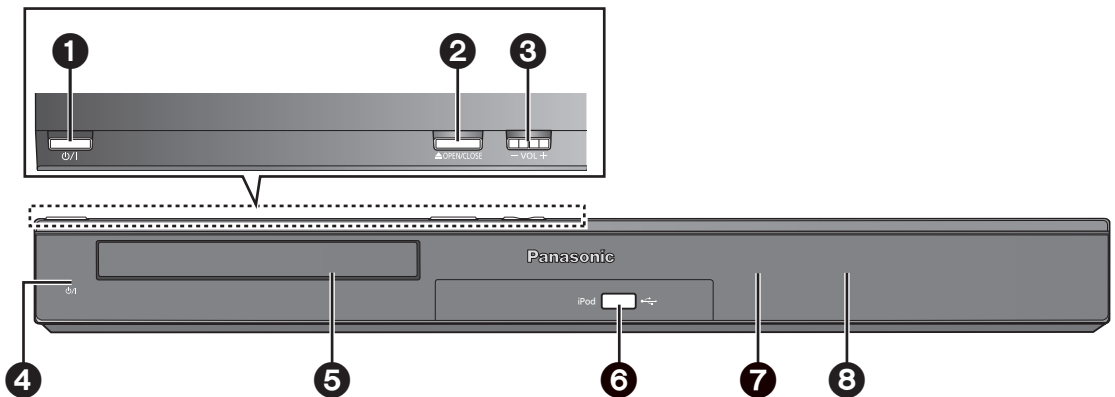
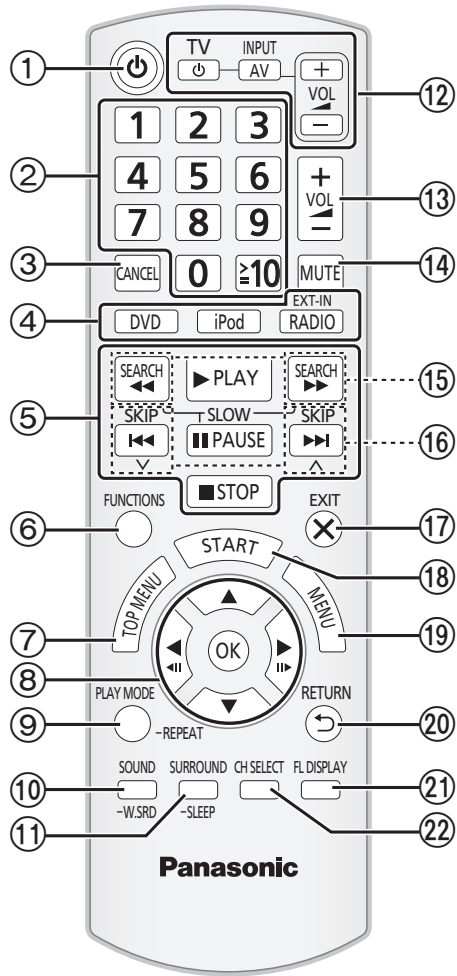

Control reference guide

Remote control

- ① Turn the main unit on/off (⇒ 8)
- ② Select channels and title numbers etc. / Enter numbers (⇒ 9, 11)
- ③ Cancel (⇒ 12)
- ④ **Source select**
[DVD]: Select disc as the source (⇒ 11)
[iPod]: Select iPod®/iPhone® as the source (⇒ 15)
[EXT-IN, RADIO]: Select the FM tuner or the external audio source (⇒ 9)
FM → AUX → ARC → D-IN
↑—————┘
- ⑤ Basic operations for play (⇒ 11)
- ⑥ Show on-screen menu (⇒ 13)
- ⑦ Show a disc top menu (⇒ 11)
- ⑧ Select or confirm menu items / Frame-by-frame (⇒ 11)
- ⑨ Select the play mode / Set the repeat mode (⇒ 12)
- ⑩ Select sound mode / Turn Whisper-mode Surround on/off (⇒ 10, 11)
- ⑪ Select surround sound effects (⇒ 10)
or
Set the Sleep timer
Press and hold [–SLEEP].
While the time is shown on the main unit's display, press [–SLEEP] repeatedly.
Each time you press the button:
SLEEP 30 → SLEEP 60 → SLEEP 90 → SLEEP 120
↑————— OFF (Cancel) —————┘
 - To confirm the remaining time, press and hold the button again.
- ⑫ **TV operations**
Aim the remote control at the Panasonic TV and press the button.
[TV, ⏻]: Turn the TV on/off
[INPUT, AV]: Change the TV's video input mode
[+, VOL, –]: Adjust the TV volume
This may not work properly with some models.
- ⑬ Adjust the volume of the main unit
- ⑭ **Mute the sound**
 - "MUTE" flashes on the main unit's display while the function is on.
 - To cancel, press the button again or adjust the volume.
 - Mute is cancelled when you switch the unit to standby.
- ⑮ Select radio stations manually (⇒ 9)
- ⑯ Select preset radio stations (⇒ 9)
- ⑰ Exit the display
- ⑱ Show START menu (⇒ 9)
- ⑲ Show a disc menu (⇒ 11)
- ⑳ Return to previous screen (⇒ 11)
- ㉑ Switch information on the main unit's display (⇒ 11)
- ㉒ Select speaker channel (⇒ 11)

Avoiding interference with other Panasonic equipment

Other Panasonic audio/video equipment may start functioning when you operate the unit using the supplied remote control. You can operate this unit in another mode by setting the remote control operating mode to "REMOTE 2".

The main unit and remote control must be set to the same mode.

- 1 Press [EXT-IN]④ to select "AUX".
- 2 Press and hold [▲ OPEN/CLOSE]② on the main unit and [2] on the remote control until the main unit's display shows "REMOTE 2".
- 3 Press and hold [OK]⑧ and [2] on the remote control for at least 2 seconds.

To change the mode back to "REMOTE 1", repeat the steps above by replacing [2] with [1].

Main unit

- ① **Standby/on switch (⏻/I)**
Press to switch the unit from on to standby mode or vice versa. In standby mode, the unit is still consuming a small amount of power.
- ② Open/Close the disc tray (⇒ 11)
- ③ Adjust the volume of the main unit
- ④ **Power indicator**
The indicator lights when this unit is turned on.
- ⑤ Disc tray
- ⑥ Connect iPod/iPhone (⇒ 15)
- ⑦ Remote control signal sensor
- ⑧ Display (FL display)

POWER-SAVING FEATURES

The main unit is designed to conserve its power consumption and save energy.

■ Auto FL display turn-off function

The main unit's display is automatically turned off when the volume is adjusted to "0". (⇒ 17, "FL Control" in Others menu.)

■ Auto power-down function

- The main unit will automatically switch to standby mode after 30 minutes of inactivity.
e.g.
 - There is no audio signal from an external device.
 - Disc playback is stopped/paused.
 - iPod/iPhone playback is stopped/paused.
 - The disc menu is displayed and play is not selected.
(This function may not work depending on the application type of discs.)
- When the main unit is turned back on, "POWER ON FROM AUTO POWER DOWN MODE" appears on the main unit's display.

TABLE OF CONTENTS

Getting Started

Accessories	2
IMPORTANT SAFETY INSTRUCTIONS	2
Control reference guide	4
POWER-SAVING FEATURES	4

Quick Start Guide

step 1 Positioning	6
step 2 Connections	6
Speaker connections	6
Radio antenna connection	6
Audio and video connections	7
step 3 AC power supply cord connection	8
step 4 Preparing the remote control	8
step 5 Easy setup	8
Listening to the radio	9
Presetting stations automatically	9
Listening to a preset channel	9
Using the START menu	9
Selecting the source using the remote control	9
Listening to the TV or other device's audio from this unit's speakers	10
Enjoying sound effects from all speakers	10
Enjoying surround sound effects	10
Selecting sound mode	10
Whisper-mode Surround	11
Adjusting the speaker level during playback	11
Adjusting the speaker balance during playback	11

Playing Discs

Basic play	11
Playing from the selected item	12
Other modes of play	12
Program and Random play	12
Repeat play	12
Using on-screen menus	13

Other Operations

Linked operations with the TV	
(VIERA Link™ "HDAVI Control™")	14
Setting the audio link	14
Easy control only with VIERA remote control	15
Using the iPod®/iPhone®	15

Reference

Changing the player settings	16
Discs that can be played	18
Maintenance	18
Speaker installation option	19
Troubleshooting guide	19
Messages	21
Licenses	21
Specifications	22
Limited Warranty	23

step 1 | Positioning

How you set up your speakers can affect the bass and the sound field. Note the following points:

- Place speakers on flat secure bases.
- Keep your speakers at least 10 mm ($13/32$ ") away from the system for proper ventilation.
- Placing speakers too close to floors, walls, and corners can result in excessive bass. Cover walls and windows with thick curtains.
- For optional wall mount, refer to page 19.

Setup example ("Surround layout (Recommended)"): Standard surround placement)

Place the front, center, and surround speakers at approximately the same distance from the seating position. The angles in the diagram are approximate.

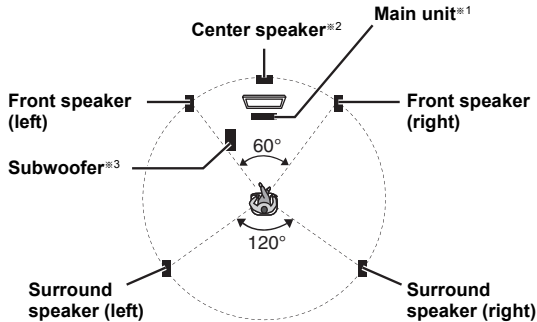

- ※1 Position with at least 5 cm (2") of space on all sides for proper ventilation.
- ※2 Place it on a rack or shelf. Vibration caused by the speaker can disrupt the picture if it is placed directly on the TV.
- ※3 Position it to the right or left of the TV, on the floor or a sturdy shelf so that it will not cause vibration. Leave about 30 cm ($11\frac{13}{16}$ ") from the TV.

Depending on the room layout, you may like to use all the speakers at the front ("Front layout (Alternative)") (→ 8, Easy setup).

Notes on speaker use

● Use only supplied speakers

Using other speakers can damage the unit, and sound quality will be negatively affected.

- You can damage your speakers and shorten their lifespan if you play sound at high levels over extended periods.
- Reduce the volume in the following cases to avoid damage:
 - When playing distorted sound.
 - When the speakers are reverberating due to a record player, noise from FM broadcasts, or continuous signals from an oscillator, test disc, or electronic instrument.
 - When adjusting the sound quality.
 - When turning the unit on or off.

If irregular coloring occurs on your TV

The center speaker is designed to be placed close to a TV, but the picture may be affected on some TVs and setup combinations.

If this occurs, turn the TV off for about 30 minutes.

The demagnetizing function of the TV should correct the problem. If it persists, move the speakers further away from the TV.



Caution

- The main unit and supplied speakers are to be used only as indicated in this setup. Failure to do so may lead to damage to the amplifier and/or the speakers, and may result in the risk of fire. Consult a qualified service person if damage has occurred or if you experience a sudden change in performance.
- Do not attempt to attach these speakers to walls using methods other than those described in this manual.

step 2 | Connections

Turn off all equipment before connection and read the appropriate operating instructions.

Do not connect the AC power supply cord until all other connections are completed.

1 Speaker connections

Pay attention to the type of speaker and the connector color when you place the speakers.

Main unit (rear)

Connect to the terminals of the same color.

Use of the speaker cable stickers is convenient when making cable connections.

Speakers (rear)

Insert the wire fully, taking care not to insert beyond the wire insulation.

+ : White
– : Blue line

- Be careful not to cross (short circuit) or reverse the polarity of the speaker wires as doing so may damage the speakers.

2 Radio antenna connection

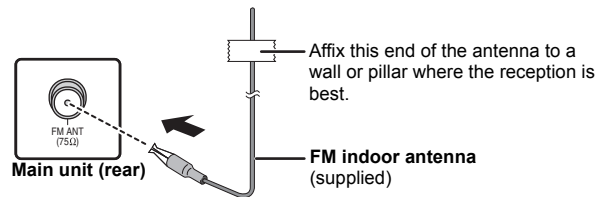

Use an FM outdoor antenna if radio reception is poor.

3 Audio and video connections

- To listen to the TV audio on the sound system, connect the optical digital audio cable, HDMI® cable or audio cable.

Refer to the operating instructions of the respective devices for the settings necessary to output the audio.

- ※ Only when connecting to an ARC compatible TV. Refer to "Connection with an ARC compatible TV" for details. (⇒ below)

Recommended connection to a TV

This connection provides the best picture and audio quality.

VIERA Link "HDAVI Control"

If your Panasonic TV is VIERA Link compatible, you can operate your TV synchronizing with home theater operations or vice versa (⇒ 14, Linked operations with the TV).



- Use the High Speed HDMI Cables.
- Non-HDMI-compliant cables cannot be utilized.
- It is recommended that you use Panasonic's HDMI cable. Recommended part number: RP-CDHS15 (1.5 m/4.9 ft), RP-CDHS30 (3.0 m/9.8 ft), RP-CDHS50 (5.0 m/16.4 ft), etc.
- Do not make the video connections through the VCR.** Due to copy guard protection, the picture may not be displayed properly.
- After connecting with the optical digital audio cable or HDMI® cable, make settings to suit the type of audio from your digital equipment (⇒ 10). (Only Dolby Digital and PCM can be played with this connection.)

Connection with an ARC compatible TV

What is ARC?

ARC is an abbreviation of Audio Return Channel, also known as HDMI ARC. It refers to one of the HDMI functions. If the TV is ARC compatible, audio from the TV can be sent to this unit via the HDMI cable without the need to make an extra audio connection.

- Refer to the operating instructions of the TV for details.

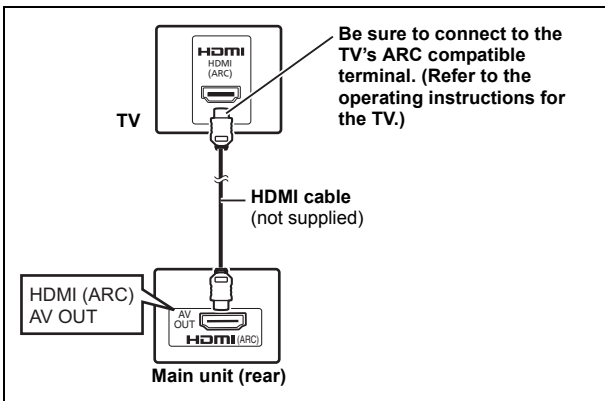

Connection without an ARC compatible TV

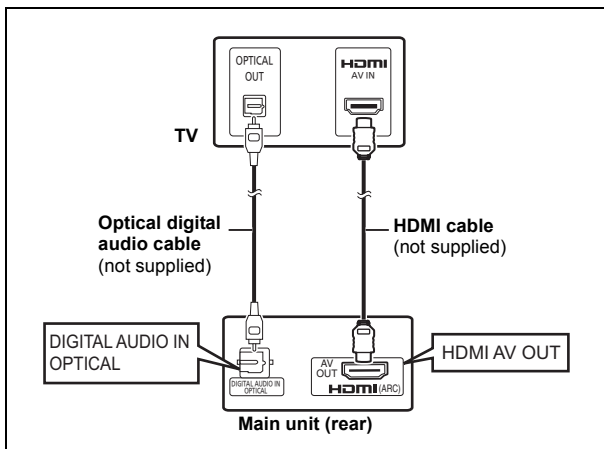

Alternative connection to a TV

- Use this video connection if the TV's HDMI input terminal is not available.

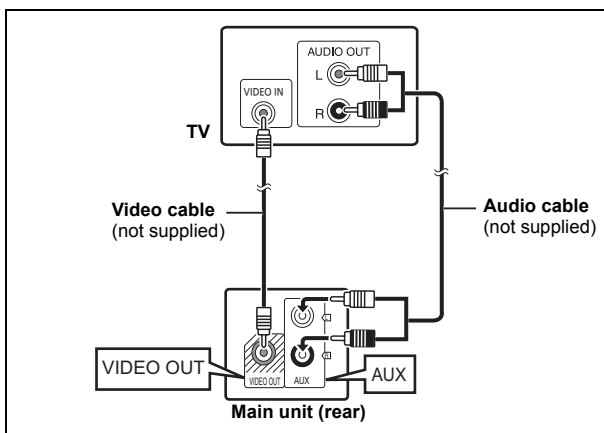

Set Top Box (cable/satellite/Blu-ray Disc player, etc) connection

Use this connection when you want to output the original surround audio from your STB, etc. to this unit.

Connect the optical digital audio cable (not supplied) from the DIGITAL AUDIO IN OPTICAL terminal on the main unit to the OPTICAL OUT terminal on your STB.

- If the DIGITAL AUDIO IN OPTICAL terminal is already in use for the TV audio, reconnect the TV audio to the AUX terminal using an audio cable.



If you have various sound sources (such as Blu-ray Disc player, DVD recorder, VCR, etc.), connect them to the available inputs on the TV and the TV output should then be connected to the AUX, HDMI AV OUT® or DIGITAL AUDIO IN OPTICAL terminal of the main unit.

step 3 | AC power supply cord connection

To household AC outlet
(AC 120 V, 60 Hz)

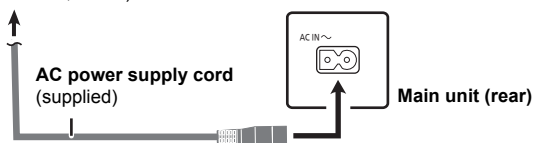

Conserving power

The main unit consumes a small amount of power, even when it is in standby mode (approx. 0.2 W). To save power when the unit is not to be used for a long time, unplug it from the household AC outlet. You will need to reset some memory items when plugging back the main unit.



The supplied AC power supply cord is for use with the main unit only. Do not use it with other equipment. Also, do not use cords from other equipment with the main unit.

step 4 | Preparing the remote control

- 2 Insert so the poles (+ and -) match those in the remote control.

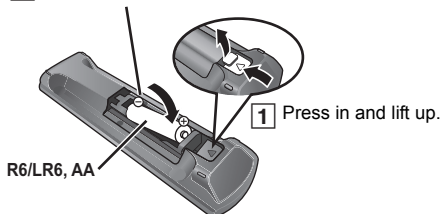

- 3 Replace the cover.

- Use alkaline or manganese batteries.

Use

Aim at the remote control signal sensor (⇒ 4), avoiding obstacles.
Distance: Within approx. 7 m (23 ft)
Angle: Within approx. 20° up and down, approx. 30° to the left and right

step 5 | Easy setup

The Easy setup screen assists you in making necessary settings.

Preparation

- Turn on your TV and select the appropriate video input mode (e.g. VIDEO 1, AV 1, HDMI, etc.) to suit the connection to this unit.
- To change your TV's video input mode, refer to its operating instructions.
 - This remote control can perform some basic TV operations (⇒ 4).

1 Press [Power] to turn on the unit.

- The Easy setup screen appears automatically.

2 Press [Up], [Down] to select "Yes" and press [OK].

3 Follow the messages and make the settings with [Up], [Down], [Left], [Right] and [OK].

• Language

Select the language used on menu screen.

• TV aspect

Select the aspect to suit your TV.

• Speaker layout

Select "Surround layout (Recommended)" mode or "Front layout (Alternative)" mode according to your speaker layout (⇒ 6, Positioning).

• Speaker check

Listen to speaker output to confirm speaker connections.

• Speaker output

Make surround sound setting for speaker output.

• TV audio

Select the audio input connection from your TV.

For AUX connection (⇒ 7): Select "AUX".

For HDMI connection (⇒ 7): Select "ARC".

For DIGITAL AUDIO IN OPTICAL connection (⇒ 7): Select "DIGITAL IN".

This will be the TV audio setting for VIERA Link "HDAVI Control". (⇒ 14)

4 Press [OK] to finish the "Easy setup".



- You can perform this setup anytime by selecting "Easy setup" in the Setup menu. (⇒ 17)
- If this unit is connected to a "HDAVI Control 3 or later" compatible TV via HDMI cable, the menu language and TV aspect information will be retrieved via VIERA Link.
- If this unit is connected to a "HDAVI Control 2" compatible TV via HDMI cable, the menu language information will be retrieved via VIERA Link.

Listening to the radio

You can preset up to 30 channels.
The radio settings will be shown on the unit's display. (Some settings are also indicated on the TV screen.)

Preparation

Make sure that the FM antenna is connected. (⇒ 6)

Presetting stations automatically

- 1 Press **[RADIO]**④ to select "FM".
- 2 Press **[MENU]**⑨ to select "LOWEST" or "CURRENT".
LOWEST:
To begin auto preset with the lowest frequency (FM 87.9 or FM 87.5).
CURRENT:
To begin auto preset with the current frequency.*
* To change the frequency, refer to "Manual tuning and presetting".
- 3 Press and hold **[OK]**⑧.
Release the button when "FM AUTO" is displayed.
The tuner starts to preset all the stations it can receive into the channels in ascending order.

Listening to a preset channel

- 1 Press **[RADIO]**④ to select "FM".
- 2 Press the numbered buttons to select the channel.
• To select a 2-digit number
e.g. 12: **[≧10]**② ⇒ **[1]** ⇒ **[2]**
Alternatively, press **[v, ^]**⑩.

Manual tuning and presetting

Select a radio broadcast.

- 1 Press **[RADIO]**④ to select "FM".
- 2 Press **[SEARCH ◀◀, SEARCH ▶▶]**⑮ to select the frequency.
• To start automatic tuning, press and hold **[SEARCH ◀◀, SEARCH ▶▶]**⑮ until the frequency starts scrolling. Tuning stops when a station is found.

To preset the channel

- 3 While listening to the radio broadcast
Press **[OK]**⑧.
- 4 While the frequency is flashing on the display
Press the numbered buttons to select the channel.



A station previously stored is overwritten when another station is stored in the same channel preset.

Using the START menu

You can select desired source, change the settings, access playback/menus, etc., by using the START menu.

1 Press **[START]**⑩ to show the START menu.

- When using VIERA Link "HDAVI Control", the TV also turns on when the START menu is displayed.

e.g.



2 Press **[▲, ▼]**⑧ to select an item and press **[OK]**⑧.

- To exit, press **[START]**⑩.

3 Press **[▲, ▼, ◀, ▶]**⑧ to make the setting and press **[OK]**⑧.

When "Input select" is selected

You can select a desired source from the menu.

- DVD/CD (⇒ 11), FM RADIO (⇒ left), AUX*1 (⇒ below), ARC*1 (⇒ below), DIGITAL IN*1,2 (⇒ below), iPod (⇒ 15)
- ※1 "TV" will appear beside "AUX", "ARC" or "DIGITAL IN", indicating the TV audio setting for VIERA Link "HDAVI Control" (⇒ 14).
- ※2 "(STB)" will appear beside "DIGITAL IN", indicating the STB audio setting for VIERA Link "HDAVI Control" (⇒ 14).

When "Setup" is selected

You can change the settings for this unit. (⇒ 16)

Other selectable items

The items that are displayed will vary depending on the media and source.

When a disc is loaded, you can also access playback or menus from the START menu.

e.g. **[DVD-V]**

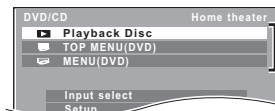

Playback/menu access

When the on-screen control panel appears

e.g. **[DVD-V]** (when "Playback Disc" is selected from the START menu)

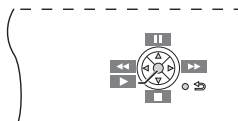

You can operate the playback with the indicated controls.

Selecting the source using the remote control

Press	To select
[DVD] ④	DVD/CD
[iPod] ④	IPOD (⇒ 15)
[EXT-IN, RADIO] ④	Each time you press the button: FM: (⇒ left) AUX: For audio input through the AUX terminal. ARC: For audio input through the HDMI AV OUT terminal. D-IN: For audio input through the DIGITAL AUDIO IN OPTICAL terminal. (⇒ 10)



Confirm the audio connection to the AUX, HDMI AV OUT or DIGITAL AUDIO IN OPTICAL terminal on the main unit when you select the corresponding sources (⇒ 7). Reduce the volume on the TV to its minimum, and then adjust the volume of the main unit.

Listening to the TV or other device's audio from this unit's speakers

Preparation

- Make sure that there is an audio connection between this unit and the TV or other device. (⇒ 7)
- Turn on the TV or/and other device.

Press [EXT-IN]④ to choose the source that is used to connect this unit to the TV or other device.

- To change the surround sound effects and sound mode, refer to "Enjoying sound effects from all speakers" (⇒ right).
- If your Panasonic TV is VIERA Link compatible, refer to "Linked operations with the TV" (⇒ 14) for other related functions.

Making settings for digital audio input

Select to suit the type of audio from the DIGITAL AUDIO IN OPTICAL and HDMI AV OUT terminal on the main unit.

- Underlined items are the factory presets.

Available settings	
Mode	Setting
DUAL:	(Only works with Dolby Dual Mono) – <u>MAIN+SAP</u> (stereo audio) – <u>MAIN</u> – <u>SAP</u> "SAP" = Secondary Audio Program • Set PCM FIX mode to "OFF" to listen to the "MAIN" or "SAP" audio.
DRC: (Dynamic Range Compression)	– <u>ON</u> Adjust for clarity even when the volume is low by compressing the range of the lowest sound level and the highest sound level. Convenient for late night viewing. (Only works with Dolby Digital) – <u>OFF</u> The full dynamic range of the signal is reproduced.
PCM FIX:	– <u>ON</u> Select when receiving only PCM signals. – <u>OFF</u> Select when receiving Dolby Digital and PCM signals. • When receiving true 5.1-channel surround sound, select "OFF".
STB*: (CABLE/SAT AUDIO)	– <u>SET</u> Select when setting the main unit to switch to "D-IN" when the input channel of an HDMI connected device (STB, etc.) is selected on the TV (⇒ 14, Setting the audio link with the STB). – <u>OFF</u> Select to cancel this setting.

- 1 Press [EXT-IN]④ several times to select "D-IN" or "ARC".
- 2 Press [PLAY MODE]⑨ and then [▲, ▼]⑧ to select the mode.
- 3 While the selected mode is displayed, press [◀, ▶]⑧ to select the desired setting.

※ Only when "D-IN" is selected.
Be sure to select the device's (STB, etc.) input channel on the TV when making the setting.

The device must be connected to the Panasonic TV via an HDMI cable and to this unit with an optical digital audio cable.

- If the device's (STB, etc.) input channel on the TV is changed or if you want to change the device allocated for the linked operations, select the "STB" mode to "OFF" in step 3 above and then select "SET" again.
- This function will not operate if "DIGITAL IN" is selected in "TV Audio" (⇒ 17).

Enjoying sound effects from all speakers

- The following sound effects may not be available or may have no effect with some sources.
- You may experience a reduction in sound quality when these sound effects are used with some sources. If this occurs, turn the sound effects off.



When changing the surround sound effect, Whisper-mode Surround or the sound modes, the setting is displayed on the TV screen if "DVD/CD" is the selected source during video playback.

Enjoying surround sound effects

Press [SURROUND]⑩.

Each time you press the button:

For "Surround layout (Recommended)"* mode

STANDARD:

Sound is output as it was recorded/encoded. Speaker output varies depending on the source.

MULTI-CH:

You can enjoy sound from the front speakers, as well as the surround speakers and center speaker even when playing stereo sources.

MANUAL: (⇒ below)

While "MANUAL" is displayed, press [◀, ▶]⑧ to select other surround modes.

Each time you press [◀, ▶]⑧:

DOLBY PLII MOVIE

Suitable for movies, or videos recorded in Dolby Surround.

DOLBY PLII MUSIC

Adds 5.1-channel effects to stereo sources.

S.SRD (Super Surround)

You can enjoy sound from all speakers with stereo sources.

STEREO

Sound will only be output to the front speakers and the subwoofer from any source.

Recommended modes to enjoy TV audio or stereo sources from all speakers:

"MULTI-CH", "DOLBY PLII MOVIE", "DOLBY PLII MUSIC" or "S.SRD"

For "Front layout (Alternative)"* mode

STANDARD:

Stereo source is output as 2.1-channel audio.

When playing surround sources, you can enjoy 5.1-channel surround-like effect even with all the speakers at the front.

STEREO:

You can play any source in stereo. Surround sound effect is unavailable.

A.SRD (Advanced Surround):

You can enjoy surround effect with any audio source.

When the signal is DTS or Dolby Digital, "DTS" or "DOLBY DIGITAL" will also be displayed respectively.

※ Selected mode in "Speaker layout" (⇒ 8, Easy setup).

Selecting sound mode

1 Press [SOUND]⑩ to select a sound mode.

Each time you press the button:

- EQ:** Equalizer
- SUBW LVL:** Subwoofer Level
- C.FOCUS:** Center Focus (Only when "Surround layout (Recommended)" mode is selected in "Speaker layout" (⇒ 8, Easy setup).)

2 While the selected mode is displayed, press [◀, ▶]⑧ to make the settings.

Refer to the following for setting details of each sound effect.

EQ (Equalizer)

You can select sound quality settings.

Each time you press [◀, ▶]Ⓢ:

FLAT: Cancel (no effect is added).

HEAVY: Adds punch to rock.

CLEAR: Clarifies higher sounds.

SOFT: For background music.

SUBW LVL (Subwoofer level)

You can adjust the amount of bass. The unit automatically selects the most suitable setting according to the type of playback source.

LEVEL 1 ↔ LEVEL 2 ↔ LEVEL 3 ↔ LEVEL 4

- The setting you make is retained and recalled every time you play the same type of source.

C.FOCUS (Center Focus)

(Effective when playing audio containing the center channel sound or when DOLBY PLII (⇒ 10) is selected.)

You can make the sound of the center speaker seem like it is coming from within the TV.

ON ↔ OFF

Whisper-mode Surround

You can enhance the audio effect for low volume 5.1-channel sound. (Convenient for late night viewing.)

Press and hold [-W.SRD]Ⓢ to show the current setting.

While the current setting is displayed, press [-W.SRD]Ⓢ to change the setting.

ON ↔ OFF

Adjusting the speaker level during playback

Only when "Surround layout (Recommended)" mode is selected in "Speaker layout" (⇒ 8, Easy setup)

(Effective when playing 5.1-channel sound or when DOLBY PLII/"S.SRD" (⇒ 10) is selected.)

1 Press [CH SELECT]Ⓢ to select the speaker.

Each time you press the button:

e.g. L → C → R → RS → LS → SW

- You can adjust SW (Subwoofer) only if the disc includes a subwoofer channel.
- When "S" appears, only the surround speaker channel can be adjusted. Both surround speaker levels will be adjusted at the same time.

2 While "C", "RS", "LS", "SW" or "S" is selected Press [▲]Ⓢ (increase) or [▼]Ⓢ (decrease) to adjust the speaker level for each speaker.

C, RS, LS, SW, S: -6 dB to +6 dB

(L, R: Only the balance is adjustable.) (⇒ below)

Adjusting the speaker balance during playback

For "Surround layout (Recommended)"* mode:

Front speaker balance

For "Front layout (Alternative)"* mode:

Front and surround speaker balance

1 Press [CH SELECT]Ⓢ to select "L" or "R".

2 While "L" or "R" is selected

Press [◀, ▶]Ⓢ to adjust the speaker balance.

* Selected mode in "Speaker layout" (⇒ 8, Easy setup).

Basic play

Preparation

To display the picture, turn on your TV and change its video input mode (e.g. VIDEO 1, AV 1, HDMI, etc.) to suit the connection to this unit.

- 1 Press [⏻]Ⓢ to turn on the unit.
- 2 Press [DVD]Ⓢ to select "DVD/CD".
- 3 Press [▲ OPEN/CLOSE]Ⓢ to open the disc tray.

4 Load the disc.

- Load double-sided discs so the label for the side you want to play is facing up.

Label facing up



5 Press [▶ PLAY]Ⓢ to start play.

- Press [+ , VOL, -]Ⓢ to adjust the volume.



- When you press [▲ OPEN/CLOSE]Ⓢ to close the disc tray, this unit automatically starts playing the disc in the tray.

JPEG

– Only the contents in the current group will be played.

You can select your desired item to start play. (⇒ 12, Using navigation menu)

- DISCS CONTINUE TO ROTATE WHILE MENUS ARE DISPLAYED.

Press [■ STOP]Ⓢ when you finish to preserve the unit's motor and your TV screen.

- Total title number may not be displayed properly on +R/+RW.

Basic controls

Stop: [■ STOP]Ⓢ

The position is memorized while "RESUME" is on the main unit's display. [DVD-V] [VCD] [CD] This unit can memorize the resume position for the last 5 discs.

- Press [▶ PLAY]Ⓢ to resume.
- Press [■ STOP]Ⓢ again to clear the position.

Pause: [⏸ PAUSE]Ⓢ

- Press [▶ PLAY]Ⓢ to restart play.

Skip: [SKIP ◀◀, SKIP ▶▶]Ⓢ

Search: [SEARCH ◀◀, SEARCH ▶▶]Ⓢ (during play)

Slow-motion: [SEARCH ◀◀, SEARCH ▶▶]Ⓢ (during pause)

- Search: Up to 4 steps
- Slow-motion: Up to 3 steps
- Press [▶ PLAY]Ⓢ to start normal play.
- [VCD] Slow-motion: Forward direction only.

[DVD-V] [VCD] Frame-by-frame: [◀◀, ▶▶]Ⓢ (during pause)

- [VCD] Forward direction only.

On-screen item select: [▲, ▼, ◀, ▶, OK]Ⓢ

[▲, ▼, ◀, ▶]Ⓢ: Select

[OK]Ⓢ: Confirm

Enter number: Numbered buttons

[DVD-V] [VCD] [CD]

e.g. To select 12: [≧10]Ⓢ ⇒ [1] ⇒ [2]

[DVD-V] Show a disc top menu: [TOP MENU]Ⓢ

[DVD-V] Show a disc menu: [MENU]Ⓢ

Return to previous screen: [RETURN]Ⓢ

[VCD] (with playback control)

Show a disc menu: [RETURN]Ⓢ

Turn PBC function on/off: [MENU]Ⓢ

Main unit display: [FL DISPLAY]Ⓢ

[DVD-V]

Time display ↔ Information display

[JPEG]

SLIDE ↔ Contents number

Playing from the selected item

Using navigation menu

CD JPEG

You can select to play from your desired item while the navigation menu screen is displayed.

Group (Folder):

Content (File/Track):

: CD-DA

: JPEG

e.g. CD

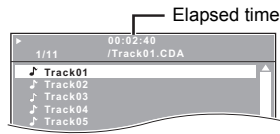

Press [▲, ▼]Ⓢ to select an item and press [OK]Ⓢ.

- Press [◀, ▶]Ⓢ to skip page by page.

Play starts from the selected content.

JPEG

- To return to the previous folder, press [RETURN]Ⓢ. You can also do this by selecting "⏪ .." in the menu.
- Maximum: 16 characters for file/folder name.
- Only the contents in the current group will be played.

Selecting the picture in Thumbnail menu

JPEG

1 While the picture is displayed, press [TOP MENU]Ⓢ to show the thumbnail menu.

e.g.



2 Press [▲, ▼, ◀, ▶]Ⓢ to select a picture and press [OK]Ⓢ.

- Press [SKIP ◀◀, SKIP ▶▶]Ⓢ to skip page by page.

Rotating a picture

While a picture is displayed, press [▲, ▼, ◀, ▶]Ⓢ to rotate the picture.

Other modes of play

Program and Random play

CD JPEG

Preparation

While stopped, press [PLAY MODE]Ⓢ to select the play mode.

Each time you press the button:

CD Music Program menu

JPEG Picture Program menu

RND (Random) menu

Exit program and random menus

Program play (up to 30 items)

1 Press [▲, ▼]Ⓢ to select an item and press [OK]Ⓢ. e.g. JPEG

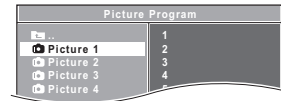

- When a content is selected, it will be programmed.
- Repeat this step to program other items.
- JPEG To return to the previous folder, press [RETURN]Ⓢ. You can also do this by selecting "⏪ .." in the menu.

2 Press [▶ PLAY]Ⓢ to start play.

To clear the selected program

- 1 Press [▶]Ⓢ and then press [▲, ▼]Ⓢ to select the program.
- 2 Press [CANCEL]Ⓢ.

To clear the whole program

Press [▶]Ⓢ several times to select "Clear All", and then press [OK]Ⓢ. The whole program is also cleared when the disc tray is opened, the unit is turned off or another source is selected.

Random play

CD All tracks will be played in random order.

Press [▶ PLAY]Ⓢ to start play.

JPEG The JPEG contents of the selected group will be played in random order.

1 Press [▲, ▼]Ⓢ to select the desired group and press [OK]Ⓢ.

e.g.

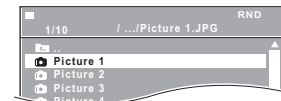

- To return to the previous folder, press [RETURN]Ⓢ. You can also do this by selecting "⏪ .." in the menu.

2 Press [▲, ▼]Ⓢ to select the desired content and press [OK]Ⓢ.

Play starts from the selected content.

Repeat play

This works only when the elapsed play time can be displayed. It also works with all JPEG content.

During play, press and hold [–REPEAT]Ⓢ, to show the repeat mode.

While the repeat mode is displayed, press [–REPEAT]Ⓢ to select the item to be repeated.

e.g. DVD-V

Chapter → Title → Off

To cancel, select "Off".

Items shown differ depending on the type of disc and playback mode.



Random mode will be cleared when you change the repeat mode.

Using on-screen menus

1 Press [FUNCTIONS]Ⓞ to show the on-screen menu.

Each time you press the button:

- Menu 1 (Disc)
- Menu 2 (Video)
- Menu 3 (Audio)
- Exit

e.g. **DVD-V** Menu 1 (Disc)

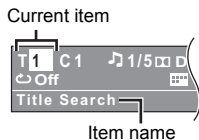

2 Press [▲, ▼, ◀, ▶]Ⓞ to select the item and press [OK]Ⓞ.

e.g. **DVD-V** Menu 1 (Disc)

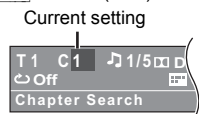

3 Press [▲, ▼]Ⓞ to make the settings and press [OK]Ⓞ.



This does not work during HD JPEG playback (⇒ 16, HD JPEG Mode **JPEG**)

Items shown will vary depending on the type of disc.

Menu 1 (Disc)

Track Search, Title Search, Content Search, Chapter Search

To start from a specific item

e.g. **DVD-V**: T2 C5

To select 12: [≧10]② ⇒ [1] ⇒ [2] ⇒ [OK]Ⓞ

Audio

DVD-V (with multiple soundtracks)

To select audio soundtrack

VCD

To select "L", "R", "L+R" or "L R"

Actual operations depend on the disc. Read the disc's instructions for details.

Signal type/data

LPCM/D/DTS/MPEG: Signal type

Play Speed

DVD-V

To change play speed

– from "×0.6" to "×1.4" (in 0.1-unit steps)

• Press [▶] PLAY⑤ to return to normal play.

• After you change the speed

– Dolby Pro Logic II has no effect.

– Audio output switches to 2-channel stereo.

– Sampling frequency of 96 kHz is converted to 48 kHz.

• This function does not work with DTS source. The play speed will return to "×1.0".

• This function may not work depending on the disc's recording.

Repeat Mode

(⇒ 12, Repeat play)

A-B Repeat (To repeat a specified section)

Except **JPEG**

Press [OK]Ⓞ at the starting and ending points.

• Select "Off" to cancel.

Subtitle

DVD-V (with multiple subtitles)

To select subtitle language

• On +R/+RW, a subtitle number may be shown for subtitles that are not displayed.

Angle

DVD-V (with multiple angles)

To select a video angle

Menu 2 (Video)

Transfer Mode

To select the method of conversion for video output to suit the type of material
Auto, Video

• When the content is distorted, select "Video".

• This may have no effect with some sources.

Zoom

To select zoom

Normal, 1, 2, 3

Menu 3 (Audio)

Dialog Enhancer

To make the dialog in movies easier to hear

DVD-V (Dolby Digital, DTS, 3-channel or higher, with the dialog recorded in the center channel)

Off, On

Linked operations with the TV (VIERA Link™ “HDAVI Control™”)

What is VIERA Link “HDAVI Control”?

VIERA Link™ is a new name for EZ Sync™.

VIERA Link “HDAVI Control” is a convenient function that offers linked operations of this unit, and a Panasonic TV (VIERA) under “HDAVI Control”. You can use this function by connecting the equipment with the HDMI cable. See the operating instructions for connected equipment for operational details.

Preparation

- Confirm that the HDMI connection has been made (⇒ 7).
- 1 Set “VIERA Link” to “On” (⇒ 17).
(The default setting is “On”.)
- 2 Set the “HDAVI Control” operations on the connected equipment (e.g., TV).
- 3 Turn on all “HDAVI Control” compatible equipment and select this unit’s input channel on the connected TV so that the “HDAVI Control” function will work properly.

Whenever the connection or settings are changed, repeat this procedure and reconfirm the points in “Setting the audio link” (⇒ below).

Setting the audio link

■ Setting the audio link with the TV

Select “AUX”, “ARC”^{※1} or “DIGITAL IN” for TV audio link.

Refer to TV audio setting in Easy setup (⇒ 8) or “TV Audio” in HDMI menu (⇒ 17).

Confirm the TV audio connection to the AUX terminal (for “AUX”), HDMI AV OUT terminal (for “ARC”^{※1}) or DIGITAL AUDIO IN OPTICAL terminal (for “DIGITAL IN”) on the main unit (⇒ 7).

■ Setting the audio link with the STB

Select “D-IN” for STB audio link.

Refer to STB setting in “Making settings for digital audio input” (⇒ 10).

Confirm the STB audio connection to the DIGITAL AUDIO IN OPTICAL terminal (for “D-IN”) on the main unit (⇒ 7).



- VIERA Link “HDAVI Control”, based on the control functions provided by HDMI which is an industry standard known as HDMI CEC (Consumer Electronics Control), is a unique function that we have developed and added. As such, its operation with other manufacturers’ equipment that supports HDMI CEC cannot be guaranteed.
- This unit supports “HDAVI Control 5” function.
“HDAVI Control 5” is the newest standard (current as of November, 2011) for Panasonic’s HDAVI Control compatible equipment. This standard is compatible with Panasonic’s conventional HDAVI equipment.
- Please refer to individual manuals for other manufacturers’ equipment supporting VIERA Link function.

Auto lip-sync

(For “HDAVI Control 3 or later”)

This function automatically provides synchronized audio and video output. (This works only when the source is “DVD/CD”, “AUX”^{※2}, “ARC”^{※1, 2} or “D-IN”^{※2, 3}.)

- When using “DVD/CD” as the source, set “Time Delay” in Video menu to “0ms/Auto” (⇒ 16).

Auto input switching (Power on link)

When the following operations are performed, the TV will automatically switch the input channel and display the corresponding action.

Additionally when the TV is off, the TV will automatically turn on:

- When play starts on the unit
- When an action that uses the display screen is performed (e.g., START menu)
- When you switch the TV input to TV tuner mode or the STB input channel, this unit will automatically switch to “AUX”^{※2}, “ARC”^{※1, 2} or “D-IN”^{※2, 3}.
- When you start disc play, the TV will automatically switch its input mode for this unit.

Power off link

All connected equipment compatible with “HDAVI Control”, including this unit, automatically turn off when you switch the TV off.

To continue audio playback even when the TV is turned off, select “Video” (⇒ 17, “Power Off Link” in HDMI menu).



When you press [⏻]①, only this unit turns off. Other connected equipment compatible with VIERA Link “HDAVI Control” stays on.

For details, refer also to the operating instructions for your TV.

Speaker selection

You can select whether audio will output from this unit’s speakers or the TV speakers by using the TV menu settings. For details, refer to the operating instructions for your TV.

Home theater

This unit’s speakers are active.

- When you turn on this unit, this unit’s speakers will be automatically activated.
- When this unit is in standby mode, changing the TV speakers to this unit’s speakers in the TV menu will automatically turn this unit on and select “AUX”^{※2}, “ARC”^{※1, 2} or “D-IN”^{※2, 3} as the source.
- The TV speakers are automatically muted.
- You can control the volume setting using the volume or mute button on the TV’s remote control. (The volume level is displayed on the main unit’s display.)
- To cancel muting, you can also use this unit’s remote control (⇒ 4).
- If you turn off this unit, TV speakers will be automatically activated.

TV

TV speakers are active.

- The volume of this unit is set to “0”.
 - This function works only when “DVD/CD”, “AUX”^{※2}, “ARC”^{※1, 2} or “D-IN”^{※2, 3} is selected as the source on this unit.
- Audio output is 2-channel audio.



When switching between this unit speakers and TV speakers, the TV screen may go blank for several seconds.

- | | |
|----|---|
| ※1 | The selection works only when using an ARC compatible TV. |
| ※2 | “AUX”, “ARC” or “D-IN” (DIGITAL IN) works depending on the TV audio setting (⇒ left, Setting the audio link with the TV). |
| ※3 | “D-IN” (DIGITAL IN) works depending on the STB audio setting (⇒ left, Setting the audio link with the STB). |

Easy control only with VIERA remote control

(For "HDAVI Control 2 or later")

You can control the playback menus of this unit with the TV's remote control. When operating the TV's remote control, refer to the below illustration for operation buttons.

- 1 Select this unit's operation menu by using the TV menu settings. (For details, refer to the operating instructions for your TV.) The START menu will be shown. e.g. **DVD-V**

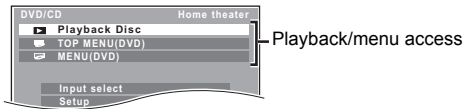

- The START menu can also be shown by using a button on the TV's remote control (e.g. [SUB MENU]).
 - When "DVD/CD" is selected as the source, the TV's remote control works only during stop mode.
 - This feature does not work while the iPod music playback screen is displayed on the TV.

- 2 Select the desired item on the START menu (⇒ 9).

When the on-screen control panel appears e.g. **DVD-V** (when "Playback Disc" is selected from the START menu.)

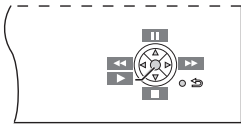

You can operate the playback with the indicated controls.

- The on-screen control panel can also be shown by using a button on the TV's remote control (e.g. [SUB MENU]).
 - This works only during "DVD/CD" playback and resume modes or, while the iPod music playback screen is displayed on the TV.



- Depending on the menu, some button operations cannot be performed from the TV's remote control.
- You cannot input numbers with the numbered buttons on the TV's remote control ([0] to [9]). Use this unit's remote control to select the play list etc.

Using the iPod®/iPhone®

You can enjoy iPod/iPhone music through this unit's speakers.

Preparation

Before connecting/disconnecting the iPod/iPhone, turn the main unit off or reduce the volume of the main unit to its minimum.

1 Connect the iPod/iPhone.

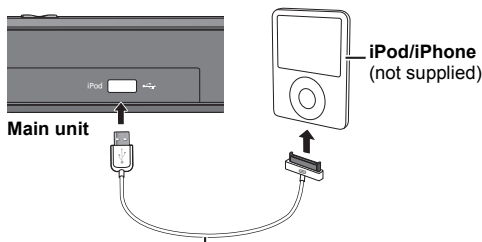

Dock Connector to USB Cable
(not supplied)

To purchase this cable, consult your iPod/iPhone dealer.

2 Press [iPod]④ to select "IPOD".

The music menu screen is displayed.

e.g.

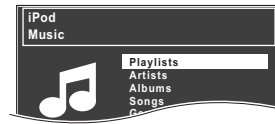

3 Press [▲, ▼]⑧ to select an item and press [OK]⑧.

- Press [◀, ▶]⑨ to skip page by page.
- To return to the previous screen, press [RETURN]⑩.

Play starts from the selected song.

e.g. playback screen

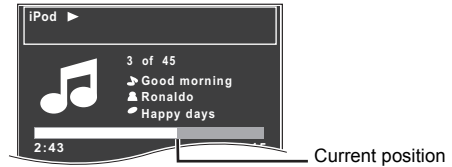

Basic controls

Button	Function
[▶] PLAY]⑤	Play
[■] STOP]⑤, [] PAUSE]⑤	Pause
[SKIP ◀◀, SKIP ▶▶]⑤	Skip
(press and hold) [SEARCH ◀◀, SEARCH ▶▶]⑤	Search

Other methods of playback

Shuffle mode

Press [PLAY MODE]⑥ several times. SHUFFLE SONGS, SHUFFLE ALBUMS, SHUFFLE OFF

Repeat mode

Press and hold [–REPEAT]⑥ and then press the button several times within a few seconds.

ONE REPEAT, ALL REPEAT, REPEAT OFF



Music playback modes set on the iPod/iPhone will be maintained when connected to the main unit. Changes made while the iPod/iPhone is connected to the main unit will be kept on the iPod/iPhone after disconnecting it.

About recharging the battery

- Recharging during standby mode: Ensure that the iPod/iPhone battery starts recharging before switching the main unit to standby mode.
- "IPOD *" will be shown on the main unit's display during iPod/iPhone charging in main unit standby mode.
- Check iPod/iPhone to see the battery charging condition.
- If you are not using iPod/iPhone for an extended period of time after recharging has completed, disconnect it from main unit, as the battery will be depleted naturally. (Once fully recharged, additional recharging will not occur.)

Compatible iPod/iPhone (as of November 2011)

- Update your iPod/iPhone with the latest software before using this unit.
- iPod/iPhone compatibility is based on the operations* described in this manual.
 - ※ Subject to the availability of the functions on your iPod/iPhone.
- Compatibility depends on the software version of your iPod/iPhone.

iPod touch® 1st, 2nd, 3rd, and 4th generation
iPod nano® 1st, 2nd, 3rd, 4th, 5th, and 6th generation
iPod classic®
iPod® 5th generation
iPhone® 4S, iPhone® 4, iPhone® 3GS, iPhone® 3G, iPhone®

In some locations, reception status of an iPhone may be poor when it is connected to this unit.

To use the iPod touch/iPhone features

- 1 Press the Home button on the iPod touch/iPhone.
- 2 Select the iPod touch/iPhone features on the touch screen to operate.



When the iPhone receives a call while connected to this unit, playback, etc. of the iPhone may stop.

To prioritize the operation with the iPhone connected to this unit, make the setting so that the iPhone does not receive calls.

Changing the player settings

- 1 Press [DVD]④ to select "DVD/CD".
- 2 Press [START]⑩ to show the START menu.
- 3 Press [▲, ▼]⑥ to select "Setup" and press [OK]⑧.

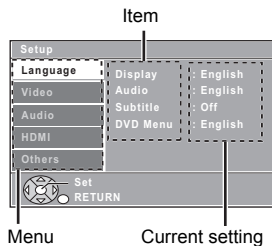

- 4 Press [▲, ▼]⑥ to select menu and press [OK]⑧.
- 5 Press [▲, ▼]⑥ to select the item and press [OK]⑧.
- 6 Press [▲, ▼]⑥ to make the settings and press [OK]⑧.

- To return to the previous screen, press [RETURN]⑫.
- To exit the screen, press [START]⑩.
- The settings remain intact even if you switch the unit to standby.
- Underlined items are the factory settings in the following menus.

Language menu

Display

Choose the language for the on-screen messages.

- English • Français • Español

Audio*

Choose the audio language.

- English • French • Spanish

Subtitle*

Choose the subtitle language.

- Auto • English • French • Spanish
- Off

DVD Menu*

Choose the language for disc menus.

- English • French • Spanish

- ※ Some discs start in a certain language despite any changes you make here.
- When the selected language is not available on the disc, the default language is played. There are discs where you can only switch the language from the menu screen (⇒ 11).

Video menu

TV Aspect

Choose the setting to suit your TV.

- 16:9: Widescreen TV (16:9)
- 4:3 Pan&Scan: Regular aspect TV (4:3)
The sides of the widescreen picture are cut off so it fills the screen (unless prohibited by the disc).
- 4:3 Letterbox: Regular aspect TV (4:3)
Widescreen picture is shown in the letterbox style.



Time Delay

When connected with a Plasma display, adjust if you notice the audio is out of sync with the video.

- 0ms/Auto • 20ms • 40ms • 60ms
- 80ms • 100ms

When using VIERA Link "HDMI Control" with "HDMI Control 3 or later" compatible TV (⇒ 14), select "0ms/Auto". Audio and video will automatically be set in sync.

Video Resolution

This works only when the HDMI connection is being used.

Select suitable picture quality for your TV.

(Video recordings will be converted to, and output as, high-definition video.)

- Auto • 480i • 480p • 720p
- 1080i • 1080p

Ensure that your TV can support the resolution that you choose.

If a message screen appears, confirm your selection by pressing [◀, ▶]⑥ to select "Yes" and press [OK]⑧. If the picture is distorted, wait for 15 seconds or press [◀, ▶]⑥ to select "No". To accept the setting, select "Yes" again.

HD JPEG Mode JPEG

(This works only when using HDMI connection with "Video Resolution" (⇒ above) set to "Auto", "720p", "1080i" or "1080p".)

- On: HD JPEG playback is available. (JPEG images will be displayed in original resolution.)
- Off

During HD JPEG playback, there will be no on-screen menus (⇒ 13) and on-screen displays.

Black Level

(This works only for video output from the VIDEO OUT terminal.)

Change the black level of the picture.

- Lighter
- Darker

Audio menu

Select to suit the type of equipment you connected to the HDMI AV OUT terminal.

Select "Bitstream" when the equipment can decode the bitstream (digital form of 5.1-channel data). Otherwise, select "PCM".

(If the bitstream is output to the equipment without a decoder, high levels of noise can be output and may damage your speakers and hearing.)

Digital Output

- Bitstream • PCM

When audio output is from HDMI AV OUT terminal, and the connected equipment does not support the item selected, the actual output will depend on the performance of this connected equipment.

Dynamic Range

- **On:** Adjusts for clarity even when the volume is low. Convenient for late night viewing. (Only works with Dolby Digital)
- **Off:** The full dynamic range of the signal is reproduced.

Speaker Settings

Select the delay time of the speakers.
(Effective only when "Surround layout (Recommended)" mode is selected in "Speaker layout" (⇒ 8, Easy setup).)
(Center and surround speakers only)
For optimum listening with 5.1-channel sound, all the speakers, except for the subwoofer, should be the same distance from the seating position.
If you have to place the center or surround speakers closer to the seating position, adjust the delay time to make up for the difference.

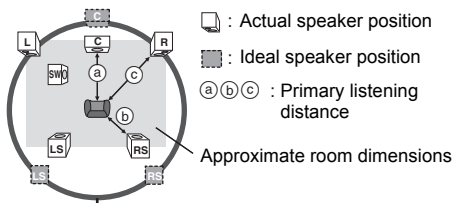

Circle of constant primary listening distance

If either distance (a) or (b) is less than (c), find the difference in the table and change to the recommended setting.

a) Center speaker		b) Surround speaker	
Difference (Approx.)	Setting	Difference (Approx.)	Setting
30 cm (1 foot)	1ms	150 cm (5 feet)	5ms
60 cm (2 feet)	2ms	300 cm (10 feet)	10ms
90 cm (3 feet)	3ms	450 cm (15 feet)	15ms
120 cm (4 feet)	4ms		
150 cm (5 feet)	5ms		

- **C Delay (Center Delay):**
0ms, 1ms, 2ms, 3ms, 4ms, 5ms
Select the delay time for your center speaker.
- **LS/RS Delay (Left Surround/Right Surround Delay):**
0ms, 5ms, 10ms, 15ms
Select the delay time for your surround speakers.
- **Test Tone:**
Use the test tone to listen to the speaker output to confirm speaker connections.
Test tone will be output to each channel in the following order:
Left, Center, Right, Surround Right, Surround Left, Subwoofer
To stop the test tone, press [RETURN]Ⓜ.

HDMI menu

VIERA Link

- **On:** The VIERA Link "HDMI Control" function is available (⇒ 14).
- **Off**

Audio Out

- **On:** When audio output is from the HDMI AV OUT terminal. (Depending on the capabilities of the connected equipment, audio output may differ from the audio settings of the main unit.)
- **Off:** When audio output is not from the HDMI AV OUT terminal. (The audio is output using the settings of the main unit.)

Power Off Link

Select the desired power off link setting of this unit for VIERA Link operation (⇒ 14). (This works depending on the settings of the connected VIERA Link "HDMI Control" compatible equipment.)

- **Video/Audio:** When the TV is turned off, this unit will turn off automatically.
- **Video:** When the TV is turned off, this unit will turn off except during the following conditions:
 - audio playback (CD)
 - iPod/iPhone mode
 - radio mode
 - "AUX", "ARC" or "D-IN" mode (non-selected TV audio setting for VIERA Link)

TV Audio

Select the TV audio input to work with the VIERA Link operations (⇒ 14).

- **AUX**
- **ARC**
- **DIGITAL IN**

Others menu

Slide Show Time

Set the speed of the slideshow.

- **3 Seconds**
- **5 Seconds**
- **10 Seconds**
- **15 Seconds**

Easy setup

You can execute basic settings to optimize your home theater system. (⇒ 8)

FL Dimmer

Change the brightness of the unit's display.

- **Bright**
- **Dim:** The display is dimmed.
- **Auto:** The display is dimmed, but brightens when you perform some operations.

FL Control

- **On (VOL 0):** The unit's display will turn off when the volume is adjusted to "0".

- **Off**

Screen Saver

This is to prevent burn marks on the TV screen.

- **Off**
- **Wait 5 min:** If there is no operation for 5 minutes, the screen saver will be shown. The TV screen will resume when you perform some operations. (This does not work during playback.)

Ratings

Set a rating level to limit DVD-Video play.

Setting ratings (When level 8 is selected)

- 1 to 7
- **8 No Limit**

When you select your ratings level, a password screen is shown.

The default password is "0000".

Enter the 4-digit password with the numbered buttons, and press [OK]Ⓜ. You can change the default password (⇒ below)

Do not forget your password.

A message screen will be shown if a DVD-Video disc exceeding the rating level is inserted in the unit.

Follow the on-screen instructions.

Set Password

Change the password for "Ratings".

When you change the password for the first time:

The default password is "0000".

Follow the on-screen instructions.

Restore Default Settings



This returns all values in the Setup menu to the default settings except the password and ratings level.

Press [◀, ▶]Ⓜ to select "Yes" and press [OK]Ⓜ.



Turn the unit off and on again.

Discs that can be played

Commercial discs

Type of media/ Logo	Remarks	Indicated as
DVD-Video 	High quality movie and music discs	DVD-V
Video CD 	Music discs with video Including SVCD (Conforming to IEC62107)	VCD
CD 	Music discs	CD

Recorded discs

Type of media/ Logo	Formats	Indicated as
DVD-R/RW  	<ul style="list-style-type: none"> DVD-Video Format JPEG format 	DVD-V JPEG
DVD-R DL 	<ul style="list-style-type: none"> DVD-Video Format 	DVD-V
+R/+RW/+R DL	<ul style="list-style-type: none"> +VR (+R/+RW Video Recording) Format 	DVD-V
CD-R/RW	<ul style="list-style-type: none"> CD-DA format JPEG format 	CD JPEG

- Before playback, finalize the disc on the device it was recorded on.
- It may not be possible to play all the above-mentioned discs in some cases due to the type of disc, the condition of the recording, the recording method, or how the files were created (⇒ right, Tips for making data discs).

Note about using a DualDisc

The digital audio content side of a DualDisc does not meet the technical specifications of the Compact Disc Digital Audio (CD-DA) format so playback may not be possible.

Discs that cannot be played

Blu-ray Discs, HD DVD, AVCHD discs, DVD-RW version 1.0, DVD-Audio, DVD-ROM, DVD-VR, CD-ROM, CDV, CD-G, SACD, MP3 discs, WMA discs, DivX discs and Photo CD, DVD-RAM, and "Chaoji VCD" available on the market including CVD, DVCD and SVCD that do not conform to IEC62107.

Region number

DVD-V

The player plays DVD-Video marked with labels containing the region number "1" or "ALL".

e.g.



Disc handling precautions

- Do not attach labels or stickers to discs. This may cause disc warping, rendering it unusable.
- Do not write on the label side with a ball-point pen or other writing instrument.
- Do not use record cleaning sprays, benzene, thinner, liquids which prevent static electricity, or any other solvent.
- Do not use scratch-proof protectors or covers.
- Do not use the following discs:
 - Discs with exposed adhesive from removed stickers or labels (rented discs, etc.).
 - Discs that are badly warped or cracked.
 - Irregularly shaped discs, such as heart shapes.

Tips for making data discs

JPEG (Extension: ".JPG", ".jpg", ".JPEG", ".jpeg")

Disc: DVD-R/RW, CD-R/RW

- JPEG files taken on a digital camera that conform to DCF Standard (Design rule for Camera File system) Version 1.0 are displayed.
 - Files that have been altered, edited or saved with computer picture editing software may not be displayed.
- This unit cannot display moving pictures, MOTION JPEG and other such formats, still pictures other than JPEG (e.g. TIFF), or play pictures with attached audio.

- There may be differences in the display order on the menu screen and computer screen.
- This unit cannot play files recorded using packet write.

DVD-R/RW

- Discs must conform to UDF bridge (UDF 1.02/ISO9660).
- This unit does not support multi-session. Only the default session is played.

CD-R/RW

- Discs must conform to ISO9660 level 1 or 2 (except for extended formats).
- This unit supports multi-session but if there are many sessions it takes more time for play to start. Keep the number of sessions to a minimum to avoid this.

Maintenance

Clean this unit with a soft, dry cloth

- Never use alcohol, paint thinner or benzene to clean this unit.
- Before using chemically treated cloth, carefully read the instructions that came with the cloth.

Do not use commercially available lens cleaners as they may cause malfunction. Cleaning of the lens is generally not necessary although this depends on the operating environment.

Before moving the unit, ensure the disc tray is empty. Failure to do so will risk severely damaging the disc and the unit.

Speaker installation option

Attaching to a wall

You can attach all of the speakers (except subwoofer) to a wall.

- The wall or pillar on which the speakers are to be attached should be capable of supporting 10 kg (22 lbs) per screw. Consult a qualified building contractor when attaching the speakers to a wall. Improper attachment may result in damage to the wall and speakers, and personal injury.

1 Drive a screw (not supplied) into the wall.

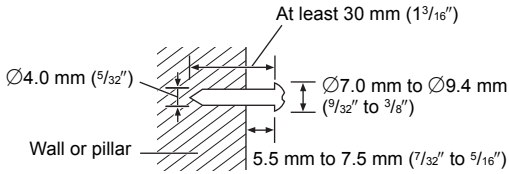

2 Fit the speaker securely onto the screw(s) with the hole(s).

e.g., Surround speaker	
DO NOT	DO
<ul style="list-style-type: none"> • In this position, the speaker will likely fall if moved to the left or right. 	<ul style="list-style-type: none"> • Move the speaker so that the screw is in this position.

■ Tips

Use the measurements indicated below to identify the screwing positions on the wall.

- Leave at least 20 mm (25/32") of space above the speaker and 10 mm (13/32") on each side to allow enough space for fitting the speaker.

Front/Surround speaker

Center speaker

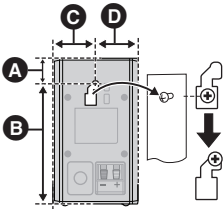

- A 24 mm (15/16")
- B 116 mm (49/16")
- C 40 mm (1 9/16")
- D 40 mm (1 9/16")

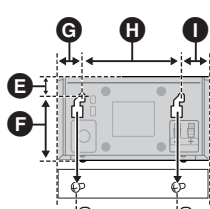

- E 18 mm (23/32")
- F 65 mm (2 9/16")
- G 24 mm (1 5/16")
- H 95.5 mm (3 25/32")
- I 27 mm (1 1/16")

■ To prevent speakers from falling

Front speaker, Surround speaker, Center speaker

e.g. Front speaker

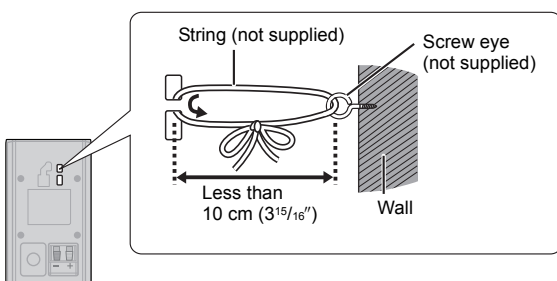

Troubleshooting guide

Before requesting service, make the following checks. If you are in doubt about some of the check points, or if the solutions indicated in the following guide do not solve the problem, refer to "Customer Services Directory (United States and Puerto Rico)" on page 23.

Power

No power.

Insert the AC power supply cord securely. (⇒ 8)

The unit is automatically switched to standby mode.

- The Sleep timer was working and had reached the set time limit. (⇒ 4)
- The main unit will automatically switch to standby mode after 30 minutes of inactivity. (⇒ 4)

Power of this unit is turned off when the input for the TV is changed.

This is normal when using VIERA Link "HDMI Control 4 or later". For details please read the operating instructions for the TV.

General operation

No response when any buttons are pressed.

- This unit cannot play discs other than the ones listed in this Owner's Manual. (⇒ 18)
- The unit may not be operating properly due to lightning, static electricity or some other external factor. Turn the unit off and then back on. Alternatively, turn the unit off, disconnect the AC power supply cord, and then reconnect it.
- Condensation has formed. Wait 1 to 2 hours for it to evaporate.

No response when remote control buttons are pressed.

- Check that the battery is installed correctly. (⇒ 8)
- The battery is depleted. Replace it with a new one. (⇒ 8)
- Aim the remote control at the remote control signal sensor and operate. (⇒ 4)

Other products respond to the remote control.

Change the remote control operating mode. (⇒ 4)

Cannot display the START menu.

Remove the disc and then press [START] again.

No picture or sound.

- Check the video or speaker connection. (⇒ 6, 7)
- Check the power or input setting of the connected equipment and the main unit.
- Check that the disc has something recorded on it.
- During HD JPEG playback, there will be no video output from the VIDEO OUT terminal.

No on-screen menus/displays.

JPEG This is normal during HD JPEG playback.

You have forgotten your ratings password.

Reset all the settings to Factory Preset.

While "DVD/CD" is the source and there is no disc inserted, press and hold [▲ OPEN/CLOSE] on the main unit and [≧10] on the remote control until "RESET" appears on the main unit's display. Turn the unit off and on again.

All settings will return to the default values.

Some characters are not displayed correctly.

Characters other than English alphabet and Arabic numerals may not be displayed correctly.

The VIERA Link "HDMI Control" function does not respond.

Depending on the condition of this unit or the connected equipment, it may be necessary to repeat the same operation so that the function can work correctly. (⇒ 14)

The setting you made in "TV Aspect" (⇒ 16, Video menu) or "Display" (⇒ 16, Language menu) does not work.

The settings for "TV Aspect" and "Display" will automatically follow the information from the TV. (⇒ 8, Easy setup)

- ※1 When using VIERA Link "HDMI Control" with "HDMI Control 3 or later" compatible TV
- ※2 When using VIERA Link "HDMI Control" with "HDMI Control 2 or later" compatible TV

Disc operation

A menu screen appears during skip or search. [VCD]

This is normal for Video CDs.

Playback control menu does not appear.

[VCD] with playback control

Press [MENU]Ⓜ to change to PBC on and then press [RETURN]Ⓜ during playback.

Play does not start.

If a disc contains CD-DA and other formats, proper playback may not be possible.

No subtitles.

Display the subtitles. ("Subtitle" in Menu 1) (⇒ 13)

Point B is automatically set.

The end of an item becomes point B when it is reached.

The Setup menu cannot be accessed.

Select "DVD/CD" as the source.

Sound

Sound is distorted.

The format (sampling frequency, etc.) of the digital audio input is not supported by this unit.

Effects do not work.

Some audio effects do not work or have less effect with some discs.

Humming is heard during play.

An AC power supply cord or fluorescent light is near the main unit. Keep other appliances and cables away from the main unit.

No sound.

- There may be a slight pause in sound when you change the play speed.
- If the input source is bitstream, set the sound setting to PCM on the external equipment.
- When using the HDMI output, audio may not output from other terminals.

No sound from the TV.

- If the TV is not ARC compatible and only the HDMI connection is used, an extra audio connection is necessary. (⇒ 7)
- Confirm the audio connection. Press [EXT-IN]④ to select the corresponding source. (⇒ 7, 9)
- When using the HDMI connection, ensure that "Audio Out" in the HDMI menu is set to "On". (⇒ 17)

No sound from the surround speakers.

- When using the "Surround layout (Recommended)" mode, press [SURROUND]Ⓜ to select "MULTI-CH". (⇒ 10)
- When using the "Front layout (Alternative)" mode, press [SURROUND]Ⓜ to select "A.SRD". (⇒ 10)

Picture

The picture on the TV is not displayed correctly or disappears.

- Ensure that the unit is connected directly to the TV, and is not connected through a VCR. (⇒ 7)
- Mobile telephone chargers can cause some disturbance.
- If you are using an indoor TV antenna, change to an outdoor antenna.
- The TV antenna wire is too close to the unit. Move it away from the unit.
- Reduce the number of connected HDMI devices.
- When using the HDMI AV OUT terminal, ensure that an incompatible video output with the connected TV is not selected. Set the "Video Resolution" in Video menu to "480p". (⇒ 16)
- Video images converted to 1920×1080 resolution may look different from the true native 1080p full-HD sources. This is not a malfunction of the main unit.

Picture size does not fit the screen.

- Change "TV Aspect" in the Video menu. (⇒ 16)
- Use the TV to change the aspect.
- Change the zoom setting. ("Zoom" in Menu 2) (⇒ 13)
- [JPEG] This is normal during HD JPEG playback. Set "HD JPEG Mode" to "Off" if you want to perform zoom function. (⇒ 16)

Menu is not displayed correctly.

Restore the zoom ratio to "Normal". ("Zoom" in Menu 2) (⇒ 13)

Display is distorted.

[JPEG] This is normal when the display switches to/from HD JPEG playback.

iPod/iPhone operation

Cannot charge or operate.

- Check the iPod/iPhone connection. (⇒ 15)
- The battery of the iPod/iPhone is depleted. Charge the iPod/iPhone, and then operate again.
- The main unit was switched to standby mode. (When recharging the iPod/iPhone battery, ensure recharging starts before switching the main unit to standby mode.)

HDMI progressive video

There is ghosting when HDMI progressive output is on.

This problem is caused by the editing method or material used on DVD-Video, but should be corrected if you use interlaced output. When using the HDMI AV OUT terminal, set "Video Resolution" in Video menu to "480i". Or, disable the HDMI connection and use the other video connection. (⇒ 7, 16)

Closed captions not displayed.

When HDMI progressive output is used, closed captions will not be displayed.

Radio

Distorted sound or noise is heard.

Adjust the position of the FM antenna.

A beat sound is heard.

Try to keep a certain amount of distance between the antenna and the TV.

Stations cannot be selected.

Change the FM frequency step.

- 1 Press [RADIO]④ to select "FM".
- 2 Press and hold [▲ OPEN/CLOSE]Ⓜ on the main unit. After a few seconds the display changes to show the current lowest frequency. Continue to hold the button down. The lowest frequency changes and the step is changed.

If noise is excessive.

Change the audio to be output as monaural. Press and hold [PLAY MODE]Ⓜ to select "MONO". The sound becomes monaural.

- To cancel the mode, press and hold the button again until "AUTO ST" is displayed. (The mode is also cancelled when you change the frequency.)

In normal circumstances, select "AUTO ST".

Messages

The following messages or service numbers may appear on the TV or unit's display.

TV displays

“”

The operation is prohibited by the unit or disc.

“ Incorrect Disc Region”

Only DVD-Video discs that include or have the same region number as the one on the rear panel of this unit can be played. (⇒ 18)

Unit displays

“NO PLAY”

- You inserted a disc the unit cannot play; insert one it can. (⇒ 18)
- You inserted a blank disc.
- You inserted a disc that has not been finalized.

“NO DISC”

- You have not inserted a disc; insert one.
- You have not inserted the disc correctly; insert it correctly. (⇒ 11)

“IPOD OVER CURRENT ERROR”

The iPod/iPhone is drawing too much power. Remove the iPod/iPhone, and turn the unit off and on again.

“F61”

Check and correct the speaker cable connections. If this does not fix the problem, consult the dealer. (⇒ 6)

“F76”

There is a power supply problem. Consult the dealer.

“DVD U11”

Disc may be dirty. Wipe it clean.

“SET OK”

“SET OK” is displayed when the stations are set, and the radio tunes to the last preset station.

“ERROR”

- Incorrect operation performed. Read the instructions and try again.
- “ERROR” is displayed when automatic presetting is unsuccessful. Preset the stations manually.

“TUNED/STEREO”

Displayed when receiving stereo broadcasting.

“TUNED”

Displayed when receiving monaural broadcasting or monaural sound is selected.

“DVD H□□”

“DVD F□□□”

□ stands for a number.

- Trouble may have occurred. The numbers following “H” and “F” depend on the status of the unit. Turn the unit off and then back on. Alternatively, turn the unit off, disconnect the AC power supply cord, and then reconnect it.
- If the service numbers fail to clear, note the service number and contact a qualified service person.

“U70□”

□ stands for a number. (The actual number following “U70” will depend on the state of the main unit.)

- The HDMI connection acts unusually.
 - The connected equipment is not HDMI-compatible.
 - Use the High Speed HDMI Cables.
 - The HDMI cable is too long.
 - The HDMI cable is damaged.

“REMOTE 1” or “REMOTE 2”

Match the modes on the main unit and remote control. Depending on the number being displayed (“1” or “2”), press and hold [OK]Ⓞ and the corresponding numbered button ([1] or [2]) for at least 2 seconds. (⇒ 4)

“LOADING”

- The iPod/iPhone is not ready. Wait for this display to disappear.
- Disconnect the iPod/iPhone, and then reconnect it firmly. (⇒ 15)

Licenses

Manufactured under license from Dolby Laboratories. Dolby, Pro Logic, and the double-D symbol are trademarks of Dolby Laboratories.

Manufactured under license under U.S. Patent Nos: 5,956,674; 5,974,380; 6,487,535 & other U.S. and worldwide patents issued & pending. DTS, the Symbol, & DTS and the Symbol together are registered trademarks & DTS Digital Surround and the DTS logos are trademarks of DTS, Inc. Product includes software. © DTS, Inc. All Rights Reserved.

This item incorporates copy protection technology that is protected by U.S. patents and other intellectual property rights of Rovi Corporation. Reverse engineering and disassembly are prohibited.

HDMI, the HDMI Logo, and High-Definition Multimedia Interface are trademarks or registered trademarks of HDMI Licensing LLC in the United States and other countries.

HDAVI Control™ is a trademark of Panasonic Corporation.

VIERA Link™ is a trademark of Panasonic Corporation.

EZ Sync™ is a trademark of Panasonic Corporation.



“Made for iPod” and “Made for iPhone” mean that an electronic accessory has been designed to connect specifically to iPod, or iPhone, respectively, and has been certified by the developer to meet Apple performance standards.

Apple is not responsible for the operation of this device or its compliance with safety and regulatory standards.

Please note that the use of this accessory with iPod, or iPhone may affect wireless performance.

iPhone, iPod, iPod classic, iPod nano, and iPod touch are trademarks of Apple Inc., registered in the U.S. and other countries.

“DVD Logo” is a trademark of DVD Format/Logo Licensing Corporation.

Specifications

AMPLIFIER SECTION

RMS Output Power: Dolby Digital Mode

Front Ch	160 W per channel (3 Ω), 1 kHz, 10 % THD
Surround Ch	160 W per channel (3 Ω), 1 kHz, 10 % THD
Center Ch	160 W per channel (3 Ω), 1 kHz, 10 % THD
Subwoofer Ch	200 W per channel (3 Ω), 100 Hz, 10 % THD
Total RMS Dolby Digital mode power	1000 W

FTC Output Power: Dolby Digital Mode

Front Ch	60 W per channel (3 Ω), 150 Hz to 20 kHz, 1 % THD
Surround Ch	60 W per channel (3 Ω), 150 Hz to 20 kHz, 1 % THD
Center Ch	90 W per channel (3 Ω), 150 Hz to 20 kHz, 1 % THD
Subwoofer Ch	100 W per channel (3 Ω), 50 Hz to 150 Hz, 1 % THD
Total FTC Dolby Digital mode power	430 W

FM TUNER, TERMINALS SECTION

Preset Memory FM 30 stations

Frequency Modulation (FM)

Frequency range	87.9 MHz to 107.9 MHz (200-kHz step) 87.5 MHz to 108.0 MHz (100-kHz step)
Antenna terminals	75 Ω (unbalanced)

Digital audio input

Optical digital input	Optical terminal
Sampling frequency	32 kHz, 44.1 kHz, 48 kHz

DISC SECTION

Discs played [8 cm (3") or 12 cm (5")]

- (1) DVD (DVD-Video)
 - (2) DVD-R (DVD-Video, JPEG^{#2,3})
 - (3) DVD-R DL (DVD-Video)
 - (4) DVD-RW (DVD-Video, JPEG^{#2,3})
 - (5) +R/+RW (Video)
 - (6) +R DL (Video)
 - (7) CD, CD-R/RW (CD-DA, Video CD, SVCD^{#1}, JPEG^{#2,3})
- ※1 Conforming to IEC62107
 ※2 Exif Ver 2.1 JPEG Baseline files
 Picture resolution:
 16:9 min. size 4×4, max. size (720×8)×(405×8);
 4:3 min. size 4×4, max. size (720×8)×(540×8)
 ※3 The total combined maximum number of recognizable picture contents and groups: 2600 picture contents and 259 groups.
 (Excluding Root folder)

Pick up

Wavelength (DVD/CD)	655/790 nm
Laser power	CLASS II/CLASS Iia

Audio output (Disc)

Number of channels	5.1 ch (FL, FR, C, SL, SR, SW)
--------------------	--------------------------------

VIDEO SECTION

Video system NTSC

Composite video output

Output level	1 Vp-p (75 Ω)
Terminal	Pin jack (1 system)

HDMI AV output

Terminal	19-pin type A connector
----------	-------------------------

HDAVI Control

This unit supports "HDAVI Control 5" function.

SPEAKER SECTION

Front speakers SB-HF171

Type	1 way, 1 speaker system (Bass reflex)
Speaker unit(s)	Impedance 3 Ω
Full range	6.5 cm (2 1/2") Cone type
Output sound pressure	78 dB/W (1 m)
Frequency range	97 Hz to 25 kHz (−16 dB) 130 Hz to 22 kHz (−10 dB)
Dimensions (W×H×D)	80 mm×139 mm×70 mm (3 ⁹ / ₃₂ "×5 ¹⁵ / ₃₂ "×2 ³ / ₄ "
Mass [Weight]	0.37 kg (0.82 lbs)

Surround speakers SB-HS171

Type	1 way, 1 speaker system (Bass reflex)
Speaker unit(s)	Impedance 3 Ω
Full range	6.5 cm (2 1/2") Cone type
Output sound pressure	78 dB/W (1 m)
Frequency range	97 Hz to 25 kHz (−16 dB) 130 Hz to 22 kHz (−10 dB)
Dimensions (W×H×D)	80 mm×139 mm×70 mm (3 ⁹ / ₃₂ "×5 ¹⁵ / ₃₂ "×2 ³ / ₄ "
Mass [Weight]	0.37 kg (0.82 lbs)

Center speaker SB-HC171

Type	1 way, 1 speaker system (Bass reflex)
Speaker unit(s)	Impedance 3 Ω
Full range	6.5 cm (2 1/2") Cone type
Output sound pressure	79 dB/W (1 m)
Frequency range	90 Hz to 25 kHz (−16 dB) 130 Hz to 22 kHz (−10 dB)
Dimensions (W×H×D)	146.5 mm×84 mm×78 mm (5 ¹⁵ / ₁₆ "×3 ⁵ / ₁₆ "×3 ¹ / ₁₆ "
Mass [Weight]	0.5 kg (1.1 lbs)

Subwoofer SB-HW190

Type	1 way, 1 speaker system (Bass reflex)
Speaker unit(s)	Impedance 3 Ω
Woofer	16 cm (6 1/2") Cone type
Output sound pressure	78 dB/W (1 m)
Frequency range	40 Hz to 220 Hz (−16 dB) 45 Hz to 180 Hz (−10 dB)
Dimensions (W×H×D)	145 mm×289.5 mm×259 mm (5 ²³ / ₃₂ "×11 ¹³ / ₃₂ "×10 ³ / ₁₆ "
Mass [Weight]	3 kg (6.6 lbs)

GENERAL

Power supply	AC 120 V, 60 Hz
Power consumption	Main unit 75 W
Dimensions (W×H×D)	430 mm×47 mm×263 mm (16 ¹⁵ / ₁₆ "×1 ²⁷ / ₃₂ "×10 ¹¹ / ₃₂ "
Mass [Weight]	Main unit 2.4 kg (5.3 lbs)
Operating temperature range	0 °C to +40 °C (+32 °F to +104 °F)
Operating humidity range	35 % to 80 % RH (no condensation)

Power consumption in standby mode	approx. 0.2 W
--	---------------



- 1 Specifications are subject to change without notice.
Mass and dimensions are approximate.
- 2 Total harmonic distortion is measured by a digital spectrum analyzer.

Limited Warranty

Panasonic Consumer Marketing Company of North America,
Division of Panasonic Corporation of North America
One Panasonic Way, Secaucus, New Jersey 07094

Panasonic Home Audio Products Limited Warranty

Limited Warranty Coverage (For USA and Puerto Rico Only)

If your product does not work properly because of a defect in materials or workmanship, Panasonic Consumer Marketing Company of North America (referred to as "the warrantor") will, for the length of the period indicated on the chart below, which starts with the date of original purchase ("warranty period"), at its option either (a) repair your product with new or refurbished parts, (b) replace it with a new or a refurbished equivalent value product, or (c) refund your purchase price. The decision to repair, replace or refund will be made by the warrantor.

Product or Part Name	Parts	Labor
Audio Products (except items below)	1 year	1 year
DVD Home Theater System	1 year	1 year
Home Theater Audio System	1 year	1 year
SD Memory Cards, Rechargeable Battery Packs (defective exchange)	90 days	Not Applicable

During the "Labor" warranty period there will be no charge for labor. During the "Parts" warranty period, there will be no charge for parts. This Limited Warranty excludes both parts and labor for non-rechargeable batteries, antennas, and cosmetic parts (cabinet). This warranty only applies to products purchased and serviced in the United States or Puerto Rico. This warranty is extended only to the original purchaser of a new product which was not sold "as is".

Carry-In or Mail-In Service

To find a service center please visit <http://www.panasonic.com/help> or call 1-800-211-PANA (7262).

When shipping the unit, carefully pack, include all supplied accessories listed in the Owner's Manual, and send it prepaid, adequately insured and packed well in a carton box. When shipping Lithium Ion batteries please visit our Web Site at www.panasonic.com/BatteryHandling as Panasonic is committed to providing the most up to date information. Include a letter detailing the complaint, a return address and provide a daytime phone number where you can be reached. A valid registered receipt is required under the Limited Warranty.

IF REPAIR IS NEEDED DURING THE WARRANTY PERIOD, THE PURCHASER WILL BE REQUIRED TO FURNISH A SALES RECEIPT/ PROOF OF PURCHASE INDICATING DATE OF PURCHASE, AMOUNT PAID AND PLACE OF PURCHASE. CUSTOMER WILL BE CHARGED FOR THE REPAIR OF ANY UNIT RECEIVED WITHOUT SUCH PROOF OF PURCHASE.

Limited Warranty Limits And Exclusions

This warranty ONLY COVERS failures due to defects in materials or workmanship, and DOES NOT COVER normal wear and tear or cosmetic damage. The warranty ALSO DOES NOT COVER damages which occurred in shipment, or failures which are caused by products not supplied by the warrantor, or failures which result from accidents, misuse, abuse, neglect, mishandling, misapplication, alteration, faulty installation, set-up adjustments, misadjustment of consumer controls, improper maintenance, power line surge, lightning damage, modification, introduction of sand, humidity or liquids, commercial use such as hotel, office, restaurant, or other business or rental use of the product, or service by anyone other than a Factory Service Center or other Authorized Servicer, or damage that is attributable to acts of God.

THERE ARE NO EXPRESS WARRANTIES EXCEPT AS LISTED UNDER "LIMITED WARRANTY COVERAGE". THE WARRANTOR IS NOT LIABLE FOR INCIDENTAL OR CONSEQUENTIAL DAMAGES RESULTING FROM THE USE OF THIS PRODUCT, OR ARISING OUT OF ANY BREACH OF THIS WARRANTY. (As examples, this excludes damages for lost time, travel to and from the servicer, loss of or damage to media or images, data or other memory or recorded content. The items listed are not exclusive, but for illustration only.)

ALL EXPRESS AND IMPLIED WARRANTIES, INCLUDING THE WARRANTY OF MERCHANTABILITY, ARE LIMITED TO THE PERIOD OF THE LIMITED WARRANTY.

Some states do not allow the exclusion or limitation of incidental or consequential damages, or limitations on how long an implied warranty lasts, so the exclusions may not apply to you. This warranty gives you specific legal rights and you may also have other rights which vary from state to state. If a problem with this product develops during or after the warranty period, you may contact your dealer or Service Center. If the problem is not handled to your satisfaction, then write to the warrantor's Consumer Affairs Department at the addresses listed for the warrantor.

PARTS AND SERVICE, WHICH ARE NOT COVERED BY THIS LIMITED WARRANTY, ARE YOUR RESPONSIBILITY.

Customer Services Directory (United States and Puerto Rico)

Obtain Product Information and Operating Assistance; locate your nearest Dealer or Service Center; purchase Parts and Accessories; or make Customer Service and Literature requests by visiting our Web Site at:

<http://www.panasonic.com/help>

or, contact us via the web at:

<http://www.panasonic.com/contactinfo>

You may also contact us directly at:

1-800-211-PANA (7262)

Monday-Friday 9am-9pm, Saturday-Sunday 10am-7pm EST

For hearing or speech impaired TTY users, TTY: 1-877-833-8855

Accessory Purchases (United States and Puerto Rico)

Purchase Parts, Accessories and Instruction Books online for all Panasonic Products by visiting our Web Site at:

<http://www.pstc.panasonic.com>

Or, send your request by E-mail to:

nppcparts@us.panasonic.com

You may also contact us directly at:

1-800-332-5368 (Phone) 1-800-237-9080 (Fax Only)

(Monday-Friday 9am-9pm EST)

Panasonic National Parts Center

20421 84th Ave. S., Kent, WA 98032

(We accept Visa, MasterCard, Discover Card, American Express)

For hearing or speech impaired TTY users, TTY: 1-866-605-1277

As of January 2012

CAUTION	- LASER RADIATION WHEN OPEN. DO NOT STARE INTO BEAM. FDA 21 CFR / Class II
CAUTION	- CLASS 1M INVISIBLE AND INVISIBLE LASER RADIATION WHEN OPEN. DO NOT VIEW DIRECTLY WITH OPTICAL INSTRUMENTS. RECORDS-1 +A2/ Class 1M
VARNING	- KLAS 1M SYNLIG OCH OSYNLIG LASERSTRÅLNING NÄR DENNA DEL ÄR ÖPPNAD. BETRÄKTA EJ STRÅLEN DIREKT GENOM OPTISKA INSTRUMENTEN.
FORSIGTIG	- SYNLIG OG USYNLIG LASERSTRÅLING KLASSE 1M. NÄR LÅGET ER ÅBENT, UNDSKÅ AT SE I SEJRE PÅ MED OPTISKE INSTRUMENTER.
VARO!	- HUHTAESSA OLET ALTIIVIA LUOKAN 1M NÄKYVÄÄ JA NÄKYMÄTÖNTÄ, LASERSÄTELYÄ, ÄLÄ KATSO OPTISILLA LAITTEILLA SUORAAN SÄTEESEEN.
VORSICHT	- SICHTBARE UND UNSICHTBARE LASERSTRAHLUNG KLASSE 1M. WENN ABDECKUNG GEÖFFNET, NICHT DIREKT MIT OPTISCHEN INSTRUMENTEN BETRACHTEN.
ATTENTION	- RAYONNEMENT LASER VISIBLE ET INVISIBLE. CLASSE 1M. EN CAS D'OUVERTURE, NE PAS REGARDER DIRECTEMENT À L'AIDE D'INSTRUMENTS D'OPTIQUE.
PRECAUCIÓN	- RADIACION LASER VISIBLE E INVISIBLE DE CLASE 1M AL ESTAR ABIERTO. NO VEA DIRECTAMENTE CON INSTRUMENTOS OPTICOS.

(Inside of product)

User memo:

DATE OF PURCHASE _____
DEALER NAME _____
DEALER ADDRESS _____

TELEPHONE NUMBER _____

The model number and serial number of this product can be found on either the back or the bottom of the unit. Please note them in the space provided below and keep for future reference.

SC-XH170

MODEL NUMBER _____
SERIAL NUMBER _____

-If you see this symbol-

Information on Disposal in other Countries outside the European Union



This symbol is only valid in the European Union. If you wish to discard this product, please contact your local authorities or dealer and ask for the correct method of disposal.



As an ENERGY STAR® Partner, Panasonic has determined that this product meets the ENERGY STAR® guidelines for energy efficiency.

FCC Note:

This equipment has been tested and found to comply with the limits for a Class B digital device, pursuant to Part 15 of the FCC Rules. These limits are designed to provide reasonable protection against harmful interference in a residential installation. This equipment generates, uses and can radiate radio frequency energy and, if not installed and used in accordance with the instructions, may cause harmful interference to radio communications. However, there is no guarantee that interference will not occur in a particular installation. If this equipment does cause harmful interference to radio or television reception, which can be determined by turning the equipment off and on, the user is encouraged to try to correct the interference by one or more of the following measures:

- Reorient or relocate the receiving antenna.
- Increase the separation between the equipment and receiver.
- Connect the equipment into an outlet on a circuit different from that to which the receiver is connected.
- Consult the dealer or an experienced radio/TV technician for help.

Any unauthorized changes or modifications to this equipment would void the user's authority to operate this device.

This device complies with Part 15 of the FCC Rules. Operation is subject to the following two conditions: (1) This device may not cause harmful interference, and (2) this device must accept any interference received, including interference that may cause undesired operation.

Responsible Party:
 Panasonic Corporation of North America
 One Panasonic Way, Secaucus, NJ 07094

Support Contact:
 Panasonic Consumer Marketing Company of North America
 Telephone No.: 1-800-211-PANA (7262)

Panasonic Consumer Marketing
 Company of North America,
 Division of Panasonic Corporation of
 North America
 One Panasonic Way, Secaucus,
 New Jersey 07094
<http://www.panasonic.com>

En