



RCA

TV/VCR/DVD User's Guide

Changing Entertainment. Again.



	CAUTION RISK OF ELECTRIC SHOCK DO NOT OPEN	
CAUTION: TO REDUCE THE RISK OF ELECTRIC SHOCK, DO NOT REMOVE COVER (OR BACK). NO USER-SERVICEABLE PARTS INSIDE. REFER SERVICING TO QUALIFIED SERVICE PERSONNEL.		



The lightning flash with arrowhead symbol, within an equilateral triangle is intended to alert the user to the presence of uninsulated dangerous voltage within the product's enclosure that may be of sufficient magnitude to constitute a risk of electric shock to persons.



The exclamation point within an equilateral triangle is intended to alert the user to the presence of important operating and maintenance (servicing) instructions in the literature accompanying the appliance.

WARNING: TO REDUCE THE RISK OF FIRE OR ELECTRIC SHOCK, DO NOT EXPOSE THIS APPLIANCE TO RAIN OR MOISTURE.
CAUTION: TO PREVENT ELECTRIC SHOCK DO NOT USE THIS POLARIZED PLUG WITH AN EXTENSION CORD, RECEPTACLE OR OTHER OUTLET UNLESS THE BLADES CAN BE FULLY INSERTED TO PREVENT BLADE EXPOSURE.

WARNING: This equipment has been tested and found to comply with the limits for a Class B digital device, pursuant to Part 15 of the FCC Rules. These limits are designed to provide reasonable protection against harmful interference in a residential installation. This equipment generates, uses and can radiate radio frequency energy and, if not installed and used in accordance with the instructions, may cause harmful interference to radio communications. However, there is no guarantee that interference will not occur in a particular installation. If this equipment does cause harmful interference to radio or television reception, which can be determined by turning the equipment off and on, the user is encouraged to try to correct the interference by one or more of the following measures:

- Reorient or relocate the receiving antenna.
- Increase the separation between the equipment and receiver.
- Connect the equipment into an outlet on a circuit different from that to which the receiver is connected.
- Consult the dealer or an experienced radio/TV technician for help.

CAUTION: Changes or modifications not expressly approved by the party responsible for compliance with the FCC Rules could void the user's authority to operate this equipment.

CAUTION: THIS DIGITAL VIDEO PLAYER EMPLOYS A LASER SYSTEM.
TO ENSURE PROPER USE OF THIS PRODUCT, PLEASE READ THIS USER'S GUIDE CAREFULLY AND RETAIN FOR FUTURE REFERENCE. SHOULD THE UNIT REQUIRE MAINTENANCE, CONTACT AN AUTHORIZED SERVICE LOCATION-SEE SERVICE PROCEDURE.
USE OF CONTROLS, ADJUSTMENTS OR THE PERFORMANCE OF PROCEDURES OTHER THAN THOSE SPECIFIED HEREIN MAY RESULT IN HAZARDOUS RADIATION EXPOSURE.
TO PREVENT DIRECT EXPOSURE TO LASER BEAM, DO NOT TRY TO OPEN THE ENCLOSURE. VISIBLE LASER RADIATION MAY BE PRESENT WHEN THE ENCLOSURE IS OPENED. DO NOT STARE INTO BEAM.

Product Registration

Please fill out the product registration card (packed separately) and return it immediately. For U.S. customers: Your RCA Consumer Electronics product may also be registered at www.rca.com/productregistration. Registering this product allows us to contact you if needed.

Product Information

Keep your sales receipt to obtain warranty parts and service and for proof of purchase. Attach it here and record the serial and model numbers. These numbers are located on the product.

Model No. _____ Serial No. _____ Purchase Date: _____
 Dealer/Address/Phone: _____

Note:

This device is protected by U.S. patent numbers 4,631,603 and 4,577,216 and 4,819,098 and other intellectual property rights. The use of Macrovision's copy protection technology in the device must be authorized by Macrovision and is intended for home and other limited pay-per-view uses only, unless otherwise authorized in writing by Macrovision. Reverse engineering or disassembly is prohibited.

Location of the required Marking

The rating sheet and the safety caution are on the rear of the unit.

CERTIFICATION: COMPLIES WITH FDA RADIATION PERFORMANCE STANDARDS, 21 CFR SUBCHAPTER J.

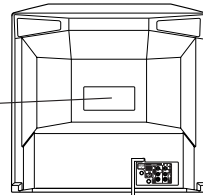

IMPORTANT SAFEGUARDS

1. READ INSTRUCTIONS

All the safety and operating instructions should be read before the unit is operated.

2. RETAIN INSTRUCTIONS

The safety and operating instructions should be retained for future reference.

3. HEED WARNINGS

All warnings on the unit and in the operating instructions should be adhered to.

4. FOLLOW INSTRUCTIONS

All operating and use instructions should be followed.

5. CLEANING

Unplug this unit from the wall outlet before cleaning. Do not use liquid cleaners or aerosol cleaners.

Use a damp cloth for cleaning the exterior cabinet only.

6. ATTACHMENTS

The manufacturer of this unit does not make any recommendations for attachments, as they may cause hazards.

7. WATER AND MOISTURE

Do not use this unit near water. For example, near a bathtub, washbowl, kitchen sink, laundry tub, in a wet basement, or near a swimming pool.

8. ACCESSORIES

Do not place this unit on an unstable cart, stand, tripod, bracket, or table.

The unit may fall, causing serious injury, and serious damage to the unit.

- 8A. An appliance and cart combination should be moved with care. Quick stops, excessive force, and uneven surfaces may cause the appliance and cart combination to overturn.

9. VENTILATION

Slots and openings in the cabinet back or bottom are provided for ventilation, to ensure reliable operation of the unit, and to protect it from overheating.

These openings must not be blocked or covered. The openings should never be blocked by placing the unit on a bed, sofa, rug, or other similar surface. This unit should never be placed near or over a radiator or heat source. This unit should not be placed in a built-in installation such as a bookcase or rack unless proper ventilation is provided and/or the manufacturer's instructions have been adhered to.

10. POWER SOURCES

This unit should be operated only from the type of power source indicated on the rating plate. If you are not sure of the type of power supply to your home, consult your appliance dealer or local power company. For units intended to operate from battery power, or other sources, refer to the operating instructions.

11. GROUNDING OR POLARIZATION

This unit is equipped with a polarized alternating-current line plug (a plug having one blade wider than the other). This plug will fit into the power outlet only one way. This is a safety feature. If you are unable to insert the plug fully into the outlet, try reversing the plug. If the plug should still fail to fit, contact your electrician to replace your obsolete outlet. Do not defeat the safety purpose of the polarized plug, if your unit is equipped with a 3-wire grounding-type plug, a plug having a third (grounding) pin. This plug will only fit into a ground-ing-type power outlet. This too, is a safety feature. If you are unable to insert the plug into the outlet, contact your electrician to replace your obsolete outlet. Do not defeat the safety purpose of the grounding-type plug.

12. POWER-CORD PROTECTION

Power-supply cords should be routed so that they are not likely to be walked on or pinched by items placed upon or against them, paying particular attention to cords at plugs, convenience receptacles, and the point where they exit from the appliance.

PORTABLE CART WARNING
(symbol provided by RETAC)



S3126A

IMPORTANT SAFEGUARDS

13. LIGHTNING

To protect your unit from a lightning storm, or when it is left unattended and unused for long periods of time, unplug it from the wall outlet and disconnect the antenna or cable system. This will prevent damage to the unit due to lightning and power line surges.

14. POWER LINES

An outside antenna system should not be located in the vicinity of overhead power lines or other electric light or power circuits, or where it can fall into such power lines or circuits. When installing an outside antenna system, extreme care should be taken to keep from touching such power lines or circuits, as contact with them might be fatal.

15. OVERLOADING

Do not overload wall outlets and extension cords, as this can result in a risk of fire or electric shock.

16. OBJECT AND LIQUID ENTRY

Do not push objects through any openings in this unit, as they may touch dangerous voltage points or short out parts that could result in fire or electric shock. Never spill or spray any type of liquid into the unit.

17. OUTDOOR ANTENNA GROUNDING

If an outside antenna or cable system is connected to the unit, be sure the antenna or cable system is grounded to provide some protection against voltage surges and built-up static charges, Section 810 of the National Electrical Code, ANSI/NFPA 70, provides information with respect to proper grounding of the mast and supporting structure, grounding of the lead-in wire to an antenna discharge unit, size of grounding conductors, location of antenna discharge unit, connection to grounding electrodes, and requirements for the grounding electrode.

18. SERVICING

Do not attempt to service this unit yourself as opening or removing covers may expose you to dangerous voltage or other hazards. Refer all servicing to qualified service personnel.

19. DAMAGE REQUIRING SERVICE

Unplug this unit from the wall outlet and refer servicing to qualified service personnel under the following conditions:

- a. When the power-supply cord or plug is damaged.
- b. If liquid has been spilled, or objects have fallen into the unit.
- c. If the unit has been exposed to rain or water.
- d. If the unit does not operate normally by following the operating instructions. Adjust only those controls that are covered by the operating instructions, as an improper adjustment of other controls may result in damage and will often require extensive work by a qualified technician to restore the unit to its normal operation.
- e. If the unit has been dropped or the cabinet has been damaged.
- f. When the unit exhibits a distinct change in performance, this indicates a need for service.

20. REPLACEMENT PARTS

When replacement parts are required, be sure the service technician uses replacement parts specified by the manufacturer or those that have the same characteristics as the original part.

Unauthorized substitutions may result in fire, electric shock or other hazards.

21. SAFETY CHECK

Upon completion of any service or repairs to this unit, ask the service technician to perform safety checks to determine that the unit is in proper operating condition.

22. HEAT

The product should be situated away from heat sources such as radiators, heat registers, stoves, or other products (including amplifiers) that produce heat.

23. DISC TRAY

Keep your fingers well clear of the disc tray as it is closing. It may cause serious personal injury.

24. CONNECTING

When you connect the product to other equipment, turn off the power and unplug all of the equipment from the wall outlet. Failure to do so may cause an electric shock and serious personal injury. Read the owner's manual of the other equipment carefully and follow the instructions when making any connections.

IMPORTANT SAFEGUARDS

25. LASER BEAM

Do not look into the opening of the disc tray or ventilation opening of the product to see the source of the laser beam. It may cause sight damage.

26. DISC

Do not use a cracked, deformed, or repaired disc. These discs are easily broken and may cause serious personal injury and product malfunction.

27. NOTE TO CABLE TV SYSTEM INSTALLER

This reminder is provided to call the CABLE TV system installer's attention to Article 820-40 of the NEC that provides guidelines for proper grounding and, in particular, specifies that the cable ground shall be connected to the grounding system of the building, as close to the point of cable entry as practical.

EXAMPLE OF ANTENNA GROUNDING AS PER THE NATIONAL ELECTRICAL CODE

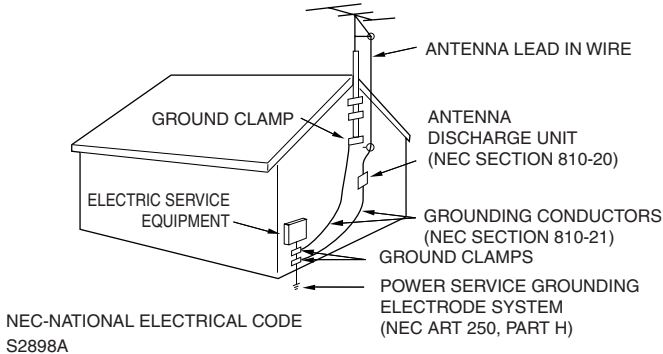

CONDENSATION

Moisture will form in the operating section of the unit if the unit is brought from cool surroundings into a warm room or if the temperature of the room rises suddenly. When this happens, the unit's performance will be impaired.

To prevent this, let the unit stand in its new surroundings for about an hour before switching it on, or make sure that the room temperature rises gradually.

Condensation may also form during the summer if the unit is exposed to the breeze from an air conditioner. In such cases, change the location of the unit.

Power source

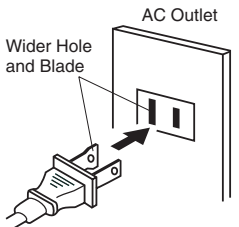

Polarized AC Cord Plug
(One blade is wider than the other.)

TO USE AC POWER SOURCE

Use the AC polarized line cord provided for operation on AC. Insert the AC cord plug into a standard 120V 60Hz polarized AC outlet.

NOTES:

- Never connect the AC line cord plug to other than the specified voltage (120V 60Hz). Use the attached power cord only.
- If the polarized AC cord does not fit into a non-polarized AC outlet, do not attempt to file or cut the blade. It is the user's responsibility to have an electrician replace the obsolete outlet.
- If you cause a static discharge when touching the unit and the unit fails to function, simply unplug the unit from the AC outlet and plug it back in. The unit should return to normal operation.

Features

Color TV with DVD/CD Player/Video Cassette Recorder

- **Color TV with DVD/CD player with Video Cassette Recorder** - Unique space saving design combines a color TV, a DVD/CD player and a Hi-Fi Video cassette recorder. The DVD disc has much more capacity, but is the same size as the audio CD disc. Picture quality is higher than Super VHS. Audio quality is higher than audio CD. The DVD PLAYER can play back audio CDs.
- **High Quality Picture** - More than 400 lines (VCR mode: 220 lines) of Horizontal Resolution.

TV Section

- **On-Screen 3 Language Display** - You can select one of 3 languages, English, Spanish or French for on-screen programming.
- **Closed Caption Decoder With Full Text Mode** - Displays text captions or full screen text on the screen for hearing impaired viewers.
- **Picture Adjustments Using The Remote Control** - The On-Screen display allows precise remote control adjustment of BRIGHTNESS, CONTRAST, COLOR, TINT and SHARPNESS.
- **Programmable TV Sleep Timer** - Operable from the remote control, the TV can be programmed up to 120 minutes to turn off automatically.
- **V-Chip** - The V-Chip function can read the rating of a TV program or movie content if the program is encoded with this information. V-Chip will allow you to set a restriction level.
- **Surround Sound** - The surround sound feature expands the audio listening field wider and deeper to create exceptional sound quality from the TV's speakers.
- **Stable Sound** - The stable sound feature limits the highest volume level to prevent extreme changes in volume when the signal source is changed.

VCR Section

- **Stereo/SAP Reception** - This VCR is designed to receive stereo and second audio program (SAP) broadcasts where available.
- **4 Video Heads** - Provides optimal picture quality for special effects playback.
- **19µm HEAD** - For superior picture quality even in SLP mode, 19micron width technology helps to avoid crosstalk and boost SLP picture quality to near SP levels. With precision technology, ghosts and color beats are virtually eliminated.
- **Hi-Fi Stereo Sound** - With a frequency response of 20 to 20,000 Hz and a dynamic range of better than 90dB, this VCR provides a level of excellence that rivals compact discs.
- **One-touch Timer Recording (OTR)** - Simply by pressing the REC/OTR button, the VCR can be programmed for up to 6 hours of recording with an immediate start.

DVD Section

- **Compatible with a wide range of DVD audio outputs**
 - **Digital Audio Jack:**
 - When a component with a built-in Dolby Digital decoder is connected, Dolby Digital sound can produce the effect of being in a movie theater or a concert hall.
 - Surround standard different from Dolby Digital. This format is already in use in many theaters. By connecting this unit to a DTS decoder or an AV amplifier with a built-in DTS decoder, the DTS audio of DVD discs recorded in this format can be enjoyed. However, audio will not be output from the analog audio output jacks.
 - The MPEG audio of DVD discs recorded in this format can be enjoyed.
 - The Linear PCM sound of a 48 kHz/16 bit through 96 kHz/24 bit exceeds audio CD sound.
- **Multi-Language** - Since this DVD matches with 136 language-subtitles/-soundtracks, you can enjoy selecting a favorite one. (You can not select the language that is not recorded on the disc.)
- **Multi-Angle** - Pictures of Sports or a Live Concert are recorded with many cameras. When you play such a disc, you can change the angles during playback. (If a Multi-Angle is not recorded on the disc, you can not change the angle.)
- **Repeat Playback** - You can repeat chapter, track, title, sides or material between two selected points.
- **Memory/Random Playback** - You can play back tracks, titles or chapters in programmed or random-selected sequences.
- **Zoom** - You can zoom in on the selected subject on the screen during playback.
- **Video Aspect Ratio** - You can change the aspect ratio of the screen for your monitor/television on a suitable disc.
- **Parental Control** - You can limit the playback of scenes or sounds of adult DVD discs which have a parental level rating.

* This product incorporates copyright protection technology that is protected by method claims of certain U.S. patents and other intellectual property rights owned by Macrovision Corporation and other rights owners. Use of this copyright protection technology must be authorized by Macrovision Corporation and is intended for home and other limited viewing uses only unless otherwise authorized by Macrovision Corporation. Reverse engineering or disassembly is prohibited.

* Manufactured under license from Dolby Laboratories. "Dolby" and the double-D symbol are trademarks of Dolby Laboratories.

* "DTS" and "DTS Digital Out" are trademarks of Digital Theater Systems, Inc.

* Unauthorized recording of copyrighted television programs, films, video cassettes and other materials may infringe the rights of copyright owners and be contrary to copyright laws.

Before using your unit

IMPORTANT SAFEGUARDS	3
Power source	5
Features	6
Contents	7
Parts and functions	8
Remote control	9
Antenna connections	11
Cable TV connections	12
Connections to other equipment	13
Setting the language	15
Auto clock setting	16
Manual clock setting	18

TV operation

TV operation	19
Closed caption	21
Memorizing channels	22
Setting the V-Chip	24
Setting the on timer	27
Setting the off timer	28
Picture control adjustment	29
Adjusting the picture preference	30
Sound control adjustment	31
Setting the surround sound/ Setting the stable sound	32
Stereo recording and playback/ Second Audio Program (SAP)	33

Tape playback operation

Loading and Unloading a cassette tape	34
Cassette tape playback	35
Special playback	36
ZERO RETURN function/ Video index search system	37

Recording

Recording a TV program	38
One-touch Timer Recording (OTR)	40
Timer recording	41

Advanced function of VCR section

Duplicating a video tape	43
--------------------------------	----

Disc playback operation

Disc	44
Preparation/Status display of disc	45
Setting the setup language	46
Playback procedure	47
Special playback	48
mp3/WMA/JPEG playback	49
Setting the JPEG interval	51
Setting the select files	52
Zooming/Locating desired scene	53
Repeat playback	54
Program playback/Random playback (CD)	55
Changing soundtrack language/Subtitles/ Karaoke playback	56
Changing angles/Title selection/DVD menu ...	57

Advanced function of DVD section

Setting the aspect ratio of TV screen/ Setting on screen display	58
Dynamic Range Control	59
Parental control setting	60
Changing the parental level	61
Temporary disabling of rating by DVD disc	62
Setting the menu language	63
Setting the subtitle language	64
Setting the audio soundtrack language	65

Additional information

Language code list	66
Problems and troubleshooting	67
Video head cleaning	68
Specifications	69
Warranty	70

Parts and functions

Front

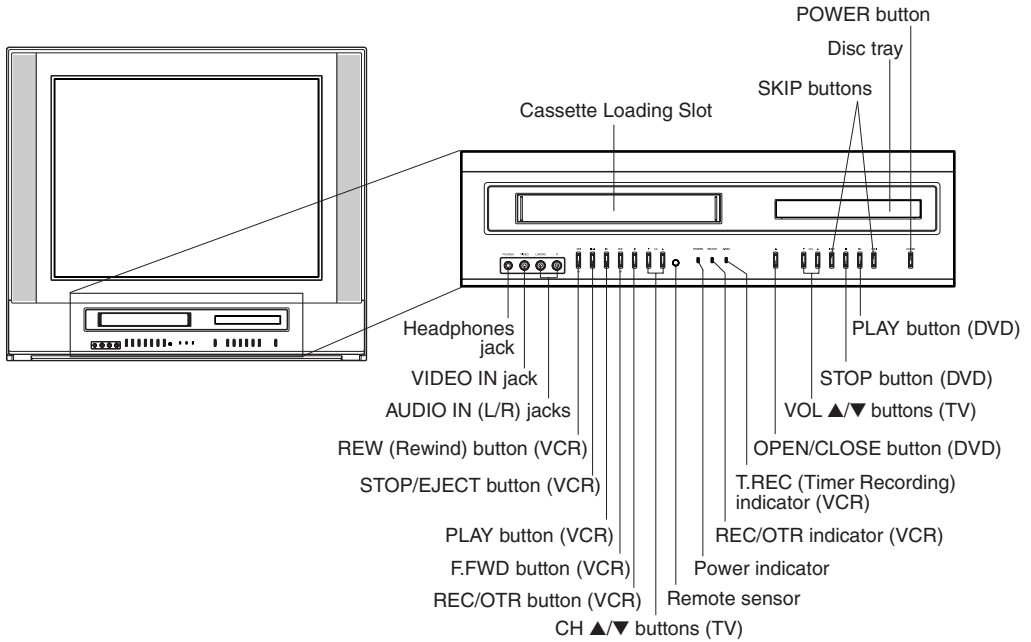

Rear

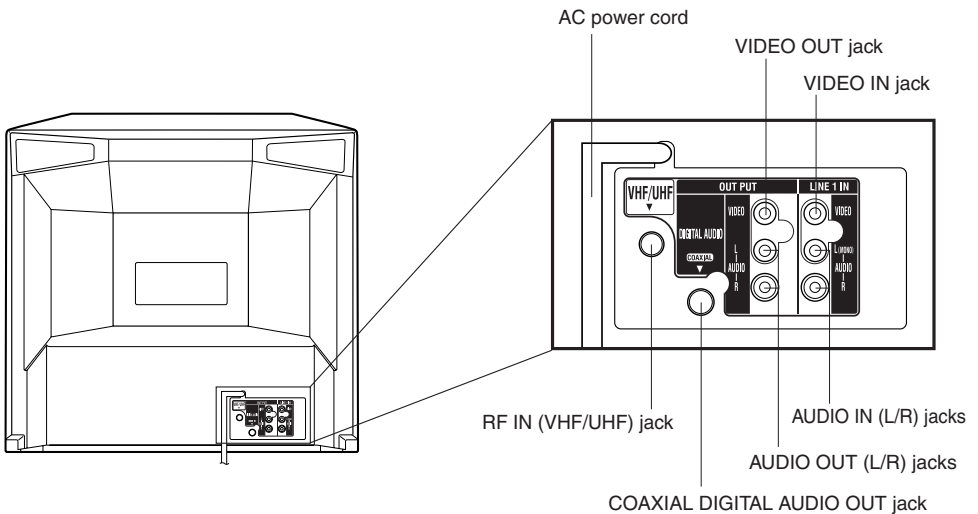

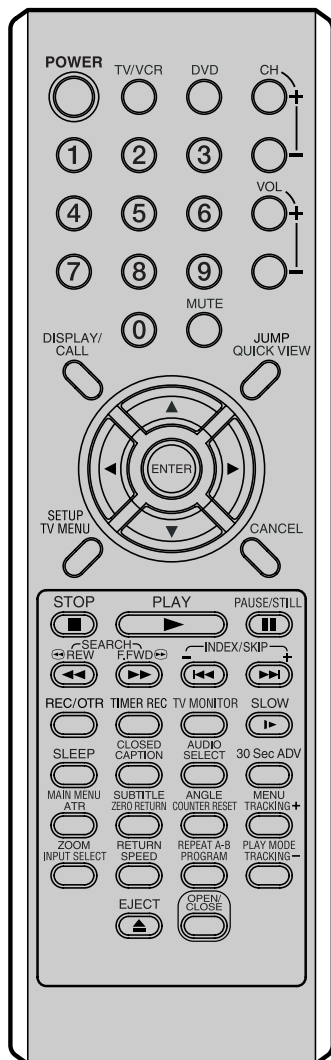

POWER	Power on/off	10,15,16,19,45,47
TV/	Press to operate TV	
VCR	Press to operate VCR	
DVD	Press to operate DVD	10,40,45~47,53,59
CH +/-	Select channel	20,38,40
0-9	Number buttons	10,19,23,38,40
	Input setting	49,50,53,55
	Enter a password	24,26,60~62
VOL +/-	Adjust volume of TV	19,20
MUTE	Switch off the sound	20
DISPLAY/CALL	Display TV/VCR or DVD operation status	16,20,25,36,37,39,41,45
JUMP	Locating desired scene	53
QUICK VIEW	Switch between present/last channel	20
▲ / ▼ / ◀ / ▶	Arrow buttons	
ENTER	Enter information in the menu Select option in the menu	
SETUP/TV MENU	Display menu of setup	
CANCEL	Delete Timer program Cancel input data in the setting mode	42 24,26,29,31,53,55,60,61
STOP	Stop	35,37~40,47,49,50
PLAY	Playback	35,36,47~50,54,55,57,62
PAUSE/STILL	Still picture/Recording pause on/off	36,39,43,48
REW/SEARCH	Rewind/Review playback	35,36,48
F.FWD/SEARCH	Fast Forward/Forward search playback	35,36,48
INDEX +/-	Search for the INDEX mark of a tape	37
SKIP +/-	Skip chapter to forward or reverse direction	48,50
REC/OTR	Recording	38,40,43
TIMER REC	Set the unit to start recording at a preset time	41,42
TV MONITOR	Temporarily view a TV channel select on the VCR while in the playback mode	36
SLOW	Slow-motion playback	36,48
SLEEP	Sleep timer	20
CLOSED CAPTION	Switch between closed captioning options	21
AUDIO SELECT	Switches sound between mono and stereo Change sound track language of DVD	33 56
30 Sec ADV	Skip the unwanted short material of a tape	36
MAIN MENU	Select title of a DVD disc	50,57
ATR	Digital AUTO TRACKING	36
SUBTITLE	Set Subtitle of a DVD disc	56
ZERO RETURN	Stop the tape when the counter reaches 00:00:00	37
ANGLE	Change playback angle of a DVD disc	57
COUNTER RESET	Reset the counter to 00:00:00	37
MENU	Select menu of a DVD disc	50,57
TRACKING +	Manual tracking button in playback mode	36
ZOOM	Zoom (for DVD playback)	53
INPUT SELECT	Switch the connected TV to external mode	14,43
RETURN	Remove DVD set up menu	46,51,52,58~65
SPEED	Sets the tape speed for recording	38,40,43
REPEAT A-B	Repeat playback between A and B (DVD/CD)	54
PROGRAM	Confirm the timer program	28,42
PLAY MODE	Select playback mode	54,55
TRACKING -	Manual tracking button in playback mode	36
EJECT	Eject a cassette tape	34,41
OPEN/CLOSE	Open or Close the tray	47,49,50,62

Inserting Batteries

- 1 Open the battery compartment cover in the direction of the arrow.



- 2 Install two "AAA" batteries (supplied), paying attention to the polarity diagram in the battery compartment.

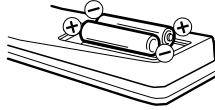

- 3 Replace the compartment cover.



Battery precautions

The precautions below should be followed when using batteries in this device:

1. Use only the size and type of batteries specified.
2. Be sure to follow the correct polarity when installing the batteries as indicated in the battery compartment. Reversed batteries may cause damage to the device. To avoid a potential short circuit, insert the "-" end first.
3. Do not mix different types of batteries together (e.g. Alkaline and Carbon-zinc) or old batteries with fresh ones.
4. If the device is not to be used for a long period of time, remove the batteries to prevent damage or injury from possible battery leakage.
5. Do not try to recharge batteries not intended to be recharged; they can overheat and rupture. (Follow battery manufacturer's directions.)

Remote control basics

- Press **POWER** to turn the TV/VCR/DVD on or off.
- Select your desired operating mode (TV/VCR or DVD) using **TV/VCR** or **DVD**.
- Press **CH +/-** to move through the channels one channel at a time.
- The **Arrow buttons** (▲/▼/◀/▶) are also used to navigate on-screen menu system.
- You can directly access specific channels using the **number buttons**.

Operation

- Aim the remote control at the remote sensor and press control buttons to operate.
- Operate the remote control within 30° angle on either side of the remote sensor, up to a distance of Approx. 5 meters (16 ft.).

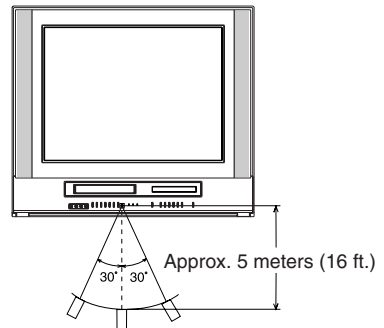

Antenna connections

If you are using an indoor or outdoor antenna, follow the instructions below that correspond to your antenna system. If you are using a cable TV service (CABLE), see page 12 for Cable TV connections.

Combination VHF/UHF antenna (Single 75 ohm cable or 300 ohm twin-lead wire)

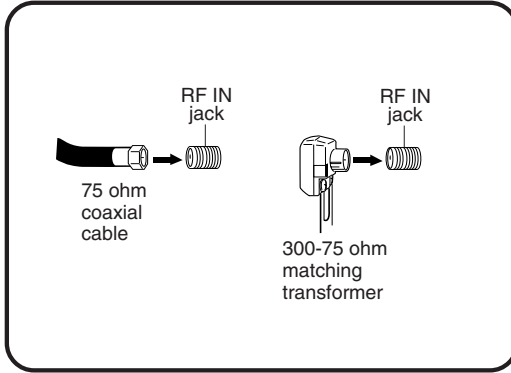

Connect the 75 ohm cable from the combination VHF/UHF antenna to the RF IN jack.

If your combination VHF/UHF antenna has a 300 ohm twin-lead wire, the use of the 300-75 ohm matching transformer may be necessary (not supplied).

Combination VHF/UHF antenna (Separate VHF and UHF 300 ohm twin-lead wires)

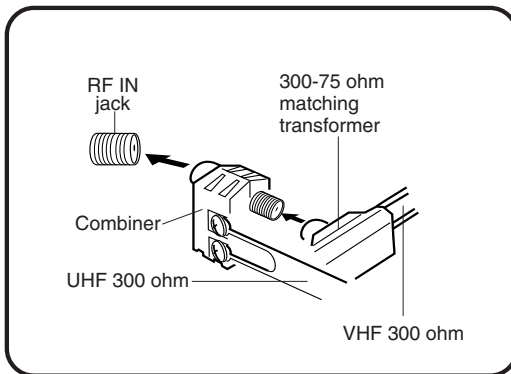

Connect the UHF 300 ohm twin-lead wire to the combiner (not supplied). Connect the VHF 300 ohm twin-lead wire to the 300-75 ohm matching transformer. Attach the transformer to the combiner, then attach the combiner to the RF IN jack.

Separate VHF/UHF antennas (75 ohm VHF cable and 300 ohm UHF twin-lead wires)

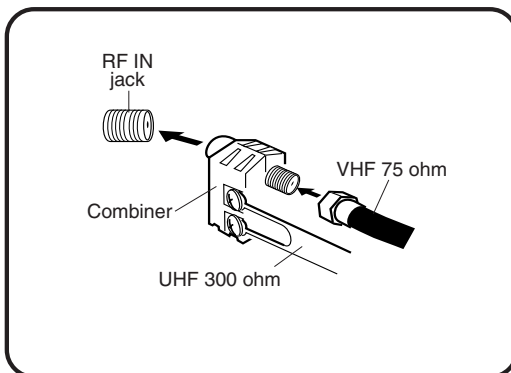

Connect the VHF 75 ohm cable and UHF 300 ohm twin-lead wire to the combiner. Attach the combiner to the RF IN jack.

IMPORTANT: Go to page 22 to choose the signal and search for channels.

Cable TV connections

This unit has an extended tuning range and can tune most cable channels without using a Cable TV Converter box. Some cable companies offer “premium pay channels” in which the signal is scrambled. Descrambling these signals for normal viewing requires the use of a descrambler device which is generally provided by the cable company.

FOR SUBSCRIBERS TO BASIC CABLE TV SERVICE

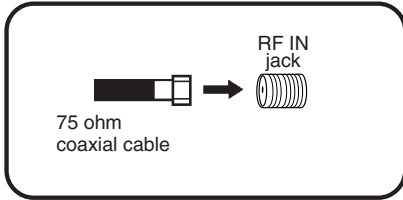

For basic cable service not requiring a Converter/Descrambler box, connect the 75 ohm Coaxial Cable directly to the RF IN Jack on the back of the unit.

FOR SUBSCRIBERS TO SCRAMBLED CABLE TV SERVICE

If you subscribe to a cable TV service which requires the use of a converter/descrambler box, connect the incoming 75 ohm coaxial cable to the converter/descrambler box. Using another 75 ohm coaxial cable, connect the output jack of the converter/descrambler box to the RF IN jack on the unit. Follow the connections shown below. Set the unit to the output channel of the converter/descrambler box (usually channel 3 or 4) and use the converter/descrambler box to select channels.

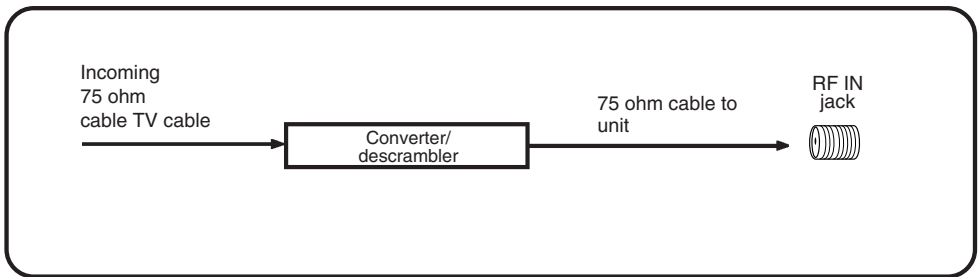

FOR SUBSCRIBERS TO UNSCRAMBLED BASIC CABLE TV SERVICE WITH SCRAMBLED PREMIUM CHANNELS

If you subscribe to a cable TV service in which basic channels are unscrambled and premium channels require the use of a converter/descrambler box, you may wish to use a signal splitter and an A/B switch box (available from the cable company or an electronics supply store). Follow the connections shown below. With the switch in the “B” position, you can directly tune any nonscrambled channels on your unit. With the switch in the “A” position, tune your unit to the output of the converter/descrambler box (usually channel 3 or 4) and use the converter/descrambler box to tune scrambled channels.

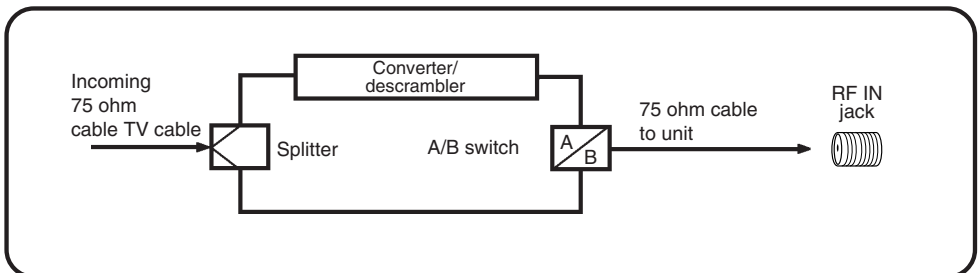

IMPORTANT: Go to page 22 to choose the signal and search for channels.

Connections to other equipment

The exact arrangement you use to interconnect various video and audio components to the unit is dependent on the model and features of each component. Check the Owner's Manual provided with each component for the location of video and audio inputs and outputs.

Using an Audio Amplifier

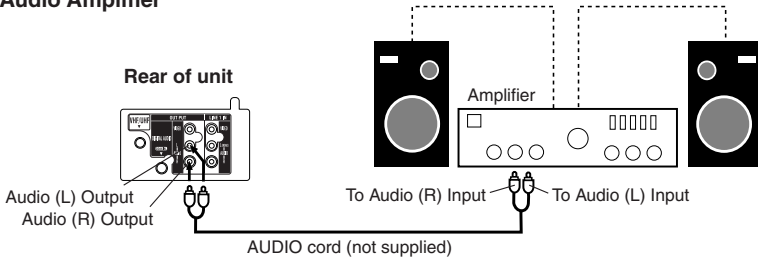

Using an AV Amplifier with built-in digital surround

If you are using an Amplifier with a built-in digital surround as follows, you can enjoy the various audio systems including Dolby Digital Surround audio that sounds just like the movie.

Connect an AV amplifier with built-in Dolby Digital decoder, DTS decoder, MPEG decoder or etc as shown below.

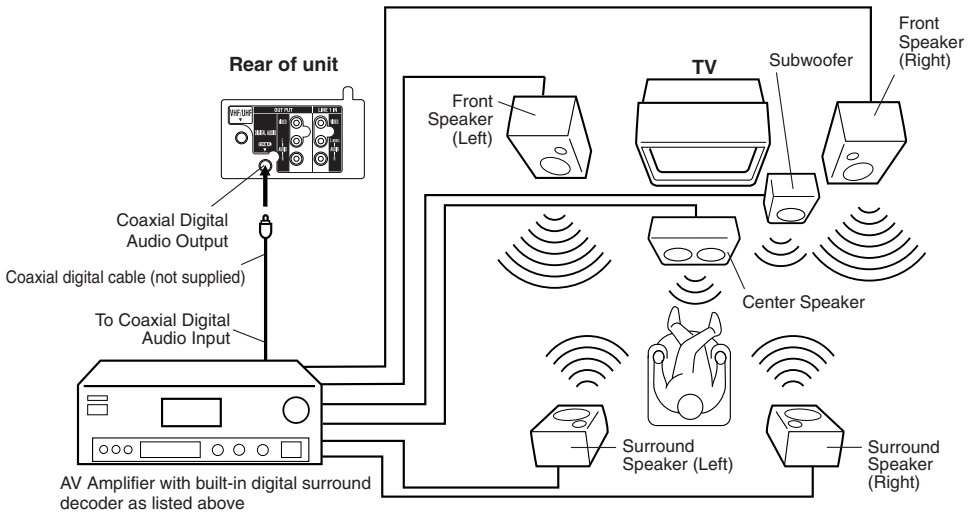

* Manufactured under license from Dolby Laboratories. "Dolby" and the double-D symbol are trademarks of Dolby Laboratories.

* "DTS" and "DTS Digital Out" are trademarks of Digital Theater Systems, Inc.

NOTES:

- When you make the connections above, do not set DOLBY DIGITAL to DOLBY DIGITAL, MPEG to MPEG to ON on the AV Amplifier. If you do, a loud noise will suddenly come out from the speakers, affecting your ears or causing the speakers to be damaged.
- Some DTS decoders which do not support DVD-DTS interface may not work properly with the unit.

Using the audio/video inputs

If you connect the TV/VCR/DVD to a camcorder or Video Game Console, you can select different modes by pressing **INPUT SELECT**.

Press **INPUT SELECT** repeatedly to select the desired mode.
"LINE1", "LINE2" or TV channel will display on the screen for 4 seconds.

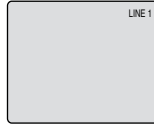

NOTE:
In the DVD mode this key will not operate.

To connect the unit to a camcorder

To playback from the camcorder, connect the camcorder to the unit as shown.

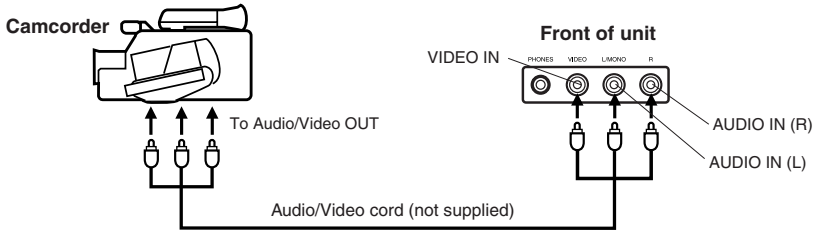

To connect the TV/VCR/DVD to a Video Game Console

The TV/VCR/DVD can also be used as a display device for many video games. However, due to the wide variety of formats, they have not all been included in the suggested connection diagram. You'll need to consult each component's Owner's Manual for additional information.

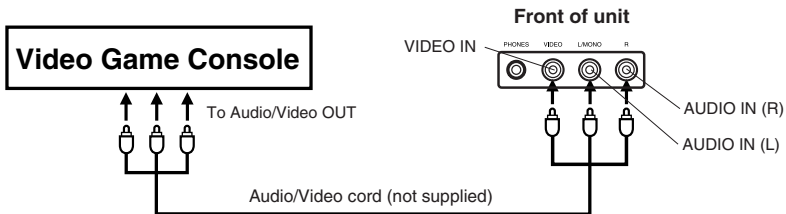

Setting the language

You can choose from three different languages (English, French and Spanish) for the on-screen displays.

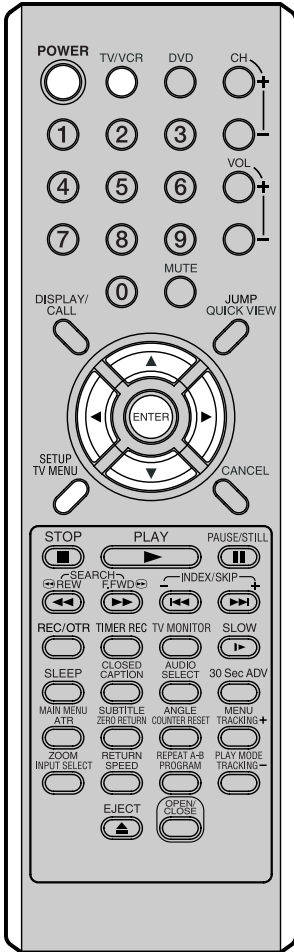

1 Press **POWER** to turn on the TV/VCR/DVD.

2 Press **TV/VCR** to select the TV/VCR mode.

3 Press **TV MENU**. Press ◀ or ▶ to select  option.

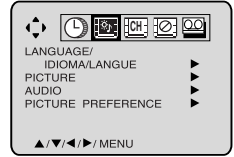

4 Press ▲ or ▼ to select "LANGUAGE", then press ▶.

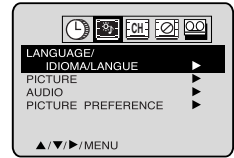

5 Press ▲ or ▼ to select the desired language: English (ENGLISH), Spanish (ESPAÑOL) or French (FRANCAIS), then press **ENTER**.



6 Press **TV MENU** until the MENU screen disappears.

NOTES:

- Both the TV/VCR and the DVD have their own menu option (see page 46).
- If no buttons are pressed for more than 60 seconds, the MENU screen disappears automatically.

Auto clock setting

The Auto Clock function will automatically set the built-in clock (Month, Day, Year and Time) when the TV/VCR/DVD is connected to an Antenna or Cable system and it is turned off. As the TV/VCR/DVD searches for a receivable station in your area and it receives a broadcast signal for Auto Clock, the Auto Clock needs several minutes to set itself.

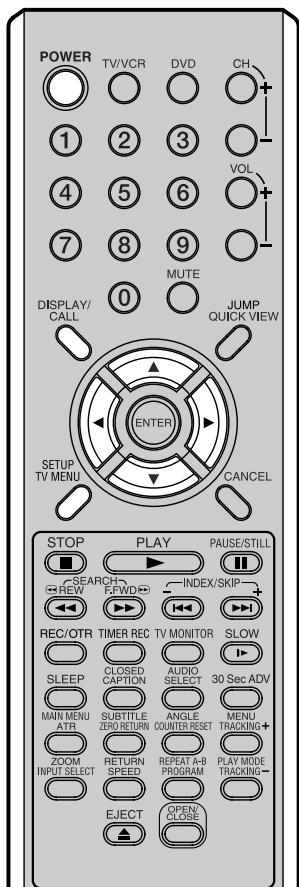

NOTES:

- After a power failure or disconnection of the power, the timer settings will be lost. In this case, reset the present time.
- If you live in Newfoundland and the Auto Clock does not function properly, set the AUTO CLOCK menu option to "OFF" and set the clock manually.

AUTO CLOCK SETTING

- 1 Connect the Antenna or Cable system.
 - If you use a cable box, turn it on.
- 2 Plug the AC Power cord to the AC outlet.
- 3 Make sure the TV/VCR/DVD is turned off.
 - If you press **POWER**, Auto Clock set is not effective.
- 4 Wait at least three minutes and press **POWER**.
- 5 Press **DISPLAY/CALL** to check the clock on the screen.
- 6 If the clock is not set, make sure you are receiving TV channels. The Auto Clock may not function properly if the reception condition is not good.

AUTO CLOCK ADJUSTMENT

The Auto Clock Adjustment will be performed at 12:00 PM everyday if you turn off the TV/VCR/DVD.

- If you use a cable box and you want Auto Clock adjustment to be performed, the cable box must be left on.
- The Auto Clock Adjustment won't work if there is more than 5 minutes between the built-in clock time and the actual time.

TO SET AUTO CLOCK TO OFF

When shipped from factory "AUTO CLOCK" is set to "ON". But if you do not want Auto Clock set (Adjustment):

- 1 Turn on the TV/VCR/DVD.
- 2 Press **TV MENU**.
- 3 Press **◀** or **▶** to select **CLOCK** option.
- 4 Press **▲** or **▼** to select "AUTO CLOCK".
- 5 Press **◀** or **▶** to select "OFF".
- 6 Press **TV MENU** repeatedly to return to the normal screen.
 - When "AUTO CLOCK" is set to "OFF", the Auto Clock adjustment does not function.
 - Set the clock manually (see page 18).

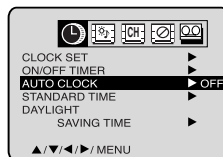
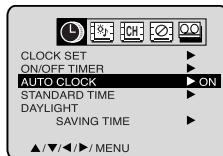
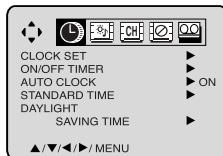

TO SET STANDARD TIME

In the rare event that you live within broadcast range of two stations in two different time zones, the TV/VCR/DVD may recognize the wrong station for the Auto Clock set. To correct the situation:

- 1 Press **TV MENU**.
- 2 Press ◀ or ▶ to select ⌚ option.
- 3 Press ▲ or ▼ to select "STANDARD TIME", then press ▶.
- 4 Press ▲ or ▼ to select your time zone, then press **ENTER**.

ATLANTIC	:	GMT - 4 hours
EASTERN	:	GMT - 5 hours
CENTRAL	:	GMT - 6 hours
MOUNTAIN	:	GMT - 7 hours
PACIFIC	:	GMT - 8 hours
ALASKA	:	GMT - 9 hours
HAWAII	:	GMT - 10 hours
AUTO	:	AUTO SET

- 5 Press **TV MENU** repeatedly to return to the normal screen.

NOTE: To be able to select the standard time, the clock must first be set by "AUTO CLOCK" once.

DAYLIGHT SAVING TIME SETTING

You can set the Daylight Saving Time automatically or manually.

- 1 Press **TV MENU**.
Press ◀ or ▶ to select ⌚ option.
- 2 Press ▲ or ▼ to select "DAYLIGHT SAVING TIME", then press ▶.
- 3 Press ▲ or ▼ to select one of the options, then press **ENTER**. Press **TV MENU** until the MENU screen disappears.

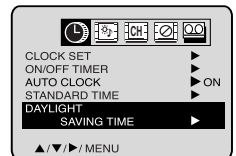
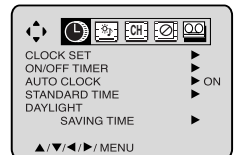

NOTES:

- When shipped from factory, "DAYLIGHT SAVING TIME" is set to "AUTO".
- When you want to set the Daylight Saving Time manually, on the first Sunday in April you set to "ON", and on the last Sunday in October you set to "OFF".
- When the clock is not set, Daylight Saving Time setting is not available.
- When there is no Daylight Saving Time in your area, always select "OFF" in step 3.

- ON:** for manual setting (forward one hour)
- OFF:** for manual setting (back one hour)
- AUTO:** for automatic setting (read XDS in the signal)

Manual clock setting

You must set the date and time manually for Timer Recordings, ON/OFF Timer and Daylight Saving Time if the Auto Clock process did not set them correctly.

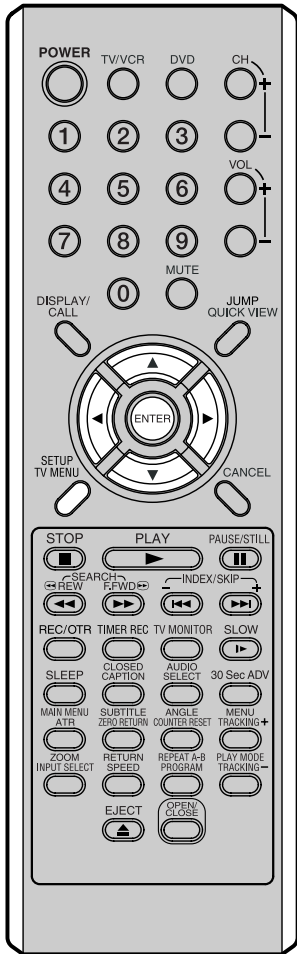

EXAMPLE: Setting the clock to "8:30 AM" March, 26 (SAT), 2005.

1 Press **TV MENU**. The TV/VCR menu screen will appear.

2 Press **◀** or **▶** to select the  option.

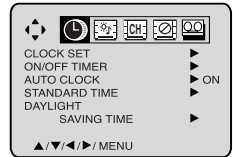

3 Press **▲** or **▼** to select the "CLOCK SET" option, then press **▶**.

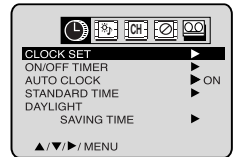

4 Press **◀** or **▶** to set the month, then press **▼**.

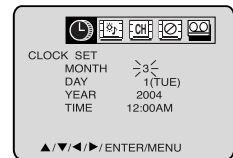

To make corrections any time during the process

Press **▲** repeatedly until the item you want to change blinks, then press **◀** or **▶**.

5 Set the day, year and time as in step 4, then press **ENTER**.

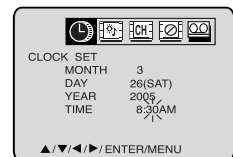

6 After setting the clock, date and time starts functioning automatically.

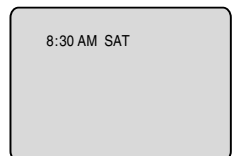

NOTE:

After a power failure or disconnection of the power, the timer settings will be lost. In this case, reset the present time.

TV operation

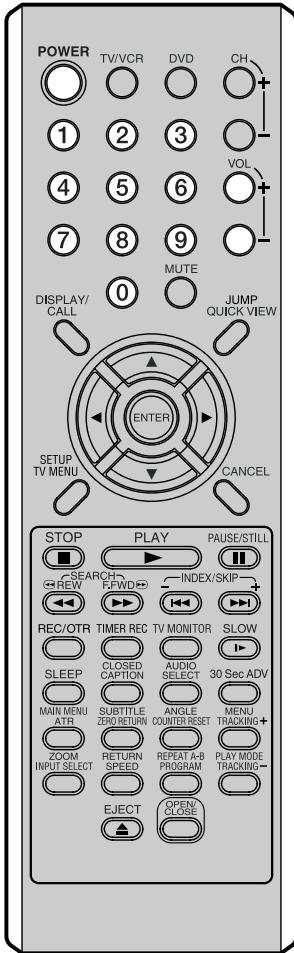

1 To turn on the TV/VCR/DVD, press **POWER**.

2 Adjust the volume level by pressing **VOL +** or **-**. The volume level appears.

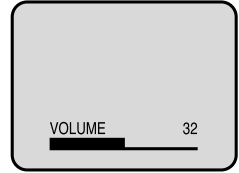

3 Set the TV/CABLE menu option to the appropriate position. (See page 22.)

TV - VHF/UHF channels
CABLE - CABLE TV channels

4 Press the **number buttons** to select the channel.

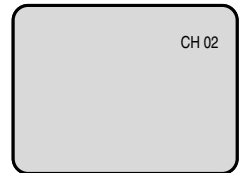

Channels can be instantly selected by using two buttons. (for example, to select channel 2, press "0", then "2". If you press only "2", channel selection will be delayed for a few seconds.)

For channels 10 and above, press the 2 digits in order. For example, to select channel 36, press "36". You can also press "0", then the remaining 2 digits. For example, to select channel 12, press "012".

For 3 digit numbers, press the 3 digits in order. For example, to select channel 120, just press "120".

NOTES:

- If a channel with no broadcast is selected, the sound will automatically be muted.
- If a station being viewed stops broadcasting, the TV will automatically shut itself off after 15 minutes.

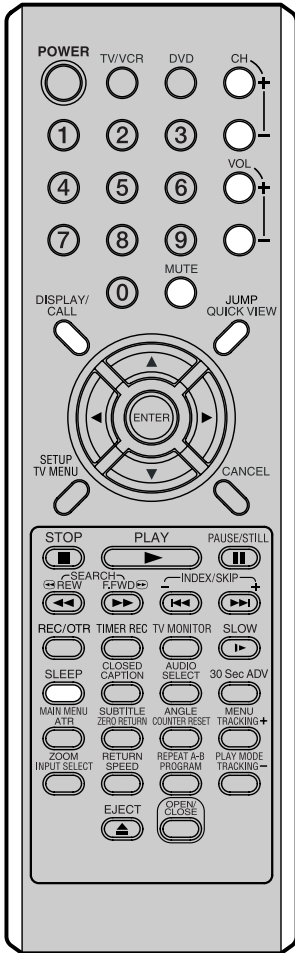

NOTE:

To listen through the headphones, insert the headphones (not supplied) with a 1/8" mini plug into PHONES jack on the front. The sound from the TV speaker is muted.

CHANNEL +/-

Press and release **CH +** or **-**. The channel automatically stops at the next channel set into memory. For proper operation, before selecting channels, they should be set into the memory. See pages 22 and 23 "Memorizing channels".

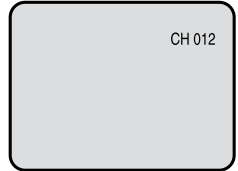

CALL

Press **DISPLAY/CALL** to display the current informations on the screen. Press **DISPLAY/CALL** again to clear the call display.

- Channel number or VIDEO mode.
- Stereo or SAP (second audio program) audio status.
- Audio output status.

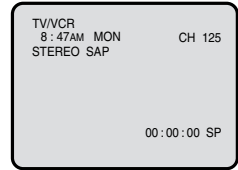

QUICK VIEW

This button allows you to go back to the last channel selected by pressing **QUICK VIEW**. Press **QUICK VIEW** again to return to the last channel you were watching.

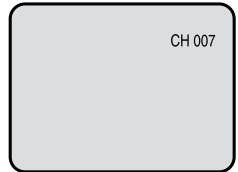

MUTE

Press **MUTE** to switch off the sound. The unit's sound will be silenced and "MUTE" will briefly appear on the screen. The sound can be switched back on by pressing this button again or one of **VOL +** or **-**.

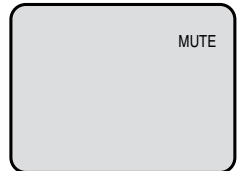

SLEEP

To set the TV/VCR/DVD to turn off after a preset amount of time, press **SLEEP** on the remote control. The clock will count down 10 minutes for each press of **SLEEP** (120, 110, ...10, 0). After the sleep time is programmed, the display will appear briefly every ten minutes to remind you that the sleep timer is operating. To confirm the sleep timer setting, press **SLEEP** and the remaining time will be displayed for a few seconds. To cancel the sleep timer, press **SLEEP** repeatedly until the display turns to 0.

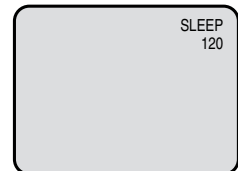

Closed caption

WHAT IS CLOSED CAPTIONING?

This television has the capability to decode and display closed captioned television programs. Closed captioning will display text on the screen for hearing impaired viewers or it will translate and display text in another language.

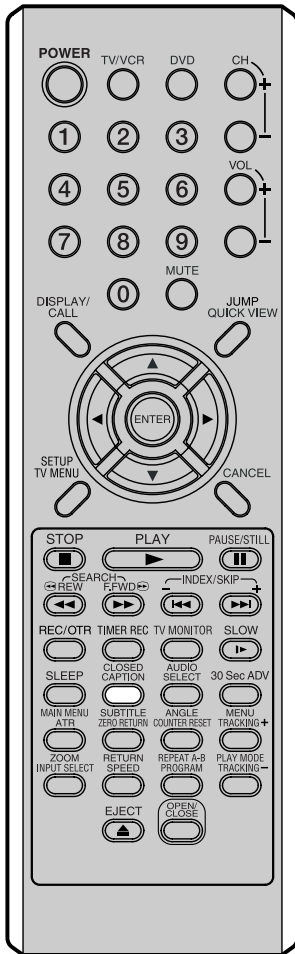

Captions: This closed caption mode will display text on the screen in English or another language (depending on the setting of the closed captions CH 1/2).

Generally, closed captions in English are transmitted on captions channel 1 and closed captions in other languages are transmitted on captions channel 2.

Text: The text closed caption mode will usually fill the screen with a programming schedule or other information.

After selecting a closed caption mode, it will stay in effect until it is changed, even if the channel is changed.

If the captions signal is lost due to a commercial or a break in the signal, the captions will reappear when the signal is received again. If the channels are changed, the captions will be delayed approximately 10 seconds. The captions will appear in places on the screen where they will least interfere with the picture, usually on the bottom of the screen. News programs will usually show three-line closed captions which scroll onto the screen.

Most other shows provide two or three lined captions placed near the character who is speaking so the viewer can follow the dialogue. Words in italics or underlined describe titles, words in foreign languages or words requiring emphasis. Words that are sung usually appear enclosed by musical notes.

For television programs broadcasting with closed captions, look in your TV guide for the closed captions symbol (CC).

TO VIEW CLOSED CAPTIONS

Press **CLOSED CAPTION** to switch between normal TV and the two closed caption modes (captions and full screen text). Closed captioning will display text on the screen for hearing impaired viewers.

CAPTION CH 1

NOTES:

- When selecting closed captions, the captioning will be delayed approximately 10 seconds.
- If no caption signal is received, no captions will appear, but the television will remain in the caption mode.
- Misspellings or unusual characters may occasionally appear during closed captioning. This is normal with closed captioning, especially with live programs. This is because during live programs, captions are also entered live. These transmissions do not allow time for editing.
- When captions are being displayed, on-screen displays, such as volume and mute may not be seen or may interfere with closed captions.
- Some cable systems and copy protection systems may interfere with the closed captioned signal.
- If using an indoor antenna or if TV reception is very poor, the closed caption decoder may not appear or may appear with strange characters or misspelled words. In this case, adjust the antenna for better reception or use an outdoor antenna.

Memorizing channels

This TV/VCR/DVD is equipped with a channel memory feature which allows channels to skip up or down to the next channel set into memory, skipping over unwanted channels. Before selecting channels, they must be programmed into the unit's memory. In addition to normal VHF and UHF channels, this TV/VCR/DVD can receive up to 113 Cable TV channels. To use this TV/VCR/DVD with an antenna, set the TV/CABLE menu option to the TV mode. When shipped from the factory, this menu option is in the CABLE mode.

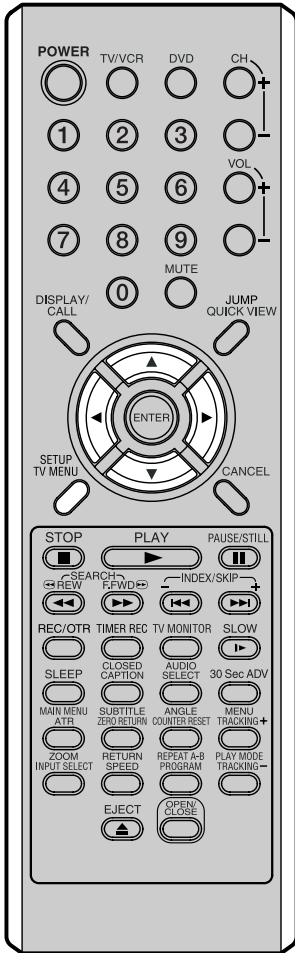

TV/CABLE SELECTION

1 Press **TV MENU** in the TV/VCR mode. The TV/VCR menu screen will appear.

2 Press **◀** or **▶** to select **CH** option.

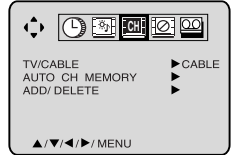

3 Press **▲** or **▼** to select "TV/CABLE".

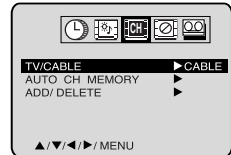

4 Press **◀** or **▶** to select "TV" or "CABLE".

TV - VHF/UHF channels
CABLE - CABLE TV channels

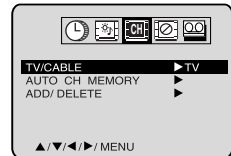

5 Press **TV MENU** until the MENU screen disappears.

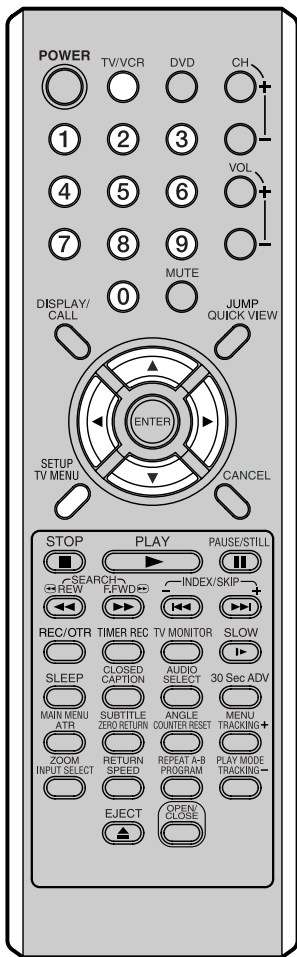

AUTOMATIC MEMORY TUNING

- 1 Press **TV/VCR**. Press **TV MENU**, the TV/VCR menu screen will appear.
- 2 Press **◀** or **▶** to select **CH** option.
- 3 Press **▲** or **▼** to select "AUTO CH MEMORY".
- 4 Press **▶**. The TV will begin memorizing all the channels available in your area.
- 5 Press **TV MENU** until the MENU screen disappears.

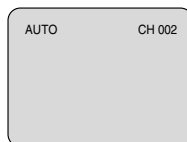
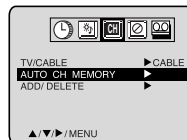
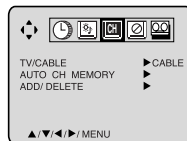

TO ADD/DELETE CHANNELS

- 1 Press **TV MENU**. The TV/VCR menu screen will appear.
- 2 Press **◀** or **▶** to select **CH** option.
- 3 Press **▲** or **▼** to select "ADD/DELETE", then press **▶**.
- 4 Select the desired channel to be memorized or deleted using the **number buttons (0-9)**, or **▲** or **▼**.
- 5 Press **◀** or **▶** to select "ADD" or "DELETE", whichever function you want to perform.
- 6 Press **TV MENU** until the MENU screen disappears.

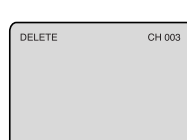
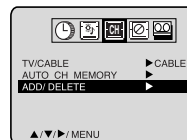
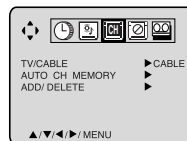

Setting the V-Chip

An age limitation can be set to forbid children to see and hear violent scenes or pictures for adults, etc. The TV/VCR/DVD corresponds to "TV RATING" and "MOVIE RATING". To use the V-Chip function, you must register a password.

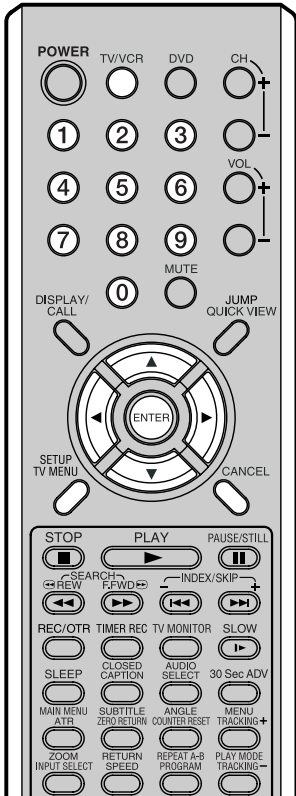

TO REGISTER PASSWORD

1 Press **TV/VCR**. Press **TV MENU**, the TV/VCR menu screen will appear.

2 Press **◀** or **▶** to select  option, then press **▲** or **▼** to select "PASSWORD".

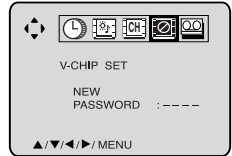

3 Enter the password (4 digits) using the **number buttons (0-9)**, then press **ENTER**. If you put in a wrong number, press **CANCEL**.

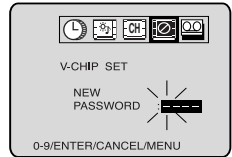

"*" appears instead of the number.

4 Enter the same password again, then press **ENTER**. The password is now registered and the V-Chip Set menu appears.

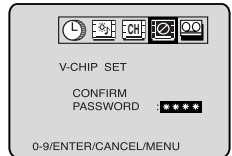

NOTES:

- To avoid forgetting the password, write it down and keep it in a safe place.
- If you forget the password...
 1. Disconnect the AC cord plug from the AC outlet and leave the TV/VCR/DVD unplugged for more than two minutes.
 2. Insert the AC cord plug again, and turn the volume level to a minimum.
 3. Press the **VOL ▼** button on the TV/VCR/DVD and the **0** button on the remote control for more than 2 seconds simultaneously.

TO SET THE V-CHIP

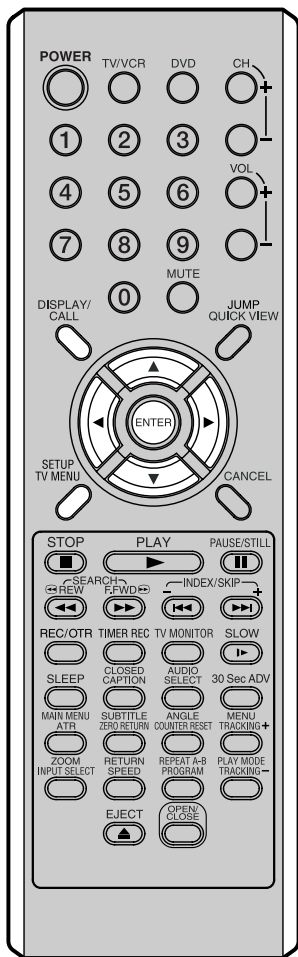

To use the TV after V-Chip is activated.

When the program applied to the V-Chip setting is received, enter the password, then press **ENTER**. When the password is entered correctly the protection will be temporarily overridden.

NOTE:

The V-Chip function is activated only on programs and tapes that support the rating system.

- 1 In the V-CHIP SET menu, press **▲** or **▼** to select "V-CHIP SET", then press **▶**.

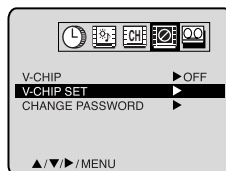

- 2 Press **▲** or **▼** to select "TV RATING", then press **◀** or **▶** to display the desired setting.

OFF : TV RATING is not set
TV-Y : All children
TV-Y7 : 7 years old and above
TV-G : General audience
TV-PG : Parental guidance
TV-14 : 14 years old and above
TV-MA : 17 years old and above

When you select TV- Y7, TV-PG, TV-14 or TV-MA, press **DISPLAY/CALL** to show the contained rating. Press **▲** or **▼** to select the desired item you want. Press **◀** or **▶** to select the setting "ON" or "OFF".

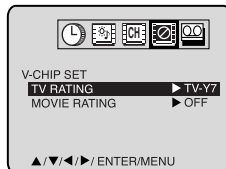

- 3 Press **▲** or **▼** to select "MOVIE RATING".

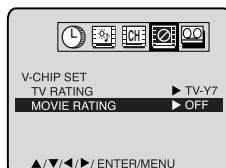

- 4 Press **◀** or **▶** to select desired rating, then press **ENTER**.

OFF : MOVIE RATING is not set
G : All ages
PG : Parental guidance
PG-13 : Parental guidance less than 13 years old
R : Under 17 years old
 Parental guidance suggested
NC-17 : 17 years old and above
X : Adult only

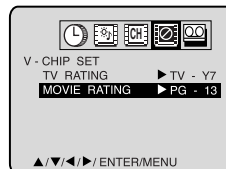

- 5 Press **▲** or **▼** to select "V-CHIP".

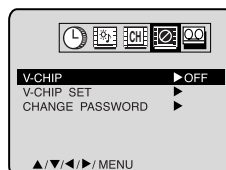

- 6 Press **◀** or **▶** to display "ON".
 Now your settings were set into the memory.

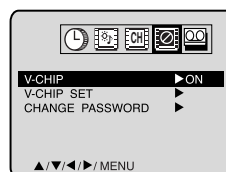

- 7 Press **TV MENU** until the MENU screen disappears.

TO CHANGE PASSWORD

1 Press **TV/VCR**. Press **TV MENU**, the TV/VCR menu screen will appear.

2 Press **◀** or **▶** to select  option.



3 Press **▲** or **▼** to select the "PASSWORD".

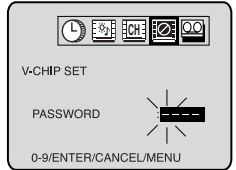

4 Enter the Password using the **number buttons (0-9)**, then press **ENTER**.
If you put a wrong number, press **CANCEL**.

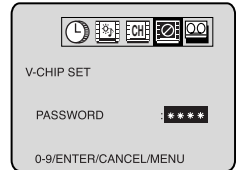

5 Press **▲** or **▼** to select "CHANGE PASSWORD", then press **▶**.

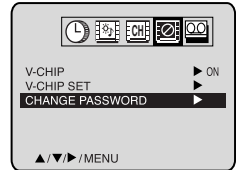

6 Enter the new password using the **number buttons (0-9)**, then press **ENTER**.

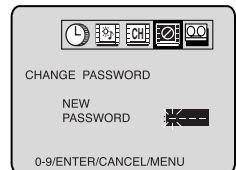

7 Enter the same password again to confirm, then press **ENTER**.

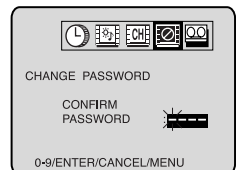

8 Press **TV MENU** repeatedly to return to normal screen.

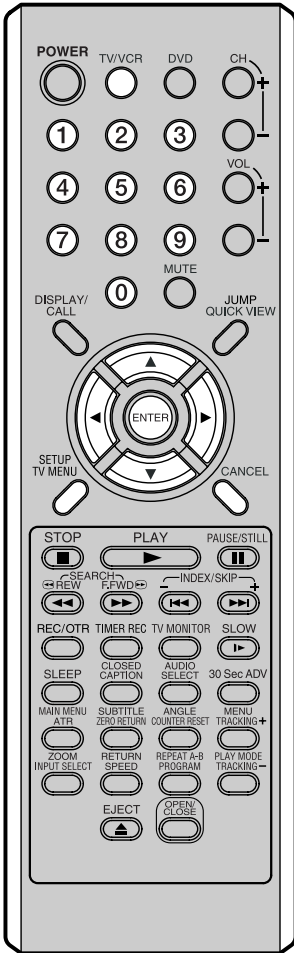

Setting the on timer

This feature allows you to have the TV/VCR/DVD automatically turn on at a predetermined time. If you program the ON TIMER once, the TV/VCR/DVD will turn on on the programmed day (daily/weekly) at the same time to the same channel.

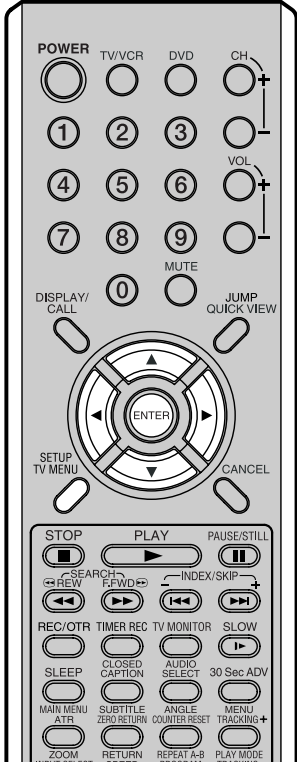

EXAMPLE: Turning on the TV to channel 12 at 7:00 AM, MONDAY-FRIDAY.

1 Press **TV MENU**. Press ◀ or ▶ to select ⌚ option.

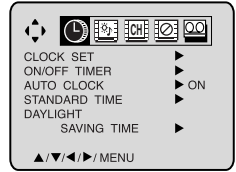

2 Press ▲ or ▼ to select "ON/OFF TIMER", then press ▶.

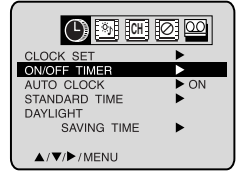

3 Press ▲ or ▼ to select "ON TIMER", then press ▶.

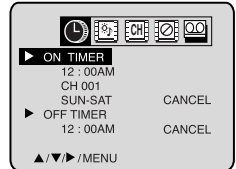

4 Press ◀ or ▶ to set the desired hour, then press ▼.

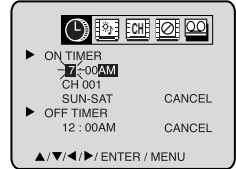

5 Set the desired minute, channel and daily or weekly timer date as in step 4.

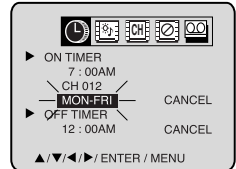

6 Press ◀ or ▶ to select "SET", then press **ENTER**. Press **TV MENU** repeatedly to return to normal screen.

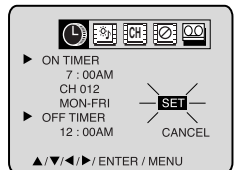

NOTES:

- The TV/VCR/DVD will automatically turn off approximately 1 hour later after the ON TIMER turns on if no OFF TIMER has been set. To continue watching the TV, press any button to cancel the one hour automatic shut off.
- To cancel ON TIMER, follow above steps 1-5, then press ◀ or ▶ to select "CANCEL". Press **TV MENU** repeatedly to return to the normal screen.
- After setting the ON TIMER, the arrow moves to OFF TIMER position. If you wish to set the OFF TIMER, press ▶ then follow the steps 4-6 on page 28 "Setting the off timer".

Setting the off timer

This feature allows you to have the TV/VCR/DVD turn off automatically at a predetermined time. If you program the OFF TIMER once, the TV/VCR/DVD will automatically turn off at the same time everyday.

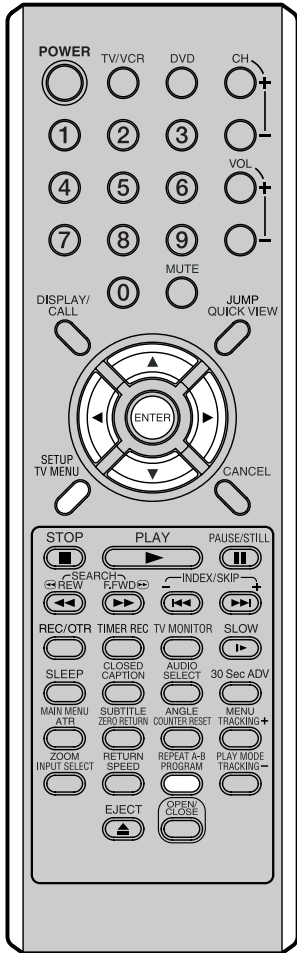

NOTES:

- If a station being viewed stops broadcasting, the TV will automatically shut itself off after 15 minutes.
- To cancel OFF TIMER, follow above steps 1-5, then press ◀ or ▶ to select "CANCEL". Press TV MENU to return to the normal screen.
- To confirm the ON/OFF TIMER: Press PROGRAM twice to indicate the programs on the screen.

EXAMPLE: Turning off the TV at 11:30 PM.

- 1 Press TV MENU. Press ◀ or ▶ to select option.

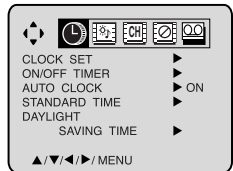

- 2 Press ▲ or ▼ to select "ON/OFF TIMER", then press ▶.

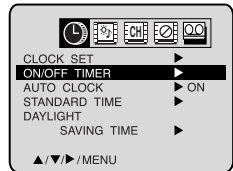

- 3 Press ▲ or ▼ to select "OFF TIMER", then press ▶.

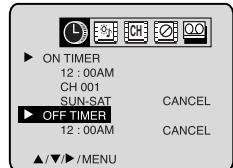

- 4 Press ◀ or ▶ to set the desired hour, then press ▼.

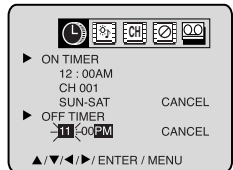

- 5 Press ◀ or ▶ to set the desired minute, then press ▼.

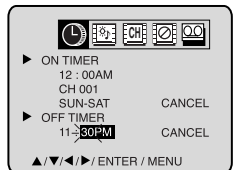

- 6 Press ◀ or ▶ to select "SET", then press ENTER. Press TV MENU repeatedly to return to the normal screen.

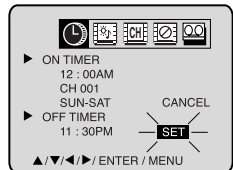

Picture control adjustment

Picture controls are factory preset but you can adjust them individually as follows:

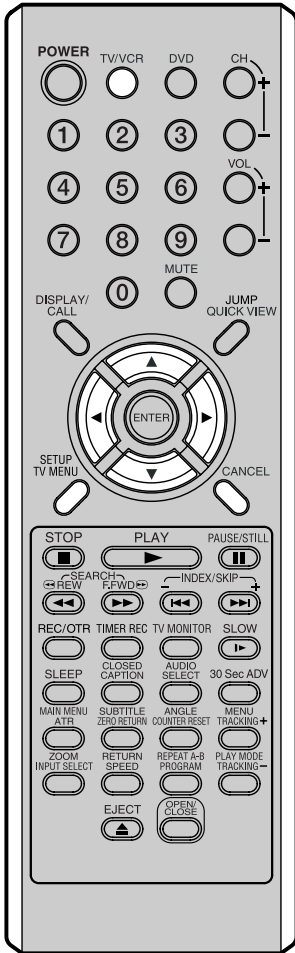

1 Press **TV/VCR**. Press **TV MENU**, the TV/VCR menu screen will appear.

2 Press **◀** or **▶** to select  option.

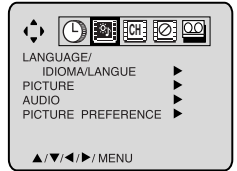

3 Press **▲** or **▼** to select "PICTURE", then press **▶**.

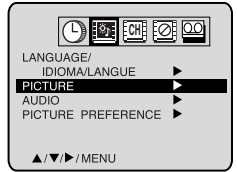

4 Press **▲** or **▼** to select the item you want to adjust. Press **◀** or **▶** to adjust the setting.



	▶	◀
BRIGHTNESS	increase brightness	decrease brightness
CONTRAST	increase contrast	decrease contrast
COLOR	brilliant color	pale color
TINT	greenish color	reddish color
SHARPNESS	makes picture clearer	makes picture softer

5 After your desired setting, press **TV MENU** until the MENU screen disappears.

CANCEL

Pressing **CANCEL** while making picture adjustments will return all adjustments to the factory preset levels.

NOTE:

The **CONTRAST** default setting is set to maximum at the factory.

Adjusting the picture preference

You can select four picture modes—**STANDARD**, **SPORTS**, **MOVIE** and **MEMORY**—as described in the following table:

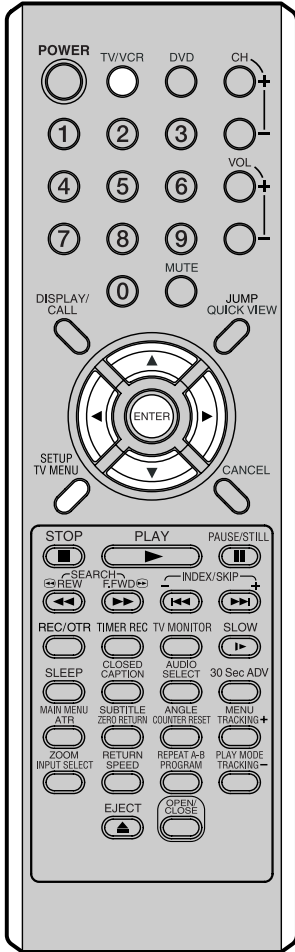

1 Press **TV/VCR**. Press **TV MENU**, the TV/VCR menu screen will appear.

2 Press **◀** or **▶** to select **Picture** option.

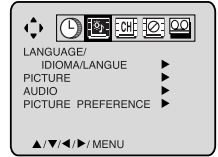

3 Press **▲** or **▼** to select “**PICTURE PREFERENCE**”, then press **▶**.

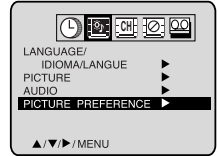

4 Press **▲** or **▼** to select the item you want to adjust. Press **ENTER** to adjust the setting.



Mode	Picture Quality
STANDARD	Standard picture quality (factory-set)
SPORTS	Bright and dynamic picture (factory-set)
MOVIE	Movie-like picture setting (factory-set)
MEMORY	Your personal preferences (set by you; see “Picture control adjustment” on the page 29).

5 After your desired setting, press **TV MENU** until the **MENU** screen disappears.

Sound control adjustment

Sound controls are factory preset but you can adjust them individually as follows:

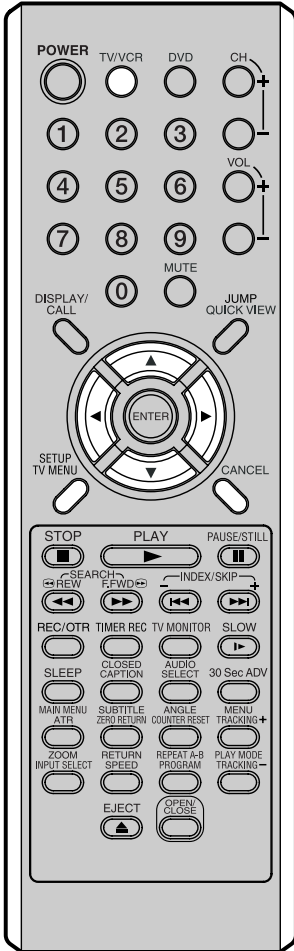

1 Press **TV/VCR**. Press **TV MENU**, the TV/VCR menu screen will appear.

2 Press **◀** or **▶** to select **🔊** option.

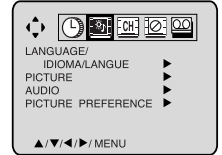

3 Press **▲** or **▼** to select "AUDIO", then press **▶**.

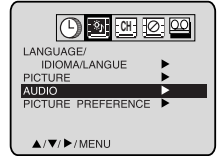

4 Press **▲** or **▼** to select the item you want to adjust. Press **◀** or **▶** to adjust the setting.

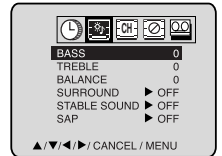

BASS:

Press **◀** or **▶** to adjust the bass sound.

TREBLE:

Press **◀** or **▶** to adjust the treble sound.

BALANCE:

Press **◀** or **▶** to obtain an equal sound level from both speakers.

5 After your desired setting, press **TV MENU** until the MENU screen disappears.

CANCEL

Pressing **CANCEL** while making sound adjustments will return all adjustments to the factory preset levels.

Setting the surround sound / Setting the stable sound

Setting the surround sound

The surround sound feature expands the audio listening field wider and deeper to create exceptional sound quality from the TV's speakers.

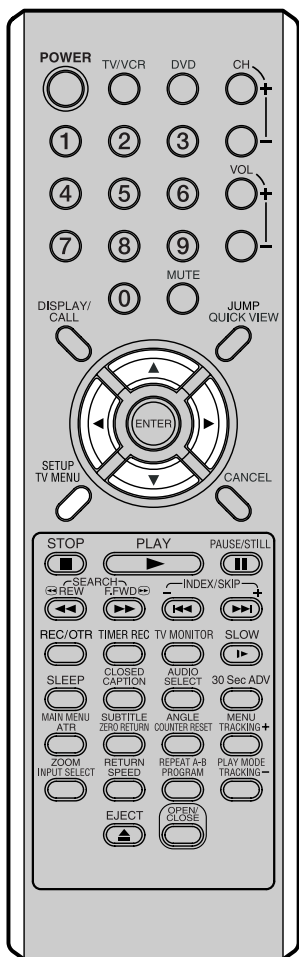

- 1 Press **TV MENU**. Press ◀ or ▶ to select option. Press ▲ or ▼ to select "AUDIO", then press ▶.

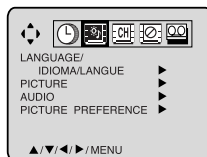

- 2 Press ▲ or ▼ to select "SURROUND". Then press ◀ or ▶ to select "ON".

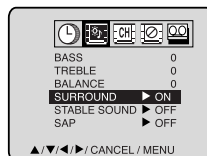

- 3 Press **TV MENU** until the MENU screen disappears.

To cancel the surround sound mode:

Follow the above step 2, then press ◀ or ▶ to select "OFF" position. Press **TV MENU** until the MENU screen disappears.

Setting the stable sound

The stable sound feature limits the highest volume level to prevent extreme changes in volume when the signal source is changed.

- 1 Press **TV MENU**. Press ◀ or ▶ to select option. Press ▲ or ▼ to select "AUDIO", then press ▶.

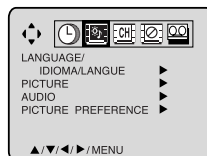

- 2 Press ▲ or ▼ to select "STABLE SOUND". Then press ◀ or ▶ to select "ON".

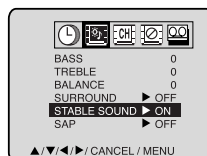

- 3 Press **TV MENU** until the MENU screen disappears.

To cancel the stable sound mode:

Follow the above step 2, then press ◀ or ▶ to select "OFF" position. Press **TV MENU** until the MENU screen disappears.

Stereo recording and playback / Second Audio Program (SAP)

Stereo recording and playback

The VHS Hi-Fi audio system permits high fidelity recording of MTS STEREO TV broadcasts.

When an MTS STEREO broadcast is received, the word STEREO will appear on the screen and the program can be viewed or recorded in stereo. The Hi-Fi STEREO recording procedure is the same as for normal recordings.

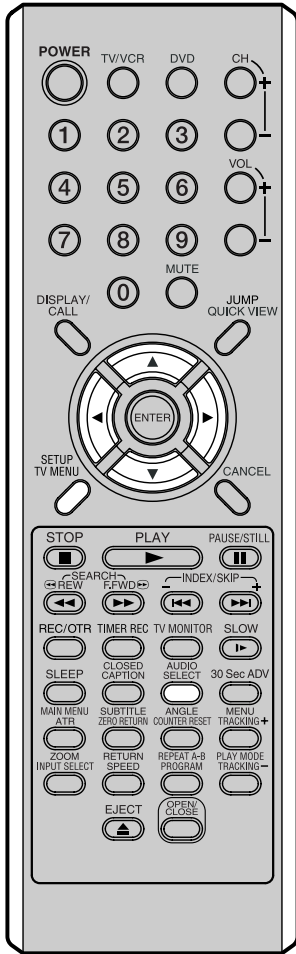
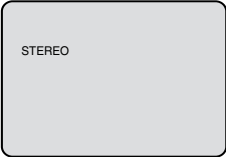

NOTE:

When using a CABLE TV system, stereo TV programs may be transmitted over a mono cable channel. In this case the word "STEREO" will not appear and the sound will be in mono.

Output selection

When viewing an MTS STEREO TV program, or playing a pre-recorded VHS Hi-Fi STEREO video tape, press **AUDIO SELECT** to select how the audio will be heard through the speakers. Normally set to the Hi-Fi STEREO position, this button can be set to the MONO position if the stereo broadcast or videotape audio is of poor quality. The "R" and "L" positions allow the audio from the Right or Left Hi-Fi channel to be heard over both TV speakers. This button has no effect when viewing a MONO video tape or TV program. Each time when you press the button, output selection display appears on the screen for several seconds. Refer to the chart below.

OUTPUT SELECTION	SOUND HEARD ON BOTH SPEAKERS
STEREO	STEREO
L ch	LEFT CHANNEL AUDIO
R ch	RIGHT CHANNEL AUDIO
MONO	MONO

Second Audio Program (SAP)

Your TV/VCR/DVD is fitted with a SAP broadcast system which enables you to switch to a second audio program when viewing a selected channel.

This function applies only when the program is broadcast in multi-languages through the SAP broadcast system.

- 1 Press **TV MENU** in the TV/VCR mode. Then press ◀ or ▶ to select option. Press ▲ or ▼ to select "AUDIO", then press ▶.
- 2 Press ▲ or ▼ to select "SAP". Then press ◀ or ▶ to select "ON".

Then press **TV MENU** until the menu screen is cleared.

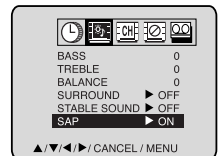

NOTES:

- When playing back a tape that is not recorded in Hi-Fi stereo mode, the audio will automatically be monaural.
- When listening to a VHS Hi-Fi video tape or MTS broadcast through the VHF/UHF jack (Audio/Video cord not connected), the sound will be monaural.

Listening to SAP

When the TV/VCR/DVD is turned on or a channel selection is made, make certain the letters "SAP" appear on the screen. This means that the "Second Audio Program" broadcasting is available.

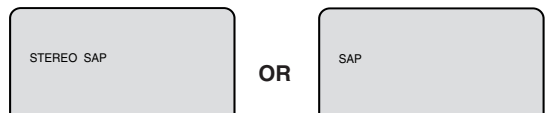

Loading and Unloading a cassette tape

Use only video cassette tapes marked **VHS**.

Loading

Push the center of the tape until it is automatically inserted.

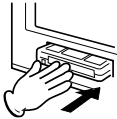

Insert the cassette tape with its labeled side facing up and the erase prevention tab positioned at your left. An inverted cassette tape cannot be inserted.

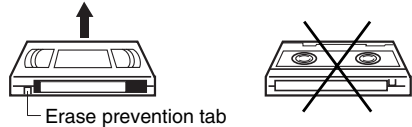

Automatic power ON

When you insert a cassette tape the TV/VCR/DVD power will turn ON automatically.

Automatic playback

When loading a cassette tape without an erase prevention tab, playback will start automatically.

Unloading

1 Press **EJECT** on the TV/VCR/DVD or the Remote.

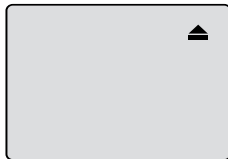

2 Remove the cassette tape.

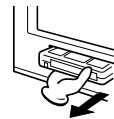

Automatic tape eject

This TV/VCR/DVD will automatically rewind the tape when the tape has ended. And when the tape is rewinded to its beginning, the cassette tape will be ejected automatically.

To prevent accidental erasure

Remove the erase prevention tab with a screwdriver.

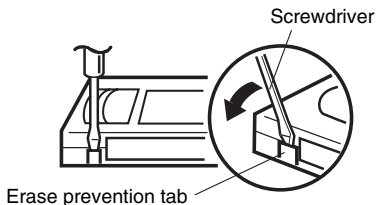

To record again

Cover the hole with a piece of adhesive tape.



Tape speed and maximum recording time

Tape Speed	Video cassette tape				
	T-160	T-120	T-90	T-60	T-30
SP (Standard Play)	2-2/3 hours	2 hours	1-1/2 hours	1 hour	30 minutes
SLP (Super Long Play)	8 hours	6 hours	4-1/2 hours	3 hours	1-1/2 hours

Cassette tape playback

Preparation:

Press **TV/VCR** to select the TV/VCR mode.

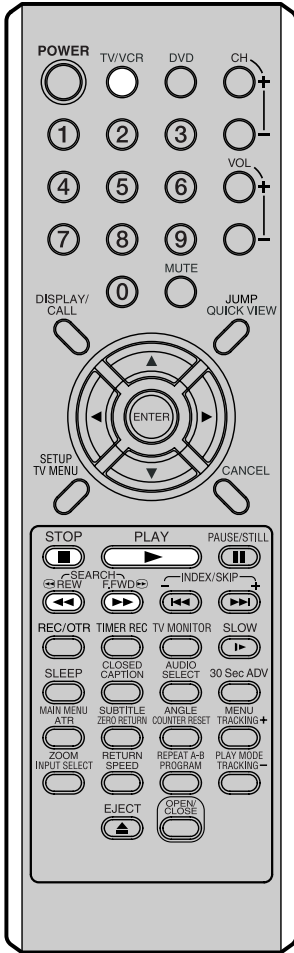

NOTES:

- This TV/VCR/DVD selects the playback tape speed SP or SLP automatically.
- If you play a prerecorded tape after the DVD playback, you must set the TV/VCR/DVD to TV/VCR mode using **TV/VCR**.
- When you select the TV/VCR mode during DVD playback, DVD playback will change to the still mode, and after 5 minutes it will change to the stop mode automatically.

- 1 Load a prerecorded tape (When loading a cassette tape without the erase prevention tab, playback will start automatically).



- 2 To start playback
Press **PLAY**.
Playback will start.
“▶” will appear on the screen for about 4 seconds.



- To stop playback
Press **STOP** once.
The tape will stop but remain fully loaded and ready to play.
“■” will appear on the screen for about 4 seconds.



To rewind the tape or forward it rapidly

Stop the playback or recording with **STOP**.

To rewind the tape:

Press **REW**.



To forward the tape:

Press **F.FWD**.



To stop the tape-winding, press **STOP**. To switch to playback directly (without **STOP**), press **PLAY**.

Forward/Reverse picture search mode

When the tape is being winded, you can switch to picture search mode (see next page). To do this, press **REW** or **F.FWD** and hold it down. The TV/VCR/DVD will resume the tape winding as soon as the button is released.

Special playback

Picture Search

Reverse picture search function

Press **REW** once or twice during the playback.

Forward picture search function

Press **F.FWD** once or twice during the playback.

To return to playback: Press **PLAY**.

SPEED SEARCH TIMES

TAPE SPEED	PICTURE SEARCH SPEED	
	PRESS ONCE	PRESS TWICE
SP (Standard Play)	3 X	5 X
SLP (Super Long Play)	9 X	15 X

Still Picture

Press **PAUSE/STILL** during playback. To resume normal playback: Press **PLAY**.

Slow Motion

During playback press **SLOW**.

To return to playback: Press **PLAY** or **SLOW**.

Slow tracking and vertical lock adjustment

If noise bars appear in the picture during slow motion, press the **TRACKING +** or **-** to reduce the noise bars. If the still picture jitters excessively, press **TRACKING +** or **-** to stabilize the still picture.

Frame by Frame Picture

Press **PAUSE/STILL** during playback.

Press **SLOW** one by one: The picture advances frame by frame.

To return to playback: Press **PLAY** or **PAUSE/STILL**.

Adjusting tracking condition

Automatic tracking adjustment

Whenever you insert a tape and start playback, automatic tracking starts working and continuously analyzes the signal to enable optimum picture quality during playback.

Manual tracking adjustment

If automatic tracking cannot eliminate noises well during playback, press **TRACKING +/-** to eliminate the noises. "MANUAL TR." will appear. Press it briefly for a fine adjustment, or press and hold for a coarse adjustment.

- Press **ATR** to reactivate automatic tracking again. "AUTO TR." will appear.

NOTES:

- The audio output is muted during Picture Search, Still Picture, Frame by Frame Picture and Slow Motion.
- During picture search mode there will be noise bars which are caused by the system.
- The Special Playback will automatically change to playback after approx. 5 minutes to protect the video tape against excessive wear.

Repeat playback

The entire video tape will be played until its end. The tape will then automatically rewind to the beginning and the playback will be repeated.

- 1 Press **TV MENU**.
Press **◀** or **▶** to select **ON** option.

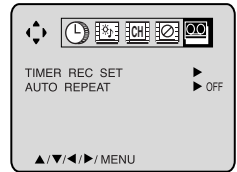

- 2 Press **▲** or **▼** to select "AUTO REPEAT", then press **◀** or **▶** to select "ON" or "OFF". If "ON" is selected, the playback will be repeated endlessly.

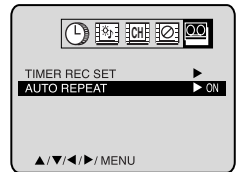

- 3 Press **TV MENU** until the menu screen is cleared. If you press **DISPLAY/CALL**, "C" will appear on the screen.

- 4 To start the playback, press **PLAY**.
The playback will be repeated endlessly.

To cancel repeat mode:

Follow the above step 2, then press **◀** or **▶** to select the OFF position. Press **TV MENU** to return to the TV.

To monitor a TV program

Press **TV MONITOR** while in the playback mode. The video tape will continue to play while the picture switches to the TV channel selected on the TV/VCR/DVD. Press the button to return to the playback picture.

CM skip

Press **30 Sec ADV** in the PLAY mode. The TV/VCR/DVD will search forward through approximately 30 seconds of the tape (e.g. unwanted commercial time) for each press of **30 Sec ADV** (maximum six presses) and then resume normal playback.

For example: 1 press: 30 second of tape
2 press: 60 second of tape
3 press: 90 second of tape

ZERO RETURN function / Video index search system

ZERO RETURN function

This function makes tape-rewinding stop at the counter 00:00:00 position automatically.

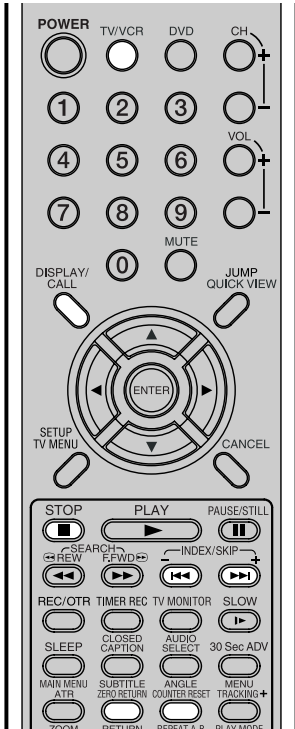

Preparation:

- Press **TV/VCR** to select the TV/VCR mode.

1 Press **DISPLAY/CALL**.
The counter display shows the tape running time during playback or recording.

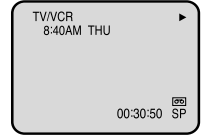

2 Press **COUNTER RESET** at the desired tape position. The counter display will be reset to the "00:00:00" position (e.g. the beginning of recording).

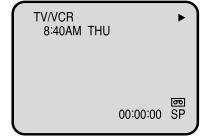

3 Press **STOP** when playback or recording is finished. Press **ZERO RETURN**. The tape will be rewinded or fast forwarded and automatically stop at the "00:00:00" position.

Video index search system

This function enables you to locate the beginning of any recording made on the VCR.

Recording an INDEX MARK

The Index Search function automatically records an INDEX mark on the tape whenever a recording is initiated.

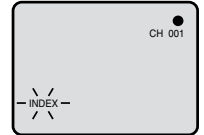

NOTES for Counter Display:

- If you rewind the tape beyond "00:00:00", a minus sign ("-") will be displayed in front of the time.
- When you load a tape, the counter will reset to "00:00:00".
- The counter does not function on nonrecorded (blank) sections of the tape. When you rewind, fast forward or play tapes through blank sections, the counter stops.

NOTES for Video index search system:

- When you record an INDEX mark at the very beginning of the tape, the mark may not be found.
- During INDEX search, the tape may stop and begin to play at a slightly different location.
- INDEX may not function properly with old or worn out video tapes.
- INDEX marks may not be found if it is extremely close to the point where the search began.
- In recording, if you stop recording temporarily, the INDEX mark is not recorded on the tape.

Index Search

Press **INDEX +** or **-** during stop or play mode.

For Succeeding programs: Press **INDEX +**.
For Preceding programs: Press **INDEX -**.
(Additional press increases the INDEX NO. up to 9.)

When the **INDEX +** or **-** is pressed, the TV/VCR/DVD starts searching the INDEX NO. selected and finds the portion, then playback starts automatically.

To stop the Index Search, press **STOP**.

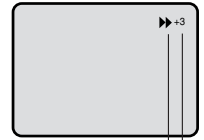

INDEX NO. (up to 9)

Recording a TV program

Recording and viewing the same TV program

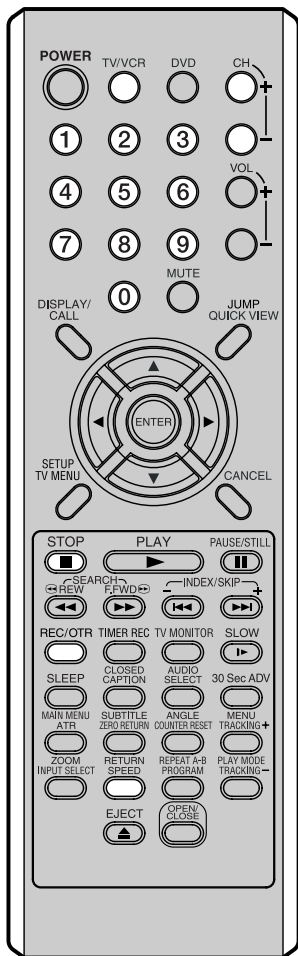

NOTES:

- If power is switched off during recording, the TV and the DVD sections go off and the VCR continues to record. Press **STOP** to halt the recording and turn off the VCR.
- The TV/VCR/DVD channel cannot be changed during recording.
- If you record the TV program after the DVD playback, you must set the TV/VCR/DVD to TV/VCR mode using **TV/VCR**.
- You can not record disc material in DVD, Audio CD, etc. onto a video tape with this TV/VCR/DVD.

Preparation:

- Press **TV/VCR** to select the TV/VCR mode.

1 Load a cassette tape with the erase prevention tab intact. The TV/VCR/DVD will automatically turn on.



2 Press **SPEED** to select the desired tape speed SP or SLP. The tape counter and SP or SLP will appear on the screen for about 4 seconds.

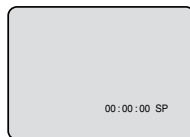

3 Set the TV/CABLE option to the appropriate position (see page 22).

TV - VHF/UHF channels
CABLE - CABLE TV channels

4 Press the **number buttons (0-9)** or **CH +/-** to select the channel to be recorded.

- 1-9 Press **0** twice and then **1-9** as required. Example: To select 2, Press **002**.
- 10-12 Press **0** first and then the remaining 2 digits in order from left to right. Example: Press **012** for "12".
- 13-99 Press 2 digits in order. Example: Press **22** for "22".
- 100-125 Press the 3 digits in order. Example: Press **110** for "110".

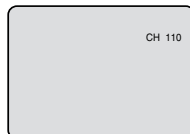

VHF/UHF/Cable TV CHANNELS

TV	Cable TV
VHF 2-13	VHF 2-13
UHF 14-69	STD / HRC / IRC 14-36 (A) (W) 37-59 (AA) (WW) 60-85 (AAA) (ZZZ) 86-94 (86) (94) 95-99 (A-5) (A-1) 100-125 (100) (125) 01 (5A)

5 Press **REC/OTR**. "●" will appear on the screen for about 4 seconds and the REC/OTR indicator will light.

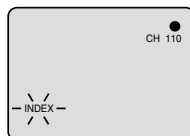

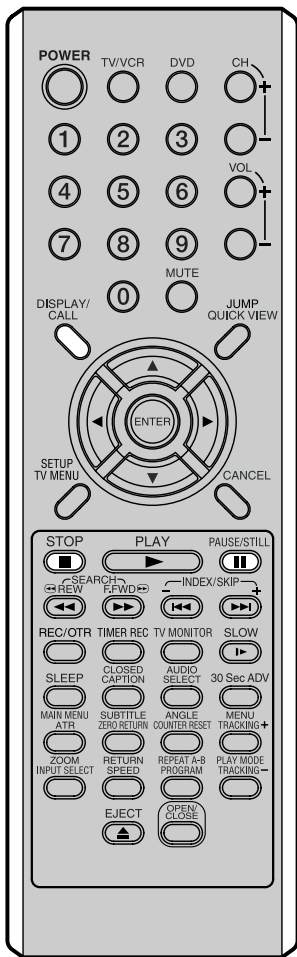

Auto Rewind feature

This VCR will automatically rewind the tape when the tape has ended (except during OTR and TIMER REC). It will also eject the tape.

To stop recording

Press **STOP** to stop recording. "■" will appear on screen for about 4 seconds.



To stop recording temporarily

Press **PAUSE/STILL** to avoid recording unwanted material. Press again to continue the recording. "||" will appear on screen for about 4 seconds.



NOTES:

- The pause function will be released after 5 minutes to prevent damage to the tape or the TV/VCR/DVD. The TV/VCR/DVD will change to the STOP mode.
- You can select a recording channel in the recording pause mode.

To display VCR operation status

Press **DISPLAY/CALL**. The clock, day of the week and more information will be indicated.

While watching TV

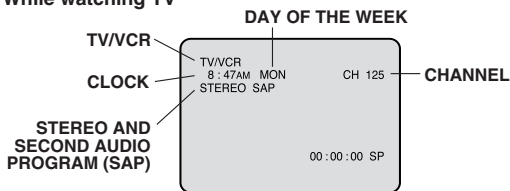

While operating a tape

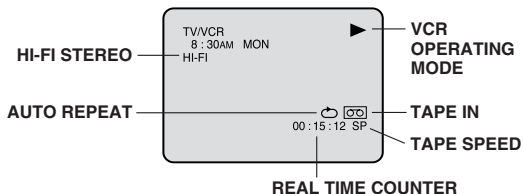

To cancel the display: Press **DISPLAY/CALL** until all indicators disappear.

One-touch Timer Recording (OTR)

The One-touch Timer Recording feature provides a simple and convenient way to make a timed recording.

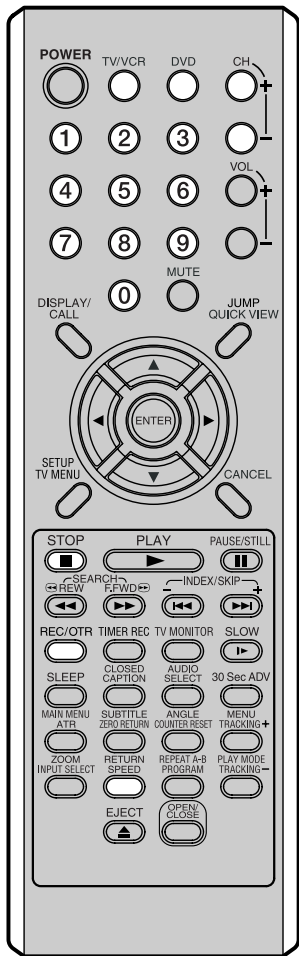

Preparation:

- Press **TV/VCR** to select the TV/VCR mode.

Example: One-touch Timer Recording for 30 minutes.

- 1 Load a cassette tape with the erase prevention tab intact. The TV/VCR/DVD will automatically turn on.



- 2 Press **SPEED** to select the desired tape speed SP or SLP. The tape counter and SP or SLP will appear on the screen for about 4 seconds.

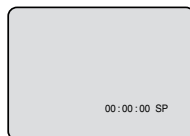

- 3 Set the TV/CABLE option to the appropriate position (see page 22).

TV - VHF/UHF channels
CABLE - CABLE TV channels

- 4 Press the **number buttons (0-9)** or **CH +/-** to select the channel to be recorded.

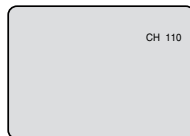

- 5 Press **REC/OTR**. Press the button again to stop recording after 30 minutes. Each additional press of **REC/OTR** will increase recording time as shown in the chart below, up to a maximum of 6 hours. The OTR and recording time will appear on the screen for about 4 seconds.

Press	Recording time	Press	Recording time
once	NORMAL REC	6 times	3:00
twice	0:30	7 times	4:00
3 times	1:00	8 times	5:00
4 times	1:30	9 times	6:00
5 times	2:00	10 times	NORMAL REC

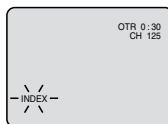

NOTES:

- If you wish to watch the DVD playback during the recording or the OTR, press **DVD** to change to DVD mode and perform the DVD playback.
- The channel cannot be changed during recording.

To cancel OTR

Press **STOP**.

"■" will appear on screen for about 4 seconds.



Timer recording

Timer recording can be programmed on-screen with the remote control. The built-in timer allows automatic unattended recording of up to 8 programs within 1 month.

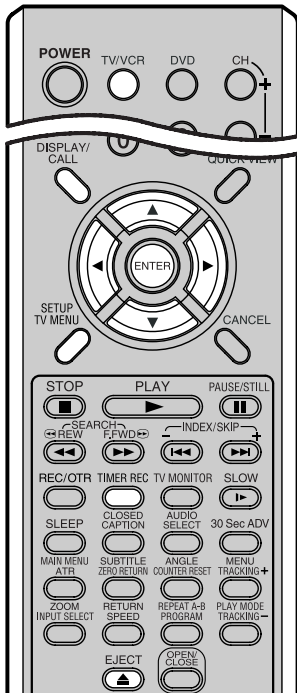

NOTES:

- If the T.REC indicator blinks when the timer recording ended, the TV program has not been completely recorded because of an insufficient tape supply. Press **TIMER REC** to cancel the timer program or press **EJECT** to remove the cassette tape.
- During timer recording standby mode, the VCR operation cannot be used. To use the VCR operation, press **TIMER REC** to deactivate the timer. After you use the VCR, press **TIMER REC** again to put the VCR into timer recording standby mode.
- If you press **TIMER REC** during timer recording, the recording operation will be interrupted. If you press **TIMER REC** again within the programmed time, the recording operation will start again.
- After a power failure or disconnection of the power plug, all programmed recording settings and time display will be lost upon resumption of power. In this case, reset the clock (see pages 16-18) and reprogram any timer recordings.

Preparation:

- Press **TV/VCR** to select the TV/VCR mode.
- Load a cassette tape with the erase prevention tab intact.
- Press **DISPLAY/CALL** to verify that the time and date are correct (see page 39).

Example: Program a timer recording for the 23rd day, channel 125 (CABLE), 7:00 - 9:30 PM on timer program number 1 (Tape speed: SLP).

1 Press **TV MENU**. Press ◀ or ▶ to select option.

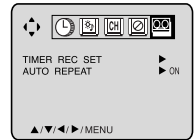

2 Press ▲ or ▼ to select "TIMER REC SET", then press ▶.

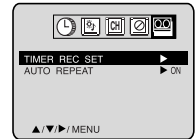

3 Press ▲ or ▼ to select one of the program line, then press **ENTER**.

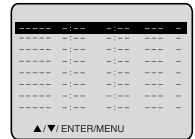

4 Press ◀ or ▶ to select the date, then press ▼.



5 Set the **start time**, **end time**, **channel** and **tape speed** as in step 4, then press **ENTER**.



NOTES:

- Press ▲ to move arrow backward for correction.
- To record from external source set the channel to "L1" or "L2". "L1" or "L2" will appear next to CH 125 (or 69).

6 To enter other programs, repeat steps 3-5.

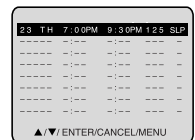

- To return to the normal screen, press **TV MENU** 3 times.

7 Press **TIMER REC**. The T.REC indicator will light and the VCR stands by for recording. The timer recording will start at 5 seconds before the time you predetermined.

NOTES:

- If the T.REC indicator does not light in spite of the pressing of **TIMER REC**, the cassette may not have been loaded yet (see page 34).
- If the cassette is ejected in spite of the pressing of **TIMER REC**, the erase prevention tab of the cassette may have been removed (see page 34).

Timer recording special case

Weekly (e.g. WKL-TUE: each Tuesday) or daily (e.g. MON-SAT: Monday to Saturday) Timer recording

Follow the procedure of timer recording on the previous page. At picture 4 press ◀ repeatedly until the desired setting appears. Then press ENTER.

When you press ◀ repeatedly, the indicator at DATE will change as follows, in this case the day is Friday.

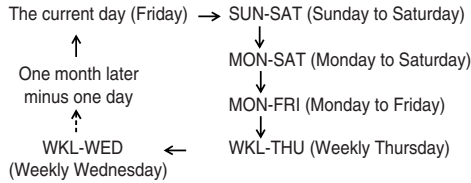

In case Timer programs-overlap

- Do not overlap timer programs as portions of the conflicting programs will be lost. The first recording time has priority over the next recording time as shown in the diagram below.

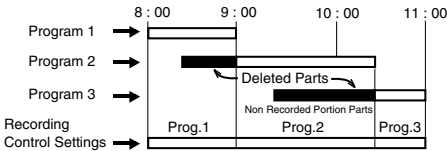

NOTES:

- The daily/weekly recording can be made continuously until the recording is canceled or the tape reaches the end.
- During timer recording the automatic rewinding mechanism does not function.

To confirm the settings

Press PROGRAM once. The TV screen displays the timer program list. Press PROGRAM again. The TV screen displays the ON/OFF TIMER setting.

(once)

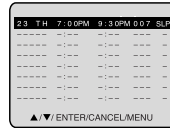

(twice)

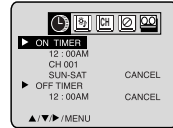

Press PROGRAM 3 times. The screen returns to the normal screen.

To cancel a program

Press ▲ or ▼ to select "TIMER REC SET" in the 00 option, then press ▶. Press ▲ or ▼ to select the unnecessary program, and press CANCEL to cancel the program.

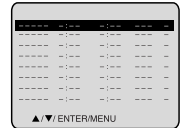

NOTES:

- If there are other timer record programs remaining, **TIMER REC** must be pressed to reactivate the timer, otherwise the remaining timer record programs will be ignored.
- You can correct or cancel a programmed setting in program confirm mode.

Duplicating a video tape

Duplicating a video tape

If you connect the TV/VCR/DVD to another VCR or camcorder, you can duplicate a previously recorded tape. Make all connections before turning on the power.

- 1 Load a blank cassette tape with the erase prevention tab intact into the recording unit.
Load a previously recorded tape into the playback VCR or CAMCORDER.
- 2 Press **SPEED** to select the desired tape speed SP or SLP.
It is recommended that you set the speed to the SP mode on the recording unit for best results.
- 3 Press **INPUT SELECT** to select AUDIO/VIDEO input position. "LINE 1" or "LINE 2" will appear on the screen.

LINE1: on the rear panel
LINE2: on the front panel

- 4 Press **REC/OTR** on the recording unit, then press **PAUSE/STILL**.
- 5 Press the **PLAY** button on the playback VCR or CAMCORDER, then press the pause button.
- 6 Release the recording pause and the playback still simultaneously to begin the duplicating process.

Connection with second Video recorder

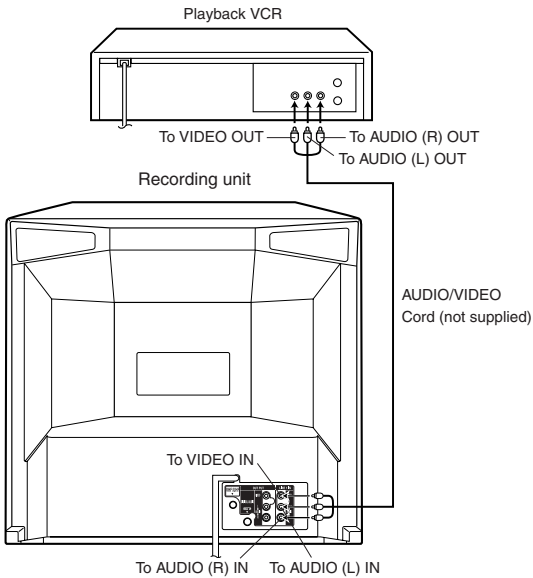

Connection with Video camera

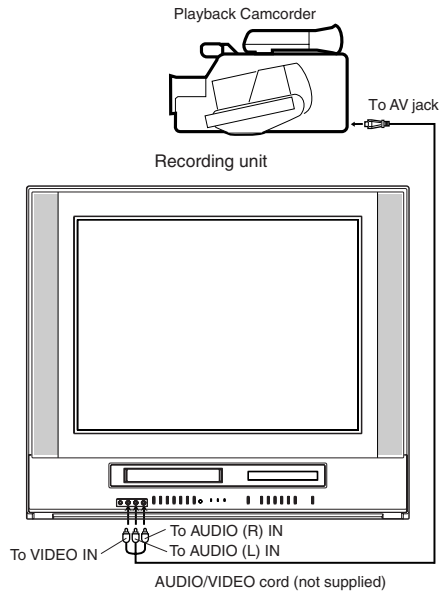

For duplicating a previously recorded tape from a camcorder, follow the camcorder manufacturer's instructions. A typical camcorder dubbing hookup is shown above.

Disc

This TV/VCR/DVD applies to DVD discs from Region 1 or ALL.

The loaded Disc (DVD, Audio-CD and mp3/WMA/JPEG-CD) will be recognized automatically.

The suitable Disc-formats are: DVD, CD-R/RW and DVD-R/RW (Video format only).

Some CD-R/RW and DVD-R/RW discs may be incompatible.

WARNING

Do not attempt to play DVD-ROM, DVD-Audio, CDV, Video-CD or CD-G to prevent accidental erasure of prerecorded material. These formats are not supported by this model.

Title

When two or more movies are recorded on a disc, the disc is divided into two or more sections. Each section is called a "TITLE".

Chapter

The titles can be subdivided into many sections. Each section is called a "CHAPTER".

Track

An Audio CD can contain several items.

Each item is called a "TRACK".

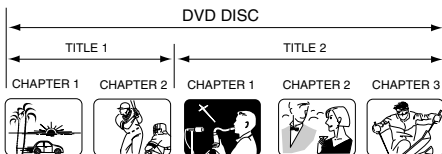

Removing Disc from Case

Be sure to hold the edge of disc. Do not touch the surface of the disc. Pick up the disc gently from the case.

- Do not scratch the disc.
- Do not get dirt on the surface of the disc.
- Do not stick a label or adhesive tape on the disc.
- Do not drop or bend the disc.

Storing Disc

- Store the disc in the case to avoid risk of scratches, dirt or damage.
- Do not leave disc exposed to direct sunlight or in hot or humid places.

Cleaning Disc

Wipe the disc with a clean, dry cloth from center to edge.

- Do not wipe the disc around in a circle.
- Do not use liquid or aerosol cleaners.

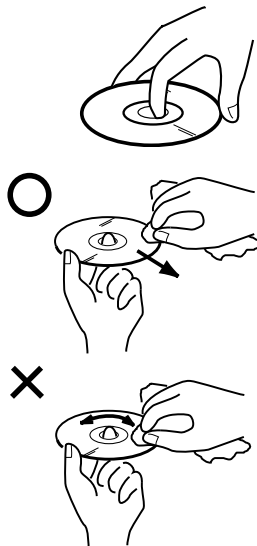

Preparation / Status display of disc

The following pages describe the setup/operation in DVD mode.

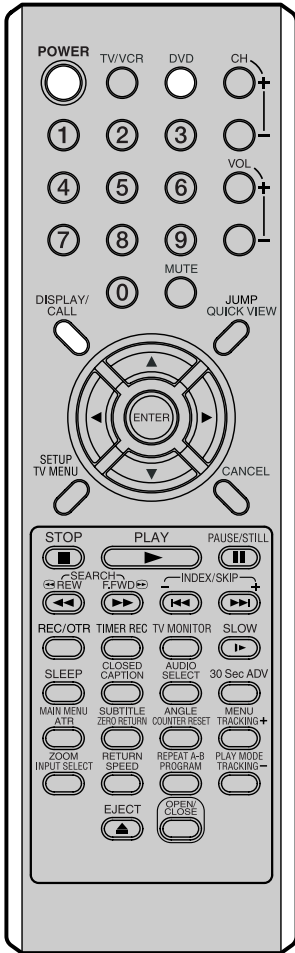

NOTE:

If the TV/VCR/DVD does not operate properly: Static electricity, etc., may affect the player's operation. Disconnect the AC power cord once, then connect it again.

Preparation

Before DVD/CD operation, please make preparations as follows.

- 1 Insert the AC cord plug into a standard 120V 60Hz polarized AC outlet.
 - If the AC cord plug is plugged in for the first time, wait for about 5 seconds before pressing **POWER**.
- NOTE:** When connecting to other equipment, unplug the TV/VCR/DVD from the AC outlet.
- 2 Press **POWER** on the TV/VCR/DVD or on the remote control to turn on the TV/VCR/DVD. The POWER indicator will light.
 - Every time you press **POWER**, the TV/DVD starts from TV mode.
 - When using an amplifier, switch on the amplifier.
- 3 Press **DVD** to select DVD mode. The DVD startup screen will appear on the screen.



Status display of disc

Press **DISPLAY/CALL** once. Only the "title elapsed playing time" and the "title total time" appear in the upper right of the screen. Press **DISPLAY/CALL** again. The full information will appear.

DVD

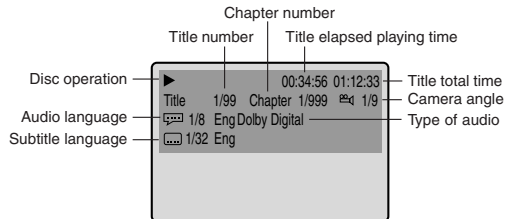

To make status display disappear, press **DISPLAY/CALL** again.

Audio CD

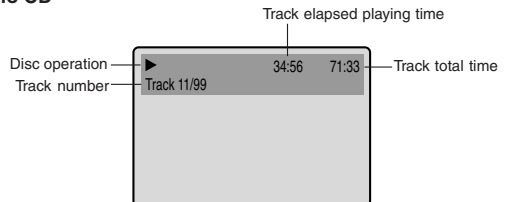

- When you play a CD disc, the status display will appear and remain on the screen.

Setting the setup language

You can change the default settings to customize performance to your preference.

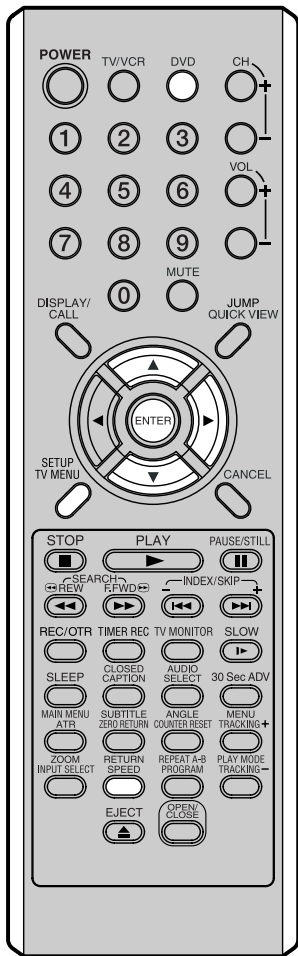

1 Press **DVD** to select the DVD mode. "No Disc" will appear on the screen. (If a DVD disc has already loaded, the playback will start automatically.)



2 Press **SETUP** in the stop mode. The **SETUP MENU** of DVD will appear on the screen. Then press **▶** to select "Other".

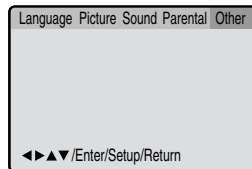

3 Press **▼** or **ENTER** to select "OSD Language".

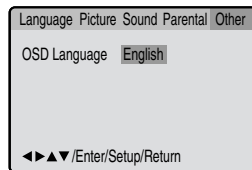

4 Press **▶** or **ENTER** and then press **▲** or **▼** to select desired language (e.g. English), then press **ENTER**.

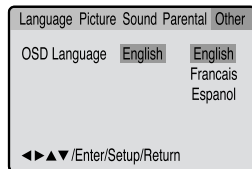

5 Press **SETUP** or **RETURN** to remove the MENU screen.

If the TV/VCR/DVD does not operate properly:

Static electricity, etc., may affect the player's operation. Disconnect the AC mains lead once, then connect it again.

Playback procedure

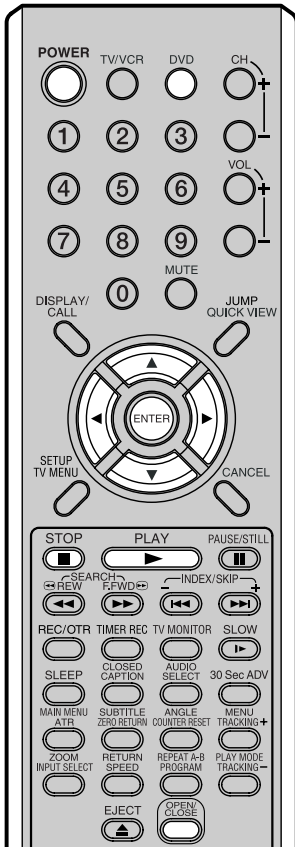

- 1 Press **DVD** to select DVD mode. Press **OPEN/CLOSE** on the TV/VCR/DVD or the remote control.
The disc tray will open.

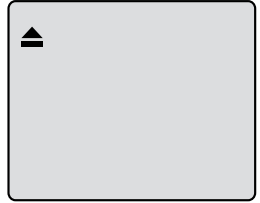

- 2 Place a disc onto the tray. Position it with the printed label side up, align it with the guides, and place it in its proper position.

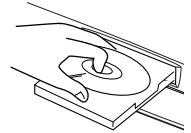

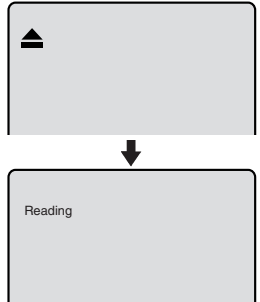

- 3 Press **OPEN/CLOSE** or **▶ (PLAY)**. The disc tray closes automatically. On the TV-screen, **▲** changes to "Reading" and then playback commences.



- A menu screen will appear on the TV screen, if the disc has a menu feature. In this case, press **▲**, **▼**, **◀**, **▶** or **ENTER** to operate a menu feature.

NOTES:

- If a non-compatible disc is loaded, "Incorrect Disc", "Region Code Error" or "Parental Error" will appear on the TV screen according to the type of loaded disc. If these appear, check your disc again (see pages 44 and 60).
- Some discs may take a minute or so to start playback.
- A "Prohibition" symbol  may appear at the upper left of the screen. This symbol means either the feature you tried is not available on the disc, or the TV/VCR/DVD can not access the feature at this time. This does not indicate a problem with the TV/VCR/DVD.
- When you set a single-faced disc label downwards (ie. the wrong way up) and press **PLAY** or **OPEN/CLOSE** on the TV/VCR/DVD, "Reading" will appear on the display for about 30 seconds and then "No Disc" or "Incorrect Disc" will be displayed.
- Some playback operations of DVDs may be intentionally fixed by software producers. Since this TV/VCR/DVD plays DVDs according to the disc contents the software producers designed, some playback features may not be available. Also refer to the instructions supplied with the DVDs.

- 4 Press **STOP** to end playback.
 - The TV/VCR/DVD memorizes the stopped point, depending on the disc. " appears on the screen. Press **PLAY** to resume playback (from the scene point).
 - If you press **STOP** again or unload the disc (" appears on the screen.), the TV/VCR/DVD will clear the stopped point.
- 5 Press **OPEN/CLOSE**. The disc tray opens. Remove the disc and press **POWER**. The disc tray closes automatically and TV/VCR/DVD turns off.

Special playback

There may be a slight delay between when you press the button and the function activating.

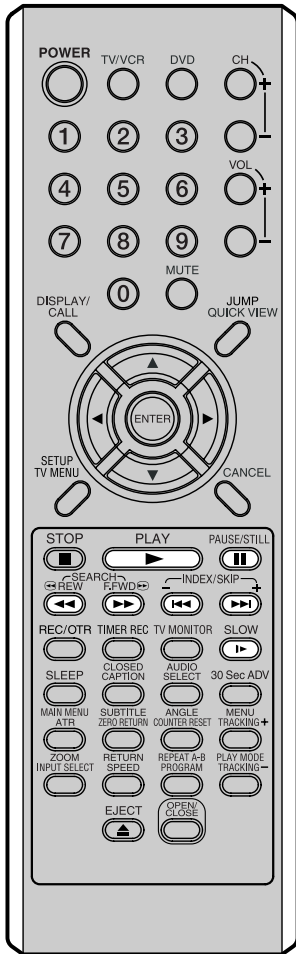

WARNING:

The TV/VCR/DVD is capable of holding a still video image or on-screen display image on your television screen indefinitely. If you leave the still video image or on-screen display image displayed on your TV for an extended period of time, you risk permanent damage to your television screen. Projection screen televisions are especially susceptible to such damage.

Fast Forward Playback

Press **SEARCH** ►► during normal playback.

Each press of the **SEARCH** ►► button will increase the speed of the search ►► (x 2), ►►► (x 4), ►►►► (x 8), ►►►►► (x 15). (CD: ►► (x 2), ►►► (x 4), ►►►► (x 8), ►►►►► (x 20))

- To resume normal playback, press **PLAY**.

Review Playback

Press **SEARCH** ◀◀ during normal playback.

Each press of the **SEARCH** ◀◀ button will increase the speed of the search ◀◀ (x 2), ◀◀◀ (x 4), ◀◀◀◀ (x 8), ◀◀◀◀◀ (x 15). (CD: ◀◀ (x 2), ◀◀◀ (x 4), ◀◀◀◀ (x 8), ◀◀◀◀◀ (x 20))

- To resume normal playback, press **PLAY**.

Still Playback

Press **PAUSE/STILL** during normal playback to pause playback.

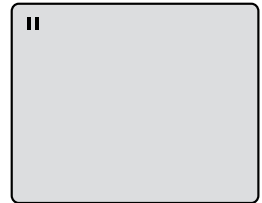

- To resume normal playback, press **PLAY**.

Frame Advance

Press **PAUSE/STILL** during still playback.

One frame is advanced each time you press **PAUSE/STILL**.

- To resume normal playback, press **PLAY**.

Slow-motion Playback

Press **SLOW** (►|) during normal playback or still playback. Each press of **SLOW** will change the speed of the slow x1/2, x1/4, x1/6, x1/7.

- To resume normal playback, press **PLAY**.
- To resume the still playback, press **PAUSE/STILL**.

Locating a chapter or track

Press **SKIP**(►►►) Forward or **SKIP**(◀◀◀) Reverse during playback to locate a chapter that you want to watch. Each time you press the button, a chapter or track is skipped.

mp3/WMA/JPEG playback

mp3/WMA/JPEG CD Information

This player can play back mp3/WMA/JPEG files recorded on a CD-R or CD-RW.

mp3 is an audio file format, which compresses recorded music. It was developed by Fraunhofer Gesellschaft in collaboration with Thomson Inc. The main advantage of the mp3 format is that it means CD-quality music tracks can be stored on a personal computer.

WMA (Windows Media Audio) is another audio file format developed by Microsoft.

JPEG files are image files.

To create these files you need a Windows-PC with CD-ROM drive and mp3/WMA/JPEG-encoding software (not supplied).

The Apple-HFS-System cannot be played.

Playback Limitations

- File names on a mp3/WMA/JPEG CD must include 3-digit extension letters such as, "mp3", "wma" or "jpg".
- This unit can read 200 files per disc. Keep directory sizes to 200 files or less. Anything over that limit will be omitted.
- This unit is able to recognize up to a maximum of 50 directories per disc.
- If a CD has both audio and graphic files on the same CD, only the audio tracks will play.
- It may take more than one minute for mp3/WMA/JPEG files to play depending on their structure.
- Music recorded by "Joliet Recording Specification" can be played back.
- The unit can play back baseline and progressive JPEG files.
- Music files recorded by "Hierarchical File System" (HFS) cannot be played.

Notes on mp3/WMA/JPEG files

- To play mp3/WMA/JPEG files in the recorded order,
1. Use mp3/WMA/JPEG software that records data alphabetically or numerically.
 2. Name each file including a two-digit or three-digit number (e.g. "01" "02" or "001" "002").
 3. Refrain from creating too many subfolders.

Limitations on display

- File names are displayed (within 16 characters) on the screen. File names longer than 16 letters are condensed.
- Available letters for display are the following: capital or small letters A through Z, numbers 0 through 9, and _ (under score).
- Letters other than those above are replaced with a hyphen. Press **ENTER**. The selected file starts playing back. Press **■ (STOP)** to end playback.

CAUTION:

- Some mp3/WMA/JPEG files cannot be played back depending on the recording conditions.
- The CD-R/RW that has no music data or non-mp3/WMA/JPEG files cannot be played back.

mp3/WMA CD playback

- 1 Press **OPEN/CLOSE**.
The disc tray will open.
Place a disc on which mp3 or WMA files have been recorded onto the tray.

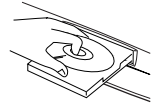

- 2 Press **OPEN/CLOSE** or **▶ (PLAY)**.
The disc tray closes automatically. On the TV-screen, "Reading" will appear. Reading will take as much time as the number of file.

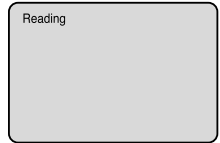

- 3 A file menu screen will appear on the TV screen.

Press **◀/▶** to select folder.

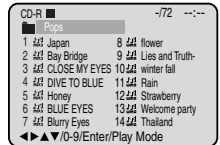

- 4 Press **▲/▼** or **◀/▶** or the **number buttons (0-9)** to select the desired file.

- In case the folder includes more than 15 files, press **◀** or **▶** to display next file list.

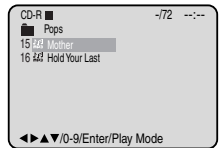
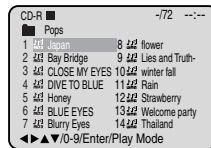

- When **▶ (PLAY)** has been pressed after displaying the file menu, or when the disc tray has been closed after pressing **▶ (PLAY)** in step 2, playback begins automatically starting from the first file. In this case, if the first file is an mp3/WMA file, only mp3/WMA files are played back in order. If the first file is a JPEG file, the first JPEG file is played back.

- 5 Press **ENTER**.
The selected file starts playing back.

- 6 Press **■ (STOP)** to end playback.
- The TV/VCR/DVD records the stopped point. "■" appears on the screen. Press **▶ (PLAY)** to resume playback (from the scene point).
 - If you press **■ (STOP)** again or unload the disc, the TV/VCR/DVD will clear the stopped point.

NOTES:

- During mp3/WMA/JPEG-Playback, you cannot use SEARCH, A-B Repeat functions.
- You can use Repeat (Track or All), Random functions and Program playback for mp3/WMA/JPEG CD Playback (see pages 54, 55).
- In the case of a CD containing a mixture of mp3, WMA and JPEG files, the files are played back by selecting them from the file menu.

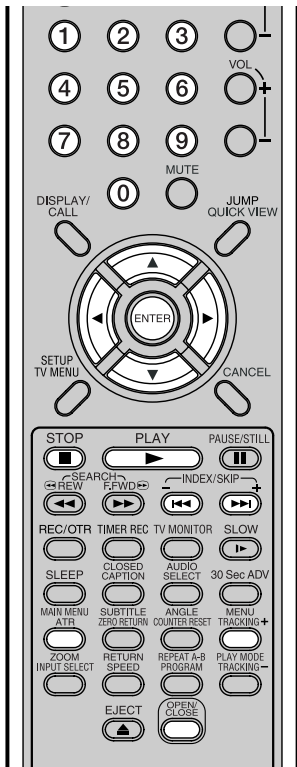

JPEG CD playback

- 1 Press **OPEN/CLOSE**.
The disc tray will open.
Place a disc on which JPEG files have been recorded onto the tray.

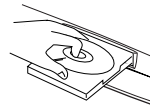

- 2 Press **OPEN/CLOSE** or **▶ (PLAY)**. The disc tray closes automatically. On the TV-screen, "Reading" will appear. Reading will take as much time as the number of file.

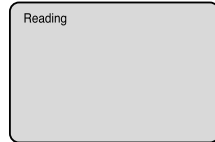

- 3 A file menu screen will appear on the TV screen.
Press **◀/▶** to select folder.

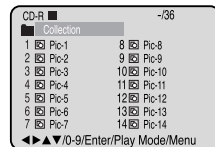

- 4 Press **▲/▼** or **◀/▶** or the **number buttons (0-9)** to select the desired file.

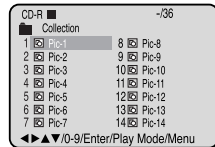

To display a picture menu, press **MENU**. (To return to a file menu, press **MAIN MENU**.)

Press **▲/▼** or **◀/▶** to select the desired file.

- To display next list, press **SKIP**



▶▶ / ◀◀

- When **▶ (PLAY)** has been pressed after displaying the file menu, or when the disc tray has been closed after pressing **▶ (PLAY)** in step 2, playback begins automatically starting from the first file. In this case, if the first file is a JPEG file, the first JPEG file is played back. If the first file is an mp3/WMA file, only mp3/WMA files are played back in order.

- 5 Press **ENTER**.
The selected picture appears on the TV screen.

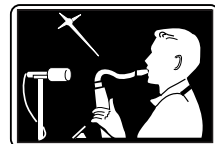

- 6 Press **■ (STOP)** to end playback.
The file menu appears on the TV screen.
If you want to watch another file, repeat steps 4-5.

About file menu

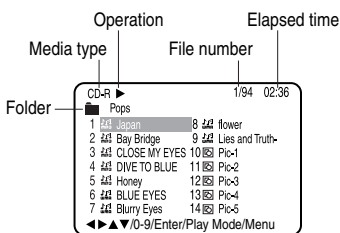

: Indicates mp3 file

: Indicates WMA file

: Indicates JPEG file

NOTES:

- The picture menu is displayed when the FUJICOLOR CD or the Kodak Picture CD are played. To display the file menu press **MAIN MENU**.
- mp3 or WMA file on the KODAK Picture CD is not recognized on this TV/VCR/DVD.

Setting the JPEG interval

Setting the JPEG Interval

You can continuously play back all JPEG files automatically.

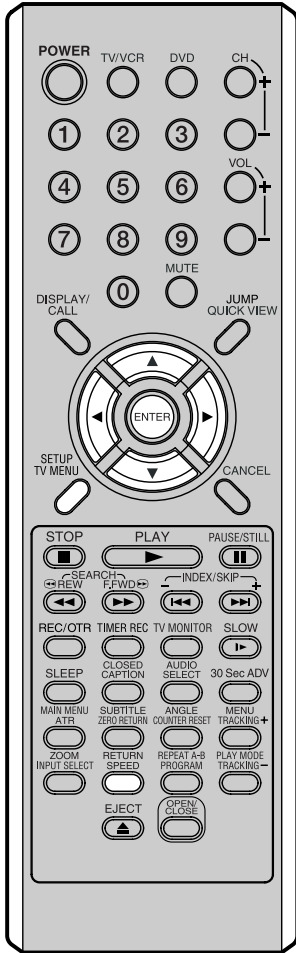

- 1 Press **SETUP** in the stop mode.
Press **◀/▶** to select "Picture", then press **▼** or **ENTER**.

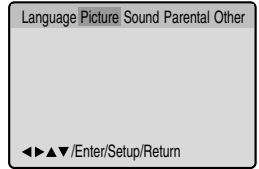

- 2 Press **▲** or **▼** to select "JPEG Interval".

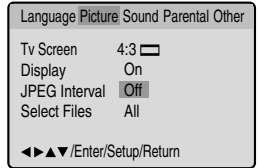

- 3 Press **ENTER** or **◀/▶** to select your desired time.

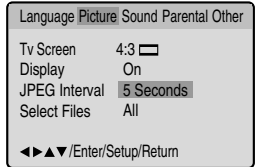

Off:
Plays back one file at a time.

5 Seconds:
Displays images in the form of a slide show. Every 5 seconds the image changes.

10 Seconds:
Displays images in the form of a slide show. Every 10 seconds the image changes.

15 Seconds:
Displays images in the form of a slide show. Every 15 seconds the image changes.

- 4 Press **SETUP** or **RETURN** to remove the MENU screen.

Setting the select files

When playing back a CD containing a mixture of mp3, WMA and JPEG files, only mp3/WMA or JPEG files can be displayed on the file menu.

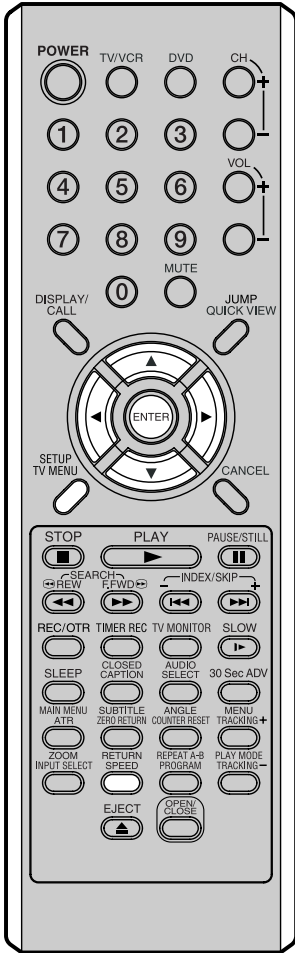

- 1 Press **SETUP** in the stop mode. Press **◀/▶** to select "Picture", then press **▼** or **ENTER**.

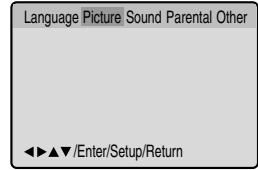

- 2 Press **▲** or **▼** to select "Select Files".

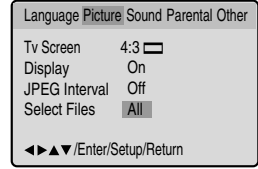

- 3 Press **ENTER** or **◀/▶** to select your desired file type.

All:
Displays all files.

Music Only:
Displays only mp3/WMA files.

Pictures Only:
Displays only JPEG files.

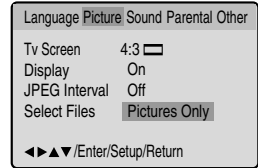

- 4 Press **SETUP** or **RETURN** to remove the MENU screen.

Zooming / Locating desired scene

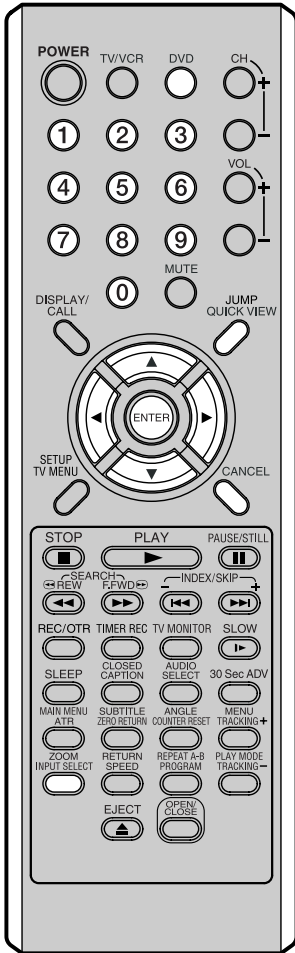

Zooming

This TV/VCR/DVD will allow you to zoom in on the frame image. You can then make selections by switching the position of the frame.

- 1 Press **DVD** to select DVD mode.
Press **ZOOM** during playback.
The center part of the image will be zoomed in.
Each press of **ZOOM** will change the ZOOM Q 1 (x 1.3), Q 2 (x 1.5), Q 3 (x 2.0).

Q 1

- 2 Press **▲/▼/◀/▶** to view a different part of the frame. You may move the frame from the center position to UP, DOWN, LEFT or RIGHT direction.
- 3 In the zoom mode press **ZOOM** repeatedly to return to a 1:1 view (Q Off).

Locating Desired Scene

Use the title, chapter and time recorded on the disc to locate the desired point to play back.

- 1 Press **JUMP** during playback.

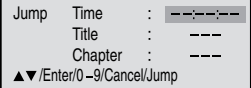

- 2 Press **▲** or **▼** to select the "Time", "Title" or "Chapter".
- 3 Press the **number buttons (0-9)** to input the number.

- If you input a wrong number, press **CANCEL**.
- Refer to the package supplied with the disc to check the numbers.

- 4 Press **ENTER**.

- Playback starts.
- When you change the title, playback starts from Chapter 1 of the selected title.
- Some discs may not work in the above operation.

NOTES:

- You can select the Pause, Slow or Search playback in the zoom mode.
- Some discs may not respond to zoom feature.

Repeat playback

Title, Chapter, Track Playback

- 1 Press **PLAY MODE** during playback or stop mode.

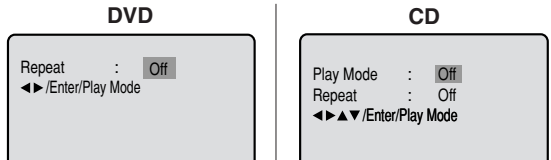
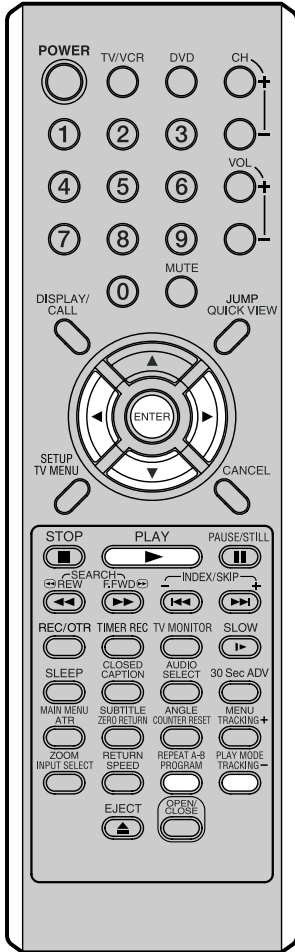

- 2 Press **◀** or **▶** or **ENTER** once or twice to select “Chapter” or “Title”.
In case of CD, at first press **▼** to select “Repeat” and then press **◀** or **▶** or **ENTER** once or twice to select “Track” or “All”.

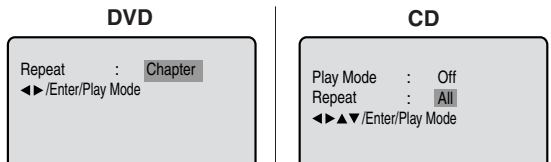

- 3 Press **PLAY MODE** again to make the screen disappear.
 - Press **PLAY** to start Repeat playback.
 - To resume normal playback, select Repeat “Off”.

A-B Repeat Playback

A-B repeat playback allows you to repeat material between two selected points.

- 1 Press **REPEAT A-B** during playback.
The start point is selected.

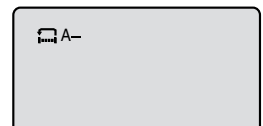

- 2 Press **REPEAT A-B** again.
The end point is selected. Playback starts at the point that you selected. Playback stops at the end point, returns to Point A automatically, then starts again.

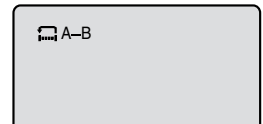

To resume normal playback press **REPEAT A-B** again.
“Off” appears on the screen.

NOTES:

- Some discs may not work with the repeat operation.
- In A-B repeat mode, subtitles near point A or B may not appear.
- During the A-B Repeat Playback the ANGLE feature will not operate.
- You may not be able to set A-B Repeat, depending on the scenes of the DVD.

Program playback/Random playback (CD)

Program playback

You can arrange the order of tracks on the disc.

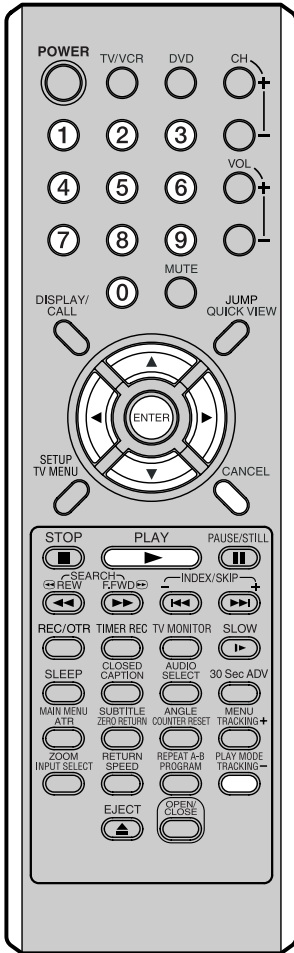

- 1 Press **PLAY MODE** in the stop mode.

```
Play Mode : Off
Repeat    : Off
◀▶▶▶/Enter/Play Mode
```

- 2 Press **▲** or **▼** to select "Play Mode", then press **◀** or **▶** or **ENTER** to select "Program".

```
Play Mode : Program
Repeat    : Off
1 --- 4 --- 7 --- 10 ---
2 --- 5 --- 8 --- 11 ---
3 --- 6 --- 9 --- 12 ---
Clear    Program Playback
◀▶▶▶/Enter/0-9/Cancel/Play Mode
```

- 3 **Example:** In case you wish to program in order of 7, 3, 11: Enter as **7 ▼, 3 ▼, 11.**

If you input a wrong number, press **CANCEL**.

```
Play Mode : Program
Repeat    : Off
1 7 --- 4 --- 7 --- 10 ---
2 3 --- 5 --- 8 --- 11 ---
3 11 --- 6 --- 9 --- 12 ---
Clear    Program Playback
◀▶▶▶/Enter/0-9/Cancel/Play Mode
```

- 4 Press **▲/▼** or **◀/▶** to select "Program Playback" and press **ENTER**. "Program Playback" will appear on the screen. The program you selected will begin to playback in the order set. To return to normal playback, select "Play Mode: Off" at step 2 above.

```
Program Playback 02:31 08:29
Track 7/11
```

Random playback

- 1 Press **PLAY MODE** during playback or stop mode.

```
Play Mode : Off
Repeat    : Off
◀▶▶▶/Enter/Play Mode
```

- 2 Press **▲** or **▼** to select "Play Mode", then press **◀/▶** or **ENTER** to select "Random".

```
Play Mode : Random
Repeat    : Off
◀▶▶▶/Enter/Play Mode
```

- 3 Press **PLAY**. "Random Play" will appear on the screen and Random Playback will start.

NOTES:

- To cancel program play, select "Clear" at step 4 and press **ENTER**.
- The program is cancelled when you open the disc tray or turn the power off.
- Random playback can not be combined with Repeat playback.

Changing soundtrack language / Subtitles / Karaoke playback

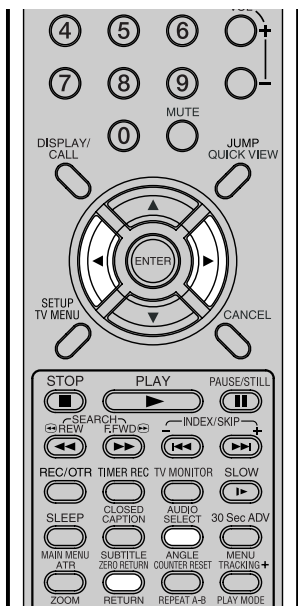

NOTES:

- If the desired language is not heard after pressing **AUDIO SELECT** several times, the language is not recorded on the disc.
- Changing soundtrack language is cancelled when you open the disc tray. The initial default language or available language will be heard if the disc is played back again.
- Changing subtitle language is cancelled when you open the disc tray or turn the power off.
- Some functions may not work on some DVDs. You may not be able to turn subtitles on or off or change subtitles. While playing the DVD, the subtitle may change when:
 - you open or close the disc tray
 - you change the title.
- In some cases, the subtitle language is not changed to the selected one immediately.
- The vocal output feature is used during playback of Dolby Digital (multi-channel) recorded DVD KARAOKE discs. This feature allows you to turn off vocal audio tracks, or restore them for background accompaniment.
- When playing KARAOKE, connect appropriate audio equipment such as an amplifier to the TV/DVD.

Changing soundtrack language

You can select the language when you play a multilingual disc.

- 1 Press **AUDIO SELECT** during playback.

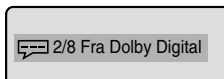

The current soundtrack language will appear.

- 2 Press **AUDIO SELECT** repeatedly until the desired language is selected.

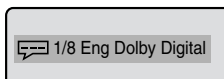

The on-screen display will disappear after a few seconds.

Subtitles

Turning the subtitles on and off

When playing back a disc recorded with subtitles, you can turn the subtitles on or off.

Press **SUBTITLE** during playback until "Off" appears.



Changing the subtitle language

You can select the language when playing back a disc recorded with multi-lingual subtitles.

- 1 Press **SUBTITLE** repeatedly during playback until your desired language appears.

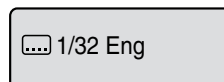

- 2 The on-screen display will disappear after a few seconds.

Karaoke playback

When playing back a DVD KARAOKE disc, you can turn the vocal on or off.

- 1 Press **AUDIO SELECT** during DVD KARAOKE disc playback.

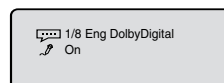

- 2 Press **◀** or **▶** to select "On" or "Off".

On: The primary vocal is output when it is recorded on the disc.

Off: The primary vocal is not output.

Changing angles / Title selection / DVD menu

Changing angles

When playing back a disc recorded with multi-angle facility, you can change the view angle.

- 1 Press **ANGLE** during playback.

The current angle will appear.

NOTE :

In case of JPEG-playback, the JPEG-image is rotated 90 degrees to the right.

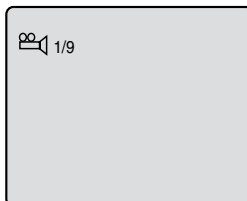

- 2 Press **ANGLE** repeatedly until the desired angle is selected.

Title selection

Two or more titles are recorded on some discs. If the title menu is recorded on the disc, you can select the desired title.

- 1 Press **MAIN MENU** during playback.
Title menu appears on the screen.
- 2 Press **▲/▼** or **◀/▶** to select the desired title.
- 3 Press **ENTER** or **▶ (PLAY)**.
The playback of the selected title will start.

DVD menu

Some DVDs allow you to select the disc contents using the menu.

When you play back these DVDs, you can select the subtitle language and sound-track language, etc. using the DVD menu.

- 1 Press **MENU** during playback.
The DVD menu appears on the screen.
 - Press **MENU** again to resume playback at the scene when you pressed **MENU**.
- 2 Press **▲/▼** or **◀/▶** to select the desired item.
- 3 Press **ENTER**.
The menu continues to another screen. Repeat steps 2 and 3 to set additional items if any.

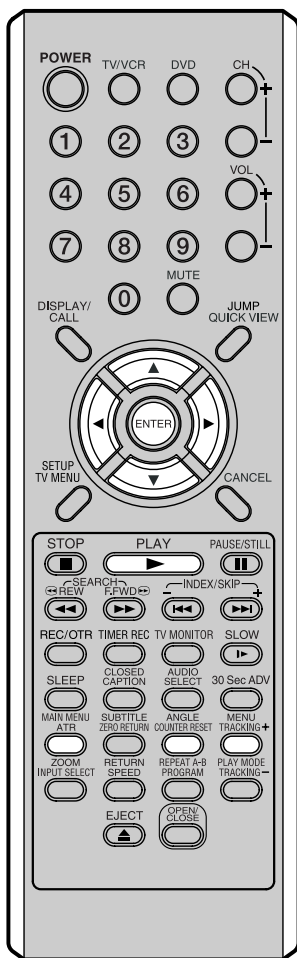

NOTES:

- Depending on the DVD, you may not be able to change the angles even if multi-angles are recorded on the DVD.
- Depending on the DVD, you may not be able to select the title. Depending on the DVD, a "title menu" may simply be called a "menu" or "title" in the instructions supplied with the disc.

Setting the aspect ratio of TV screen/Setting on screen display

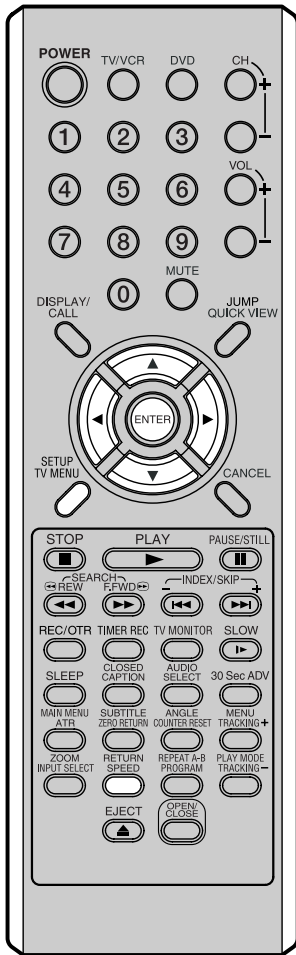

NOTE:

It is not always possible for the DVD disc to display the picture as per your preferred picture setting - for example, if you select "4:3 Panscan", the disc may not offer this option. In this case the picture would display in whichever format the disc is capable of playing back.

Setting the aspect ratio of TV screen

You can select the aspect ratio of the picture.

- 1 Press **SETUP** in the stop mode or No Disc.
Press **◀** or **▶** to select "Picture".

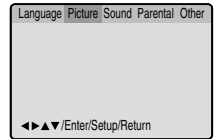

- 2 Press **▼** or **ENTER**, then press **▲** or **▼** to select "Tv Screen".

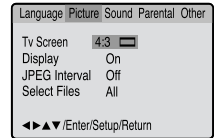

- 3 Press **▶** or **ENTER**.
Press **▲** or **▼** to select your desired screen type, then press **ENTER**.

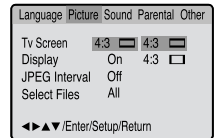

You have the following screen sizes to choose from:

4:3 Letter box

When playing back a wide screen-DVD disc, it displays the wide picture with black bands at the top and bottom of screen.

4:3 Pan scan

It displays the wide picture on the whole screen with left and right edges automatically cut off.

- 4 Press **SETUP** or **RETURN** to remove the Menu screen.

Status on screen display

On screen display can be switched on or off when you press the **DISPLAY** button.

- 1 Press **SETUP** in the stop mode or No Disc.
Press **◀** or **▶** to select "Picture".
- 2 Press **▼** or **ENTER**, then press **▲** or **▼** to select "Display".

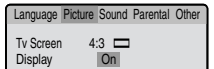

- 3 Press **▶** or **ENTER** to select "On" or "Off".

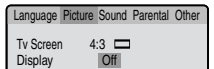

- On:** On screen displays appear when you press the buttons (factory setting).
- Off:** On screen displays do not appear when you press any buttons except **SETUP**, **SEARCH MODE**, **PLAY MODE** and **DISPLAY**.

- 4 Press **SETUP** or **RETURN** to remove the MENU screen.

Dynamic Range Control

DRC (Dynamic Range Control) enables you to control the dynamic range so as to achieve a suitable sound for your equipment.

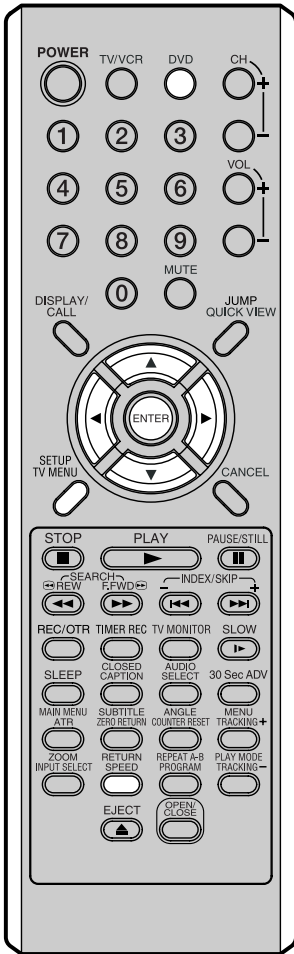

- 1 Press **DVD** to select DVD mode.
Press **SETUP** in the stop mode or No Disc.
Press **◀** or **▶** to select "Sound".

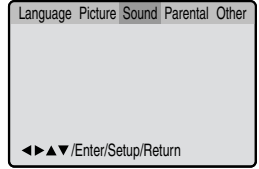

- 2 Press **▼** or **ENTER** to select "DRC".

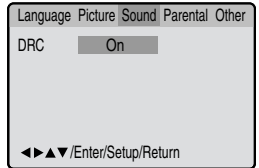

- 3 Press **▶** or **ENTER**, then press **▲** or **▼** to select "On" or "Off", then press **ENTER**.

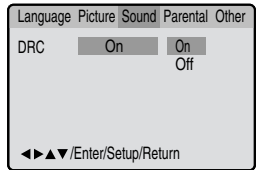

- 4 Press **SETUP** or **RETURN** to remove the MENU screen.

NOTES:

- This function works only during playback of Dolby Digital recorded discs.
- The level of Dynamic Range Reduction may differ depending on DVD video disc.

Parental control setting

If you want to limit the types of discs that can be played, use the Parental Control feature.

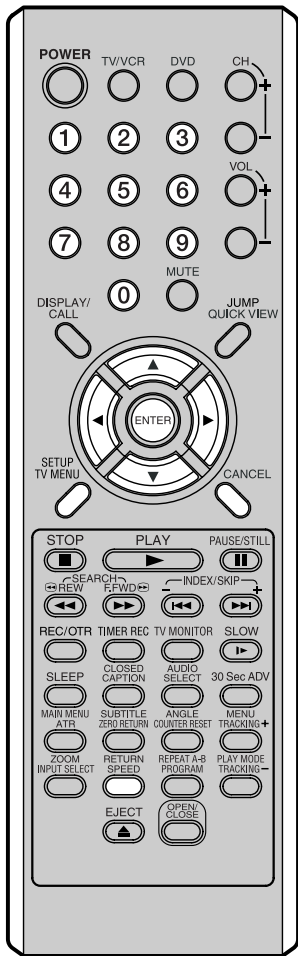

NOTES:

- If each setup (P.46, 51, 52, 58~61, 63~65) has been completed, the TV/VCR/DVD will work under the same conditions (especially with DVD discs).

Each setup will be retained in the memory when you turn the power off.

- Depending on the discs, the TV/VCR/DVD cannot limit playback.
- Some discs may not be encoded with specific rating level information though its disc jacket says "adult." For those discs, the age restriction will not work.

- 1 Press **SETUP** in the stop mode or No Disc.
Press **◀** or **▶** to select "Parental". Then press **▼** or **ENTER**.

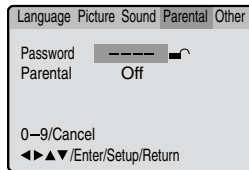

- 2 Press **▼** to select "Parental", then press **◀** or **▶** until the level you require appears.

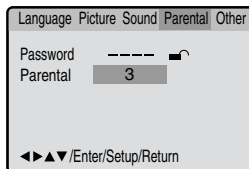

- **Level Off** : The parental control setting does not function.
- **Level 8** : Virtually all DVD software can be played back.
- **Level 1** : DVD software for adults cannot be played back.
- Select from level 1 to level 8. The limitation will be more severe as the level number decreases.

- 3 Press **▲** to select "Password".
Press the **number buttons (0-9)** to input a 4-digit password. Be sure to remember this number!
• If you input a wrong number, press **CANCEL**.

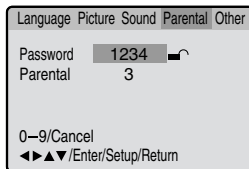

- 4 Press **ENTER** to store the password.
NOTE: Now the rating is locked and the setting cannot be changed unless you enter the correct password.

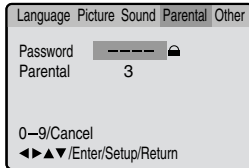

- 5 Press **SETUP** or **RETURN** to remove the MENU screen.

Changing the parental level

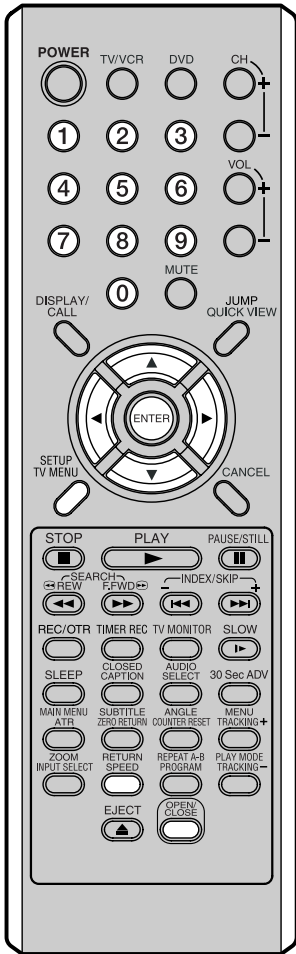

NOTE:

If you forget the password...

1. Press **OPEN/CLOSE** to open the disc tray.
2. Remove the disc.
3. Press **OPEN/CLOSE** again to close the disc tray.
"No Disc" appears on the screen.
4. While holding **STOP** down on the front panel, press **2** on the remote control.
"PASSWORD CLEAR" appears on the screen.
5. Enter a new password again.

- 1 Press **SETUP** in the stop mode or No Disc.
Press ◀ or ▶ to select "Parental". Then press ▼ or **ENTER**.

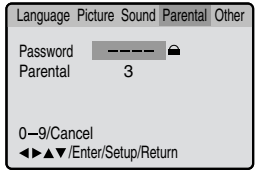

- 2 Press the **number buttons (0-9)** to enter the password you have stored.

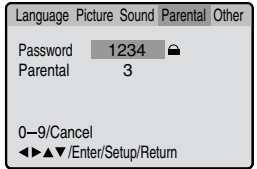

- 3 Press **ENTER**.
The rating is now unlocked.

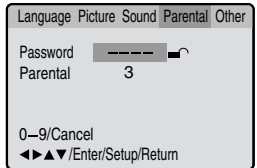

- 4 Press ▼ to select "Parental", then press ◀ or ▶ to change the parental level.

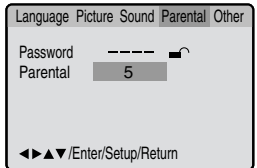

- 5 Press ▲ to select "Password", then press the **number buttons (0-9)** to enter the password.
NOTE: You can change the password at this time if you want.

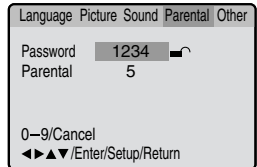

- 6 Press **ENTER**.
The parental level is changed and locked.

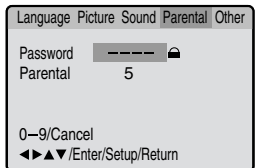

- 7 Press **SETUP** or **RETURN** to remove the MENU screen.

Temporary disabling of rating level by DVD disc

Depending on the DVD disc, the disc may try to temporarily cancel the rating level that you have set. It is up to you to decide whether to cancel the rating level or not.

- 1 Load a DVD disc and press **PLAY** or **OPEN/CLOSE** (see page 47).

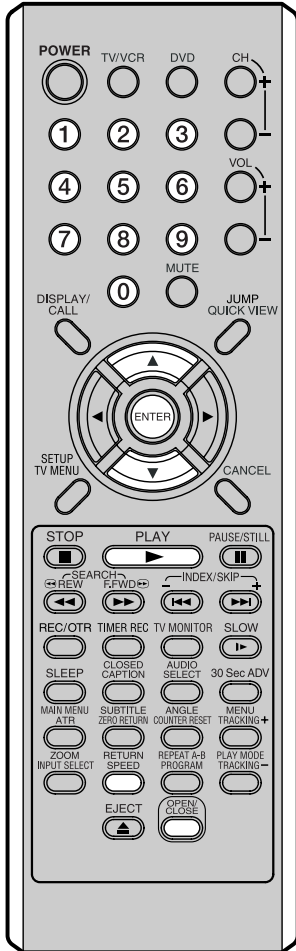
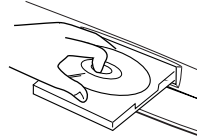

- 2 If the DVD disc has been designed to temporarily cancel the Rating level, the screen which follows the "Reading" screen will change, depending on which disc is played. If you select "YES" with **ENTER** key, "Your disc exceeds the parental control level 1." (e.g.) screen will then appear.

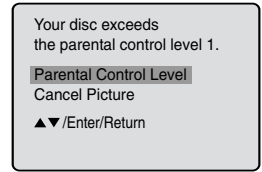

- 3 If you wish to cancel the set rating level temporarily, select "Parental Control Level" with **▲** or **▼**, then press **ENTER**. If the 4-digits password at step 3 on page 60 has been set, the password entering screen will appear as shown in step 4 below. Alternatively, if the password has not been set, playback will commence. If you don't know (or have forgotten) the password, select "Cancel Picture". The setting screen will disappear. Press **OPEN/CLOSE** to remove the disc.

- 4 Enter the password with **Direct Channel Selection (0-9)**. Then press **ENTER**.

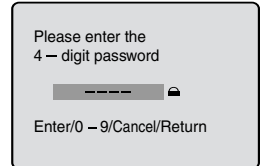

If you interrupt the entering, press **RETURN**.

- 5 Playback will commence if the entered password was correct.

NOTE:

This temporary cancellation of rating level will be kept until the disc is ejected. When the disc is ejected, the original rating level will be set again automatically.

Setting the menu language

You can select the language of the disc menu messages of DVDs.

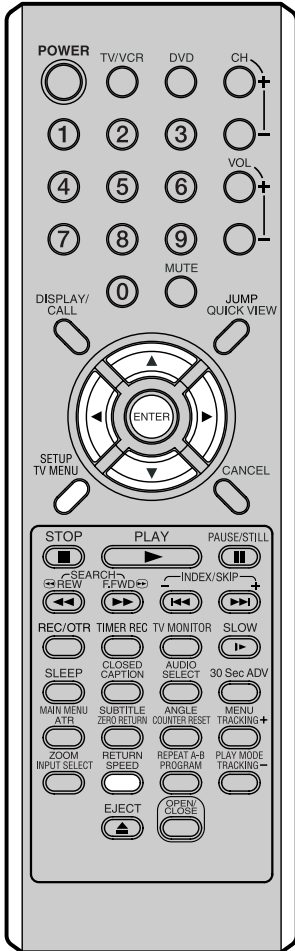

- 1 Press **SETUP** in the stop mode.
Press ◀ or ▶ to select "Language".

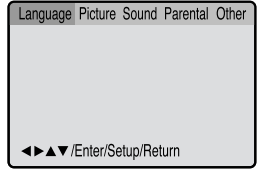

- 2 Press ▼ or **ENTER**.
Then press ▲ or ▼ to select "Menu".

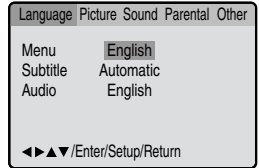

- 3 Press ▶ or **ENTER**.
Press ▲ or ▼ to select your desired language, then press **ENTER**.

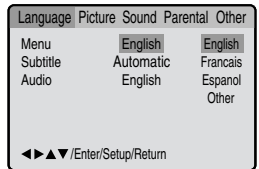

English, Francais, Espanol:

The selected language will be heard or seen.

Other:

Other language can be selected (see the "Language code list" on page 66).

- 4 Press **SETUP** or **RETURN** to remove the MENU screen.

Setting the subtitle language

The same subtitle language can always be selected even if you replace the disc or turn the power off.

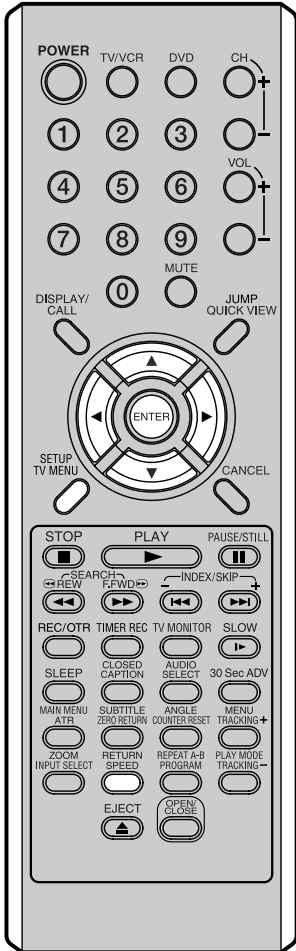

- 1 Press **SETUP** in the stop mode. Press **◀** or **▶** to select "Language".

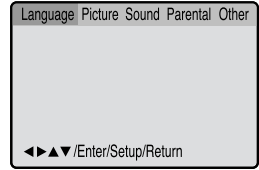

- 2 Press **▼** or **ENTER**. Then press **▲** or **▼** to select "Subtitle".

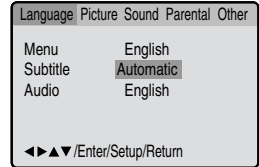

- 3 Press **▶** or **ENTER**. Press **▲** or **▼** to select your desired language, then press **ENTER**.

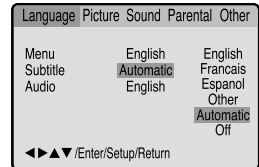

English, Francais, Espanol:

The subtitle is displayed with the selected language if it is recorded on the disc.

Other:

If you want to select another language, enter the language code (See the "Language code list" on page 66).

Automatic:

- The TV/VCR/DVD will automatically select the same language in the AUDIO setting.
- When the TV/VCR/DVD selects the same language as the AUDIO, the subtitles will not appear during playback.
- When you do not use the same language as the AUDIO, the subtitles will appear during playback.

Off:

Subtitles do not appear.

- 4 Press **SETUP** or **RETURN** to remove the MENU screen.

NOTE:

If the selected language is not recorded on the disc, the first priority language is selected.

Setting the audio soundtrack language

The same audio soundtrack language can always be selected by your TV/VCR/DVD even if you replace the disc or turn the power off.

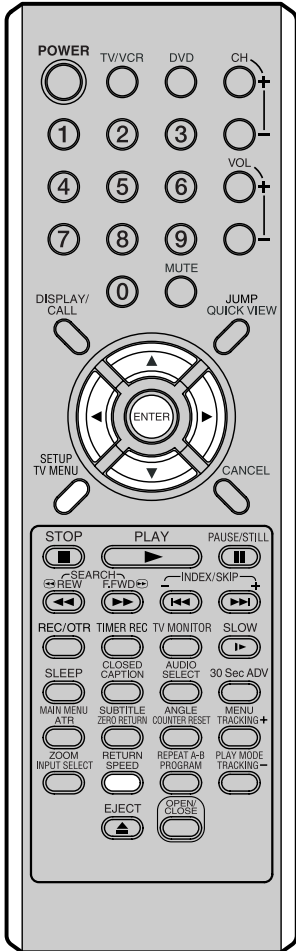

- 1 Press **SETUP** in the stop mode.
Press **◀** or **▶** to select "Language"

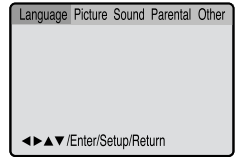

- 2 Press **▼** or **ENTER**.
Then press **▲** or **▼** to select "Audio".

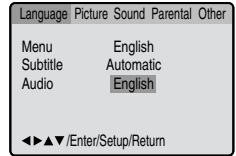

- 3 Press **▶** or **ENTER**.
Press **▲** or **▼** to select your desired Audio Language, then press **ENTER**.

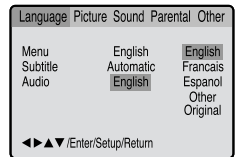

English, Francais, Espanol:

The language you have selected will play if it is recorded on the disc.

Other:

If you want to select another language, enter the language code (See the "Language code list" on page 66).

Original:

The TV/VCR/DVD will select the first priority language of each disc.

- 4 Press **SETUP** or **RETURN** to remove the MENU screen.

NOTE:

If the selected language is not recorded on the disc, the original language will be heard.

Language code list

Enter the appropriate code number for the initial settings "Menu", "Subtitle" and/or "Audio" (see pages 63–65).

Language Name	Code	Language Name	Code	Language Name	Code
Abkhazian	1112	Fiji	1620	Lingala	2224
Afar	1111	Finnish	1619	Lithuanian	2230
Afrikaans	1116	French	1628	Macedonian	2321
Albanian	2927	Frisian	1635	Malagasy	2317
Amharic	1123	Galician	1722	Malay	2329
Arabic	1128	Georgian	2111	Malayalam	2322
Armenian	1835	German	1415	Maltese	2330
Assamese	1129	Greek	1522	Maori	2319
Aymara	1135	Greenlandic	2122	Marathi	2328
Azerbaijani	1136	Guarani	1724	Moldavian	2325
Bashkir	1211	Gujarati	1731	Mongolian	2324
Basque	1531	Hausa	1811	Nauru	2411
Bengali; Bangla	1224	Hebrew	1933	Nepali	2415
Bhutani	1436	Hindi	1819	Norwegian	2425
Bihari	1218	Hungarian	1831	Oriya	2528
Breton	1228	Icelandic	1929	Panjabi	2611
Bulgarian	1217	Indonesian	1924	Pashto, Pushto	2629
Burmese	2335	Interlingua	1911	Persian	1611
Byelorussian	1215	Irish	1711	Polish	2622
Cambodian	2123	Italian	1930	Portuguese	2630
Catalan	1311	Japanese	2011	Quechua	2731
Chinese	3618	Javanese	2033	Rhaeto-Romance	2823
Corsican	1325	Kannada	2124	Romanian	2825
Croatian	1828	Kashmiri	2129	Russian	2831
Czech	1329	Kazakh	2121	Samoan	2923
Danish	1411	Kirghiz	2135	Sanskrit	2911
Dutch	2422	Korean	2125	Scots Gaelic	1714
English	1524	Kurdish	2131	Serbian	2928
Esperanto	1525	Laothian	2225	Serbo-Croatian	2918
Estonian	1530	Latin	2211	Shona	2924
Faroese	1625	Latvian, Lettish	2232	Sindhi	2914
				Singhalese	2919
				Slovak	2921
				Slovenian	2922
				Somali	2925
				Spanish	1529
				Sundanese	2931
				Swahili	2933
				Swedish	2932
				Tagalog	3022
				Tajik	3017
				Tamil	3011
				Tatar	3030
				Telugu	3015
				Thai	3018
				Tibetan	1225
				Tigrinya	3019
				Tonga	3025
				Turkish	3028
				Turkmen	3021
				Twi	3033
				Ukrainian	3121
				Urdu	3128
				Uzbek	3136
				Vietnamese	3219
				Volapük	3225
				Welsh	1335
				Wolof	3325
				Xhosa	3418
				Yiddish	2019
				Yoruba	3525
				Zulu	3631

Problems and troubleshooting

Use the following check list for troubleshooting when you have problems with your TV/VCR/DVD. Consult your local dealer or service outlet if problems persist.

Be sure all connections are properly made when using with other units.

SYMPTOMS	CAUSE	POSSIBLE SOLUTIONS	PAGE
POWER			
No power.	The AC power cord is not connected.	Connect the AC power cord to the AC outlet.	5
Although the power is on, the TV/VCR/DVD does not operate.	Cassette or disc is not inserted.	Insert a video cassette or disc.	34, 47
	The TIMER REC buttons are depressed.	Press the TIMER REC buttons.	41
TV BROADCAST RECEPTION			
Poor or no picture.	TV station experiencing problems.	Try another channel.	19
	Picture control is not adjusted.	Check picture control adjustments.	29
	Possible local interference.	Check for source of reception disturbance.	—
Poor or no color.	Antenna (CABLE) connector is not connected or possible local interference.	Check CABLE connection or VHF/UHF antenna, reposition or rotate antenna.	11, 12
	TV station experiencing problems.	Try another channel.	19
	Picture control is not adjusted.	Check picture control adjustments.	29
Picture wobbles or drifts.	Possible local interference.	Check for source of reception disturbance.	—
	Antenna (CABLE) connector is not connected or possible local interference.	Check CABLE connection or VHF/UHF antenna, reposition or rotate antenna.	11, 12
	Cable TV channel is scrambled.	Try another channel.	19
No CABLE reception.	TV station experiencing problems.	Try another channel.	19
	Antenna (CABLE) connector is not connected or possible local interference.	Check CABLE connection or VHF/UHF antenna, reposition or rotate antenna.	11, 12
	CABLE connector is not connected.	Check all CABLE connections.	12
No reception above channel 13.	TV/CABLE Mode menu option is set to the TV mode.	Set the TV/CABLE Menu option to the CABLE mode.	22
	Cable TV service interrupted.	Contact your Cable TV company.	12
	TV/CABLE Mode menu option is not set to the appropriate mode.	Make sure TV/CABLE menu option is in the appropriate mode.	22
Poor or no sound.	UHF antenna is not connected.	Check UHF antenna.	11
	TV station experiencing problems.	Try another channel.	19
	Antenna (CABLE) connector is not connected or possible local interference.	Check CABLE connection or VHF/UHF antenna, reposition or rotate antenna.	11, 12
	Possible local interference.	Check for source of reception disturbance.	—
	The MUTE button is depressed.	Check the MUTE button has not been pressed.	20
TV shuts off.	TV station stopped broadcasting.	Tune new channel.	19
	Sleep timer is set.	Set Sleep Timer to "0".	20
Closed caption is not activated.	TV station experiencing problems or program tuned is not closed captions.	Try another channel.	19
	TV signal is weak.	Check CABLE connection of VHF/UHF antenna, reposition or rotate antenna.	11, 12
	The CLOSED CAPTION button is not depressed.	Press the CLOSED CAPTION button to turn on the closed caption.	21
VCR			
TV recording does not work.	The video cassette's erase prevention tab is broken off.	Place a piece of adhesive tape over the hole.	34
Timer recording does not work.	The time is not set correctly.	Reset the present time.	16-18
	The recording start/end time is not set correctly.	Reset the start/end time.	41
Noise bars appear on the screen.	Tape is old or worn.	Replace the tape.	—
	Tracking adjustment is beyond range of automatic tracking circuit.	Adjust tracking manually using the TRACKING +/- buttons on the remote control.	36
	Video heads are dirty.	Clean the video heads.	68

Problems and troubleshooting (continued) / Video head cleaning

SYMPTOMS	CAUSE	POSSIBLE SOLUTIONS	PAGE
DVD			
The playback picture has occasional distortion.	The disc is dirty.	Eject the disc and clean it.	44
	It is in fast forward or fast reverse playback.	Some times a small amount of picture distortion may appear. This is not a malfunction.	–
The TV/VCR/DVD does not start playback.	No disc is inserted.	Insert a disc.	47
	An unplayable disc is inserted.	Insert a playable disc (Check the disc type and Region Number). This is a Region 1 player.	44
	The disc is placed upside down.	Place the disc with the playback side down.	47
	The disc is not placed within the guide.	Place the disc correctly inside the guide on the disc tray.	47
	The disc is dirty.	Clean the disc.	44
	The parental lock function is set.	Cancel the parental lock function or change the parental lock level.	60,61
Playback does not follow the course of the disc's program.	It is in the mode of repeat playback, memory playback, etc.	These operations may prevent proper progression of the contents.	–
 appears on the screen.	The function is prohibited with the TV/VCR/DVD or the disc.	–	47
REMOTE CONTROL			
Remote control does not operate.	The remote control is not aimed at the sensor.	Aim the remote control at the remote sensor.	10
	Distance is too far or too much light in the room.	Operate within 5 m or reduce the light of the room.	10
	There is an obstacle in the path of the beam.	Clear the path of the beam.	10
	The batteries are weak.	Replace the batteries.	10
	The batteries are not inserted correctly.	Insert correctly.	10

Video head cleaning

Video head clogging

The video heads are the means by which the TV/VCR/DVD reads the picture from the tape during playback. In the unlikely event that the heads become dirty enough to be clogged, no picture will be played back. This can easily be determined if, during playback of a known good tape, there is good sound, but no picture (picture is extremely snowy). If this is the case, have the TV/VCR/DVD checked by qualified service personnel.

NOTES:

- DO NOT ATTEMPT TO CLEAN THE VIDEO HEADS OR SERVICE THE TV/VCR/DVD BY REMOVING THE REAR COVER.

- Video heads may eventually wear out and should be replaced when they fail to produce clear pictures.
- To help prevent video head clogging, use only good quality VHS tapes. Discard worn out tapes.

Specifications

	20F501TDV	24F501TDV	27F501TDV
GENERAL	AC 120V 60Hz		
Power supply:	AC 120V 60Hz		
Power consumption:	Operation: 110W Stand by: 4W	Operation: 135W Stand by: 4W	Operation: 145W Stand by: 4W
Weight:	59.5 lbs (27.0 kg)	79.4 lbs (36.0 kg)	99.2 lbs (45.0 kg)
Dimensions:	Width : 22-9/16 inches (573 mm) Height: 20-3/8 inches (517 mm) Depth : 18-15/16 inches (481 mm)	25-13/16 inches (655 mm) 22-13/16 inches (580 mm) 18-3/4 inches (477 mm)	29-1/8 inches (740 mm) 25-3/8 inches (645 mm) 19-7/16 inches (494 mm)
Inputs/Outputs:	In: 1 Vp-p/75 ohm Out: 1 Vp-p/75 ohm		
Video:	In: -8 dBm/50K ohm Out: -8 dBm/1K ohm		
Audio:	20Hz to 20,000Hz More than 90 dB		
Hi-Fi frequency response:	20Hz to 20,000Hz		
Hi-Fi dynamic range:	More than 90 dB		
TELEVISION			
Picture tube:	20 inches (508 mm diagonal)	24 inches (600 mm diagonal)	27 inches (677 mm diagonal)
Tuner type:	Quartz PLL Frequency Synthesized		
Receiving channels:	VHF 2-13 UHF 14-69 CABLE 14-36 (A)-(W) 37-59 (AA)-(WW) 60-85 (AAA)-(ZZZ) 86-94 (86)-(94) 95-99 (A-5)-(A-1) 100-125 (100)-(125) 01 (5A)		
Antenna input:	VHF/UHF In 75 ohm coaxial		
Speaker:	1-13/16" (46 mm) x 3-7/8" (99 mm), 8 ohm x 2		
Audio output power:	1.5W + 1.5W		2.5W+2.5W
VCR section			
Video head:	4 Rotary Heads		
Audio track:	Hi-Fi Sound - 2 Tracks / MONO Sound - 1 Track		
Tuner:	181 Channel Freq. Synthesized VHF 2-13 UHF 14-69 CABLE 14-36 (A)-(W) 37-59 (AA)-(WW) 60-85 (AAA)-(ZZZ) 86-94 (86)-(94) 95-99 (A-5)-(A-1) 100-125 (100)-(125) 01 (5A)		
FFWD/REW Time at 25°C (77°F):	Approx. 1 minute and 48 seconds (with T-120 Cassette Tape)		
DVD section			
Signal system:	NTSC		
Applicable disc:	DVD (12 cm, 8 cm), CD (12 cm, 8 cm)		
Frequency response:	DVD: 4Hz - 22KHz/CD: 4Hz - 20KHz		
S/N Ratio:	90 dB		
Harmonic distortion:	0.06%		
Wow and flutter:	Below Measurable Level		
Output:	Video : (RCA) 1 Vp-p/75 ohm Audio : (RCA) -12 dBm/1K ohm Digital Audio : 0.5 Vp-p/75 ohm		
Pickup:	CD : Wavelength: 775 - 805 nm Maximum output power: 0.5 mW DVD : Wavelength: 640 - 660 nm Maximum output power: 1.0 mW		

ACCESSORIES:

Remote control x 1
Batteries (AAA) x 2

Warranty

RCA TruFlat TV/DVD/VCR Combination Limited Warranty

What your warranty covers:

- Defects in material or workmanship.

For how long after your purchase:

- One year from date of purchase for labor charges.
- One year from date of purchase for parts.
- Two years from date of purchase for picture tube.

The warranty period for rental units begins with the first rental or 45 days from date of shipment to the rental firm whichever comes first.

What we will do:

- Pay any Authorized RCA Television Service Center the labor charges to repair your unit.
- Pay any Authorized RCA Television Service Center for the new or, at our option, rebuilt replacement parts and picture tube required to repair your unit.

How you get service:

- For 20" screen size: Take your unit to any Authorized RCA Television Service Center and pickup when repairs are complete.
- For screen sizes larger than 20": Request home or pick up, repair and return service from any Authorized RCA Television Service Center, provided that your unit is located within the geographic territory covered by an Authorized RCA Television Service Center. If not, you must take your unit to the Service Center location at your own expense, or pay for the cost the Service Center may charge to transport your unit to and from your home.
- To identify your nearest Authorized RCA Service Center, ask your dealer, look in the Yellow Pages, visit www.rca.com, or call 1-800-336-1900.
- Proof of purchase in the form of a bill of sale or receipted invoice which is evidence that the product is within the warranty period must be presented to obtain warranty service. For rental firms, proof of first rental is also required.

What your warranty does not cover:

- Customer instruction. (Your Owner's Manual describes how to install, adjust, and operate your television. Any additional information should be obtained from your dealer.)
- Installation and related adjustments.
- Signal reception problems not caused by your unit.
- Damage from misuse or neglect.
- Cleaning of audio/video heads.
- Batteries.
- A product that has been modified or incorporated into other products or is used for institutional or other commercial purposes.
- Images burnt onto the screen.
- Acts of nature, such as but not limited to lightning damage.
- A unit purchased or serviced outside the U.S.A.

Product Registration:

Please complete the online Product Registration on www.rca.com or complete and mail the Product Registration Card packed with your unit. It will make it easier to contact you should it ever be necessary. The return of the card is not required for warranty coverage.

Limitation of Warranty:

THE WARRANTY STATED ABOVE IS THE ONLY WARRANTY APPLICABLE TO THIS PRODUCT. ALL OTHER WARRANTIES, EXPRESS OR IMPLIED (INCLUDING ALL IMPLIED WARRANTIES OF MERCHANTABILITY OR FITNESS FOR A PARTICULAR PURPOSE) ARE HEREBY DISCLAIMED. NO VERBAL OR WRITTEN INFORMATION GIVEN BY TTE TECHNOLOGY, INC., ITS AGENTS OR EMPLOYEES SHALL CREATE A WARRANTY OR IN ANY WAY INCREASE THE SCOPE OF THIS WARRANTY.

REPAIR OR REPLACEMENT AS PROVIDED UNDER THIS WARRANTY IS THE EXCLUSIVE REMEDY OF THE CONSUMER. TTE TECHNOLOGY, INC. SHALL NOT BE LIABLE FOR INCIDENTAL OR CONSEQUENTIAL DAMAGES RESULTING FROM THE USE OF THIS PRODUCT OR ARISING OUT OF ANY BREACH OF ANY EXPRESS OR IMPLIED WARRANTY ON THIS PRODUCT. THIS DISCLAIMER OF WARRANTIES AND LIMITED WARRANTY ARE GOVERNED BY THE LAWS OF THE STATE OF INDIANA. EXCEPT TO THE EXTENT PROHIBITED BY APPLICABLE LAW, ANY IMPLIED WARRANTY OF MERCHANTABILITY OR FITNESS FOR A PARTICULAR PURPOSE ON THIS PRODUCT IS LIMITED TO THE APPLICABLE WARRANTY PERIOD SET FORTH ABOVE.

How state law relates to this warranty:

Some states do not allow the exclusion nor limitation of incidental or consequential damages, or limitations on how long an implied warranty lasts, so the above limitations or exclusions may not apply to you.

This warranty gives you specific legal rights, and you also may have other rights that vary from state to state.

If you purchased your product outside the United States:

This warranty does not apply. Contact your dealer for warranty information.

Service calls which do not involve defective materials or workmanship are not covered by this warranty. Costs of such service calls are the sole responsibility of the purchaser.

Visit the RCA web site at www.rca.com

Please do not send any products to the Indianapolis address listed in this manual or on the carton. This will only add delays in service for your product.

RCA and associated marks are trademarks of THOMSON S. A. used under license to TCL-Thomson Electronics (TTE).

TTE Technology, Inc.
10330 North Meridian Street
Indianapolis, IN 46290

©2004 TTE Technology, Inc.
Printed in Thailand
TOCOM 1637133B



J5P70101B

04/11 K