



---

## Design Example Report

<b>Title</b>	<i>2.4W Charger using LNK500P</i>
<b>Specification</b>	Input: 90-264 VAC Output: 6V / 0.4A
<b>Application</b>	Cell Phone Charger
<b>Author</b>	Power Integrations Applications Department
<b>Document Number</b>	DER-12
<b>Date</b>	February 4, 2004
<b>Revision</b>	1.0

### Summary and Features

This report details the design of an isolated Flyback converter for Wall mount adapter.

- Uses LinkSwitch LNK500P (Low cost series)
- Universal input voltage
- Typical Efficiency 72 %
- Meets EN550022 Class B EMI tests with No Y1 capacitor
- Very low earth leakage current

The products and applications illustrated herein (including circuits external to the products and transformer construction) may be covered by one or more U.S. and foreign patents or potentially by pending U.S. and foreign patent applications assigned to Power Integrations. A complete list of Power Integrations' patents may be found at [www.powerint.com](http://www.powerint.com)

## Table Of Contents

1	Introduction.....	4
2	Power Supply Specification.....	4
3	Schematic.....	5
4	PCB Layout.....	5
5	Bill Of Materials.....	6
6	Transformer.....	7
6.1	Transformer Winding.....	7
6.2	Electrical Specifications.....	7
6.3	Transformer Construction.....	8
6.4	Winding Instructions.....	8
6.5	Materials.....	9
6.6	Design Notes:.....	9
7	Performance Data.....	10
7.1	Efficiency.....	10
7.2	Load Regulation.....	11
7.3	Line Regulation.....	11
7.4	No Load Input Power.....	12
7.5	Output Ripple Measurements.....	13
7.5.1	Ripple Measurement Technique.....	13
7.5.2	Output Voltage Ripple.....	14
8	Surge Test.....	14
9	EMI Tests.....	15
10	Revision History.....	17



## List Of Figures

Figure 1 – Flyback Converter – 2.4W 6V 0.4A.....	5
Figure 2 – PCB Layout .....	5
Figure 3 – Transformer Winding.....	7
Figure 4 – Transformer construction .....	8
Figure 5 – Efficiency Vs Output Current.....	10
Figure 6 – Load Regulation .....	11
Figure 7 – Line Regulation .....	11
Figure 8 – No Load Input Power.....	12
Figure 9 – Oscilloscope Probe Prepared for Ripple Measurement.....	13
Figure 10 – Oscilloscope Probe with Probe Master 5125BA BNC Adapter .....	13
Figure 11 – Output Voltage Ripple (worst case) at $V_{in} = 90 \text{ Vac}$ , $V_o = 5.44 \text{ V}$ , $I_o = 400 \text{ mA}$ .....	14
Figure 12 – EN55022 Class B, Line, artificial hand connected to output return .....	15
Figure 13 – EN55022 Class B, Neutral, artificial hand connected to output return.....	15
Figure 14 – EN55022 Class B, Line, with out artificial hand connected to output return.....	16
Figure 15 – EN55022 Class B, Neutral, with out artificial hand connected to output return .....	16

## List Of Tables

Table 1 – Power Supply Specification .....	4
Table 2 – Bill of Materials.....	6
Table 3 – Transformer BOM.....	9

### Important Notes:

Although this board is designed to satisfy safety isolation requirements, the engineering prototype has not been agency approved. Therefore, all testing should be performed using an isolation transformer to provide the AC input to the prototype board.

Design Reports contain a power supply design specification, schematic, bill of materials, and transformer documentation. Performance data and typical operation characteristics are included. Typically only a single prototype has been built.



## 1 Introduction

This document is an engineering report giving performance characteristics of an isolated Flyback converter with universal input voltage and 6V 0.4A output CV/CC characteristics. This design uses LinkSwitch – an integrated IC comprising a high voltage MOSFET, PWM controller, using no optocoupler. The controller provides an I<sup>2</sup>f type characteristic to provide a constant current output current without secondary side sensing.

This document contains the power supply specification, schematic, and bill of materials, transformer documentation, printed circuit layout, and performance data.

## 2 Power Supply Specification

Description	Symbol	Min	Typ	Max	Units	Comment
<b>Input</b> Voltage	$V_{IN}$	90		264	Vac	
<b>Output</b> Output Voltage @ full load	$V_{fl}$		5.3		V	at 400 mA load
Output Voltage @ no load	$V_{nl}$		6.6	6.8	V	
Output Ripple Voltage	$V_{RIPPLE1}$			150	mV	20 MHz Bandwidth
<b>Total Output Power</b> Continuous Output Power	$P_{OUT}$			2.4	W	
<b>Constant Current Limit</b> Output Constant Current	$I_{OUT1}$	.4	.5	.65	A	2.5V – 4.5V
<b>Conducted EMI Margin</b>		5			dB	EN550022 B, FCC B
<b>Efficiency</b>	$\eta$		72		%	At full load
Ambient Temperature	$T_{AMB}$	-10		40	°C	Free convection, Sea level

Table 1 – Power Supply Specification



### 3 Schematic

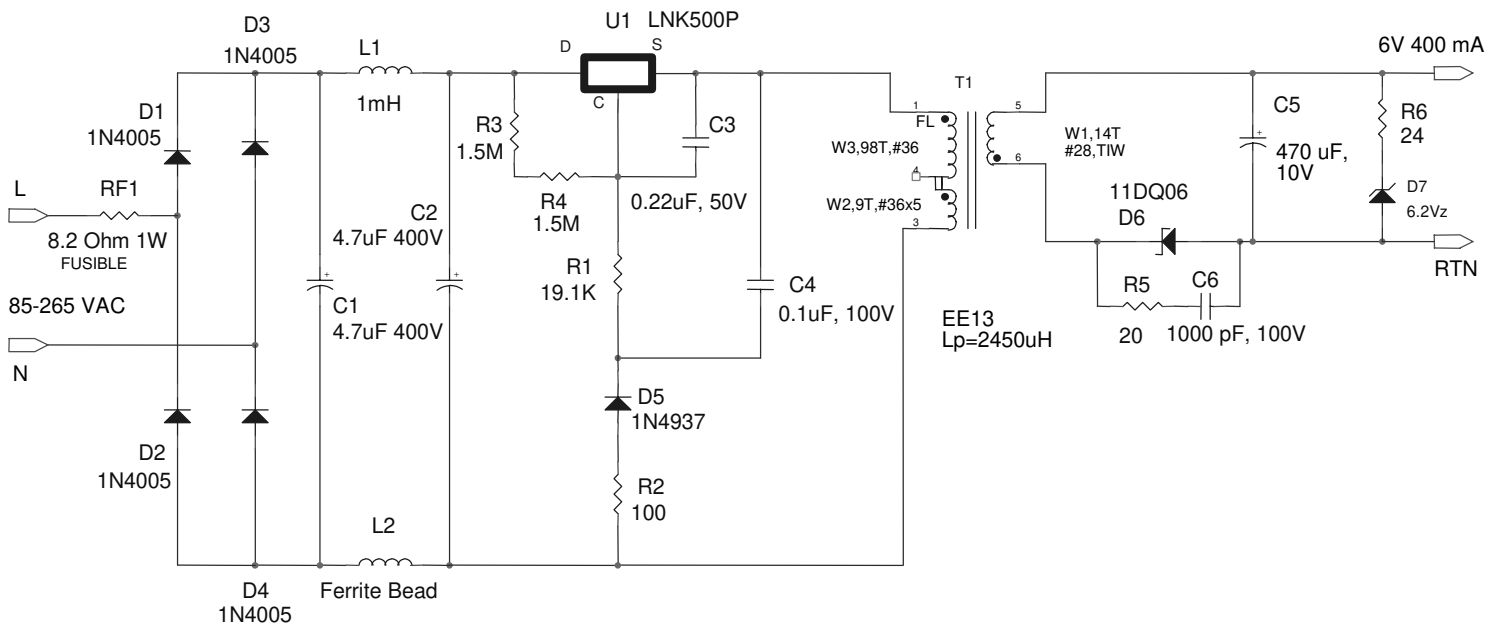

Figure 1 – Flyback Converter – 2.4W 6V 0.4A.

### 4 PCB Layout

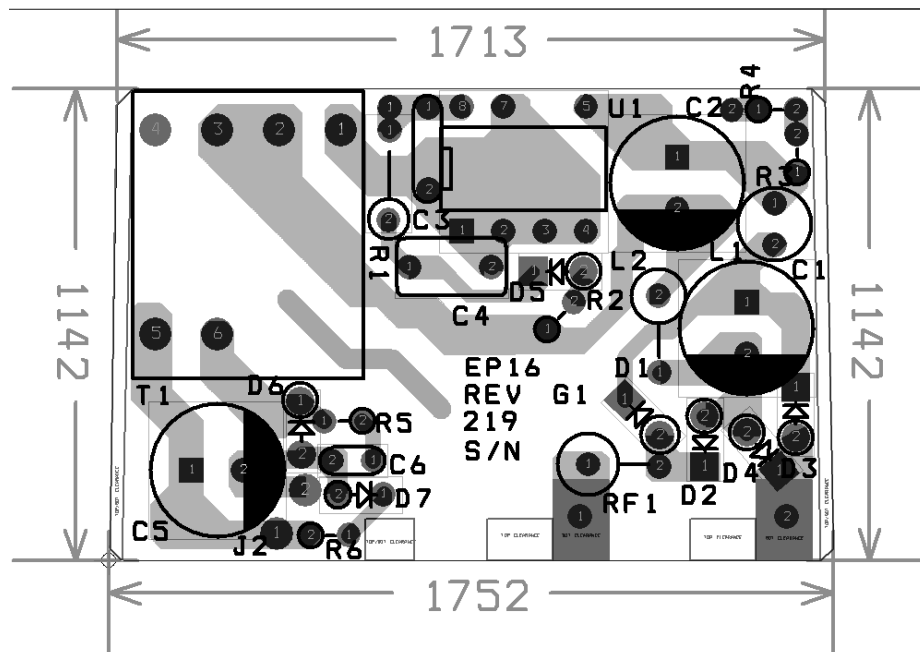

Figure 2 – PCB Layout



## 5 Bill Of Materials

Item	Qty	Ref. Des	Part Description
1	2	C1, C2	4.7 $\mu$ F, 400V, AL Electrolytic capacitor
2	1	C3	0.22 $\mu$ F, 50V, Ceramic capacitor
3	1	C4	0.1 $\mu$ F, 100V, Film capacitor
4	1	C5	470 $\mu$ F, 10V, Low ESR AL Electrolytic capacitor
5	1	C6	1000 pF, 100V, Ceramic capacitor
6	4	D1, D2, D3, D4	1N4005, Diode GP 1A 600V
7	1	D5	1N4937, Diode FR 1A 600V
8	1	D6	11DQ06, Diode Schottky 1A 60V
9	1	D7	6.2Vz, Diode Zener, 500 mW, 1%
10	1	L1	1 mH, Inductor drum core
11	1	L2	Ferrite Bead
12	1	RF1	8.2 $\Omega$ 1W, Resistor fusible
13	1	R1	19.1 K $\Omega$ , Resistor 1/4 W, 1%
14	1	R2	100 $\Omega$ , Resistor, 1/8 W, 5%
15	2	R4, R3	1.5 M $\Omega$ , Resistor 1/8 W, 5%
16	1	R5	20 $\Omega$ , Resistor, 1/8 W, 5%
17	1	R6	24 $\Omega$ , Resistor, 1/8 W, 5%
18	1	T1	Flyback Transformer
19	1	U1	LNK500P, LinkSwitch

**Table 2 – Bill of Materials**



## 6 Transformer

### 6.1 Transformer Winding

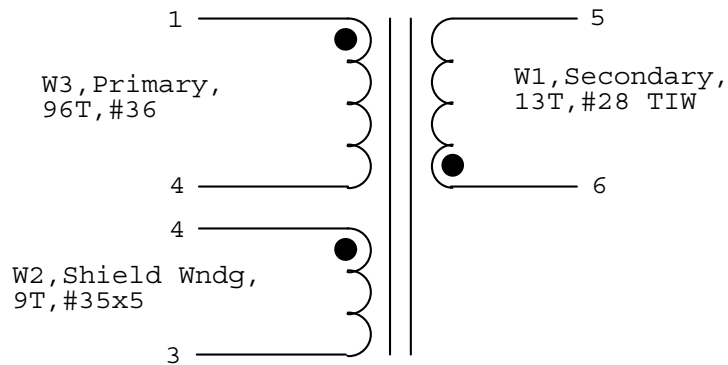

Figure 3 – Transformer Winding

### 6.2 Electrical Specifications

Electrical Strength	60Hz 1minute, from Pins 1-4 to Pins 5-6	3 kV for 1 minute
Primary Inductance (Pin 1 to Pin 3)	All windings open	2.45 mH $\pm$ 7 %
Resonant Frequency	All windings open	300 kHz min.
Primary Leakage Inductance	L <sub>13</sub> with pins 5-6 shorted	50 $\mu$ H max.

### 6.3 Transformer Construction

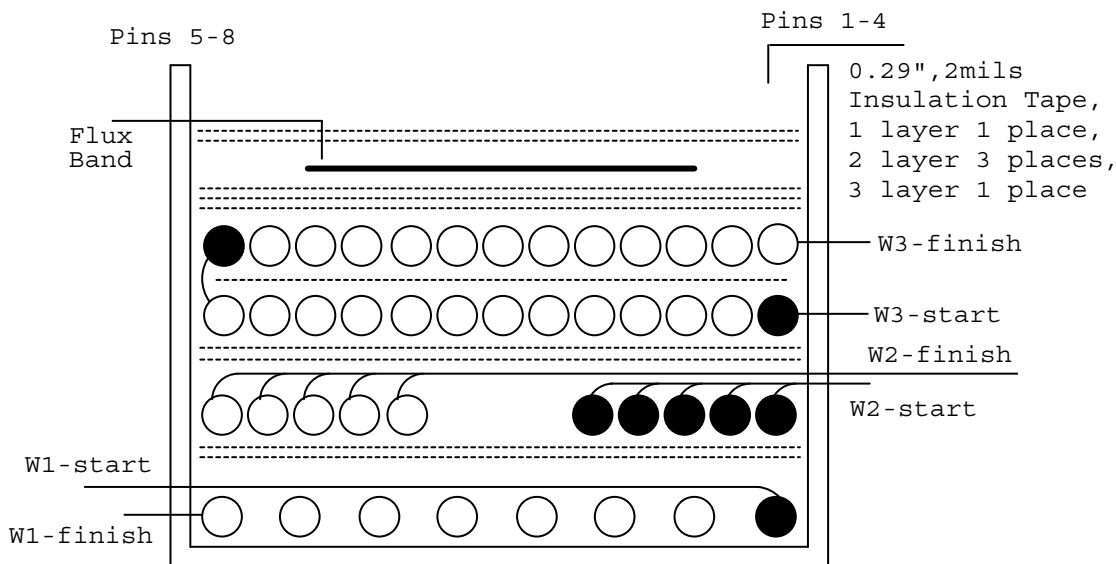

Figure 4 – Transformer construction

### 6.4 Winding Instructions

Place the bobbin on the winding machine with pins 1-4 on the right side and pins 5-8 on the left side.

W1 (Secondary Winding)	Wind 13 turns with # 28 triple insulated wire from right to left starting temporarily from 1 and finishing at 5. Bring the starting end from pin 1 to pin 6.
Basic Insulation	2 layers of tape for insulation.
W2 (Shield)	Wind 9 turns with #35 x 5 (penta-filar) magnet wire from right to left starting from 4 and finishing at 3. Wind evenly across the width of the bobbin without any gaps on sides.
Basic Insulation	2 layers of tape for insulation.
W3 (Primary Winding)	Wind 96 turns in 2 layers with # 36 AWG magnet wire – first layer 48T from right to left starting from pin 1 – one layer of insulation tape – second layer 48T from left to right and finishing at pin 4.
Basic Insulation	3 layers of tape for insulation.
Core Assembly	Assemble and secure core halves.
Flux Band	Apply Flux band around assembled core and bobbin, and solder start and finish ends. Connect the flux band to pin 3 with a piece of #35 AWG magnet wire.
Outer Insulation	2 layers of tape for insulation.
Final Assembly	Solder the transformer pins and impregnate transformer uniformly with varnish.





## 6.5 Materials

Item	Description
[1]	Core: EE13, PC40EE13, TDK Gapped for $A_L = 222 \text{ nH/T}^2 \pm 7 \%$
[2]	Bobbin: Horizontal 8 pins
[3]	Magnet Wire: #36 AWG
[4]	Magnet Wire: #35AWG
[5]	Triple Insulated wire: # 28 AWG
[6]	Copper foil, 0.2 inch x 2 mils
[7]	Tape: 3M 1298 Polyester Film (white) 0.29" x 2 mils
[8]	Varnish

Table 3 – Transformer BOM

## 6.6 Design Notes:

Power Integrations Device	LNK500P
Frequency of Operation	42 KHz
Mode	discontinuous
Peak Current	0.25 A
Reflected Voltage (Secondary to Primary)	54 V
Maximum AC Input Voltage	264 V
Minimum AC Input Voltage	90 V



## 7 Performance Data

Measurements shown are of a typical unit. The output voltages are measured at the end of a 6-foot cable with 0.2 Ω total resistance.

### 7.1 Efficiency

The measurements are made for various load and line conditions. The efficiencies are calculated and shown in Figure 5.

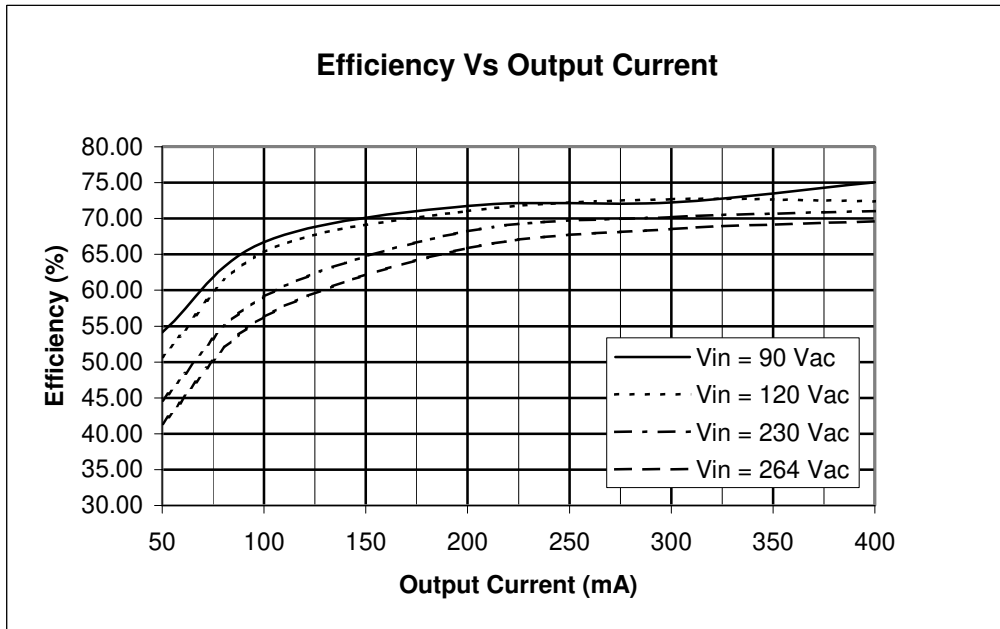

Figure 5 – Efficiency Vs Output Current



**7.2 Load Regulation**

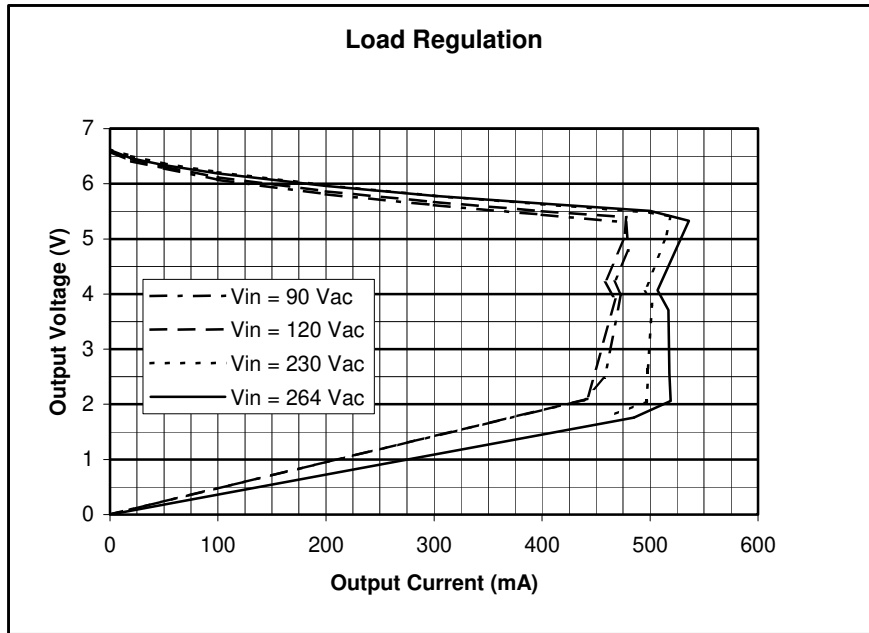

Figure 6 – Load Regulation

**7.3 Line Regulation**

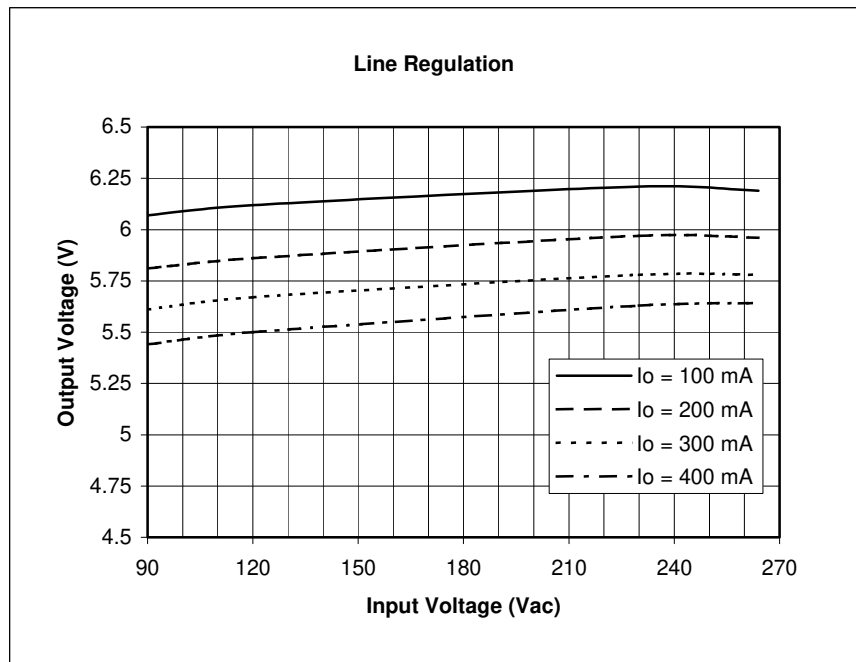

Figure 7 – Line Regulation



### 7.4 No Load Input Power

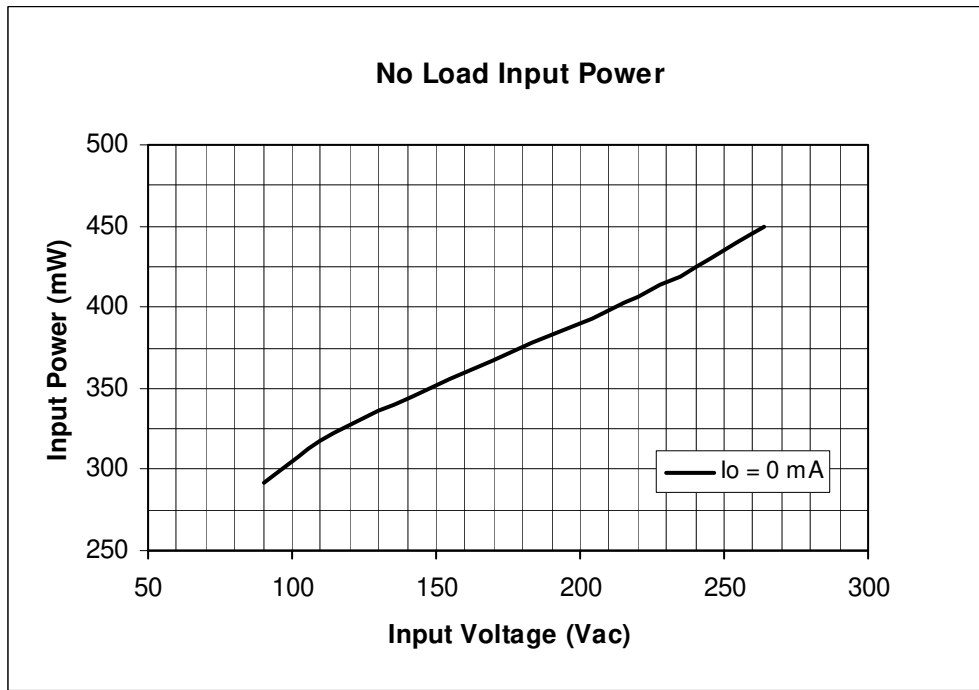

Figure 8 – No Load Input Power



## 7.5 Output Ripple Measurements

### 7.5.1 Ripple Measurement Technique

For DC output ripple measurements, a modified oscilloscope test probe must be utilized in order to reduce spurious signals due to pickup. Details of the probe modification are provided in Figure 9 and Figure 10.

The 5125BA probe adapter is affixed with two capacitors tied in parallel across the probe tip. The capacitors include one (1) 0.1  $\mu\text{F}/50\text{ V}$  ceramic type and one (1) 1.0  $\mu\text{F}/50\text{ V}$  aluminum electrolytic. *The aluminum electrolytic type capacitor is polarized, so proper polarity across DC outputs must be maintained (see below).*

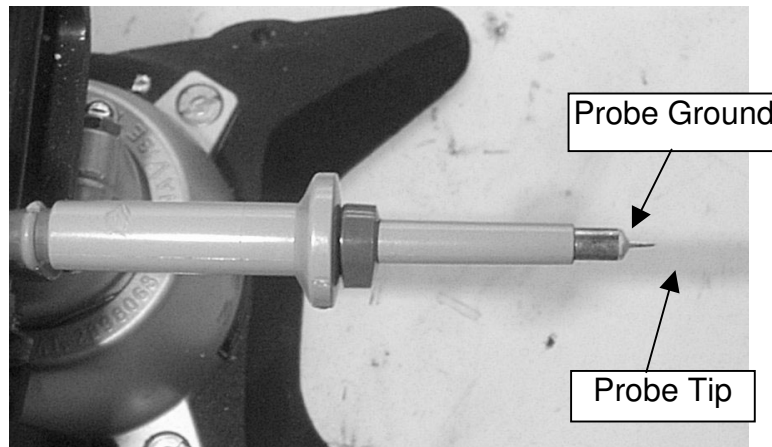

**Figure 9** – Oscilloscope Probe Prepared for Ripple Measurement.  
(End Cap and Ground Lead Removed)

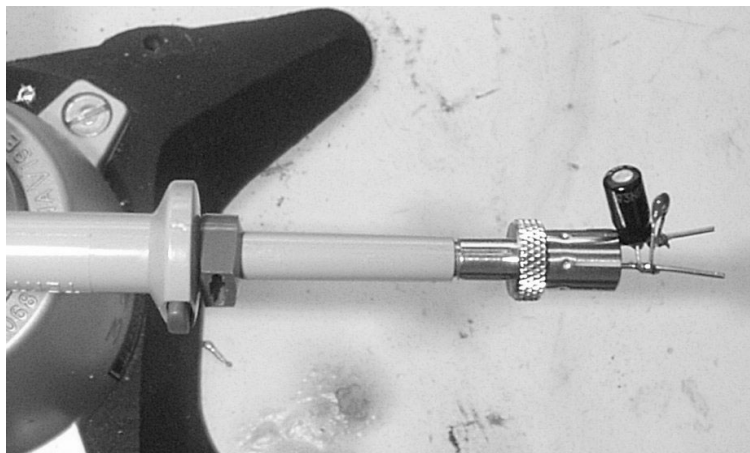

**Figure 10** – Oscilloscope Probe with Probe Master 5125BA BNC Adapter

(Modified with wires for probe ground for ripple measurement, and two parallel decoupling capacitors added).

### 7.5.2 Output Voltage Ripple

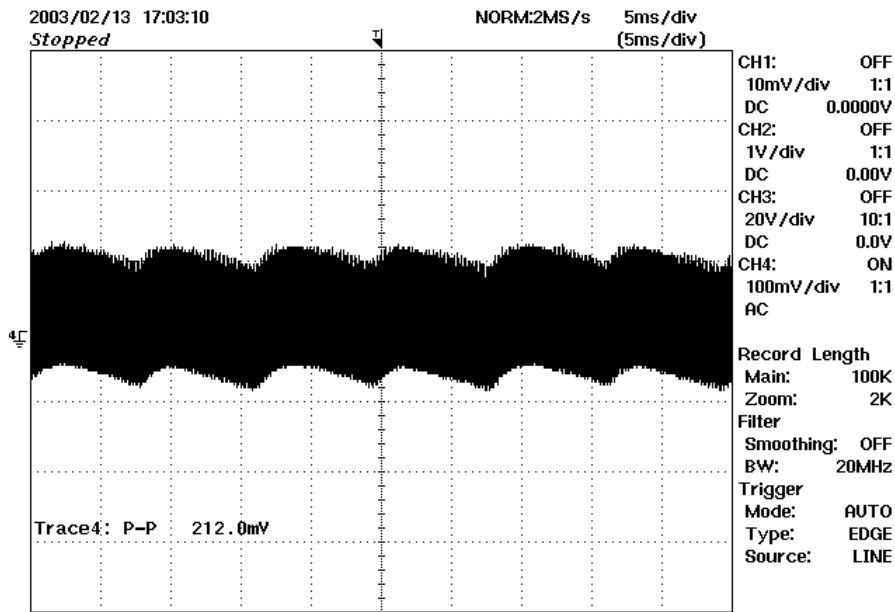

Figure 11 – Output Voltage Ripple (worst case) at  $V_{in} = 90 \text{ Vac}$ ,  $V_o = 5.44 \text{ V}$ ,  $I_o = 400 \text{ mA}$

## 8 Surge Test

Surge test was done as per IEC1000-4-5, but with 2.5kV line-line, 2  $\Omega$  impedance, with 8 strikes each at +2.5kV at 90° and -2.5kV at 270°. The unit passed without any failure.



## 9 EMI Tests

The EMI tests are done at 220 Vac input and 400 mA load.

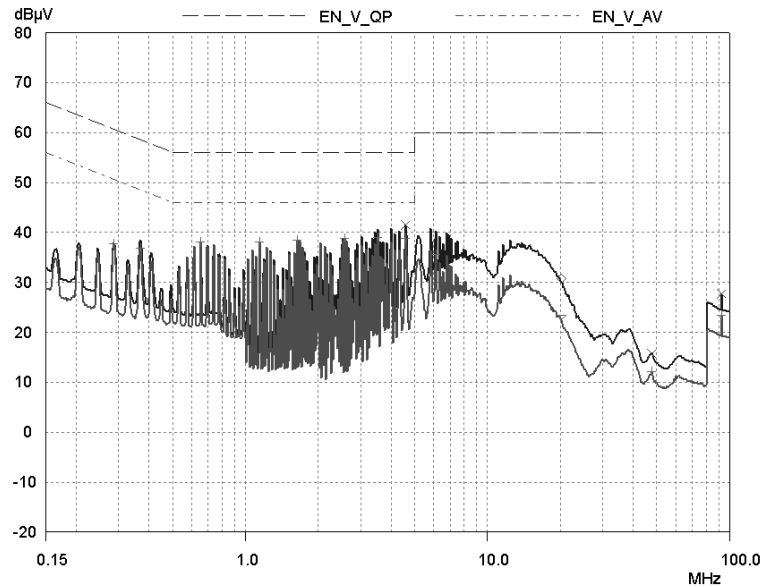

Figure 12 – EN55022 Class B, Line, artificial hand connected to output return

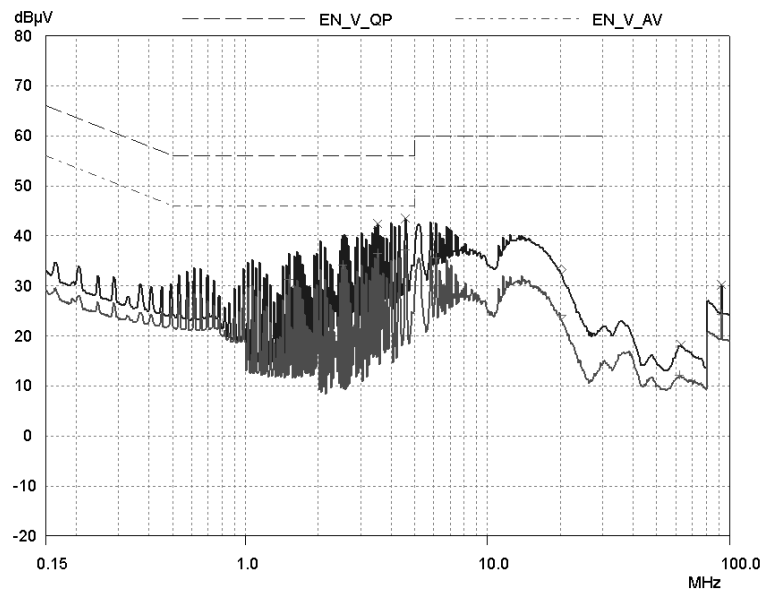

Figure 13 – EN55022 Class B, Neutral, artificial hand connected to output return



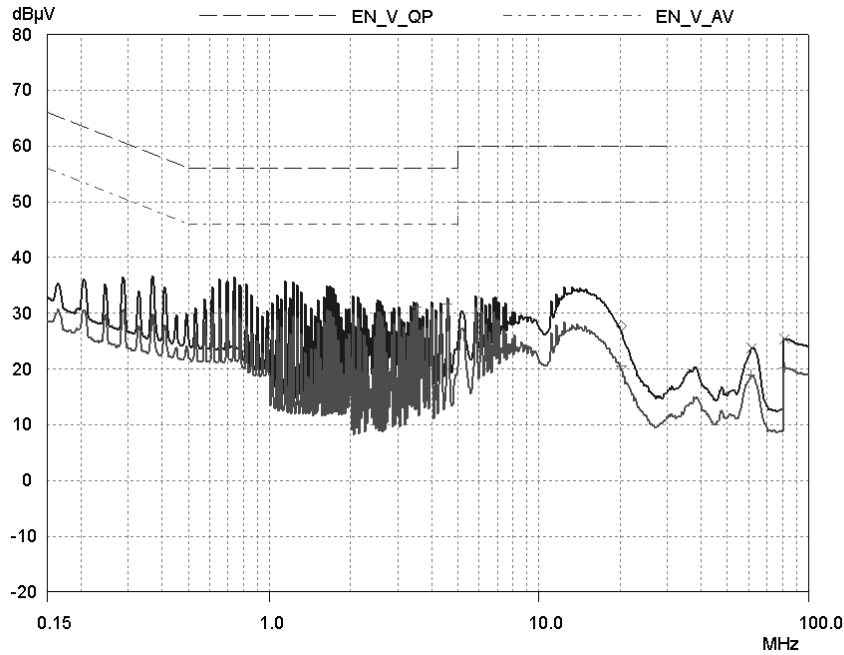

Figure 14 – EN5022 Class B, Line, without artificial hand connected to output return

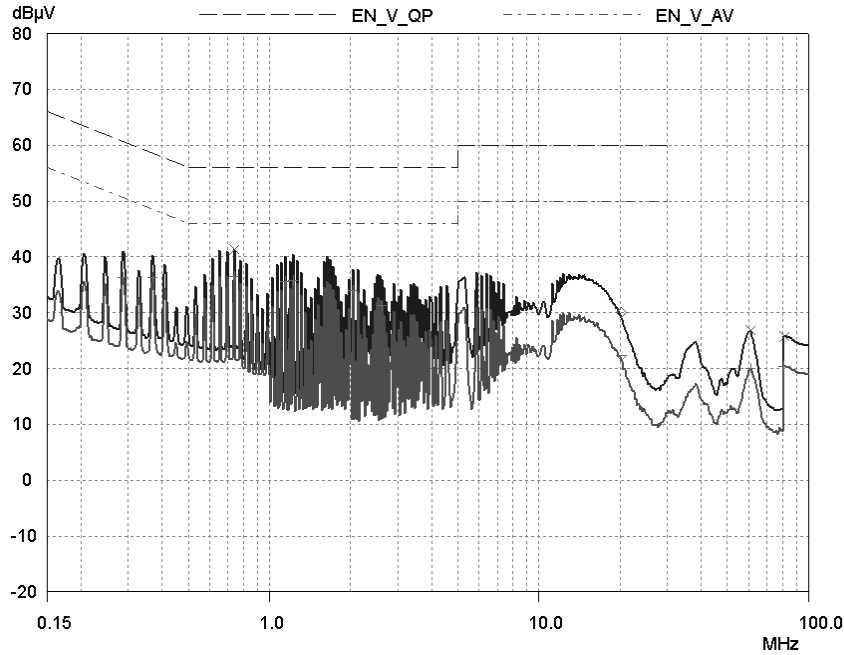

Figure 15 – EN5022 Class B, Neutral, without artificial hand connected to output return





## 10 Revision History

<b>Date</b>	<b>Author</b>	<b>Revision</b>	<b>Description &amp; changes</b>	<b>Reviewed</b>
February 4, 2004	YG	1.0	Initial release	AM/VC



**Notes**



For the latest updates, visit our Web site: [www.powerint.com](http://www.powerint.com)

Power Integrations reserves the right to make changes to its products at any time to improve reliability or manufacturability. Power Integrations does not assume any liability arising from the use of any device or circuit described herein, nor does it convey any license under its patent rights or the rights of others.

The products and applications illustrated herein (including circuits external to the products and transformer construction) may be covered by one or more U.S. and foreign patents or potentially by pending U.S. and foreign patent applications assigned to Power Integrations. A complete list of Power Integrations' patents may be found at [www.powerint.com](http://www.powerint.com).

The PI Logo, **TOPSwitch**, **TinySwitch**, **LinkSwitch**, and **EcoSmart** are registered trademarks of Power Integrations, Inc. **PI Expert** and **DPA-Switch** are trademarks of Power Integrations, Inc.  
© Copyright 2003, Power Integrations, Inc.

**WORLD HEADQUARTERS  
NORTH AMERICA - WEST**  
Power Integrations, Inc.  
5245 Hellyer Avenue  
San Jose, CA 95138 USA.  
Main: +1-408-414-9200  
Customer Service:  
Phone: +1-408-414-9665  
Fax: +1-408-414-9765

**NORTH AMERICA - EAST  
& SOUTH AMERICA**  
Power Integrations, Inc.  
Eastern Area Sales Office  
1343 Canton Road, Suite C1  
Marietta, GA 30066 USA  
Phone: +1-770-424-5152  
Fax: +1-770-424-6567

**EUROPE & AFRICA**  
Power Integrations (Europe) Ltd.  
Centennial Court  
Easthampstead Road  
Bracknell  
Berkshire RG12 1YQ,  
United Kingdom  
Phone: +44-1344-462-301  
Fax: +44-1344-311-732

**TAIWAN**  
Power Integrations International  
Holdings, Inc.  
2F, #508, Chung Hsiao E. Rd.,  
Sec. 5,  
Taipei 105, Taiwan  
Phone: +886-2-2727-1221  
Fax: +886-2-2727-1223

**CHINA**  
Power Integrations  
International  
Holdings, Inc.  
Rm# 1705, Bao Hua Bldg.  
1016 Hua Qiang Bei Lu  
Shenzhen Guangdong,  
518031  
Phone: +86-755-367-5143  
Fax: +86-755-377-9610

**KOREA**  
Power Integrations  
International  
Holdings, Inc.  
Rm# 402, Handuk Building,  
649-4 Yeoksam-Dong,  
Kangnam-Gu,  
Seoul, Korea  
Phone: +82-2-568-7520  
Fax: +82-2-568-7474

**JAPAN**  
Power Integrations, K.K.  
Keihin-Tatemono 1st Bldg.  
12-20 Shin-Yokohama 2-  
Chome,  
Kohoku-ku, Yokohama-shi,  
Kanagawa 222, Japan  
Phone: +81-45-471-1021  
Fax: +81-45-471-3717

**INDIA (Technical Support)**  
Innovatech  
#1, 8th Main Road  
Vasanthnagar  
Bangalore, India 560052  
Phone: +91-80-226-6023  
Fax: +91-80-228-9727

**APPLICATIONS HOTLINE**  
World Wide +1-408-414-9660

**APPLICATIONS FAX**  
World Wide +1-408-414-9760

