



JAURE[®]

Power Transmission Solutions

Reliable coupling
technology



EMERSON[™]
Industrial Automation

Jaure

Keep Your Equipment and Your Business Moving Forward

The whole world is on the move today. Everything from people and products to ideas and information. That means business has to be on the move as well. JAURE®

Power Transmission Solutions can help. We keep products - and businesses - moving forward.

Whether it's helping to make sure that minerals are extracted, steel is transformed, cement or paper is

manufactured, goods are hoisted and transported or energy is produced, our products and solutions help make your business go.



The Emerson advantage

JAURE® and KOP-FLEX® are the coupling brands of Power Transmission Solutions. We bring you almost a

century of technology and engineering experience. As an Emerson company, JAURE® is part of one of the world's leading suppliers of innovation and insight, providing solutions to customers around the world. Backed by extraordinary technological capabilities and resources, we can deliver customized, competitively

priced couplings and solutions that meet the unique needs of each of our customers.



JAURE®



We bring you
almost a century
of technology
and engineering
experience

all over
the world

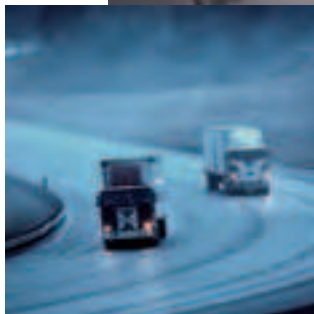

We know our
business and we
understand yours

JAURE® serves industries as diverse as our solutions themselves. We work closely with each market, to understand the day-to-day challenges and issues that each one faces. That means you get tailored solutions that bring innovation to every application.

A global reach

We also offer unparalleled service and support – anywhere in the world. A global supply chain and a worldwide distribution network lets JAURE® help you manage parts and inventories more effectively. Our lean-manufacturing capabilities coupled with our combined engineering expertise and global facilities, lets us deliver the solutions you need – when and where you need them.

The Power of People

The real innovation behind our products comes from our people. Our engineers study your unique industry challenges as thoroughly as their own areas of expertise. Meanwhile, our sales force and field-service personnel also work hard to understand the challenges of every customer, in every market place and industry. Finally, our customer service representatives are always ready and available to answer any questions, solve problems or deal with any issues.





The solutions
you need –
when and
where you
require them

technology & innovation

R+D+i: Our compromise

JAURE® develop its products and technologies through innovation, development and continuous product improvement bringing the highest possible value to our customers.

Due to our commitment for giving the best solution to our customers in the most demanding sectors like wind energy, marine and heavy industry, we are investing in new test benches and resources

while collaborating with other technological centres, suppliers and universities.

JAURE® has made significant improvements in its ability to innovate by building a worldwide virtual network of technical experts and by enhancing the New Product Development (NPD) roadmap with the Phase-Gate Process. Through a comprehensive in-house and external network (this includes the

Emerson's worldwide virtual network of over 32 global resources) JAURE® has access to new trends and technologies.

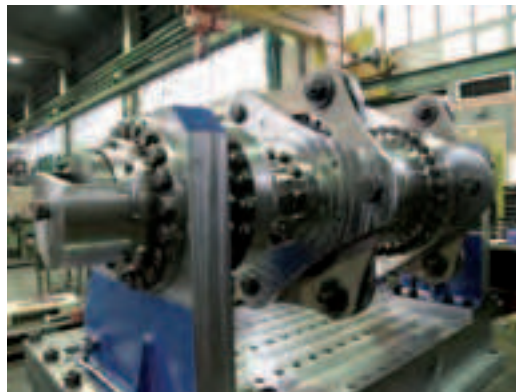
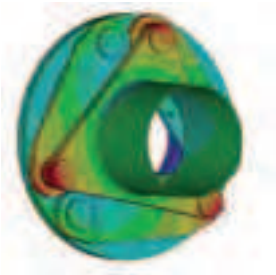

JAURE has
made significant
improvements in
its ability to
innovate



general industry

The most complete solutions for all types of applications

JAURE® is considered a leading power transmission supplier and offers the broadest range of couplings available in the market nowadays:

- Crowned Gear couplings.
- Barrel couplings.
- Disc pack couplings.
- Elastic couplings.
- Elastic links.
- Composite links.
- Grid couplings.
- Gear spindles.
- Torque limiters.
- Composite Shafts.
- High Performance KOP-FLEX® program.
- Grease program.



We have the optimum solution for the most demanding applications, such as the hoisting industry, pulp & paper, petrochemical, pump, machine tools, sugar industry, plastics & rubber, rail as well as test benches and many other drive systems. In fact, our products have been standardized for a large number of applications.

A reliable partner, well positioned, to be your best coupling solution resource. Technological leadership can only be maintained with a commitment to highly skilled resources and investment. JAURE® employs highly-qualified engineering personnel, which enables rapid new product development to continue along with

custom design and made-to-order couplings. The global network of sales and service in our group gives JAURE® the possibility to provide standard components in the fastest way and to give service to our customers throughout the world.

Quality, Reliability and
a high level of
standardization



metals & heavy industry

Engineered to your needs

The most demanding metal works and heavy duty applications such as cement mills, mineral & mining demand JAURE® gear couplings & spindles.

JAURE's close partnership to the customer, the knowledge of their needs and the resulting engi-

neered-to-order solutions achieve the high requirements of such special applications.



JAURE's wide range in size and type of couplings can be adapted to any kind of situation. No size and torque limits have been encountered yet.

Research & development in the field of materials and treatments allow JAURE® to have more compact and enduring solutions, being in the forefront of the industry.

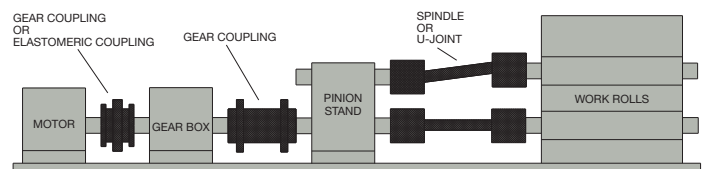



Jaure's wide range in size and types of couplings can be adapted to any kind of application

wind industry

Experience, reliability and global approach

For more than 20 years, JAURE® have been supplying high speed couplings, clamping sets, disc brakes and torque limiters for the wind industry all over the world.

Our engineers, in close cooperation with both our customers and engineering companies operating in the Wind industry, have developed latest generation coupling systems that respond to the most demanding requirements for the entire lifetime of any wind turbine from a few kW micro-machines to the biggest multi MW ones wherever they need to be installed either onshore and offshore.

Ixiflex and Compolink high speed couplings and JFTL torque limiters offer you more protection, greater strength,

more endurance, easy assembly and less maintenance always looking for optimum lifecycle cost for all your projects.





Ixiflex and
Compolink high
speed couplings and
JFTL torque limiters
offer you more
protection, greater
strength, more
endurance...

marine

Innovative solutions

Merchant, Yacht, Navy and Offshore vessels are equipped with JAURE® marine drives.

An extensive product portfolio includes: Marine style “MT” compact gear, maintenance free

“LAMIDISC” disc pack, elastic

“IXILFLEX” for high misalignment,

steel or “JCFS” composite shaft-

lines, “JHC” hydraulic-fit coupling.

Other components are offered such

as bulkhead seals, bearings, highly-elastic couplings,

brake systems enabling us to provide complete package solutions with no limitation in size.

that markets, such as main propulsion & manoeuvring of vessels, winches/deck machinery or dredging industry might require.

All our marine products are supplied with

the approval of prestigious companies, such as ABS, DNV, LRS, GL, KR, BV, etc. DNV Type Approvals are additionally available for our customers both for JAURE® gear and disc pack coupling.

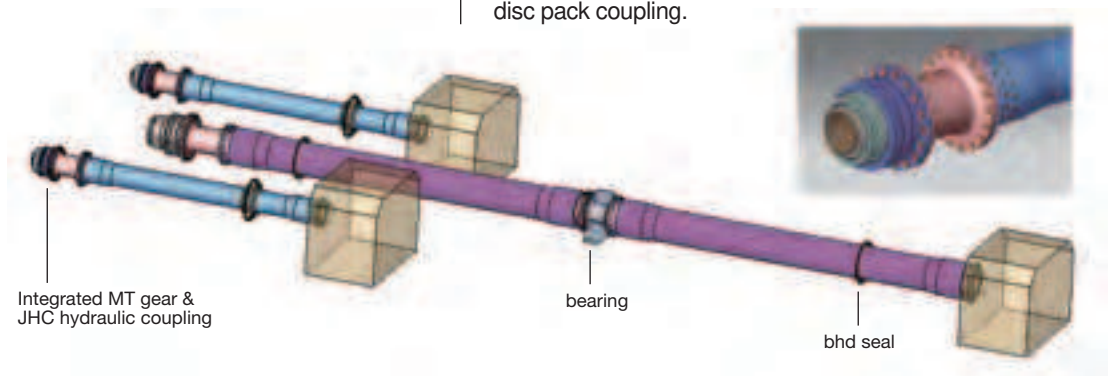

A large white ship is shown in a dry dock, illuminated by the warm, low light of a sunset. The ship's upper decks and bridge are visible, with several windows glowing from interior lights. To the left, a large, dark metal gantry structure dominates the foreground, partially obscuring the ship. In the background, other industrial structures and cranes are visible against the colorful sky. The water in the foreground is dark and reflects the ambient light.

We design and
supply class
approved complete
system solutions for
marine drives

Jaure manufacturing program

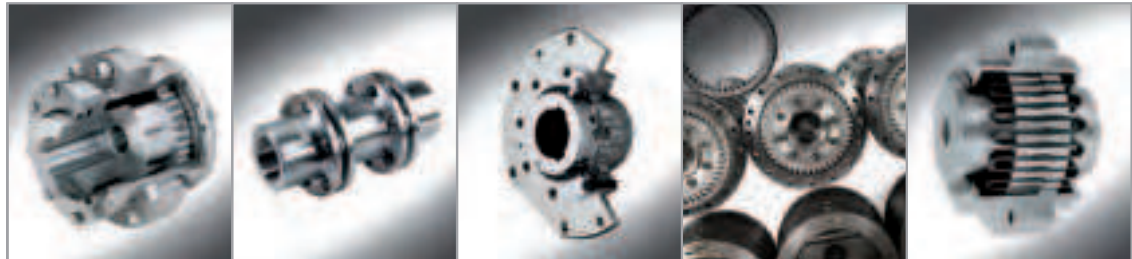

Product Brand Name	MT	LAMIDISC®	TCB / TCB-S	AL-S / AL-SD /ALD	RECORD®
Type & Description	Gear	Disc pack	Barrel (drum type)	Gear spindles	Grid / spring type

Industry Application

Metals & Heavy duty	•	•	•	•	•
Minerals & Mills	•	•	•		•
Crane & Hoisting	•	•	•		•
Pulp & Paper	•	•			•
Petrochemical / Oil & Gas	•	•			•
Cooling Towers		•			
Machine Tools		•			
Marine	•	•			
Wind Turbines		•			•
Test Benches	•	•			
Railway	•	•			



Special safety heavy duty gas
nitrided gears







LAMIDISC® Safety coupling on test bench
Incl. SAFESET®
(SAFESET® from VOITH TURBO)

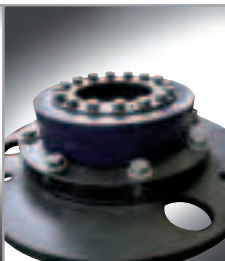
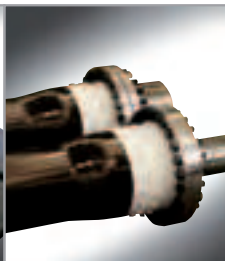

Type Approvals
(Marine & Wind)

power transmissions
solutions - couplings

					
JAUFLEX®	IXILFLEX®	COMPOLINK®	JFTL TORQUE LIMITER	JCS	JHC
Elastic	Elastic Link	Composite Link	Torque Limiter	Composite Shafts	Hydraulic fit (shaft couplings)

•			•		•
•			•		•
•			•		
•	•	•		•	
•		•		•	
		•		•	
•		•		•	
•	•	•	•	•	•
•	•	•	•	•	•
	•	•		•	•
	•	•	•		



Carbon Fibre Shaft combined with LAMIDISC® coupling



Torque monitoring on wind turbines

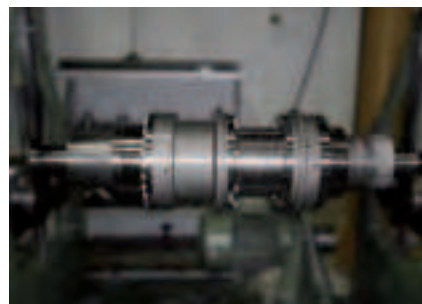

Double-gear couplings for railway

Kop-Flex & Jaure manufacturing program

Power Transmissions
Solutions - couplings



Product Brand Name	MAX-C®	HIGH PERFORMANCE PROGRAM			KOPFLEX GREASE	SERVICE
Type & Description	Heavy duty elastic coupling	GEAR	DISC	DIAPHRAGM	Gear coupling / spindle grease	Repair & maintenance program

Industry Application

Metals & Heavy duty	•				•	•
Minerals & Mills	•				•	•
Crane & Hoisting	•				•	•
Pulp & Paper					•	•
Petrochemical / Oil & Gas	•	•	•	•	•	•
Cooling Towers					•	•
Machine Tools					•	•
Marine	•	•	•	•	•	•
Wind Turbines	•				•	•
Test Benches	•	•	•	•	•	•
Railway	•	•			•	•

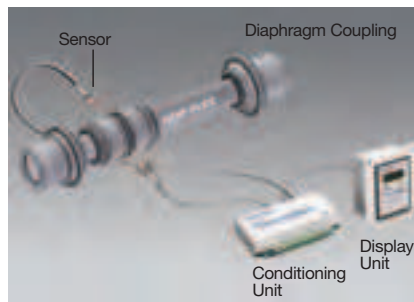

Powerlign® Torque Monitoring



High Performance Solutions

Global presence

Manufacturing facilities & Engineering Centers

JAURE® & KOP-FLEX® engineered couplings are designed, manufactured, sold and serviced worldwide, with service provided from specification right through to installation.

All JAURE® & KOP-FLEX® facilities around the globe are state of the art, with access to a large and experienced engineering staff focused on providing solutions for our customers' requirements.

A dedicated global sales and service team assists you to find the best choice and manage all your coupling needs.



JAURE®. Zizurkil, Spain



Pune, India



Nove Mesto, Slovakia



Zhangzhou, China



KOP-FLEX®.Baltimore, USA



Rexdale/Toronto, Canada



Apodaca, Mexico

JAURE®

JAURE®

JAURE S.A.
Ernio Bidea, s/n. - 20159 ZIZURKIL (Gipuzkoa) SPAIN
Phone: +34 943 69 00 54
Fax: +34 943 69 02 95
Fax Tech. Dept.: +34 943 69 03 17
e-mail: infojaure@emerson-ept.com
www.jaure.com
www.kopflex.com



Browning

JAURE

KOP-FLEX

MCGILL

Morse

ROLLWAY

SEALMASTER

**SYSTEM™
PLAST**