

Register your product and get support at

www.philips.com/welcome

DS3600



Thank you for choosing Philips.

Need help fast?

Read your Quick Start Guide and/or User Manual first for quick tips that make using your Philips product more enjoyable.

If you have read your instructions and still need assistance, you may access our online help at

www.philips.com/welcome or call

1-888-PHILIPS (744-5477) while with your product. (and Model / Serial number)



Philips vous remercie de votre confiance.

Besoin d'une aide rapide?

Le Guide rapide de début et Manuel de l'utilisateur regorgent d'astuces destinées à simplifier l'utilisation de votre produit Philips.

Toutefois, si vous ne parvenez pas à résoudre votre problème, vous pouvez accéder à notre aide en ligne à l'adresse

www.philips.com/welcome ou formez le

1-800-661-6162 (Francophone)
1-888-PHILIPS (744-5477) (English speaking)

Veillez à avoir votre produit à portée de main.

(et model / serial nombre)



Gracias por escoger Philips

Necesita ayuda inmediata?

Lea primero la Guía rápida del comienzo o el Manual del usuario, en donde encontrará consejos que le ayudarán a disfrutar plenamente de su producto Philips.

Si después de leerlo aún necesita ayuda, consulte nuestro servicio de asistencia en línea en

www.philips.com/welcome o llame al teléfono

1-888-PHILIPS (744-5477) y tenga a mano el producto. (y número de model / serial)



EN User manual

PHILIPS

Contents

1	Important	3
	Safety	3

2	Your Docking Speaker	4
	Introduction	4
	What's in the box	4
	Overview of the main unit	5
	Overview of the remote control	6

3	Get started	6
	Prepare the remote control	6
	Connect power	6
	Turn on	7

4	Play	7
	Play from iPod/iPhone/iPad	7
	Play from Bluetooth devices	9
	Play from an external audio device	10
	Adjust volume	10
	Mute sound	10

5	Product information	11
	Specifications	11

6	Troubleshooting	11
	About Bluetooth device	12

7	Notice	12
	RSS	13
	Disposal of your old product and batteries	13

1 Important

Safety

Know these safety symbols



This 'bolt of lightning' indicates uninsulated material within your unit may cause an electrical shock. For the safety of everyone in your household, please do not remove product covering.

The 'exclamation point' calls attention to features for which you should read the enclosed literature closely to prevent operating and maintenance problems.

WARNING: To reduce the risk of fire or electric shock, this apparatus should not be exposed to rain or moisture and objects filled with liquids, such as vases, should not be placed on this apparatus.

CAUTION: To prevent electric shock, match wide blade of plug to wide slot, fully insert.

Important Safety Instructions

- ① Read these instructions.
 - ② Keep these instructions.
 - ③ Heed all warnings.
 - ④ Follow all instructions.
 - ⑤ Do not use this apparatus near water.
 - ⑥ Clean only with dry cloth.
 - ⑦ Do not block any ventilation openings. Install in accordance with the manufacturer's instructions.
 - ⑧ Do not install near any heat sources such as radiators, heat registers, stoves, or other apparatus (including amplifiers) that produce heat.
 - ⑨ Protect the power cord from being walked on or pinched, particularly at plugs, convenience receptacles, and the point where they exit from the apparatus.
 - ⑩ Only use attachments/accessories specified by the manufacturer.
 - ⑪ Use only with the cart, stand, tripod, bracket, or table specified by the manufacturer or sold with the apparatus. When a cart is used, use caution when moving the cart/apparatus combination to avoid injury from tip-over.
- 
- The image is a circular prohibition sign with a diagonal slash. Inside the circle, there is a silhouette of a person pushing a cart with a large apparatus on it. The sign indicates that using the apparatus on a cart is prohibited.
- ⑫ Unplug this apparatus during lightning storms or when unused for long periods of time.
 - ⑬ Refer all servicing to qualified service personnel. Servicing is required when the apparatus has been damaged in any way, such as power-supply cord or plug is damaged, liquid has been spilled or objects have fallen into the apparatus, the apparatus has been exposed to rain or moisture, does not operate normally, or has been dropped.
 - ⑭ Apparatus shall not be exposed to dripping or splashing.
 - ⑮ Do not place any sources of danger on the apparatus (e.g. liquid filled objects, lighted candles).
 - ⑯ This product may contain lead and mercury. Disposal of these materials may be regulated due to environmental considerations. For disposal or recycling

information, please contact your local authorities or the Electronic Industries Alliance: www.eiae.org.

- ⑰ Where the plug of the Direct Plug-in Adapter is used as the disconnect device, the disconnect device shall remain readily operable.

Warning

- Keep the battery away from heat, sunshine or fire. Never discard battery in fire.
- Replace the battery with the same or equivalent type only.
- The battery contains chemical substances, so it should be disposed of properly.
- The button cell battery cannot be swallowed. Keep children away from the battery.
- The USB socket is for data transmission only.
- Never remove the casing of this apparatus.
- Make sure that you always have easy access to the power cord, plug or adaptor to disconnect the apparatus from the power.

Risk of swallowing batteries

- The product/remote control may contain a button cell battery, which is possible to be swallowed. Keep the battery out of reach of children at all times! If swallowed, the battery can cause serious injury or death. Severe internal burns can occur within two hours of ingestion.
- If you suspect that a battery has been swallowed or placed inside any part of the body, seek immediate medical attention.
- When you change the batteries, always keep all new and used batteries out of reach of children. Ensure that the battery compartment is completely secure after you replace the battery.
- If the battery compartment cannot be completely secured, discontinue use of the product. Keep out of reach of children and contact the manufacturer.

2 Your Docking Speaker

Congratulations on your purchase, and welcome to Philips! To fully benefit from the support that Philips offers, register your product at www.philips.com/welcome.

If you contact Philips, you will be asked for the model and serial number of this apparatus. The model number and serial number are on the bottom of the apparatus. Write the numbers here:

Model No. _____

Serial No. _____

Introduction

With this docking speaker, you can

- enjoy audio from the iPod/iPhone/iPad, Bluetooth devices and other external audio devices; and
- synchronize the iPod/iPhone/iPad with your computer through USB socket.

What's in the box

Check and identify the contents of your package:

- Main unit
- Remote control (with battery)
- AC power adaptor
- Quick start guide

Overview of the main unit

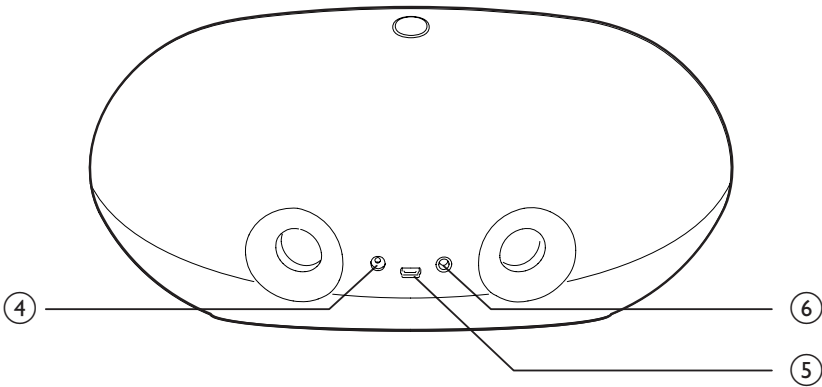
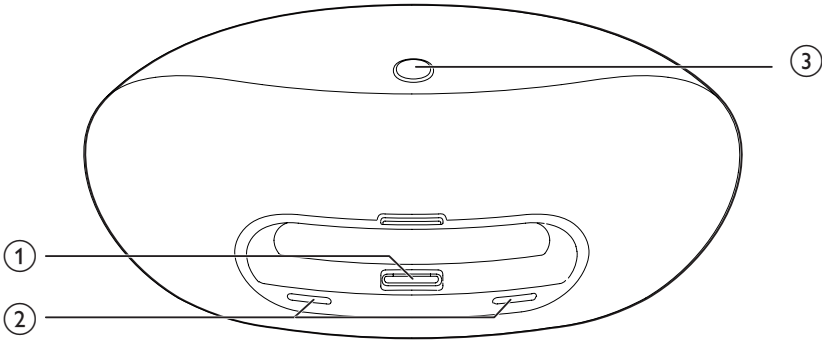

① Dock for the iPod/iPhone/iPad

② + / -

- Adjust volume.
- As LED indicators, show system status.

③ *

- Select Bluetooth mode.
- Turn the docking speaker on.
- Switch to standby mode.

④ Power supply socket

- Connect AC power.

⑤ 

- Sync with PC through a USB cable.

⑥ MP3-LINK

- Connect an external audio device.

Overview of the remote control

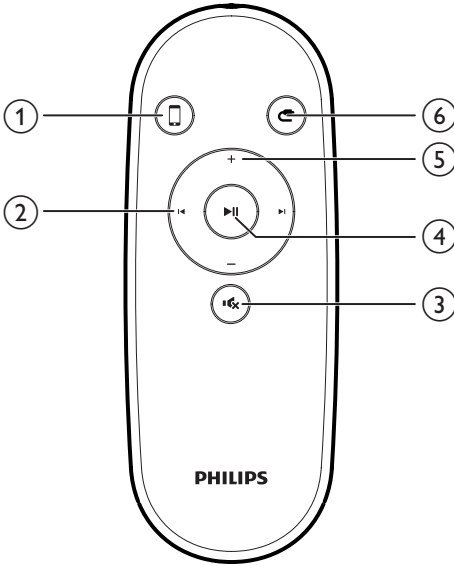

- ①
 - Select iPod/iPhone/iPad dock mode.
- ②
 - Skip to a track.
 - Search within play.
- ③
 - Mute volume.
- ④
 - Start or pause play.
- ⑤
 - Adjust volume.
- ⑥
 - Select MP3 link mode.

3 Get started

Always follow the instructions in this chapter in sequence.

Prepare the remote control

For first-time use:

Remove the protective tab to activate the remote control battery.

To replace the exhausted battery:

- 1 Open the battery tray.
- 2 Insert one CR2025 battery with correct polarity (+/-) as indicated.
- 3 Close the battery tray.

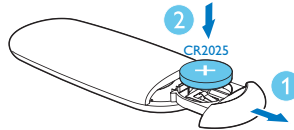

Connect power

! Caution

- Risk of product damage! Make sure that the power supply voltage matches the voltage printed on the bottom of the unit.
- Risk of electric shock! When you unplug the AC adaptor, always pull the plug from the socket. Never pull the cord.
- Before connecting the AC adaptor, ensure you have completed all other connections.

≡ Note

- The type plate is located at the back of the main unit.

Connect the AC power adaptor to:

- the power supply socket on the back of the docking speaker.
- the wall outlet.

4 Play

Play from iPod/iPhone/iPad

You can enjoy audio from iPod/iPhone/iPad through this docking speaker.

Compatible iPod/iPhone/iPad

The docking speaker supports the following iPod/iPhone/iPad models:

Made for:

- iPod touch (1st, 2nd, 3rd, and 4th generation)
- iPod nano (1st, 2nd, 3rd, 4th, 5th, and 6th generation)
- iPhone 4S
- iPhone 4
- iPhone 3GS
- iPhone 3G
- iPhone
- iPad 2
- iPad

Listen to the iPod/iPhone/iPad

Philips **DockStudio** app brings a suite of new features to your docking speaker. To enjoy more features, you are recommended to install this free application.

- 1 Insert your iPod/iPhone/iPad into the dock.
 - ↳ The docking system switches to Dock source automatically.
 - ↳ The orange LED indicators light up.

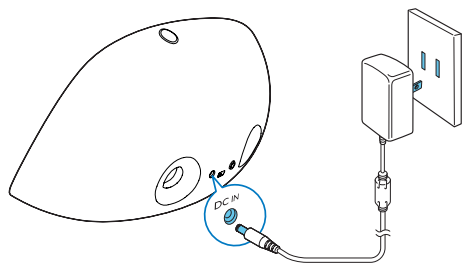

Turn on

Press and hold **⏻** on the main unit for 2 seconds.

↳ The + / - LED indicators light up.

Switch to standby mode

In the following situation, the docking speaker switches to standby mode:

- Press and hold **⏻** for 2 seconds again; or
- The system is idle for 15 minutes.

↳ In standby mode, the LED indicators light off.

Note

- In standby mode, if you press **⏻** on the main unit or **⏻** / **⏻** on the remote control, the docking speaker switches to the corresponding selected source.

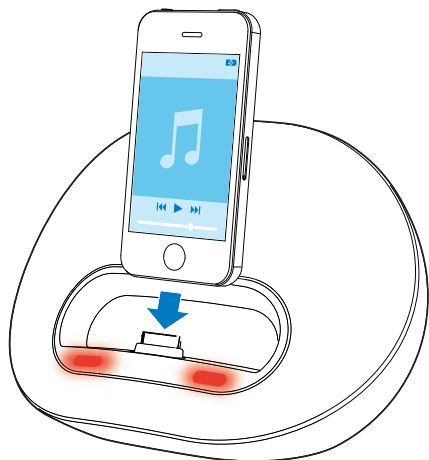

- To pause or resume play, press ►||.
- To skip to a track, press ◀/▶.
- To search during play, press and hold ◀/▶, then release to resume normal play.

Update firmware

If firmware update is available, the **DockStudio** app will search for it automatically and ask you to download it.

Note

- Make sure that your iPod/iPhone/iPad is inserted in the docking speaker and connected to the Internet.

- 2 For first-time use, you will be asked to install **DockStudio** app on your iPod/iPhone/iPad.
- 3 Tap **[Yes]** (yes) to accept the installation request.
- 4 Follow the on-screen instructions to complete the installation.

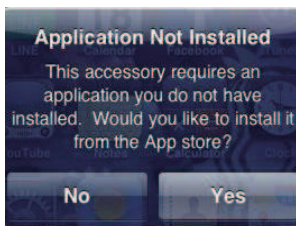

- 5 Launch the app after the installation.
- 6 Play audio on your iPod/iPhone/iPad.
 - ↳ Audio comes out through this docking speaker.

- 1 If a new firmware update is found, tap **OK**.

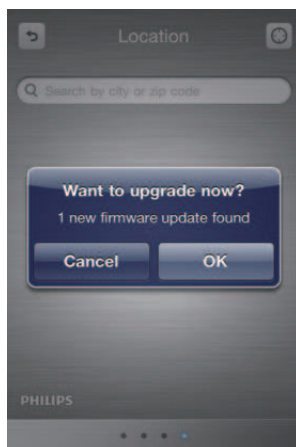

Tip

- You can press  to select Dock source.
- With the **DockStudio** app, you can enjoy music, set clock and alarm, adjust sound settings, update firmware, and so on.

- 2 Follow the on-screen instructions to complete the firmware update.

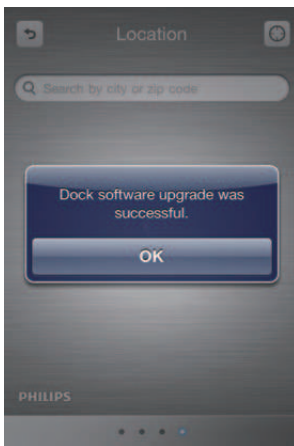
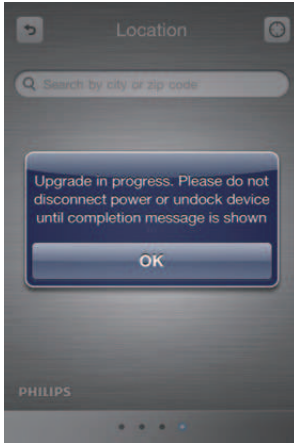

Note

- Do not disconnect power or undock the iPod/iPhone/iPad during the updating process.

Charge the iPod/iPhone/iPad

When the docking speaker is connected to power, the docked iPod/iPhone/iPad begins to charge automatically.

Sync iPod/iPhone/iPad with PC

Note

- Make sure that iTunes has been configured properly in your PC.

- 1 Insert the iPod/iPhone/iPad in the dock.
- 2 Press and hold \mathbb{H} for 2 seconds to switch the docking speaker to standby mode.
↳ The LED indicators light off.
- 3 Connect your docking speaker and PC with a USB cable.
- 4 Launch iTunes to synchronize your docking speaker with PC.
↳ The docked iPod/iPhone/iPad is synchronized with PC successfully through the iTunes.

Note

- Due to different materials and product techniques, some USB cables may not work with this device.

Play from Bluetooth devices

Note

- Before you connect a Bluetooth device to this docking speaker, familiarize yourself with the Bluetooth capabilities of the device.
- Keep this docking speaker away from other electronic devices that may cause interference.
- Any obstacle between the speaker and the device can reduce the operational range.

- 1 Press \mathbb{H} to select Bluetooth source.
↳ The blue Bluetooth indicator flashes slowly.

- 2 Turn on Bluetooth function on your device.
- Different devices may have different way to activate Bluetooth.

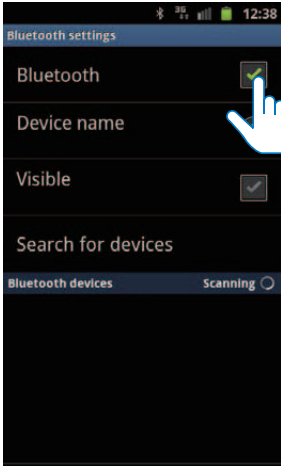

- 3 Scan Bluetooth devices that can pair with your device.
- 4 When “PHILIPS DS3600” is displayed on your device, select it to start connection.
- ↳ Double beep tone confirmation can be heard and the Bluetooth indicator light up stably if connection is successful.
- 5 Play music in your device.
- ↳ Music comes through the docking speaker.

 Tip

- If your Bluetooth device has been paired with DS3600 before, you just need to find out “PHILIPS DS3600” on your Bluetooth menu, then confirm the connection.

To disconnect Bluetooth:

- Press **⌘** on the docking speaker again, or
- Deactivate Bluetooth function on your device or move it beyond the communication range.

Play from an external audio device

- 1 If no iPod/iPhone/iPad is docked, connect an MP3 link cable (3.5mm, not supplied) to:
- the **MP3-LINK** socket at the back of the docking speaker.
 - the headphone socket on an external device.
- ↳ The docking speaker switches to MP3 link mode automatically.
- 2 Play music on the device (see the device's user manual).

 Tip

- You can select MP3 link source by pressing **⏮** on the remote control.

Adjust volume

To adjust volume:

- Press **+/-** on your docking speaker; or
- Adjust the volume control of your iPod/iPhone/iPad, Bluetooth device, or other external device.

Mute sound

During play, press **⏸** to mute or unmute sound.

5 Product information

Note

- Product information is subject to change without prior notice.

Specifications

Amplifier

Rated Output Power	2 X 10 W RMS
Signal to Noise Ratio	> 57 dBA
Aux-in Link	500mV RMS

Bluetooth

Standard	Bluetooth Standard Version 2.1+EDR
Output power	0 dBm (Class 2)
Frequency band	2.402~2.480 GHzISM Band
Range	10m (free space)

General information

AC Power	Model: AS300-120-AA250 (Philips); Input: 100-240V ~, 50/60Hz, 1.1A; Output: 12V \equiv 2.5 A
Operation Power Consumption	15 W
Standby Power Consumption	<0.5 W
Max. load for iPod/iPhone/iPad	5 V \equiv 2.1 A
Dimensions	
- Main Unit (W x H x D)	285 x 136 x 143 mm
Weight	
- Main Unit	1.2 kg
- With Packing	2.0 kg

6 Troubleshooting



Warning

- Never remove the casing of this device.

To keep the warranty valid, never try to repair the system yourself.

If you encounter problems when using this device, check the following points before requesting service. If the problem remains unsolved, go to the Philips Web page (www.philips.com/support). When you contact Philips, make sure that the device is nearby and the model number and serial number are available.

No power

- Ensure that the AC power adaptor of the unit is connected properly.
- Ensure that there is power at the AC outlet.

No sound or poor sound

- Adjust the volume of your docking speaker.
- Adjust the volume of your iPod/iPhone/iPad, Bluetooth devices or other external devices.

No response from the unit

- Disconnect and reconnect the AC power adaptor; then turn on the unit again.

Cannot sync with PC

- Switch the docking speaker to standby mode.
- Try another USB cable.
- Install iTunes in PC properly.

About Bluetooth device

Music playback is unavailable on the system even after successful Bluetooth connection.

- The device cannot be used with the system to play music.

The audio quality is poor after connection with a Bluetooth-enabled device.

- The Bluetooth reception is poor. Move the device closer to the system or remove any obstacle between the device and the system.

Cannot connect with the system.

- The device does not support the profiles required for the system.
- The Bluetooth function of the device is not enabled. Refer to the user manual of the device for how to enable the function.
- The system is not in the pairing mode.
- The system is already connected with another Bluetooth-enabled device. Disconnect that device or all other connected devices and then try again.

The paired device connects and disconnects constantly.

- The Bluetooth reception is poor. Move the device closer to the system or remove any obstacle between the device and the system.
- For some devices, the Bluetooth connection may be deactivated automatically as a power-saving feature. This does not indicate any malfunction of the system.

7 Notice

Any changes or modifications made to this device that are not expressly approved by Philips Consumer Lifestyle may void the user's authority to operate the equipment.



"Made for iPod," "Made for iPhone," and "Made for iPad" mean that an electronic accessory has been designed to connect specifically to iPod, iPhone, or iPad, respectively, and has been certified by the developer to meet Apple performance standards. Apple is not responsible for the operation of this device or its compliance with safety and regulatory standards. Please note that the use of this accessory with iPod, iPhone, or iPad may affect wireless performance.

iPod and iPhone are trademarks of Apple Inc., registered in the U.S. and other countries. iPad is a trademark of Apple Inc.

Notice for the USA

This equipment has been tested and found to comply with the limits for a Class B digital device, pursuant to part 15 of the FCC Rules.

These limits are designed to provide reasonable protection against harmful interference in a residential installation. This equipment generates, uses, and can radiate radio frequency energy and, if not installed and used in accordance with the instruction manual, may cause harmful interference to radio communications. However, there is no guarantee that interference will not occur in a particular installation. If this equipment does cause harmful interference to radio or television reception, which can be determined by turning the equipment off and on, the user is encouraged to try to correct the interference by one or more of the following measures:

- Relocate the receiving antenna.

- Increase the separation between equipment and receiver.
- Connect the equipment into an outlet on a circuit different from that to which the receiver is connected.
- Consult the dealer or an experienced radio/TV technician for help.

This equipment complies with FCC's and IC's RF radiation exposure limits set forth for an uncontrolled environment. The antenna(s) used for this transmitter must be installed and operated to provide a separation distance of at least 20 cm from all persons and must not be collocated or operating in conjunction with any other antenna or transmitter. Installers must ensure that 20cm separation distance will be maintained between the device (excluding its handset) and users.

RSS

This device complies with Industry Canada license-exempt RSS standard(s). Operation is subject to the following two conditions: (1) this device may not cause harmful interference, and (2) this device must accept any interference received, including interference that may cause undesired operation.

Disposal of your old product and batteries

Your product is designed and manufactured with high quality materials and components, which can be recycled and reused. Never dispose of your product with other household waste. Please inform yourself about the local rules on the separate collection of electrical and electronic products and batteries. The correct disposal of these products helps prevent potentially negative consequences on the environment and human health. Your product contains batteries, which cannot be disposed of with normal household waste.

Please inform yourself about the local rules on separate collection of batteries. The correct disposal of batteries helps prevent potentially negative consequences on the environment and human health.

Please visit www.recycle.philips.com for additional information on a recycling center in your area.

Environmental information

All unnecessary packaging has been omitted. We have tried to make the packaging easy to separate into three materials: cardboard (box), polystyrene foam (buffer) and polyethylene (bags, protective foam sheet.) Your system consists of materials which can be recycled and reused if disassembled by a specialized company. Please observe the local regulations regarding the disposal of packaging materials, exhausted batteries and old equipment.

Register online at www.philips.com/welcome today to
get the very most from your purchase.

Registering your model with PHILIPS makes you eligible for all of the valuable benefits listed below, so don't miss out. Register online at www.philips.com/welcome to ensure:

*Product Safety Notification

By registering your product, you'll receive notification directly from the manufacturer.

*Additional Benefits

Registering your product guarantees that you'll receive all of the privileges to which you're entitled, including special money-saving offers.

PHILIPS

*Congratulations on your purchase,
and welcome to the "family!"*

Dear PHILIPS product owner:

Thank you for your confidence in PHILIPS. You've selected one of the best-built, best-backed products available today. We'll do everything in our power to keep you happy with your purchase for many years to come.

As a member of the PHILIPS "family," you're entitled to protection by one of the most comprehensive warranties in the industry. What's more, your purchase guarantees you'll receive all the information and special offers for which you qualify, plus easy access to accessories from our convenient home shopping network.

Most importantly, you can count on our uncompromising commitment to your total satisfaction.

All of this is our way of saying welcome - and thanks for investing in a PHILIPS product.

P.S. To get the most from your PHILIPS purchase, be sure to register online at:

www.philips.com/welcome

Know these safety symbols



This "bolt of lightning" indicates uninsulated material within your unit may cause an electrical shock. For the safety of everyone in your household, please do not remove product covering.

The "exclamation point" calls attention to features for which you should read the enclosed literature closely to prevent operating and maintenance problems.

WARNING: To reduce the risk of fire or electric shock, this apparatus should not be exposed to rain or moisture and objects filled with liquids, such as vases, should not be placed on this apparatus.

CAUTION: To prevent electric shock, match wide blade of plug to wide slot, fully insert.

ATTENTION: Pour éviter les chocs électriques, introduire la lame la plus large de la fiche dans la borne correspondante de la prise et pousser jusqu'au fond.

For Customer Use

Enter below the Serial No. which is located on the rear of the cabinet. Retain this information for future reference.

Model No. _____
Serial No. _____

PHILIPS

Visit our World Wide Web Site at <http://www.philips.com>

PHILIPS LIMITED WARRANTY

ONE (1) YEAR

WARRANTY COVERAGE:

PHILIPS warranty obligation is limited to the terms set forth below.

WHO IS COVERED:

Philips warrants the product to the original purchaser or the person receiving the product as a gift against defects in materials and workmanship as based on the date of original purchase ("Warranty Period") from an Authorized Dealer. The original sales receipt showing the product name and the purchase date from an authorized retailer is considered such proof.

WHAT IS COVERED:

The Philips warranty covers new products if a defect in material or workmanship occurs and a valid claim is received by Philips within the Warranty Period. At its option, Philips will either (1) repair the product at no charge, using new or refurbished replacement parts, or (2) exchange the product with a product that is new or which has been manufactured from new, or serviceable used parts and is at least functionally equivalent or most comparable to the original product in Philips current inventory, or (3) refund the original purchase price of the product. Philips warrants replacement products or parts provided under this warranty against defects in materials and workmanship from the date of the replacement or repair for ninety (90) days or for the remaining portion of the original product's warranty, whichever provides longer coverage for you. When a product or part is exchanged, any replacement item becomes your property and the replaced item becomes Philips' property. When a refund is given, your product becomes Philips' property.

Note: Any product sold and identified as refurbished or renewed carries a ninety (90) day limited warranty.

Replacement product can only be sent if all warranty requirements are met. Failure to follow all requirements can result in delay.

WHAT IS NOT COVERED - EXCLUSIONS AND LIMITATIONS:

This Limited Warranty applies only to the new products manufactured by or for Philips that can be identified by the trademark, trade name, or logo affixed to it. This Limited Warranty does not apply to any non-Philips hardware product or any software, even if packaged or sold with the product. Non-Philips manufacturers, suppliers, or publishers may provide a separate warranty for their own products packaged with the bundled product.

Philips is not liable for any damage to or loss of any programs, data, or other information stored on any media contained within the product, or any non-Philips product or part not covered by this warranty. Recovery or reinstallation of programs, data or other information is not covered under this Limited Warranty.

This warranty does not apply (a) to damage caused by accident, abuse, misuse, neglect, misapplication, or non-Philips product, (b) to damage caused by service performed by anyone other than Philips or Philips Authorized Service Location, (c) to a product or a part that has been modified without the written permission of

Philips, or (d) if any Philips serial number has been removed or defaced, or (e) product, accessories or consumables sold "AS IS" without warranty of any kind by including refurbished Philips product sold "AS IS" by some retailers.

This Limited Warranty does not cover:

- Shipping charges to return defective product to Philips.
- Labor charges for installation or setup of the product, adjustment of customer controls on the product, and installation or repair of antenna/signal source systems outside of the product.
- Product repair and/or part replacement because of improper installation or maintenance, connections to improper voltage supply, power line surge, lightning damage, retained images or screen markings resulting from viewing fixed stationary content for extended periods, product cosmetic appearance items due to normal wear and tear, unauthorized repair or other cause not within the control of Philips.
- Damage or claims for products not being available for use, or for lost data or lost software.
- Damage from mishandled shipments or transit accidents when returning product to Philips.
- A product that requires modification or adaptation to enable it to operate in any country other than the country for which it was designed, manufactured, approved and/or authorized, or repair of products damaged by these modifications.
- A product used for commercial or institutional purposes (including but not limited to rental purposes).
- Product lost in shipment and no signature verification receipt can be provided.
- Failure to operate per Owner's Manual.

TO OBTAIN ASSISTANCE IN THE U.S.A., PUERTO RICO, OR U.S. VIRGIN ISLANDS...

Contact Philips Customer Care Center at:
1-888-PHILIPS (1-888-744-5477)

TO OBTAIN ASSISTANCE IN CANADA...

1-800-661-6162 (French Speaking)
1-888-PHILIPS (1-888-744-5477) - (English or Spanish Speaking)

REPAIR OR REPLACEMENT AS PROVIDED UNDER THIS WARRANTY IS THE EXCLUSIVE REMEDY FOR THE CONSUMER. PHILIPS SHALL NOT BE LIABLE FOR ANY INCIDENTAL OR CONSEQUENTIAL DAMAGES FOR BREACH OF ANY EXPRESS OR IMPLIED WARRANTY ON THIS PRODUCT. EXCEPT TO THE EXTENT PROHIBITED BY APPLICABLE LAW, ANY IMPLIED WARRANTY OF MERCHANTABILITY OR FITNESS FOR A PARTICULAR PURPOSE ON THIS PRODUCT IS LIMITED IN DURATION TO THE DURATION OF THIS WARRANTY.

Some states do not allow the exclusions or limitation of incidental or consequential damages, or allow limitations on how long an implied warranty lasts, so the above limitations or exclusions may not apply to you.

This warranty gives you specific legal rights. You may have other rights which vary from state/province to state/province.

Philips, P.O. Box 10313 Stamford, CT 06904

3140 035 50201

Philips Consumer Lifestyle
A division of Philips Electronics North America Corporation
P.O. Box 10313
Stamford, CT 06904
Phone: 1-888-PHILIPS (744-5477)

Meet Philips at the Internet
<http://www.philips.com/welcome>



Specifications are subject to change without notice
© 2012 Koninklijke Philips Electronics N.V.
All rights reserved.

DS3600_37_UM_V1.0

