



Prices effective February 2, 2015

Aeron® Chairs

Introduction	page 2
Aeron® Chairs	3
Work Chair	5
Work Stool	8
Side Chair	11
Accessories	12
Appendices	
20-Day or Less/Assigned Lead-Time Order Information	
Casters and Glides	
Size/Fit Reference - Aeron Chair	
Fire Retardancy-Seating	
Customer's Own Material/Customer's Own Leather Order Information-Seating	
Open Line Textiles Application Chart-Seating	
Open Line Textile Colors-Seating	
Proprietary Textiles Application Chart-Seating	
Proprietary Textile Colors-Seating	
For the latest materials information, refer to the Materials pages on HermanMiller.com.	

Introduction

A Note on the Organization of This Book

There are a few signals that will help you understand the organization of this book. Once you know them, you should be able to find your way around easily.

Like a newspaper, this book is formatted with columns of text and illustrations that run vertically.

Information wraps from one column to the next and continues for as many pages as it needs to.

Black bars are clues.

A black bar at the top of a page signals the start of information about a product.

This information is divided into two sections, each signaled by a black bar. Product Information includes a description, additional notes, and dimensional drawings. Specification Information, which always begins at the top of a column, includes a series of steps. Each step represents a decision you need to make in order to complete your product number. Steps must be followed sequentially. The number of pages needed to complete information on a product varies; some will be complete in one page; others may fill three or four pages. Just continue going through the steps until you run into the next product, signaled by the black bar at the top of the page.

Black tabs running along the outside edge of the page help you locate what section you are in or what section you want to go to. You can thumb forwards or backwards to find a section; tabs and text appear on both sides of the page.

The additional pages in the back of the book include the appendices and indices. They are signaled by a long black bar running along the outside edge of the page.

The index is presented two ways.

The first index is in alphabetical order by product name. It can be helpful if you are new to the products and numbering scheme or if you are looking for a type of product, such as work chair or round table.

The second index is by product number. It lists, in alphanumeric order, the base product number, typically a five-digit number.

General Information

This book is effective February 2, 2015, subject to change without notice. Products may be purchased from authorized Herman Miller dealers who will quote prices upon request. For more information about our products and services or to see a list of dealers, visit www.HermanMiller.com.

All prices are list prices. Additional services, such as planning services, design, storage, and installation, are not included and must be added to these prices when the additional services are requested.

Illustrations, specifications, and prices are based on the latest information at the time of publication. The right is reserved to make changes at any time without notice in prices, fabrics, finishes, materials, specifications, and models, and also to discontinue models and finishes.

Dimensions shown in the drawings are engineering drawing dimensions rounded up to the nearest $\frac{1}{8}$ ". Product is shipped set up or knocked down. Products that include "Shipped knocked down" in the description require some assembly. If this statement does not appear in the description, the product is shipped assembled.

Service problems are normally handled by a Herman Miller authorized dealer. Where this cannot be accomplished on a local level, service problems should be referred to the Customer Care Representative for your region, Herman Miller, Inc., Zeeland, Michigan 49464.

20-Day or Less/Assigned Lead-Time Shipments

All products and options in this price book not designated by an Assigned Program icon  will ship in **20 business days or less** after being acknowledged by Herman Miller.

Products and options designated by an  are on the assigned lead-time program and may ship in 20 days, less than 20 days, or more than 20 days from order acknowledgement.

Work Chair

Work Stool

Side Chair

Accessories



Work Chair

AE111
AE112
AE113



Product Information

Description

This chair has 3 sizes and a Pellicle® material that conforms to the user's body and retains its original shape when unoccupied. The material is lightweight and breathable and distributes the user's weight evenly over the seat and back of the chair. The chair has pneumatic height adjustment and a Kinemat® tilt that lets the body naturally pivot at the ankles, knees, and hips.

Tilt options include a tilt limiter that allows the user to select the tilt range to limit the amount of recline; a tilt limiter and seat angle that allows the user to select the tilt range and a horizontal or 5° forward seat angle; or a standard tilt.

Back-support options include PostureFit® support and an adjustable lumbar support. The PostureFit support provides a custom fit in the lower back area, below the beltline, that helps achieve healthier posture and improved lower back comfort. The user can adjust the level of support with a lever.

Arm choices include a fixed, nonadjustable option; a height-adjustable option that moves the arms 4" vertically; and a fully adjustable option that moves the arms 4" vertically and pivots the armpads 15° outward and 17½° inward.

The ZB, WS, and G8 base/frame finishes include a frame applique.

These appliques are applied to an Aeron work chair's seat, back, and arms to minimize the effect of contact between the chair and a wood-edge surface. The G8 option does not include an arm coating.

The frame applique options (ZB, WS, and G8) do not meet CAL 133 requirements. A fire retardant chair meets CAL 133 requirements. The chair's Pellicle material is manufactured with a fire-retardant additive.

Notes

To help determine chair size, see Aeron Chair Size/Fit Reference in Appendices. A-, B-, and C-size chairs are tested and warranted for use by persons 300 pounds and under.

For information on casters and glides, see Casters and Glides in Appendices.

PostureFit support is not available on standard tilt option.

Customer's Own Leather (COL) can be applied to armpads; requires 4 square feet. See Order Information in Appendices.

Dimensions

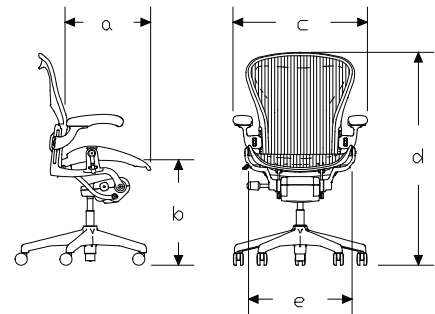

	Size A	Size B	Size C
a	15 3/4	17	18 1/2
b	14 3/8-19 1/2	15-20 7/8	15-20 7/8
c	25 3/4	27	28 1/4
d	41 max	42 max	45 max
e	19	20 1/4	21 5/8

All dimensions are in inches.

Specification Information

Step 1.

AE11

Step 2. Tilt

- 1** standard tilt
- 2** tilt limiter
- 3** tilt limiter and seat angle

Step 3. Arms

- N** no arms
- P** fixed arms
- H** height-adjustable arms
- A** fully adjustable arms

Step 4. Armpad Upholstery

For no arms (N)

- N** no arms

For fixed arms (P), height-adjustable arms (H), or fully adjustable arms (A)

- W** nonupholstered armpads
- F** leather armpads

Step 5. Size

- A** a size
- B** b size
- C** c size

Step 6. Fire Retardancy

For not fire retardant (), skip this step.*

- FR** fire retardant A

Prices for Steps 1-6.

		A*	AFR	B*	BFR	C*	CFR
AE111	N N	\$1009	1009	1009	1009	1009	1009
	P W	\$1146	1146	1146	1146	1146	1146
	F	\$1195	1195	1195	1195	1195	1195
	H W	\$1213	1213	1213	1213	1213	1213
	F	\$1263	1263	1263	1263	1263	1263
	A W	\$1292	1292	1292	1292	1292	1292
	F	\$1342	1342	1342	1342	1342	1342
AE112	N N	\$1071	1071	1071	1071	1071	1071
	P W	\$1208	1208	1208	1208	1208	1208
	F	\$1257	1257	1257	1257	1257	1257

H W	\$1276	1276	1276	1276	1276	1276
F	\$1324	1324	1324	1324	1324	1324
A W	\$1355	1355	1355	1355	1355	1355
F	\$1406	1406	1406	1406	1406	1406
AE113 N N	\$1141	1141	1141	1141	1141	1141
P W	\$1276	1276	1276	1276	1276	1276
F	\$1324	1324	1324	1324	1324	1324
H W	\$1344	1344	1344	1344	1344	1344
F	\$1393	1393	1393	1393	1393	1393
A W	\$1427	1427	1427	1427	1427	1427
F	\$1475	1475	1475	1475	1475	1475

Step 7. Back Support Option

For standard tilt (1)

- N2** no additional support +\$0
- AJ** adjustable lumbar support +\$65

For tilt limiter (2) or tilt limiter and seat angle (3)

- N2** no additional support +\$0
- AJ** adjustable lumbar support +\$65
- PJ** adjustable PostureFit® support +\$95

Step 8. Base/Frame Finish

For not fire retardant ()*

- G1** graphite +\$0
- XT** titanium with smoke frame +\$0
- WS** titanium with smoke frame and smoke applique +\$134
- ZB** graphite with graphite applique +\$134
- CD** polished aluminum with graphite frame +\$300
- G8** polished aluminum with graphite frame and graphite applique A +\$434

For fire retardant (FR)

- G1** graphite +\$0
- CD** polished aluminum with graphite frame A +\$300

Step 9. Casters/Glides

- BB** 2½" hard caster, black yoke, carpet only +\$0
- GF** 2½" glide, hard floors or carpet +\$0
- C7** 2½" caster, black yoke, hard floors or carpet +\$40
- C9** 2½" braking caster, black yoke, hard floors or carpet +\$40

Step 10. Armpad Finish

For nonupholstered armpads (W) with not fire retardant, or fire retardant (FR) with graphite (G1), or polished aluminum with graphite frame (CD), or graphite with graphite applique (ZB), or polished aluminum with graphite frame and graphite applique (G8)

BK black +\$0

For nonupholstered armpads (W) with not fire retardant with titanium with smoke frame (XT), or titanium with smoke frame and smoke applique (WS)

S8 smoke +\$0

Step 11. Pellicle® Material

See application chart and textiles list for material usage and numbers. First 2 digits of number indicate material; remaining 2 digits indicate color.

For fire retardant (FR) with graphite (G1), or polished aluminum with graphite frame (CD)

Price Category 1 +\$0

For not fire retardant ()*

Price Category 1 +\$0

Price Category 2 +\$28

Step 12. Armpad Leather

For fixed arms (P), height-adjustable arms (H), or fully adjustable arms (A) with leather armpads (F)

See application chart and textiles list for fabric usage and numbers. First 2 digits of number indicate fabric line; remaining digit(s) indicate fabric color.

Price Category 7 A +\$0

Price Category 9 +\$75

Work Stool

AE711
AE712
AE713
AE721
AE722
AE723

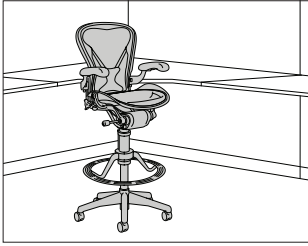

Aeron® Work Stool

Product Information

Description

This work stool has a Fine-Tune™ footring mechanism that allows the user to adjust the height of the footring from a seated position and reduces the pressure on the underside of the user's thighs. It has a 5-star base, pneumatic seat-height adjustment, and 2 height options. The low stool has a seat-height range of 24½" to 29" with a Fine-Tune footring that adjusts 2½" (from 15" to 17½" from the seat). The high stool has a seat-height range of 27½" to 34" with a Fine-Tune footring that adjusts 5½" (from 15" to 20½" from the seat). The high stool provides a wider range of height adjustment than does the low stool. The work stool is available in size B.

The stool has a Pellicle® material that conforms to the user's body and retains its original shape when unoccupied. The material is lightweight and breathable and distributes the user's weight evenly over the seat and back of the stool. The stool's Kinemat® tilt lets the body naturally pivot at the ankles, knees, and hips.

Tilt options include a tilt limiter that allows the user to select the tilt range to limit the amount of recline; a tilt limiter and seat angle that allows the user to select the tilt range and a horizontal or 5° forward seat angle; or a standard tilt.

Back-support options include PostureFit® support and an adjustable lumbar support. The PostureFit support provides a custom fit in the lower back area, below the beltline, that helps achieve healthier posture and improved lower back comfort. The user can adjust the level of support with a lever.

Arm choices include a fixed, nonadjustable option; a height-adjustable option that moves the arms 4" vertically; and a fully adjustable option that moves the arms 4" vertically and pivots the armpads 15° outward and 17½° inward.

The ZB, WS, and G8 options include a frame applique. These appliques are applied to an Aeron work stool's seat, back, and arms to minimize the effect of contact between the stool and a wood-e

Notes

Work stools are tested and warranted for use by persons 300 pounds and under.

For information on casters and glides, see Casters and Glides in Appendices.

Fine-Tune footring's polymer cover matches the frame finish.

PostureFit support is not available on standard tilt option.

Customer's Own Leather (COL) can be applied to armpads; requires 4 square feet. See Order Information in Appendices.

Dimensions

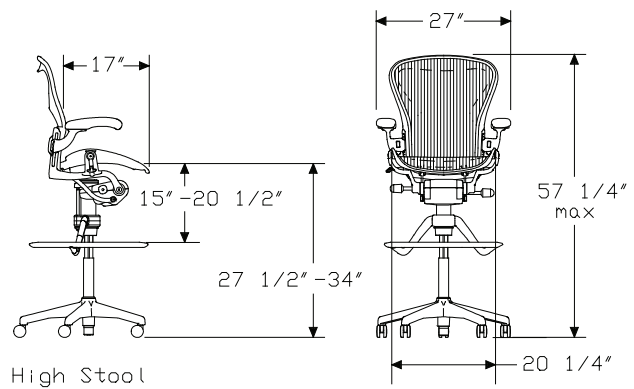
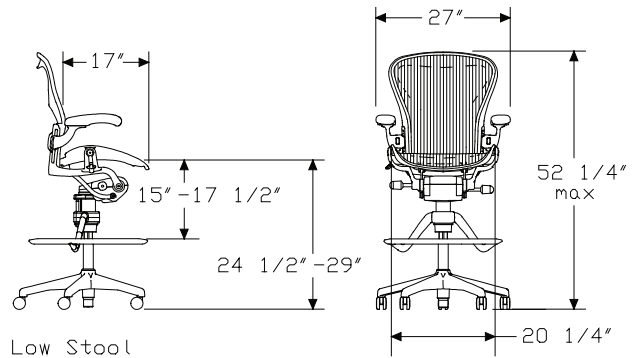

Specification Information						
Step 1.						
AE7						
Step 2. Height						
1	low					
2	high					
Step 3. Tilt						
1	standard tilt					
2	tilt limiter					
3	tilt limiter and seat angle					
Step 4. Arms						
N	no arms					
P	fixed arms					
H	height-adjustable arms					
A	fully adjustable arms					
Step 5. Armpad Upholstery						
<i>For no arms (N)</i>						
NB	no arms					
<i>For fixed arms (P), height-adjustable arms (H), or fully adjustable arms (A)</i>						
WB	nonupholstered armpads					
FB	leather armpads					
Step 6. Base/Frame Finish						
G1	graphite base/frame					
XT	titanium base with smoke frame					
CD	polished aluminum base with graphite frame A					
Step 7. Fire Retardancy						
<i>For not fire retardant (*), skip this step.</i>						
<i>For graphite base/frame (G1) or polished aluminum base with graphite frame (CD)</i>						
FR	fire retardant A					
<i>For titanium base with smoke frame (XT), skip this step.</i>						
Prices for Steps 1-7.						
		G1*	G1FR	XT*	CD*	CDFR
AE711 N NB		\$1450	1450	1450	1836	1836

P WB		\$1587	1587	1587	1971	1971
FB		\$1635	1635	1635	2020	2020
H WB		\$1655	1655	1655	2041	2041
FB		\$1704	1704	1704	2090	2090
A WB		\$1747	1747	1747	2144	2144
FB		\$1797	1797	1797	2195	2195
AE712 N NB		\$1512	1512	1512	1899	1899
P WB		\$1649	1649	1649	2035	2035
FB		\$1698	1698	1698	2084	2084
H WB		\$1717	1717	1717	2103	2103
FB		\$1766	1766	1766	2152	2152
A WB		\$1809	1809	1809	2209	2209
FB		\$1861	1861	1861	2259	2259
AE713 N NB		\$1580	1580	1580	1966	1966
P WB		\$1717	1717	1717	2103	2103
FB		\$1766	1766	1766	2152	2152
H WB		\$1785	1785	1785	2171	2171
FB		\$1834	1834	1834	2220	2220
A WB		\$1883	1883	1883	2280	2280
FB		\$1931	1931	1931	2330	2330
AE721 N NB		\$1537	1537	1537	1922	1922
P WB		\$1672	1672	1672	2059	2059
FB		\$1722	1722	1722	2108	2108
H WB		\$1741	1741	1741	2126	2126
FB		\$1791	1791	1791	2176	2176
A WB		\$1836	1836	1836	2235	2235
FB		\$1888	1888	1888	2286	2286
AE722 N NB		\$1599	1599	1599	1985	1985
P WB		\$1736	1736	1736	2121	2121
FB		\$1785	1785	1785	2171	2171
H WB		\$1803	1803	1803	2189	2189
FB		\$1853	1853	1853	2239	2239
A WB		\$1901	1901	1901	2299	2299
FB		\$1952	1952	1952	2351	2351
AE723 N NB		\$1667	1667	1667	2053	2053
P WB		\$1803	1803	1803	2189	2189
FB		\$1853	1853	1853	2239	2239
H WB		\$1871	1871	1871	2256	2256
FB		\$1921	1921	1921	2307	2307
A WB		\$1969	1969	1969	2367	2367
FB		\$2022	2022	2022	2420	2420

Step 8. Back Support Option

For standard tilt (1)

N2	no additional support	+\$0
AJ	adjustable lumbar support	+\$65

For tilt limiter (2) or tilt limiter and seat angle (3)

N2	no additional support	+\$0
AJ	adjustable lumbar support	+\$65
PJ	adjustable PostureFit® support	+\$95

Step 9. Frame Applique

For graphite base/frame (G1)

NN	none	+\$0
ZB	graphite with graphite applique	+\$134

For titanium base with smoke frame (XT)

NN	none	+\$0
WS	titanium with smoke frame and smoke applique	+\$134

For polished aluminum base with graphite frame (CD)

NN	none	+\$0
G8	polished aluminum with graphite frame and graphite applique A	+\$134

Step 10. Casters/Glides

BB	2½" hard caster, black yoke, carpet only	+\$0
GF	2½" glide, hard floors or carpet	+\$0
C7	2½" caster, black yoke, hard floors or carpet	+\$40
C9	2½" braking caster, black yoke, hard floors or carpet	+\$40

Step 11. Armpad Finish

For nonupholstered armpads (WB) with graphite base/frame (G1), or polished aluminum base with graphite frame (CD)

BK	black	+\$0
-----------	-------	------

For nonupholstered armpads (WB) with titanium base with smoke frame (XT)

S8	smoke	+\$0
-----------	-------	------

Step 12. Pellicle® Material

See application chart and textiles list for material usage and numbers. First 2 digits of number indicate material; remaining 2 digits indicate color.

For not fire retardant ()*

Price Category 1	+\$0
Price Category 2	+\$28

For graphite base/frame (G1) or polished aluminum base with graphite frame (CD) with fire retardant (FR)

Price Category 1	+\$0
------------------	------

Step 13. Armpad Leather

For fixed arms (P), height-adjustable arms (H), or fully adjustable arms (A) with leather armpads (FB)

See application chart and textiles list for fabric usage and numbers. First 2 digits of number indicate fabric line; remaining digit(s) indicate fabric color.

Price Category 7 A	+\$0
Price Category 9	+\$75

Side Chair

AE500

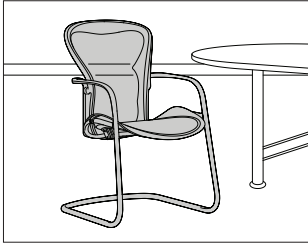

Product Information

Description

This side chair has a Pellicle® material that conforms to the user's body and retains its original shape when unoccupied. The material is lightweight and breathable and distributes the user's weight evenly over the seat and back of the chair. The chair has a sled base and fixed arms. It can be specified with optional lumbar support and with optional sled-base glides. The chair's size is based on the B-size Aeron work chair.

A fire retardant chair meets CAL 133 requirements. The chair's Pellicle material is manufactured with a fire-retardant additive. The additive does not meet Herman Miller's Design for the Environment criteria.

Notes

Side chair is tested and warranted for use by persons 300 pounds and under.

For information on glides, see Casters and Glides in Appendices.

Dimensions

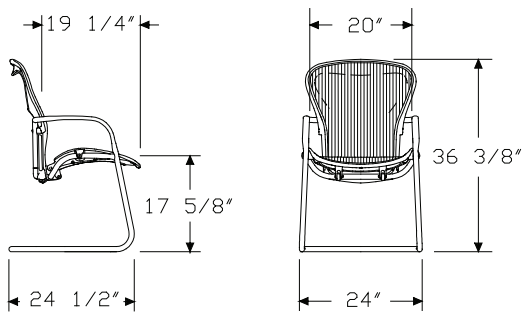

Specification Information

Step 1.

AE500P

Step 2. Fire Retardancy

For not fire retardant (), skip this step.*

FR fire retardant

Prices for Steps 1-2.

AE500P	\$828
AE500P FR	\$828

Step 3. Lumbar Option

N2	no lumbar	+\$0
AJ	adjustable	+\$65

Step 4. Base/Frame Finish

For not fire retardant

G1	graphite	+\$0
XT	titanium with smoke frame	+\$0

For fire retardant (FR)

G1	graphite <input type="checkbox"/>	+\$0
-----------	-----------------------------------	------

Step 5. Glide Option

NX	no glide	+\$0
SB	sled-base glide	+\$15

Step 6. Pellicle® Material

See application chart and textiles list for material usage and numbers. First 2 digits of number indicate material; remaining 2 digits indicate color.

For fire retardant (FR) with no glide (NX), or sled-base glide (SB)

Price Category 1	+\$0
------------------	------

For not fire retardant ()*

Price Category 1	+\$0
Price Category 2	+\$28

Aeron® Side Chair

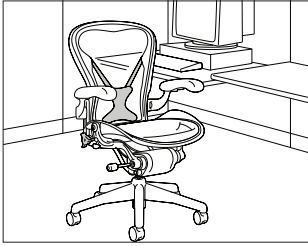

Product Information

Description

This PostureFit® support fits on the back of an A-, B-, or C-size Aeron work chair or B-size Aeron work stool. It provides a custom fit in the lower back area, below the beltline, that helps achieve healthier posture and improved lower back comfort. The user can adjust the level of support with a lever.

Graphite (G1) finish is recommended for use with the following chair or stool base/frame finishes:

- Graphite (G1)
- Graphite with graphite applique (ZB)
- Polished aluminum with graphite frame (CD)
- Polished aluminum with graphite frame and graphite applique (G8)

Smoke (S8) finish is recommended for use with the following chair or stool base/frame finishes:

- Titanium with smoke frame (XT)
- Titanium with smoke frame and smoke applique (WS)

Notes

Existing Aeron chair should include the tilt limiter option (tilt option 2 or 3) for optimal performance.

Specification Information

Step 1.

AE905

Step 2. Size

A	a size
B	b size
C	c size

Prices for Steps 1-2.

AE905 A	\$112
B	\$112
C	\$112

Step 3. Finish

G1	graphite	+ \$0
S8	smoke	+ \$0

Lumbar Kit

AE900

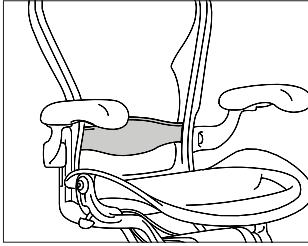

Product Information

Description

This lumbar pad fits into the back of an Aeron work chair or work stool to further support the lower back. The pad can be reversed to adjust for more or less support; one side of the pad is 3/4" and the other is 1 1/4".

Black (BK) lumbar pad finish is recommended for use with the following chair or stool base/frame finishes:

- Graphite (G1)
- Graphite with graphite applique (ZB)
- Polished aluminum with graphite frame (CD)
- Polished aluminum with graphite frame and graphite applique (G8)

Smoke (S8) lumbar pad finish is recommended for use with the following chair or stool base/frame finishes:

- Titanium with smoke frame (XT)
- Titanium with smoke frame and smoke applique (WS)

Notes

Specify lumbar pad size to match work chair size. For work stool, specify size B.

Specification Information

Step 1.

AE900NN

Step 2. Size

- A** a size
- B** b size
- C** c size

Prices for Steps 1-2.

AE900NN A	\$79
B	\$79
C	\$79

Step 3. Finish

BK black	+\$0
S8 smoke	+\$0

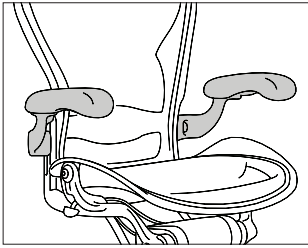

Aeron® Accessories

Product Information

Description
 These arms can be retrofit to an Aeron work chair or work stool. Arm choices include a height-adjustable option that moves the arms 4" vertically and a fully adjustable option that moves the arms 4" vertically and pivots the armpads 15° outward and 17½° inward. Arm components are preassembled.

Notes
 Customer's Own Leather (COL) requires 4 square feet. See Order Information in Appendices.

Dimensions



Fixed Arms



Height Adjustable and Fully Adjustable Arms

Specification Information

Step 1.

AE900

Step 2. Arms

- P** fixed arms
- H** height-adjustable arms
- A** fully adjustable arms

Step 3. Armpad Upholstery

- W0** nonupholstered armpads
- F0** leather armpads

Prices for Steps 1-3.

		W0	F0
AE900	P	\$140	189
	H	\$261	309
	A	\$308	357

Step 4. Finish

- G1** graphite +\$0
- XT** titanium +\$0
- CD** polished aluminum **A** +\$100

Step 5. Armpad Finish

For nonupholstered armpads (W0) with graphite (G1), or polished aluminum (CD)

- BK** black +\$0

For nonupholstered armpads (W0) with titanium (XT)

- S8** smoke +\$0

Step 6. Armpad Leather

For leather armpads (Fo)
 See application chart and textiles list for fabric usage and numbers. First 2 digits of number indicate fabric line; remaining digit(s) indicate fabric color.

- Price Category 7 **A** +\$0
- Price Category 9 +\$75

Frame Applique

AE910

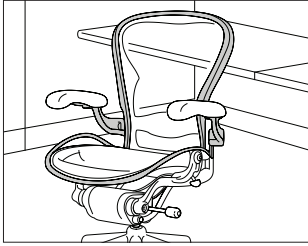

Product Information

Description

This frame applique is applied to an Aeron work chair or work stool's seat, back, and arms to minimize the effect of contact between the chair and a wood-edge surface. The seat and back appliques attach with the chair or stool's existing screws. Coated arm yokes replace existing arm yokes; arm components are preassembled. The arm yokes use the chair or stool's existing arm pads.

Frame applique does not meet CAL 133 requirements.

Notes

Order A-, B- or C-size applique to retrofit work chair; order B-size applique to retrofit work stool.

Specification Information

Step 1.

AE910

Step 2. Arms

- P** fixed arms
- H** height-adjustable arms
- A** fully adjustable arms

Step 3. Size

- A** a size
- B** b size
- C** c size

Prices for Steps 1-3.

		A	B	C
AE910	P	\$306	306	306
	H	\$320	320	320
	A	\$325	325	325



Step 4. Finish

- WS** titanium with smoke frame and smoke applique +\$0
- ZB** graphite with graphite applique +\$0

20-Day or Less/Assigned Lead-Time Order Information

20-Day or Less and Assigned Lead-Time Programs

20-day or less and assigned lead-time products are designed for established Herman Miller dealers with pre-approved credit.

Products are distributed from multiple manufacturing facilities across the United States. All products and options not designated by an Assigned Lead-Time icon  will ship in 20 business days or less after being acknowledged by Herman Miller. Products and options designated by an  are on the assigned lead-time program and will ship in 20 days, less than 20 days, or more than 20 days from order acknowledgement.

Ordering Procedure

Please place orders through Order Manager. If this is not available to you, place orders through mail or fax. Verbal purchase orders will not be accepted.

Order Entry fax number for Passage®, 5000 Series, and Meridian® Filing and Storage: (616) 846 9236.

Order Entry fax number for all other products:
(616) 654 3085.

For more information, contact your Customer Care representative at:
(866) 854 3048 EXT 3400.

Shipments and Delivery

Per Herman Miller Terms and Conditions.

Changes and Cancellation

Per Herman Miller Terms and Conditions.



Casters and Glides

▲	WARNING	▲
Depending on the floor surface, chair may unexpectedly roll away from user when entering or exiting the chair, possibly leading to unexpected injury. Please refer to descriptions of floor types when selecting casters.		

32 Caster

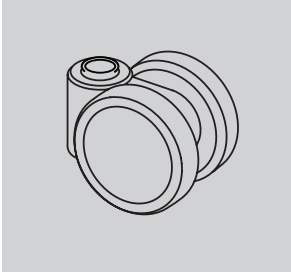

17/8-inch-diameter hard double-wheel caster; black nylon wheels and yoke; for use on carpet only

Applicable on:
SAYL® Chairs

BB Caster

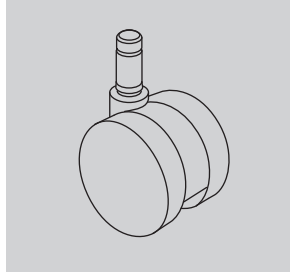

2 1/2-inch-diameter hard double-wheel caster; black nylon wheels and yoke; for use on carpet only

Applicable on:
Aeron® Chairs Setu® Chairs
Ambi® Chairs SAYL Chairs
Caper® Chairs
Celle® Chairs
Embody® Chairs
Equa 2® Chairs
Ergon 3® Chairs
Mirra® Chairs
Mirra 2 Chairs

C7 Caster

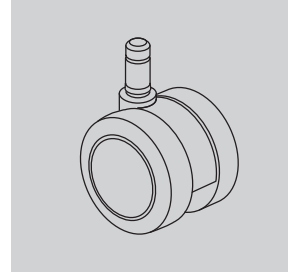

2 1/2-inch-diameter double-wheel caster; black nylon wheels and yoke; soft polyurethane tread; for use on hard floors or carpet

Applicable on:
Aeron Chairs SAYL Chairs
Ambi Chairs
Caper Chairs
Celle Chairs
Embody Chairs
Equa 2 Chairs
Ergon 3 Chairs
Mirra Chairs
Mirra 2 Chairs

CA Caster



2-inch-diameter single-wheel caster; black rubber wheel with black yoke; for use on hard floors or carpet

Applicable on:
Co/Struc® System

49 Caster

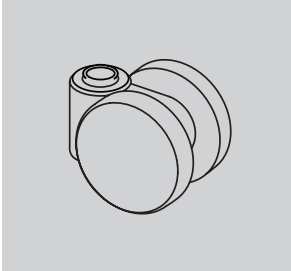

1 7/8-inch-diameter soft double-wheel caster; black nylon wheels and yoke; for use on hard floors or carpet

Applicable on:
SAYL Chairs

BSC Caster

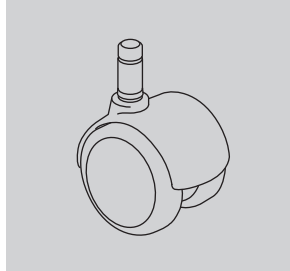

2-inch-diameter double-wheel caster; black nylon wheels and hood; soft polyurethane tread; for use on hard floors or carpet

Applicable on:
Eames® Aluminum Group
Eames Executive Chairs
Eames Soft Pad Group

C9 Caster

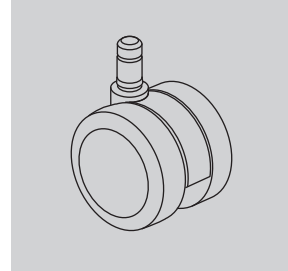

2 1/2-inch-diameter double-wheel caster; black nylon wheels and yoke; soft polyurethane tread; internal brake; for use on hard floors or carpet

Applicable on:
Aeron Chairs Mirra 2 Chairs
Ambi Chairs SAYL Chairs
Caper Chairs
Celle Chairs
Embody Chairs
Equa 2 Chairs
Ergon 3 Chairs
Mirra Chairs

DS Caster

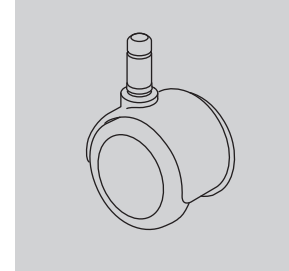

2-inch-diameter soft double-wheel braking caster; black nylon wheels and hood; for use on hard floors only

Applicable on:
Aside® Chairs
Caper Chairs

Casters and Glides

continued

H9 Caster

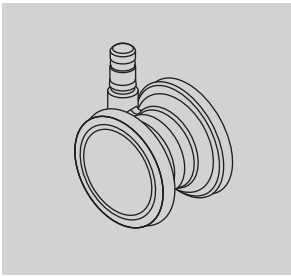

2 1/2-inch-diameter double-wheel caster; clear polycarbonate wheels; nylon yoke; soft polyurethane tread; for use on hard floors or carpet.

Applicable on:
Embody Chairs
Setu Chairs

HW Caster

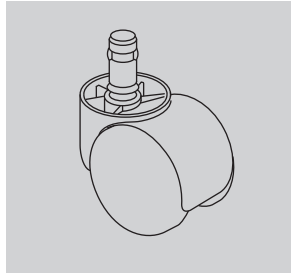

2-inch-diameter double-wheel caster; black nylon wheels and hood; for use on carpet only

Applicable on:
Limerick® Cart

OC Caster

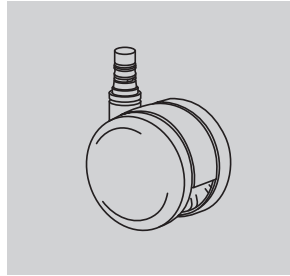

Setu-specific 2 1/2-inch-diameter double-wheel caster; black nylon wheels and yoke; soft polyurethane tread; internal brake; for use on hard floors or carpet

Applicable on:
Setu Chairs

SW Caster

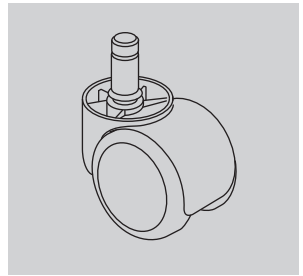

2-inch-diameter soft double-wheel caster; black nylon wheels and hood; for use on hard floors only

Applicable on:
Limerick Cart

HCC Caster

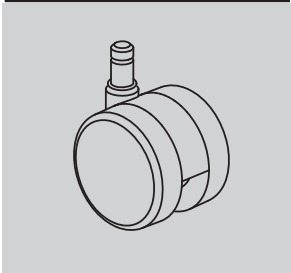

2 1/2-inch-diameter double-wheel caster; black yoke; for use on hard floors or carpet.

Applicable on:
Setu Chairs

MD Caster

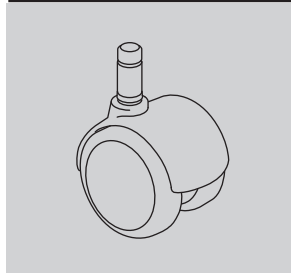

2-inch-diameter double-wheel caster; black nylon wheels with integral chrome hood; soft polyurethane tread; for use on hard floors or carpet

Applicable on:
Eames® Aluminum Group
Eames Executive Chairs
Eames Soft Pad Group

SC8 Caster

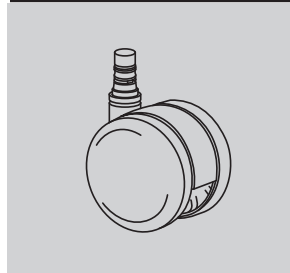

2 1/2-inch-diameter double-wheel caster; black nylon wheels and yoke; soft polyurethane tread; quiet roll technology; for use on hard floors or carpet

Applicable on:
Mirra 2 Chairs

U4 Caster

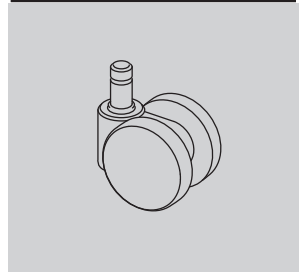

1 7/8-inch-diameter hard double-wheel caster; black nylon wheels and yoke; for use on carpet only

Applicable on:
Aside Chairs
Caper Chairs

Casters and Glides

continued

U5 Caster

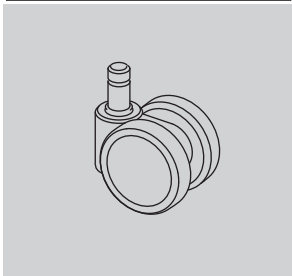

1 7/8-inch-diameter soft double-wheel caster; black nylon wheels and yoke; for use on hard floors or carpet

Applicable on:
Aside Chairs
Caper Chairs

VD Caster

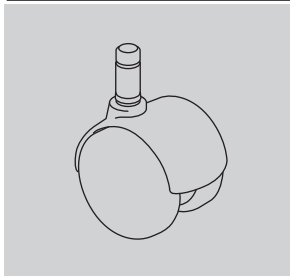

2-inch-diameter hard double-wheel caster; black nylon wheels with integral chrome hood; for use on carpet only

Applicable on:
Eames Aluminum Group
Eames Executive Chairs
Eames Soft Pad Group

69 Glide

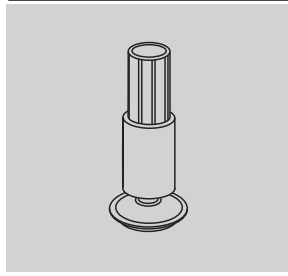

(Front glide shown)
2 1/8-inch-high glide; black glass-filled nylon stem; steel-plated swivel foot with Floor Saver Glide™ insert; for use on hard floors only

Applicable on:
SAYL Chairs

GE Glide

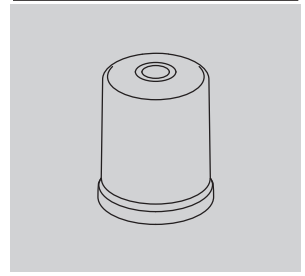

2-inch-high glide; black nylon; for use on hard floors or carpet

Applicable on:
Equa 2 Chairs
Ergon 3 Chairs

UD Caster

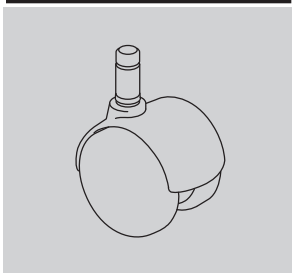

2-inch-diameter hard double-wheel caster; black nylon wheels with painted hood; for use on carpet only

Applicable on:
Eames® Aluminum Group
Eames Executive Chairs
Eames Soft Pad Group

16 Glide

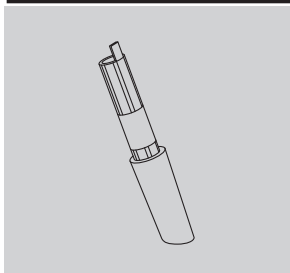

(Front glide shown)
2 1/8-inch-high glide; black or fog acetate; for use on carpet only

Applicable on:
SAYL Chairs

GD Glide

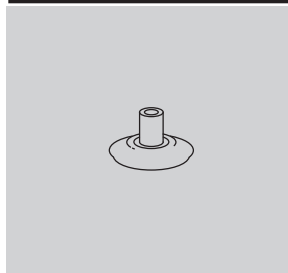

1 1/2-inch-diameter glide; 1/2 inch in height; black nylon; for use on hard floors or carpet

Applicable on:
Eames Aluminum Group
Eames Executive Chairs
Eames Soft Pad Group

GF Glide

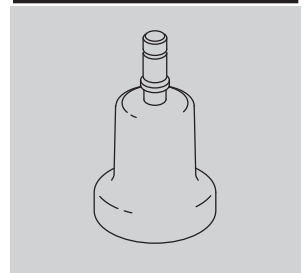

2 1/2-inch-high glide; black nylon; for use on hard floors or carpet

Applicable on:
Aeron Chairs
Celle Chairs
Mirra Chairs
Mirra 2 Chairs
SAYL Chairs

Casters and Glides

continued



GG Glide

1/2-inch-high ganging glide; clear polycarbonate; for use on hard floors or carpet

Applicable on:
Limerick Chairs



SB Glide

1/4-inch-high, 1-inch diameter glide; thermoplastic CAP?material (G1 base has black glides; XT base has clear glides); for use on hard floors or carpet

Applicable on:
Aeron Chairs
Equa 2 Chairs



SG Glide (for Limerick)

1/2-inch-high glide; clear polycarbonate; for use on hard floors or carpet

Applicable on:
Limerick Chairs



Y7 Glide

17/8-inch-high glide; black acetal; for use on carpet only

Applicable on:
Caper Chairs



HG Glide

1/2-inch-high glide; black nylon glide with stainless-steel insert; for use on hard floors or carpet

Applicable on:
Aside Chairs



SG Glide (for Aside)

1/2-inch-high glide; black nylon; for use on carpet only

Applicable on:
Aside Chairs

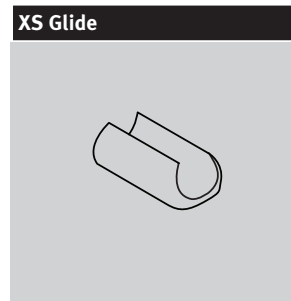

XS Glide

1/8-inch-high glide; polycarbonate in black, fog, clear, and studio white finishes; for use on hard floors or carpet

Applicable on:
SAYL Chairs

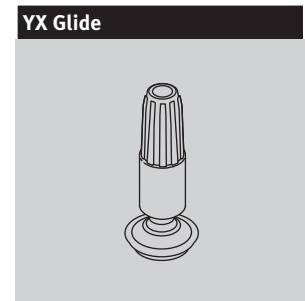

YX Glide

17/8-inch-high glide; black nylon stem; steel-plated swivel foot with Floor Saver Glide™ insert; for use on hard floors only

Applicable on:
Caper Chairs

Size/Fit Reference – Aeron® Chair

This reference helps people select A-, B-, or C-size chairs when the three sizes are not available for actual test sitting. Height and weight are key indicators of suitable chair-size choice. Since the B-size chair is designed to fit a broad range of people, Herman Miller recommends it for users who fall in the A/B or B/C category. This chart applies to Aeron chairs with the extended-height-range pneumatic height-adjustment cylinder.

To determine which chair size is best, find the point of intersection for your height and weight. Aeron A-, B-, and C-size chairs are tested and warranted for use by persons 300 pounds and under.

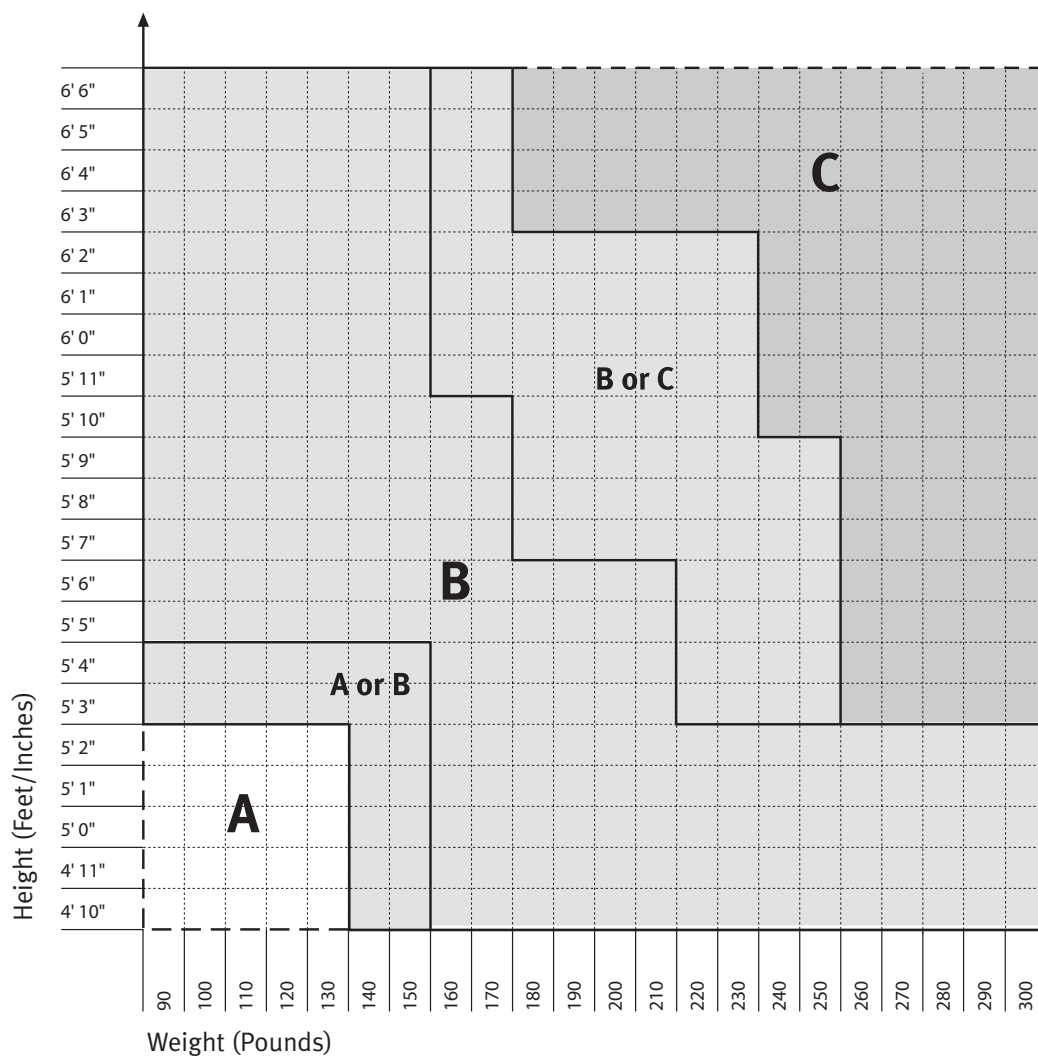



Fire Retardancy – Seating

Fire Retardancy

Fire-retardant chairs are manufactured with special cushions, cushions covered with fire-barrier material, and/or are upholstered in approved fire-retardant fabrics. These chairs meet California TB 133 requirements.

All foam, Proprietary Textiles, and Textile Alliance Program™ (TAP™) textiles on HermanMiller seating products comply with California TB 117-2013.

State of California
Bureau of Home
Furnishings,
Technical Bulletin 133

State of California
Bureau of Home
Furnishings, Technical
Bulletin 117-2013

AireWeave™	FR	•
AireWeave™ 2	FR	•
Balance ¹	FR	•
Bento	FR	•
Bingo		•
Circuit	FR	•
Coil	FR	•
ColorGuard	FR	•
Crepe	FR	•
Crossing	FR	•
Cygnus™	FR	•
Flexnet™	FR	•
Gem	FR	•
Hopsak	FR	•
Latitude™	FR	•
Leather	FR	•
Lyris 2™ ³	FR	•
Mercer		•
Moiré	FR	•
Noble		•
Pellicle® Classic ⁴	FR	•
Pellicle Tuxedo		•
Pellicle Waves		•
Plateau	FR	•
Quilty	FR	•
Railroad	FR	•
Rhythm ²	FR	•
Slideshow	FR	•
Spools		•
Stitches	FR	•
Strata		•
Twist	FR	•

- Fabric meets code requirements.

FR To meet California TB 133 code requirements, fabrics must be applied to approved chairs identified with FR product numbers.

To verify a fabric is approved for a specific chair, see the Fire-Retardant listing on the Seating Textiles Application Chart.

- 1 Balance 3512 carbon and 3513 black only available on Embody® FR chairs.
- 2 Rhythm 3014 black only available on Embody FR chairs.
- 3 Lyris 2 4W11 graphite only available on Setu® FR chairs.
- 4 Pellicle Classic 3D01 graphite only available on Aeron® FR chairs.



Customer's Own Material/Customer's Own Leather Order Information — Seating

Packaging

Packaging varies according to individual product. A surcharge may be added for special packaging requests. Contact Customer Care for specific information.

Customer's Own Material/Customer's Own Leather

Program Overview

The Customer's Own Material (COM) and Customer's Own Leather (COL) program gives you the option of using textiles other than those listed. Herman Miller will test textiles for application to Herman Miller products and will process orders for those with approved COM/COL textiles only. COM/COL are assigned lead-time textiles.

Kiosk lists an overview of fabrics and leathers that have been tested and indicates whether or not they were approved for application to Herman Miller products.

Specific information on the terms and conditions, testing, approval, and ordering process for COM/COL is listed below. Questions about the COM/COL program and requests for assistance may be directed to your COM representative at:

(616) 654 3400

(866) 854 3048 EXT 3400

Customer's Own Material/Customer's Own Leather Warranty

Herman Miller does not warrant COM/COL textiles. COM/COL textiles are tested for application only; they are not tested for performance. The Herman Miller warranty does apply to the underlying products.

Suppliers of COM/COL textiles are responsible for color consistency within commercial tolerances, UV stability, and resistance to soiling and perspiration.

Customer's Own Material/Customer's Own Leather Pricing

COM is a Category 1 fabric. There are no application charges for COM fabrics. COL is a Category 7 textile; refer to prices on specific products to determine the application charge.

Ordering and payment for COM/COL textile yardage are the responsibility of the customer and the textile supplier.

If desired, Herman Miller will purchase COM textiles directly from True Textiles, C.F. Stinson, Luna Textiles, Maharam, and Momentum Textiles to simplify ordering and shipment. For this service, refer to the Supplier Connection program.

Textile Approval

1. Select a COM/COL textile and a Herman Miller product.
2. If your textile is not listed in Kiosk, obtain a test number from a COM representative at (616) 654 3400. You can also submit your request within Kiosk. Please have the following information ready before calling: textile name, number, pattern, roll width, and the product you will apply it to.

Additional yardage may be needed due to the unique characteristics of a textile. All package labels must include the words "COM test" or "COL test" and the assigned COM/COL test number.

3. Herman Miller will notify you of approval or disapproval within 4 days from receipt of the test yardage.

Ordering Products with COM/COL

1. Refer to the specific products to determine the yardage required for COM/COL textiles.
2. If your textile is not listed in Kiosk, call a COM representative at (616) 654 3400 or (866) 854 3048 EXT 3400. The representative will assign an identification number for your textile (ID#) and will verify yardage requirements for your order. Additional yardage may be needed due to the unique characteristics of a textile.
3. Enter your order on Order Manager in Kiosk.
4. Upon receipt of your purchase order, Herman Miller will send you a PO acknowledgment.
5. Arrangements must be made for the textiles to be shipped from the supplier to Herman Miller for application to the seating products. Textiles must be tagged with the assigned identification number and the roll yardage quantity. See Kiosk for shipping procedures and current shipping addresses or contact a COM representative at (616) 654 3400 or (866) 854 3048 EXT 3400.

Products will be scheduled for production when COM/COL textiles are received at Herman Miller. Standard lead times in effect at that time will apply.

Note: If textiles are to be purchased directly by Herman Miller through the Supplier Connection program, Herman Miller will handle the ordering and shipping process and will schedule your order for production upon receipt of your purchase order (dependent on textile availability). Refer to the Supplier Connection program for more information.

Customer's Own Material/Customer's Own Leather Order Information — Seating

continued

Supplier Connection

Program Overview

The Supplier Connection program is a service offered by Herman Miller to purchase approved COM textiles directly from True Textiles, C.F. Stinson, Luna Textiles, Maharam, and Momentum Textiles. When you select a textile through this program, Herman Miller will facilitate the ordering, scheduling, and shipment of the textile directly with the supplier.

Suppliers included in the Supplier Connection program keep an active inventory of textiles that are pre-approved for application to Herman Miller products. Pre-approval applies only to the suitability of a textile for manufacturing and application to a Herman Miller product. Kiosk provides an overview of fabrics that have been tested and indicates whether or not they were approved for application to Herman Miller products.

Specific information on the terms and conditions, testing, approval, and ordering process for the Supplier Connection program is listed below. Questions and requests for assistance may be directed to your COM representative at:

(616) 654 3400

(866) 854 3048 EXT 3400

Supplier Connection Warranty

Textiles purchased by Herman Miller through the Supplier Connection program are COM and are not warranted by Herman Miller. COM textiles are tested for application only; they are not tested for performance. The Herman Miller warranty does apply to the underlying products.

Suppliers of COM textiles are responsible for color consistency within commercial tolerances, UV stability, and resistance to soiling and perspiration.

Supplier Connection Pricing

Textiles purchased by Herman Miller through the Supplier Connection program are COM. COM is a Category 1 fabric. There are no application charges for COM fabrics.

Payment for textiles purchased by Herman Miller through the Supplier Connection program is the responsibility of the customer or dealer. Herman Miller will invoice the order at the supplier's prices published at the time of the order.

Textile Approval

1. Refer to Kiosk to identify the approval status of the textile. If your textile is not listed, contact the COM Department to request testing for application to Herman Miller products.
2. Herman Miller will notify you of approval or disapproval in approximately 4 days from receipt of the test yardage. If the textile is approved, it will be assigned a COM identification number.

Ordering Products with Supplier Connection COM

1. Identify and include the following information on your purchase order:
 - Product number and option
 - Herman Miller's COM identification number
2. Enter your order on Order Manager in Kiosk.
3. Upon receipt of the purchase order, Herman Miller will process your order and send you a PO acknowledgment. Herman Miller will determine the yardage required to produce your product and will order and schedule for delivery the required textile. Standard lead times in effect at the time the textile is allocated at the supplier will apply to products ordered through this program.

Open Line Textiles Application Chart – Seating

• Available

A Assigned lead-time textile.

See following page for exception notes.

	Aeron® Work Chairs/Stools	Aeron Arm pads/Arm Kit	Mirra® Chairs	Celle® Chairs	Embody™ Chairs	SAYL® Work Chairs	SAYL Side Chairs	Ergon 3® Chairs	Ergon 3 Adjustable Arm Kit	Equa 2® Fully Upholstered Chairs/Stools	Equa 2 Split-Pad Upholstered Chairs/Stools	Equa 2 Adjustable Arm Kit	Aside® Chairs	Caper® Chairs	Celeste™ Seating	Swoop™ Lounge Seating - Plywood	Eames® Aluminum Group Chairs/Ottomans	Eames Soft Pad Group Chairs/Ottomans	Eames Executive Chairs	Eames Lounge Chairs/Ottomans	Eames Chaise	Eames Sofa Compact	Eames Sofa, 2 and 3 Seat	Eames Tandem Sling Seating	Eames Wire Chair	Goetz™ Sofa	Nelson™ Marshmallow Sofa	Nelson Platform Bench Cushion	Cushion Tops	Systems
Price Category 1-8																														
No fabrics available at this time.																														
Price Category 9																														
VZ__ Leather - Wollsdorf Leather		•		14		•	•			•	•	8			4	•	•	•	•	•			•		•	•	•	•	•	

4 See specific products for information on specifying leather in combination with fabric.
 8 Only available on nonupholstered outer back option (PB).
 14 Only available on Celle UC Chairs.



Open Line Textile Colors – Seating

Price Category 1 - 8

No fabrics available at this time.

Price Category 9

Leather - Open Line	
Wollsdorf Leather	
	approx. 50 sq. ft. per hide
	100% leather
VZ10	Magnolia
VZ11	Bone
VZ12	Eggshell
VZ13	Honeydew
VZ14	Parchment
VZ15	Caramel
VZ16	Camel
VZ17	Tan
VZ18	Saddle
VZ19	Orange
VZ20	Persimmon
VZ21	Russet
VZ22	Cherry
VZ23	Chateau
VZ24	Avocado
VZ25	Clover
VZ26	Sage
VZ27	Teak
VZ28	Lagoon
VZ29	Spirit
VZ30	Grape
VZ31	Indigo
VZ32	Fawn
VZ33	Safari
VZ34	Deep Earth
VZ35	Chocolate
VZ36	Cocoa

*For samples,
contact the supplier of
Open Line Leather:*

*Wollsdorf Leather
345 South Road
High Point, NC 27262
(336) 884-5005
sales@wollsdorfleather.com*



Proprietary Textiles Application Chart – Seating

• Available

[A] Assigned lead-time textile.

See following page for exception notes.

	Aeron® Work Chairs/Stools	Aeron Arm pads/Arm Kit	Mirra® Chairs	Mirra® 2 Chairs	Celle® Chairs	Embody® Chairs	SAYL® Work Chairs	SAYL Side Chairs	Setu® Chairs	Ergon 3® Chairs	Ergon 3/Equa 2® Adjustable Arm Kit	Equa 2 Fully Upholstered Chairs/Stools	Equa 2 Split-Pad Upholstered Chairs/Stools	Aside® Chairs	Cape® Chairs	Celeste™ Seating	Locale™ Cushion	Public Office Landscape™ Back	Public Office Landscape Seat	Swoop™ Lounge Seating - Fully Upholstered	Swoop Lounge Seating - Plywood	Eames Tandem Sling Seating	Cushion Tops	Systems	
Price Category 1																									
COM	Customer's Own Material [A]				14		1	1		1		1	1	1		1					1	1	1	1	1
3Q__	AireWeave™ (7Q__)		•																						
1A7__	AireWeave™ 2			•																					
3P__	ColorGuard				15		•	22	•	2			3	8		•					•	•	6	•	•
8T__	Crossing				•				•	•		•	•	•							•	•		•	•
6V__	Flexnet™														•						•	•		•	•
95__	Gem				14				•	•		•	•	•		•					•	•		•	•
4W__	Lyris 2™								•																
3D__	Pellicle® Classic (3V__)	•																							
2Z__	Slideshow				14		21	22		•		•	•	•		•								•	•
Price Category 2																									
92__	Crepe				•	•	•	•	•	•		•	•	•		•					•	•		•	•
1LM__	Loom				14	•	•	•	•	•		•	•	•							•	•		•	•
1HA__	Medley				14	•	•	22	•	•		•	•	•		•			•	•	•	•		•	•
3A__	Moiré				14	•	•	•	•	•		•	•	•		•					•	•		•	•
4M__	Pellicle Tuxedo (4Q__)	•																							
4E__	Pellicle Waves (4F__)	•																							
8V__	Railroad				•	•	•	•	•	•		•	•	•		•					•	•		•	•
30__	Rhythm				•	23	•	•	•	•		•	•	•							•	•		•	•
8R__	Twist				•	•	•	•	•	•		•	•	•		•					•	•		•	•
Price Category 3																									
70__	Bento					•	•	•	•	2		•	•	8							20			•	•
1FA__	Circuit				14	•	•	•	•	•		•	•	•		•					•	•		•	•
8S__	Coil				•	•	•	•	•	•		•	•	•		•					•	•		•	•
8M__	Latitude™			23	23	•	•	•					3								•	•		•	•
8U__	Stitches				•	•	•	•	•	•		•	•	•		•					•	•		•	•
Price Category 4																									
7Y__	Bingo					•	•	•	•	2			3	8		•									•
213__	Mercer				14	•	22							•	•										•
1A9__	Network																		•						
6J__	Plateau									•		•	•	•											•
6S__	Quilty				14	•	•							•							•			•	•
8Y__	Spools				14	21	•	•	•	•		•	•	•							•			•	•
22P__	Strata					21	22	•	•	•						•					•	•		•	•
Price Category 5																									
14A__	Hopsak				14	•	22	•	•	•		•	•	•		•					•	•		•	•
22N__	Noble (22H__)				14	21	22	•	•	•		•	3	8		•	•			•	•		•	•	•
Price Category 6																									
35__	Balance					•																			
Price Category 7																									
COL	Customer's Own Leather [A]		1		14	•	•			1	1	1	1	8											1
Price Category 8																									
No fabrics available at this time																									
Price Category 9																									
21__	Leather		•		14	•	•				•	•	•	8		4					•			•	

continued on next page

Proprietary Textiles Application Chart – Seating

continued

• Available

[A] Assigned lead-time textile.

See below for exception notes.

Appendix: Proprietary Textiles Application Chart – Seating

Fire-Retardant Chairs/Fabrics

Price Category 1

COM Customer's Own Material [A]

3Q__ AireWeave™ (7Q__)

3P__ ColorGuard

8T__ Crossing

6V__ Flexnet™

95__ Gem

4W__ Lyris 2™

3D__ Pellicle® Classic

2Z__ Slideshow

Price Category 2

92__ Crepe

3A__ Moiré

8V__ Railroad

30__ Rhythm

8R__ Twist

Price Category 3

70__ Bento

1FA__ Circuit

8S__ Coil

8M__ Latitude™

8U__ Stitches

Price Category 4

6J__ Plateau

6S__ Quilty

Price Category 5

14A__ Hopsak

Price Category 6

35__ Balance

Price Category 9

21__ Leather

	Aeron® Work Chairs/Stools	Mirra® Chairs	Celle® Chairs	Embody® Chairs	SAYL® Work Chairs	SAYL Side Chairs	Setu® Chairs	Ergon 3® Chairs	Equa 2® Fully Upholstered Chairs/Stools	Equa 2 Split-Pad Upholstered Chairs/Stools	Aside® Chairs	Caper® Chairs	Celeste™ Seating	Swoop™ Lounge Seating - Fully Upholstered	Eames® Tandem Sling Seating
COM Customer's Own Material [A]								1	1	1	1		1		
3Q__ AireWeave™ (7Q__)		•													
3P__ ColorGuard			15		22		2		3				•	•	6
8T__ Crossing			14				•	•	•	•			•	•	
6V__ Flexnet™												•			
95__ Gem			14				•	•	•	•			•	•	
4W__ Lyris 2™						18									
3D__ Pellicle® Classic	7														
2Z__ Slideshow			14	21			•	•	•	•			•		
Price Category 2															
92__ Crepe			14	•	•			•	•	•			•	•	
3A__ Moiré			14	•	•			•	•	•			•	•	
8V__ Railroad			14	•				•	•	•			•	•	
30__ Rhythm			14	16	•	•								•	
8R__ Twist			14	•	•			•		•	•		•	•	
Price Category 3															
70__ Bento				•	•									•	
1FA__ Circuit			14					•	•	•	•		•	•	
8S__ Coil			14	•	•			•	•	•	•		•	•	
8M__ Latitude™			•	•	•										
8U__ Stitches			14	•	•			•	•	•	•		•	•	
Price Category 4															
6J__ Plateau											•				
6S__ Quilty			14	•										•	
Price Category 5															
14A__ Hopsak			14						•	•	•			•	
Price Category 6															
35__ Balance				17											
Price Category 9															
21__ Leather			14												

All foam and Proprietary Textiles on HermanMiller seating comply with California TB 117-2013.

- 1 Refer to price book appendices and Kiosk for COM/COL information.
- 2 Available on all Ergon 3 chairs except for fabric back (FB) option.
- 3 Available on A-and B-size Equa 2 split-pad upholstered chairs.
- 4 See specific products for information on specifying leather in combination with fabric.
- 6 Only available in 3P02 Navy, 3P03 Spruce, 3P14 Black, 3P17 Burgundy, 3P19 Slate, and 3PC7 Bucksuede.
- 7 Only available in 3D01 Graphite.
- 8 Only available on nonupholstered outer back option (PB).
- 14 Available on Celle UC (upholstered seat) and HC (upholstered seat with protective edge) Chairs.

- 15 Available only on Celle HC (upholstered seat with protective edge) Chairs.
- 16 Only available in 3014 Black.
- 17 Only available in 3512 Carbon and 3513 Black.
- 18 Only available in 4W26 Slate Grey, 4W30 Java, and 4W31 Graphite.
- 20 Not available in Bento 7001 Frost, 7002 Linen, and 7003 Khaki on Swoop Plywood Lounge and Ottoman.
- 21 Not available on SAYL upholstered back work chairs.
- 22 Not available on SAYL side chairs with upholstered backs.
- 23 Available in select colors. Refer to "Proprietary Textile Colors-Seating" for color offering.

Proprietary Textile Colors – Seating

Price Category 1

Customer's Own Material
See Order Information in Appendices. Assigned lead-time textile. A

AireWeave™
For Mirra® chairs with a graphite or shadow base/frame.
67% elastomeric
33% antimony-free polyester

3Q11 Graphite
3Q12 Shadow
3Q13 Citron
3Q15 Blue Fog
3Q16 Cappuccino
3Q20 Alpine

AireWeave
For Mirra chairs with a graphite base/frame.
67% elastomeric
33% antimony-free polyester

7Q01 Graphite Dark
7Q05 Blue Fog Dark
7Q06 Cappuccino Dark

AireWeave 2
For Mirra 2 chairs
67% elastomeric
33% antimony-free polyester

1A701 Alpine
1A702 Slate Grey
1A703 Graphite
1A704 Lime Green
1A705 Cappuccino
1A706 Urban Orange
1A707 Dark Turquoise
1A708 Twilight

ColorGuard
54" wide
100% vinyl

3P01 Grey
* 3P02 Navy
* 3P03 Spruce A
3P04 Jade A
3P05 Natural A
3P08 Blueberry A
3P09 Coal A
3P12 Black Plum A
* 3P14 Black
3P15 New Burgundy A
* 3P17 Burgundy A
* 3P19 Slate
3P31 Horizon Blue A
3P33 Pumice
3P54 Candy Apple A
3P58 Beige A
3P66 Deep Clay A
3P72 Allspice A
3P90 Green Tea A
3P93 Camelback A
3P96 Manzanita A
3P97 Fudge A
3PB2 Sea Grass A
3PB5 Vizcaya Palm A
3PB9 Neptune A
* 3PC7 Bucksuede A
3PD4 Otter A

* Colors available on Eames® Tandem Sling Seating.

A Assigned lead-time color.

Crossing
54" wide
86% antimony-free polyester
14% polyester

8T03 Wicker
8T04 Porcelain
8T05 Warm Grey
8T06 Sepia
8T07 Pumpkin
8T08 Copper
8T09 Cranberry
8T10 Tomato
8T11 Mulberry
8T12 Plum
8T13 Green Apple
8T14 Loden
8T15 Spruce
8T16 Periwinkle
8T17 Cerulean
8T18 Indigo
8T19 Shale
8T20 Brownstone
8T21 Bark
8T22 Tin
8T23 Graphite
8T24 Black

Flexnet™
69% elastomeric
31% polyester

6V01 Black
6V02 Silver Grey

Gem
54" wide
100% antimony-free polyester

9501 Sesame
9502 Tangerine
9503 Red
9504 Red Violet
9505 Mulberry
9506 Java
9507 Twilight
9508 Bayou
9509 Iris
9510 Berry Blue
9511 Aqua Green
9512 Green Apple
9513 Spruce
9514 Black
9515 Slate Grey
9516 Fog

Lyris 2™
74% elastomeric
26% polyester

4W21 Alpine
4W22 Mango
4W23 Chartreuse
4W25 Berry Blue
4W26 Slate Grey
4W28 Chino
4W29 Rattan
4W30 Java
4W31 Graphite

Proprietary Textile Colors – Seating

continued

Price Category 1

continued

Pellicle® Classic
For Aeron® chairs with a graphite or polished aluminum base.
70% elastomeric
30% polyester
3D01 Carbon
3D02 Lead

Pellicle Classic
For Aeron chairs with a titanium base.
70% elastomeric
30% polyester
3V01 Zinc
3V03 Quartz

Slideshow
54" wide
54% recycled polyester
46% polyester
2Z01 Cinema
2Z02 Snapshot
2Z03 Shutter
2Z04 Scenic
2Z05 Portrait
2Z06 Still Life
2Z07 Blueprint
2Z08 Halftone
2Z09 Exposure
2Z10 Zoom

Price Category 2

Crepe
54" wide
100% recycled polyester
9201 Licorice
9203 Smoke
9207 Cherry
9209 Claret
9212 Raisin
9218 Aquamarine
9223 Cadet
9241 Beachglass
9243 Midnight
9244 Artichoke
9248 Warm White
9249 Stone
9250 Earth
9251 Fog
9252 Slate Grey
9253 Yellow Dark
9254 Coral
9255 Blush Grey
9256 Wild Berry
9257 Clover
9258 Caribbean
9259 Cerulean

Loom
54" wide
100% polyester
1LM01 Linen
1LM02 Brown Sugar and Spice
1LM03 Brick and Mortar
1LM04 Salt and Pepper
1LM05 Black
1LM06 Lemongrass
1LM07 Poppy
1LM08 Wild Berry
1LM09 Loden
1LM10 Jade
1LM11 Deep Sea

Medley
54" wide
100% polyester
1HA01 Stone
1HA02 Trail
1HA03 Charcoal
1HA04 Cinder
1HA05 Citrus
1HA06 Papaya
1HA07 Chutney
1HA08 Tundra
1HA09 Feather Grey
1HA10 Chartreuse
1HA11 Loden
1HA12 Peacock
1HA13 Bayou
1HA14 Blue Grotto
1HA15 Blueberry

Moiré
54" wide
100% recycled polyester
3A01 Concrete
3A02 Biscotti
3A03 Rattan
3A04 Chambray
3A05 Fern
3A08 Violet
3A09 Zin
3A10 Curry
3A11 Spice
3A12 Cork

Pellicle® Tuxedo
For Aeron chairs with a graphite or polished aluminum base.
64% elastomeric
36% polyester
4M01 Grey Black
4M02 Blue Black

Pellicle Tuxedo
For Aeron chairs with a titanium base.
64% elastomeric
36% polyester
4Q01 White Gold

Pellicle Waves
For Aeron® chairs with a graphite or polished aluminum base.
68% elastomeric
32% polyester
4E01 Carbon
4E03 Platinum

Pellicle Waves
For Aeron chairs with a titanium base.
68% elastomeric
32% polyester
4F01 Zinc
4F03 Quartz

Railroad
54" wide
100% recycled polyester
8V01 Straw
8V02 Squash
8V03 Cayenne
8V04 Nutmeg
8V05 Root
8V06 Wicker
8V07 Moss
8V08 Aquamarine
8V09 Slate

Proprietary Textile Colors – Seating

continued

Price Category 2

continued

Rhythm

54" wide
100% polyester
* 3001 Kiwi Green
3002 Green Apple
3003 Peacock
* 3004 Bayou
3005 Berry Blue
3006 Iris
3007 Twilight
* 3008 Pumpkin
* 3009 Poppy
3010 Molasses
3011 Mulberry
* 3012 Khaki
3013 Mink
3014 Black
3015 Charcoal

* Colors not available on Embody Chair.

Twist

54" wide
80% antimony-free polyester
13% recycled polyester
7% polyester
8R04 Chamois
8R05 Wicker
8R06 Nutmeg
8R07 Squash
8R08 Copper
8R09 Cayenne
8R10 Poppy
8R11 Magenta
8R12 Garnet
8R13 Iceberg
8R14 Tin
8R15 Shale
8R16 Graphite
8R17 Birch
8R18 Sepia
8R19 Coffee Bean
8R20 Bayou
8R21 Periwinkle
8R22 Blueberry
8R23 Green Apple
8R24 Loden
8R25 Turquoise

Price Category 3

Bento

54" wide
100% antimony-free polyester
7001 Frost
7002 Linen
7003 Khaki
7004 Truffle
7005 Grey Black
7006 Pumpkin
7007 Cranberry
7008 Everglade
7009 Cobalt

Circuit

54" wide
100% recycled polyester
1FA1 Sunflower
1FA2 Mango
1FA3 Red
1FA4 Magenta
1FA5 Cocoa
1FA6 Berry Blue
1FA7 Peacock
1FA8 Green Apple
1FA9 Graphite
1FAA Black

Coil

54" wide
100% recycled polyester
8S01 Nougat
8S02 Squash
8S03 Copper
8S04 Molasses
8S05 Chutney
8S06 Claret
8S07 Plum
8S08 Olive Wood
8S09 Root
8S10 Pesto
8S11 Hemlock
8S12 Java
8S13 Bayou
8S14 Peacock
8S15 Twilight
8S16 Ink
8S17 Black

Latitude™

61" wide
100% polyester
8M01 Graphite
8M02 Shadow
8M03 Citron
8M04 Felt Green
8M05 Blue Fog
8M06 Cappuccino
8M07 Terra Cotta
8M10 Alpine
8M12 French Blue
8M13 Midnight Blue
8M14 True Red
8M15 Champagne
8M16 Chestnut
8M17 Black
8M18 Brownstone
8M19 Green Leaf
8M20 Cabernet
8M21 Slate Grey
8M22 Lime Green
8M23 French Press
8M24 Urban Orange
8M25 Dark Turquoise
8M26 Twilight

Latitude

Colors for Mirra® Chairs
100% polyester
8M01 Graphite
8M02 Shadow
8M03 Citron
8M05 Blue Fog
8M06 Cappuccino
8M10 Alpine
8M13 Midnight Blue
8M15 Champagne
8M16 Chestnut
8M17 Black
8M18 Brownstone

Latitude

Colors for Mirra 2 Chairs
100% polyester
8M10 Alpine
8M17 Black
8M21 Slate Grey
8M22 Lime Green
8M23 French Press
8M24 Urban Orange
8M25 Dark Turquoise
8M26 Twilight

Stitches

54" wide
54% polyester
46% recycled polyester
8U02 Rye
8U03 Khaki
8U04 Honey
8U05 Cattail
8U06 Pumpkin
8U07 Brick
8U08 Cool Grey
8U09 Slate Blue
8U10 Juniper
8U11 Evening Blue
8U12 Charcoal
8U13 Kiwi Green
8U14 Olive
8U15 Pesto
8U16 Cocoa
8U17 Seed

Proprietary Textile Colors – Seating

continued

Price Category 4

Bingo

54" wide
100% PVC-free polyurethane
Resilience® finish
7Y01 Oyster
7Y02 Natural
7Y03 Cashew
7Y04 Buff
7Y05 Rattan
7Y06 Root
7Y07 Woodland
7Y08 Camel
7Y09 Copper
7Y10 Allspice
7Y11 Canyon
7Y12 Henna
7Y13 Sedona
7Y14 Black Plum
7Y15 Currant
7Y16 Mahogany
7Y17 Seed
7Y18 Mushroom
7Y19 Blue Grey
7Y20 Navy
7Y21 Black
7Y22 Mint
7Y23 Seaport
7Y24 Evening Blue
7Y25 Hemlock
7Y26 Kiwi Green
7Y27 Celadon
7Y28 Moss
7Y29 Pesto

Mercer

54" wide
50% solution dyed recycled nylon
50% solution dyed nylon
BLOCKaide
21301 Stone
21302 Rattan
21303 Cayenne
21304 Chutney
21305 Pesto
21306 Teal Blue
21307 Ultramarine
21308 Acai Berry

Mercer continued

21309 Ash Brown
21310 Charcoal

Network

knit to size
100% polyester
1A901 Warm White
1A903 Red
1A906 Twilight
1A907 Graphite

Plateau Perspectives® Collection

knit to size
100% polyester
6J01 Feather Grey
6J02 Trail
6J03 Mustard Seed
6J04 Fennel
6J05 Red Pepper
6J06 Twig
6J07 Waterfall
6J08 Sagebrush
6J09 Winter Berry
6J10 Thunder
6J11 Blueberry
6J12 Rosemary
6J13 Wild Plum
6J14 Black

Quilty

56" wide
100% antimony-free polyester
GreenShield
6S01 Wicker
6S02 Honey
6S03 Khaki
6S04 Straw
6S05 Squash
6S06 Cayenne
6S07 Brick
6S08 Cerulean
6S09 Blue Violet
6S10 Mink
6S11 Green Apple
6S12 Jade
6S13 Indigo

Price Category 5

Hopsak

56" wide
100% recycled polyester
14A20 Black
14A22 Raw Umber Dark
14A26 Grey Blue Dark
14A30 Sepia Dark
14A38 Emerald Dark
14A39 Yellow Dark
14A40 Orange
14A41 Sienna
14A42 Olive Green Dark
14A43 Crimson
14A44 Crimson Dark Dark
14A45 Violet Dark
14A46 Pink Dark Dark
14A47 Ultramarine Dark
14A48 Cobalt Blue
14A49 Terra Cotta
14A50 Ochre Dark

Noble

Assigned lead-time textile. ^A
54" wide
100% wool
22N01 Bucksuede
22N02 Chipotle
22N03 Magenta
22N04 Cherry
22N05 Bordeaux
22N06 Boysenberry
22N07 Cadet
22N08 Berry Blue
22N09 Peacock
22N10 Kiwi Green
22N11 Pesto
22N12 Blue Grey Mix
22N13 Tan Mix
22H14 Heathered Brown
22H15 Heathered Black
22H16 Heathered Grey
22H17 Heathered Twilight

Spools

54" wide
51% recycled polyester
49% polyester
Crypton® Green
8Y01 Cashew
8Y02 Wicker
8Y03 Trail
8Y04 Cappuccino
8Y05 Copper
8Y06 Paprika
8Y07 Sedona
8Y08 Bluegrass
8Y09 Lagoon
8Y10 Grape
8Y11 Beachglass
8Y12 Marsh
8Y13 Bud

Strata

54" wide
50% solution dyed recycled nylon
50% solution dyed nylon
BLOCKaide
22P01 Rattan
22P02 Yellow Jacket
22P03 Avocado
22P04 Pesto
22P05 Peacock
22P06 Blue Jay
22P07 Blueberry
22P08 Boysenberry
22P09 Mango
22P10 Paprika
22P11 Mulberry
22P12 Wheat
22P13 Brownstone
22P14 Bayou
22P15 Trail

Proprietary Textile Colors – Seating

continued

Price Category 6

Balance

100% polyester

3506 Green Apple

3507 Blue Moon

3509 Berry Blue

3510 Iris

3512 Carbon

3513 Black

Price Category 7

Customer's Own Leather

See Order Information in Appendices. Assigned lead-time textile. [A](#)

Price Category 8

No fabrics available at this time.

Price Category 9

Leather

approx. 50 sq. ft. per hide

100% leather

2101 Ivory

2102 Wheat

2103 Honey

2104 Copper

2105 Canyon

2106 Olive

2107 Tobacco

2108 Mink

2109 Black

2110 Smoke

2111 Graphite

For more information about our products and services or to see a list of dealers, please visit us at HermanMiller.com or call (800) 851 1196.

This book is recyclable. Printed in U.S.A. on recycled paper.

© 2015 Herman Miller, Inc., Zeeland, Michigan

® **HermanMiller**, ●, 3D Intelligent, Abak, AO, Action Office, Aeron, Ambi, ArcSpan, Ardea, Aside, Avall, Avive, Canvas Office Landscape, Caper, Celle, Co/Struc, Daisyone, Eames, Embody, Envelop, Equa 2, Ergon 3, Ethospace, Fine-Tune, FlexFront, Flo, Ground Cloth, Herman Miller Healthcare, Intersect, Kinemat, Lapjack, Leaf, Lifework, Limerick, Live Unframed, Maharam, Meridian, Mirra, Passage, Pellicle, Perspectives, PostureFit, Prospects, Resolve, Rodney, SAYL, Setu, Thrive, Tu, Vary Easy, Wishbone, Y-Tower, and Z-Axis are among the registered trademarks of Herman Miller, Inc., and its owned subsidiaries.

™ About Face, AireWeave, Albert, Backfit, Bubbletack, Burdick Group, Butterfly Back, Celeste, Cellular Suspension, Clam, Compass, Connect, DOT, Duracare, Durawrap, Eco-Dematerialized, EnhancedAccess, Everywhere, Flex-Edge, Flute, Formcoat, Formwork, Harmonic, Herman Miller for the Home, Herman Miller International Collection, Herman Miller Select, Hopsak 2, Iota, Jaw, Keyless Entry, Latitude, Layout Studio, Living Office, Locale, Loop, Lyris, Lyris 2, Metaform Portfolio, Multiscrim, My Studio Environments, Nelson, Pixelated Support, Public Office Landscape, Q, Rapunzel, Recline Selector, Renew, SoftPad, Sense, Stackable, Stackable Storage, Swoop, Thinking is good for you, Tone, TriFlex, Twist, and Wireframe are among the trademarks of Herman Miller, Inc., and its owned subsidiaries.

SM S3, TAP, Textile Alliance Program, and Herman Miller Options are among the service marks of Herman Miller, Inc.

Chemsurf® is a registered trademark of Wilsonart International.

Corian® is a registered trademark of E.I. du Pont de Nemours and Company Corporation.

DACRON® is a registered trademark of INVISTA S.a r.l.

Edelman® Leather is a registered trademark of Edelman Leather, Inc.

FLEXNET™ is a trademark of Milliken & Company.

Floor Saver Glide® is a registered trademark of Carpin Manufacturing, Inc.

Geiger® is a registered trademark, and Bumper™ and Ward Bennett™ are trademarks, of Geiger International.

Goetz™ is a trademark of Mark W. Goetz.

GREENGUARD® is a registered trademark of the Greenguard Environmental Institute.

Hang-It-All® is a registered trademark of Lucia Eames Demetrios, d.b.a. Eames Office.

Holophane® is a registered trademark of Holophane.

Ingeo™ is a trademark of Cargill Dow LLC.

iPad® is a registered trademark of Apple, Inc.

LifeSize® is a registered trademark of LifeSize Communications, Inc.

Magis®, Bombo®, and Me Too® are registered trademarks of Magis SpA.

Microsoft® and Natural® Keyboard are registered trademarks of Microsoft Corporation.

MOTOROLA XOOM™ is a trademark of Motorola Trademark Holdings, LLC.

Noguchi® and the Noguchi table configuration are registered trademarks, and Rudder Table™ is a trademark, of The Isamu Noguchi Foundation and Garden Museum.

Place Textiles® is a registered trademark of Place Textiles.

SuperSeat™ is a trademark of ITW-Dahti Seating.