



Operation Manual
PVED-CL Controller
for Electro-Hydraulic Steering,
Version 1.38



Revision History*Table of Revisions*

Date	Changed	Rev
11 Jan 2010	Major changes. For PVED-CL software release 1.38	CA
05 May 2007	Major changes. For PVED-CL software release 1.28	BA
01 Nov 2006	First edition. For PVED-CL software release 1.26	AA

Contents**General Information**

Definitions and Abbreviations.....	8
Reference Documents.....	8
Introduction to Electrohydraulic Steering.....	8
EH steering valve.....	9
EHPS steering valve piloted with electric actuator PVE and/or steering unit.....	9
PVG 32 Proportional valve.....	9
PVG 100 Proportional valve.....	10
PVED-CL.....	10
Steering Possibilities.....	10
Input Devices/Controllers.....	10
Programs.....	10
Interface Overview.....	11
Application Examples.....	11
Wheel Loader.....	11
Tractor.....	12
CAN Interface.....	12
Bus Architecture Considerations.....	12
Power-up.....	12
CAN-bus Sensor Power-up Synchronization.....	12
CAN-bus Protocol.....	13
PVED-CL Input Interface	13
Output Interface	13
Battery.....	13
Actuator Position Sensor.....	13
Functional Options Overview.....	14

Safety Considerations

Safety Considerations.....	15
On-road Operation.....	15
Vehicle Speed Sensor.....	15
Closed-loop Operation.....	15
Analogue Input Sensors (Joystick or Wheel Angle Sensor).....	15
Risk assessment.....	16

Configuration and Adjustment

Configuration and Adjustment.....	17
Parameter Tuning Process.....	17
Changing Default Parameters.....	17
System Parameters.....	17
Steering Device Parameters.....	18
Program Parameters.....	18
Indexing Parameter.....	19
Reading and Writing Parameters.....	20
Program Transition Control.....	20
System State.....	20
Select Program/Program Transition.....	20
Program Transition Acknowledge.....	21
How does the PVED work?.....	21
Electronic Control Unit.....	21
Solenoid Valve Bridge.....	21
Control Principle.....	22
Inductive Transducer, LVDT (Linear Variable Differential Transformer).....	22
Integrated Pulse Width Modulation.....	22
LED.....	22

Technical Specification

Technical Data.....	24
---------------------	----

Contents

Installation

Installation..... 25

 Connector Interface..... 25

Valve Interface..... 25

 Valve calibration objectives..... 26

 Dead-band crossing..... 26

 Valve types overview..... 26

 Valve transfer function..... 26

 Valve interface parameters..... 27

Valve calibration methods..... 28

 Method 1: Conservative software dead-band values..... 28

 Example: Determine the general software dead-bands for a series of PVED-CL / EH valve with a dynamic spool:..... 28

 Method 2: Manual software dead-band calibration..... 28

 Method 3: Valve auto-calibration..... 29

 Preconditions:..... 29

 Valve auto-calibration command parameters..... 30

 Valve auto-calibration procedure..... 30

 Suggested valve auto-calibration command values..... 31

Valve auto-calibration quick-guide..... 32

 Valve auto-calibration procedure..... 32

 Parameter tuning order..... 32

 Verification of auto-calibration result stability..... 32

 Verification of the open-loop performance..... 32

 Verification of the closed-loop performance..... 33

 Logging and monitoring..... 33

 Explanation: 33

Mapping a Steering Device..... 34

 Only one signal per analogue channel can be acquired..... 34

Analogue Interface..... 35

 AD Signal Interface Requirements..... 35

 Scaling Analogue Signals..... 35

 Linear Transfer Characteristic (3-Point)..... 35

 Non-Linear Transfer Characteristic (5-Point)..... 36

 Steering Actuator Position Signal..... 37

 Analogue Input Drift Compensation..... 37

 Transmitting the Voltage Readings on CAN..... 38

Steering Device Transition

Steering Device Transition..... 39

Threshold Definition..... 39

Define the Maximum Steering Motion Speed..... 39

Define the Steering Motion Threshold..... 40

Steering Wheel Sensor Noise Gate

Retrieving Steering Device Information..... 41

Steering Wheel Sensor Noise Gate..... 41

 Example:..... 41

Steering by Steering Wheel – Open Loop

Steering by Steering Wheel – Open Loop..... 42

 Acquire the Signals..... 42

 Functionality Tree..... 42

 Open Loop Control..... 43

 Select the Control Principle..... 43

 Apply Backlash..... 44

 Set-point Transfer Function..... 44

 Steering Sensitivity..... 45

 Select a Fixed Sensitivity..... 45

Contents

Select a Sensitivity with Relation to Actuator Position46

Select a Sensitivity with Relation to Vehicle speed.....47

Ramps (Anti-jerk).....48

Ramps with Fixed Ramp Times.....48

 Example:49

 Example:50

Select Ramps with Ramp Times Related to Vehicle Speed.....50

 Example:52

 Example:52

 Anti-jerk Ramp Parameter Tuning Guide.....53

Soft (Cushion) End-stop.....53

Main Spool Dead-band Control Function.....54

 Dead-band Jump Control.....55

 Dead-band Hold and Proportional Control.....55

 Responding to Flow Requests after Tolsout.....55

Magnetic Valve Control.....55

Steering by Steering Wheel – Closed Loop

Steering by Steering wheel – Closed Loop.....56

Functionality Tree.....56

Select the Control Principle.....57

 Acquire the Signals.....57

 Apply Backlash.....57

Steering Sensitivity.....58

Select a Fixed Steering Sensitivity.....58

Select a Sensitivity with Relation to Vehicle Speed.....58

Create the Set-point.....60

Closing the Loop.....61

 Feed-forward.....61

 Steady State Error.....61

 To achieve steady state accuracy:.....61

 Proportional Band.....61

Steering Wheel Knob Position Control.....63

 What makes the steering wheel drift?.....63

Eliminate Noise due to Frequent Pressure Build-up.....63

Magnetic Valve Control.....64

Steering by High Priority Steering Device – Open Loop

Steering by High Priority Steering Device – Open Loop.....65

Functionality Tree.....65

Select the Control Principle.....66

 Acquire the Signals.....67

Set-point Transfer Function.....67

Steering Sensitivity.....68

Select a Fixed Sensitivity.....68

Select a Sensitivity with Relation to the Actuator Position.....69

Select a Sensitivity with Relation to Vehicle Speed.....70

Ramps (Anti-Jerk).....71

Select Ramps with Fixed Ramp Times.....72

 Example:72

 Example:72

Select Ramps with Ramp Time Related to Vehicle Speed.....73

 Example:75

 Example:75

Anti-jerk Ramp Parameter Tuning Guide.....76

Soft (Cushion) End-stop.....76

Spool Dead-band Hold Control Function78

 Dead-band Jump Control.....78

Contents

Dead-band Hold and Proportional Control.....	78
Responding to Flow Requests after Tolsout.....	78
Magnetic Valves OFF Control.....	78
Resolving a Steering Control Conflict.....	78

Steering by High Priority Steering Device – Closed Loop

Steering by High Priority Steering Device – Closed Loop	79
Functionality Tree.....	79
Tracking.....	80
Select the Control Principle.....	80
Acquire the Signals.....	81
Create the Set Point.....	81
Closing the Loop.....	82
Eliminate Noise due to Frequent Pressure Build-up.....	82
Magnetic Valves OFF Control	82
Resolving a Steering Control Conflict.....	83
High Priority Steering Device Enable/Disable Control.....	83
System Requirements.....	83
Device Diagnostic Operation.....	83
Enable or Disable Joystick Steering Device.....	84
Boot-up State of Steering Device.....	84
Getting the Actual Enable/disable Status of the Device.....	84

Steering by Low Priority Steering Device – Open Loop

Steering by Low Priority Steering Device – Open Loop.....	85
Functionality Tree.....	85
Select the Control Principle.....	86
Acquire the Signals.....	87
Set-point Transfer Function.....	87
Steering Sensitivity.....	88
Select a Fixed Sensitivity.....	88
Select a Sensitivity with Relation to the Actuator Position.....	89
Select a Sensitivity with Relation to Vehicle speed.....	90
Ramps (Anti-jerk).....	91
Ramps with Fixed Ramp Times.....	92
Example:	92
Example:	92
Select Ramps with Ramp Time Related to Vehicle Speed.....	93
Example:	95
Example:	95
Anti-jerk Ramp Parameter Tuning Guide.....	96
Soft (Cushion) End-stop.....	96
Spool Dead-band Hold Control Function.....	98
Dead-band Jump Control.....	98
Dead-band Hold and Proportional Control.....	98
Responding to Flow Requests after Tolsout.....	98
Magnetic Valves OFF Control.....	98
Resolving a Steering Control Conflict.....	98

Steering by Low Priority Steering Device – Closed Loop

Steering by High Priority Steering Device – Closed Loop	99
Functionality Tree.....	99
Tracking.....	100
Select the Control Principle.....	100
Acquire the signals.....	101
Create the Set Point.....	101
Closing the Loop.....	102
Eliminate Noise due to Frequent Pressure Build-up.....	102
Magnetic Valves OFF Control.....	102

Contents

Resolving a Steering Control Conflict..... 103
 Low Priority Steering Device Enable/Disable Control..... 103
 System Requirements..... 103
 Device Diagnostic Operation..... 103
 Enable or Disable Joystick Steering Device..... 103
 Boot-up State of Steering Device..... 104
 Getting the Actual Enable/disable Status of the Device..... 104

Auto-steering

Auto-steering..... 105
 Guidance Commands..... 105
 Calculating the Wheel Angle..... 105
 Closing the Loop..... 106
 Trimming the System..... 106
 Noise due to Frequent Pressure Build-up..... 107
 Select a Fixed Sensitivity..... 107
 Vehicle Speed Dependent Sensitivity..... 107
 Magnetic Valves OFF Control..... 109
 Resolving a Steering Control Conflict..... 109
 SASA disengage ability check..... 109

Reduced State

Reduced State..... 111
 Reduced Steering Functionality..... 111
 High Priority Steering Device Fault..... 111
 Low Priority Steering Device Fault..... 112
 Vehicle Speed Sensor Fault..... 112
 Steered Wheel Angle Sensor Fails..... 112

Diagnostic & Troubleshooting

Diagnostic..... 114
 Example on Resolving a Fault 114
 Solution..... 114
 Troubleshooting..... 114
 Typical Fault Sources..... 114
 J1939 Diagnostic Interface..... 115
 AD1 and/or AD2 Short-circuit..... 117
 Missing CAN Sensor Set-points..... 117
 Redundant Wheel Angle Sensor Values Deviate too much or CAN Sensor Set-point Data out of Range..... 118
 Steering Wheel Speed Plausibility Check Failure..... 118
 Vehicle Speed CAN Sensor Data Plausibility Check Failure..... 118
 Power Supply Voltage..... 118
 Sensor Supply Voltage..... 118
 Loss of Main Spool Control or Spool Position Plausibility Check Failure..... 118
 Internal PVED-CL Error..... 119
 LED Diagnostic..... 119

Appendix

System Parameters..... 120
 Program Parameters..... 124
 Steering Device Parameters..... 126

General Information

Definitions and Abbreviations

Definitions and Abbreviations

Term	Description
DTC	Diagnostic Trouble Code
ECU	Electronic Control Unit
EHPS	Electro-Hydraulic Power Steering
MMI	Man-Machine Interface
XID	Extended Message Identifier
PVED-CL	Proportional Valve Digital – Closed Loop – here the valve controller
SPN	Suspect Parameter Number

Reference Documents

Referring to Literature:

Reference
PVED-CL Communication Protocol version 1.38, 11025584

Introduction to Electrohydraulic Steering



As operator comfort receives higher and higher focus along with higher demands for automation, new technologies are necessary to take on this challenge. The new technologies are using electro-hydraulics, combining hydraulic power with electronics and computer power.

Electro-hydraulic steering system has the advantages over pure hydraulic steering systems such as the ability to meet specific functionalities on request.

In order to give this functionality Danfoss has developed the PVED-CL which is a valve actuator with integrated controller, designed to fit onto various Danfoss valves such as:

General Information

EH steering valve



- Max flow: 40 l/min
- Max steering pressure: 210 bar
- Available as in-line and OSPE version

EHPS steering valve piloted with electric actuator PVE and/or steering unit



F301 257

- Flow capacity up to 100 l/min
- Max steering pressure up to 250 bar

PVG 32 Proportional valve



F301 302

- Flow capacity up to 120 l/min
- Max steering pressure: 350 bar

(Please contact Danfoss for further information.)

General Information

PVG 100 Proportional valve



F301 307

- Flow capacity up to 180 l/min
- Max steering pressure: 350 bar

(Please contact Danfoss for further information.)

The advantage of having various valves that interfaces to the same valve actuator is a higher flexibility for our customers needing different valve sizes and wanting to use the same valve actuator.

PVED-CL

The PVED-CL is a steering controller in the Danfoss valve actuator family. The steering controller is designed to meet the functional requirements for steering - electro-hydraulically - any of-road vehicle by following types of steering methods:

- Steering with operator input via steering devices such as joystick, steering wheel sensor, mini-wheel etc.
- Automated steering with input from GPS, laser or row guidance controllers

The compact design of the PVED-CL reduce space, wiring, installation time, and provides the most optimal location of any controller executing software to steer any vehicle. Especially when more than with a one steering device is available in a vehicle or when closed-loop control is used, the advantage of the controller being integrated in the valve becomes clear.

Steering Possibilities

Input Devices/Controllers

The PVED-CL allows up to four steering devices/controllers to be active in one system. For example: Steering wheel and joystick steering in one system can both be connected to the PVED-CL.

The input steering device selection principle works as follows:

- In case the operator wants to switch to a lower priority steering device / controller, the steering valve must be in neutral (no steering) before it can switch to the requested steering device.
- In case the operator wants to switch to a higher priority steering device/controller the switch will happen instantaneously. This means that when several steering devices are operated, the input signal of the steering device/controller with highest priority is always selected.

Programs

The PVED-CL provides, for each steering device, multiple separated set of control parameters (programs) to leave the choice entirely up to the OEM's to:

General Information

- Select and program a control principle (open- or closed-loop) for each program for a particular steering device
- Select and program customized functionalities like variable steering ratio, ramp time, etc. for a particular steering device.

Interface Overview

The PVED-CL provides the possibility for dynamic adjustment of the steering system by dynamically applying a new set of control parameters from a program while driving. This allows the driver to optimize the steering system to the working situation like; material handling, precision steering, fast driving and anti jerk control for articulated steered vehicles. Up to 5 programs per steering device/controller (10 for steering wheel sensor) are available. A man-machine interface (MMI) with a display with control buttons provides means to request programs. The MMI transmits the specific commands via CAN bus.

Application Examples

Wheel Loader

The use of the PVED-CL on wheel loaders typically in conjunction with EHPS gives a range of functional opportunities:

- Anti-jerks functionality
- Soft-stop at cylinder-end positions
- Variable steering ratio – fixed mode
 - Lower steering ratio during a load-cycle
 - High steering ratio during a transport cycle
- Variable steering ratio – speed dependant
 - The higher driving speed - the higher the steering ratio
- Joystick steering
- Graceful degradation (operation in reduced mode)
 - Allow faults to partly shut-down of steering functionality to maximize system performance for the rest of the mission

Other articulated vehicles can have similar advantages.

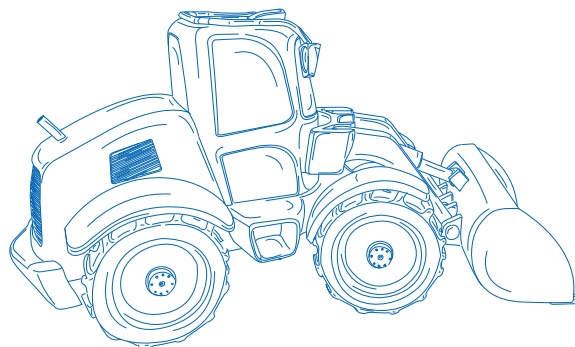

General Information

Tractor

- Auto-guidance with GPS, laser or row guidance controllers
- Variable steering ratio - actuator dependant
 - Lower steering ratio during load cycle
- Variable steering ratio speed dependant
 - The higher driving speed the higher ratio
- Plug and perform GPS control

Storing the machine parameters in the PVED-CL allows a GPS controller to be moved between various machines without re-adjusting the machine parameters.

Automated steering is the next step in automating the field work on farms. The automated steering gives the following advantages

- Longer operation time
- Ensures that the machine works optimally (minimal waste).

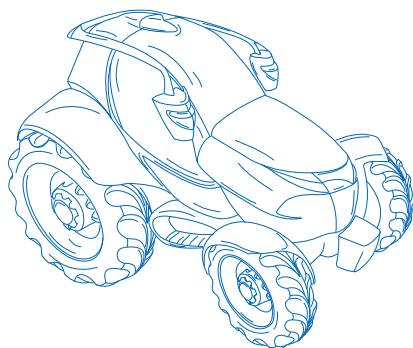

CAN Interface

Bus Architecture Considerations

It is recommended to install the steering system on a separate bus as it is important to have enough CAN bus bandwidth for all the input devices/controllers and the PVED-CL to work in an optimal way.

Power-up

Within 1500 ms after powering up, the PVED-CL is fully operational and transmits an Address claim message on CAN-bus. Power-up is normally synchronized with engine start and allows to be executed regardless any sensor input values. After power up the PVED-CL validates periodically the presence of all CAN and analogue control signals with the ones mapped. In case a signal is not available or is invalid, the PVED-CL enters fault-mode or optionally a reduced state, where operation is continued with reduced steering functionality. After successful power-up, the main spool inside the valve is first operated when a steering device is operated.

CAN-bus Sensor Power-up Synchronization

The PVED-CL can be configured to wait up to 10000 ms for a CAN message. This is to accommodate for slow-starting CAN devices which are transmitting data to the PVED-CL.

Please see device dependent parameters **HPStwPowerUpTimeout**, **HPStdPowerUpTimeout**, **LPStdPowerUpTimeout**, **WAPowerUpTimeout** and **VSPowerUpTimeout** in [System Parameters](#) on page 120.

General Information

CAN-bus Protocol

The PVED-CL conforms to CAN-bus standard J1939. Relevant J1939 compliance issues are explained in *PVED-CL Communication Protocol*, **11025584**.

For details on parameter changes, refer to [Changing Default Parameters](#) on page 17.

PVED-CL Input Interface

The PVED-CL provides:

- Two 0-to-5 V DC analogue inputs
- One CAN J1939 2.0b compatible bus

The CAN interface combines compact design, reliability and flexibility to offer the steering functionality required. Additionally the CAN interface is used for configuration and diagnostic purposes.

For correct signal acquisition, read the requirements described in Analogue Interface, page 28 and *PVED-CL Communication Protocol*, **11025584**.

Output Interface

The PVED:

- Controls the physical movement of the main spool inside the valve
- Controls the color of the LED
- Transmits process data on CAN to help service personnel during installation and to verify the Computational processed PVED-CL.

Battery

Likewise hydraulic power, sufficient electric power supply to the PVED-CL is crucial to operate the spool inside the valve and to transport the control signals. Without it, the vehicle cannot be steered by the PVED-CL. In order to cope with voltage fluctuations during cold engine start or disturbances by the alternator, the PVED-CL incorporates a regulator to stabilize the voltage level used by the electronics and sensors connected to the analogue inputs. The regulator makes the same PVED-CL compatible to both 12 and 24 Volt batteries. For more information, see [Technical Data](#) on page 24.

Actuator Position Sensor

The actuator sensor serves the purpose to allow external closed loop position control, for example soft stop or variable steering sensitivity depending on cylinder position.

For added safety the PVED-CL provides connectivity of a second sensor inputs at the same interface type. When position sensors are mounted on the steering actuator, the signal range must be at least 5 to 10% larger than maximum physical movement of the actuator.

The PVED-CL incorporates a printed circuit board (PCB), LVDT sensor and a solenoid operated hydraulic H-bridge. The PCB provides connectivity to CAN and analogue signals by two 4-pin connectors each colored differently¹ to distinguish CAN and power supply from cables with analog control signals. The gray connector is dedicated for CAN and electric power supply and the black for connecting analogue devices to the PVED.

¹ Only for AMP. See also laser engraved text on PVED-CL to distinguish between CAN and Analog.

General Information

Functional Options Overview

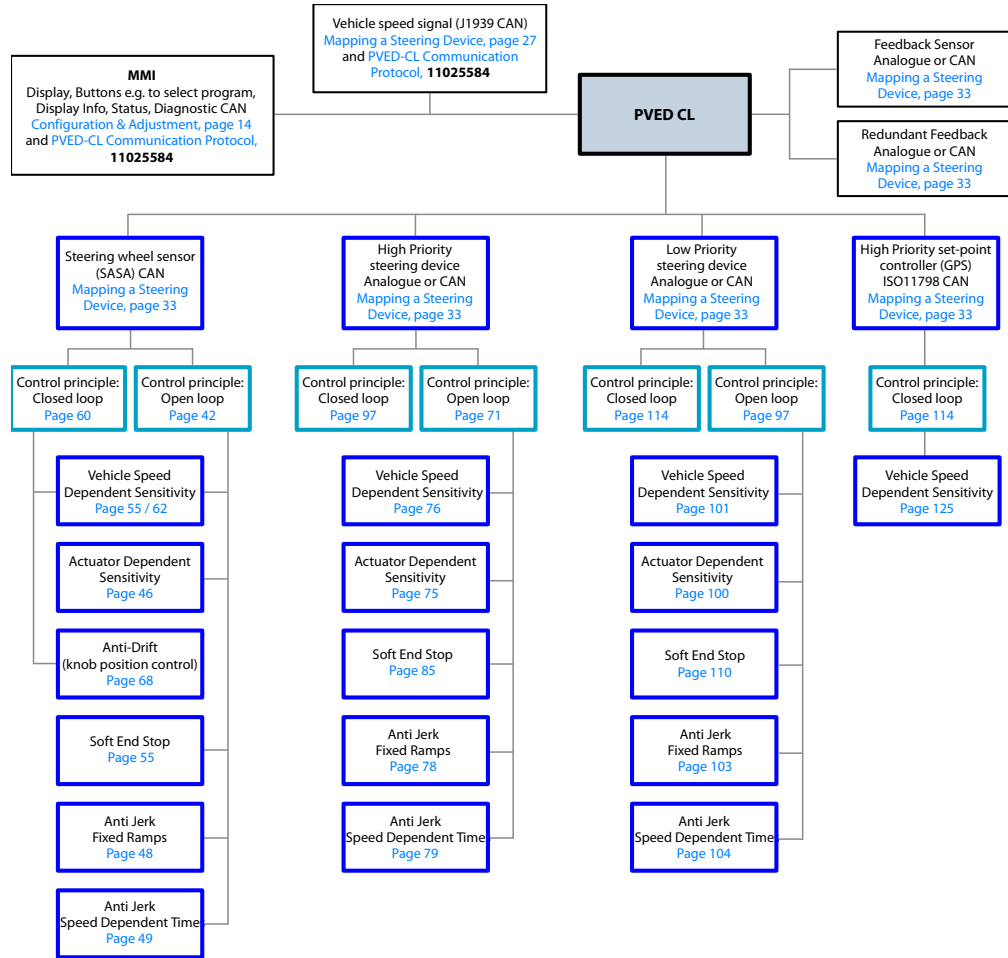

Safety Considerations

Safety Considerations

The steering architecture shall be designed with care. Controlling an EHPS or EH valve with a PVED-CL is designed for off-road use only. More single channels of control may be identified in the architecture, meaning that a single failure may have an impact on the steering behavior which cannot be resolved by the architecture itself.

In these situations the driver or external equipment must intervene to bring the steering system to a safe state.

The PVED-CL has on-board fault monitoring on the sensor interface as well as other critical parts of the system. Please refer to [Diagnostic & Troubleshooting](#) on page 114 for an overview of the PVED-CL fault monitoring.

On-road Operation

Warning

The PVED-CL shall be de-energized while driving on-road. It is the OEMs responsibility to establish the necessary means to inform and de-energize the PVED-CL from the cabin when driving on public roads.

Vehicle Speed Sensor

The vehicle speed sensor may be used to modulate the steering valves output as a function of vehicle speed. However, the PVED-CL has no means to validate the validity of the vehicle speed signal as long as the messages arrive correctly and the data field is within the valid range. Therefore:

Warning

It is the OEMs responsibility to establish a reliable vehicle speed signal to the PVED-CL.

The provider of the vehicle speed signal shall implement means to detect faults and let the vehicle speed sensor go silent if a fault is detected. A silent vehicle speed sensor will be detected by the PVED-CL and it will enter fault state or optionally reduced state.

Closed-loop Operation

The PVED-CL may be used in closed-loop applications such as auto-guidance or row guidance. The PVED-CL has no means to validate the validity of an input steered wheel angle set-point or steered wheel position as long as the set-point conform to the timing and data range requirements. Therefore:

Warning

It is the OEMs responsibility to establish a reliable steered wheel angle set-point to the PVED-CL.

Analogue Input Sensors (Joystick or Wheel Angle Sensor)

The PVED-CL has no means to validate the validity of an input if the voltage conforms to range requirements.

Any undetected faults may be resolved by changing to steering wheel steering.

Warning

It is the OEMs responsibility to establish reliable analogue signal connections to the PVED-CL.

Safety Considerations

Risk assessment

 **Warning**

It is the OEMs responsibility to perform a hazard and risk analysis of the complete steering system and add the necessary risk-reducing measures.

Configuration and Adjustment

Configuration and Adjustment

The PVED-CL contains parameters to tailor the valve and PVED-CL to the vehicle and to provide the required functionality. The OEM must be in possession of an interface device that is capable of reading and transmitting messages on the CAN bus. It is recommended to implement the PVED-CL communication protocol in a service tool or MMI.

Parameter Tuning Process

A typical parameter tuning process is:

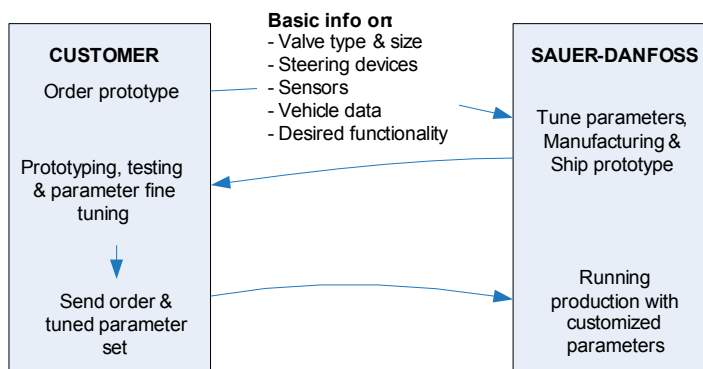

Danfoss Technical Sales is able to ship steering valve prototypes that are vehicle install-ready and where the relevant parameters have already been tuned towards their optimum values. The OEM customer needs to do the fine-tuning.

Changing Default Parameters

The PVED-CL is manufactured with a parameter set that provides basic functionality for the steering devices that are used. In most cases the default values need to be changed to adapt the valve to the system.

Configuration of the PVED-CL is required to customize the EHPS/EH system to a particular vehicle. Parameters are used to e.g. map steering devices and sensors, compensate for non-linearity in steering signals and to control the functionality features in the PVED-CL.

There exists three different kinds of parameter types:

System Parameters

System parameters are parameters which describe:

- PVED-CL interface & environment configuration (sensors, valves)
- Start-up default behavior (sensor interface)
- Addresses on J1939 CAN bus (customization of CAN IDs)
- System identification information (valve type, software version, sales order number, PVED-CL serial number)

It is vital in order to achieve correct PVED-CL functionality, that the system parameters are set correctly. Some system parameters are used by the software to calculate the correct hydraulic gain, determining left and right direction etc. An overview of all system parameters can be found in appendix [System Parameters](#) on page 120.

Configuration and Adjustment

Steering Device Parameters

Steering device parameters are parameters which define functionality related to a particular steering device. These parameters will be common to a particular device at all times during operation and for all steering device programs. The parameters define functionality as:

- Detection criteria for steering device activation
- Steering device closed-loop proportional gain
- Spool control in the valve dead-band region
- Program transition criteria for a steering device
- Magnetic bridge enable/disable control for a steering device

An overview of all steering device parameters can be found in appendix [Steering Device Parameters](#) on page 126.

Program Parameters

A number of user programs are available to each steering device. This enables programming flexible functionality for each steering device such as:

- Possibility to adapt the steering system to the working situation.
- Personalized steering behavior (novice or expert level)
- Customized/variable steering ratio/gain settings
- Invert flow direction for e.g. backward steering

A number of programs are allocated to each steering device as shown in the table below. Each program has a unique number which is used for requesting a new program from the MMI.

Number of programs per steering device

Steering device	Number of programs	Program number
Steering wheel sensor (SASA)	10	0-9
High priority steering device	5	20-24
Low priority steering device	5	25-29
High priority set-point controller	5	30-34

Example on program layout for high priority steering device

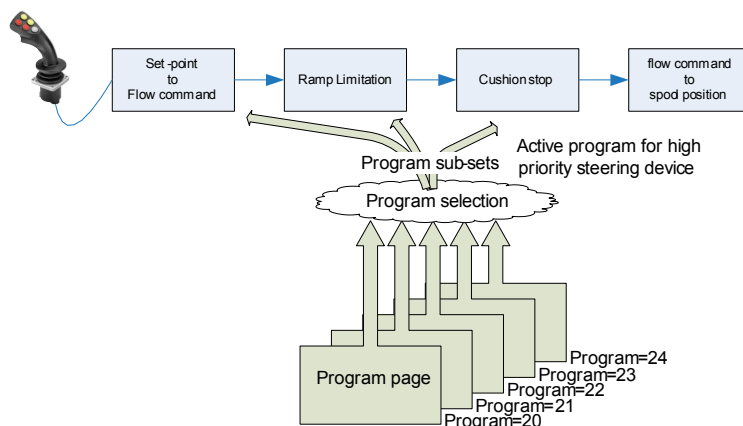

At power-up, the lowest program number for each device is applied i.e. program 0 for steering wheel sensor, program 20 for high priority steering device etc.

Configuration and Adjustment

The program for a steering device becomes active as soon as the steering device is activated i.e. meets the set-up criteria for when the PVED-CL shall regard a steering device as 'being used for steering'.

An overview of all program parameters can be found in appendix [Program Parameters](#) on page 124.

Indexing Parameter

Each parameter has a unique index. Only one parameter can be accessed at a time. The system parameter and steering device parameter indices are explicit and can be found in [Appendix](#) on page 120.

The program parameters are organized in a matrix. Each program parameter index for given program and for a given steering device can be derived as follows:

$$\text{Parameter index} = [\text{Steering Device number}][\text{Program index}][\text{Program parameter sub-index}]$$

Number of programs per steering device

Steering device	Steering Device Number	Program Index
Steering wheel sensor (SASA)	1	0-9
High priority steering device	3	0-4
Low priority steering device	4	0-4
High priority set-point controller	5	0-4

The program parameter sub-index is the two last digits in program parameters in appendix [Program Parameters](#) on page 124.

What is the program parameter index for 'Steering sensitivity selector, Sse' for the steering wheel program 4?

Program Parameters				
Name	Data type	Description of parameters	Steering	
			Steering wheel	High priority device
Pid	S16	Program identification number.	1x00	3x00
Did	U8	Device identification number.	1x01	3x01
Cp	BOOL	Control principle.	1x02	3x02
Xysat	S16	Saturation of Y at input X.	1x03	3x03
Ri	S16	Steering wheel backlash.	1x04	3x04
db	S16	Dead band.	1x05	3x05
Lx	S16	Linearity index.	1x06	3x06
YR	S16	Right position limit.	1x07	3x07
YL	S16	Left position limit.	1x08	3x08
Sse	U8	Steering sensitivity selector.	1x09	3x09

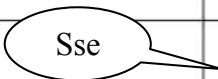

Steering wheel device is defined as device number 1. The index for program number 4 is derived by substituting x with 4 i.e. the index is 1409.

Sse for high priority steering device program 1 is 3109 etc.

Default program index for steering devices is 0.

Configuration and Adjustment

Reading and Writing Parameters

Configuring the PVED-CL by means of setting parameters and reading parameters is done via a J1939 CAN bus, using proprietary PGN 61184. The configuration command set is described in *PVED-CL Communication Protocol, 11025584*.

The following steps are needed to change a parameter:

Variable	Description
Power up PVED-CL	The PVED-CL shall be in operational, reduced or calibration mode (observe current mode in OperationStatus message) to accept parameter changes.
Configure	On reception of one or more SetParameter messages, the contents are decoded and temporarily stored in RAM. The PVED-CL will send SetParameterResponse to verify the reception of each command. Switching off the electric power to the PVED before committing the data will erase all parameter changes. Attempts to write or read non-existing parameters have no effect.
Commit to EEPROM	On reception of a single CommitData message, all RAM parameters are stored in EEPROM. During this operation, all parameters are range checked. The commit procedure (copying data from RAM to EEPROM) will take 4 seconds to complete. Committed parameters will first have any effect after the next boot up. If power is disconnected before all parameters are stored in EEPROM, the PVED will power-up with the previous set of valid parameters. Observe CommitDataResponse for information on commit process and success rate.

Program Transition Control

The PVED-CL can change steering program and thus steering behavior maximum 50 ms after reception of a Select Program command. However, before a new program is applied, the PVED-CL validates the system state for safe program transition.

System State

The system state is defined by:

Variable	Description																				
Vehicle speed	The vehicle shall drive slower or equal to a threshold value. The PVED-CL provides max vehicle speed thresholds for each steering device. The default values are chosen for robustness reasons to create a region rather than a point.																				
	<table border="1"> <thead> <tr> <th>Device</th> <th>Index</th> <th>Default</th> <th>Value range</th> </tr> </thead> <tbody> <tr> <td>Steering by steering wheel</td> <td>127</td> <td>50</td> <td>0-1000 (0.0-1000 km/h)</td> </tr> <tr> <td>Steering by high priority steering device</td> <td>327</td> <td>50</td> <td>0-1000</td> </tr> <tr> <td>Steering by low priority steering device</td> <td>427</td> <td>50</td> <td>0-1000</td> </tr> <tr> <td>Steering by GPS, Laser or row guidance controllers</td> <td>527</td> <td>50</td> <td>0-1000</td> </tr> </tbody> </table>	Device	Index	Default	Value range	Steering by steering wheel	127	50	0-1000 (0.0-1000 km/h)	Steering by high priority steering device	327	50	0-1000	Steering by low priority steering device	427	50	0-1000	Steering by GPS, Laser or row guidance controllers	527	50	0-1000
	Device	Index	Default	Value range																	
	Steering by steering wheel	127	50	0-1000 (0.0-1000 km/h)																	
	Steering by high priority steering device	327	50	0-1000																	
Steering by low priority steering device	427	50	0-1000																		
Steering by GPS, Laser or row guidance controllers	527	50	0-1000																		
This condition has no effect when vehicle speed signal is not present.																					
The setting the treshold higher than the max. vehicle speed disable this condition.																					
Steering actuator speed	The spool inside the valve must be in or near its neutral position.																				
Steering actuator position	The steering actuator position must be within the limits specified by the YR and YL parameter.																				

Select Program/Program Transition

The program is applied when all conditions are met, otherwise it is rejected and the current program is kept.

A program transition request is accomplished by transmitting a **SelectProgram** command (see **SelectProgram** in *PVED-CL Communication Protocol, 11025584*).

Configuration and Adjustment

Program Transition Acknowledge

Upon the reception of a **SelectProgram** command and if the system state allows it, the program transition is executed and a SelectProgram response is transmitted (see **SelectProgramResponse** in *PVED-CL Communication Protocol, 11025584*).

The currently active program is continuously transmitted in the PVED-CL operation status message (see **OperationStatus** in *PVED-CL Communication Protocol, 11025584*).

How does the PVED work?

The PVED incorporates a printed circuit board (PCB), LVDT sensor and a solenoid operated hydraulic H-bridge. The PCB provides connectivity to CAN and analogue signals by two 4-pin connectors each colored differently to distinguish CAN and power supply from cables with analog control signals. When using AMP the gray connector is dedicated for CAN and electric power supply and the black for connecting analogue devices to the PVED. Deutsch connectors are not-keyed, but PVED-CL is laser-marked with description.

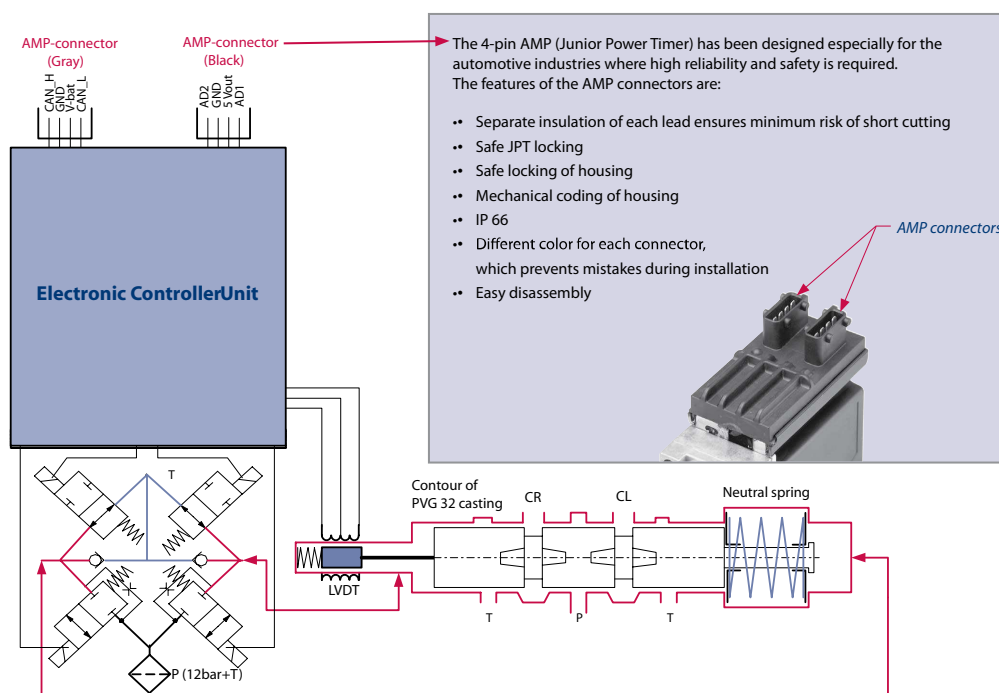

Electronic Control Unit

The Electronic Control Unit (ECU) performs the following tasks:

- CAN messages. The PVED hardware is compatible to CAN 2.0B
- Converting two analogue input voltages between 0 and 5V to digital signals (10 bit)
- Executing the steering software & monitoring for discrepancies with fixed time intervals
- Output the main spool position setpoint
- Controlling the LED color

Solenoid Valve Bridge

The PVED-CL features an integrated feedback transducer that measures spool movement in relation to the input signal from the main micro controller, and by means of a solenoid valve bridge, controls the direction, velocity, and position of the main spool of the valve. The integrated electronics compensate for

Configuration and Adjustment

flow forces on the spool, internal leakage, changes in oil viscosity, pilot pressure, etc. This results in lower hysteresis and better resolution.

Control Principle

In principle the input signal (set-point signal) determines the level of pilot pressure, which moves the main spool. The position of the main spool is sensed in the LVDT transducer, which generates an electric feedback signal registered by the electronics. The variation between the set-point signal and feedback signal activates the solenoid valves. The solenoid valves are actuated so that hydraulic pressure drives the main spool into the correct position.

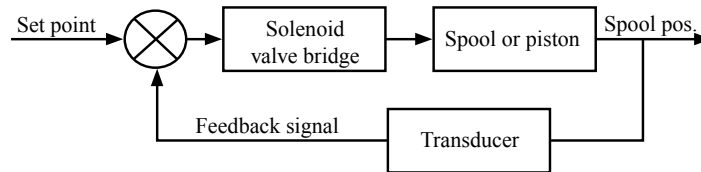

Inductive Transducer, LVDT (Linear Variable Differential Transformer)

When the main spool is moved, a voltage, proportional to the spool position, is induced. The use of LVDT gives contact less monitoring of the main spool position. This means an extra long working life and no limitation as regards the type of hydraulic fluid used. In addition, LVDT gives a precise position signal of high resolution.

Integrated Pulse Width Modulation

Positioning of the main spool in the PVED-CL is based on the pulse width modulation principle.

LED

A three-color LED on the top of the PVED provides high-dependable information of 4 basic states of the electronic hardware.

Inactive: No electric power

Green: The PVED controls the spool movement inside the valve.

Yellow: The magnetic valves are temporary disabled due to the power saving feature or until the PVED is operated. The magnetic valves can also permanently be disabled due to a major fault in the PVED or wrong signal reception. The CAN bus communication is still operational for diagnostics according to protocol definition. The spool position control is disabled.

Red: The PVED has detected a critical fault or inconsistency and has executed a "failed silent" procedure. The spool position controller (Magnetic valves) is disabled. CAN is disabled for diagnostics.

Configuration and Adjustment



In case the LED indicates yellow, details of the fault can be retrieved from the persistent error buffer and transmitted on CAN. For more information on this topic see [Diagnostic & Troubleshooting](#) on page 114.

Technical Specification
Technical Data
Technical Data

Electrical	Unit	Min	Max
Required supply voltage	V DC	11	32
Required current with magnetic valves enabled	A	1	0.3
Required current with magnetic valves disabled	A	0.1	0.03
Power consumption	W	7	10
Power consumption (magnetic valves off)	W	max 0.3	
Hydraulic			
Viscosity	Cst	21	460
Contamination level (ISO 4406)	-	21/19/16	
Max EMC	V/m	max 100	
Oil temperature	°C	-30	90
Recommended oil temperature	°C	30	60
Ambient Temperature	°C	-30	60
Pilot flow with magnetic valves disabled	l/min	0.2	0.4
Pilot flow with magnetic valves enabled	l/min	0.2	1.1
Pilot pressure to PVED	bar	10	15
Signals			
Stabilized voltage supply	V DC	4.80	5.20
Max current taken from stabilized voltage supply	mA	100	
Digital conversion of signals at AD1 & 2	V DC	0 to 5 VDC into 0 – 1023 (10 bit)	
Available baud rates to CAN	Kilo bit/s	125, 250, 500	
AD1 & 2 input impedance		Approximately 1MΩ	
Max analogue signal source impedance		<100 kΩ	
Protection			
Grade of enclosure (IEC 529) Connector	IP	66	
Over voltage at 36 V DC	minutes	5	
Reverse polarity	minutes	Infinite for all faults except: see Installation on page 25.	
Performance			
Spool position Hysteresis in % of full spool stroke	-	0.5	1
Inherent Ramp-up time from neutral to full open	ms	50	210
Inherent Ramp-down time from full open to neutral	ms	40	150
Boot time EHPS software	ms	1200	1500
Recognition time of incorrect voltage signals	ms	50	
Recognition time of incorrect supply voltage	ms	200	
Recognition time of incorrect CAN signals	ms	200	
Recognition time of incorrect internal operations	ms	50 (watchdog)	

Installation

Installation

Connector Interface

Two connector variants are available: Deutsch and AMP. Interchanging the Deutsch connectors will not destroy the PVED-CL however the PVED-CL will not work.

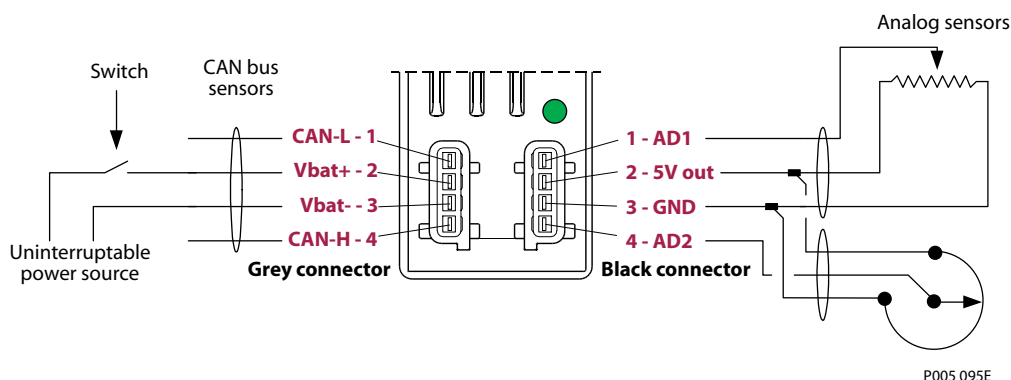
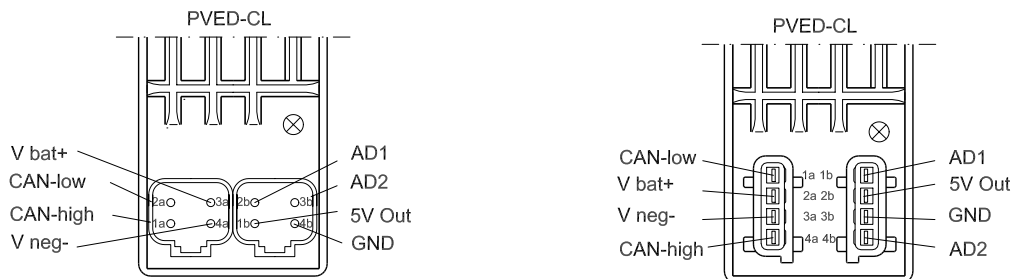

The CAN-wiring is done according to J1939-15, where as Analogue wiring is recommended to be at least 0.75 mm² and no longer than 9 meters.

Warning

The following wiring faults will destroy the PVED-CL '5V out' output:

- Connecting GND to 5V out AND Vbat+ to Vbat-
- Connecting Vbat+ to 5V out
- Short-circuit 5V out to GND for more than 5 minutes

Valve Interface

The PVED-CL shall always be calibrated to the valve it is controlling. Valve calibration enables interfacing to various valve types as well as cancellation of mechanical, electrical and environmental dependent tolerances which can lead to performance degradations. Valve calibration is normally only needed once at production time, at installation time, in a PVED-CL replacement situation or in performance fine-tuning situations.

The PVED-CL is calibrated to the valve by a dedicated valve transfer function, having 7 parameters to compensate for discontinuities (hydraulic dead-band), asymmetry (maximum flow) and non-linearity in the left and right spool characteristic. Correct parameter values are essential for achieving optimum performance in all PVED-CL operation modes.

Installation
Valve calibration objectives

The PVED-CL calibration shall satisfy multiple conflicting objectives. Like for any proportional spool valve, the purpose of the hydraulic dead-band is to prevent unwanted oil output flow while the main spool is resting in neutral position.

In PVED-CL steering wheel mode (open-loop application), the dead-band prevents noise (electrical and mechanically), from e.g. the steering wheel sensor (SASA), from leading to unwanted oil output flow or creating small steady-state quivering wheel movements. On the other hand, a too large dead-band may result in a noticeable steering wheel dead-band which may not be desirable.

For closed-loop applications such as auto-steering, the hydraulic dead-band has an undesirable effect. Small position control errors are corrected by proportional spool activations to output a correcting flow. However, if the spool movement is inside the hydraulic-dead-band, then a steady-state error is present which will cause the vehicle to drift from the desired course. This is one of most likely reason for degraded auto-steering performance and shall be avoided.

The performance objective in closed-loop mode is to always output a flow when a steered wheel position error is present while ensuring that the valve operation is not too crude, leading to jerky vehicle course corrections.

Dead-band crossing

In open-loop operation mode, the spool operation in the hydraulic dead-band can be configured by parameters. The spool can either be controlled through the hydraulic dead-band manually by following the input device set-point. This allows the user to control the level of pressure built-up of the steered wheels. This is controlled with the valve-specific parameters, as well as the steering device specific parameters (See the input device specific chapters).

Alternatively the spool operation can be configured to 'jump' between over the dead-band. This resembles servo valve operation and gives a fast steering response.

In PVED-CL closed-loop operation mode, the spool will always jump over the hydraulic dead-band.

Valve types overview

The below table shows the hydraulic dead-band characteristics and tolerances for the available steering valves. Due to mechanical tolerances on the valve parts, the exact hydraulic dead-band position cannot be predicted for any single valve. Similarly, it may differ from valve to valve.

Steering valve tolerance characteristics

Valve type	Nominal dead-band		Dead-band tolerance		Maximum spool displacement	
	[mm]	[Xsp]	[mm]	[Xsp]	[mm]	[Xsp]
EH, dynamic spool	0.5	94	0.36 – 0.62	77 – 108	3	430
EH, static spool	0.8	136	0.6 – 1.1	106 – 177	3	430
OSPEH	0.8	136	0.6 – 1.1	106 – 177	4	560
EHPS	1.3	204	1.05 – 1.55	170 - 238	7	915

Xsp values are valid for programmed linear spool characteristic.

Valve transfer function

The valve transfer function matches the PVED-CL to the valve and thus also the hydraulic dead-band. The PVED-CL converts the calculated requested port flow to a spool set-point, Xsp. Xsp is a scaled representation of the physical spool displacement where 0 is neutral position and ± 1000 is the maximum possible spool stroke.

Installation

Diagram

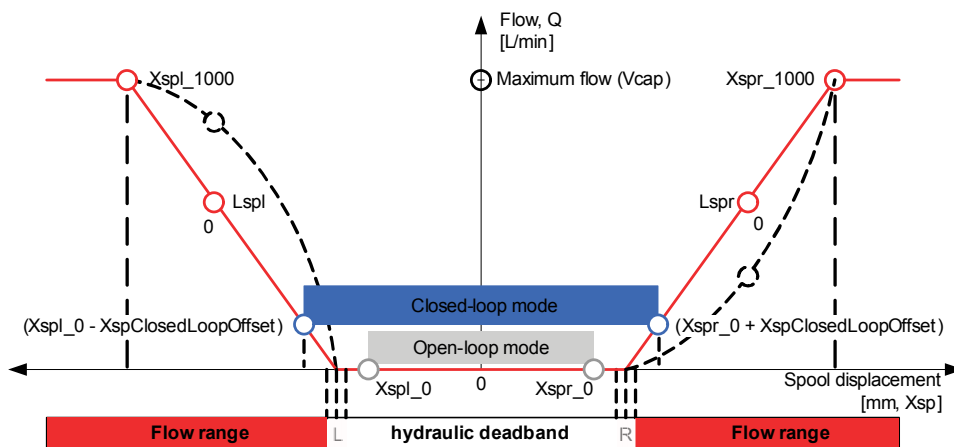

Valve interface parameters

Xspl_0 Left software dead-band in PVED-CL open-loop operation mode.

Lspl Controls the left spool position-to-flow linearity. Use for compensating for non-linearity or to create non-linear spool characteristics. Default is linear spool characteristic.

Xspl_1000 Left maximum port flow. Port flow at this set-point is equivalent to maximum valve capacity.

Xspr_0 Right software dead-band in PVED-CL open-loop operation mode.

Lspr Controls the right spool position-to-flow linearity. Use for compensating for non-linearity or to create non-linear spool characteristics. Default is linear spool characteristic.

Xspr_1000 Right maximum port flow. Port flow at this set-point is equivalent to maximum valve capacity.

Vcap Parameter holding information about the maximum flow capacity of the valve.

ClosedLoopXspOffset Spool position offset which is added to spool position set-point in closed-loop mode only. The offset ensures that the spool is always operated at a point where the valve outputs a flow. The offset extends the software open-loop dead-bands to form closed-loop dead-bands as illustrated above.

Valve interface parameters

Symbol	Index	Default	Value range
Xspl_0	737	-185	-250 to 0 for EH valve -350 to 0 for EHPS valve
Lspl	702	0	-10 to 10 (max regressive to max progressive)
Xspl_1000	729	-1000	-1000 to -300 for EH valve -1000 to -400 for EHPS valve
Xspr_0	738	185	0 to 250 for EH valve 0 to 350 for EHPS valve
Lspr	703	0	-10 to 10 (max regressive to max progressive)
Xspr_1000	747	1000	300 to 1000 for EH valve 400 to 1000 for EHPS valve
Vcap	706	25	5 to 120 (5 to 120 L/min)
ClosedLoopXspOffset	748	25	0 to 1000 (0 to ±maximum spool stroke)

Installation

Valve interface parameters (continued)

Symbol	Index	Default	Value range
ValveType	65121	1	1 - EHPS valve 2 - EH/OSPE valve
Note that the default values may not be suitable for all valve types.			

Valve calibration methods

The PVED-CL can be calibrated to a valve in three possible ways:

- Use conservative software dead-band values
- Manual software dead-band calibration
- Valve auto-calibration

Method 1: Conservative software dead-band values

This method does not require any specific sensor or measurement equipment. The principle in this method is to set the open-loop and closed-loop software dead-bands sufficiently low and high, respectively, and let these dead-bands be valid for an entire series of valve units.

1. The open-loop dead-bands are determined based on the minimum hydraulic dead-band tolerances for a particular valve.
2. The closed loop dead-bands are determined by setting the **ClosedLoopXspOffset** parameter, based on knowledge to the maximum hydraulic dead-band tolerances for a particular valve and adding some margin, to always have a correcting flow available.

Example: Determine the general software dead-bands for a series of PVED-CL / EH valve with a dynamic spool:

- All dead-band values are in scaled spool position set-points, Xsp.
- From the [Valve types overview](#) on page 26 we get the minimum hydraulic dead-band to 77 and a maximum hydraulic dead-band equal to 108.
- **Xspl_0** and **Xspr_0** are set to ± 70 to have a small overlap (± 7) to the minimum hydraulic dead-band.
- To ensure enough flow for e.g. auto-steering, **ClosedLoopXspOffset** is set equal to the maximum hydraulic dead-band plus a little margin to guarantee a flow.
- In this example a margin equal 25 is chosen which result in a **ClosedLoopXspOffset** equal to $(108 + 25) - 70 = 63$.
- **Xspl_1000** and **Xspr_1000** are set to 430 to operate the EH valve in its full range.

Using conservative dead-band values will create steering performance which will vary slightly from valve to valve. E.g. for variable steering ratio applications, the dead-band and steering ratio will vary slightly. Similarly in auto-steering mode, the flow for correcting the steered wheels may vary from smooth corrections to more jerky corrections.

Method 2: Manual software dead-band calibration

The principle in this method is to match the PVED-CL software dead-bands to the hydraulic dead-band for the particular valve it is controlling. This kind of calibration will reduce the impact of mechanical tolerances and thus reduce the valve-to-valve performance differences.

This method does not require any specific sensor but requires a service tool to be connected to the PVED-CL. The operator performing the calibration must be able to observe a movement of the steering actuator or steered wheels during the procedure and read out main spool set-points.

Installation

For production, calibration and field service purposes, the PVED_CL allows direct control of the main spool. On reception of a **SetSpoolPosition** message (see *PVED-CL Communication Protocol*, **11025584**), the main spool can be commanded to a specific set-point position. Manual software dead-band calibration can only be performed when the PVED-CL is in calibration mode. See section **EnterCalibrationMode** in *PVED-CL Communication Protocol*, **11025584** on how to run the PVED-CL in calibration mode.

The procedure requires a service tool to set the PVED-CL in calibration mode and to control the main spool set-point. The procedure is:

1. Find the hydraulic dead-band by gradually increasing the main spool set-point in small steps (5 – 10), until steered wheel movement is observed. Must be done for both left and right direction.
2. Determine **Xspl_0** and **Xspr_0** by subtracting 10-25 from the detected hydraulic dead-bands. This shall ensure that the open-loop dead-bands are inside the hydraulic dead-band with an over-lap.
3. The closed-loop dead-band values are calculated as the detected hydraulic dead-band values plus some margin depending on the desired minimum correction flow. Typical values are 20-30 further out than the hydraulic dead-band values.
4. **Xspl_1000** and **Xspr_1000** are set to the respective maximum stroke for the valve (see valves types overview).

The applied values are example values. The optimum values are vehicle specific.

The result that can be achieved with manual calibration is also operator sensitive. Manual valve calibration depends on visual confirmation of wheel movement. Differing perception of wheel movement will affect the final steering performance.

Method 3: Valve auto-calibration

A third alternative is to utilize a build-in valve auto-calibration algorithm which can automate the valve calibration and produce deterministic results. The algorithm utilizes the wheel angle sensor and can be regarded as an automated manual calibration procedure.

See section **StartValveAutoCalibration** in *PVED-CL Communication Protocol*, **11025584** on how to invoke the valve auto-calibration.

During the calibration procedure, the actuator position/steered wheel angle (Y_{act}) change is measured in a pre-defined time interval (dt) to derive a steering velocity representation. Exceeding a defined Y_{act}/dt is used as an "output flow detected" criterion. The principle in valve auto-calibration is to search for the main spool set-point X_{sp} , where output flow is detected and then derive the software open-loop dead-bands by applying a fixed rule. This is done for both left and right direction.

Preconditions:

1. The PVED to valve auto-calibration is available only when PVED is in the calibration mode. See section **EnterCalibrationMode** in *PVED-CL Communication Protocol*, **11025584** on how to set the PVED-CL in calibration mode.
2. The valve auto-calibration command shall be sent from the MMI controller.
3. A wheel angle sensor shall be installed, mapped and calibrated.
4. A steering wheel sensor (SASA) shall be installed and mapped.
5. The wheels shall be positioned in the straight ahead position $\pm 25\%$ of the max angle in one direction prior to invoking valve auto-calibration.
6. Auto-calibration shall be performed while the wheels are on an even and solid surface. No front load or front attachment shall be mounted.
7. Parameter configuration is not possible during the auto-calibration procedures. Any attempt to read or write parameters is ignored.

Installation

Valve auto-calibration command parameters

See section **StartValveAutoCalibration** in *PVED-CL Communication Protocol, 11025584* on how to format the command and for detailed status/error code information.

Valve auto-calibration command parameters

Command	Description
XspStartSearch	Sets the starting main spool set-point. Values close to 0 will include more of the hydraulic dead-band in the search and thus consume more time. Setting the value closer to a main spool position where flow is expected, will speed up the calibration time. The starting main spool set-point is used for both the left and right direction.
XspIncrementSize	The main spool set-point increment size defines the step that the algorithm is using in each iteration. As a consequence, it defines the resolution of the calibration result. A small value < 5 could potentially produce a more accurate calibration result at the expense of calibration time. However, repeatability of the calibration result may be poor. A step size > 5 will speed up the calibration time at the expense of calibration accuracy.
YactDiffThreshold	Set the 'change threshold' for 'steering actuator position'/'steered wheel position' (Yact) that is the criterion for detecting a flow. The position change, $\Delta Yact$, is measured in the time-out period for each main spool position set-point increment. A low threshold (< 20) will detect very small flows but is sensitive to e.g. noise from the wheel angle sensor. Too low thresholds will often result in false flow detection which again results in too conservative software dead-bands. A high threshold (> 60) requires a significant position changes. Further-more, the calibration time increases because the main spool needs to be increment to a higher set-point before the necessary output flow is present. Yact is the scaled 'steering actuator position'/'steered wheel position'.
TimeOutPeriod	The time between two consecutive steps of the automatic calibration process and thus sets the measurement time in which $\Delta Yact$ is measured. A value <500 could reduce the calibration time, but requires careful selection of the YactDiffThreshold setting. A value >1000 significantly increases the calibration time requirement.

XspCalibrationOffset - Main spool displacement offset which is subtracted from the detected spool set-point which satisfies the 'output flow detected' criterion. Subtracting the offset from the detected spool set-points results in the open-loop software dead-bands values.

XspCalibrationOffset is a parameter value and is used for both left and right spool direction.

XspCalibrationOffset parameters

Symbol	Index	Default	Value range
XspCalibrationOffset	758	25	0 -300 (scaled main spool set-points, Xsp)

XspCalibrationOffset is a parameter value and not intended to be modified on each auto-calibration invocation.

Valve auto-calibration procedure

The valve calibration procedure and how all involved parameters are used, works as follows.

The procedure is showed for the right dead-band only.

Installation

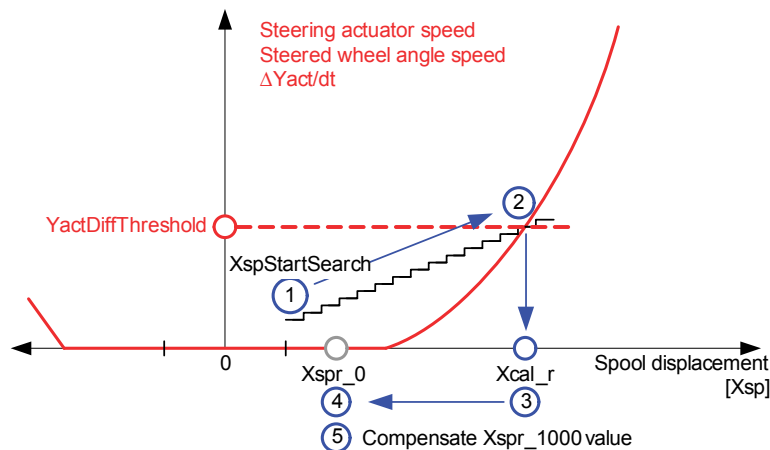

1. The main spool set-point starts at **XspStartSearch**
 - $\Delta Yact$ is calculated as the difference measured in **TimeOutPeriod** ms
 - Every **TimeOutPeriod** ms, the main spool set-point is incremented by **XspIncrementSize**
 - Step 1 is repeated until step 2 becomes valid
2. The measured $\Delta Yact$ exceeds **YactDiffThreshold**
3. The current Xsp is stored and denoted **Xcal_r**
4. The open-loop dead-band parameter is calculated as **Xspr_0 = Xcal_r - XspCalibrationOffset**
 - The Xspr_0 value is written to eeprom
5. The main spool set-point where the valve outputs its nominal maximum flow, **Xspr_1000**, (see Valve transfer function) is adjusted equally to the Xspr_0 change. As an example; if the detected **Xspr_0** has shifted 10 Xsp steps towards neutral compared to the previous Xspr_0, then Xspr_1000 is shifted 10 Xsp steps as well. This maintains the transfer function slope.

The same procedure is applied to the left dead-band. When both open-loop dead-bands are calculated and written, the changes are automatically committed to eeprom. The progress through the valve auto-calibration procedure can be monitored on the CAN bus.

Operating the steering wheel during valve auto-calibration will immediately abort the valve auto-calibration process. The PVED-CL will remain in calibration mode until power is cycled.

Suggested valve auto-calibration command values

The following table shows the suggested valve auto-calibration command values for the different valve types. Other settings may be more appropriate. The optimum parameters for a particular vehicle must be found by experimentation and testing.

Suggested valve auto-calibration command values

Command parameter	EH dynamic	EH static	OSPEH	EHPS
XspStartSearch	35	50	50	130
XspIncrementSize	5	5	5	5-10
YactDiffThreshold	20	20	20	20-30
TimeOutPeriod	500	500	500	500-1000

Changing TimeOutPeriod will affect the criterion where a flow is detected. Fix the TimeOutPeriod to 500 ms or 1000 ms, and adjust YactDiffThreshold until a repeatable and robust performance is obtained.

Installation

Valve auto-calibration quick-guide

Valve auto-calibration procedure

1. Issue the start valve auto-calibration command from a MMI.
2. Monitor valve auto-calibration status messages. Optionally, enable status set 1 for detailed monitoring of the analogue wheel angle sensor signal and the spool position set-point
3. Wait for status 'auto-calibration completed'

See **StartValveAutoCalibration** and **AutoCalibrationStatus** in *PVED-CL Communication Protocol, 11025584*.

Parameter tuning order

1. Adjust XspCalibrationOffset. Use 65 as a starting reference.
2. Adjust and test valve auto-calibration command values (PVED-CL calibration mode)
See [Suggested valve auto-calibration command values](#) on page 31 for starting values.
3. Test and evaluate open-loop steering performance (operation mode)
4. Repeat step (1)2-3 until satisfactory results are obtained.
5. Adjust parameter ClosedLoopXspOffset. Use 65 as a starting reference.
6. Test and evaluate closed-loop steering performance (PVED-CL operation mode)
7. Repeat step 5-6 until satisfactory results are obtained.

The PVED-CL shall be powered-cycled after an auto-calibration before the new dead-band parameters take effect.

The PVED-CL closed-loop performance can also be evaluated in calibration mode by issuing the **SetFlow** command. To evaluate the smallest possible actuator speed, set 'Requested Flow' to ± 1 and apply 'Closed-loop flow-to-spool-position scaling'. See **SetFlow** in *PVED-CL Communication Protocol, 11025584*.

Verification of auto-calibration result stability

Check that the calibration results can be reproduced repeatedly (10-20 times) for a specific set of auto-calibration command values. The resulting parameters Xspr_0 and Xspl_0 should stay within $\pm XspIncrementSize$.

If repeatability is poor, then adjust the auto-calibration command values. Typically, YactDiffThreshold and XspCalibrationOffset are subject for tuning and needs to be increased.

Verification of the open-loop performance

Check that no unwanted steering actuator movement takes place while operating the PVED-CL in open-loop mode for e.g. variable steering ratio or joystick applications. Verify that the steering actuator is not quivering in a steady state and that the steered wheels are not moving aggressively for small steering wheel or joystick inputs. Both situations indicate no or a too small hydraulic dead-band. XspCalibrationOffset should be increased and auto-calibration is repeated.

Secondly, verify that the steering performance is symmetric in both directions i.e. that the steering actuator moves with the same speed in both directions for the same steering input in both directions.

If asymmetry is evident then a new valve auto-calibration shall be performed.

Installation

Verification of the closed-loop performance

Check that the desired steering accuracy can be obtained when using the PVED-CL in closed-loop mode such as auto-steering. The vehicle shall follow the path within the expected precision with small steering actuator movements.

If the vehicle cannot follow a path within the expected precision or deviates from the desired path, then it may be due to a hydraulic dead-band. Increase ClosedLoopXspOffset in steps of 5-10 and test until the performance is satisfactory.

If the steered wheels move aggressively and jerky while following a path in closed-loop mode, then the valve outputs too much flow for small corrections and ClosedLoopXspOffset shall be decreased and tested in steps of 5-10.

If there is a tendency that the vehicle deviates in only one direction in closed-loop mode, then one of the open-loop dead-bands may not be correct and a new valve auto-calibration shall be performed.

Logging and monitoring

In addition to ValveAutoCalibrationStatus, PVED-CL status set 1 can also be enabled for detailed monitoring and logging of the CAN bus traffic while the auto-calibration runs.

The below chart below shows the auto-calibration progress of an EH valve with a static main spool, fitted to a 150 HP tractor. Values from [Suggested valve auto-calibration command values](#) on page 31 are used; XspStartSearch 50, XspIncrementSize 5, YactDiffThreshold 20 and TimeOutPeriod 500.

The auto-calibration progress of an EH valve with a static main spool

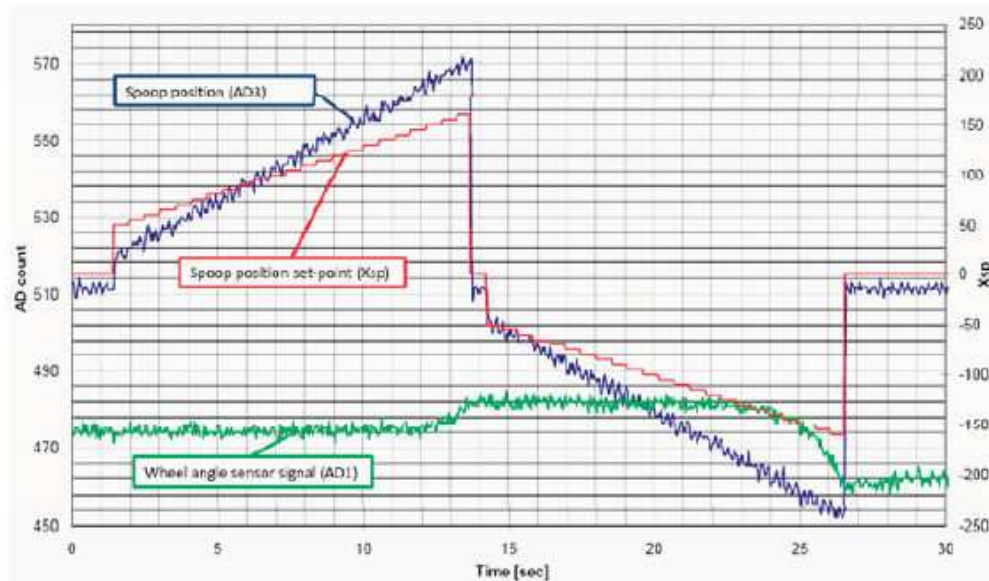

Explanation:

At 12 second the steering actuator begins to move. Around 14 seconds the actuator speed has exceeded **YactDiffThreshold** where after the algorithm proceeds to the left direction. At 26.5 seconds the actuator speed exceeds **YactDiffThreshold** and the algorithms stores the dead-band parameters and terminates.

Warning

Check for misaligned maximum spool stroke set-point parameter values: Previous auto-calibration attempts with faulty command values may have shifted the parameters Xspr_1000 and XspI_1000 to inappropriate values which may result in asymmetric flow characteristics. Ensure that Xspr_1000 and

Installation

Xspl_1000 have values close the default values (± 30) for the applied valve. See 'Xsp maximum spool displacement' in table [Valve types overview](#) on page 26.

Check for severe noise levels from the analogue wheel angle sensor: The wheel angle sensor AD noise shall not exceed ± 4 counts when observed via Status set 1 (see Status in PVED-CL Communication Protocol, 11025584). High noise levels will increase the likelihood of interpreting noise as steered wheel movement. Furthermore, repeatability may be poor.

Mapping a Steering Device

All the above mentioned functionality must be 'activated' by mapping or 'Setting Present' the individual steering devices. This means appropriate parameters must be set to the right values, as shown in the table below. This is done as mentioned in [Reading and Writing Parameters](#) on page 20.

The default settings mean a PVED-CL with power on, a CAN Steering Wheel Sensor and an analogue joystick physically connected, will not interpret any of these inputs until the mapping is done. CAN sensor messages are ignored and so are the voltage-inputs on the AD pins.

Steering Device Signals	Index	Default	Mapping Set Value
Steering wheel angle signal (Priority 1)	65101	0	0 - not present 255 - present on CAN
High priority steering device (Priority 2)	65102	0	0 - not present 1 - present at AD1 2 - present at AD2 4 - present at CAN
Low priority steering device (Priority 3)	65103	0	0 - not present 1 - present at AD1 2 - present at AD2 4 - present at CAN
Primary steered wheel (or actuator) signal	65104	0	0 - not present 1 - present at AD1 2 - present at AD2 4 - present at CAN
High priority set-point controller (Priority 4)	65105	0	0 - not present 255 - present on CAN
Redundant steered wheel sensor signal	65107	0	0 - not present 255 - present on the same interface type
Vehicle speed signal	65108	0	0 - not present 255 - present on CAN
OSP signal	65109	0	0 - not present 255 - present hydraulically

When mapping the vehicle speed sensor, the CAN source address of the vehicle speed sensor shall be configured correspondingly in the **VehicleSpeedSensorSourceAddress** parameter. See [System Parameters](#) on page 120.

Only one signal per analogue channel can be acquired

Mapping the OSP signal serves only the purpose to monitor the PVED for conflicting setpoints when steering by steering wheel using the EHPS valve with hydraulic back up. Other parameter conflicts are mentioned appendix [Program Parameters](#) on page 124.

A mapped device can be de-activated by means of sending a DeviceDisableCommand as mentioned in chapters [High Priority Steering Device Enable/Disable Control](#) on page 83 and [Low Priority Steering Device Enable/Disable Control](#) on page 103.

The High priority set-point controller can similarly be de-activated. Please refer to *PVED-CL Communication Protocol, 11025584*.

Installation

Analogue Interface

A 200 Hz first-order low-pass filter is applied before the AD sampling. Both analogue voltage signals at AD1 and AD2 are converted into a digital value between 0 and 1023 [AD full scale]. A running average filter, which takes 5 consecutive samples per 5 ms, removes high frequent noise. In case a redundant steered wheel angle sensor occupies both analogue inputs, comparison between both scaled values is made.

Block diagram of processing analogue to digital converted signals

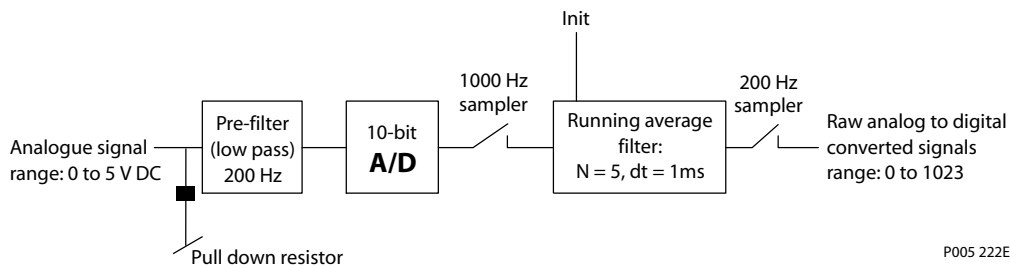

AD Signal Interface Requirements

When control signals are mapped to pin AD1 or AD2, the sampled voltage is range-checked to be between 20 and 967 [AD full scale]. These bounds are used for detecting the signal being shortcut to ground or VCC/battery power supply.

Voltage signals must always be in range in order not to trigger the signal validation monitor which results in PVED fault state or reduced state. The maximum input range which leaves margin for noise etc. is 30 to 957 [AD full scale]. As a rule of thumb, one should attempt to have 0.5 V and 4.5 V at the end-stops and approximately 2.5 V at neutral. The parameter defaults are set-up to this voltage range. A weak internal pull-down resistor will pull the input below the fault detection threshold if the input is open-circuited. The AD input impedance is > 1 MΩ.

Scaling Analogue Signals

The sampled analogue values needs to be scaled to the internal calculation domain before the signals can be applied in the software control algorithms. Scaling is a method to fully utilize the software calculation dynamic by assigning fixed calculation domain values to the equivalent analogue values for maximum left, right and neutral and even intermediate values if desired. Scaling is done by sample value to calculation domain transfer characteristics. Two different transfer characteristics are available for each AD input.

Linear Transfer Characteristic (3-Point)

Linear transfer characteristic is suitable for sensors with a known characteristic such as joysticks and mini-wheels. The transfer characteristic orientation depends on the sensor mounting orientation (both cases are shown below).

Installation

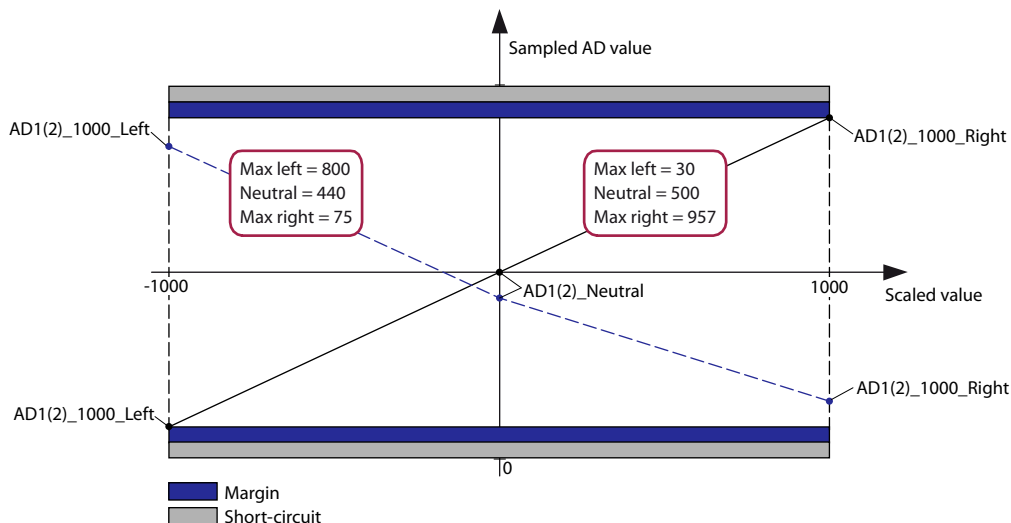

Symbol	Index	Default	Value range
AD1_1000_Left	65080	100	[30;957]
AD1_Neutral	65086	500	
AD1_1000_Right	65083	900	
AD1_Linear	65087	255	0 (Non-linear), 255 (Linear)
AD2_1000_Left	65089	100	[30;957]
AD2_Neutral	65095	500	
AD2_1000_Right	65092	900	
AD2_Linear	65096	255	0 (Non-linear), 255 (Linear)

- When building a transfer characteristic, the characteristic shall be monotonically increasing or decreasing. An attempt to build illegal characteristics is not possible.
- AD values for Neutral shall be between the AD values for left and right.

Non-Linear Transfer Characteristic (5-Point)

A non-linear transfer characteristic is suitable in situations where a sensor output is non-linear due to e.g. sensor mounting geometry.

Scenario

Applying a linear transfer characteristic (3-point) to a non-linear steered wheel angle sensor in a closed-loop application (auto-guidance or GPS) may result in incorrect steered wheel positions for set-points not equal to neutral or the end-positions. Furthermore, the steered wheel angle may not be symmetrical around neutral. The effect of non-linearity may become apparent in auto-steering applications where a vehicle shall drive in precise circles.

In general, it is recommended to have “an as linear as possible” relation between the steered wheel angle and the steered wheel angle sensor. This can be achieved by clever mechanical sensor mounting. However, it may not always be possible to achieve linearity mechanically. To electronically compensate for a non-linear sensor characteristic, two extra points are included in the calibration.

The two extra points represents the steered wheel angle, where the steered wheel is precisely in between neutral and right or left end-stop respectively.

Installation

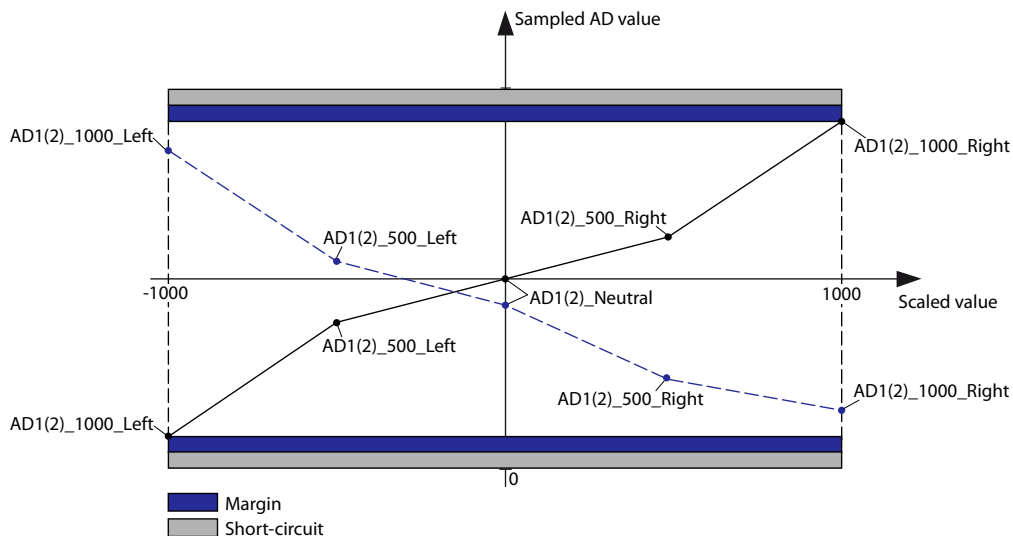

Symbol	Index	Default	Value range
AD1_1000_Left	65080	100	[30;957]
AD1_500_Left	65055	300	
AD1_Neutral	65086	500	
AD1_500_Right	65062	700	
AD1_1000_Right	65083	900	
AD1_Linear	65087	0	0 (Non-linear), 255 (Linear)
AD2_1000_Left	65089	100	[30;957]
AD2_500_Left	65069	300	
AD2_Neutral	65095	500	
AD2_500_Right	65076	700	
AD2_1000_Right	65092	900	
AD2_Linear	65096	0	0 (Non-linear), 255 (Linear)

- When building a transfer characteristic, the characteristic shall be monotonically increasing or decreasing. An attempt to build illegal characteristics is not possible.
- AD values for Neutral shall be between the AD values for left and right.

Steering Actuator Position Signal

The steering actuator position signal can be mapped to either AD1 or AD2. Scaling parameters Max left and Max right are set respectively equal to the digital converted voltage at the left and right end-lock position. The third parameter “Middle” is normally set equal to the digital converted voltage when the steering actuator is set in the straight forward driving position.

The default values meet most analogue sensors with standard 0.5 to 4.5 signal span.

Analogue Input Drift Compensation

A radiometric compensation algorithm has been implemented to ensure robustness of the checks even in situations where the Vext-supply voltage fluctuates from 4.80 to 5.20 V DC. Range checking is done on

Installation

the compensated value. Compensation is only required for analogue sensors without built-in compensation - hence sensors whose output is directly depending on the Vext-supply supply voltage.

The objective is to reduce the risk of drift in calibration value as a result of aging or temperature of the electronic circuits. To select compensation in PVED-CL or not, use parameter **AnalogChannelCompensation**.

Compensation can be applied to either input or both of them.

Symbol	Index	Default	Value range
AnalogChannelCompensation	65098	0	0=None, 1=AD1, 2=AD2, 3=Both AD1 and AD2

Transmitting the Voltage Readings on CAN

In order to calibrate the AD inputs from steering devices or steering actuator position signals, the read AD value shall be echoed back to user via the CAN bus.

Sending a **StartStopStatus** status set 1 message will invoke the PVED-CL to send out a status message with data [AD1][AD2][AD3][Xsp]. AD1 and AD2 are the analogue PVED-CL interface ports. AD3 is the spool position reading. Xsp is the spool set-point calculated by the PVED-CL.

Steering Device Transition

Steering Device Transition

The PVED-CL allows steering with electric signals from more than one steering device. Every 50 ms, the PVED sequentially monitors all mapped steering device signals according to their priority.

It selects one of steering devices based on:

- the amount of signal change detected in the steering signal per time unit and
- the current in [System State](#) on page 20. When the steering signal change per time unit exceeds a user-defined threshold, it is considered as a request to steer the vehicle with that particular steering device.

The system state is used to ensure:

- Smooth transition from one to another device by requiring the valve spool to be inside or near the valve dead-band.
- Reach-ability of the closed-loop control by demanding the steering actuator to be within the control region of the closed-loop controller (if closed-loop control is applied).
- Safe transition to a steering device, and hence program by only allowing this change at vehicle speeds equal to or lower than the threshold value defined in [Program Transition Control](#) on page 20 provided that a vehicle speed signal is present.

When all above criteria are fulfilled, the steering device is selected and the associated steering control principle is applied. If no steering device fulfils the criteria the previous selected device remains. On power up, all devices are normally in their rest position, which means that no device is selected. The magnetic valve is disabled while no device is selected.

Threshold Definition

To determine if a steering device exceeds its defined threshold, two parameters shall be defined for each applied steering device namely the maximum steering motion speed and the steering motion threshold. The threshold is defined as a percentage of the maximum steering motion speed.

Define the Maximum Steering Motion Speed

The fastest steering input is defined as the time in ms to change the input signal from its minimum to its maximum value or visa versa, hence the value corresponding to 100%. This means e.g. the minimum time required to make one full turn for the steering wheel, one full movement left to right on the joystick, etc.

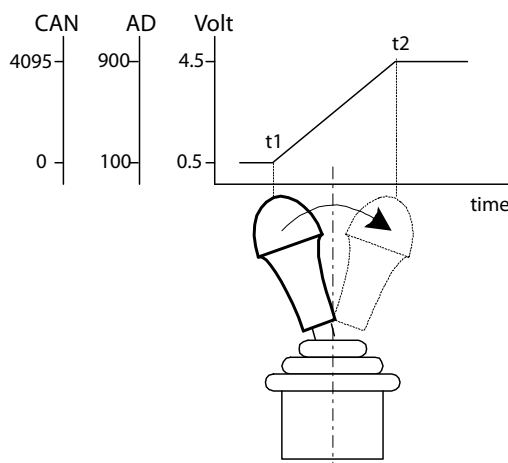

Example: How the maximum signal change is carried out

Device	Index	Default	Value range
Steering by steering wheel	111	500	500 – 750 (120 to 80 rpm)
Steering by High priority steering device	311	200	150 – 450

Steering Device Transition

Example: How the maximum signal change is carried out (continued)

Device	Index	Default	Value range
Steering by Low priority steering device	411	200	150 – 450
Steering by High priority external set-point controller	511	200	10 – 2000

Changes to parameters of non-present steering devices have no effect.

Define the Steering Motion Threshold

The steering motion threshold represents a percentage of the maximum steering motion which is defined for each steering device. This means for the PVED-CL to detect a steering request on a new steering device, the input on this device shall happen faster than the defined threshold speed.

The default values are a compromise between a quick respond to steering inputs and avoiding unintentional transitions due to noise that might be present in the steering signal.

Device	Index	Default	Value range
Steering by steering wheel	119	50	0 – 200 (0.00 to 20.0 % of max. activation speed)
Steering by High priority steering device	319	100	0 - 200
Steering by Low priority steering device	419	100	0 - 200
Steering by High priority external set-point controller	519	100	0 - 200

Changes to parameters of non-present steering devices have no effect.

Thresholds equal to zero auto-selects the device whenever a device of higher priority enters the non-active state.

Thresholds near zero could cause unintentionally transitions due to noise in the input signals.

No priority is given to higher priority devices when steering within the non-active operation state.

Once a steering device has been selected for steering it will be active until another steering device meets the criteria for being selected for steering.

Steering Wheel Sensor Noise Gate

Retrieving Steering Device Information

The PVED-CL continuously transmits status information on which steering devices is mapped in the system and their present state. Refer to **OperationStatus** in *PVED-CL Communication Protocol, 11025584*.

Steering Wheel Sensor Noise Gate

Noise from the SASA sensor may be a result from sampling noise on the least significant bits or mechanical vibrations causing small steering wheel movements. Regardless of the cause, the noise in the SASA message data may propagate though the PVED-CL and show itself as small pressure build-ups or small wheel movements. This high SASA sensitivity is desired for high controllability and good response to slow steering wheel movements whereas it is less desired when the steering wheel is not activated.

A compromise can be achieved by setting up the steering wheel sensor noise gate to filter out small steering wheel data changes after some specified time with no steering wheel activation.

StwDxFILTERThreshold parameter defines the steering wheel angle over time threshold, where a 'no steering wheel activation' confidence timer is incremented. Any steering wheel activation which results in a steering wheel angle/dt higher than StwDxFILTERThreshold will reset the timer.

StwDxFILTERStartTime parameter defines the time in ms that the 'no steering wheel activation' confidence timer shall reach before the noise gate will floor any steering wheel input to 0. As long as the confidence timer is below StwDxFILTERStartTime, all steering wheel inputs will pass the noise gate.

Device	Index	Default	Value range
StwDxFILTERThreshold	64020	2	0,1: Disable filtering [2 ; 4095]: dPosition/dt
StwDxFILTERStartTime	64021	0	0: filter always enabled [0; 65515]: Time in ms [65516 ; 65535]: Disables the timer

Example:

Analyzing the SASA data while the steering wheel is not activated, shows that the position change fluctuates ± 2 peak-peak. Converted to steering wheel rpm, this corresponds to:

$$2 \text{ ticks} \cdot (1000 \text{ ms} / 10 \text{ ms}) \cdot 60 \text{ sec} / 4095 \text{ ticks} = 2.9 \text{ rpm}$$

Where:

- 10 ms is the steering wheel position change sampling period
- (1000 ms / 10 ms) is the steering wheel position change per second
- 4095 is the position change measured in ticks for one steering wheel revolution.

To cut out any steering wheel activation below 2.9 rpm for more than 5 seconds, set **StwDxFILTERThreshold** equal to 2 and **StwDxFILTERStartTime** equal to 5000. This will allow very slow steering wheel activation below 2.9 rpm (or noise) for 5 seconds, before the noise gate cuts of the input. The values in this example are suggested starting values for a tuning process.

Steering by Steering Wheel – Open Loop

Steering by Steering Wheel – Open Loop

EHPS Type 2 System Diagram

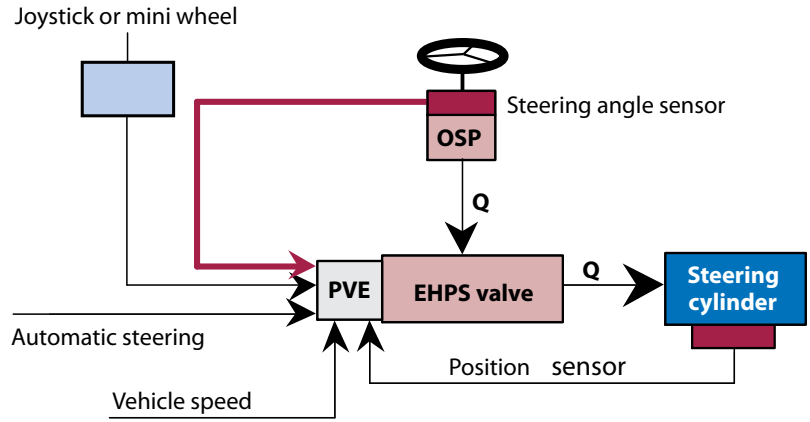

P005 225E

Acquire the Signals

See [Mapping a Steering Device](#) on page 34 on how to map the steering wheel sensor and steering wheel angle sensor.

Functionality Tree

The tree below illustrates the functionality available in the PVED-CL for open-loop steering wheel steering. The manufacturing default is found by following the red line. Following the instructions in this chapter can of course modify it. The switches in the tree are used to select the functionality required. In case different functionalities are required, the EHPS software provides multiple programs for each steering device.

Steering by Steering Wheel – Open Loop

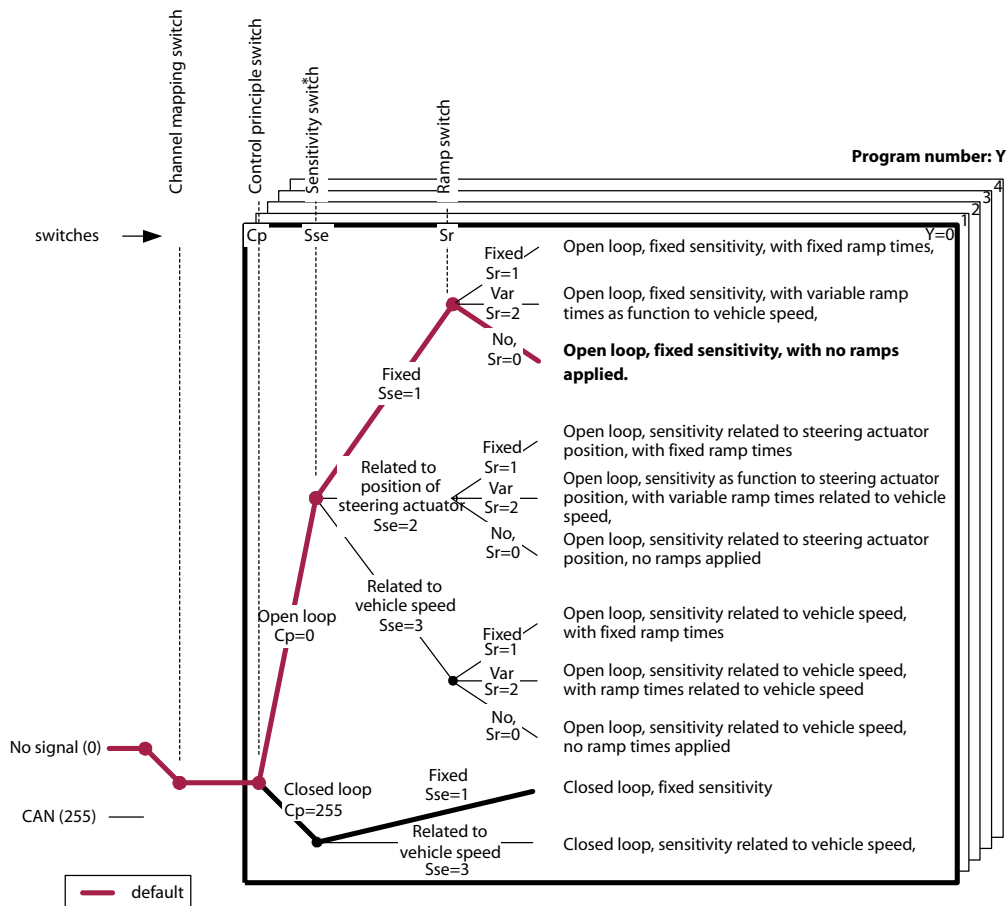

* Sensitivity means: number of revolutions on steering wheel from lock to lock

P005 202E

Open Loop Control

Open loop steering shall be chosen for implementing variable steering ratio or when sideward forces on articulated steered vehicles must be actively reduced.

Block diagram oped loop steering wheel steering

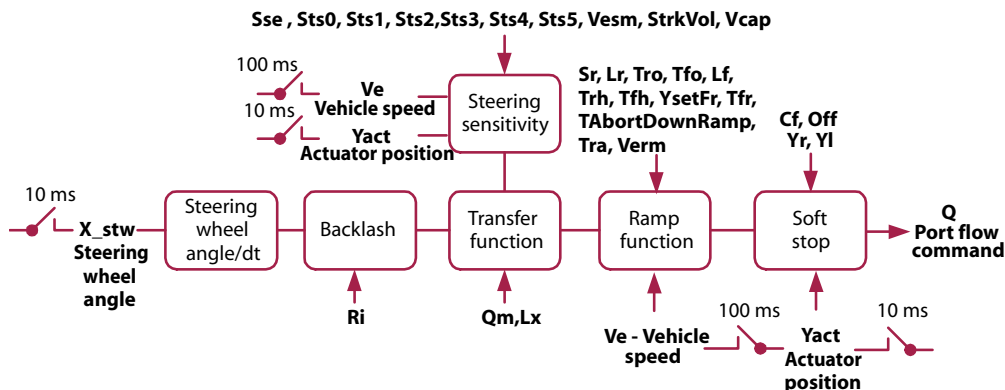

P005 206E

Select the Control Principle

Cp is used to select Open loop control for steering wheel steering by setting parameter index 1y02 equal to 0. Parameter selection values: Y selects the program and ranges from 0 and 9.

Steering by Steering Wheel – Open Loop

Apply Backlash

Ri If elasticity affects the sensor readings when the driver releases the steering wheel and hereby unintentionally operates the valve, a backlash region (R_i) can be applied to prevent it. The size of the backlash region is normally set equal to the angle related to elasticity.

However, any set-value greater than zero leads to slower steering responds. Therefore, to minimize these effects, the steering wheel, sensor shaft and underlying mechanics as shown below must be designed as stiff as possible.

Since this parameter only effects changes in the set point, stability problems in closed loop are not related to the set-value of this parameter.

The default value does not remove elasticity effects.

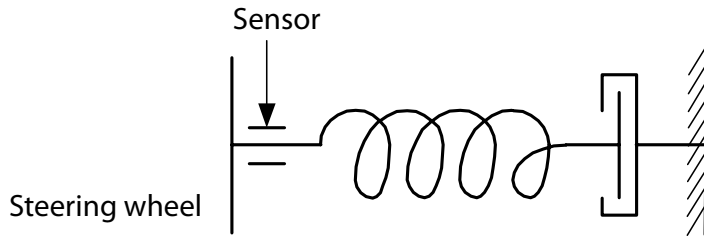

Symbol	Index	Default	Value range
R_i	1y04	0 to 5	0 to 200

0 means 0 degrees backlash, 200 means ~17 degrees backlash. Backlash applies in both steering directions; therefore the total backlash region is twice the threshold.

Set-point Transfer Function

The transfer function provides two parameters to transform steering wheel positional information to port flow. Its main function is to create the flow request set-point from the steering wheel sensor.

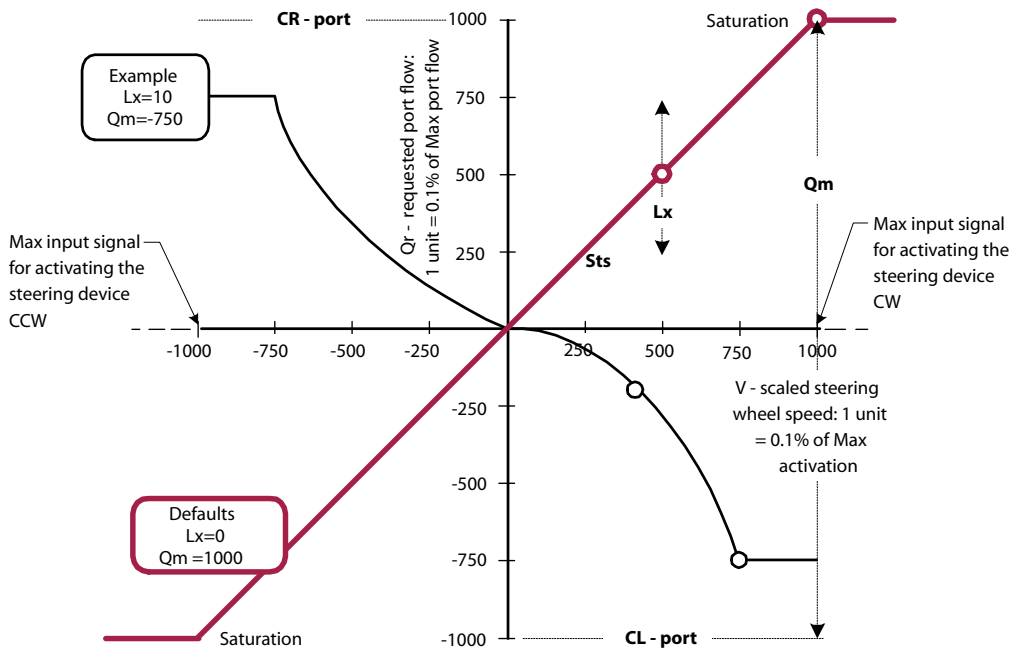

L_x affects the inherent linearity between steering actuator speed and steering wheel speed. The set value affects the linearity of a second order function. Increase L_x to achieve slower cylinder speed at low

Steering by Steering Wheel – Open Loop

steering wheel RPMs and consequently higher cylinder speeds at higher steering wheel RPMs. The default value gives a linear relationship between steering wheel RPM and cylinder speed.

Qm sets the maximum port flow. It defines the maximum achievable cylinder speed for steering left and right. The default value is set to maximum flow and thus dependent on the maximum flow of the applied valve.

Symbol	Index	Default	Value range
Lx	1y06	0	-10 max regressive, 0 (linear) to 10 (max progressive)
Qm	1y27	1000	0 to 1000 (100% flow at CL or CR port)

Steering Sensitivity

Sensitivity is set individually for each program and can be either fixed or variable. Sensitivity can depend on vehicle speed, steered wheel position, or change of current device program. Using variable sensitivity can increase comfort and controllability significantly, and depending on the vehicle type and use, the appropriate way to achieve the change might be different. The PVED-CL allows 10 different programs for the steering wheel steering with different sensitivity settings. Each program can be applied via the MMI while driving. Each program can then use either fixed or variable sensitivity – hence we talk ‘second-order-variability’ by using the PVED-CL.

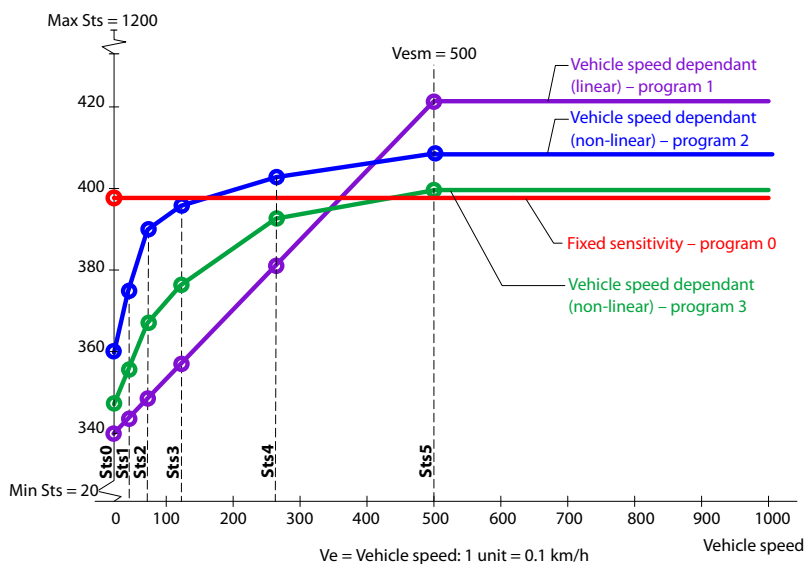

A note on variable steering ratio:

In systems with an EHPS valve, the sensitivity settings yield equivalent steering ratio results on the physical steering system.

In systems with an EH valve, the software does not take the parallel flow contribution from the OSP into account. Unless compensated for, the resulting steering ratio on the physical steering system will be lower than expected. To compensate, increase the sensitivity parameters and optionally limit the maximum flow (Qm) to achieve the desired steering ratio for the used steering programs.

Select a Fixed Sensitivity

Vcap holds information about the actual valve capacity. This information is needed by the software to achieve the desired sensitivity.

StrkVol holds information about the actual stroke volume (cylinder size). This information is needed by the software to achieve the desired sensitivity.

Sse selects between a fixed steering sensitivity, variable to steering actuator position or vehicle speed. Set Sse to 1 to select the fixed sensitivity

Steering by Steering Wheel – Open Loop

Sts0 defines the fixed steering ratio. This value shall be set large enough to provide sufficient directional stability at all vehicle speeds. The default value is set to a commonly applied steering ratio.

Symbol	Index	Default	Value range
Vcap	706	25	5 to 120 (l/min)
StrkVol	707	600	100 to 8000 (cm3)
Sse	1y09	1	Must be set at 1
Sts0	1y10	400	20 to 1200

A steering ratio of 400 equals to 4.00 steering wheel turns to move the steering actuator from YL to YR (left to right end-lock position)

Select a Sensitivity with Relation to Actuator Position

A variable steering sensitivity related to actuator position is normally chosen for increased controllability for straightforward driving (for e.g. material handling applications). The correlation between steering wheel movements and the cylinder position is normally closely related to the mechanical geometry between steering actuator and steered wheels of the individual vehicle.

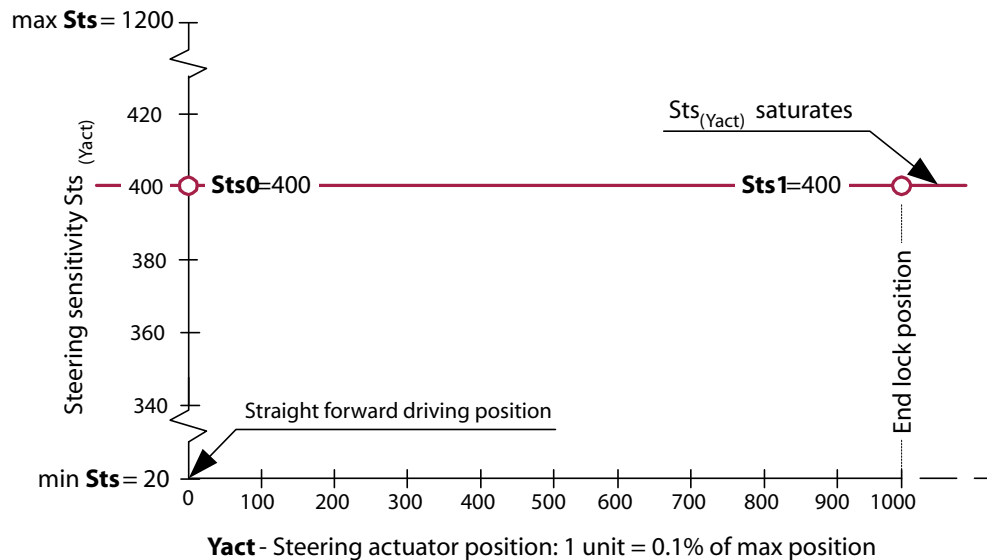

P005 091E

The correlation is defined by two parameters. The steering sensitivity between two table coordinates is found by linear interpolation. The functionality is symmetrical around neutral.

Vcap holds information about the actual valve capacity. This information is needed by the software to achieve the desired sensitivity.

StrkVol holds information about the actual stroke volume (cylinder size). This information is needed by the software to achieve the desired sensitivity.

Sse selects between a fixed steering sensitivity, variable to steering actuator position or vehicle speed. Set Sse to 2 to select the sensitivity related to steering actuator position.

Sts0 sets the linear gradient between steering angle and requested port flow for steering straight forward. When the steering actuator signal unintentionally is not mapped, Sts(Yact) will be equal to Sts0, since variable Yact remains 0.

Sts1 sets the linear gradient between steering angle and requested port flow for steering at with the minimum turning radius.

Steering by Steering Wheel – Open Loop

Symbol	Index	Default	Value range
Vcap	706	25	5 to 120 (L/min)
StrkVol	707	600	100 to 8000 (ccm)
Sse	1y09	1	Must be set at 2
Sts0	1y10	400	20 to 1200
Sts1	1y11		

See [Mapping a Steering Device](#) on page 34.
 Steering actuator Sensor (feedback from vehicle wheels)
 Steering actuator position to acquire "steering actuator position".

Select a Sensitivity with Relation to Vehicle speed

Variable steering sensitivity related to vehicle speed is normally used to optimize steering controllability at higher driving speeds. The parameter values and correlation is normal closely related to the present vehicle dynamics of the individual vehicle model.

The correlation is defined by seven parameters. All Sts-parameters may be set equal to each other or monotonically increasing for higher vehicle speeds. The steering sensitivity between two table coordinates is found by linear interpolation. The relation is equal for negative speeds.

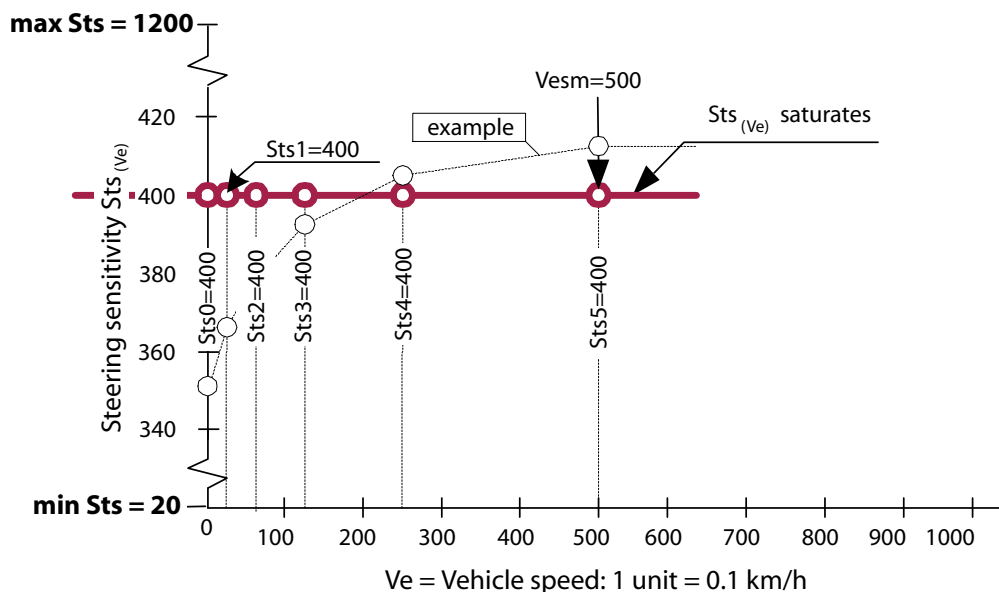

P005 204E

Vcap holds information about the actual valve capacity. This information is needed by the software to achieve the desired sensitivity.

StrkVol holds information about the actual stroke volume (cylinder size). This information is needed by the software to achieve the desired sensitivity.

Sse selects between a fixed steering sensitivity, variable to steering actuator position or vehicle speed. Set **Sse** to 3 to select the sensitivity related to vehicle speed.

Sts0 sets the steering ratio when the vehicle is standing still. **Sts0** applies at all times when the vehicle signal unintentionally is not configured as PRESENT (Ve remains 0). In case the vehicle speed signal is not diagnosed, it is recommended to set **Sts0** at a value where sufficient directional stability at maximum vehicle speed is present. The default value is set to a value which yields good controllability at high vehicle speeds.

Sts1 sets the steering ratio when the vehicle is driving at 6.25% of $Vesm$.

Steering by Steering Wheel – Open Loop

Sts2 sets the steering ratio when the vehicle is driving at 12.50% of Vesm.

Sts3 sets the steering ratio when the vehicle is driving at 25.00% of Vesm.

Sts4 sets the steering ratio when the vehicle is driving at 50.00% of Vesm.

Sts5 sets the steering ratio when the vehicle is driving at 100.00% of Vesm.

Vesm sets the region where steering sensitivity is variable to vehicle speed. The default value is set at the maximum speed of most applications.

Symbol	Index	Default	Value range
Vcap	706	25	5 to 120 (L/min)
StrkVol	707	600	100 to 8000 (ccm)
Sse	1y09	1	Must be set at 3
Sts0	1y10	400	20 to 1200
Sts1	1y11	400	Sts0 to 1200
Sts2	1y12	400	Sts1 to 1200
Sts3	1y13	400	Sts2 to 1200
Sts4	1y14	400	Sts3 to 1200
Sts5	1y15	400	Sts4 to 1200
Vesm	1y16	500	1 to 1000 (0.0 to 100.0 km/h)

Please note the parameter dependency of Sts. Steering sensitivity of 400 equals to 4.00 steering wheel turns to move the steering actuator from YL to YR (left to right end-lock position) See chapters [Mapping a Steering Device](#) on page 34 and [J1939 Diagnostic Interface](#) on page 115 to acquire vehicle speed.

Ramps (Anti-jerk)

Ramps are normally used to minimize jerk forces in machines with articulated steered steering systems. In these steering systems, the articulating masses can be instantly stopped by closing the valve oil flow. An instant cylinder movement stop starts the articulating masses to oscillate until all kinetic energy is dispatched into heat by the shock valves or by the friction between wheels and ground. Jerk is an inherent characteristic of articulated steered vehicles and cannot be completely removed. However, it is best minimized when the forces are monotonically reduced in magnitude.

To achieve this, the EHPS software provides linear or non-linear ramps which in effect creates an orifice across the main spool to tank by holding the valve open near its closing position until all kinetic energy is dispatched into heat for some time. Ramps work on the valve spool set-point.

Ramps with Fixed Ramp Times

Sr sets the method. The ramp times can be disabled, fixed or related to vehicle speed. Set Sr to:

- 0 to select no ramps (default),
- 1 to select fixed ramp times, or
- 2 for speed dependent ramp times.

Symbol	Index	Default	Value range
Sr	1y17	0	0 (default)

The figure below shows the operation of ramps with fixed ramp times and illustrates different ramp scenarios. **Qr** is the request port flow commanded with the steering wheel. **Qramp** the ramp limited port flow and can be regarded as the result of the ramp function.

Steering by Steering Wheel – Open Loop

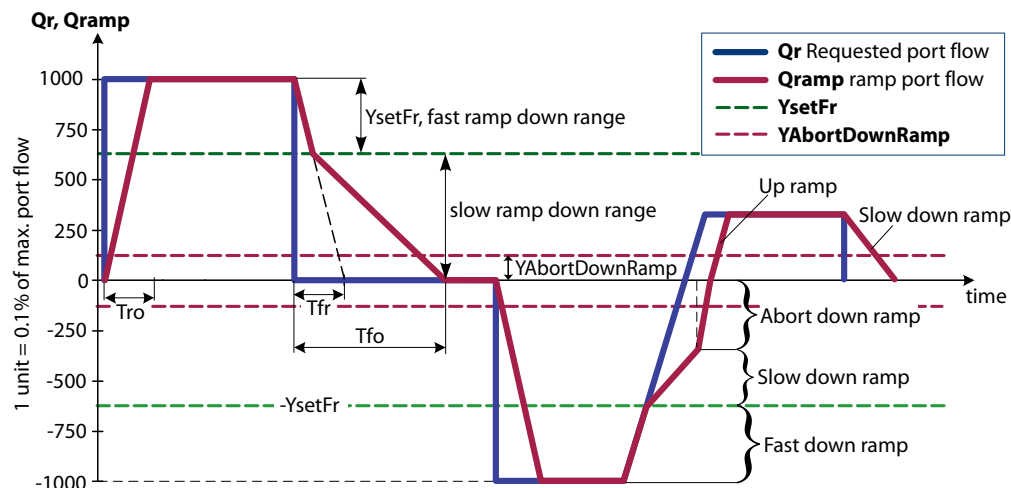

P005 205E

Sr Selects the ramp type. The ramp function can be disabled, fixed or related to vehicle speed. Set Sr to 1 to select fixed ramps.

Lr Sets the linearity of the ramp-up curve. The default value is a linear ramp.

Lf Sets the linearity of the slow ramp-down curve. The default value is a linear ramp.

Tro Sets the ramp-up time to open the valve from zero to max port flow. The time applies for both ports. To gain the best performance, the ramp-up time shall be set larger than the inherent ramp up time of the main spool. See [Technical Data](#) on page 24 for these ramp times.

Tfo Sets the ramp-down time to close the valve from max to zero port flow. The time applies for both ports. It has most effect when the ramp-up time is set larger than the inherent ramp down time of the main spool. See [Technical Data](#) on page 24 for these ramp times.

YsetFr Experience shows that ramping down from maximum flow towards medium flows do not cause as much jerk as ramping down from medium flows towards no flow (close to the valve dead-bands). In order to “expedite” the ramping at large flows, a flow range can be set up where the spool can move faster down to a flow range, where the slow down ramp is active. The overall goal with the parameter is too optimize steering response time without degrading the anti-jerk performance. Set up fast ramp down time Tfr before tuning this parameter. Setting YsetFr to 1000 eliminates the effect of the fast ramp down. Typical settings are 500-800. Use trial and error.

Example:

A value of 800 can be interpreted as allowing the spool to ramp down with a fast ramp for flow requests between maximum flow (1000) and 800/1000 of maximum flow.

Tfr This time defines the applied ramp time in the fast ramp-down range. It is defined as the ramp time from maximum flow to no flow. This means that in practice, the actual fast ramp-down time is proportional to the fast ramp-down range divided by 1000.

Use this optimization criterion: Ramp down as fast as possible for flow ranges, where jerks are not significant. Typical values are 1-50 ms. The fast ramp down time shall always be less than the slow ramp-down time. Once the value is set, it should not be adjusted anymore during further ramp parameter optimization.

YAbortDownRamp To come around the problem of slow steering response for large down-ramp times, especially if a sudden emergency change of direction is needed, a slow down-ramp can be aborted by requesting a flow in the opposite direction. Once a slow down-ramp is aborted, an abort down-ramp time, Tra is applied. Obviously Tra shall be significantly smaller than the slow down-ramp to get any effect.

Steering by Steering Wheel – Open Loop

Tra is the ramp-down time applied when the slow down-ramp is aborted. This rampdown time shall typically be much lower than the slow ramp-down time, Tfo, in order to gain any increased steering responsiveness. Typical value is half the value of Tfo or Tfh time if vehicle speed dependency is applied (Sr=2). Use trail and error.

Example:

A value equal to 500 means that the driver needs to steer out 500/1000 of maximum flow before the slow down-ramp is aborted. 500 again corresponds to a certain steering wheel RPM.

Typical values are 100-300 to have the abort down ramp possibility and to avoid unintentional abort of the down ramp due to steering wheel activation due to vibrations. Setting the value to 1000 disables the abort down ramp functionality.

Symbol	Index	Default	Value range
Sr	1y17	0	Must be set at 1
Lr	1y19	0	0 (linear) to 10 (max progressive)
Lf	1y20	0	0 to 10
Tro	1y21	1	1 to 1000 (ms)
Tfo	1y23	350	1 to 1000 (ms)
YsetFr	1y32	1000	0 to 1000 (1 unit = 0.1% of max. flow)
Tfr	1y33	100	1 to 1000 ms Tfr shall be smaller than Tfo and less than 150 ms.
YAbortDownRamp	1y34	0	0 to 500 (1 unit = 0.1% of max. flow). The default value will force an down-ramp abort at a slight reverse port flow request. Typically YAbortDownRamp needs be increased to avoid unintentional down-ramp aborts as this will infer a jerk on the driver.
Tra	1y35	1	1 to 1000 ms Ramp-down time for canceled down-ramp
The discontinuities in the progressive characteristic are located at 50, 120 and 333 ([5.0;T at 25], [12.0;T at 50] and [33.3;T at 75] of max port flow capacity)			

Select Ramps with Ramp Times Related to Vehicle Speed

Often, slow ramps are not convenient at high speeds and results in difficulties driving precise and straight. Including the vehicle speed information will allow the software to interpolate between maximum and minimum ramp times as a function of vehicle speed.

Ramp time T(Ve) is determined by interpolating between Tro and Tfo as well as Tfo and Tfh as shown in the figure below. The relation is equal for negative speeds.

Steering by Steering Wheel – Open Loop

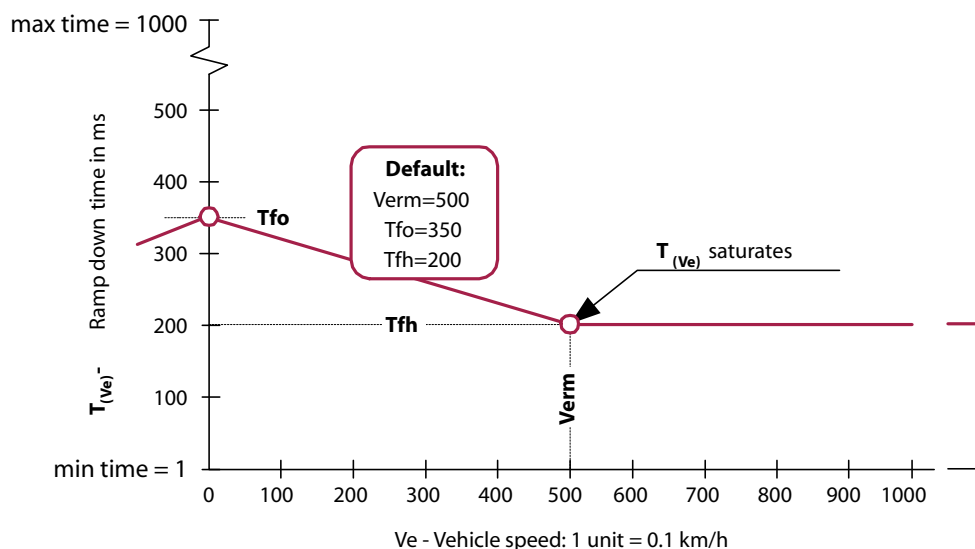
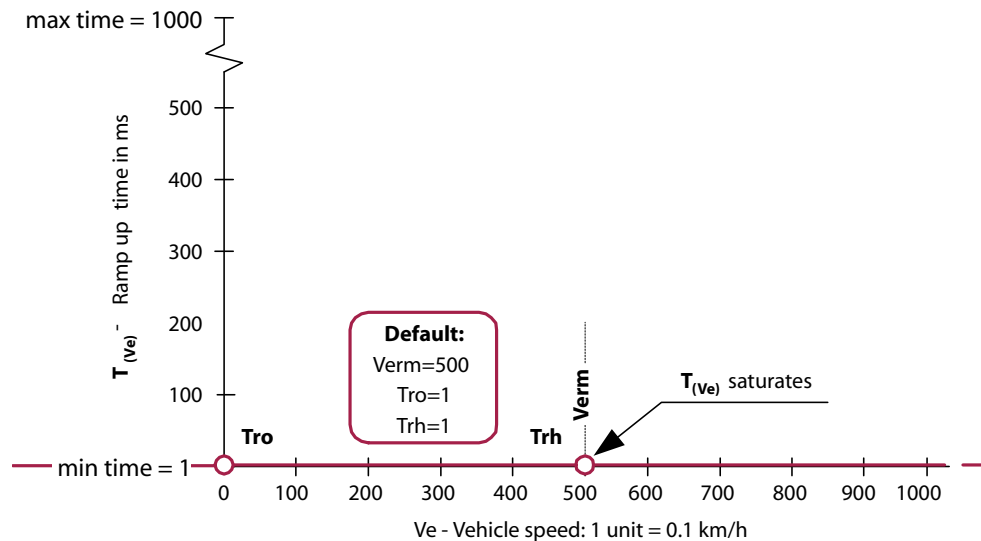

P005 220E

Sr Selects the ramp type. The ramp function can be disabled, fixed or related to vehicle speed. Set Sr to 1 to select fixed ramps.

Lr Sets the linearity of the ramp-up curve. The default value is a linear ramp.

Lf Sets the linearity of the slow ramp-down curve. The default value is a linear ramp.

Tro Sets the ramp-up time to open the valve from zero to max port flow when the vehicle speed is 0 kmph. The time applies for both ports. To gain the best performance, the ramp-up time shall be set larger than the inherent ramp up time of the main spool.

See [Technical Data](#) on page 24 for these ramp times.

Tfo Sets the ramp-down time to close the valve from max to zero port flow when the vehicle speed is 0 kmph. The time applies for both ports. It has most effect when the ramp-up time is set larger than the inherent ramp down time of the main spool.

See [Technical Data](#) on page 24 for these ramp times.

Steering by Steering Wheel – Open Loop

Trh Sets the ramp-up time to open the valve from zero to max port flow when the vehicle speed is equal to Verm kmph. The time applies for both ports. To gain the best performance, the ramp-up time shall be set larger than the inherent ramp up time of the main spool.

See [Technical Data](#) on page 24 for these ramp times.

Tfh Sets the ramp-down time to close the valve from max to zero port flow when the vehicle speed is equal to Verm kmph. The time applies for both ports. It has most effect when the ramp-up time is set larger than the inherent ramp down time of the main spool.

See [Technical Data](#) on page 24 for these ramp times.

Verm Sets the region (in kmph) where ramp-up (Trh) and ramp-down (Tfh) time is variable to vehicle speed.

YsetFr Experience shows that ramping down from maximum flow towards medium flows do not cause as much jerk as ramping down from medium flows towards no flow (close to the valve dead-bands). In order to “expedite” the ramping at large flows, a flow range can be set up where the spool can move faster down to a flow range, where the slow down ramp is active.

The overall goal with the parameter is to optimize steering response time without degrading the anti-jerk performance. Set up fast ramp down time Tfr before tuning this parameter. Setting YsetFr to 1000 eliminates the effect of the fast ramp down.

Typical settings are 500-800. Use trial and error.

Example:

A value of 800 can be interpreted as allowing the spool to ramp down with a fast ramp for flow requests between maximum flow (1000) and 800/1000 of maximum flow.

Tfr This time defines the applied ramp time in the fast ramp-down range. It is defined as the ramp time from maximum flow to no flow. This means that in practice, the actual fast ramp-down time is proportional to the fast ramp-down range divided by 1000.

Use this optimization criterion: Ramp down as fast as possible for flow ranges, where jerks are not significant. Typical values are 1-50 ms. The fast ramp down time shall always be less than the slow ramp-down time. Once the value is set, it should not be adjusted anymore during further ramp parameter optimization.

YAbortDownRamp To come around the problem of slow steering response for large down-ramp times, especially if a sudden emergency change of direction is needed, a slow down-ramp can be aborted by requesting a flow in the opposite direction. Once a slow down-ramp is aborted, an abort down-ramp time, Tra is applied. Obviously Tra shall be significantly smaller than the slow down-ramp to get any effect.

Example:

A value equal to 500 means that the driver needs to steer out 500/1000 of maximum flow before the slow down-ramp is aborted. 500 again corresponds to a certain steering wheel RPM.

Typical values are 100-300 to have the abort down ramp possibility and to avoid unintentional abort of the down ramp due to steering wheel activation due to vibrations. Setting the value to 1000 disables the abort down ramp functionality.

Symbol	Index	Default	Value range
Sr	1y17	0	must be set to 1
Lr	1y19	0	0 (linear) to 10 (max progressive)
Lf	1y20	0	
Tro	1y21	1	1 to 1000 ms

Steering by Steering Wheel – Open Loop

Symbol	Index	Default	Value range
Tfo	1y23	350	
Trh	1y22	1	
Tfh	1y24	350	
Verm	1y25	500	1 to 1000 (1 unit is 0.1 km/h)
YsetFr	1y32	1000	0 to 1000 (1 unit = 0.1% of max. flow) Fast ramp-down is active in the port flow request range 1000 to YsetFr. The default value disables fast ramp-down.
Tfr	1y33	100	1 to 1000 ms. Tfr shall be smaller than Tfo and less than 150 ms.
YAbortDownRamp	1y34	0	0 to 500 (1 unit = 0.1% of max. flow). The default value will force an down-ramp abort at a slight reverse port flow request. Typically YAbortDownRamp needs be increased to avoid unintentional down-ramp aborts as this will infer a jerk on the driver.
The discontinuities in the progressive characteristic are located at 50, 120 and 333. ([5.0;T at 25], [12.0;T at 50] and [33.3;T at 75] of max port flow capacity)			

Anti-jerk Ramp Parameter Tuning Guide

Tuning the parameters is an iterative process. The following sequence may be useful when tuning a vehicle:

1. Initial setting: Set Tro to Set Tfr to Set YsetFr to 1000. Set Tra to 1. Set YabortThreshold to 500.
2. Set the ramp-down time , Tfo, to a start value e.g. 500.
3. Decrease YsetFr from 1000 towards a smaller number. Observe which value of YsetFr where the level of jerks starts to get worse to find the flow request range, where ramping has an effect. Optionally increase Tfr to optimize on the fast ramp-down operation. Tfr should not exceed 150 ms and always be smaller than Tfo.
4. Adjust the ramp-down time, Tfo, until at good anti-jerk performance is achieved.
5. Increase the ramp-up time, Tro, to further improve the anti-jerk performance. Tro is typically smaller than Tfo.
6. Fine-tune the performance by experimenting with Tfr, Tra, and YsetFr. Note that the largest jerks shall be tuned away with the ramp-up time, Tro, and ramp-down time, Tfo.
7. Finally the YAbortThreshold and Tra may be adjusted. Consider how many steering wheel RPM is needed to abort the down-ramp. Secondly, adjust Tra to reduce the jerk when aborting the down-ramp. Obviously, Tra needs to be less than the down-ramp time, Tfo to get a faster steering response. Typical values for Tra is 50 – 100 ms.

The above typical parameter settings may vary from vehicle to vehicle.

Soft (Cushion) End-stop

To prevent the steering actuator to hit the mechanical end lock with great speed, the PVED is able to slow down the actuator speed when approaching the end lock electronically. The red line in the figure below shows how the actuator is slowed down near the end lock position. The black line in the figure below shows how port flow is reduced. The steering actuator signal must be present in the PVED for this functionality to work.

Steering by Steering Wheel – Open Loop

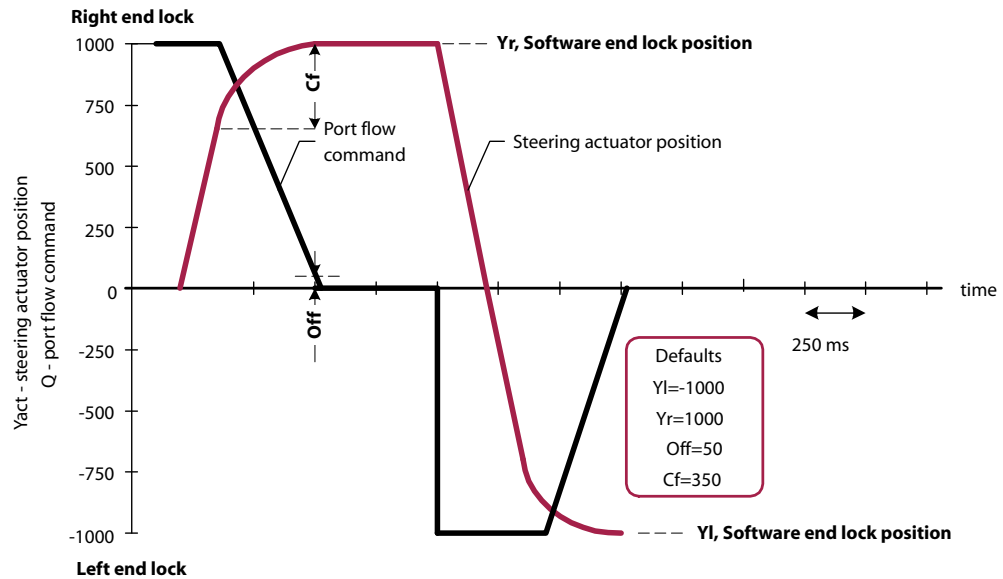

P005 221E

Yr, Yl The difference between the values of both parameter set the freedom of the steering actuator. Normally, Yr is set equal at the right mechanical end lock. Yl is normally set equal to the left mechanical end lock. For example, setting Yr at 500 and Yl at -500 reduces the freedom of the actuator by 50%. The default values for Yr and Yl are set equal to position of the mechanically end locks.

Cf Sets the region where actuation speed is slowed down. This region starts from the position defined by Yr and Yl. Making this region to small reduces or can eliminate the effect of soft stop. The default value for Cf ensures the valve is closed proportionally with actuator position.

In order to slow down in a controlled manner, the inherent shortest time for the PVED to move the spool from max open to be fully closed has to be considered. This ramp down time can be found in [Technical Data](#) on page 24.

Off This parameter sets the permitted actuation speed when hitting the end lock defined by Yr or Yl. When the steering actuator passed Yr or Yl, actuation speed will decay to zero.

The default sets a speed that allows building up pressure when the actuator is located at Yr or Yl.

Symbol	Index	Default	Value range
Yr	10y7	1000	-1000 – 1000, Values smaller than 0 will be set equal to the positive equivalent
Yl	10y8	-1000	-1000 – 1000, Values greater than 0 will be set equal to the negative equivalent
Off	1y28	50	0 to 1000 (0.0 - 100.0% of max port flow)
Cf	1y29	333	1 to 1000

See chapters Mapping Steering Signals, Steering Actuator Sensor (feedback from vehicle wheels) and Steering Actuator Position to acquire "steering actuator position".

Main Spool Dead-band Control Function

Tolsout maximum time where the main spool is allowed to be operated proportionally within the valve dead-bands. The main spool control range for this function can be seen on the [Dead-band Jump Control](#) on page 55. This function is useful to eliminate frequent spool relocating events from its neutral to its dead-band position and back (so called jumps) at low steering wheel speeds.

The flow request is 0 while moving the steering wheel within the defined steering wheel backlash range (see [Apply Backlash](#) on page 44).

Steering by Steering Wheel – Open Loop

Dead-band Jump Control

Set Tolsout lower than 21 (ms) to momentarily set the main spool in neutral as soon as the flow request is 0. No proportional main spool movement will take place. The spool will jump from neutral to either of the valve dead-bands depending on the flow request. The backlash parameter has no impact for these Tolsout values.

Dead-band Hold and Proportional Control

Setting Tolsout between 21 and 30 000 (ms) defines the maximum time where the main spool is either set on the valve dead-band or controlled proportionally within the dead-band (granted that the flow request is 0 during this time).

After a flow request to either left or right port, the main spool will be set on the respective left or right valve dead-band. Any steering wheel movement within the defined backlash region will result in proportional main spool movement as a function of the steering wheel movement. Proportional control will be allowed for Tolsout ms.

If the flow request has been 0 for Tolsout ms, the main spool will be set in neutral and any steering wheel movements within the backlash range is ignored.

To utilize proportional control, a steering wheel backlash range needs to be created. If the backlash range is set a low value, the main spool will effectively be operated as **dead-band jump control**.

Responding to Flow Requests after Tolsout

If the main spool has been set in neutral after Tolsout ms, any flow request will cause the spool to immediately jump to the relevant spool position with no initial proportional dead-band control.

Symbol	Index	Default	Value range
Tolsout	116	10 000	1 to 30 000 (ms)

Magnetic Valve Control

Magnetic valves off delay time disables the magnetic valve bridge after a time specified in ms when the flow request is 0, otherwise it remains enabled. This parameter is used when electrical energy consumption by the solenoid bridge in the PVED must be reduced or to remove a steering control conflict between the OSP and the PVED.

The default value disables this functionality i.e. the magnetic valve bridge is enabled at all times. Generally, the magnetic valve bridge is enabled when the PVED-CL receives a non-zero flow request.

Symbol	Index	Default	Value range
Magnetic valves off delay time	115	30 000	1 to 30 000 (ms)

If **Qm** is set to 0, then the magnetic valve bridge will be disabled immediately when the SASA sensor is the selected device.

Steering by Steering Wheel – Closed Loop

Steering by Steering wheel – Closed Loop

Closed loop steering by wheel steering is chosen when:

- The knob of the steering wheel must return in the same position for straight forward driving
- Accurate steering sensitivity is required
- Steering motion is required at extreme low steering wheel speeds
- Hold the steering actuator at a fixed position when steering wheel speed is zero.

Warning

Steering by steering wheel in closed loop mode shall only applied in systems with a PVED-CL and an EHPS valve. Using an OSP and an EH valve in closed-loop is not a valid configuration and will lead to unpredictable closed loop performance.

Functionality Tree

The tree below illustrates the functionality available in the PVED-CL for closed-loop steering wheel steering. The manufacturing default is found by following the red line. Following the instructions in this chapter can of course modify it. The switches in the tree are used to select the functionality required. In case different functionalities are required, the EHPS software provides multiple programs for each steering device.

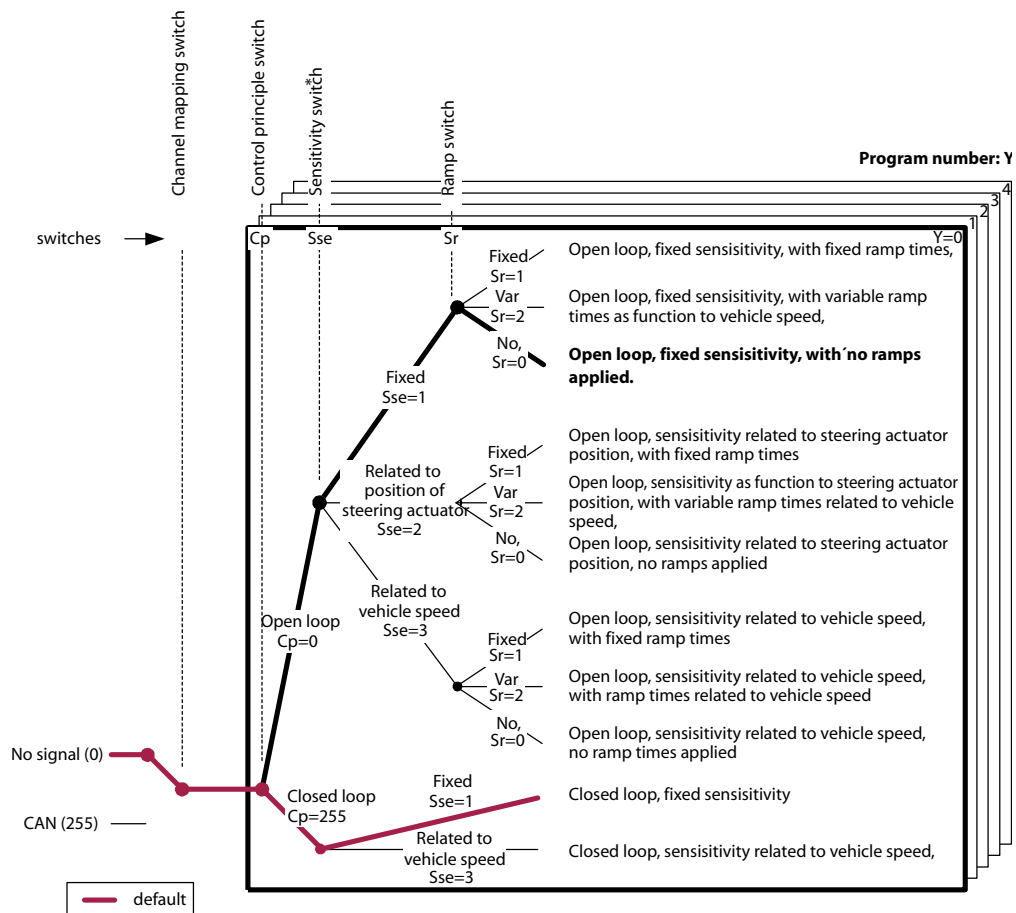

* Sensitivity means: number of revolutions on steering wheel from lock to lock

For safety reasons, an anti wind up function prevents the steering actuator to lag behind the drivers steering intends. The function is typically needed when not enough flow is supplied to the steering

Steering by Steering Wheel – Closed Loop

system at high steering wheel speeds combined with a low steering ratio or when not enough pressure is provided when the driver steers against a high resistance. Under these conditions and without effective measures it might significantly reduce the ability to steer the vehicle at higher speeds. The anti wind up function operates continuously and will limit the set point when commanded port flow exceeds the max flow capacity of the valve. These events always increase the number of steering wheel turn from lock to lock.

Block diagram closed loop steering wheel steering

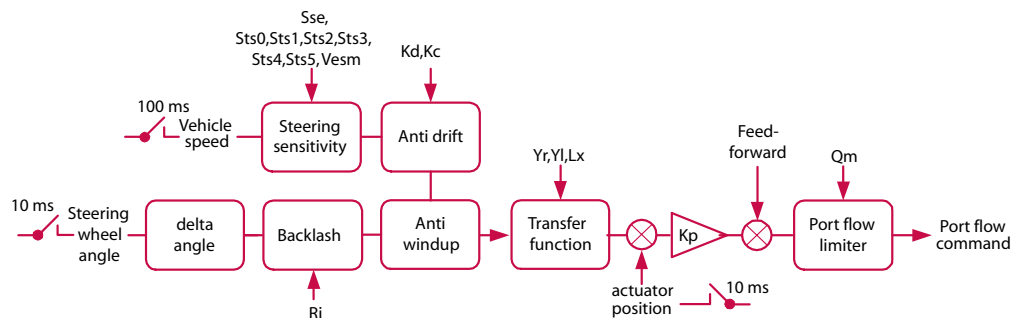

Select the Control Principle

Cp selects the closed loop control for steering wheel steering. Parameter index 1y02 must be set equal to 255. Parameter selection values: Y selects the program and ranges from 0 and 9. A fixed value of Y must be consistently used throughout the entire configuration of a single program.

Acquire the Signals

See [Mapping a Steering Device](#) on page 34 on how to map the steering wheel sensor and steering wheel angle sensor.

Apply Backlash

Ri If elasticity affects the sensor readings when the driver releases the steering wheel and hereby unintentionally operates the valve, a backlash region (R_i) can be applied to prevent it. The size of the backlash region is normally set equal to the angle related to elasticity.

However, any set-value greater than zero leads to slower steering responds. Therefore, to minimize these effects, the steering wheel, sensor shaft and underlying mechanics as shown below must be designed as stiff as possible.

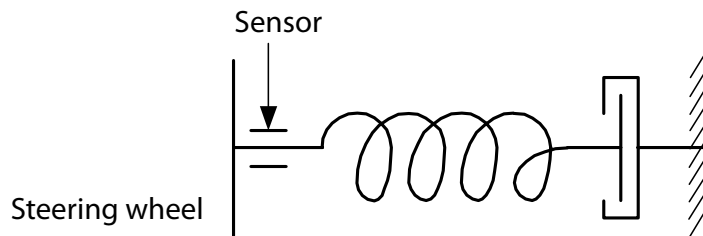

Since this parameter only effects changes in the set point, stability problems in closed loop are not related to the set-value of this parameter.

The default value does not remove elasticity effects.

Symbol	Index	Default	Value range
Ri	1y04	0	0 to 200

Steering by Steering Wheel – Closed Loop

Symbol	Index	Default	Value range
0 means 0 degrees backlash, 200 means ~17 degrees backlash. Backlash applies in both steering directions; therefore the total backlash region is twice the threshold.			

Steering Sensitivity

Sensitivity is set individually for each program and can be either fixed or variable. Variability can depend on vehicle speed or change of current device program.

Using variable sensitivity can increase comfort and drivability significantly, and depending on the vehicle type and use the appropriate way to achieve the change might be different.

The PVED-CL allows several programs for each steering device, which means that 5 to 10 different programs with different sensitivity settings can be made and applied via the MMI while driving. Each program can then use either fixed or variable sensitivity – hence we talk ‘second-order-variability’ by using the PVED-CL.

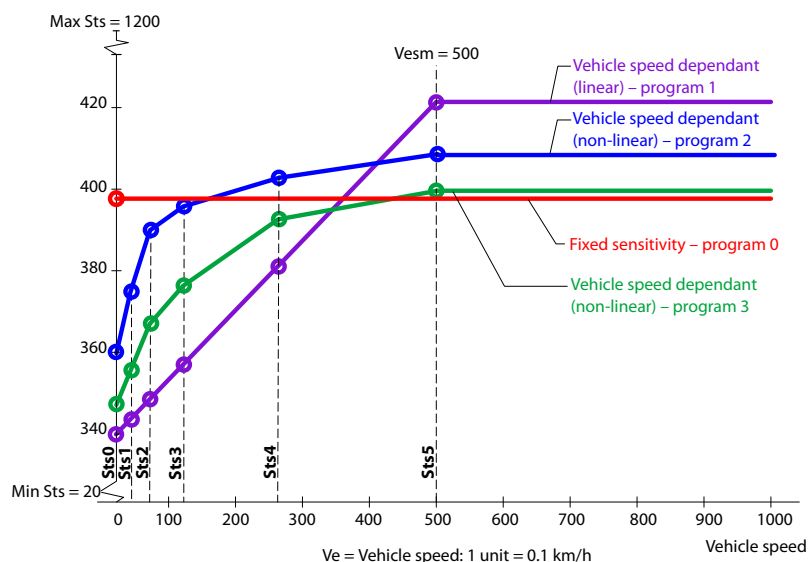

Select a Fixed Steering Sensitivity

Sse selects between a fixed steering sensitivity, variable to steering actuator position or vehicle speed. Set Sse to 1 to select the fixed sensitivity.

Sts0 set the steering ratio. This value should provide sufficient directional stability at all vehicle speeds.

The default value is set at a steering ratio most used.

Symbol	Index	Default	Value range
Sse	1y09	1	Must be set at 1
Sts0	1y10	400	20 to 1200
A steering ratio of 400 equals to 4.00 steering wheel turns to move the steering actuator from YL to YR (left to right end-lock position)			

Select a Sensitivity with Relation to Vehicle Speed

Variable steering sensitivity related to vehicle speed is normally used to optimize steering controllability at higher driving speeds. The values & correlation is normal closely related to the present vehicle dynamics of the individual vehicle model.

Steering by Steering Wheel – Closed Loop

The correlation is defined by seven parameters. All Sts-parameters may be set equal to each other or monotonically rising for higher vehicle speeds. The steering sensitivity between two table coordinates is found by linear interpolation. The relation is equal for negative speeds.

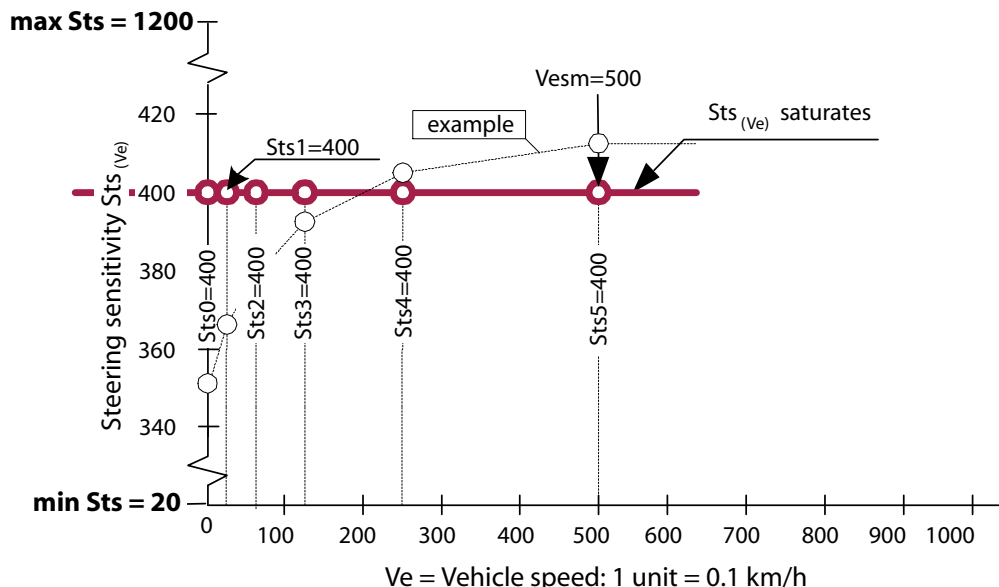

P005 204E

Variable steering sensitivity related to actuator position, is normally applied to have a higher sensitivity around neutral (driving straight) and lower sensitivity at different turning angles.

Sse selects between a fixed steering sensitivity, variable to steering actuator position or vehicle speed.

Set **Sse** to 3 to select the sensitivity related to vehicle speed.

Sts0 sets the steering ratio when the vehicle is standing still. **Sts0** applies at all times when the vehicle signal unintentionally is not configured as PRESENT (Ve remains 0). In case the vehicle speed signal is not diagnosed, it is recommended to set **Sts0** at a value where sufficient directional stability at maximum vehicle speed is present. The default value is set a value common to fast driving mobiles

Sts1 sets the steering ratio when the vehicle is driving at 6.25% of **Vesm**.

Sts2 sets the steering ratio when the vehicle is driving at 12.50% of **Vesm**.

Sts3 sets the steering ratio when the vehicle is driving at 25.00% of **Vesm**.

Sts4 sets the steering ratio when the vehicle is driving at 50.00% of **Vesm**.

Sts5 sets the steering ratio when the vehicle is driving at 100.00% of **Vesm**.

Vesm sets the region where steering sensitivity is variable to vehicle speed.

The default value is set at the maximum speed of most applications.

Symbol	Index	Default	Value range
Sse	1y09	1	Must be set at 3
Sts0	1y10	400	20 to 1200
Sts1	1y11	400	Sts0 to 1200
Sts2	1y12	400	Sts1 to 1200
Sts3	1y13	400	Sts2 to 1200
Sts4	1y14	400	Sts3 to 1200
Sts5	1y15	400	Sts4 to 1200

Steering by Steering Wheel – Closed Loop

Symbol	Index	Default	Value range
Vesm	1y16	500	1 to 1000 (0.0 to 100.0 km/h)

Please note the parameter dependency of Sts. Steering sensitivity of 400 equals to 4.00 steering wheel turns to move the steering actuator from YL to YR (left to right end-lock position) See chapters Mapping steering signals and J1939 Vehicle Speed to acquire vehicle speed.

Create the Set-point

The transfer function provides three parameters to relate a sum of scaled steering wheel angle increments to steering actuator set point position. The scaled steering wheel position is a sum of steering wheel angle increments corrected by the current applied steering sensitivity and scaled according to the operating ranges of variable Yact.

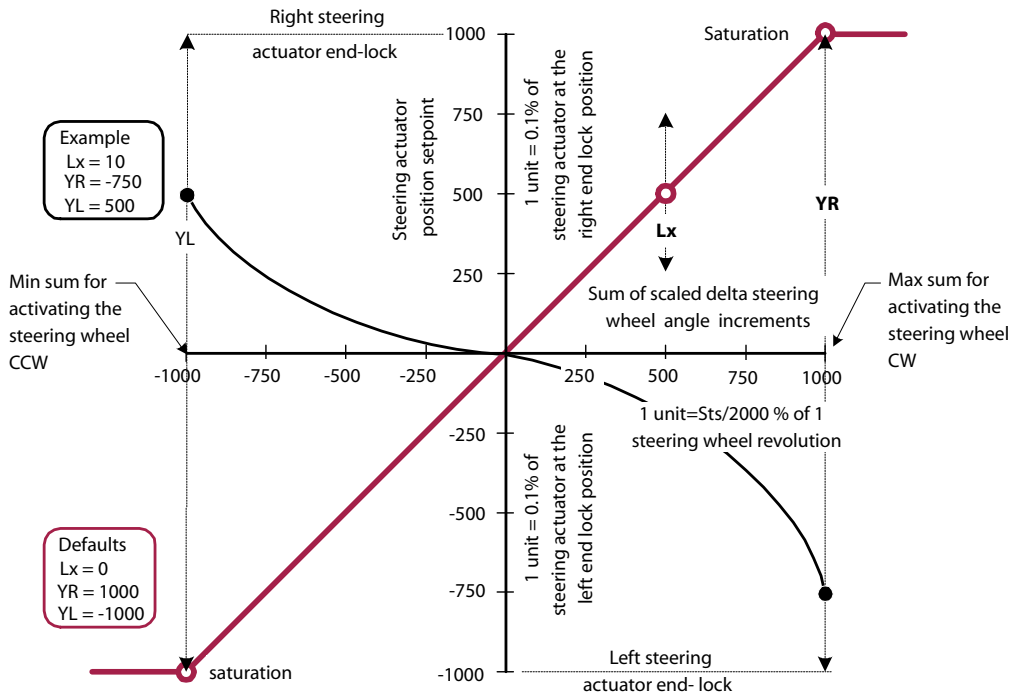

Lx Sets the curve linearity. The parameter is set down when the cylinder position is too far (over-steer) for small steering angles or vice versa. The optimum value for this parameter is closely related to the inherent linearity between steering actuator position and signal. This inherent linearity depends very much whether a linear sensor is used to detect cylinder piston position or an angular sensor at the king pin. **Lx** is typical set at zero when the cylinder piston position is detected using a linear sensor. When the king pin rotation is detected with an angular sensor at the king pin, Lx is typical set between 2 and 4.

The default value will not effect the resulting relation.

YR, YL The difference between the set values of both parameters define the freedom of the steering actuator. Normally, YR is set equal at the mechanical end lock that steers the vehicle into a right direction. YL is normally set equal to the mechanical end lock that steers the vehicle into a left direction. In case an opposite steering behavior is required, YR must be set at the negative equivalent. YL must be set at the positive equivalent.

The default value for YR and YL is set equal to the mechanical locks of the steering actuator and provides steering in the right direction.

Symbol	Index	Default	Value range
Lx	1y06	0	-10 to 10

Steering by Steering Wheel – Closed Loop

Symbol	Index	Default	Value range
YR	1y07	1000	-1000 to 1000; Yr ≠ 0
YL	1y08	-1000	-1000 to 1000; Yl ≠ 0
Lx in quadrant 1 or 4 is located at: $[500; Yr * (20 - Lx) / 40]$, Lx in quadrant 2 or 3 is located at: $[-500; Yl * (20 - Lx) / 40]$			

YR and YL may not both be zero nor have same sign.

Closing the Loop

Feed-forward

This variable is used to feed the drivers steering intends forward to the valve. It minimizes effectively lag in the steering actuator motion. The feed forward has most effect when the system responds 80 to 90% of the exact intend. This is accomplished by scaling steering wheel speed using the following parameter:

StrkVol scales the feed forward in order to get the specified number of steering wheel turns within the end-locks. It represents the stroke volume between the mechanical end-locks in cm³.

Kp must be temporarily set at zero to eliminate the closed loop contribution while tuning. Tuning is finished when the number of steering wheel turns from lock to lock is at 80 to 90 % of the turns specified. If 4 turns was specified, the number of turns should be between 4.4 and 4.8.

Steady State Error

Since the steering actuator acts as a free integral and the dead band in the valve is compensated in software, the loop does not necessarily include a second integrate term to achieve accuracy. The controller in EHPS software has therefore only a proportional term, which keeps tuning relatively simple.

To achieve steady state accuracy:

- The difference between the location of spool dead band specified in the spool compensation function in the EHPS software and the true locations should be as little as possible.
- The amount of internal leakage at all potential locations between cylinder and valve and its dependency on steering pressure should be as little as possible.
- The amount of backlash in the feedback signal. Extreme care must be taken when an actuator position sensor is installed.

The controller has proofed repeatable steady state accuracy at ± 1% of the full control region.

Proportional Band

In order to acquire open loop steering characteristics like absences of stability problems and lag, the available proportional band for the controller is variable to steering wheel speed as shown in the figure below.

Steering by Steering Wheel – Closed Loop

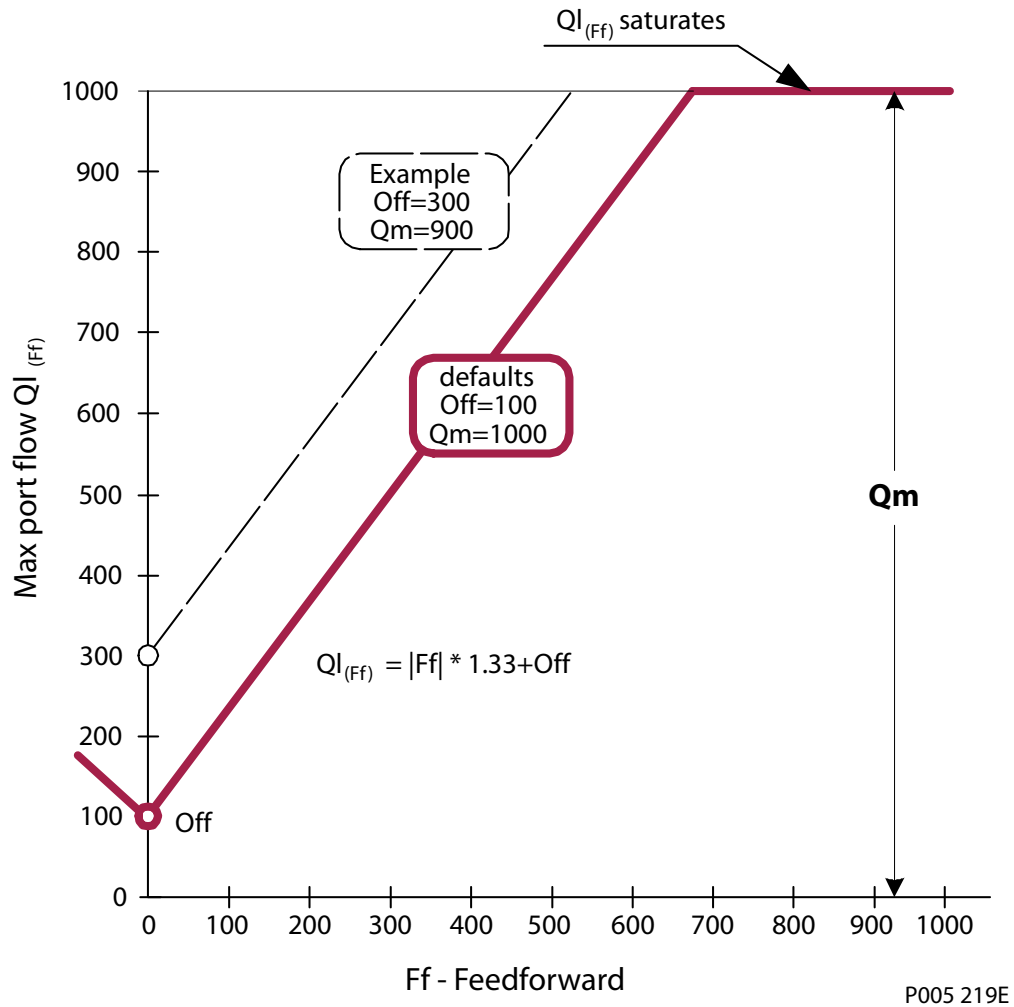

Off Sets max port flow at zero feed forward. Setting the parameter equal to Q_m disables the variable proportional band.

The default value is set at 10% of max port flow, which is sufficient to counter act disturbances in steady state and to control the steering actuator at low steering wheel speeds.

Qm Sets max port flow. It cuts-off the function and defines hereby the maximum speed of the steering actuator to approach the set point position.

Kp This parameter is closely related to valve capacity, stroke volume and amplifies the error between set-point and current position.

The optimum value for K_p is found when a non-lagging, accurate, non-oscillating steering actuation without overshoot is achieved at:

- Extreme low and high oil viscosities as specified in [Technical Data](#) on page 24.
- Low and near max steering pressure when driving at low, high vehicle speed and reversed gear. The default value fits to steering systems with a lock-to-lock time of 2 seconds at max port flow.

Symbol	Index	Default	Value range
K_p	108	50	0 to 200 (0.00 to 2.00% of port flow capacity per 0.1 % positional error)

Steering by Steering Wheel – Closed Loop

Symbol	Index	Default	Value range
Qm	1y27	1000	0 to 1000 (0.0 - 100.0% of max port flow)
Off	1y28	100	0 to 1000 (0.0 - 100.0% of max port flow)
StrkVol	707	600	10 to 8000 ccm

In order to ensure convergence, check that variable Yact is increasing for positive values of port flow. Open loop control can be used to check this. To retrieve this data, use StartStopStatus and request status data set number 2. See PVED-CL Communication Protocol. The PVED-CL will return the status data with ~ 40 ms intervals.

This function will continuously minimize the steering wheel drift that is build up and which results in misalignment of the straight direction indication on the steering wheel and the actual driving direction.

The absolute steering wheel sensor position 0 defines the straight direction. Aligning the steering wheel sensor with straight driving direction can be achieved by orienting the SASA sensor to output position 0 when the steering wheel and steering actuator are in straight position. Alternatively the SASA sensor position 0 can be programmed after physical installation. Refer to *CAN message Protocol in OSPE Steering Valve, SASA Sensor, Technical Information, 11068682*.

Steering Wheel Knob Position Control

This function relates the absolute steering wheel position to the position of the steering actuator

What makes the steering wheel drift?

- Flow & pressure saturation events that might occur during high steering wheel speeds combined with low steering ratios.
- Applying different steering ratios when driving into and out a curve. (Only when variable steering ratio is active)
- Activating joystick steering and re-activate steering wheel steering at a different actuator position from where the joystick initially was activated.

Steering wheel drift is compensated by manipulation of the present steering sensitivity (Sts).

Kd Amplifies the steering wheel drift error. The resulting value represents a request in changing the present steering sensitivity.

The default value disables the function.

Kc Limits the change in percentage of the present steering sensitivity.

The default value ensures that drift compensation is carried out beyond the notice of the driver.

Symbol	Index	Default	Value range
Kd	1y31	0	0 to 200
Kc	1y30	10	0 to 20 - > If Sts=400, Kc=10. Sts ranges from 360 to 440

Eliminate Noise due to Frequent Pressure Build-up

Eliminating noise is accomplished by stopping the controller to respond to minor deviations between set point and current actuator position.

The spool inside the valve is set in neutral when the port flow command has been within a threshold value (Qth) for a given time (Tclpout).

The spool is reactivated again when port flow command exceeds the threshold.

The default values mean that if a flow request from the controller is less than 5% of max. port flow, has occurred for 3 seconds, the spool returns to neutral.

Steering by Steering Wheel – Closed Loop

Tclpout Sets the time delay before the main spool is set in neutral.

Qth Sets the threshold value for port flow command when the controller is in steady state.

Symbol	Index	Default	Value range
Tclpout	117	3000	1 to 30 000 (ms)
Qth	118	50	0 to 100 (0.0 to 10.0 % of max port flow)

Magnetic Valve Control

Magnetic valves off delay time Disables the magnetic valve bridge after a time specified in ms when the flow request is 0, otherwise it remains enabled. This parameter is used when electrical energy consumption by the solenoid bridge in the PVED must be reduced or to remove a steering control conflict between the OSP and the PVED.

This applies to the EHPS valve, where a conflict may happen if the PVED is configured to be controlled with either CAN or analogue steering devices but not with the steering wheel angle signal. In this configuration the PVED- has no information about the steering wheel operation cannot resolve the conflict.

The default value disables this functionality i.e. the magnetic valve bridge is enabled at all times. The magnetic valve bridge is enabled when the PVED-CL receives a non-zero flow request.

Use this parameter to create EHPS type 1 configurations.

Symbol	Index	Default	Value range
Magnetic valves off delay time	115	30 000	1 to 30 000 (ms)

Steering by High Priority Steering Device – Open Loop

Steering by High Priority Steering Device – Open Loop

EHPS Type 2 System Diagram

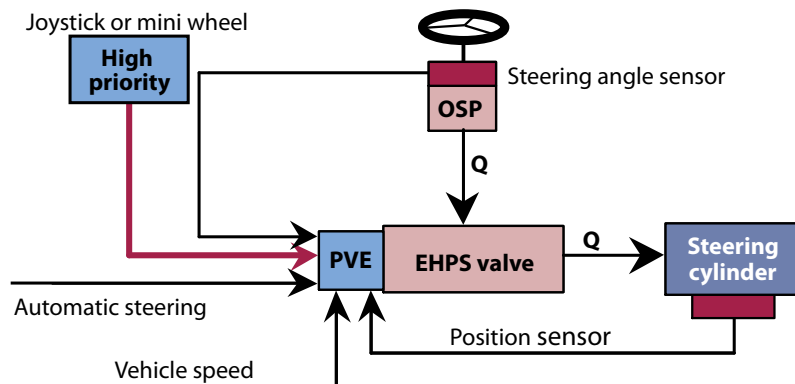

P005 225E

Functionality Tree

The tree below illustrates the availability of the PVED for steering by joystick, mini wheel with speed output or by potentiometer-like steering devices. The manufacturing default functionality is found by following the red line. Following the instructions in this chapter can of course modify the default. The switches in the tree are used to select the functionality required. In case different functionalities are required, the EHPS software provides 5 programs from which the driver can select when the system is fully operative.

Steering by High Priority Steering Device – Open Loop

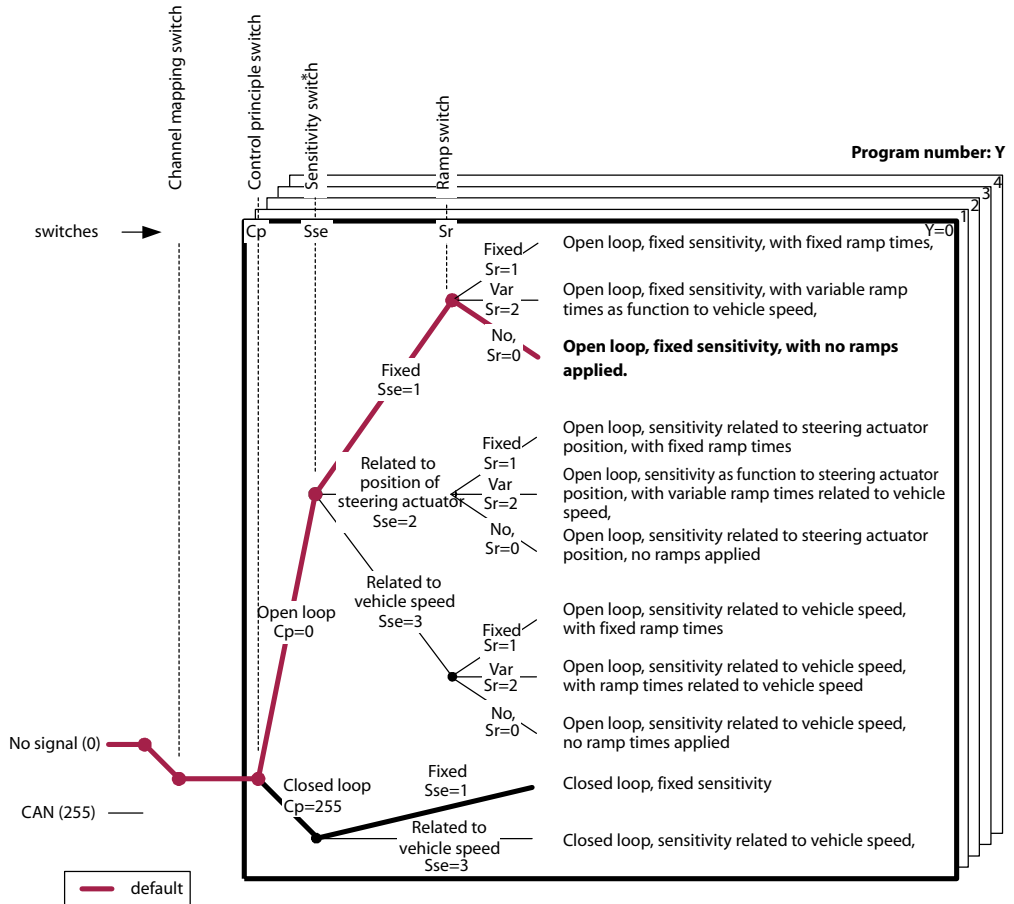

* Sensitivity means: number of revolutions on steering wheel from lock to lock

P005 202E

Select the Control Principle

The PVED-CL provides open loop control for steering devices with spring return or for steering devices with a speed output. This control principle keeps a fixed or variable relation between steering input and cylinder speed. The control loop provides several parameters to transform positional information to port flow.

Cp selects the open-loop control using parameter index 3y02 equal to 0 (default). **Y** selects the program and ranges from 0 and 9.

Steering by High Priority Steering Device – Open Loop

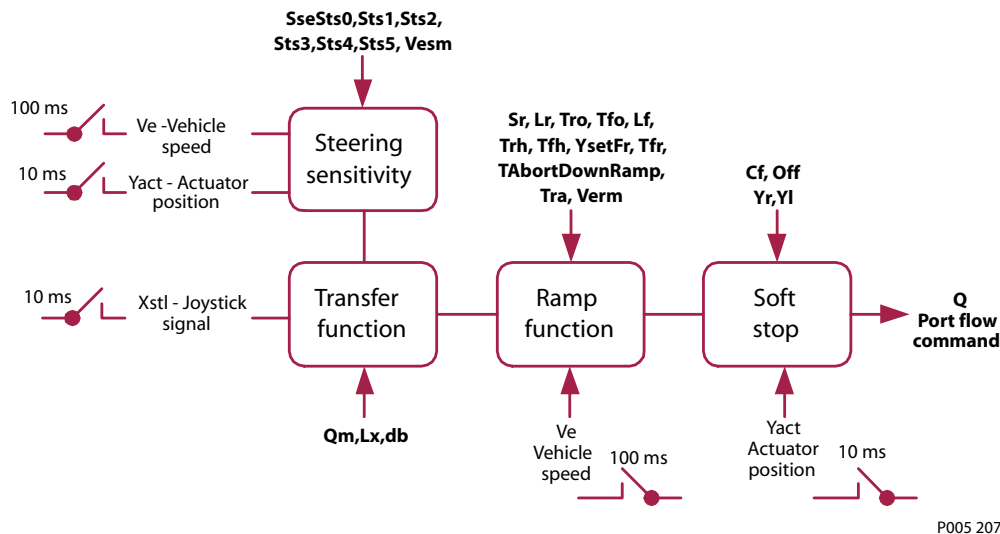

P005 207E

Acquire the Signals

See [Mapping a Steering Device](#) on page 34 on how to map the steering wheel sensor and steering wheel angle sensor.

Set-point Transfer Function

The transfer function provides 3 parameters to transfer joystick inputs signal to requested port flow.

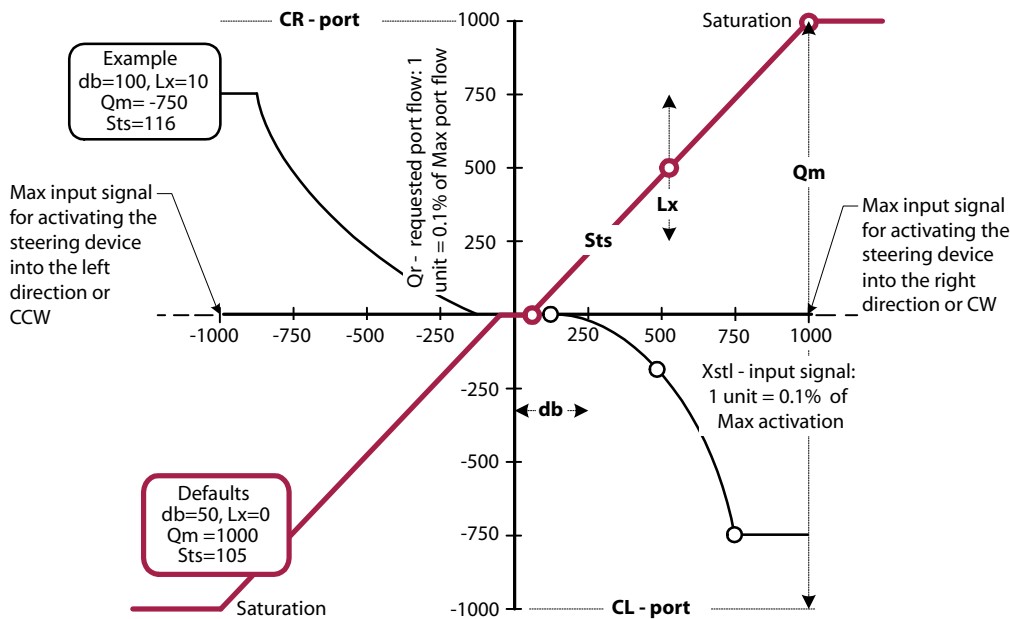

P005 210E

Db Sets a dead-band in the middle region of the steering input. It prevents self-steering caused by manufacturing deviations in the signal when the handle is in the middle or released position.

The default value is set twice the maximum deviation of most spring returned steering devices.

Lx Effect the inherent linearity between steering actuator speed and steering angle. The set value is set down when slower cylinder speed at larger steering angles is required.

Steering by High Priority Steering Device – Open Loop

The default value will not effect the resulting relation.

Qm Limits the maximum cylinder speed for steering the vehicle in the right steering direction. (See set-point transfer function above)

The default value is set equal to the inherent max port flow capacity of the valve and will therefore not have any effect.

Symbol	Index	Default	Value range
db	3y05	50	0 to 250
Lx	3y06	0	-10 (max regressive), 0 (linear) to 10 (max progressive)
Qm	3y27	1000	0 to 1000 (100% flow at CR- or CL-port

Steering Sensitivity

Sensitivity is set individually for each program and can be either fixed or variable. Variability can depend on vehicle speed, steered wheel position, or change of current device program.

Using variable sensitivity can increase comfort and drivability significantly, and depending on the vehicle type and use the appropriate way to achieve the change might be different.

The PVED-CL allows several programs for each steering device, which means that 5 to 10 different programs with different sensitivity settings can be made and applied via the MMI while driving. Each program can then use either fixed or variable sensitivity – hence we talk ‘second-order-variability’ by using the PVED-CL.

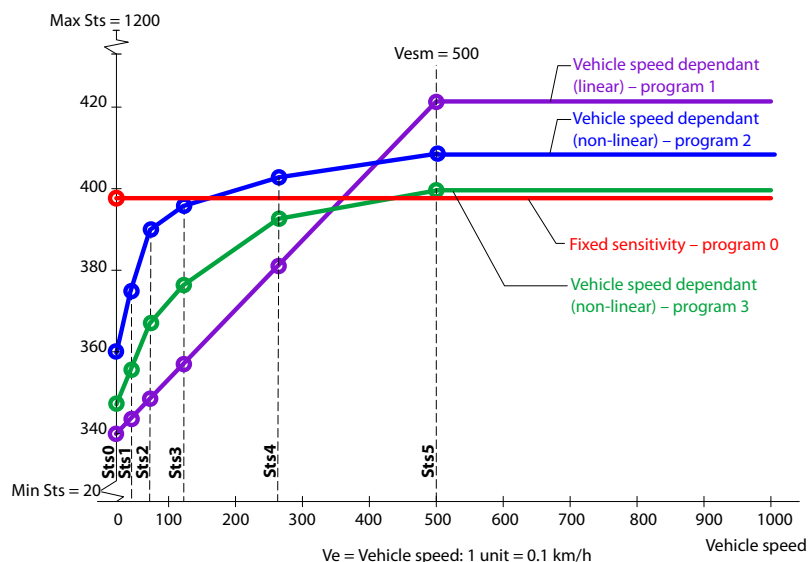

Select a Fixed Sensitivity

A fixed steering sensitivity is chosen when no cylinder position or vehicle speed signal is available on the vehicle.

Sse Selects between a fixed steering sensitivity, variable to steering actuator position or vehicle speed. Set Sse to 1 to select the fixed sensitivity.

Sts0 Sets a gradient between steering angle and requested port flow. Sts0 is normally set when max port flow (defined by Qm) is achieved at maximum steering device input. This is calculated by the following function.

$$Sts = \frac{Qm \cdot 100}{1000 - db}$$

Steering by High Priority Steering Device – Open Loop

The default value is a gradient matching maximum requested port flow to maximum port flow at the maximum steering angle.

Symbol	Index	Default	Value range
Sse	3y09	1	Must be set at 1
Sts0	3y10	105	20 to 1200 (Amplification of 0.2 to 12.00)

Select a Sensitivity with Relation to the Actuator Position

A steering sensitivity related to actuator position is normally chosen for increased directional stability for straightforward driving (material handling). The values & correlation is normally closely related to the mechanical geometry between steering actuator and steered wheels of the individual vehicle. The correlation is defined by 2 parameters. The steering sensitivity between two table coordinates is found by linear interpolation. The relation is equal for negative positions.

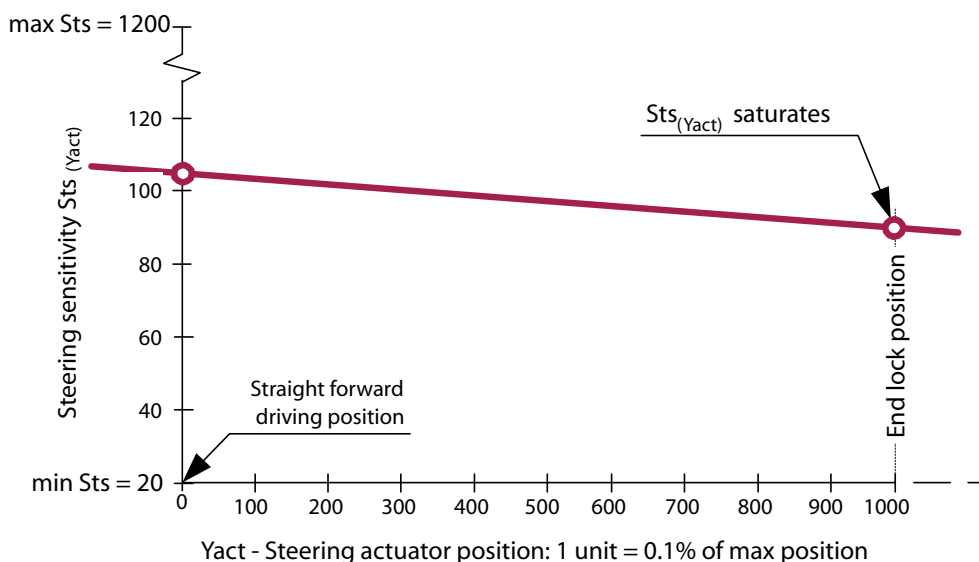

P005 098E

Sse Selects between a fixed steering sensitivity, variable to steering actuator position or vehicle speed.

Set Sse to 2 to select the sensitivity related to steering actuator position.

Sts0 Sets the linear gradient between steering angle and requested port flow for steering straightforward. When the steering actuator signal unintentionally is not mapped, Sts0 will be constantly used since variable Yact remains 0.

Sts1 Sets the linear gradient between steering angle and requested port flow for steering at the minimum turning radius.

Symbol	Index	Default	Value range
Sse	3y09	1	Must be set at 2
Sts0	3y10	105	20 to 1200 (Amplification of 0.2 to 12.00)
Sts1	3y11	90	20 to 1200

See chapter Mapping steering signals, Steering actuator Sensor (feedback from vehicle wheels) and Steering actuator position to acquire "steering actuator position".

Steering by High Priority Steering Device – Open Loop

Select a Sensitivity with Relation to Vehicle Speed

Variable steering sensitivity related to vehicle speed is normally used to optimize directional stability automatically and beyond the notice of the driver. The values and correlation is normally closely related to the present vehicle dynamics of the individual vehicle model. The Sts value is used to amplify the input signal as described in *Set-point Transfer Function* on page 44 .

The correlation is defined by seven parameters. All Sts-parameters may be set equal to each other or set monotonically falling for increasing vehicle speeds. The steering sensitivity between two table coordinates is found by linear interpolation. The relation is equal for negative speeds.

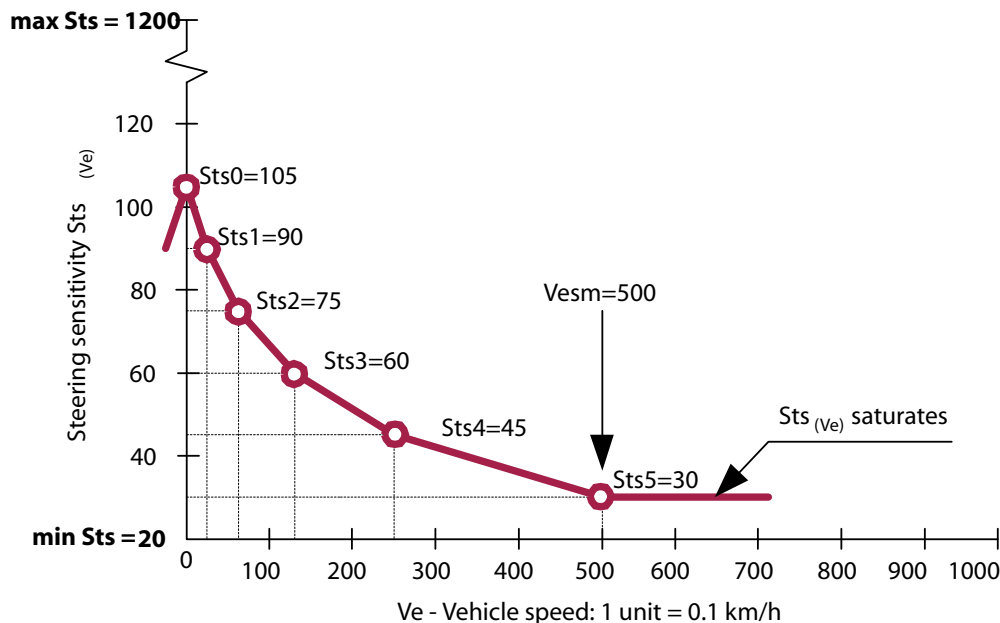

P005 088E

Sse Selects between a fixed steering sensitivity, variable to steering actuator position or vehicle speed. Set Sse to 3 to select the sensitivity related to vehicle speed.

Sts0 Sets the linear gradient between steering angle and requested port flow when the vehicle is standing still. When the vehicle signal unintentionally not is mapped, Sts0 is applied constantly since variable Ve remains 0. In case the vehicle signal not is diagnosed, it is recommended to set Sts0 at a value where sufficient directional stability at maximum vehicle speed is present.

Sts1 Sets the linear gradient between steering angle and requested port flow when the vehicle is driving at 6.25% of the speed defined by parameter Vesm.

Sts2 Sets the linear gradient between steering angle and requested port flow when the vehicle is driving at 12.50% of the speed defined by parameter Vesm.

Sts3 Sets the linear gradient between steering angle and requested port flow when the vehicle is driving at 25.00% of the speed defined by parameter Vesm.

Sts4 Sets the linear gradient between steering angle and requested port flow when the vehicle is driving at 50.00% of the speed defined by parameter Vesm.

Sts5 Sets the linear gradient between steering angle and requested port flow when the vehicle is driving at 100.00% of the speed defined by parameter Vesm.

Vesm Sets the region where steering sensitivity is variable to vehicle speed.

Symbol	Index	Default	Value range
Sse	3y09	1	Must be set at 3

Steering by High Priority Steering Device – Open Loop

Symbol	Index	Default	Value range
Sts0	3y10	105	20 to 1200 (Amplification of 0.2 to 12.00)
Sts1	3y11	90	20 to Sts0
Sts2	3y12	75	20 to Sts1
Sts3	3y13	60	20 to Sts2
Sts4	3y14	45	20 to Sts3
Sts5	3y15	30	20 to Sts4
Vesm	3y16	500	1 (0.1 km/h) to 1000 (100.0 km/h)

Please note the parameter dependency of Sts. See Mapping steering signals and J1939 Vehicle Speed to acquire " Vehicle speed"

Ramps (Anti-Jerk)

Ramps are normally used to minimize jerk forces in machines with articulated steered steering systems. In these steering systems, the articulating masses can be instantly stopped by closing the valve oil flow. An instant cylinder movement stop starts the articulating masses to oscillate until all kinetic energy is dispatched into heat by the shock valves or by the friction between wheels and ground. Jerk is an inherent characteristic of articulated steered vehicles and cannot be completely removed. However, it is best minimized when the forces are monotonically reduced in magnitude.

To achieve this, the EHPS software provides linear or non-linear ramps which in effect creates an orifice across the main spool to tank by holding the valve open near its closing position until all kinetic energy is dispatched into heat for some time. Ramps work on the valve spool set-point.

Sr sets the method. The ramp times can be disabled, fixed or related to vehicle speed. Set Sr to 0 to select no ramps (Default), 1 to select fixed ramp times, or 2 for speed dependent ramp times.

Symbol	Index	Default	Value range
Sr	3y17	0	Must be set at 0

The below figure shows the operation of ramps with fixed ramp times and illustrates different ramp scenarios. Qr is the request port flow commanded with the high priority steering device. Qramp the ramp limited port flow and can be regarded as the result of the ramp function.

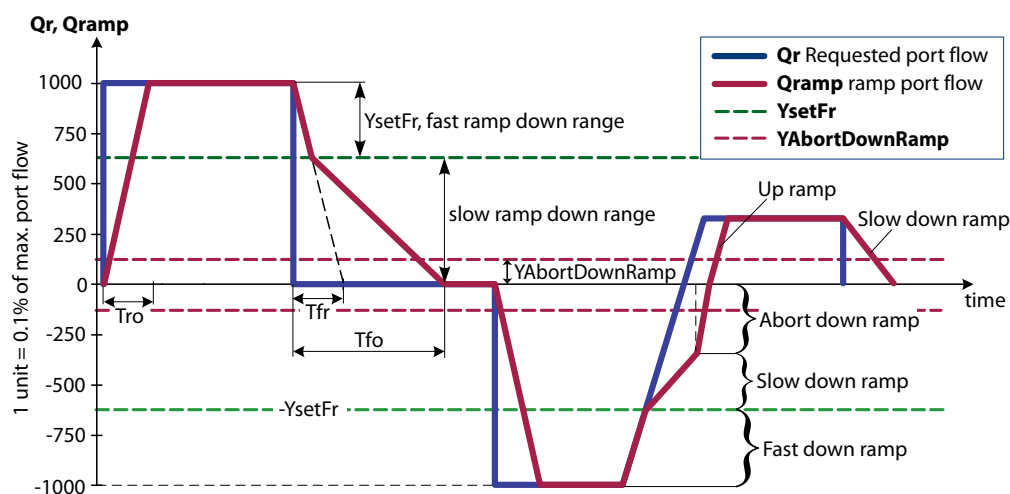

P005 205E

Sr Selects the ramp type. The ramp function can be disabled, fixed or related to vehicle speed. Set Sr to 1 to select fixed ramps.

Steering by High Priority Steering Device – Open Loop

Lr Sets the linearity of the ramp-up curve.

The default value is a linear ramp.

Lf Sets the linearity of the slow ramp-down curve.

The default value is a linear ramp.

Select Ramps with Fixed Ramp Times

Tro Sets the ramp-up time to open the valve from zero to max port flow. The time applies for both ports. To gain the best performance, the ramp-up time shall be set larger than the inherent ramp up time of the main spool. See [Technical Data](#) on page 24.

Tfo Sets the ramp-down time to close the valve from max to zero port flow. The time applies for both ports. It has most effect when the ramp-up time is set larger than the inherent ramp down time of the main spool. See [Technical Data](#) on page 24.

YsetFr Experience shows that ramping down from maximum flow towards medium flows do not cause as much jerk as ramping down from medium flows towards no flow (close to the valve dead-bands). In order to “expedite” the ramping at large flows, a flow range can be set up where the spool can move faster down to a flow range, where the slow down ramp is active.

The overall goal with the parameter is to optimize steering response time without degrading the anti-jerk performance. Set up fast ramp down time Tfr before tuning this parameter. Setting YsetFr to 1000 eliminates the effect of the fast ramp down. Typical settings are 500-800. Use trial and error.

Example:

A value of 800 can be interpreted as allowing the spool to ramp down with a fast ramp for flow requests between maximum flow (1000) and 800/1000 of maximum flow.

Tfr This time defines the applied ramp time in the fast ramp-down range. It is defined as the ramp time from maximum flow to no flow. This means that in practice, the actual fast ramp-down time is proportional to the fast ramp-down range divided by 1000.

Use this optimization criterion: Ramp down as fast as possible for flow ranges, where jerks are not significant. Typical values are 1-50 ms. The fast ramp down time shall always be less than the slow ramp-down time. Once the value is set, it should not be adjusted anymore during further ramp parameter optimization.

YAbortDownRamp To come around the problem of slow steering response for large down-ramp times, especially if a sudden emergency change of direction is needed, a slow down-ramp can be aborted by requesting a flow in the opposite direction. Once a slow down-ramp is aborted, an abort down-ramp time, Tra is applied. Obviously Tra shall be significantly smaller than the slow down-ramp to get any effect.

Tra is the ramp-down time applied when the slow down-ramp is aborted. This rampdown time shall typically be much lower than the slow ramp-down time, Tfo, in order to gain any increased steering responsiveness. Typical value is half the value of Tfo or Tfh time if vehicle speed dependency is applied (Sr=2). Use trial and error.

Example:

A value equal to 500 means that the driver needs to steer out 500/1000 of maximum flow before the slow down-ramp is aborted. 500 again corresponds to a certain steering wheel RPM.

Typical values are 100-300 to have the abort down ramp possibility and to avoid unintentional abort of the down ramp due to steering wheel activation due to vibrations. Setting the value to 1000 disables the abort down ramp functionality.

Steering by High Priority Steering Device – Open Loop

Symbol	Index	Default	Value range
Sr	3y17	0	Must be set at 1
Lr	3y19	0	0 (linear) to 10 (max progressive)
Lf	3y20	0	0 to 10
Tro	3y21	1	1 to 1000 (ms)
Tfo	3y23	350	1 to 1000 (ms)
YsetFr	3y32	1000	0 to 1000 (1 unit = 0.1% of max. flow)
Tfr	3y33	100	1 to 1000 ms Tfr shall be smaller than Tfo and less than 150 ms.
YAbortDownRamp	3y34	0	0 to 500 (1 unit = 0.1% of max. flow). The default value will force an down-ramp abort at a slight reverse port flow request. Typically YAbortDownRamp needs be increased to avoid unintentional down-ramp aborts as this will infer a jerk on the driver.

The discontinuities in the progressive characteristic are located at 50, 120 and 333 ([5.0;T at 25], [12,0;T at 50] and [33.3;T at 75] of max port flow capacity)

Select Ramps with Ramp Time Related to Vehicle Speed

To optimize the anti-jerk performance to different work cycles, the vehicle speed can be used to derive ramp times by interpolation between ramp values for 0 km/h.

Steering by High Priority Steering Device – Open Loop

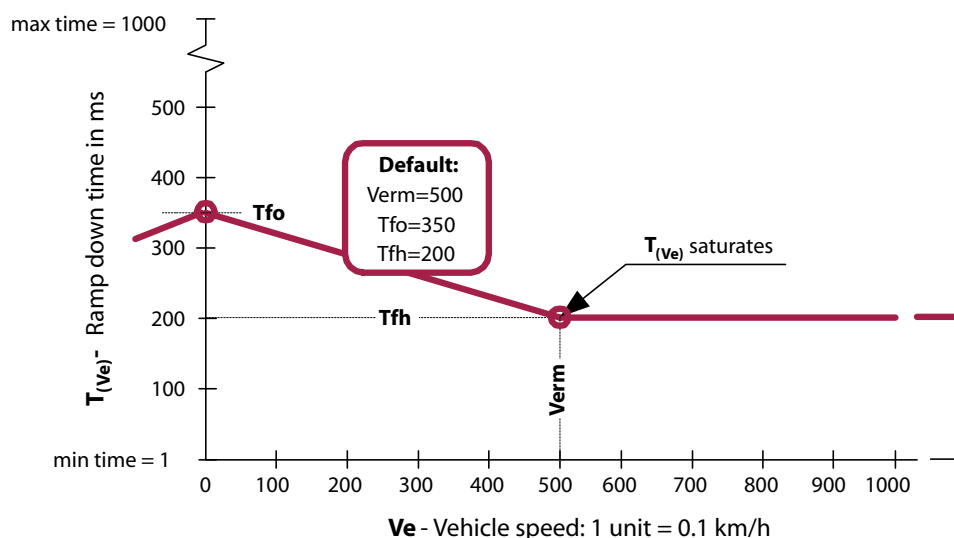
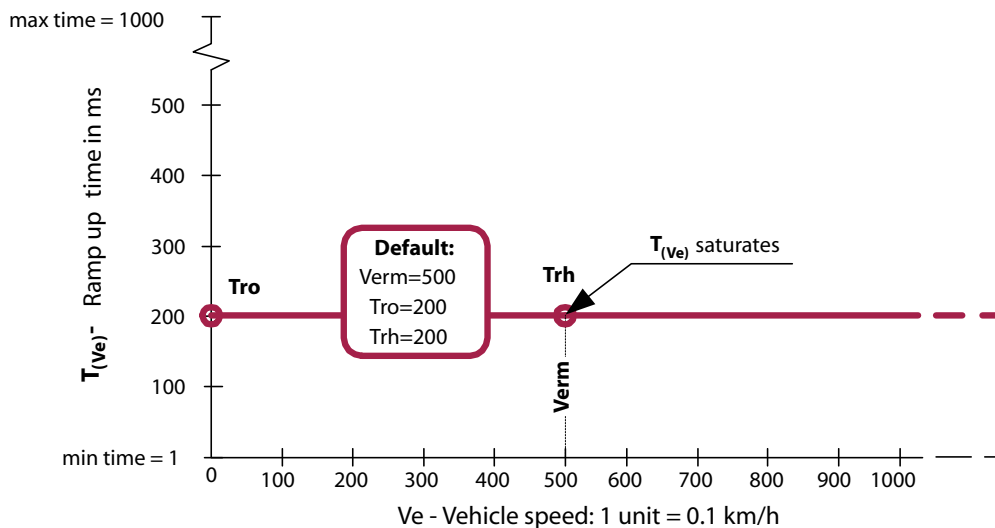

P005 218E

Sr Selects the ramp type. The ramp function can be disabled, fixed or related to vehicle speed. Set Sr to 21 to select vehicle speed dependant ramps.

Lr Sets the linearity of the ramp-up curve.

The default value is a linear ramp.

Lf Sets the linearity of the slow ramp-down curve.

The default value is a linear ramp.

Tro Sets the ramp-up time to open the valve from zero to max port flow when the vehicle speed is 0 kmph. The time applies for both ports.

To gain the best performance, the ramp-up time shall be set larger than the inherent ramp up time of the main spool. See [Technical Data](#) on page 24.

Tfo Sets the ramp-down time to close the valve from max to zero port flow when the vehicle speed is 0 kmph. The time applies for both ports. It has most effect when the ramp-up time is set larger than the inherent ramp down time of the main spool. See [Technical Data](#) on page 24 for these data.

Steering by High Priority Steering Device – Open Loop

Trh Sets the ramp-up time to open the valve from zero to max port flow when the vehicle speed is equal to Verm kmph. The time applies for both ports.

To gain the best performance, the ramp-up time shall be set larger than the inherent ramp up time of the main spool. See [Technical Data](#) on page 24 for these ramp times.

Tfh Sets the ramp-down time to close the valve from max to zero port flow when the vehicle speed is equal to Verm kmph. The time applies for both ports. It has most effect when the ramp-up time is set larger than the inherent ramp down time of the main spool. See [Technical Data](#) on page 24 for these ramp times.

Verm Sets the region (in kmph) where ramp-up (Trh) and ramp-down (Tfh) time is variable to vehicle speed.

YsetFr Experience shows that ramping down from maximum flow towards medium flows do not cause as much jerk as ramping down from medium flows towards no flow (close to the valve dead-bands). In order to “expedite” the ramping at large flows, a flow range can be set up where the spool can move faster down to a flow range, where the slow down ramp is active. The overall goal with the parameter is to optimize steering response time without degrading the anti-jerk performance. Set up fast ramp down time Tfr before tuning this parameter. Setting YsetFr to 1000 eliminates the effect of the fast ramp down. Typical settings are 500-800. Use trial and error.

Example:

A value of 800 can be interpreted as allowing the spool to ramp down with a fast ramp for flow requests between maximum flow (1000) and 800/1000 of maximum flow.

Tfr This time defines the applied ramp time in the fast ramp-down range. It is defined as the ramp time from maximum flow to no flow. This means that in practice, the actual fast ramp-down time is proportional to the fast ramp-down range divided by 1000.

Use this optimization criterion: Ramp down as fast as possible for flow ranges, where jerks are not significant. Typical values are 1-50 ms. The fast ramp down time shall always be less than the slow ramp-down time. Once the value is set, it should not be adjusted anymore during further ramp parameter optimization.

YAbortDownRamp To come around the problem of slow steering response for large down-ramp times, especially if a sudden emergency change of direction is needed, a slow down-ramp can be aborted by requesting a flow in the opposite direction. Once a slow down-ramp is aborted, an abort down-ramp time, Tra is applied. Obviously Tra shall be significantly smaller than the slow down-ramp to get any effect.

Tra is the ramp-down time applied when the slow down-ramp is aborted. This rampdown time shall typically be much lower than the slow ramp-down time, Tfo, in order to gain any increased steering responsiveness. Typical value is half the value of Tfo or Tfh time if vehicle speed dependency is applied (Sr=2). Use trail and error.

Example:

A value equal to 500 means that the driver needs to steer out 500/1000 of maximum flow before the slow down-ramp is aborted. 500 again corresponds to a certain steering wheel RPM.

Typical values are 100-300 to have the abort down ramp possibility and to avoid unintentional abort of the down ramp due to steering wheel activation due to vibrations. Setting the value to 1000 disables the abort down ramp functionality.

Symbol	Index	Default	Value range
Sr	3y17	0	Must be set at 2
Lr	3y19	0	0 to 10 (linear to max progressive)

Steering by High Priority Steering Device – Open Loop

Symbol	Index	Default	Value range
Lf	3y20	0	0 to 10
Tro	3y21	200	1 to 1000 ms
Tfo	3y23	350	1 to 1000 ms
Trh	3y22	200	1 to 1000
Tfh	3y24	350	1 to 1000
Verm	3y25	500	0 to 1000 (1 unit is 0.1 km/h)
YsetFr	3y32	1000	0 to 1000 (1 unit = 0.1% of max. flow). Fast ramp-down is active in the port flow request range 1000 to YsetFr. The default value disables fast ramp-down.
Tfr	3y33	100	1 to 1000 ms. Tfr shall be smaller than Tfo and less than 150 ms.
YAbortDownRamp	3y34	0	0 to 500 (1 unit = 0.1% of max. flow). The default value will force an down-ramp abort at a slight reverse port flow request. Typically YAbortDownRamp needs be increased to avoid unintentional down-ramp aborts as this will infer a jerk on the driver.
The discontinuities in the progressive characteristic are located at 50, 120 and 333 ([5.0;T at 25], [12,0;T at 50] and [33.3;T at 75] of max port flow capacity)			

Anti-jerk Ramp Parameter Tuning Guide

Tuning the parameters is an iterative process. The following sequence may be useful when tuning a vehicle:

1. Initial setting: Set Tro to 1. Tfr to 1. Set YsetFr to 1000. Set Tra to 1. Set YabortThreshold to 500.
2. Set the ramp-down time, Tfo, to a start value e.g. 500.
3. Decrease YsetFr from 1000 towards a smaller number. Observe which value of YsetFr where the level of jerks starts to get worse to find the flow request range, where ramping has an effect. Optionally increase Tfr to optimize on the fast ramp-down operation. Tfr should not exceed 150 ms and always be smaller than Tfo.
4. Adjust the ramp-down time, Tfo, until at good anti-jerk performance is achieved.
5. Increase the ramp-up time, Tro, to further improve the anti-jerk performance. Tro is typically smaller than Tfo.
6. Fine-tune the performance by experimenting with Tfr, Tra, and YsetFr. Note that the largest jerks shall be tuned away with the ramp-up time, Tro, and ramp-down time, Tfo.
7. Finally the YAbortThreshold and Tra may be adjusted. Consider how many steering wheel RPM is needed to abort the down-ramp. Secondly, adjust Tra to reduce the jerk when aborting the down-ramp. Obviously, Tra needs to be less than the down-ramp time, Tfo to get a faster steering response. Typical values for Tra is 50 – 100 ms.

The above typical parameter settings may vary from vehicle to vehicle.

Soft (Cushion) End-stop

To prevent the steering actuator to hit the mechanical end lock with great speed, the PVED is able to slow down the actuator speed when approaching the end lock electronically.

The red line in the figure below shows how the actuator is slowed down near the end lock position. The black line in the figure below shows how port flow is reduced. The steering actuator signal must be present in the PVED for this functionality to work.

This functionality can be applied only in open-loop control mode, but requires that a steered wheel feedback sensor is mapped and mounted on either the steered wheel or cylinder, to indicate the motion-range.

Steering by High Priority Steering Device – Open Loop

In the figure below the red line shows how the actuator is slowed down near the end lock position, and the black line shows how port flow is reduced. The steering actuator signal must be present in the PVED for this functionality to work.

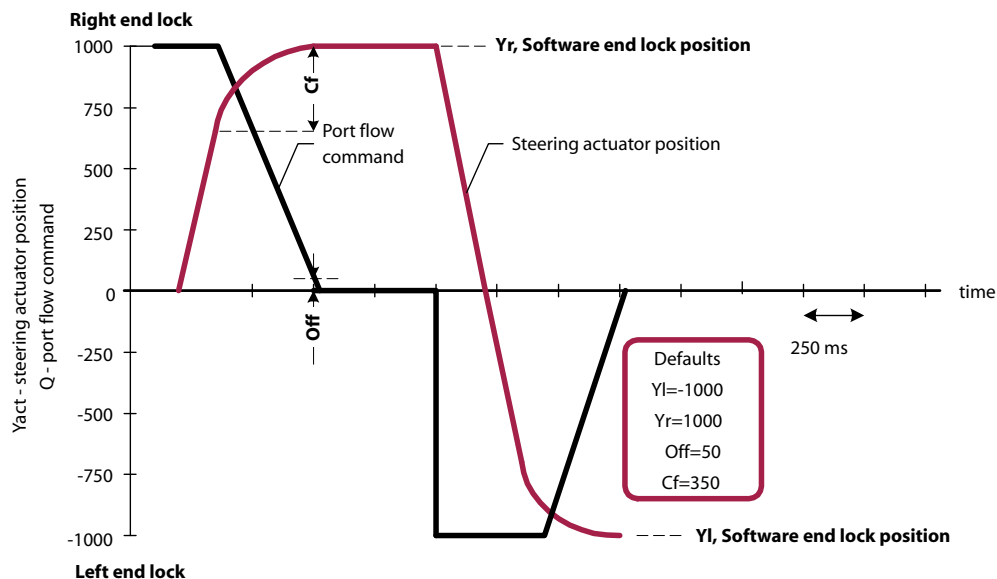

P005 221E

YR, YL The difference between the values of both parameter set the freedom of the steering actuator. Normally, YR is set equal at the right mechanical end lock. YL is normally set equal to the left mechanical end lock. For example, setting YR at 500 and YL at -500 reduces the freedom of the actuator by 50%. The default values for YR and YL are set equal to position of the mechanically end locks.

Cf Sets the region where actuation speed is slowed down. This region starts from the position defined by YR and YL. Making this region to small reduces or can eliminate the effect of soft stop.

The default value for Cf ensures the valve is closed proportionally with actuator position.

Off This parameter sets the permitted actuation speed when hitting the end lock defined by YR or YL. When the steering actuator passed YR or YL, actuation speed will decay to zero.

The default sets a speed that allows building up pressure when the actuator is located at YR or YL.

Symbol	Index	Default	Value range
YR	3y07	1000	-1000 – 1000, Values smaller than 0 will be set equal to the positive equivalent
YL	3y08	-1000	-1000 – 1000, Values greater than 0 will be set equal to the negative equivalent
Off	3y28	50	0 to 1000 (0.0 - 100.0% of max port flow)
Cf	3y29	333	1 to 1000

See chapter Mapping steering signals, Steering actuator Sensor (feedback from vehicle wheels) and Steering actuator position to acquire “steering actuator position”.

Tolsout Maximum time where the main spool is allowed to be operated proportionally within the valve dead-bands.

The main spool control range for this function can be seen in the [Dead-band crossing](#) on page 26.

This function is useful to eliminate frequent spool relocating events from its neutral to its dead-band position and back (so called jumps) at small flow requests.

The flow request is 0 while moving the high priority steering device within the steering device dead-band, db (see [Set-point Transfer Function](#) on page 44).

Steering by High Priority Steering Device – Open Loop

Spool Dead-band Hold Control Function

Dead-band Jump Control

Set Tolsout lower than 21 (ms) to momentarily set the main spool in neutral as soon as the flow request is 0, No proportional spool movement will take place. The spool will jump from neutral to either of the valve dead-bands depending on a flow request. The steering device dead-band, db, has no impact for these Tolsout values.

Dead-band Hold and Proportional Control

Setting Tolsout between 21 and 30000 (ms) defines the maximum time where the main spool is either set on the valve dead-band or controlled proportionally within the valve dead-band (granted that the flow request is 0 during this time).

After a flow request to either left or right port, the main spool will be set on the respective left or right valve dead-band. Any steering device movement within the defined steering device dead-band, db, will result in proportional main spool movement. Proportional control will be allowed for Tolsout ms. If the flow request has been 0 for Tolsout ms, the main spool will be set in neutral and any steering device movements within db will be ignored.

To utilize proportional control, a steering device dead-band, db, needs to be created. If db is set a low value, the main spool will effectively be operated as dead-band jump control.

Responding to Flow Requests after Tolsout

If the main spool has been set in neutral after Tolsout ms, any flow request will cause the spool to immediately jump to the relevant spool position with no initial proportional dead-band control.

Symbol	Index	Default	Value range
Tolsout	316	10 000	1 to 30 000 (ms)

Magnetic Valves OFF Control

Magnetic valves off delay time disables the magnetic valve bridge after a time specified in ms when the flow request is 0, otherwise it remains enabled. This parameter is used when electrical energy consumption by the magnetic valve bridge in the PVED must be reduced or to resolve a steering control conflict between the OSP and the PVED-CL (implementing EHPS type 1 systems only).

The default value disables this functionality i.e. the magnetic valve bridge is enabled at all times. The magnetic valve bridge is enabled when the PVED-CL receives a non-zero flow request.

Symbol	Index	Default	Value range
Magnetic valves Off delay time	315	30 000	1 to 30 000 (ms)

Resolving a Steering Control Conflict

On systems utilizing a PVED-CL, an EHPS valve, an OSP, a CAN or analogue steering device but no steering wheel angle sensor (SASA) (EHPS type 1), the PVED-CL has no means to detect that the steering wheel is being activated. A steering conflict between OSP steering and steering device steering is thus possible.

To resolve this conflict, set Tolsout to a value (typically 50 ms – 200 ms) to disable the magnetic valve bridge when no flow request is being commanded with the steering device.

Steering by High Priority Steering Device – Closed Loop

Steering by High Priority Steering Device – Closed Loop

EHPS Type 2 Automatic Steering Diagram

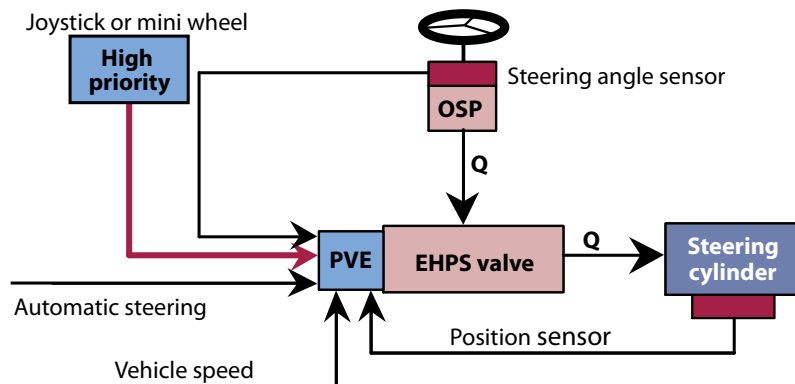

P005 225E

Functionality Tree

The tree below illustrates the functionality available in the PVED for steering by a potentiometer device or by joystick or by mini wheel with speed output. The manufacturing default functionality is found by following the red line. It can of course be modified by following the instructions in this chapter. The switches in the tree are used to select the functionality required. In case different functionalities are required, the EHPS software provides 5 programs from which the driver can select when the system is fully operative. For steering by a device without spring return the PVED provides closed loop position control. The steering signal is monotonic and represents the angle of the physical device. These devices are normally friction held to prevent unintentionally steering due to machine vibrations. Use this mode for implementation of proprietary auto-guidance applications i.e. auto-guidance applications that do not conform to the ISO standardized auto-guidance messages. See [Auto-steering](#) on page 105.

Steering by High Priority Steering Device – Closed Loop

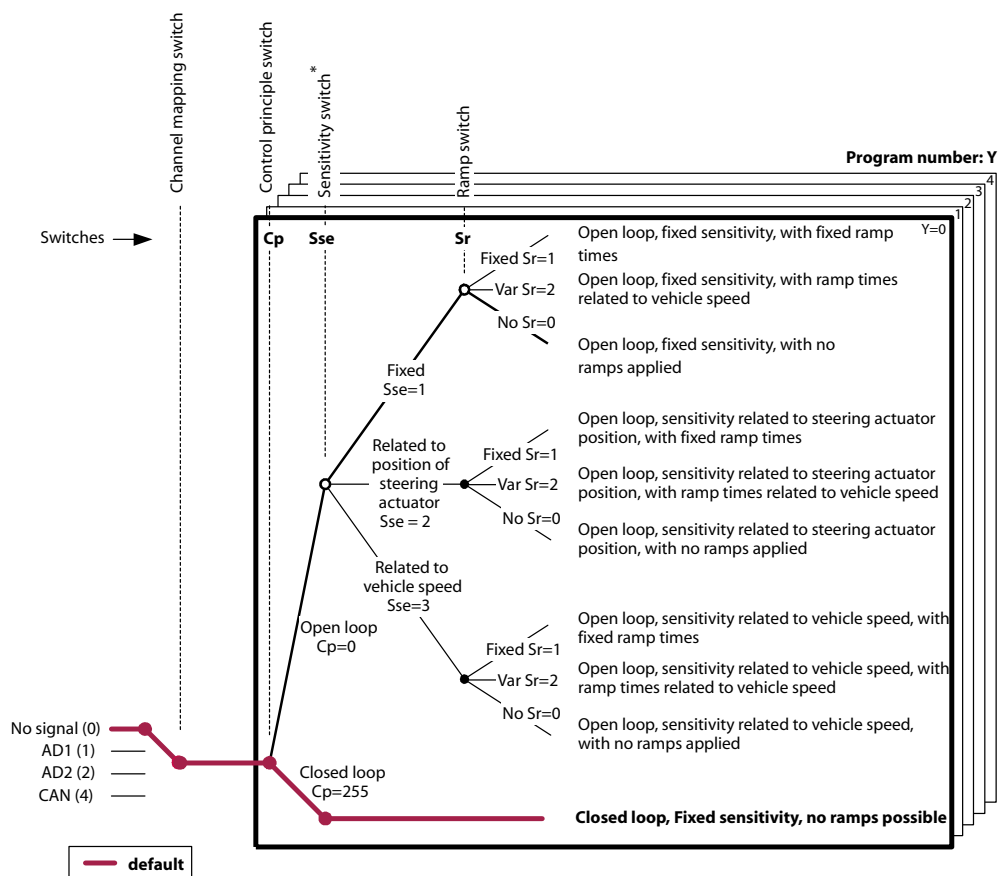

* Sensitivity means: Port flow amplification

P005 089E

Tracking

For safety reasons, a tracking function ensures bump-less transition on control loop initialization. It forces the user initially to operate the potentiometer knob into a position that matches zero deviation between set point and current steering actuator position or by sweeping through it. While tracking, the commanded port flow is limited at zero.

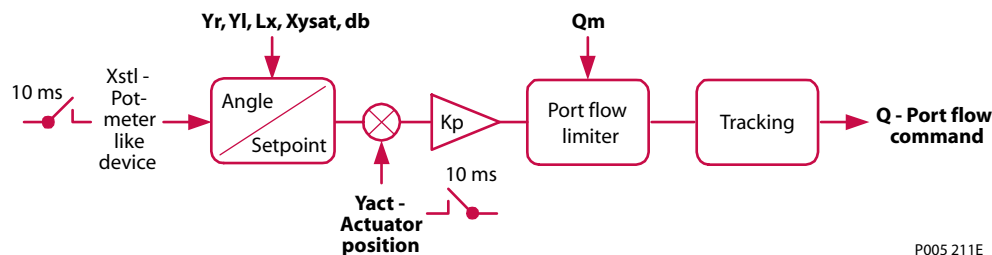

P005 211E

Select the Control Principle

Cp selects the closed loop control using parameter index 3y02 equal to 255. **Y** selects the program and ranges from 0 and 4. The value for **y** must be consistently used throughout the entire configuration of a single program.

Steering by High Priority Steering Device – Closed Loop

Acquire the Signals

See [Mapping a Steering Device](#) on page 34 on how to map an analogue or CAN-based high priority closed-loop steering device and steering wheel angle sensor.

Create the Set Point

A function provides 5 parameters to transform angle information to a steering actuator position set point.

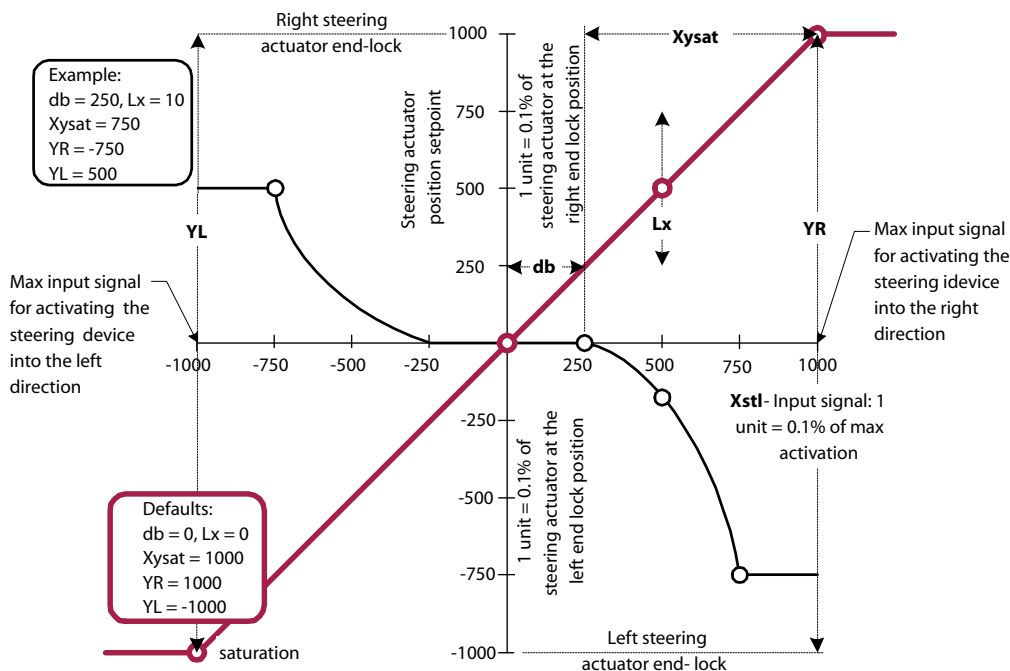

P005 212E

db Sets a dead band about the middle region of the signal. The parameters prevent self-steering, caused by manufacturing deviations in the signal when the handle is in the middle or released position. However, db is normally set to zero for pot-meter like steering devices.

The default value is set to serve pot-meter like steering devices

Lx Set the curve linearity. The parameter is set down when the cylinder position is too far (over-steer) for small steering angles or vice versa.

The optimum value for this parameter is closely related to:

- The inherent linearity between steering actuator position and signal
- The inherent linearity between device handle angle and signal
- The inherent over or under-steer tendency of the vehicle when steering into curves
- The default value will not effect the resulting relation.

YR, YL The difference between the values of both parameter set the freedom of the steering actuator.

Normally, YR is set equal at the right mechanical end lock. YL is normally set equal to the left mechanical end lock. This results in steering to the right direction. In case an opposite steering behavior is required, YR must be set at the negative equivalent and YL must be set at the positive equivalent (See example). The default value for YR and YL is set equal to the mechanical locks of the steering actuator resulting in the vehicle to steer in the right direction.

Xysat Sets a threshold for the output to be at its maximum or minimum when the input signal exceeds the threshold value. Xysat is normally set down when more sensitivity is required than inherently

Steering by High Priority Steering Device – Closed Loop

available with the steering device. The default value will not effect the inherent sensitivity of the steering device.

Symbol	Index	Default	Value range
db	3y05	0	0.0 to 250 (0.0 to 25.0% of max activation in the right steering direction)
Lx	3y06	0	-10 to 10 (-10 max regress, 0 linear, 10 max progress)
YR	3y07	1000	-1000 to 1000
YL	3y08	-1000	-1000 to 1000
Yxsat	3y03	1000	251 to 1000
Parameter Yxsat, db & Lx have same value in quadrant 2 & 3. Lx in quadrant 1 or 4 is located at: $[(X_{ysat}+db)/2; YR*(20-Lx)/40]$. Lx in quadrant 2 or 3 is located at: $[-(X_{ysat}+db)/2; YL*(20-Lx)/40]$.			

Closing the Loop

Kp Amplifies the error between set point and current position. The optimum value for Kp is found when a non-lagging, accurate, non-oscillating steering actuation without overshoot is achieved at extreme low and high oil viscosities as specified in chapter: (robustness to changes sin dead times) and at low and near max steering pressure when driving at low, high vehicle speed and reversed gear (robustness to changes in damping & dead times). Moreover, Kp is closely related to valve capacity, stroke volume. See section [Steady State Error](#) on page 61 for information on accuracy. The default value fits to steering systems with a lock-to-lock time of 2 seconds at max port flow.

Qm Sets the maximum port flow. It effects the speed of the steering actuator to move towards the set point position. Negative values of Qm are interpreted as the positive equivalent.

The default value is set equal to the inherent max port flow capacity of the valve and will therefore not have any effect.

Symbol	Index	Default	Value range
Kp	308	50	0 to 200 (0.00 to 2.00% of port flow capacity of the valve for 0.1% positional error)
Qm	3y27	1000	0 to 1000 (0.0 to 100.0 % port flow)

Eliminate Noise due to Frequent Pressure Build-up

Eliminating noise is accomplished by stopping the controller to respond to minor deviations between set point and current actuator position. The spool inside the valve is set in neutral when the port flow command has been within a threshold value (Qth) for a given time (Tclpout). The spool is reactivated again when port flow command exceeds the threshold.

Tclpout Sets the time delay (ms) before the main spool is set in neutral.

Qth Sets the threshold value for port flow command when the controller is in steady state.

Symbol	Index	Default	Value range
Tclpout	317	3000	1 to 30000 (ms)
Qth	318	50	0 to 100 (0.0 to 10.0% of max port flow)

Magnetic Valves OFF Control

Magnetic valves off delay time Disables the magnetic valve bridge after a time specified in ms when the flow request is 0, otherwise it remains enabled. This parameter is used when electrical energy consumption by the magnetic valve bridge in the PVED must be reduced or to resolve a steering control conflict between the OSP and the PVED-CL (implementing EHPS type 1 systems only).

The default value disables this functionality i.e. the magnetic valve bridge is enabled at all times. The magnetic valve bridge is enabled when the PVED-CL receives a non-zero flow request

Steering by High Priority Steering Device – Closed Loop

Symbol	Index	Default	Value range
Magnetic Valves Off delay time	315	30 000	1 to 30 000 (ms)

Resolving a Steering Control Conflict

On systems utilizing a PVED-CL, an EHPS valve, an OSP, a CAN or analogue steering device but no steering wheel angle sensor (SASA) (EHPS type 1), the PVED-CL has no means to detect that the steering wheel is being activated. A steering conflict between OSP steering and steering device steering is thus possible. To resolve this conflict, set Tolsout to a value (typically 50 ms – 200 ms) to disable the magnetic valve bridge when no flow request is being commanded with the steering device.

High Priority Steering Device Enable/Disable Control

The PVED functionality allows the user to dynamically enable or disable a steering device during operation from the cabin MMI (via CAN bus). This functionality enables e.g. an armrest device to be folded away for easy access to the cabin, while the system operational, to avoid the risk of unintended device activation when the user enters or leaves the cabin.

Another user scenario is to disable one or more lower priority steering devices when only the steering wheel device is in use for a longer period of time and the user wishes to eliminate the risk of unintentional device activation.

System Requirements

The device enable/disable control functionality is only functional if the following conditions are fulfilled.

- The system must be in operational state.
- The device that shall be enabled/disabled is mapped.
- An OSP for hydraulic backup exists and the presence of the OSP is configured in the PVED.

Symbol	Index	Default	Value range
HighPrioritySteeringDeviceInterface	65102	0	0 (NONE), 1 (AD1), 2 (AD2), 4 (CAN)
OSP present	65109	0	0 (NONE), 255 (PRESENT)

If an OSP is not present, the device enable/disable control command is ignored. The OSP shall be present because it is theoretically possible to electrically disable all steering devices if the primary steering wheel sensor is not mapped. In this situation only the OSP pilot signals are driving the valve.

Caution

The vehicle system integrator shall consider the following to ensure a safe and reliable device enable/disable functionality:

- It is recommended to include the vehicle velocity information in the decision whether a device disable request shall be sent to the PVED or not.
- The location of the enable/disable button shall be well-considered to avoid unintentional enabling/disabling of a steering device.
- Unintended enabling/disabling should be further avoided by requiring the enable/disable button to be pressed for a well-defined period of time.
- The OEM shall ensure that a steering device outputs a signal within a valid range when the device is enabled.

Device Diagnostic Operation

The steering device diagnostic checks are performed both when the device is enabled and disabled.

Steering by High Priority Steering Device – Closed Loop

Enable or Disable Joystick Steering Device

The device enable/disable control is executed by means of the DisableSteeringDevice command (see *PVED-CL Communication Protocol Technical Information, 11025584*) from e.g. the man machine interface. The DisableSteeringDevice command options are:

- Arm joystick enable/disable
- Enable joystick
- Disable joystick

The enabling or disabling of a steering device must follow the state transition sequence shown below in order to minimize undesired enabling or disabling of a steering device.

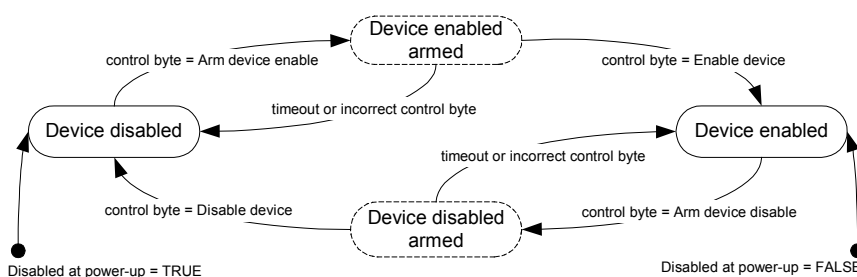

The states, device enabled armed and device disabled armed are volatile states. A transition from these states to the desired state requires reception of a command message within 200 ms after the reception of first command message. Otherwise the device disable state will change back to its last state.

Boot-up State of Steering Device

The boot-up enable/disable state of the device can be configured with a parameter and can be changed via the SetParameter command (see *PVED-CL Communication Protocol Technical Information, 11025584*).

Symbol	Index	Default	Value range
HPStdDisabledAtBootUp	64008	0	0 (FALSE), 255 (TRUE)
HpStd means High Priority Steering Device. If the device disable functionality is not desired, the parameter shall be 0.			

Getting the Actual Enable/disable Status of the Device

The PVED will send one DisableSteeringDeviceResponse reply message to each DisableSteeringDevice command it receives (or on time-out), containing the present enable/disable state for all steering devices. This reply may be used by the MMI for acknowledge or display purposes (see *PVED-CL Communication Protocol Technical Information, 11025584*).

The device enable/disable present status for all devices is also transmitted periodically in the OperationStatus message which is transmitted on the CAN bus by default (see *PVED-CL Communication Protocol Technical Information, 11025584*).

Steering by Low Priority Steering Device – Open Loop

Steering by Low Priority Steering Device – Open Loop

EHPS Type 2 System Diagram

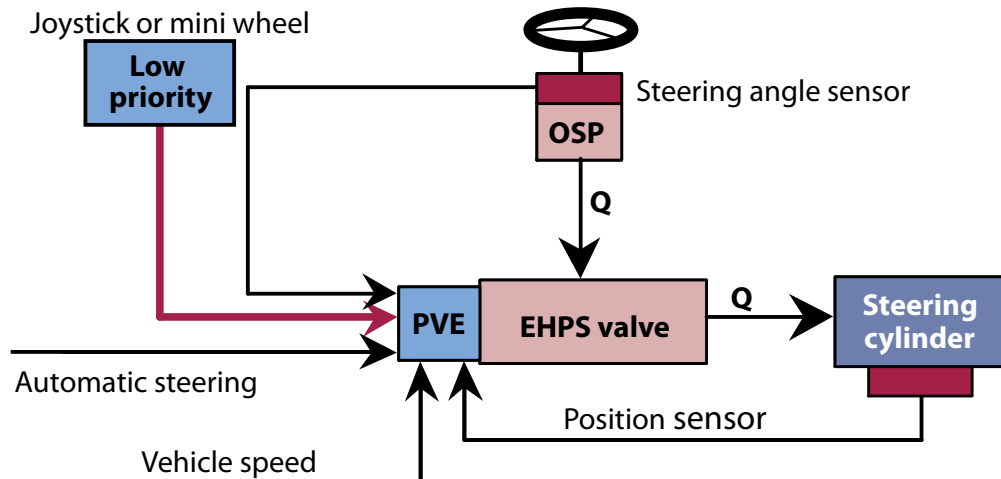

Functionality Tree

The tree below illustrates the availability of the PVED for steering by joystick, mini wheel with speed output or by potentiometer-like steering devices. The manufacturing default functionality is found by following the red line. Following the instructions in this chapter can of course modify the default. The switches in the tree are used to select the functionality required. In case different functionalities are required, the EHPS software provides 5 programs from which the driver can select when the system is fully operative.

Steering by Low Priority Steering Device – Open Loop

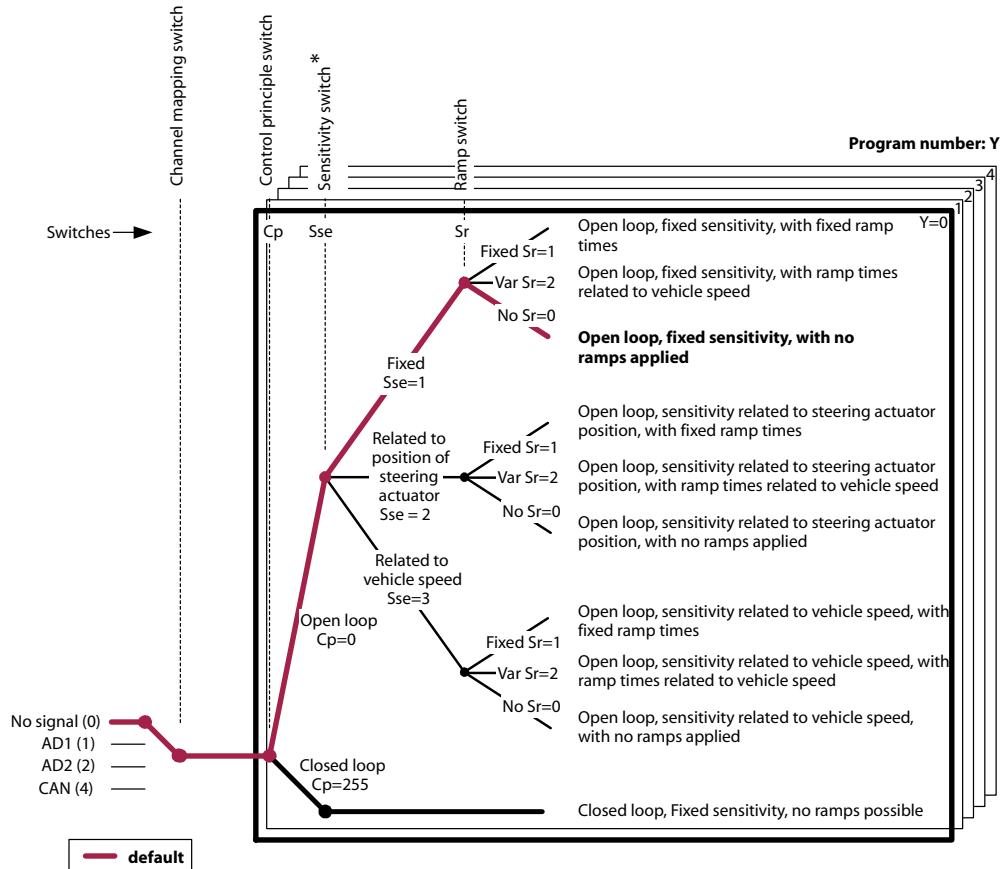

* Sensitivity means: Port flow amplification

P005 099E

Select the Control Principle

The PVED-CL provides open loop control for steering devices with spring return or for steering devices with a speed output. This control principle keeps a fixed or variable relation between steering input and cylinder speed. The control loop provides several parameters to transform positional information to port flow.

Cp is used to select open loop control for joystick steering by setting parameter index 4y02 equal to 0. Parameter selection values: Y selects the program and ranges from 0 and 9.

Steering by Low Priority Steering Device – Open Loop

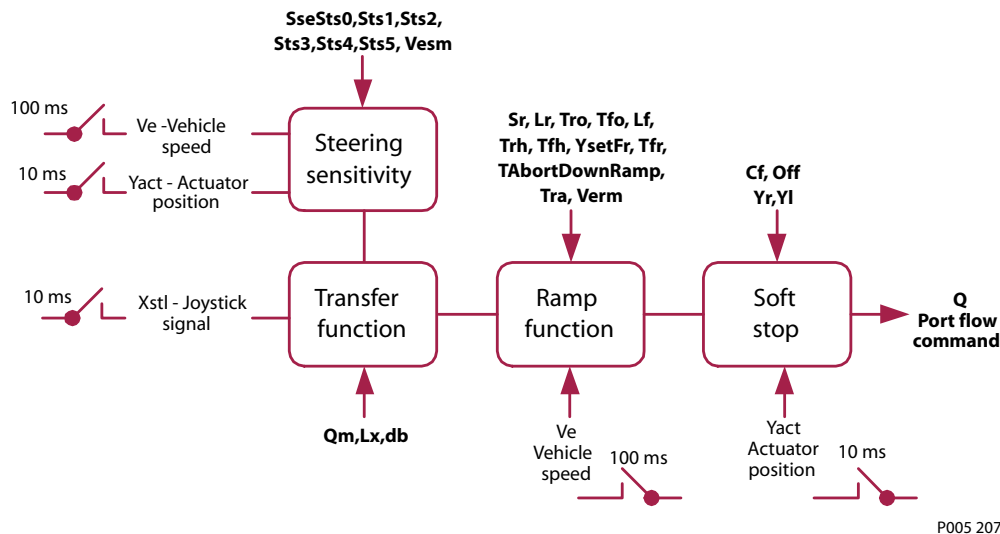

P005 207E

Acquire the Signals

See [Mapping a Steering Device](#) on page 34 on how to map the steering wheel sensor and steering wheel angle sensor.

Set-point Transfer Function

The transfer function provides 3 parameters to transfer joystick inputs signal to requested port flow.

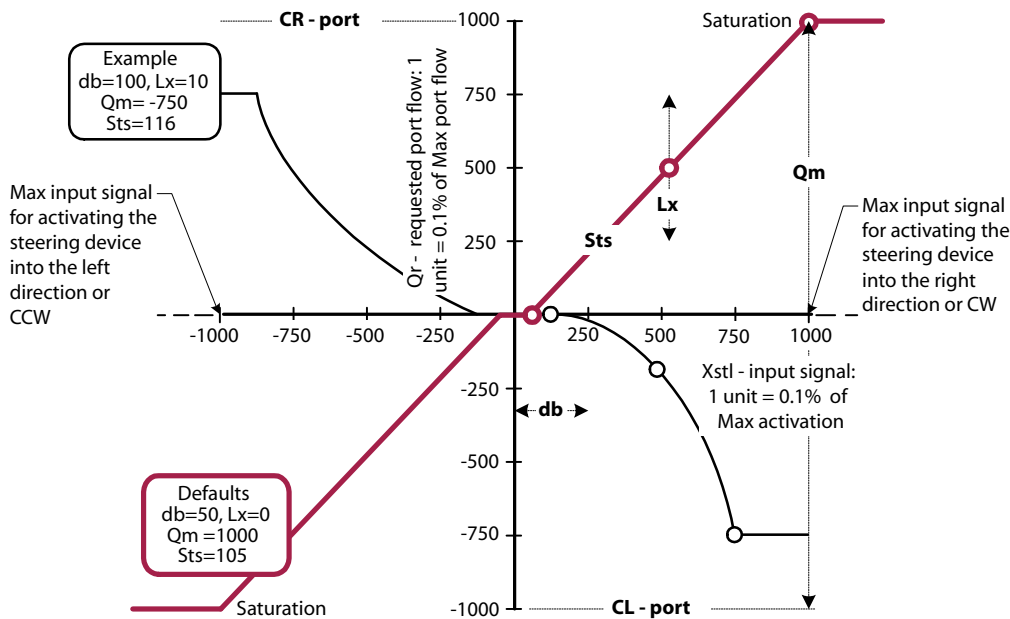

P005 210E

Db Sets a dead-band in the middle region of the steering input. It prevents self-steering caused by manufacturing deviations in the signal when the handle is in the middle or released position.

The default value is set twice the maximum deviation of most spring returned steering devices.

Lx Effect the inherent linearity between steering actuator speed and steering angle. The set value is set down when slower cylinder speed at larger steering angles is required.

Steering by Low Priority Steering Device – Open Loop

The default value will not effect the resulting relation.

Qm Limits the maximum cylinder speed for steering the vehicle in the right steering direction. (See set-point transfer function above)

The default value is set equal to the inherent max port flow capacity of the valve and will therefore not have any effect.

Symbol	Index	Default	Value range
db	4y05	50	0 to 250
Lx	4y06	0	-10 (max regressive), 0 (linear) to 10 (max progressive)
Qm	4y07	1000	0 to 1000 (100% flow at CR- or CL-port

Steering Sensitivity

Sensitivity is set individually for each program and can be either fixed or variable. Variability can depend on vehicle speed, steered wheel position, or change of current device program. Using variable sensitivity can increase comfort and drivability significantly, and depending on the vehicle type and use the appropriate way to achieve the change might be different.

The PVED-CL allows several programs for each steering device, which means that 5 to 10 different programs with different sensitivity settings can be made and applied via the MMI while driving. Each program can then use either fixed or variable sensitivity – hence we talk ‘second-order-variability’ by using the PVED-CL.

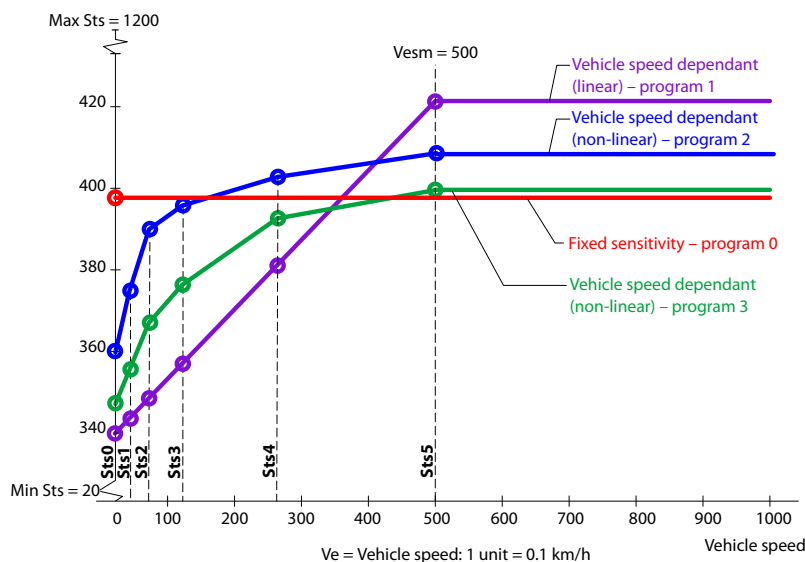

Select a Fixed Sensitivity

A fixed steering sensitivity is chosen when no cylinder position or vehicle speed signal is available on the vehicle.

Sse Selects between a fixed steering sensitivity, variable to steering actuator position or vehicle speed.

Set Sse to 1 to select the fixed sensitivity

Sts0 Sets a gradient between steering angle and requested port flow. Sts0 is normally set when max port flow (defined by Qm) is achieved at maximum steering device input. This is calculated by the following function.

$$Sts = \frac{Qm \cdot 100}{1000 - db}$$

Steering by Low Priority Steering Device – Open Loop

The default value is a gradient matching maximum requested port flow to maximum port flow at the maximum steering angle.

Symbol	Index	Default	Value range
Sse	4y09	1	Must be set at 1
Sts0	4y10	105	20 to 1200 (Amplification of 0.2 to 12.00)

Select a Sensitivity with Relation to the Actuator Position

A steering sensitivity related to actuator position is normally chosen for increased directional stability for straightforward driving (for e.g. material handling). The values and correlation is normally closely related to the mechanical geometry between steering actuator and steered wheels of the individual vehicle.

The correlation is defined by two parameters. The steering sensitivity between two table coordinates is found by linear interpolation. The relation is equal for negative positions.

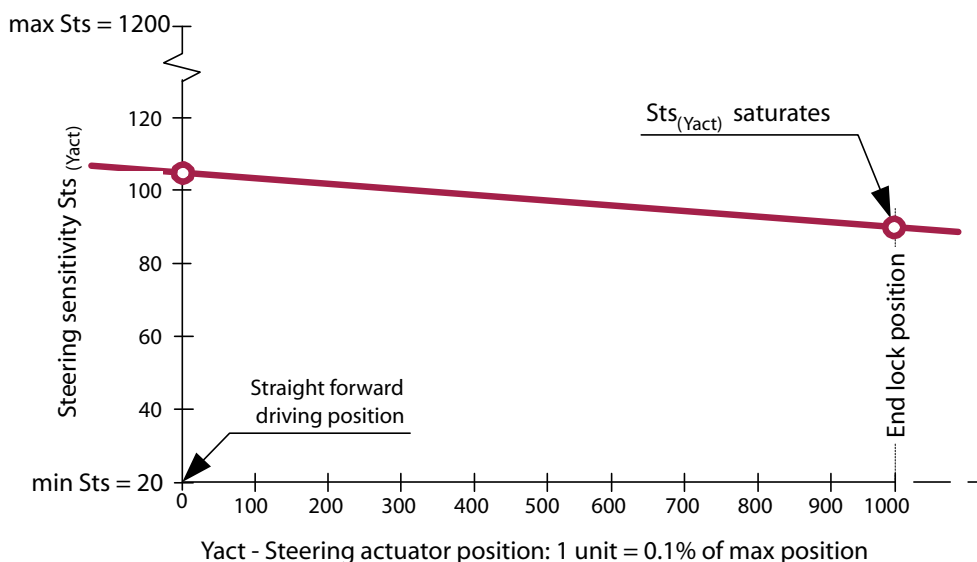

P005 098E

Sse selects between a fixed steering sensitivity, variable to steering actuator position or vehicle speed. Set Sse to 2 to select the sensitivity related to steering actuator position

Sts0 sets the linear gradient between steering angle and requested port flow for steering straightforward. When the steering actuator signal unintentionally is not mapped, Sts0 will be constantly used since variable Yact remains 0.

Sts1 sets the linear gradient between steering angle and requested port flow for steering at the minimum turning radius.

Symbol	Index	Default	Value range
Sse	4y09	1	Must be set at 2
Sts0	4y10	105	20 to 1200 (Amplification of 0.2 to 12.00)
Sts1	4y11	90	20 to 1200

See chapter Mapping steering signals, Steering actuator Sensor (feedback from vehicle wheels) and Steering actuator position to acquire "steering actuator position".

Steering by Low Priority Steering Device – Open Loop

Select a Sensitivity with Relation to Vehicle speed

Variable steering sensitivity related to vehicle speed is normally used to optimize directional stability automatically and beyond the notice of the driver. The values and correlation is normally close related to the present vehicle dynamics of the individual vehicle model. The Sts value is used to amplify the input signal as described in *Set-point Transfer Function* on page 87.

The correlation is defined by seven parameters. All Sts-parameters may be set equal to each other or set monotonically falling for increasing vehicle speeds. The steering sensitivity between two table coordinates is found by linear interpolation. The relation is equal for negative speeds.

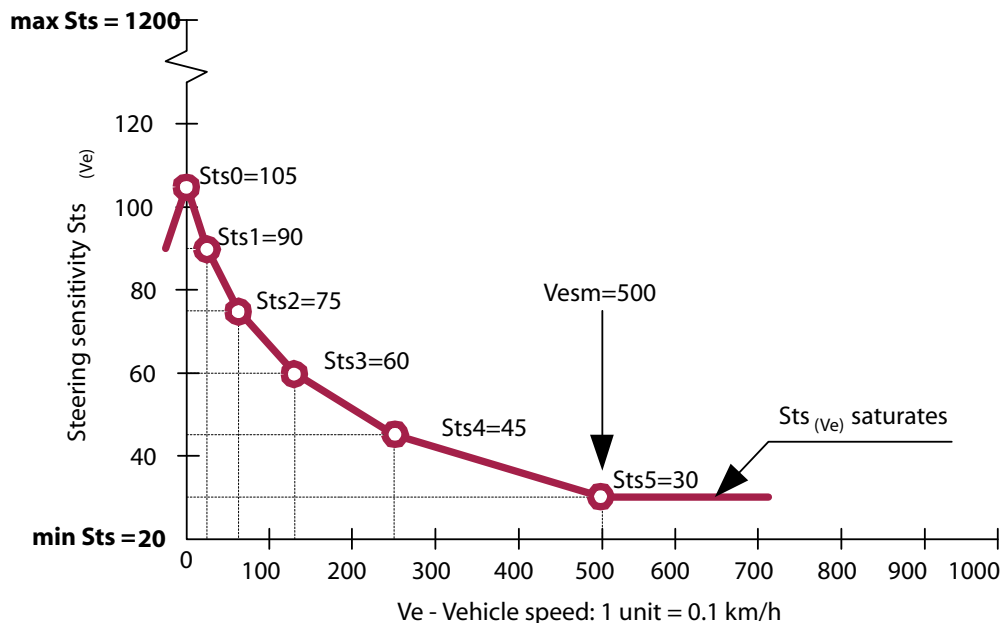

P005 088E

Sse Selects between a fixed steering sensitivity, variable to steering actuator position or vehicle speed. Set Sse to 3 to select the sensitivity related to vehicle speed.

Sts0 Sets the linear gradient between steering angle and requested port flow when the vehicle is standing still. When the vehicle signal unintentionally not is mapped, Sts0 is applied constantly since variable Ve remains 0. In case the vehicle signal not is diagnosed, it is recommended to set Sts0 at a value where sufficient directional stability at maximum vehicle speed is present

Sts1 Sets the linear gradient between steering angle and requested port flow when the vehicle is driving at 6.25% of the speed defined by parameter Vesm.

Sts2 Sets the linear gradient between steering angle and requested port flow when the vehicle is driving at 12.50% of the speed defined by parameter Vesm.

Sts3 Sets the linear gradient between steering angle and requested port flow when the vehicle is driving at 25.00% of the speed defined by parameter Vesm.

Sts4 Sets the linear gradient between steering angle and requested port flow when the vehicle is driving at 50.00% of the speed defined by parameter Vesm.

Sts5 Sets the linear gradient between steering angle and requested port flow when the vehicle is driving at 100.00% of the speed defined by parameter Vesm.

Vesm Sets the region where steering sensitivity is variable to vehicle speed.

Symbol	Index	Default	Value range
Sse	4y09	1	Must be set at 3

Steering by Low Priority Steering Device – Open Loop

Symbol	Index	Default	Value range
Sts0	4y10	105	20 to 1200 (Amplification of 0.2 to 12.00)
Sts1	4y11	90	20 to Sts0
Sts2	4y12	75	20 to Sts1
Sts3	4y13	60	20 to Sts2
Sts4	4y14	45	20 to Sts3
Sts5	4y15	30	20 to Sts4
Vesm	4y16	500	1 (0.1 km/h) to 1000 (100.0 km/h)

Please note the parameter dependency of Sts.
See Mapping steering signals and J1939 Vehicle Speed to acquire " Vehicle speed"

Ramps (Anti-jerk)

Ramps are normally used to minimize jerk forces in machines with articulated steered steering systems. In these steering systems, the articulating masses can be instantly stopped by closing the valve oil flow. An instant cylinder movement stop starts the articulating masses to oscillate until all kinetic energy is dispatched into heat by the shock valves or by the friction between wheels and ground. Jerk is an inherent characteristic of articulated steered vehicles and cannot be completely removed. However, it is best minimized when the forces are monotonically reduced in magnitude.

To achieve this, the EHPS software provides linear or non-linear ramps which in effect creates an orifice across the main spool to tank by holding the valve open near its closing position until all kinetic energy is dispatched into heat for some time. Ramps work on the valve spool set-point.

Sr sets the method. The ramp times can be disabled, fixed or related to vehicle speed. Set Sr to:

- 0 to select no ramps (default),
- 1 to select fixed ramp times, or
- 2 for speed dependent ramp times.

The figure below shows the operation of ramps with fixed ramp times and illustrates different ramp scenarios. **Qr** is the request port flow commanded with the steering wheel. **Qramp** the ramp limited port flow and can be regarded as the result of the ramp function.

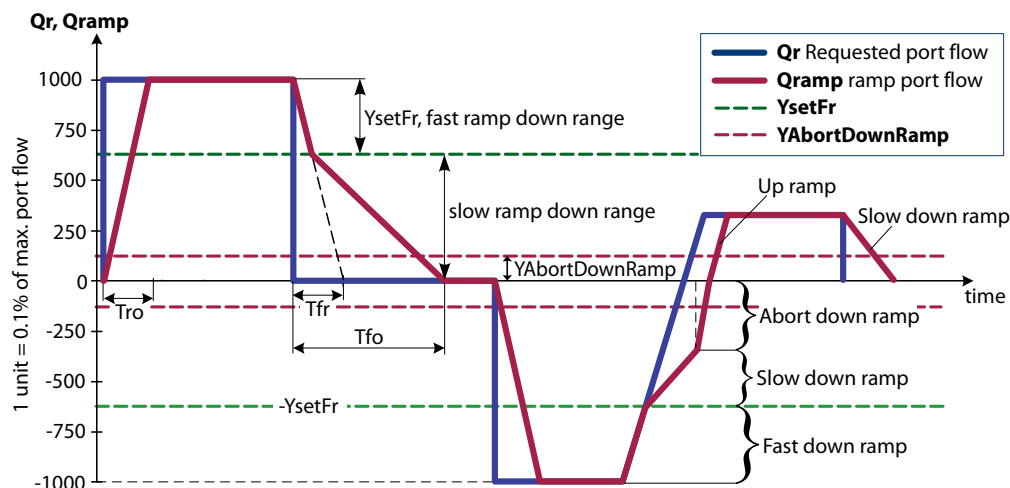

P005 205E

Steering by Low Priority Steering Device – Open Loop

Symbol	Index	Default	Value range
Sr	4y17	0	0 (default)

Ramps with Fixed Ramp Times

Sr Selects the ramp type. The ramp function can be disabled, fixed or related to vehicle speed. Set Sr to 1 to select fixed ramps.

Lr Sets the linearity of the ramp-up curve. The default value is a linear ramp.

Lf Sets the linearity of the slow ramp-down curve. The default value is a linear ramp.

Tro Sets the ramp-up time to open the valve from zero to max port flow. The time applies for both ports. To gain the best performance, the ramp-up time shall be set larger than the inherent ramp up time of the main spool.

See [Technical Data](#) on page 24 for these ramp times.

Tfo Sets the ramp-down time to close the valve from max to zero port flow. The time applies for both ports. It has most effect when the ramp-up time is set larger than the inherent ramp down time of the main spool.

See [Technical Data](#) on page 24 for these ramp times.

YsetFr Experience shows that ramping down from maximum flow towards medium flows do not cause as much jerk as ramping down from medium flows towards no flow (close to the valve dead-bands). In order to “expedite” the ramping at large flows, a flow range can be set up where the spool can move faster down to a flow range, where the slow down ramp is active. The overall goal with the parameter is to optimize steering response time without degrading the anti-jerk performance. Set up fast ramp down time Tfr before tuning this parameter. Setting YsetFr to 1000 eliminates the effect of the fast ramp down. Typical settings are 500-800. Use trial and error.

Example:

A value of 800 can be interpreted as allowing the spool to ramp down with a fast ramp for flow requests between maximum flow (1000) and 800/1000 of maximum flow.

Tfr This time defines the applied ramp time in the fast ramp-down range. It is defined as the ramp time from maximum flow to no flow. This means that in practice, the actual fast ramp-down time is proportional to the fast ramp-down range divided by 1000.

Use this optimization criterion: Ramp down as fast as possible for flow ranges, where jerks are not significant. Typical values are 1-50 ms. The fast ramp down time shall always be less than the slow ramp-down time. Once the value is set, it should not be adjusted anymore during further ramp parameter optimization.

YAbortDownRamp To come around the problem of slow steering response for large down-ramp times, especially if a sudden emergency change of direction is needed, a slow down-ramp can be aborted by requesting a flow in the opposite direction. Once a slow down-ramp is aborted, an abort down-ramp time, Tra is applied. Obviously Tra shall be significantly smaller than the slow down-ramp to get any effect.

Tra is the ramp-down time applied when the slow down-ramp is aborted. This rampdown time shall typically be much lower than the slow ramp-down time, Tfo, in order to gain any increased steering responsiveness. Typical value is half the value of Tfo or Tfh time if vehicle speed dependency is applied (Sr=2). Use trial and error.

Example:

A value equal to 500 means that the driver needs to steer out 500/1000 of maximum flow before the slow down-ramp is aborted. 500 again corresponds to a certain steering wheel RPM.

Steering by Low Priority Steering Device – Open Loop

Typical values are 100-300 to have the abort down ramp possibility and to avoid unintentional abort of the down ramp due to steering wheel activation due to vibrations. Setting the value to 1000 disables the abort down ramp functionality.

Symbol	Index	Default	Value range
Sr	4y17	0	Must be set at 1
Lr	4y19	0	0 (linear) to 10 (max progressive)
Lf	4y20	0	0 to 10
Tro	4y21	1	1 to 1000 (ms)
Tfo	4y23	350	1 to 1000 (ms)
YsetFr	4y32	1000	0 to 1000 (1 unit = 0.1% of max. flow)
Tfr	4y33	100	1 to 1000 ms Tfr shall be smaller than Tfo and less than 150 ms.
YAbortDownRamp	4y34	0	0 to 500 (1 unit = 0.1% of max. flow). The default value will force an down-ramp abort at a slight reverse port flow request. Typically YAbortDownRamp needs be increased to avoid unintentional down-ramp aborts as this will infer a jerk on the driver.
Tra	4y35	1	1 to 1000 ms Ramp-down time for canceled down-ramp
The discontinuities in the progressive characteristic are located at 50, 120 and 333 ([5.0;T at 25], [12.0;T at 50] and [33.3;T at 75] of max port flow capacity)			

Select Ramps with Ramp Time Related to Vehicle Speed

To optimize the anti-jerk performance to different work cycles, the vehicle speed can be used to derive ramp times by interpolation between ramp values for 0 km/h.

Steering by Low Priority Steering Device – Open Loop

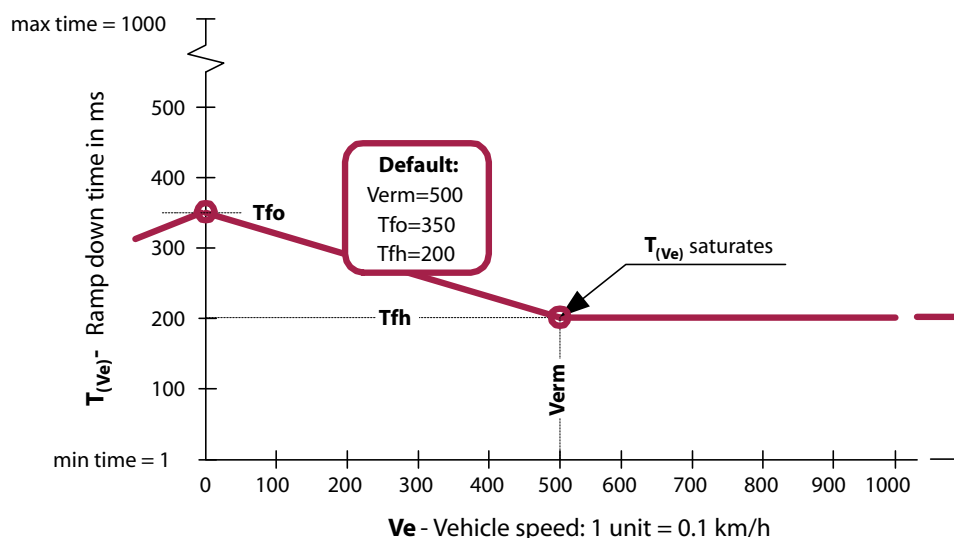
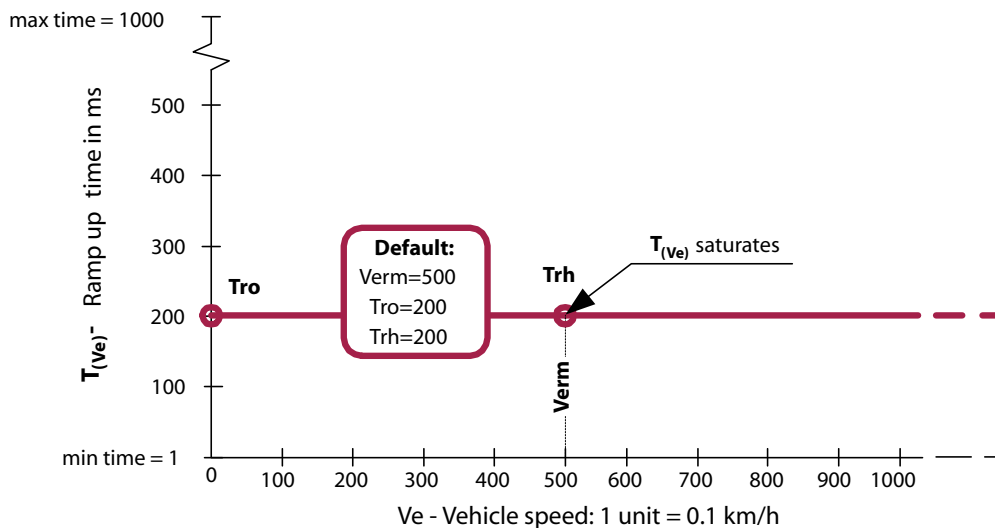

P005 218E

Sr Selects the ramp type. The ramp function can be disabled, fixed or related to vehicle speed. Set Sr to 21 to select vehicle speed dependant ramps.

Lr Sets the linearity of the ramp-up curve.

The default value is a linear ramp.

Lf Sets the linearity of the slow ramp-down curve.

The default value is a linear ramp.

Tro Sets the ramp-up time to open the valve from zero to max port flow when the vehicle speed is 0 kmph. The time applies for both ports.

To gain the best performance, the ramp-up time shall be set larger than the inherent ramp up time of the main spool. See [Technical Data](#) on page 24.

Tfo Sets the ramp-down time to close the valve from max to zero port flow when the vehicle speed is 0 kmph. The time applies for both ports. It has most effect when the ramp-up time is set larger than the inherent ramp down time of the main spool. See [Technical Data](#) on page 24 for these data.

Steering by Low Priority Steering Device – Open Loop

Trh Sets the ramp-up time to open the valve from zero to max port flow when the vehicle speed is equal to Verm kmph. The time applies for both ports.

To gain the best performance, the ramp-up time shall be set larger than the inherent ramp up time of the main spool. See [Technical Data](#) on page 24 for these ramp times.

Tfh Sets the ramp-down time to close the valve from max to zero port flow when the vehicle speed is equal to Verm kmph. The time applies for both ports. It has most effect when the ramp-up time is set larger than the inherent ramp down time of the main spool. See [Technical Data](#) on page 24 for these ramp times.

Verm Sets the region (in kmph) where ramp-up (Trh) and ramp-down (Tfh) time is variable to vehicle speed.

YsetFr Experience shows that ramping down from maximum flow towards medium flows do not cause as much jerk as ramping down from medium flows towards no flow (close to the valve dead-bands). In order to “expedite” the ramping at large flows, a flow range can be set up where the spool can move faster down to a flow range, where the slow down ramp is active. The overall goal with the parameter is to optimize steering response time without degrading the anti-jerk performance. Set up fast ramp down time Tfr before tuning this parameter. Setting YsetFr to 1000 eliminates the effect of the fast ramp down. Typical settings are 500-800. Use trial and error.

Example:

A value of 800 can be interpreted as allowing the spool to ramp down with a fast ramp for flow requests between maximum flow (1000) and 800/1000 of maximum flow.

Tfr This time defines the applied ramp time in the fast ramp-down range. It is defined as the ramp time from maximum flow to no flow. This means that in practice, the actual fast ramp-down time is proportional to the fast ramp-down range divided by 1000.

Use this optimization criterion: Ramp down as fast as possible for flow ranges, where jerks are not significant. Typical values are 1-50 ms. The fast ramp down time shall always be less than the slow ramp-down time. Once the value is set, it should not be adjusted anymore during further ramp parameter optimization.

YAbortDownRamp To come around the problem of slow steering response for large down-ramp times, especially if a sudden emergency change of direction is needed, a slow down-ramp can be aborted by requesting a flow in the opposite direction. Once a slow down-ramp is aborted, an abort down-ramp time, Tra is applied. Obviously Tra shall be significantly smaller than the slow down-ramp to get any effect.

Tra is the ramp-down time applied when the slow down-ramp is aborted. This rampdown time shall typically be much lower than the slow ramp-down time, Tfo, in order to gain any increased steering responsiveness. Typical value is half the value of Tfo or Tfh time if vehicle speed dependency is applied (Sr=2). Use trail and error.

Example:

A value equal to 500 means that the driver needs to steer out 500/1000 of maximum flow before the slow down-ramp is aborted. 500 again corresponds to a certain steering wheel RPM.

Typical values are 100-300 to have the abort down ramp possibility and to avoid unintentional abort of the down ramp due to steering wheel activation due to vibrations. Setting the value to 1000 disables the abort down ramp functionality.

Symbol	Index	Default	Value range
Sr	4y17	0	Must be set at 2
Lr	4y19	0	0 to 10 (linear to max progressive)

Steering by Low Priority Steering Device – Open Loop

Symbol	Index	Default	Value range
Lf	4y20	0	0 to 10
Tro	4y21	200	1 to 1000 ms
Tfo	4y23	350	1 to 1000 ms
Trh	4y22	200	1 to 1000
Tfh	4y24	350	1 to 1000
Verm	4y25	500	0 to 1000 (1 unit is 0.1 km/h)
YsetFr	4y32	1000	0 to 1000 (1 unit = 0.1% of max. flow). Fast ramp-down is active in the port flow request range 1000 to YsetFr. The default value disables fast ramp-down.
Tfr	4y33	100	1 to 1000 ms. Tfr shall be smaller than Tfo and less than 150 ms.
YAbortDownRamp	4y34	0	0 to 500 (1 unit = 0.1% of max. flow). The default value will force an down-ramp abort at a slight reverse port flow request. Typically YAbortDownRamp needs be increased to avoid unintentional down-ramp aborts as this will infer a jerk on the driver.
Tra	4y35	1	1 to 1000 ms Ramp-down time for canceled down-ramp

The discontinuities in the progressive characteristic are located at 50, 120 and 333 ([5.0;T at 25], [12.0;T at 50] and [33.3;T at 75] of max port flow capacity)

Anti-jerk Ramp Parameter Tuning Guide

Tuning the parameters is an iterative process. The following sequence may be useful when tuning a vehicle:

1. Initial setting: Set Tro to Tfr to Set YsetFr to 1000. Set Tra to Set YabortThreshold to 500.
2. Set the ramp-down time, Tfo, to a start value e.g. 500.
3. Decrease YsetFr from 1000 towards a smaller number. Observe which value of YsetFr where the level of jerks starts to get worse to find the flow request range, where ramping has an effect. Optionally increase Tfr to optimize on the fast ramp-down operation. Tfr should not exceed 150 ms and always be smaller than Tfo.
4. Adjust the ramp-down time, Tfo, until at good anti-jerk performance is achieved.
5. Increase the ramp-up time, Tro, to further improve the anti-jerk performance. Tro is typically smaller than Tfo.
6. Fine-tune the performance by experimenting with Tfr, Tra, and YsetFr. Note that the largest jerks shall be tuned away with the ramp-up time, Tro, and ramp-down time, Tfo.
7. Finally the YAbortThreshold and Tra may be adjusted. Consider how many steering wheel RPM is needed to abort the down-ramp. Secondly, adjust Tra to reduce the jerk when aborting the down-ramp. Obviously, Tra needs to be less than the down-ramp time, Tfo to get a faster steering response. Typical values for Tra is 50 – 100 ms.

The above typical parameter settings may vary from vehicle to vehicle.

Soft (Cushion) End-stop

To prevent the steering actuator to hit the mechanical end lock with great speed, the PVED is able to slow down the actuator speed when approaching the end lock electronically.

This functionality can be applied only in open-loop control mode, but requires that Steered wheel feedback sensor is mapped and mounted on either the steered wheel or cylinder, to indicate the motion-range.

Steering by Low Priority Steering Device – Open Loop

The red line in the figure below shows how the actuator is slowed down near the end lock position. The black line in the figure below shows how port flow is reduced. The steering actuator signal must be present in the PVED for this functionality to work.

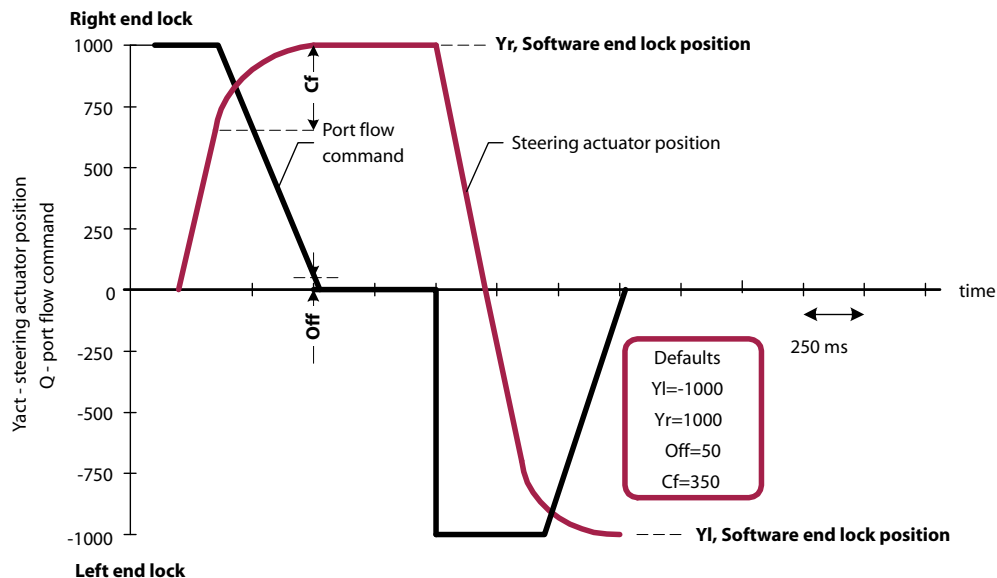

P005 221E

YR, YL The difference between the values of both parameter set the freedom of the steering actuator. Normally, YR is set equal at the right mechanical end lock. YL is normally set equal to the left mechanical end lock. For example, setting YR at 500 and YL at -500 reduces the freedom of the actuator by 50%. The default values for YR and YL are set equal to position of the mechanically end locks.

Cf Sets the region where actuation speed is slowed down. This region starts from the position defined by YR and YL. Making this region to small reduces or can eliminate the effect of soft stop.

The default value for Cf ensures the valve is closed proportionally with actuator position.

Off This parameter sets the permitted actuation speed when hitting the end lock defined by YR or YL. When the steering actuator passed YR or YL, actuation speed will decay to zero.

The default sets a speed that allows building up pressure when the actuator is located at YR or YL.

Symbol	Index	Default	Value range
YR	4y07	1000	-1000 – 1000, Values smaller than 0 will be set equal to the positive equivalent
YL	4y08	-1000	-1000 – 1000, Values greater than 0 will be set equal to the negative equivalent
Off	4y28	50	0 to 1000 (0.0 - 100.0% of max port flow)
Cf	4y29	333	1 to 1000

See chapter Mapping steering signals, Steering actuator Sensor (feedback from vehicle wheels) and Steering actuator position to acquire “steering actuator position”.

Tolsout Maximum time where the main spool is allowed to be operated proportionally within the valve dead-bands. The main spool control range for this function can be seen on the [Dead-band crossing](#) on page 26. This function is useful to eliminate frequent spool relocating events from its neutral to its dead-band position and back (so called jumps) at small flow requests.

The flow request is 0 while moving the high priority steering device within the steering device dead-band, db (see [Set-point Transfer Function](#) on page 87).

Steering by Low Priority Steering Device – Open Loop

Spool Dead-band Hold Control Function

Dead-band Jump Control

Set Tolsout lower than 21 (ms) to momentarily set the main spool in neutral as soon as the flow request is 0, No proportional spool movement will take place. The spool will jump from neutral to either of the valve dead-bands depending on a flow request. The steering device dead-band, db, has no impact for these Tolsout values.

Dead-band Hold and Proportional Control

Setting Tolsout between 21 and 30000 (ms) defines the maximum time where the main spool is either set on the valve dead-band or controlled proportionally within the valve dead-band (granted that the flow request is 0 during this time).

After a flow request to either left or right port, the main spool will be set on the respective left or right valve dead-band. Any steering device movement within the defined steering device dead-band, db, will result in proportional main spool movement. Proportional control will be allowed for Tolsout ms.

If the flow request has been 0 for Tolsout ms, the main spool will be set in neutral and any steering device movements within db will be ignored.

To utilize proportional control, a steering device dead-band, db, needs to be created. If db is set a low value, the main spool will effectively be operated as dead-band jump control.

Responding to Flow Requests after Tolsout

If the main spool has been set in neutral after Tolsout ms, any flow request will cause the spool to immediately jump to the relevant spool position with no initial proportional dead-band control.

Symbol	Index	Default	Value range
Tolsout	416	10 000	1 to 30 000 (ms)

Magnetic Valves OFF Control

Magnetic valves off delay time disables the magnetic valve bridge after a time specified in ms when the flow request is 0, otherwise it remains enabled. This parameter is used when electrical energy consumption by the magnetic valve bridge in the PVED must be reduced or to resolve a steering control conflict between the OSP and the PVED-CL (implementing EHPS type 1 systems only).

The default value disables this functionality i.e. the magnetic valve bridge is enabled at all times. The magnetic valve bridge is enabled when the PVED-CL receives a non-zero flow request.

Symbol	Index	Default	Value range
Magnetic valves Off delay time	415	30 000	1 to 30 000 (ms)

Resolving a Steering Control Conflict

On systems utilizing a PVED-CL, an EHPS valve, an OSP, a CAN or analogue steering device but no steering wheel angle sensor (SASA) (EHPS type 1), the PVED-CL has no means to detect that the steering wheel is being activated. A steering conflict between OSP steering and steering device steering is thus possible. To resolve this conflict, set Tolsout to a value (typically 50 ms – 200 ms) to disable the magnetic valve bridge when no flow request is being commanded with the steering device.

Steering by Low Priority Steering Device – Closed Loop

Steering by High Priority Steering Device – Closed Loop

EHPS Type 2 Automatic Steering Diagram

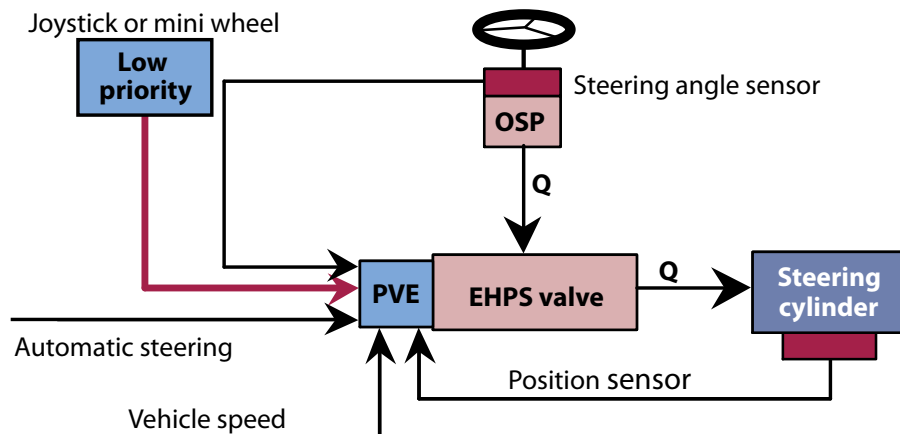

Functionality Tree

The tree below illustrates the functionality available in the PVED for steering by a potentiometer device or by joystick or by mini wheel with speed output. The manufacturing default functionality is found by following the red line. It can of course be modified by following the instructions in this chapter. The switches in the tree are used to select the functionality required. In case different functionalities are required, the EHPS software provides 5 programs from which the driver can select when the system is fully operative.

For steering by a device without spring return the PVED provides closed loop position control. The steering signal is monotonic and represents the angle of the physical device. These devices are normally friction held to prevent unintentionally steering due to machine vibrations

Use this mode for implementation of proprietary auto-guidance applications i.e. auto-guidance applications that do not conform to the ISO standardized auto-guidance messages (see [Auto-steering](#) on page 105).

Steering by Low Priority Steering Device – Closed Loop

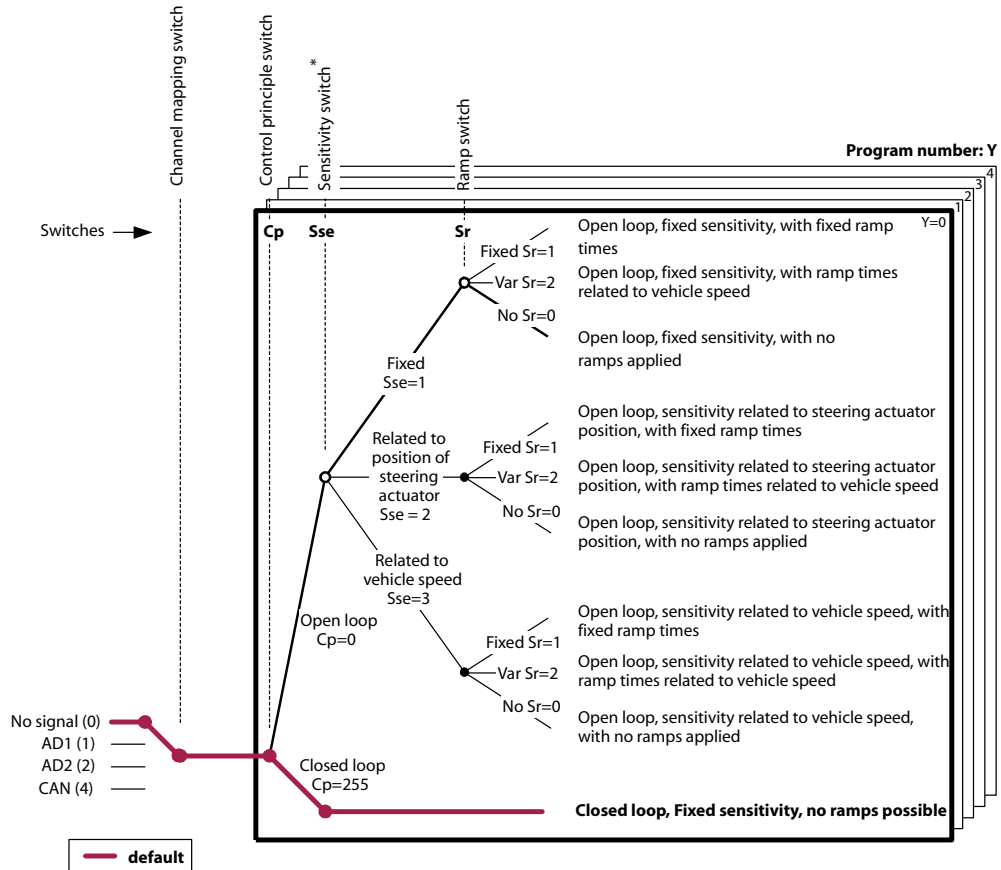

* Sensitivity means: Port flow amplification

P005 089E

Tracking

For safety reasons, a tracking function ensures bump-less transition on control loop initialization. It forces the user initially to operate the potentiometer knob into a position that matches zero deviation between set point and current steering actuator position or by sweeping through it. While tracking, the commanded port flow is limited at zero.

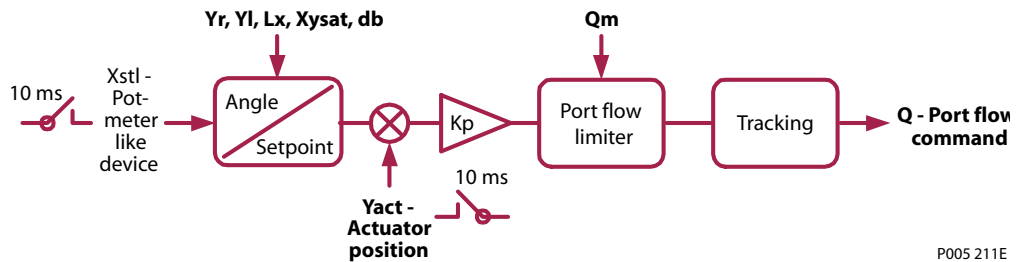

P005 211E

Select the Control Principle

Cp selects the closed loop control using parameter index 4y02 equal to 255. **Y** selects the program and ranges from 0 and 4. The value for **y** must be consistently used throughout the entire configuration of a single program.

Steering by Low Priority Steering Device – Closed Loop

Acquire the signals

See [Mapping a Steering Device](#) on page 34 on how to map an analogue or CAN-based high priority closed-loop steering device and steering wheel angle sensor.

Create the Set Point

A function provides 5 parameters to transform angle information to a steering actuator position set point.

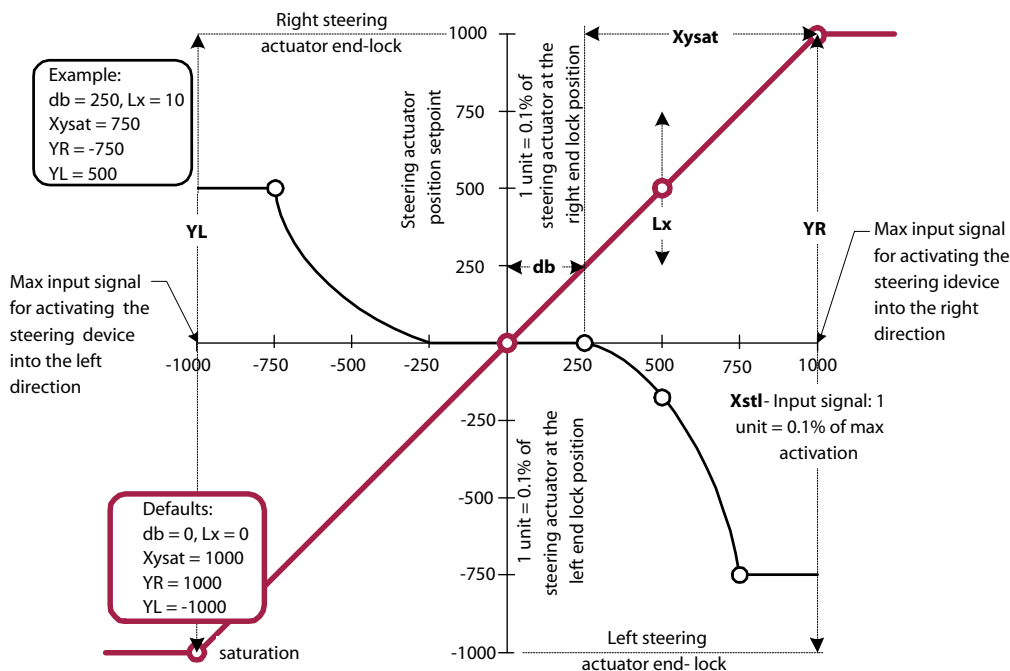

P005 212E

db Sets a dead band about the middle region of the signal. The parameters prevent self-steering, caused by manufacturing deviations in the signal when the handle is in the middle or released position. However, db is normally set to zero for pot-meter like steering devices.

The default value is set to serve pot-meter like steering devices

Lx Set the curve linearity. The parameter is set down when the cylinder position is too far (over-steer) for small steering angles or vice versa. The optimum value for this parameter is closely related to:

- The inherent linearity between steering actuator position and signal
- The inherent linearity between device handle angle and signal
- The inherent over or under-steer tendency of the vehicle when steering into curves
- The default value will not effect the resulting relation.

YR, YL The difference between the values of both parameter set the freedom of the steering actuator. Normally, YR is set equal at the right mechanical end lock. YL is normally set equal to the left mechanical end lock. This results in steering to the right direction. In case an opposite steering behavior is required, YR must be set at the negative equivalent and YL must be set at the positive equivalent (See example). The default value for YR and YL is set equal to the mechanical locks of the steering actuator resulting in the vehicle to steer in the right direction.

Xysat Sets a threshold for the output to be at its maximum or minimum when the input signal exceeds the threshold value. Xysat is normally set down when more sensitivity is required than inherently available with the steering device.

The default value will not effect the inherent sensitivity of the steering device.

Steering by Low Priority Steering Device – Closed Loop

Symbol	Index	Default	Value range
db	4y05	0	0.0 to 250 (0.0 to 25.0% of max activation in the right steering direction)
Lx	4y06	0	-10 to 10 (-10 max regress, 0 linear, 10 max progress)
YR	4y07	1000	-1000 to 1000
YL	4y08	-1000	-1000 to 1000
Yxsat	4y03	1000	251 to 1000

Parameter Yxsat, db & Lx have same value in quadrant 2 & 3.
 Lx in quadrant 1 or 4 is located at: $[(X_{ysat}+db)/2;YR*(20-Lx)/40]$.
 Lx in quadrant 2 or 3 is located at: $[-(X_{ysat}+db)/2;YL*(20-Lx)/40]$.

Closing the Loop

Kp Amplifies the error between set point and current position. The optimum value for Kp is found when a non-lagging, accurate, non-oscillating steering actuation without overshoot is achieved at extreme low and high oil viscosities as specified in chapter: (robustness to changes sin dead times) and at low and near max steering pressure when driving at low, high vehicle speed and reversed gear (robustness to changes in damping & dead times). Moreover, Kp is closely related to valve capacity, stroke volume. See section [Steady State Error](#) on page 61 for information on accuracy. The default value fits to steering systems with a lock-to-lock time of 2 seconds at max port flow.

Qm Sets the maximum port flow. It effects the speed of the steering actuator to move towards the set point position. Negative values of Qm are interpreted as the positive equivalent.

The default value is set equal to the inherent max port flow capacity of the valve and will therefore not have any effect.

Symbol	Index	Default	Value range
Kp	408	50	0 to 200 (0.00 to 2.00% of port flow capacity of the valve for 0.1% positional error)
Qm	4y27	1000	0 to 1000 (0.0 to 100.0 % port flow)

Eliminate Noise due to Frequent Pressure Build-up

Eliminating noise is accomplished by stopping the controller to respond to minor deviations between set point and current actuator position. The spool inside the valve is set in neutral when the port flow command has been within a threshold value (Qth) for a given time (Tclpout). The spool is reactivated again when port flow command exceeds the threshold.

Tclpout Sets the time delay (ms) before the main spool is set in neutral.

Qth Sets the threshold value for port flow command when the controller is in steady state.

Symbol	Index	Default	Value range
Tclpout	417	3000	1 to 30000 (ms)
Qth	418	50	0 to 100 (0.0 to 10.0% of max port flow)

Magnetic Valves OFF Control

Magnetic valves off delay time Disables the magnetic valve bridge after a time specified in ms when the flow request is 0, otherwise it remains enabled. This parameter is used when electrical energy consumption by the magnetic valve bridge in the PVED must be reduced or to resolve a steering control conflict between the OSP and the PVED-CL (implementing EHPS type 1 systems only).

The default value disables this functionality i.e. the magnetic valve bridge is enabled at all times. The magnetic valve bridge is enabled when the PVED-CL receives a non-zero flow request

Steering by Low Priority Steering Device – Closed Loop

Symbol	Index	Default	Value range
Magnetic Valves Off Delay Time	416	30 000	1 to 30 000 (ms)

Resolving a Steering Control Conflict

On systems utilizing a PVED-CL, an EHPS valve, an OSP, a CAN or analogue steering device but no steering wheel angle sensor (SASA) (EHPS type 1), the PVED-CL has no means to detect that the steering wheel is being activated. A steering conflict between OSP steering and steering device steering is thus possible. To resolve this conflict, set Tolsout to a value (typically 50 ms – 200 ms) to disable the magnetic valve bridge when no flow request is being commanded with the steering device.

Low Priority Steering Device Enable/Disable Control

The PVED functionality allows the user to dynamically enable or disable a steering device during operation from the cabin MMI (via CAN bus). This functionality enables e.g. an armrest device to be folded away for easy access to the cabin, while the system operational, to avoid the risk of unintended device activation when the user enters or leaves the cabin.

Another user scenario is to disable one or more lower priority steering devices when only the steering wheel device is in use for a longer period of time and the user wishes to eliminate the risk of unintentional device activation.

System Requirements

The device enable/disable control functionality is only functional if the following conditions are fulfilled.

The system must be in operational state. The device that shall be enabled/disabled is mapped. An OSP for hydraulic backup exists and the presence of the OSP is configured in the PVED.

Symbol	Index	Default	Value range
LowPrioritySteeringDeviceInterface	65103	0	0 (NONE), 1 (AD1), 2 (AD2), 4 (CAN)
OSP present	65109	0	0 (NONE), 255 (PRESENT)

If an OSP is not present, the device enable/disable control command is ignored. The OSP shall be present because it is theoretically possible to electrically disable all steering devices if the primary steering wheel sensor is not mapped. In this situation only the OSP pilot signals are driving the valve.

Caution

The vehicle system integrator shall consider the following to ensure a safe and reliable device enable/disable functionality. The vehicle velocity shall be included in the decision whether a device disable request shall be sent to the PVED or not. The location of the enable/disable button shall be well-considered to avoid unintentional enabling/disabling of a steering device. Unintended enabling/disabling should be further avoided by requiring the enable/disable button to be pressed for a well-defined period of time. The OEM shall ensure that a steering device outputs a signal within a valid range when the device is enabled.

Device Diagnostic Operation

The steering device diagnostic checks are performed both when the device is enabled and disabled.

Enable or Disable Joystick Steering Device

The device enable/disable control is executed by means of the DisableSteeringDevice command (see *PVED-CL Communication Protocol Technical Information, 11025584*) from e.g. the man machine interface. The DisableSteeringDevice command options are:

Steering by Low Priority Steering Device – Closed Loop

- Arm joystick enable/disable
- Enable joystick
- Disable joystick

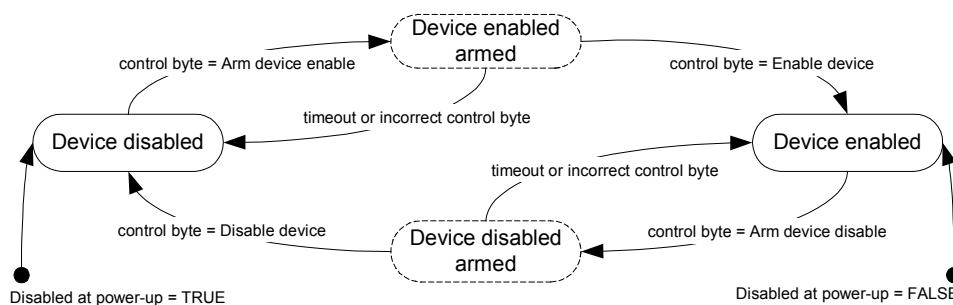

The enabling or disabling of a steering device must follow the state transition sequence shown below in order to minimize undesired enabling or disabling of a steering device.

The states, device enabled armed and device disabled armed are volatile states. A transition from these states to the desired state requires reception of a command message within 200 ms after the reception of first command message. Otherwise the device disable state will change back to its last state.

Boot-up State of Steering Device

The boot-up enable/disable state of the device can be configured with a parameter and can be changed via the SetParameter command (see *PVED-CL Communication Protocol Technical Information, 11025584*).

Symbol	Index	Default	Value range
LpStdDisabledAtBootUp	64009	0	0 (FALSE), 255 (TRUE)

LpStd means Low Priority Steering Device.
If the device disable functionality is not desired, the parameter shall be 0.

Getting the Actual Enable/disable Status of the Device

The PVED will send one DisableSteeringDeviceResponse reply message to each DisableSteeringDevice command it receives (or on time-out), containing the present enable/disable state for all steering devices. This reply may be used by the MMI for acknowledge or display purposes (see *PVED-CL Communication Protocol Technical Information, 11025584*).

The device enable/disable present status for all devices is also transmitted periodically in the OperationStatus message which is transmitted on the CAN bus by default (see *PVED-CL Communication Protocol Technical Information, 11025584*).

Auto-steering

Auto-steering

EHPS Type 2 Automatic Steering System Diagram

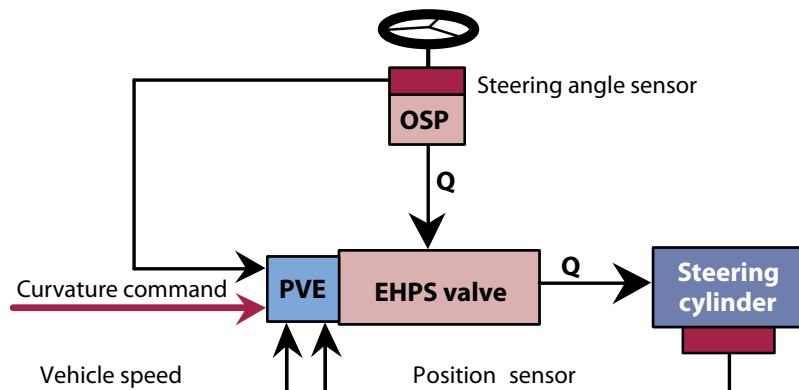

Guidance Commands

To facilitate the implementation of the PVED-CL for auto-steering or guidance, it is designed to use ISO11783 auto-guide messages. This means the PVED-CL can easily be integrated with any GPS, row-guide, or similar controller sending ISOBUS specific curvature commands.

Calculating the Wheel Angle

The messages **GuidanceSystemCommand** and **GuidanceMachineStatus** are defined in the *PVED-CL Communication Protocol Technical Information, 11025584*.

To position the wheels or the articulation angle correctly some vehicle geometry information is needed. The parameter values are used by the control algorithm to calculating from Curvature into wheel set-point (and from wheel set-point to Curvature for generating estimated curvature. The parameters and shown in the parameter table below.

Other parameters mentioned in this chapter can be used with default values and should only be adjusted if the performance needs fine-tuning.

Symbol	Index	Default	Value range
MaxWheelAngleLeft	65099	35 000	Maximum wheel angle to the left [mdeg]. Measured on the wheel where the wheel angle sensor is mounted.
MaxWheelAngleRight	65100	35 000	Maximum wheel angle to the right [mdeg]. Measured on the wheel where the wheel angle sensor is mounted.
VehicleLength	65112	4000	Wheelbase from front to rear axle in mm. Articulated vehicle: Distance from front axle to joint.
ValveType	65121	1	1 means EHPS or PVB, 2 means EH.
SteeringType	65122	1	1 means front wheel steering, 2 means rear wheel steering, 3 means articulated steering
VehicleLength2 (Only articulated)	65123	4000	Only used for articulated vehicles. Length from joint to rear axle.

Auto-steering

Closing the Loop

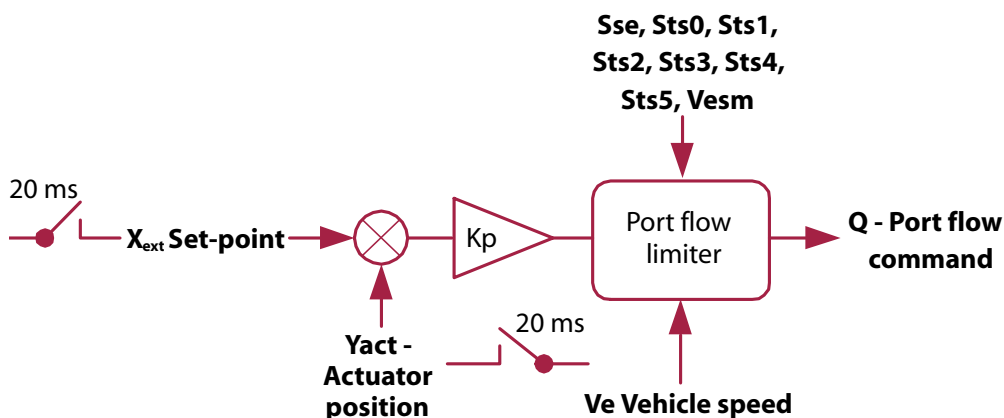

P005 208E

The auto-steering functionality always uses closed loop control, hence the steered wheel or articulation angle is read back to the PVED-CL, and used for control purposes to ensure correct positioning.

The functionality available in the PVED to steer by any curvature set-point controller is defined by mapping the External Set-point Controller and a Steered Wheel Sensor according to [Mapping a Steering Device](#) on page 34. As soon as these parameters are set, it is ready to run, but it is strongly recommended to have a steering wheel sensor to disengage auto-steering just by turning the steering wheel. Alternatively the power supply must be interrupted, or guidance message flagged as 'Not intended for steering'.

Trimming the System

To optimize the system functionality, ensure the parameters above were set correctly. If this was not enough, try changing the parameters below.

Kp This parameter is closely related to valve capacity, stroke volume and amplifies the error between set-point and current position. The optimum value for Kp is found when a non-lagging, accurate, non-oscillating steering actuation without overshoot is achieved at:

- Extreme low and high oil viscosities as specified in [Technical Data](#) on page 24.
- Low and near max steering pressure when driving at low, high vehicle speed and reversed gear

The default value fits to steering systems with a lock-to-lock time of 2 seconds at max port flow.

Qm Sets the maximum port flow. It effects the speed of the steering actuator to move towards the set point position. Negative values of Qm are interpreted as the positive equivalent.

The default value is set equal to the inherent max port flow capacity of the valve and will therefore not have any effect.

Ampl Factor that 'amplifies' the set-point. Used if the steered angle is always too small or too larger. It applies to both sides, hence if the angle is too large left, and too small right, this factor cannot solve it – that will probably be a steered wheel sensor calibration error.

ClosedLoopXspOffset Spool position offset which is added to spool position command to eliminate any spool overlap. The offset ensures that the spool is always operated in a range where the valve outputs a flow. This is especially important for auto-steering applications where any control error shall generate a flow to correct the error.

Symbol	Index	Default	Value range
Kp	508	50	0 to 200 (0.00 to 2.00 % flow capacity of the valve for 0.1 % positional error)

Auto-steering

Symbol	Index	Default	Value range
Qm	5y27	1000	0 to 1000 (0.0 to 100.0% of max port flow)
Ampl	5y37	1000	0 to 2000 (Factor 0.001; Setpoint from 0 to 2 times the setpoint message value)
ClosedLoopXspOffset	748	0	0 to 1000 (0 to ± 7 mm)

Kp and ClosedLoopXspOffset correlates. By increasing ClosedLoopXspOffset, the proportional gain may be reduced. It is recommended to first set ClosedLoopXspOffset to 20 and then tune Kp.

Noise due to Frequent Pressure Build-up

Eliminating noise is accomplished by stopping the controller to respond to minor deviations between set point and current actuator position. The spool inside the valve is set in neutral when the port flow command has been within a threshold value (Qth) for a given time (Tclpout). The spool is reactivated again when port flow command exceeds the threshold value.

Tclpout Sets the time delay (ms) before the main spool is set in neutral.

Qth Sets the threshold value for port flow command when the controller is in steady state.

Symbol	Index	Default	Value range
Tclpout	517	3000	1 to 30000 (ms)
Qth	518	0	0 to 100 (0.0 to 10.0 % of max port flow)

Qth may introduce a control dead-band which may not be desired. Set Qth to 0 for tight closed-loop control and for maximum precision.

Select a Fixed Sensitivity

A fixed steering sensitivity is chosen if the valve shall output a flow which is only dependent on the control error and Kp.

Sse Selects between a fixed steering sensitivity, variable to steering actuator position or vehicle speed. Set Sse to 1 to select the fixed sensitivity

Sts0 Sets a gradient between steering angle and requested port flow. Sts0 is normally set when max port flow (defined by Qm) is achieved at maximum steering device input.

The default value is a gradient matching maximum requested port flow to maximum port flow at the maximum steering angle.

Symbol	Index	Default	Value range
Sse	5y09	1	Must be set at 1
Sts0	5y10	1000	0 to 1000 (amplification of 0 to 100 %) Default Sts0 shall be changed to 1000.

Vehicle Speed Dependent Sensitivity

Variable steering sensitivity related to vehicle speed is normally used to optimize directional stability automatically and beyond the notice of the driver. The values and correlation is normally close related to the present vehicle dynamics of the individual vehicle model. The Sts value is used to amplify the input signal as described in [Set-point Transfer Function](#) on page 87 .

The correlation is defined by seven parameters. All Sts-parameters may be set equal to each other or set monotonically falling for increasing vehicle speeds. The steering sensitivity between two table coordinates is found by linear interpolation. The relation is equal for negative speeds.

Auto-steering

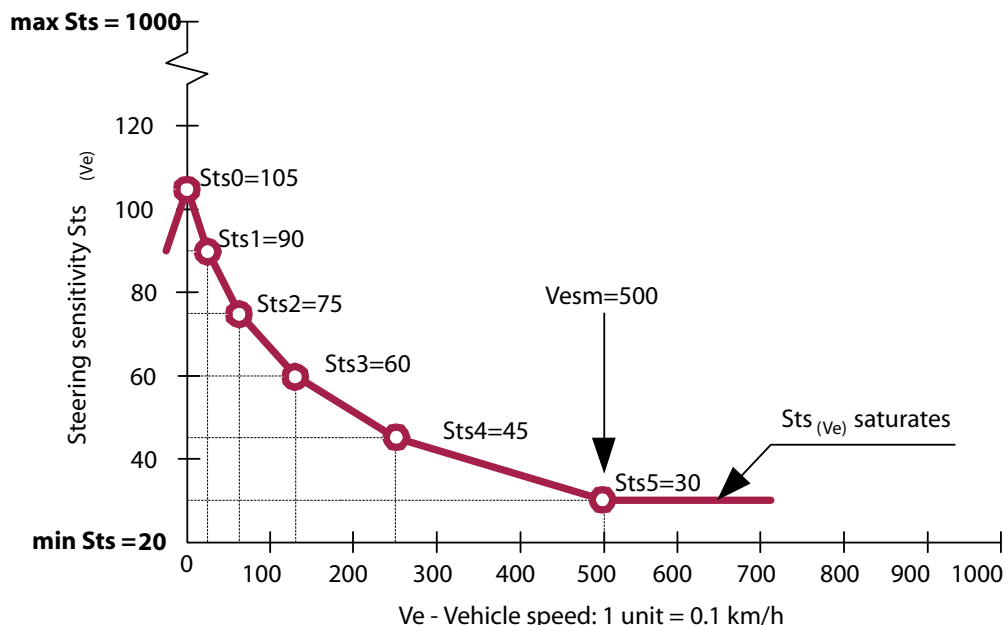

Sse Selects between a fixed steering sensitivity, variable to steering actuator position or vehicle speed. Set Sse to 3 to select the sensitivity related to vehicle speed.

Sts0 Sets the linear gradient between steering angle and requested port flow when the vehicle is standing still. When the vehicle signal unintentionally not is mapped, Sts0 is applied constantly since variable Ve remains 0.

In case the vehicle signal not is diagnosed, it is recommended to set Sts0 at a value where sufficient directional stability at maximum vehicle speed is present.

Sts1 Sets the linear gradient between steering angle and requested port flow when the vehicle is driving at 6.25% of the speed defined by parameter Vesm.

Sts2 Sets the linear gradient between steering angle and requested port flow when the vehicle is driving at 12.50% of the speed defined by parameter Vesm.

Sts3 Sets the linear gradient between steering angle and requested port flow when the vehicle is driving at 25 % of the speed defined by parameter Vesm.

Sts4 Sets the linear gradient between steering angle and requested port flow when the vehicle is driving at 50 % of the speed defined by parameter Vesm.

Sts5 Sets the linear gradient between steering angle and requested port flow when the vehicle is driving at 100 % of the speed defined by parameter Vesm.

Vesm Sets the region where steering sensitivity is variable to vehicle speed.

Symbol	Index	Default	Value range
Sse	5y09	1	Must be set at 3
Sts0	5y10	1000	20 to 1200 (Amplification of 0.2 to 12.00)
Sts1	5y11		20 to Sts0
Sts2	5y12		20 to Sts1
Sts3	5y13		20 to Sts2
Sts4	5y14		20 to Sts3
Sts5	5y15		20 to Sts4
Vesm	5y16	500	1 (0.1 km/h) to 1000 (100.0 km/h)

Auto-steering

Symbol	Index	Default	Value range
Please note the parameter dependency of Sts. See Mapping steering signals and J1939 Vehicle Speed to acquire " Vehicle speed"			

Magnetic Valves OFF Control

Magnetic valves off delay time Disables the magnetic valve bridge after a time specified in ms when the flow request is 0, otherwise it remains enabled. This parameter is used when electrical energy consumption by the magnetic valve bridge in the PVED must be reduced or to resolve a steering control conflict between the OSP and the PVED-CL (implementing EHPS type 1 systems only).

The default value disables this functionality i.e. the magnetic valve bridge is enabled at all times. The magnetic valve bridge is enabled when the PVED-CL receives a non-zero flow request.

Symbol	Index	Default	Value range
Magnetic valves Off delay time	515	30 000	1 to 30 000 (ms)

Resolving a Steering Control Conflict

On systems utilizing a PVED-CL, an EHPS valve, an OSP, a CAN or analogue steering device but no steering wheel angle sensor (SASA) (EHPS type 1), the PVED-CL has no means to detect that the steering wheel is being activated. A steering conflict between OSP steering and steering device steering is thus possible. To resolve this conflict, set Tolsout to a value (typically 50 ms – 200 ms) to disable the magnetic valve bridge when no flow request is being commanded with the steering device.

SASA disengage ability check

Disengaging auto-steering relies on the SASA sensor which transmits position changes when the steering wheel is activated as described in Steering Device Transition, page 33. To address the risk that the SASA steering wheel sensor should fail to deliver position changes (dx) to the PVED-CL – even if the steering wheel is activated - and thus not be able to disengage auto-steering - a SASA disengage ability check can be configured. The check is outlined below and will prevent auto-steering from being engaged if the SASA sensor is failing:

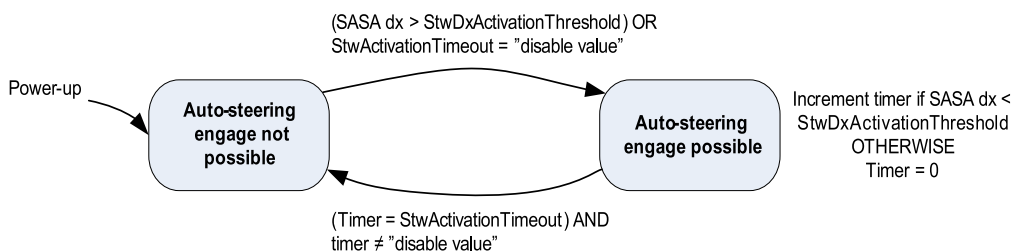

StwDxActivationThreshold The SASA steering wheel position change threshold, |dx|, which shall be exceeded before auto-steering can be engaged. The relation between dx and steering wheel rpm is: dx= 1 is equivalent to 1.4 rpm.

StwActivationTimeout The amount of time where immediate engaging auto-steering is kept possible after |dx| getting lower than StwDxActivationThreshold. "Kept possible" in this context means: Without first requiring detection of SASA steering wheel position changes.

Symbol	Index	Default	Value range
StwDxActivationThreshold	64022	5	0 to 4095
StwActivationTimeout	64023	0x7FFFFFFF	0 to 0x7FFFFFFF Default is also denoted "disable value". Time in ms.

Auto-steering** Warning**

It is recommended that the SASA disengage ability check is enabled in auto-steering applications to reduce the risk of not being able to disengage auto-steering with the steering wheel (SASA). Note that the check is not enabled by default.

Reduced State

Reduced State

The PVED-CL contains functionality that allows the system architect to set up a “graceful degradation” behavior if e.g. a sensor faults should occur. The overall objective is to sustain the machine up-time and to allow the driver to finish the mission with as much steering performance as possible.

Faults on the following sensors can be configured to allow the PVED-CL to enter reduced state:

- High Priority (HP) steering device faults
- Low Priority (LP) steering device faults
- Vehicle speed sensor faults
- Steered wheel angle sensor faults

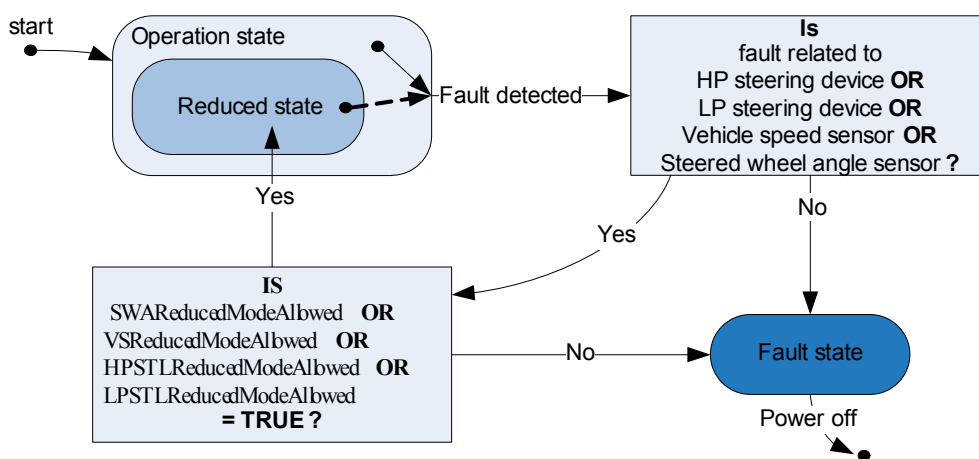

Reduced Steering Functionality

The steering functionality in reduced state is dependent on which of the allowed faults are present as presented below.

High Priority Steering Device Fault

HPSTDReducedModeAllowed parameter indicates to the PVED-CL error handler, that any fault related to the High priority steering device shall bring the PVED-CL into reduced state and change the high priority steering device functionality as follows:

- High priority steering device disabled
- High priority steering device enable not possible (see [High Priority Steering Device Enable/Disable Control](#) on page 83)

Symbol	Index	Default	Value range
HPSTDReducedModeAllowed	64013	0	0 (FALSE), 255 (TRUE)
The parameter controls both analogue and CAN based steering devices. 'False' infers that the PVED-CL will enter fault state if a fault occurs.			

The high priority steering device faults that can trigger reduced state can be found in [J1939 Diagnostic Interface](#) on page 115.

Reduced State

Low Priority Steering Device Fault

LPSTDReducedModeAllowed parameter indicates to the PVED-CL error handler, that any fault related to the Low priority steering device shall bring the PVED-CL into reduced state and change the Low priority steering device functionality as follows:

- Low priority steering device disabled
- Low priority steering device enable not possible (see [Low Priority Steering Device Enable/Disable Control](#) on page 103)

Symbol	Index	Default	Value range
LPSTDReducedModeAllowed	64014	0	0 (FALSE), 255 (TRUE)
The parameter controls both analogue and CAN based steering devices. 'False' infers that the PVED-CL will enter fault state if a fault occurs.			

The low priority steering device faults that can trigger reduced state can be found in [J1939 Diagnostic Interface](#) on page 115.

Vehicle Speed Sensor Fault

The vehicle speed signal may be used by more steering devices. Any fault on the vehicle speed sensor or signal will only affect the functionality that uses the speed signal. A steering device utilizing a speed dependent functionality will continue to work while by-passing the vehicle speed dependent function.

VSReducedModeAllowed This parameter indicates to the PVED-CL error handler, that any fault related to the CAN vehicle speed sensor shall bring the PVED-CL into reduced state and change steering functionality as follows:

- Speed dependent steering sensitivity is by-passed for all steering devices utilizing this functionality. The PVED-CL will assume maximum speed in the absence of a valid vehicle speed signal. See [Select a Sensitivity with Relation to Vehicle speed](#) on page 90.
- Speed dependent ramp is by-passed for steering devices utilizing this functionality. The PVED-CL will assume maximum speed in the absence of a valid vehicle speed signal. See [Select Ramps with Ramp Times Related to Vehicle Speed](#) on page 50.
- Program transition will ignore vehicle speed condition rule. See [System State](#) on page 20.

Symbol	Index	Default	Value range
VSReducedModeAllowed	64012	0	0 (FALSE), 255 (TRUE)
'False' infers that the PVED-CL will enter fault state if a fault occurs.			

The vehicle speed sensor faults that can trigger reduced state can be found in Available J1939 Diagnostic Trouble Codes, page 135.

Steered Wheel Angle Sensor Fails

The steered wheel angle sensor signal may be used by more steering devices. Any fault on the steered wheel angle sensor or signal will only affect the functionality that uses the steered wheel angle signal. A steering device utilizing this signal will continue to work while by-passing the functionality using the steered wheel angle sensor signal.

SWAReducedModeAllowed parameter indicates to the PVED-CL error handler, that any fault related to the steered wheel angle sensor shall bring the PVED-CL into reduced state and change steering functionality as follows:

Reduced State

- Soft-stop functionality is by-passed
- Actuator dependent steering sensitivity is by-passed.
- Closed-loop control with any steering device or external set-point controller is not possible.

Symbol	Index	Default	Value range
SWAReducedModeAllowed	64011	0	0 (FALSE), 255 (TRUE)
'False' infers that the PVED-CL will enter fault state if a fault occurs.			

The steered wheel angle sensor faults that can trigger reduced state can be found in [J1939 Diagnostic Interface](#) on page 115.

Diagnostic & Troubleshooting

Diagnostic

Any detected fault will bring the PVED-CL in reduced state or fail-safe state. Fail safe state infers that the magnetic bridge is disabled and no pilot flow from the PVED-CL controls the valve. A fault that brings the PVED-CL in fail-safe state is denoted a 'critical' fault. All critical faults are stored in the PVED-CL error buffer for diagnostic purposes.

The PVED-CL may be accessed via CAN for diagnostic purposes while being in fail-safe state but parameter configuration is not possible in fail-safe state. If the fault is related to the sensors or CAN bus cable tree, these faults should be resolved and the PVED-CL should be powered up again. If the fault requires parameters to be changed, the user must bring the PVED-CL in calibration mode (or operational or reduced state if possible) before re-configuring the parameters.

Example on Resolving a Fault

A sensor is mapped (see [Mapping a Steering Device](#) on page 34) as present but does not exist in the system. The sensor cannot be unmapped because the PVED-CL enters fail-safe state when powered on.

Solution

The PVED-CL needs to run in operational, reduced state or calibration state before any parameter may be changed i.e. a) Simulate the sensor signal to satisfy the PVED-CL sensor checks while changing the parameter or b) power up the PVED-CL in calibration mode.

Troubleshooting

The PVED-CL software performs diagnostic checks on the CAN bus interface, analogue sensors, magnetic valve bridge interface, internal hardware peripherals and software execution plausibility. All detected faults, which are rated as safety critical, will bring the PVED-CL in to its fail-safe state. Secondly the diagnostic checks provide precise indication of the fault source and thus reduce system down-time.

However, not all unexpected system behavior can be traced via error codes. E.g. a too low gain-related parameter value may result in too slow steering actuation but this cannot be detected as a fault. To rule out faults resulting from conflicting system and parameter settings, the following trouble shooting steps are recommended:

- Check the list of typical faults first
- Check the J1939 Diagnostic interface
- Check the PVED-CL LED diagnostic interface (see [LED Diagnostic](#) on page 119)

Typical Fault Sources

The table below contains symptoms and possible resolutions. The PVED-CL operation status is the status reflected in the CAN OperationStatus message (see [PVED-CL Communication Protocol Technical Information, 11025584](#)), which is transmitted periodically on the CAN bus. If the PVED-CL operation status is not available on the CAN bus, check the LED diagnostic interface see [LED Diagnostic](#) on page 119).

Symptom	PVED-CL Operation Status	Cause/Solution
No actuation (with high or low priority steering device or external set-point controllers)	Operational	<ol style="list-style-type: none"> 1. No or insufficient pressure is supplied to the valve. 2. No steering device is mapped. 3. Parameter Qm set to ~0 4. No or incorrect auto-steering message from external set-point controller 5. Spool sticks in neutral position
	Fault	<ol style="list-style-type: none"> 1. No or missing signal from steering signals at the AD1, AD2 or CAN interface. 2. Missing sensor signal (see J1939 Diagnostic Interface on page 115). 2. PVED-CL expects a different baud rate at network. 3. Insufficient electrical power supply to the PVED-CL.

Diagnostic & Troubleshooting

Symptom	PVED-CL Operation Status	Cause/Solution
		4. PVED-CL has suffered a internal critical error.
	No status available	1. CAN bus not operational. Check connection. 2. No electric power supply 3. PVED-CL is damaged. (see LED Diagnostic on page 119).
Opposite actuation	Operational	1. Hoses between valve and steering actuator are swapped. 2. Steering wheel angle sensor (and possibly OSP) is incorrectly installed. 3. Steering device input transfer function is mirrored. 4. The InvertInputSignal program parameter is set incorrectly (see page 127). 5. The ValveType parameter is set incorrectly (see page 124). 6. Steered wheel sensor outputs a constant valid voltage/value (closed loop).
Slow actuation responds (delays)	Operational	1. Air is trapped in the steering actuator or hoses. 2. Oil has high viscosity. Make sure to apply to the technical requirements listed in Technical Data on page 24. 3. The requested pressure is supplied with some delay (Pump).
Self-steering	Operational	1. The parameters Xspr_0 and Xspl_0 in the PVED-CL are not correctly set relative to the mechanical dead-band location in the spool-opening characteristic. Read more information in Valve Interface on page 25. 2. The actual neutral position and calibrated neutral position (steering devices such as joysticks, etc.) do not match and causes a small output flow when the device is activated. 3. PVED-CL neutral spool position calibration is incorrect and needs re-adjusting (mechanical valve defect). 4. Auto-steering is not disabled when a higher priority device is selected. Check if higher priority devices are mapped. 5. Steering device dead-band is too small – noise may activate the device and cause the spool to jump between left and right valve dead-band.
Actuation with low gain	Operational	1. The amplification parameters (Sts) are set at a too low value (for steering devices) and too high for the steering wheel sensor. Read more information on Select a fixed sensitivity . 2. The gain linearity index (Lx) is set at a high value. 3. Parameter "Vcap" is set greater than the true flow capacity of the valve. 4. Steering wheel angle sensor is installed upside down (causing a conflict with the OSP pilot signals). 5. The soft-stop functionality limits the flow because the steered wheel angle sensor input is not correctly calibrated, mirrored or constant. 6. (Soft-stop). The steered wheels are being driven beyond the logical end-stop values (maximum output flow in determined by the Off parameter). 7. The maximum flow parameter (Qm) is set too low for the particular program. 8. Then SASA sensor is not mapped as present – only the OSP is driving the valve. 9. The full range of a steering device relative to its calibration range is not being fully utilized. 10. If velocity dependent steering sensitivity is applied, the Sts settings may be incorrect or the vehicle speed sensor outputs wrong data.
	Fault	The hydraulic back-up system is active. The steering sensitivity is determined by the OSP.

J1939 Diagnostic Interface

There are two ways of accessing fault codes in the PVED-CL as outlined in a figure below.

- Via J1939 diagnostic interface (SAE J1939-73)
- Via J1939 proprietary protocol (PDU1 format)

Diagnostic & Troubleshooting

Accessing fault codes in the PVED-CL

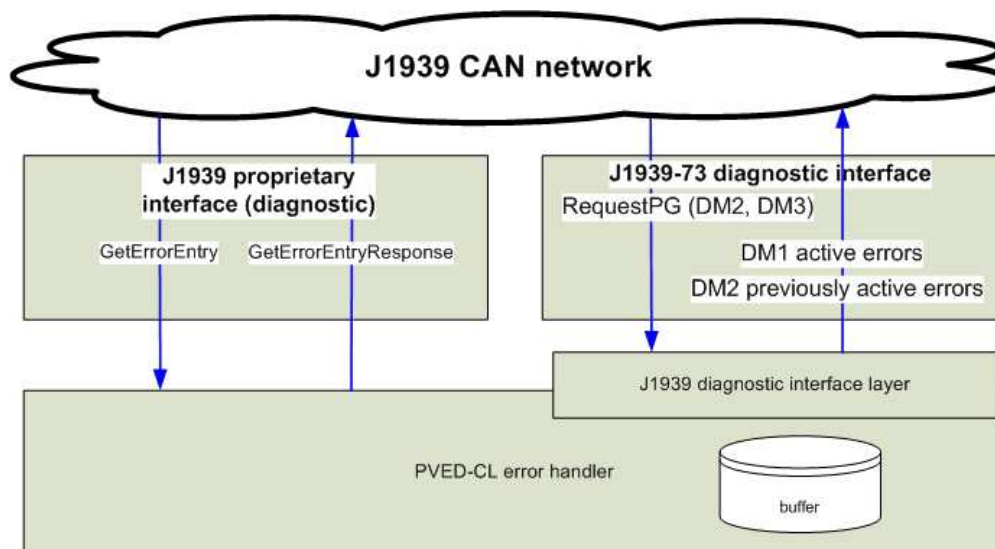

The PVED operation status is the status reflected in the OperationStatus message (see PVED-CL Communication Protocol Technical Information, 11025584) which is transmitted cyclically on the CAN bus. If the PVED operation status is not available, check the LED diagnostic, [LED Diagnostic](#) on page 119.

Available J1939 Diagnostic Trouble Codes

SPN	Description	Lamp Status	FMI	CM	OC	Corresponding PVED-CL Error Code
1083	AD1 short-circuit to GND	Red/Amber	4	0	Yes	10106
1083	AD1 short-circuit to VCC		3	0	Yes	10108
1084	AD2 short-circuit to GND		4	0	Yes	10107
1084	AD2 short-circuit to VCC		3	0	Yes	10109
611	Missing sensor set-points	Red/Amber	14	0	Yes	10210, 10212-10215, 10218-10221, 10223-10226, 10229-10231
612	Redundant wheel angle sensor values deviate too much or CAN sensor set-point data out of range		14	0	Yes	10104, 10105, 10232, 10234-10238
613	Steering wheel speed plausibility check failure	Red	14	0	Yes	13063
84	Vehicle speed CAN sensor data plausibility check failure	Red/Amber	12	0	Yes	10217, 10228
627	Power supply voltage below min. threshold value	Red	4	0	Yes	13030
627	Power supply voltage exceeds max. threshold value		3	0	Yes	13031
1079	Sensor supply voltage below min. threshold value		4	0	Yes	13032
1079	Sensor supply voltage exceeds max. threshold value		3	0	Yes	13033
614	Loss of main spool control or spool position plausibility check failure	Red/Amber	14	0	Yes	13053, 13054
615 (1)	Vehicle speed CAN sensor data plausibility check failure		14	0	Yes	13064
615 (2)	Internal PVED-CL error (= any other classified as critical)	Red	14	0	Yes	any other classified as critical

Diagnostic & Troubleshooting

1. This has been separated from the next row SPN 615 as this is the only case when the DTC with SPN 615 can signal the Lamp status set to Amber.
2. SPN 615 with the Lamp status set to Red indicates that other critical EHPS error has happened. The user must retrieve an error code from the EHPS error buffer and use the table in section 2 to locate the source of a problem.

The PVED-CL supports DM1, DM2 and DM3 according to SAE J1939-73 diagnostic protocol (see *PVED-CL Communication Protocol Technical Information, 11025584*).

A sub-set of all possible PVED-CL fault codes are represented as standardized J1939-73 Suspect Parameter Numbers (SPN). The sub-set is limited to interface-related faults, which are typically causing most troubles.

AD1 and/or AD2 Short-circuit

Each of the two analog input ports are monitored for short-circuits to GND, VCC or positive battery supply. The Failure Mode Identifier (FMI) differentiates between the two type of short-circuits. An internal pull-down resistor on both analog input ports will pull the input level to GND if an analog input port is left open. No analog input diagnostic is active if the analog input is not mapped.

Missing CAN Sensor Set-points

SPN 611 indicates a fault due to invalid timing or missing input signals from the sensors, most likely due to a failing CAN sensor or cable tree fault. In this context, input signals are both CAN messages and analog samples from sensors. However, missing analog samples or invalid timing of analog samples can only be caused by an internal PVED-CL fault – nothing can be concluded about the analog sensors from this SPN.

Invalid timing means that the requirements to the period that data has to be received within, has not been met. This could again be caused by an incorrectly configured CAN sensor or a heavy CAN bus-load, restricting the CAN sensor messages to be transmitted at their expected time.

SPN	PVED-CL Error Code	Possible root cause
611	10210	SASA steering wheel sensor message period exceeds 100 ms
	10212	High Prio. steering device CAN sensor message period exceeds 100 ms
	10213	Low Prio. steering device CAN sensor message period exceeds 100 ms
	10214	Primary wheel angle CAN sensor message period exceeds 100 ms
	10215	Redundant wheel angle CAN sensor message period exceeds 100 ms
	10218	Analog input 1 sample period exceeds 5 ms. Internal PVED-CL fault
	10219	Analog input 2 sample period exceeds 5 ms. Internal PVED-CL fault
	10220	Analog spool position input sample period exceeds 5 ms. Internal PVED-CL fault
	10221	SASA steering wheel sensor messages are missing
	10223	High priority steering device CAN sensor messages are missing
	10224	Low priority steering device CAN sensor messages are missing
	10225	Primary wheel angle CAN sensor messages are missing
	10226	Redundant wheel angle CAN sensor messages are missing
	10229	Analog input 1 samples are missing. Internal PVED-CL fault
	10230	Analog input 2 samples are missing. Internal PVED-CL fault
10231	Analog spool position input samples are missing. Internal PVED-CL fault	

Diagnostic & Troubleshooting

Redundant Wheel Angle Sensor Values Deviate too much or CAN Sensor Set-point Data out of Range

SPN 612 indicates more faults, depending on the actual system configuration i.e. many of the PVED-CL error codes can be ignored by using the knowledge of the actual sensor mapping.

SPN	PVED-CL Error Code	Possible root cause
612	10104	The primary steered wheel angle sensor set-point and the redundant steered wheel angle sensor set-point deviates too much. One of the sensors may not work or the sensor values differs due to a physical sensor offset
	10105	The deviation between the primary steered wheel angle sensor set-point and the redundant steered wheel angle sensor set-point exceeds the valid range.
	10232	The SASA steering wheel sensor set-point exceeds the valid range.
	10234	High priority steering device CAN sensor set-point exceeds the valid range.
	10235	Low priority steering device CAN sensor exceeds the valid range.
	10236	Primary wheel angle CAN sensor set-point exceeds the valid range.
	10237	Redundant wheel angle CAN sensor set-point exceeds the valid range.
	10238	External CAN set-point generator curvature or spool position set-point exceeds the valid range.

Steering Wheel Speed Plausibility Check Failure

SPN 613 indicates an abnormal steering wheel activation i.e. the measured rpm exceeds 600 rpm.

Vehicle Speed CAN Sensor Data Plausibility Check Failure

SPN 84 indicates that the vehicle speed sensor data is invalid.

SPN	PVED-CL Error Code	Possible root cause
84	10217	Vehicle speed CAN sensor message period exceeds 150 ms.
	10228	Vehicle speed CAN sensor messages are missing.

Power Supply Voltage

SPN 627 indicates that the battery voltage supply is either below 9V or has exceeded 32V.

Sensor Supply Voltage

SPN 1079 indicated that the regulated 5V supply for external sensors is out of range. This could be due to a short-circuit, overload or an internal PVED-CL hardware fault

Loss of Main Spool Control or Spool Position Plausibility Check Failure

SPN 614 indicates that the main valve spool is out of control. This may be caused by an incorrect sensor mapping i.e. if a SASA sensor is not mapped as present and the steering wheel is activated simultaneously with e.g. a joystick. Secondly it may indicate that the spool position signal is out of range. Subsequently the fault may also be traced to a PVED-CL hardware error.

SPN	PVED-CL Error Code	Possible root cause
614	13053	Main valve spool is out of control.
	13054	Main valve spool position signal is out of range.

Diagnostic & Troubleshooting

Internal PVED-CL Error

SPN 615 indicates that a critical PVED-CL fault has happened. The user must look up the EHPS error buffer to retrieve the EHPS error code and apply the table with PVED-CL error codes to locate the error source. The user shall locate the last entered error entry which is either the last error code before the 'No error' code or the error code at the last error entry. If the error buffer is filled up, new error codes will overwrite the error code in the last error entry.

LED Diagnostic

The PVED-CL has a LED mounted at the connector side for low level diagnostic.

LED color	PVED-CL Operation Status	PVED-CL Status
Black / Off	Not available	No battery power is supplied to the PVED-CL
Orange	Fault	PVED-CL is in fault state. More information is available in DM1 CAN message.
	Operational	PVED-CL is operational but no device has been selected. Once a steering device is activated, the LED changes to green.
Green	Operational	PVED-CL is operational
	Reduced	PVED-CL is in reduced state
	Calibration	PVED-CL is operating in calibration mode
Red	Not available	A critical PVED-CL specific fault has happened – PVED-CL is in fail silent state (silent ~ disconnected from the CAN bus)

Appendix

System Parameters

Index	Name	Description	Data Type	Range	Default	Locked	Not Restored
702	Lspl	Index for controlling linearity of left flow characteristic	S16	[-10 ; 10]	0		
703	Lspr	Index for controlling linearity of right flow characteristic		[-10 ; 10]	0		
706	Vcap	Valve capacity [l/min]	U16	[5; 120]	25		
707	StrkVol	Stroke Volume [cm3]		[100 ; 8000]	600		
725	RiOSP	Backlash of OSP		[0; 160]	50		
726	Sts_backup	Steering sensitivity of back up system		[300; 700]	500		
729	Xspl_1000	Max spool position at left side of neutral	S16	[-1000; -300] EH/OSPE [-1000; -400] EHPS	-1000	✓	✓
737	Xspl_0	Spool position at left spool dead band		[-250; 0] EH/OSPE [-350; 0] EHPS	-185	✓	✓
738	Xspr_0	Spool position at right spool dead band		[-250; 0] EH/OSPE [-350; 0] EHPS	185	✓	✓
747	Xspr_1000	Max Spool position at right side of neutral		[300; 1000] EH/OSPE [400; 1000] EHPS	25	✓	✓
748	ClosedLoopXspOffset	Auto-calibration set-point offset		[0; 300]	25	✓	✓
750	Ktol	Tolerance parameter for plausibility check and steering actuator dynamics	U16	[500; 1000]	800		
758	XspCalibrationOffSet	Auto-calibration set-point offset	S16	[0; 300]	25	✓	✓
798	Ve_100_to_0_time	Fastest time in ms to deceleration from 100 to 0 km/h	U16	[0; 32000]	0		
799	Ve_0_to_100_time	Fastest time in ms to acceleration from 0 to 100 km/h					
832	SensorSupplyVoltage	Sensor supply voltage [mV]. Read only.		[0; 5100]			
833	Temperature	Temperature measured on the PVED-CL printed circuit board in degrees C. Read only.	S16	[-50; 451]			
931	OperationTime	The time PVED has been operating since the first boot. Unit: 6 min. Read-only.	U32	[0 ; 4294967295]			✓
932	Temperature histogram interval 1	Number of 6. minute ticks where the PVED-CL is operating in temperature interval : 1 : < -40 deg. C 2 : [-40; -31] deg. C 3 : [-30; -21] deg. C 4 : [-20; -11] deg. C 5 : [-10; -9] deg. C 6 : [0; 9] deg. C 7 : [10; 19] deg. C 8 : [20; 29] deg. C 9 : [30; 39] deg. C 10: [40; 49] deg. C 11: [50; 59] deg. C 12: [60; 69] deg. C 13: [70; 79] deg. C 14: [80; 89] deg. C 15: [90; 99] deg. C 16: [100; 109] deg. C 17: [110; 119] deg. C 18: [120; 129] deg. C 19: [130; 139] deg. C	U32	[0 ; 4294967295]			
933	Temperature histogram interval 2						
934	Temperature histogram interval 3						
935	Temperature histogram interval 4						
936	Temperature histogram interval 5						
937	Temperature histogram interval 6						
938	Temperature histogram interval 7						
939	Temperature histogram interval 8						
940	Temperature histogram interval 9						
941	Temperature histogram interval 10						
942	Temperature histogram interval 11						
943	Temperature histogram interval 12						
944	Temperature histogram interval 13						
945	Temperature histogram interval 14						
946	Temperature histogram interval 15						

Appendix

Index	Name	Description	Data Type	Range	Default	Locked	Not Resored	
947	Temperature histogram interval 16	20: > 140 deg. C The temperature measured on the PVED-CL printed circuit as long as the PVED-CL is powered. Read only						
948	Temperature histogram interval 17							
949	Temperature histogram interval 18							
950	Temperature histogram interval 19							
951	Temperature histogram interval 20							
6300 - 6301 9	- not used - 20 general purpose storage parameters	- user defined -	U32	[0; 4294967295]	0		✓	
6400 2	StatusReportsPGNBase	Offset for proprietary B messages that contains status data	U8	[0; 253]	0			
6400 3	PvedSourceAddress	PVED-CL Source Address			19			
6400 4	VehicleSpeedSensorSourceAddress	Source Address of the vehicle speed sensor			251			
6400 5	ControlDeviceSourceAddress	Source Address of the MMI controller.			252			
6400 6	ConfigurationDeviceSourceAddress	Source Address of the configuration/diagnostic tool.			253			
6400 7	HPExtSourceAddress	Source Address of the high priority external set-point generator			28			
6400 8	HPStdDisabledAtBootUp	High priority steering device state at power-up (device enable/disable)			BOO L			Enabled: 0 Disabled: 255
6400 9	LPStdDisabledAtBootUp	Low priority steering device state at power-up (device enable/disable)						
6401 0	HPExtDisabledAtBootUp	High priority external set-point controller state at power-up (enable/disable)						
6401 1	WAReducedModeAllowed	Reduced mode switch for the wheel angle sensor signal	Not allowed: 0 Allowed: 255	0				
6401 2	VSReducedModeAllowed	Reduced mode switch for the vehicle speed sensor signal						
6401 3	HPStdReducedModeAllowed	Reduced mode switch for the high priority steering device						
6401 4	LPStdIReducedModeAllowed	Reduced mode switch for the low priority steering device.						
6401 5	HPStwPowerUpTimeout	Power-up timeout value for the steering wheel signal Unit: 1 ms.	U16	[100; 10 000]	100			
6401 6	HPStdPowerUpTimeout	Power-up timeout value for the high priority steering device set-points (CAN) Unit: 1 ms.						
6401 7	LPStdPowerUpTimeout	Power-up timeout value for the low priority steering device set-points (CAN) Unit: 1 ms.						
6401 8	WAPowerUpTimeout	Power-up timeout value for the wheel angle sensor Unit: 1 ms.	U16	[60; 10 000]	60			
6401 9	VSPowerUpTimeout	Power-up timeout value for the vehicle speed signal Unit: 1 ms.		[160; 10 000]	160			

Appendix

Index	Name	Description	Data Type	Range	Default	Locked	Not Restored
64020	StwDxFILTERThreshold	Threshold for the steering wheel dx filter		0,1: Disable filter [2 ; 4095]	2		
64021	StwDxFILTERStartTime	Timeout-value for the steering wheel dx filter activation Unit: 1ms	U16	0: filter always enabled [1 ; 65515] > 65515: Disable filter	0		
64022	StwDxActivationThreshold	The SASA steering wheel position change threshold, dx , which shall be exceeded before auto-steering can be engaged. The relation between dx and steering wheel rpm is: dx= 1 is equivalent to 1.4 rpm.	U16	[0 ; 4095]	5		
64023	StwActivationTimeout	The amount of time where immediate engaging auto-steering is kept possible after dx getting lower than StwDxActivationThreshold. "Kept possible" in this context means: Without first requiring detection of SASA steering wheel position changes.	U32	[0 ; 2147483647]	2147483647		
65000	SD_ID	Danfoss ID according to J1939 / ISO11783	U8	[0 ; 253]	57	✓	✓
65001	PVEDSerialNo	PVED barcode number	U32	[0 ; 4294967295]	0	✓	✓
65002	SalesOrderNo	Danfoss Sales Order Number. Identifies hardware configuration, software version and parameter setup.				✓	✓
65003	SWVersionNo	Installed software version. Read only.				✓	✓
65004	ParamDefFile	Identifies the parameter set file applied at production time.	U16		0	✓	✓
65005	- not used -	- user defined -	U32				
65006	- not used -	- user defined -					
65051	BaudRate	The CAN bus physical baud rate			250		✓
65055	AD1_500_Left	Value of the analogue AD 1 between extreme left and neutral	U16	[30 ; 957]	300		✓
65062	AD1_500_Right	Value of the analogue AD 1 between extreme right and neutral			700		✓
65069	AD2_500_Left	Value of the analogue AD 2 between extreme left and neutral			300		✓
65076	AD2_500_Right	Value of the analogue AD 2 between extreme right and neutral			700		✓
65080	AD1_1000_Left	Extreme value of the analogue input AD 1 steering left		{125, 250, 500}	100		✓
65083	AD1_1000_Right	Extreme value of the analogue input AD 1 steering right		[30 ; 957]	900		✓
65086	AD1_Neutral	Neutral value of analogue input AD 1			500		✓
65087	AD_1_Linear	Defines whether AD1 scaling is based on 3 or 5 points	BOOL	5-point: 0 3-point: 255	255		✓

Appendix

Index	Name	Description	Data Type	Range	Default	Locked	Not Resorted
65089	AD2_1000_Left	Extreme value of the analogue input AD 2 steering left	U16	[30 ; 957]	100		✓
65092	AD2_1000_Right	Extreme value of the analogue input AD 2 steering right			300		✓
65095	AD2_Neutral	Neutral value of analogue input AD 2			500		✓
65096	AD_2_Linear	Defines whether AD2 scaling is based on 3 or 5 points	BOOL	5-point: 0 3-point: 255	255		✓
65098	AnalogChannelCompensation	Analogue input voltage compensation Enables radiometric measurement of voltages which are proportional to the PVED-CL 5V external reference voltage (such as simple resistive potentiometers). ⚠ Warning <u>Do not use for sensors which outputs are already compensated.</u>	U16	No compensation (0)	0		✓
				Compensation on AD1 (1)			✓
				Compensation on AD2 (2)			✓
				Compensation on AD1+AD2 (3)			✓
65099	MaxWheelAngleLeft	Maximum wheel angle to the left [mdeg]. Measured on the wheel where the wheel angle sensor is mounted	U32	[0 ; 50000]	35000		
65100	MaxWheelAngleRight	Maximum wheel angle to the right [mdeg]. Measured on the wheel where the wheel angle sensor is mounted					
65101	SteeringWheelSensorPresent	Steering wheel sensor configuration (SASA Sensor)	BOOL	Not present: 0 Present: 255	0		

Index	Name	Description	Data Type	Range	Default
65102	HighPrioritySteeringDeviceInterface	High priority steering device configuration (joystick, potentiometer, other)	U8	No device connected (0)	0
				Analogue device on AD1 (1)	
				Analogue device on AD2 (2)	
				CAN-based device (4)	
65103	LowPrioritySteeringDeviceInterface	Low priority steering device configuration (joystick, potentiometer, other)	U8	No device connected (0)	0
				Analogue device on AD1 (1)	
				Analogue device on AD2 (2)	
				CAN-based device (4)	
65104	PrimaryWheelAngleSensorInterface	Steered wheel angle sensor configuration (feedback from steered wheels)	U8	No device connected (0)	0
				Analogue device on AD1 (1)	
				Analogue device on AD2 (2)	
				CAN-based device (4)	
65105	ExternalSetPointControllerPresent	External set-point controller configuration (GPS)	BOOL	Not present: 0 Present: 255	0
65107	RedundantWheelAngleSensorPresent	Redundant steered wheel angle sensor configuration			
65108	VehicleSpeedSensorPresent	Vehicle Speed J1939 signal IO configuration			
65109	OSPPresent	Defines whether the hydraulic backup is present. Only on EHPS system.			

Appendix

Index	Name	Description	Data Type	Range	Default
65110	SpoolMonitorPresent	Valve main spool monitoring. Monitors if main spool set-point and actual spool position relationship.			
65112	VehicleLength	Distance [mm] between the front and rear axles. Articulated vehicles: distance [mm] between the front axle and the articulation point.	U16	[1 ; 65535]	4000
65113	VehicleType	Defines the vehicle type		[0 ; 65535]	0
65114	AntennaOffsetX	Offset or distance of Antenna related to reference point, in X direction [mm]			
65115	AntennaOffsetY	Offset or distance of Antenna related to reference point, in Y direction [mm]			
65116	AntennaOffsetZ	Offset or distance of Antenna related to reference point, in Z direction [mm]			
65117	DMUOffsetX	Offset or distance of DMU related to reference point, in X direction [mm]			
65118	DMUOffsetY	Offset or distance of DMU related to reference point, in Y direction [mm]			
65119	DMUOffsetZ	Offset or distance of DMU related to reference point, in Z direction [mm]			
65120	OSPSize	Size of hydraulic steering unit in cm ³		[20 ; 1200]	20
65121	ValveType	Defines type of the valve PVED-CL is mounted on		EHPS: 1, EH: 2	1
65122	SteeringType	Used for Auto-steering algorithm selection		Front wheel steering (1) Rear wheel steering (2) Articulated steering (3)	
65123	VehicleLength2	Articulated vehicles: distance [mm] between the rear axle and the articulation point		[1 ; 65535]	4000
65124	STWSensorTransmissionRate	Steering wheel sensor transmission rate	5 ms (0) 10 ms (1) 15 ms (2)	1	

Program Parameters

Name	Data type	Description of parameter	Steering wheel	Steering device		External set-point controller	Range	Default
				High Priority	Low Priority			
Pid	S16	Program identification number	1y00	3y00	4y00	5y00	[0; 34]	{0, 20, 25, 30}
Did	U8	Device identification number	1y01	3y01	4y01	5y01	[0; 4]	{0, 2, 3, 4}
Cp	BOOL	Control principle	1y02	3y02	4y02	5y02	Open loop: 0 Closed loop: 255	{0, 0, 0, 255}
Xysat	S16	Saturation of Y at input X	1y03	3y03	4y03	5y03	[0; 1000]	1000
Ri		Steering wheel backlash	1y04	3y04	4y04	5y04	[0; 200]	0
db		Dead band	1y05	3y05	4y05	5y05	[0; 250]	{5, 0, 0, 0,}
Lx		Linearity index	1y06	3y06	4y06	5y06	[-10; 10]	0
YR		Right position limit	1y07	3y07	4y07	5y07	[0; 1000]	1000

Appendix

Name	Data type	Description of parameter	Steering wheel	Steering device		External set-point controller	Range	Default
				High Priority	Low Priority			
YL		Left position limit	1y08	3y08	4y08	5y08	[-1000 ; 0]	-1000
Sts0		Steering sensitivity at 0 % of Vesm	1y10	3y10	4y10	5y10	[20; 1200] External set-point generator [0; 1000]	{400, 105, 105, 1000}
Sts1		Steering sensitivity at 6 % of Vesm	1y11	3y11	4y11	5y11		{400, 90, 90, 1000}
Sts2		Steering sensitivity at 12 % of Vesm	1y12	3y12	4y12	5y12		{400, 75, 75, 1000}
Sts3		Steering sensitivity at 25 % of Vesm	1y13	3y13	4y13	5y13		{400, 60, 60, 1000}
Sts4		Steering sensitivity at 50 % of Vesm	1y14	3y14	4y14	5y14		{400, 45, 45, 1000}
Sts5		Steering sensitivity at 100 % of Vesm	1y15	3y15	4y15	5y15		{400, 30, 30, 1000}
Lr		Ramp-up linearity index	1y19	3y19	4y19	5y19	[0; 10]	0
Lf		Ramp-down linearity Index	1y20	3y20	4y20	5y20		
Tro		Ramp-up time at vehicle speed = 0	1y21	3y21	4y21	5y21	[1; 1000]	1
Trh		Ramp-up time at vehicle speed = Verm	1y22	3y22	4y22	5y22		
Tfo		Ramp-down time at vehicle speed = 0	1y23	3y23	4y23	5y23		350
Tfh		Ramp-down time at vehicle speed = Verm	1y24	3y24	4y24	5y24		
Qm		Maximum port flow	1y27	3y27	4y27	5y27		1000
Off		Maximum port flow at end-stop (Soft end-stop)	1y28	3y28	4y28	5y28		50
Cf		Active soft end-stop port flow range	1y29	3y29	4y29	5y29	[1; 1000]	333
kc		Minimum & maximum steering sensitivity bound in % of Sts(k) (Steering wheel drift control)	1y30	3y30	4y30	5y30	[0; 20]	20
kd		Proportional gain for steering wheel drift control	1y31	3y31	4y31	5y31	[0; 200]	0
YsetFr	S16	Fast ramp-down range (rate limitation)	1y32	3y32	4y32	5y32	[0; 1000]	1000
Tfr		Fast ramp-down time (rate limitation)	1y33	3y33	4y33	5y33	[1; 1000]	100
YAbort Down Ramp		Input flow command threshold for canceling down-ramp (rate limitation)	1y34	3y34	4y34	5y34	[0; 500]	0
Tra		Ramp-down time for canceled down-ramp	1y35	3y35	4y35	5y35	[1; 1000]	1
Ampl	U16	Set-point amplification [Factor 0.001]	1y36	3y36	4y36	5y36	[0; 2000]	1000
InvertInputSignal	BOOL	Steering device signal inversion control	1y37	3y37	4y37	5y37	Normal: 0 Inverted: 255	0
Sse	S16	Steering sensitivity selector	1y09	3y09	4y09	5y09	Fixed 1 Actuator position dependent 2 Vehicle speed dependent 3	1
Sr		Rate limitation selector (anti-jerk)	1y17	3y17	4y17	5y17	No ramps applied 0 Fixed ramp times 1 Vehicle speed dependent 2	0
Vesm		Vehicle speed range where steering sensitivity is dependent on vehicle speed.	1y16	3y16	4y16	5y16	[1; 1000]	{50, 50, 50, 50}

Appendix

Name	Data type	Description of parameter	Steering wheel	Steering device		External set-point controller	Range	Default
				High Priority	Low Priority			
		Vehicle speeds higher than Vesm will saturate steering sensitivity at Sts5.						
Verm		Vehicle speed range where ramp up/down time is dependent on vehicle speed. Vesm [vehicle speed • 10] Vehicle speeds higher than Verm will saturate ramp times at Trh and Tfh respectively.	1y25	3y25	4y25	5y25	[0; 1000]	500

Steering Device Parameters

Name	Data type	Description of parameter	Steering wheel	Steering device		External set-point controller	Range	Default
				High Priority	Low Priority			
Kp	SIGNED16	Proportional gain for closed loop	108	308	408	508	[0; 200]	50
Full_Strk	SIGNED16	Fastest steering device input - minimum to maximum or vice versa (ms). For steering wheel device it is the time for one revolution.	111	311	411	511	[1; 2000]	{500, 200, 200, 200}
Magnetic Valves Off Delay Time	SIGNED16	Delay from main spool position in neutral position to valve controller is disabled (ms). A delay equal to default keeps the valve controller constantly enabled.	115	315	415	515	[1; 30000]	30 000
TolsOut	SIGNED16	Time out value for main spool position variable at dead band in open loop control (ms)	116	316	416	516	[1; 30000]	10 000
TclpOut	SIGNED16	Time out value for main spool position variable between Valve opening threshold and dead band in closed loop control [ms]	117	317	417	517	[1; 30000]	3000
Qth	SIGNED16	Valve Opening Threshold for main spool position control in closed loop.	118	318	418	518	[0; 100]	{50, 50, 50, 0}
Steering Motion Threshold	SIGNED16	Active State speed threshold. Detection of steering request with a steering device (% • 10 of maximum activation speed)	119	319	419	519	[0; 2000]	{50, 100, 100, 100}
P_Ve_Transit_Threshold	SIGNED16	Vehicle speed Threshold value to allow new programs to be used for steering. (km/h • 10)	127	327	427	527	[0; 1000]	50



Products we offer:

- Bent Axis Motors
- Closed Circuit Axial Piston Pumps and Motors
- Displays
- Electrohydraulic Power Steering
- Electrohydraulics
- Hydraulic Power Steering
- Integrated Systems
- Joysticks and Control Handles
- Microcontrollers and Software
- Open Circuit Axial Piston Pumps
- Orbital Motors
- PLUS+1® GUIDE
- Proportional Valves
- Sensors
- Steering
- Transit Mixer Drives

Danfoss Power Solutions is a global manufacturer and supplier of high-quality hydraulic and electronic components. We specialize in providing state-of-the-art technology and solutions that excel in the harsh operating conditions of the mobile off-highway market. Building on our extensive applications expertise, we work closely with our customers to ensure exceptional performance for a broad range of off-highway vehicles.

We help OEMs around the world speed up system development, reduce costs and bring vehicles to market faster.

Danfoss – Your Strongest Partner in Mobile Hydraulics.

Go to www.powersolutions.danfoss.com for further product information.

Wherever off-highway vehicles are at work, so is Danfoss.

We offer expert worldwide support for our customers, ensuring the best possible solutions for outstanding performance. And with an extensive network of Global Service Partners, we also provide comprehensive global service for all of our components.

Please contact the Danfoss Power Solution representative nearest you.

Comatrol

www.comatrol.com

Schwarz Müller-Inverter

www.schwarzmueller-inverter.com

Turolla

www.turollaocg.com

Valmova

www.valmova.com

Hydro-Gear

www.hydro-gear.com

Daikin-Sauer-Danfoss

www.daikin-sauer-danfoss.com

Local address:

Danfoss Power Solutions US Company
2800 East 13th Street
Ames, IA 50010, USA
Phone: +1 515 239 6000

Danfoss Power Solutions GmbH & Co. OHG
Krokamp 35
D-24539 Neumünster, Germany
Phone: +49 4321 871 0

Danfoss Power Solutions ApS
Nordborgvej 81
DK-6430 Nordborg, Denmark
Phone: +45 7488 2222

Danfoss Power Solutions (Shanghai) Co. Ltd.
Building #22, No. 1000 Jin Hai Rd
Jin Qiao, Pudong New District
Shanghai, China 201206
Phone: +86 21 3418 5200

Danfoss can accept no responsibility for possible errors in catalogues, brochures and other printed material. Danfoss reserves the right to alter its products without notice. This also applies to products already on order provided that such alterations can be made without subsequential changes being necessary in specifications already agreed. All trademarks in this material are property of the respective companies. Danfoss and the Danfoss logotype are trademarks of Danfoss A/S. All rights reserved.