



- Contact Phone Numbers
- Tire Care
- Weight Distribution
- Air Brake System
- Chassis Lubrication
- Pre-Trip and Scheduled Maintenance
- Allison Transmission Operation
- Misc.

Freightliner Custom Chassis Customer Support

1-800-FTL-HELP (800-385-4357)

24 HOURS A DAY

7 DAYS A WEEK

365 DAYS A YEAR

If you should require chassis service, ***you should first contact your nearest Freightliner Chassis service center.*** If for some reason this is not possible or if you would like to call the manufacturers direct, you can contact them at the following telephone numbers:

FREIGHTLINER CUSTOM CHASSIS CORPORATION

1-800-FTL-HELP (800-385-4357)

(Please have your VIN# ready)

CATERPILLAR RV ENGINE SUPPORT

1-877-777-3126

CUMMINS ENGINE COMPANY

1-800-DIESELS (800-343-7357)

ALLISON TRANSMISSIONS

1-800-524-2303

MICHELIN

800-TIRE-HELP

(800-847-3435)

Visit our web site at www.freightlinerchassis.com

Tire Care

- What is the most important component of tire care?
 TIRE PRESSURE



- Why?
 - Improved Ride
 - Improved Tire Wear
 - Improved Road Handling
 - Improved Braking

Tire Care

The most important factor in maximizing the life of your tires is maintaining proper inflation pressure. An under inflated tire will build up excessive heat that may go beyond the prescribed limits of endurance of the rubber and the radial cords. Over inflation will reduce the tire's foot print on the road, reducing the traction, braking capacity, and handling of your vehicle. An over inflated tire will also cause a harsh ride, uneven tire wear, and will be more susceptible to impact damage.

Keep in mind that the pressure rating on the side wall of your tire is the maximum pressure for that tire. This is not necessarily the correct pressure for the tires when installed on your vehicle. Maintaining the correct tire pressure for your vehicle's loaded weight is extremely important and must be a part of regular vehicle maintenance.

Michelin Tires

- How to determine the correct pressure
 - Weigh each wheel position
 - Set tire pressure according to chart



255/80R22.5 LRG (2) - XRV

PSI		75	80	85	90	95	100	105
lbs per position	S	3750	4000	4235	4465	4710	4960	5205
	D	6935	7390	7820	8270	8710	9150	9620
kg. per position	S	1702	1815	1921	2025	2137	2250	2360
	D	3147	3352	3547	3752	3951	4151	4360

**** Cold Inflation Pressures**

To determine the correct air pressure for your tires, load your motor home as you would normally travel, including water and fuel. Go to a truck scale as found at most truck stops and weigh **each wheel position** independently, with driver and passenger or passengers in the vehicle as described in the **Michelin Recreational Vehicle Tire Guide** (MDL40660 Rev. 1/03) to determine the correct air pressure for the weight on each wheel position. Then use the charts in the guide and adjust the pressure accordingly when the tires are cool or have not been driven for more than one mile.

Never reduce the air pressure in a hot tire.

Remember : For control of your RV, its critical that the tire pressure be the same on both sides of the axle!

**** For a copy of the Michelin RV Tire Guide, call 1-800-847-3435.**

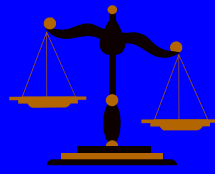

Weight Distribution

- Too much weight in one position can adversely affect ride and handling.
- Too light on front axle causes steering wander
- Front to rear weight distribution should be as close to equal percentages as possible
 - Example:
 - Front GAWR 10,410 lbs / 80% = 8,328 lbs.
 - Rear GAWR 17,500 lbs / 80% = 14,000 lbs.

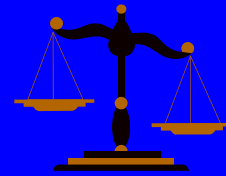

Weight Distribution

The distribution of weight in your motorhome is a very important factor. Too much weight either on one side of the vehicle or too much weight in the rear compared to the front axle can adversely affect the handling characteristics of the vehicle and in some cases can result in overloading the tires or axle components. Care should be taken to assure that you maintain as much of an equal balance as possible when loading your equipment, food and other supplies into the vehicle.

The front to rear weight balance should be as close to equal percentages of each axle weight rating as possible (Example: Front GAWR = 10,410 lbs. / 80% = 8,328. Rear GAWR = 17,500 lbs. / 80% = 14,000 lbs.) This type of balance provides the best handling characteristics of the vehicle. Small percentage differences will not make a great deal of difference. A unit that is too light on the front axle and heavy on the rear axle can result in wandering and porpoising, or a continued bouncing of the front of the coach after hitting a bump in the road.

By knowing what your vehicle weighs, you can determine the best location for your belongings. Simply because you can fit everything in one compartment for easy access, does not mean that this is OK. Your house is now moving down the road, so the little things like location of heavy items becomes important from more than an accessibility standpoint.

Brake System



- Rear brakes act as parking brake.
 - Spring applied
 - Holding power of two large drum brakes
 - Park brake will not release in event of air pressure loss
- In the event of an air pressure loss
 - Warning lamp and buzzer will warn you

- Equipped with automatic slack adjusters



The rear brakes on the Freightliner chassis are also used as the parking brakes. This gives you the holding power of two large drum brakes to keep your coach from rolling even when fully loaded on a 20% grade.

A loss in air pressure will not result in an immediate loss of brakes. If a leak develops in the air system while driving, (at approximately 60 to 65 PSI) you will be alerted by a light on the instrument panel and an audible alarm. As you apply the brakes, the air supply holding the brakes in the released position will gradually be depleted. When fully depleted, (approximately 40 PSI) the rear brakes will set. This gives you plenty of time to pull over to the side of the road. **NOTE: (The rear brakes on Freightliner chassis are spring applied and air released.)**

Equipped with automatic slack adjusters that eliminate the need to manually adjust your brakes. Each time you step on the brake pedal, if adjustment is needed, the adjusters take up the slack. That is all there is to it.

Brakes - cont.



- Air dryer
 - Removes moisture and oil from compressed air
 - Spin-on desiccant cartridge to remove moisture
 - Internal coalescing filter to remove oil

Freightliner chassis air brake systems are equipped with an air dryer to remove the condensed moisture from compressed air. The air dryer is equipped with a spin-on desiccant cartridge that is scheduled to be changed every **18 months**. Inside this is a coalescing filter that should be changed every **18 months**. The dryer is located either on the right hand frame rail (behind the rear axle) or between the frame rails (behind the rear axle) on later models.

(WARNING: Air Tanks should be bled of all pressure any time you work on the air system)

Brakes - cont.

- Heated automatic moisture ejector system
 - Inside air dryer
 - On the wet tank

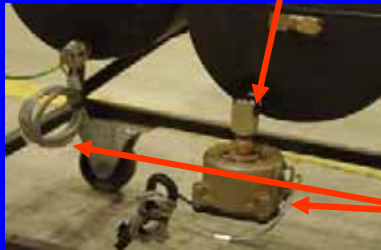

- Drain lanyards should be pulled every 6 Months for 10 to 15 seconds.
- Manual drain lanyards

NOTE: There are three drain lanyards only two are shown.

Freightliner chassis are equipped, *as standard equipment*, with a heated automatic moisture ejector on the wet tank in addition to one built into the air dryer. This eliminates the need to climb under the coach to drain air and water from the tanks daily. You still must pull all three drain lanyards for 10 to 15 seconds every **6 Months** to drain moisture. A fine mist is normal due condensation. If a large amount of moisture is present it should be completely drained, and the air dryer serviced. Moisture in the braking system can cause brake system failure and is not covered by the manufacturers warranty.

Exhaust & Compression Brake & Variable Geometry Turbo

- Improves braking power
- Reduces chances of overheating brakes on steep grades
- Works in conjunction with Allison electronic transmissions
- Illuminates brake lamps with 5 & 6 Speed Allison
- Compression brake allows for 3 or 6 cylinder use.



Cummins ISB VGT



Exhaust Brake





Compression Brake

All brakes build up heat when being used due to friction, this is normal. However, excessive use of the brakes when descending a grade can result in excessive heat and can cause “brake fade” or a loss of braking power, even with disc brakes. The correct way to use your brakes is to go slowly enough that a fairly light occasional use of the brakes will keep your speed from increasing. ***Do not maintain continual brake pedal pressure when descending a hill with any type of brake system.*** Instead, down shift the transmission to slow the vehicle and make light, intermittent brake applications to control down hill speeds. By utilizing the transmission gears and/or the VGT, Exhaust Brake, or Compression Brake (if so equipped), continual use of the brakes will not be necessary. When using the transmission’s lower gears to slow the vehicle on hills, be careful not to exceed the governed speed of your engine. If engine-governed speed is exceeded, the transmission will shift up to the next range, rapidly increasing the speed of your vehicle. If you find that you are continually using the brakes to maintain a safe speed and to keep the RPMs within this range, slow the vehicle down even further and shift the transmission to a lower gear.

Caution: Do Not Use the VGT, Exhaust Brake, or Compression Brake on wet roads or slippery conditions.

Scheduled Maintenance

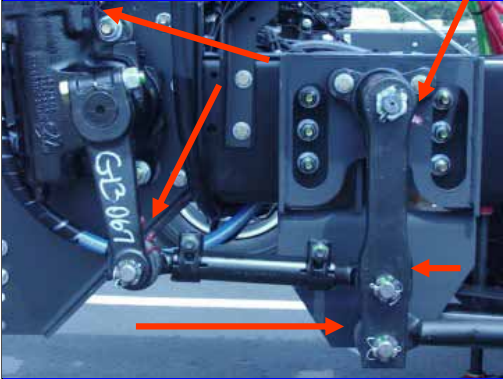
- Grease fittings
- Front oil filled bearing

Oil and filter change .	Engine fuel filter change
Caterpillar 3126 & 3126B 19 Qt Pan Serial # Prefix 1WM & 7AS 9,000 miles or 1 year which ever occurs first.	9,000 miles or 1 year which ever occurs first.
Caterpillar 3126B & 3126E & C7 22 Qt Pan Serial # Prefix 7AS, 8YL, 9SZ & CKM 11,000 miles or 1 year which ever occurs first.	11,000 miles or 1 year which ever occurs first.
Cummins B5.9L & C8.3L 6,000 miles or 6 months which ever occurs first.	12,000 miles or 6 months which ever occurs first.
Cummins ISB & ISC 15,000 miles or 1 year which ever occurs first.	15,000 miles or 1 year which ever occurs first.
Cummins ISL 18,000 miles or 1 Year which ever occurs first.	18,000 miles or 1 year which ever occurs first.
Cummins ISM 7,000 miles or 6 months which ever occurs first.	7,000 miles or 6 months which ever occurs first.
Recommended Fluid Types	
Engine Oil	Transmission Fluid
Caterpillar & Cummins Engines	MT643, MD3060, 1000/2000 Series, 3000/4000MH
Outside air temperature between + 5 F & + 122 F	Dexron III or TransSynd
SAE 15W-40 CH-4, CG-4 or CF-4	2000MH TransSynd
Rear Axle Differential & Front Wheel, Oil Lubricated Wheel Bearings	Hydraulic System Reservoir
SAE 80-90W Gear Lubricant	Dexron III
Front Axle Spindle Pins, Tie Rods, Drag Link, Intermediate Steering Shaft & Gear	Front & Rear Wheel Bearings, Brake Camshafts, Auto Slack Adjusters & Universal Joints.
Multi-Purpose Grease NLGI Grade 1 or 2	Multi-Purpose Grease NLGI Grade 1 or 2
Brake Caliper Slides (Hydraulic Brakes)	Pac Brake Exhaust Brake
Aeroshell Grade 5 (ES-1246) Grease	Pac Brake Synthetic Lube or Synco Super Lube

Scheduled Maintenance

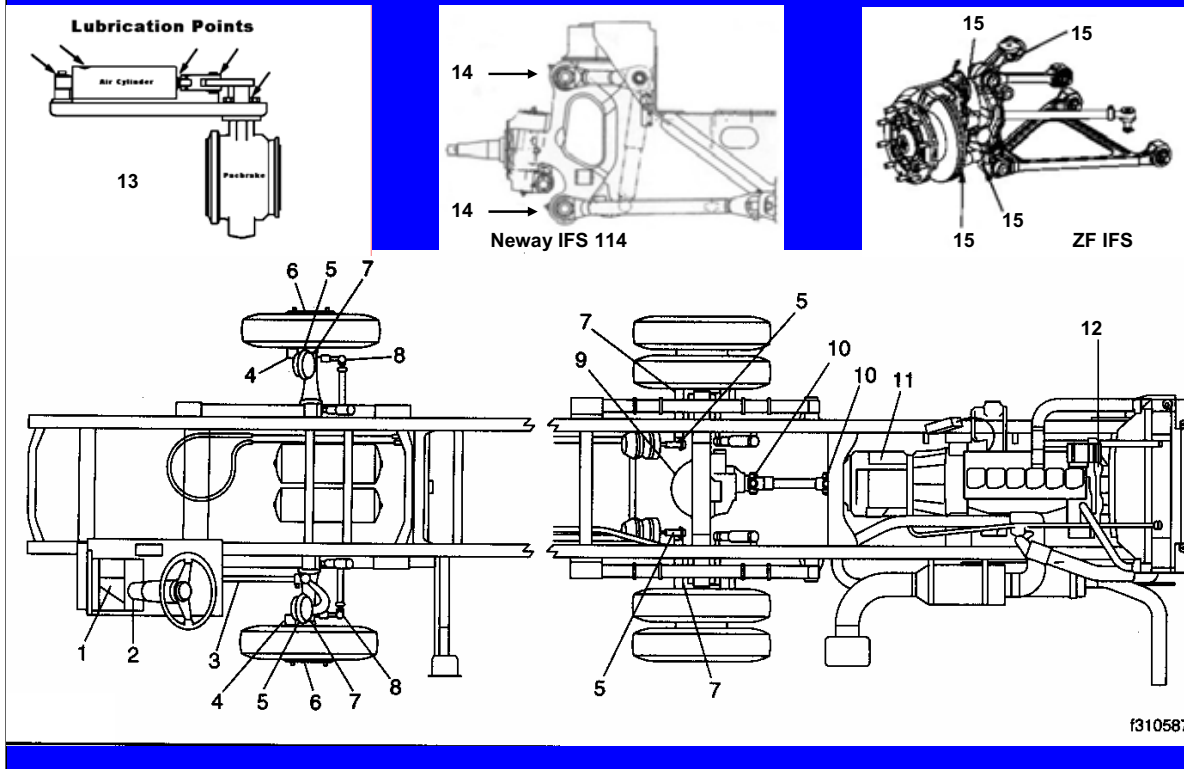

One very important area of regular, scheduled maintenance, is the lubrication of various points on the chassis steering, braking and suspension systems. The above chart points out these locations. The lubrication intervals and lubricant specifications are listed in your owners manual and on the attached pages for your particular chassis. Lubrication does not have to be performed by a authorized service dealer, but the dates and mileage of lubrication and general service should be recorded for future reference.

No.	Text Ref. No.	Components	Remarks	Total
1	46-05	Steering Gear	One Grease Fitting	1
2	46-04	Steering Shaft	Three grease fittings; lubricate both universal joints and the slip joint spline	3
3	46-01	Drag Link & Bell Crank	Two grease fittings per drag link; one on each end, and one on bell crank housing	5
4	33-01	Knuckle Pins	Two grease fittings; one on top and one on bottom of knuckle pin. Lubricate both sides of axle.	4
5	42-05	Automatic Slack Adjusters	One Grease Fitting; Lubricate boths sides of front and rear axle	4
6	33-04	Grease Lubricated Wheel Bearings, Front Axle	Inspect, repack and adjust inner and outer bearings on both sides of front axle	
7	42-04	Brake Camshaft Bracket	One grease fitting; Pump in grease until it appears at the slack adjuster end of the bracket. Lubricate both sides of the front and rear axles.	4
8	33-02	Tie Rod	One grease fitting; one on each end of tie rod	2
9	35-01	Rear Axle	Check fluid level; add fluid if low (35-02)	
	35-02		Change fluid when required (35-01)	
10	41-01	Driveshaft	Three grease fittings; lubricate both universal joints & slip joint spline	3
11	26-02	Automatic Transmission	Change fluid when required (35-01)	
12		Caterpillar Fan Drive Pulley	One grease fitting; on top of fan drive pulley	1
13		Pacbrake Exhaust brake	Lubricate the five points indicated	
14	32-04	Neway Ind. Front Susp.	Two grease fittings; One on top & bottom of knuckle post, lubricate both side of suspension	4
15		ZF Ind. Front Susp.	Four grease fittings;one on top and bottom steering knuckle, and one on top and bottom control arm. Lubricate both sides of suspension.	8

Scheduled Maintenance

MAINTENANCE SCHEDULE SERVICE INTERVALS	MILEAGE INTERVALS						
	1,000	6,000	10,000	15,000	20,000	25,000	50,000
•Check and add lubricant if necessary to front oil filled wheel bearings. (Oil Seals) drain and refill at least once a year.	X						
•Check and add lubricant if necessary to front wheel bearings. every (Grease filled bearings)				X			
•Check air intake system for damage, cracked hoses, & loose clamps.		X					
•Check wheel lug nut torque the first 50 & 500 mi. then every 5,000 mi.		X					
•Inspect fan & fan shroud every 12 months or:					X		
•Check belt tensioner bearing.					X		
•Check air restriction indicator when refueling, replace air cleaner element when the indicator reaches 25" or 2 Yrs which ever occurs first.							
•Change automatic transmission fluid & filters AT542 MT643 every 12 months or:						X	
•Change automatic transmission fluid & filters 1000/2000/2000MH Refer to Allison Owners Manual (1)							
•Change automatic transmission filters MD3060 3000/4000MH the first 5,000 See Allison Op. Man. for Change Recommendation (1)							
•Lubricate Brake Caliper slides the first 5,000 miles then every 12 months or: (Hydraulic Disc Brakes Only)				X			
•Lubricate steering linkage & drive shaft U-joints, air brake camshafts slip yoke & brake linkage.		X					
•Lubricate front axle king pins the first 5,000 mi. then every 12 mos.							
•Lubricate PacBrake exhaust brake as needed, or every 6 months.							
•Rotate tires if required			X				
•Replace fuel water separator every 12 months or every oil change							
•Check/Clean electrical ground connections every 12 months		X					
•Inspect drive belts for condition & tension every 6 mos. Or 6,000 mi.							
•Check rear axle lubricant every 6,000 miles.							
•Change rear axle lubricant (Meritor) every 12 mos.							
•Check coolant SCA's & freeze point, hoses, clamps every 6 mos							
•Replace coolant every 24 months or 60,000 mi 2001 MY and prior							
•Replace coolant every 60 months or 100,000 mi 2002 MY chassis (2)							
•Replace air dryer coalescing & desiccant filter every 18 months (3)							
•Replace desiccant cartridge every 36 mos (4)							
•Check hydraulic fluid reservoir level every 6 mos. or 6,000 mi.							
•Change hydraulic fluid & filter every 2 yrs. or 24,000 mi.							
•Check and clean charge air cooler as required.							
(1) Transynd Fluid always used in 2000MH. Transynd used in 3000MH chassis build date 1/5/04							
(2) SCA level and freeze point must be checked and recharged to proper levels every 6 months or 25,000 miles whichever occurs first to achieve this interval.							
(3) This interval applies to Midland/Haldex Pure Air Plus Dryer							
(4) This Interval applies to CR, and Haldex PURest Dryer's. PURest dryers start with chassis build date 11/28/03							
Note: This is a list of the most common maintenance items. Additional maintenance may be required. Check the appropriate operation and maintenance manuals for more information.							

Authorized Service Parts

- Customers may perform their own service
 - Maintain accurate records
 - Does not void warranties
- Genuine parts ensure quality

Parts should be ordered using your chassis VIN to ensure correct parts.

**Note:
Part numbers are accurate at time of printing and subject to change without notice!**



Part Description	Manufacturer	Part Number
Engine Oil Filter		
Cummins B5.9L	Fleetguard	LF 3349
Cummins C8.3L, ISC, ISL, & ISM	Fleetguard	LF 3000
Cummins ISB	Fleetguard	LF 3970
Cummins ISB 02	Fleetguard	LF3729
Caterpillar 3126, 3126B & 3126E	Caterpillar	1R-0739
Air Cleaner Element		
Cummins B5.9L; ISB; Caterpillar 3126, 3126B & 3126E	Farr	End Inlet 114500-003
	Farr	Side Inlet 114880-003
C8.3L	Farr	Side Inlet 099842-009
Cummins ISC & ISL	Farr	Side Inlet 062891 001
Cummins ISM	Farr	Side Inlet 062891-002
Fuel Filter (Engine Mounted)		
Cummins B5.9L & C8.3L	Fleetguard	FF 5052
Cummins ISB	Fleetguard	Spin-On FS 19519
Cummins ISB	Fleetguard	Top Load FS 1268
Cummins ISC & ISL & Remote Mtd	Fleetguard	Spin On FS 1022
Cummins ISM	Fleetguard	Spin On FS 1003
Caterpillar (Secondary - Engine Mtd)	Caterpillar	Spin On 1R-0759
Caterpillar (Fuel Filter/Water Sep)	Caterpillar	198-6378
Caterpillar (Fuel Filter/Water Sep)	Alliance	ABP-32FRT03
Cummins ISB 02 FWS Remote Mtd	Fleetguard	Spin On FS19596
Fuel Filter/Water Separator - Remote Mtd	Fleetguard	FS 1242
Fuel Filter/Water Separator - Remote Mtd	Alliance	ABP - 32FRT01
Cooling System		
SCA Coolant Filter 8 to 20 Gallons	Penray	PIC NF 2088
SCA Liquid 1 Pint Bottle	Penray	PIC 3000 16
SCA Test Strips (Bottle of 10)	Penray	PIC TS 102
SCA Pre Charged 50/50 Pre -Diluted Antifreeze 1 Gallon	Old World Ind.	OWI ALAWS3
Transmission Filter		
Allison 1000, 2000 & 2000MH	Allison	Spin On 29537268
Allison MD3060, 3000MH, HD4060, 4000MH	Allison	Internal 29540493
Allison 3000MH & 4000MH Deep Sump	Allison	Internal 29540494
Allison MT643 (Remote Mounted)	Fleetguard	Spin On LF3342
Air Dryer Filter		
Midland or Haldex Pure Air Plus	Haldex	Kit# DQ6026
Haldex PURest Filter Kit	Haldex	Kit# DQ6050
Haldex PURest Purge Valve Kit	Haldex	Kit# DA33115
VC & VCL Chassis	Chicago Rawhide	T224

Pre-Trip Inspection

- Check tires



- Look for fluid leaks

Please take some time, if you have not already done so, to read through the operator's manual provided with your chassis. Familiarization with this book and your chassis is the best possible way to ensure that you can safely operate your vehicle and extend its useful life.

Prior to starting your vehicle each day, there are a few things that should be checked. Taking the time to follow these recommendations could mean the difference between having a wonderful vacation and spending your time on the side of the road or in the lobby of a repair shop.

- **Check the tires for proper inflation pressure and for damage. Don't forget to check the inner duals. Refer to the air pressure charts in the beginning of this handout for proper inflation pressures.**

- **Look for fluid leaks under the Motorhome. (The simple act of tightening a hose clamp could prevent a serious problem.)**

Pre-Trip Inspection

- Check coolant level



910 sq in rear radiator



Side radiator



1050 sq in rear radiator

- Factory fill →



Check the coolant level in the reservoir and add a 50/50 mix of coolant and water if needed. This reservoir is located at the rear of your vehicle. *Be careful not to confuse it with the hydraulic fluid reservoir though, they look very much alike.*

- Check SCA (supplemental coolant additive) and freeze point every 6 months or 25,000 miles. Recharge as required.





IF THE WATER TEMP IN YOUR ENGINE IS GREATER THAN 120 DEGREES, DO NOT REMOVE THE RADIATOR CAP !

YOU COULD BE SEVERLY BURNED !!!

- Approximate COOLING SYSTEM CAPACITIES Does not include heater core or other auxiliary system's added by Coach Manufacturer.
- Cummins ISB - Rear Radiator 36 Qt. or 9 Gallons.
- Cummins ISC - Rear Radiator 42 Qt. or 10 ½ Gallons.
- Cummins ISC & ISL - Side Radiator 42 Qt. or 10 ½ Gallons.
- Cummins ISM – Side Radiator 50 Qt. or 12 ½ Gallons.
- Caterpillar 3126, 3126B & 3126E Rear Radiator 38 Qt. or 9 ½ Gallons.
- Caterpillar 3126, 3126B & 3126E Side Radiator 38 Qt. or 9 ½ Gallons.

Note: If you have trouble getting Alliance Brand Coolant ALAWS3 Detroit Diesel Brand Powercool 50/50 pre mixed is the same coolant .Part # PCA053. Fleetcharge coolant is also the same and sold through some PEP BOY'S, NAPA, and Tractor Supply under Fleetcharge FCA053.

Pre-Trip Inspection

- Check transmission fluid level 
- Check engine oil level 
- Check for animals in engine compartment 
- Check hydraulic fluid 

- Check transmission fluid level add fluid if needed
- Check your engine oil level and add oil if needed
- Check the engine compartment for squirrels, cats, etc. They like the warmth of the engine compartment, but make a real mess if caught in the belts.
- Check the hydraulic fluid in the hydraulic reservoir and add fluid if needed.

Pre-Trip Inspection

Check fuel/water separator

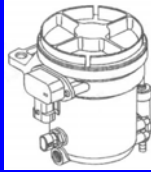

ISB



ISB 02



3126 E



ISC / ISL

- Check fuel/water separator and drain any water or contamination that may be present.

After you have completed your inspection, you may now start your engine. If you have an electronic engine such as the Caterpillar 3126 or the Cummins ISB, turn the key to the run position and wait for the wait to start light (in some cases it may read "Inlet heater") to turn off. You may now start the engine. **Never use ether or any other starting aid to start the electronic engine. The inlet heater can ignite the fumes and cause an explosion in the air inlet system.** Once you have started the engine, monitor your gauges closely. Make sure that the oil pressure rises within 15 seconds. If it does not, shut down the engine and call a repair facility to determine the cause.

Pre-Trip Inspection

- Check air filter restriction indicator

Brand New Air Cleaner

10" to 12" of Vacuum



- Engine Air Cleaner Element should be changed when the air inlet restriction indicator reaches 25 inches of vacuum or every two years whichever occurs first.

Allison Transmission Operation

- Normal driving- Best fuel economy
 - Select “D” and “Mode On”
- Performance
 - “Mode Off”
 - For mountain driving select lower gears to maintain 2000+ engine RPM.
- Hill climbing on hot days
 - Keep RPMs high to cool engine
- Transynd used in 3000MH with chassis built date of 1/5/04



DRIVING TIPS WITH THE ALLISON MD3060 3000MH TRANSMISSION

When driving under normal road conditions, the DRIVE mode is recommended for optimum performance and fuel economy. The MODE switch should be set to ON for economy mode but MODE off should be used when climbing hills and when extra performance is needed.

The display screen on the shift control pad will indicate the highest selected gear for the transmission. When mountainous or up and down terrain conditions occur, you should manually select a lower gear, preferably lower than 5th gear and turn OFF the mode switch. This can be done at any road speed by pressing the down arrow repeatedly until the desired gear is indicated in the window of the shifter pad and then pressing the MODE button. When your road speed decreases to a safe point, the transmission will downshift at a higher RPM than normal. This will limit the use of overdrive while pulling hills, which can produce excessive heat build-up in the transmission, and it keeps the engine operating at peak horse power and performance.

With the MT 643 and T-handle shifter, simply shift to a lower gear selection to keep the RPM's in the upper range. The transmission **will not** shift into a lower gear until it is safe for it to do so.

When ascending a grade, maintain engine speed to within 400 - 500 RPM of governed engine speed. Governed speed will be 2400-2500 RPM depending on your engine model. Road speed may decrease, but the engine will be at it's peak in the power curve.

It is especially important to monitor your water temperature gauge when climbing hills. Keep in mind, it is not unusual for the temperature to rise, especially in hot weather. If the gauge reaches the red zone or if the temperature warning light on the gauge panel should come on, reduce your road speed and shift to the next lower gear and keep your tachometer within 500 RPM of engine governed speed. In many cases this will stabilize the water temperature. If the temperature gauge continues to rise, pull over to the side of the road and shift the transmission into neutral. Bring the engine RPM to 1,700-2,000 RPM until the temperature drops down into the normal range. This should occur in a relatively short period of time. If the temperature gauge does not begin to drop and stays in the red zone or continues to rise, shut down the engine and allow it to cool. After the engine is allowed to cool, check the fluid level in the reservoir and add a 50/50 coolant and water mixture if needed.

A good "rule of thumb" for descending grades is to never use a higher gear than was used to climb the same or similar grade. Try to keep the engine within 500 RPM of governed speed. This will give the best engine braking and reduce the need to use the service brakes. Select a gear that will keep you at a safe speed with minimal brake application. Never ride your brakes when descending a grade since excessive brake heat will build up and your brakes could fade leaving you with little or no stopping power.

If your vehicle is equipped with an exhaust brake, This will also aid in slowing your vehicle on a down hill grade. With the exhaust brake switch in the ON position, when your foot is released from the accelerator, the transmission select number will change to “2”. The exhaust brake will engage and the transmission will begin to down shift as soon as road and engine speed will safely allow. This will produce a slowing effect and will remain engaged until either the exhaust brake switch is turned off, the accelerator is depressed or the transmission shifts to second gear. If your initial speed is high, you may have to step on the brake to slow the vehicle before the transmission will down-shift from 6th gear to 5th gear. This is normal.

Allison Transmission Fluid Level Check

- Transmission at operating temperature
- Press up and down arrow keys simultaneously
- Wait for 2 minute "count-down"
- Display indicates - OL
 - "OL - OK" indicates good oil level
 - "OL - HI" followed by number indicates quarts over-filled
 - "OL - LO" followed by number indicates quarts under-filled.
 - "OL - 70" transmission not up to operating temperature



Transmission must be at operating temperature. Coach must be on level ground.

Trip Odometer & Odometer

• Trip Odometer & Odometer in Speedo

- A short press of Trip Reset (< 3 sec.) will toggle between Trip mode & Odometer mode
- A long press of Trip Reset (>3 sec.) while in Trip mode will reset the Trip Odometer
- A long press of Trip Reset (>3 sec.) while in Odometer mode will toggle between Miles & Kilometers



2002 MY and After



1999 thru 2001 MY

• Trip Odometer in Tach

• Odometer in Speedo

- A short press of Trip Reset (<3 sec.) will reset the Trip Odometer
- A long press of Trip Reset (>3 sec.) will switch the displays between Miles & Kilometers

The letter "K" & "M" appear to the left lower & upper left side of the Trip Odometer & Odometer indicating Kilometers or Miles on both systems



Trip Reset

- (< 3 sec.) means less than 3 seconds
- (> 3 sec.) means more than 3 seconds
- A small triangle is displayed pointing to either the "K" or "M" telling you if its reading in Kilometers or Miles
- The Trip Reset switch may be located in different places on the dash depending on the Coach builder

LCD Info Center

Provides The Following Information



- Average Fuel Economy
- Instant Fuel Economy
- Fuel Level
- Trip Miles
- Odometer Miles
- Volt Meter
- Oil Pressure
- Engine Temperature
- Engine RPM
- Road Speed (MPH)
- Diagnostics

Auxiliary Air Supply

- Manifold provided for auxiliary air source
 - Up to 120 psi
- Can be used for:
 - Air horn supply
 - Fill tires
 - etc.
- The only approved location for tying into the air system.



This manifold is usually located somewhere toward the front of the coach ie. , firewall, front compartment. The location depends on the coach manufacturer.

(WARNING: Air Tanks should be bled of all pressure any time you work on the air system)

Service With You Down the Road 350 + Locations US & Canada

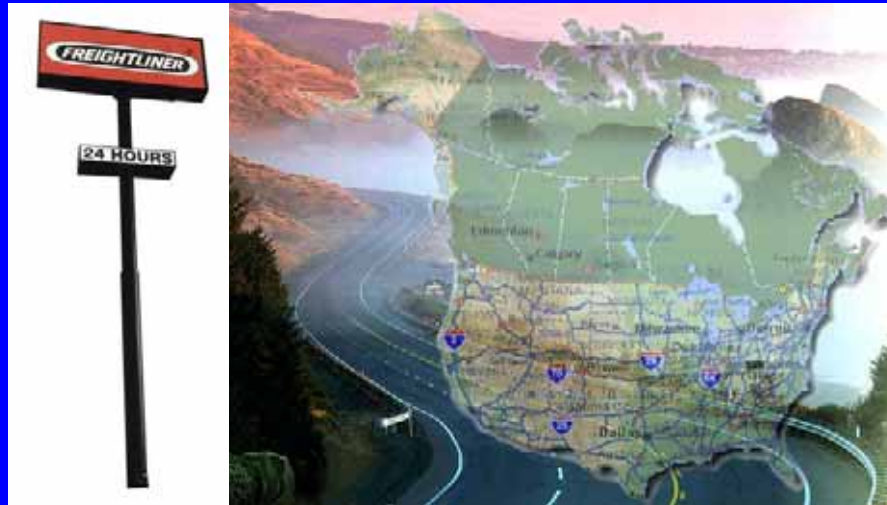

Many open 24 Hrs/7 Days

Consult Your Service Directory For Authorized Locations

Dealer/Service Locator is Available on our WEB SITE at
www.freightlinerchassis.com



WARRANTY

Engine	Cummins	5 Years	100,000 mi
	Caterpillar	5 Years	200,000 mi
Transmission			
	2500 MH Series	5 Years	200,000 mi
	3000 MH Series	5 Years	200,000 mi
Chassis		3 Years	50,000 mi
Drive Train		3 Years	50,000 mi
Suspension		3 Years	50,000 mi
Frame Rails & Crossmembers		5 Years	100,000 mi
Transferable		<i>All of The Above</i>	

4/04

WARRANTY

- Cummins Engine's - 5 yrs. / 100,000 miles.
- Caterpillar Engine - 5 yrs. / 200,000 miles.
- Allison Transmissions:
 - 2500 MH - 5 yrs. / 200,000 miles.
 - 3000 MH - 5 yrs. / 200,000 miles.
- Chassis 3 yrs. / 50,000 miles
- Towing and Roadside Assistance included
- Frame rails & crossmembers - 5 yrs. / 100,000 miles.

All completely transferable.



- **Chapter of FMCA**
- **First year's membership free with the purchase of a new Motorhome built on a Freightliner Chassis**
- **Membership dues \$10 per year**
- **Open to owners of John Deere, Oshkosh and Freightliner chassis**
- **Approximately 4,000 members and growing**
- **Two Rallies per year**
- **Quarterly Newsletter (with technical info)**
- **5% discount on parts and labor at FCCC Gaffney Svc Center**
- **Purchase discounts on New Chrysler vehicles (Chrysler, Dodge, Jeep) Viper excluded**

- Must be a member of FMCA to be a Freightliner Chassis Owners Club Member
- At least two rallies per year held in conjunction with FMCA International Conventions.
 - Rallies Include but not limited to
 - Freightliner Chassis display
 - Freightliner Show and Service Trailer
 - Freightliner Service Technicians
 - Technical Day with Freightliner and Component Manufacturer personnel
 - Fellowship with all
- Quarterly Newsletter - with info on up coming rallies, technical articles from Freightliner, Allison, Caterpillar, Cummins, Michelin, etc.
- 5% parts & service discount at Freightliner Custom Chassis Service Center at the plant in Gaffney, SC
- Purchase Program of new Chrysler, Dodge, Jeep vehicles at below dealer invoice which also includes any cash rebates or special financing. Program excludes Dodge Viper and all Mercedes – Benz vehicles.
- Web site www.freightlinerchassisownersclub.org

