

Thank you for choosing UltraForm System Cabinetry Inc. We offer the widest variety of portable cabinetry in the world!

Fast, Simple Assembly: All cabinets assemble in minutes without tools!

Compact Breakdown: Cabinets knock down to ship in wheeled, roto-molded cases that are UPS and Fedex shippable.

Cabinet Accessories Include: locking doors, keyboard pullouts, shelves, monitor openings, lighting.

The **Tradition line** is the original tambour wrap cabinet. These sturdy cabinets will support 200 lbs. Bases are available in all exhibit fabrics and limited selection of laminated tambour.

The **Epic line** has the look of custom, but at the cost of modular! They are simple, strong and beautiful with a high-end appearance. Available in your choice of laminates to match your display, or we'll use fabric if you prefer. Epic cabinets will support up to 300 lbs.

New **UltraLite** cabinets are a lighter weight and less expensive line made with flexible plastic tambour. **(Many of the cabinets have the same curve as a pop up so they can nest against the backwall.)** UltraLite panels are finished with fabric, or can be ordered as "Graphic-Ready" if you want a smooth finish to adhere graphics. UltraLite cabinets support up to 100 lbs.

UltraForm **Rental** cabinets are available many models, at a fraction of the cost of purchase. They are available with Coal or Silver FrontRunner fabric and Wilsonart Graphite Nebula tops. Rental period is a generous 30 days and we offer an option to purchase after the rental period.

Our **Cases** are heavy-duty, rotomolded with wheels and handles. Most are UPS and Fedex shippable. The Jumbo Shipper is a good alternative to heavy wood custom crates. Jumbos ship via truck line.

Table of Contents

| | |
|--|---|
| <p>Cabinet FinishesII</p> <p>Terms & ConditionsII</p> <p>Freight TermsIII</p> <p>Limited WarrantyIV</p> <p>TraditionT-1</p> <p style="padding-left: 20px;">Pedestal CabinetsT-1</p> <p style="padding-left: 20px;">Multi/Computer StandsT-9</p> <p style="padding-left: 20px;">Computer Cabinets/Pedestals .T-24</p> <p style="padding-left: 20px;">TowersT-28</p> <p>EpicE-1</p> <p style="padding-left: 20px;">Standard/Computer Cabinets .E-1</p> <p style="padding-left: 20px;">KiosksE-21</p> <p style="padding-left: 20px;">TowersE-22</p> | <p>UltraLiteU-1</p> <p style="padding-left: 20px;">Pedestal/Computer Pedestal ..U-1</p> <p style="padding-left: 20px;">Multi/Computer CabinetsU-5</p> <p style="padding-left: 20px;">Folding Curving CabinetU-10</p> <p>RentalsR-1</p> <p style="padding-left: 20px;">Pedestal CabinetsR-1</p> <p style="padding-left: 20px;">Multi/Computer StandsR-4</p> <p style="padding-left: 20px;">Computer PedestalsR-8</p> <p style="padding-left: 20px;">Kiosks/TowersR-9</p> <p style="padding-left: 20px;">Cases/Lit StandsR-11</p> <p style="padding-left: 20px;">Terms & ConditionsR-12</p> <p>CasesC-1</p> <p>AccessoriesA-1</p> |
|--|---|

CHOOSE FROM THESE CABINET FINISHES

Stocked Laminate Colors:

| | | | | | |
|-------------------|-----------------------------|-----------------|---------------------------|-----------------|----------------------|
| <u>Wilsonart:</u> | Black - 1595-60 | <u>Pionite:</u> | Etched Platinum - AG232-N | <u>Formica:</u> | Dover White - F7197 |
| | Platinum - D315-60 | | Pyrenees Marble - ME011-G | | Spectrum Red - F845 |
| | White Nebula - 4621-60 | | Baltic Fresco - AB141 | | Spectrum Blue - F851 |
| | Graphite Nebula - 4623-60 | | Hardrock Maple - WM791 | | |
| | Satin Stainless - 4830-07.1 | | Pearwood - WX031 | | |

(Other colors and brands available, but non-standard orders may affect lead time and cost.)

SurfX Laminate Colors: (for UltraLite Tops)

Black, Pearwood, Hardrock Maple, Brushed Stainless, White

Stocked Fabric Colors:

| | | | |
|---------------------|--|-----------------|---------|
| <u>Frontrunner:</u> | Coal, Cornflower, Imperial, Koala, Panama, Royal Red, Silver, Windsor | <u>Prelude:</u> | Eclipse |
|---------------------|--|-----------------|---------|

(Other colors and exhibit fabrics available.)

Stocked Laminated Tambour Colors:

| | | | |
|-------------------|-----------------------------|-----------------|------------------------|
| <u>Wilsonart:</u> | Black - 1595-60 | <u>Pionite:</u> | Hardrock Maple - WM791 |
| | Graphite Nebula - 4623-60 | | Pearwood - WX031 |
| | Satin Stainless - 4830-07.1 | | |

(Other choices require 4 - 6 weeks lead time and an upcharge.)

Note: Tradition cabinets are available with Laminate tops and Fabric bases, or you may choose Stocked Laminated Tambour bases at no additional cost. UltraLite cabinets come with your choice of SurfX laminate top and Fabric base (laminated tambour is NOT an option.) If you choose our Epic Modular cabinets, we can "customize" them for you with several different laminate choices for the various cabinet components. These choices can be from our Stocked Laminate colors - AND you can choose ONE Non-Stocked Wilsonart, Pionite, Formica or Nevamar Laminate in manufacturer's stock finishes at no additional cost!

TERMS AND CONDITIONS

SPECIFICATIONS:

All dimensions are nominal within one-half inch and are subject to change without notice. Please call for exact dimensions if required.

ORDERING:

A purchase order or other documentation in writing must be submitted to initiate production of an order. Verbal requests will not be honored.

Confirmations of orders are typically provided within 24 hours of receipt. Dealers are responsible for verifying and correcting order information on confirmations.

CANCELLATION FEE

Any orders cancelled within 48 hours of a scheduled ship time will incur a charge equal to 10% of the total order cost, or a minimum of \$50. All cancellations must be in writing by fax, mail or email.

LEAD TIMES:

Normal lead time for standard equipment is 5-7 business days from receipt of order. Lead times will be influenced by specific materials requested. UltraForm reserves the right to ship sooner than standard lead time unless a specific ship date is noted on purchase order.

Custom equipment ships 21 business days from receipt of order pending confirmation of material availability.

Lead time for orders requesting a non-stocked materials is a minimum 15 business days. This is not guaranteed and is dependent upon receipt of material from our supplier.

RUSH CHARGES:

Orders required to ship in less than lead time days from receipt of order are subject to a 15% rush charge.

SHIPPERS:

Prices include a one-way corrugated shipper. Molded shipping cases are available; number and size of cases needed are listed below each unit. Additional case information can be found on page C-1.

FREIGHT:

Freight charges are the responsibility of the dealer. These charges will be billed on the dealer's invoice. See page III for complete "Freight Terms and Responsibilities."

SETUP INSTRUCTIONS:

Provided with all standard orders.

WARRANTY:

For complete "Limited Lifetime Warranty." See page IV.

INSPECTION OF GOODS:

Equipment must be assembled and inspected within 48 hours of receipt.

Shortages, damages or other discrepancies must be reported to UltraForm within 48 hours of receipt of goods.

Any claim of damages due to shipping that extends beyond 15 days after receipt of goods is the responsibility of the dealer.

All prices are stated in U.S. funds and are subject to change without notice.

FREIGHT TERMS & RESPONSIBILITIES

IMPORTANT:

All freight charges are the responsibility of the UltraForm DEALER.

OUTGOING FREIGHT:

All outgoing freight charges are to be prepaid or billed direct to the dealer or end user through the carrier.

a. Prepaid freight:

UltraForm highly recommends that orders be shipped "prepaid freight." For all COD orders, or upon request by dealers with terms, UltraForm will provide a freight estimate as a separate line item on the confirmation of the order sent to the dealer. This estimate can change under the following conditions:

1. Changes to ship to address.
(Final destination)
2. Changes to items ordered.
(Affects weight and dimensions)
3. Changes to need date or lead time.
(Time in transit)
4. Additional charges to be known after shipment is delivered. These include wait time at showsites, large package/oversize fees, fees incurred due to incorrect ship to addresses, and other post-estimate charges billed to UltraForm. These charges will be billed to the dealer when imposed by the carrier. A separate invoice may be issued.

A revised confirmation will be provided should any of these changes occur prior to ship date. Freight charges will be adjusted accordingly.

Prepaid freight will only be allowed through carriers of UltraForm's choice. These include UPS, FedEx, and many well known LTL/FTL carriers. UltraForm has established discount relationships with these carriers, and will make every attempt to provide the best possible freight estimate. UltraForm will also be responsible for making all arrangements with the prepaid freight carriers.

A handling fee is included in this prepaid freight charge. UltraForm will track all packages at the dealer's request. UltraForm will be responsible for contacting the freight carrier in the event of any delays or transit problems. UltraForm will also process any necessary paperwork in regards to freight-related claims.

b. Freight billed directly to dealer or end user:

These guidelines must be followed if freight is to be billed directly to the dealer or end user. This option may only be used under the following conditions:

1. Freight carrier's name, address, phone & fax number must be provided.
2. Dealer's or enduser's freight account number must be provided.
3. If enduser's freight account number is to be used, then enduser's complete name, address, phone & fax number must also be provided. A "3rd Party Billing Information Request Form" will be faxed to the dealer to facilitate this process.
4. Method of shipment must be designated (i.e. service level-overnight, 2-day, 3-day, other; air freight vs. sea freight; etc.)
5. Dealer is responsible for contacting the freight carrier for pickup arrangements. Pickup from UltraForm's shipping dock should be scheduled between 3- 5pm EST.
6. ALL delays, transit problems, and freight related claims are the responsibility of the DEALER.
7. These shipments cannot ship COD. Balance of order must be prepaid prior to scheduled ship date.

Note: All enduser 3rd party pickups will be subject to a \$10.00 processing fee.

IMPORTANT NOTE REGARDING INVALID FREIGHT ACCOUNT NUMBERS:

If an invalid freight account number is provided, all freight charges and associated fees will be billed back to the UltraForm dealer along with a \$25.00 processing fee.

MISCELLANEOUS FREIGHT CHARGES:

If non-UltraForm parts or items are delivered to UltraForm, the dealer has the option to have these items returned. UltraForm will contact the dealer for instructions. These instructions must be provided within (5) days, or items will be disposed of at UltraForm's discretion. Freight for these items may be returned prepaid freight, or billed direct to the dealer's or enduser's freight account number. All enduser 3rd party pickups will be subject to a \$10.00 processing fee.

All prices are stated in U.S. funds and are subject to change without notice.

UltraForm System Cabinetry Inc.

Limited Lifetime Warranty

General Statement: UltraForm System Cabinetry Inc. provides a limited lifetime warranty against defects in materials and workmanship. This warranty is extended to the Dealer and the Customer who purchases the product directly from the Dealer. This warranty is non-transferable.

UltraForm will make every effort to make delivery of equipment as designated by the Dealer, but UltraForm will not be liable for late delivery. Moreover, UltraForm will not be liable for any failure to deliver resulting from circumstances beyond its control. These include, but are not limited to, suppliers' failure to provide required materials, Force Majeure and errors in shipping by freight carriers.

Damage in Transit/Freight Warranty Claims:

Shipments must be checked immediately upon receipt for damage making note of any visible damage on manifest or bill of lading. Contents must be checked for accuracy and concealed damage. UltraForm must be notified of any damages or discrepancies within 48 hours of receipt. Failure to follow these requirements relieves the shipper and carrier of shipment responsibility and will result in denial of any claims.

UltraForm's Warranty and Limitations:

UltraForm warrants that its products, when properly used, stored and maintained, will be free from defects in material and workmanship.

All warranty claims must be made through the Dealer. The Dealer shall provide UltraForm with written notice of any claimed defect within five (5) days of discovery thereof (except "Damage in Transit/Freight" claims covered above) and shall provide satisfactory proof thereof. UltraForm's obligations and the Dealer's or Customer's exclusive remedy under this Warranty shall be limited to repair or replacement by UltraForm, at UltraForm's option, of the products which prove to be defective.

THIS LIMITED LIFETIME WARRANTY IS IN LIEU OF ALL OTHER WARRANTIES WHETHER ORAL, WRITTEN, EXPRESSED, IMPLIED OR STATUTORY. IMPLIED WARRANTIES OF FITNESS AND MERCHANTABILITY SHALL NOT APPLY. ULTRAFORM'S WARRANTY OBLIGATIONS AND THE DEALER'S AND CUSTOMER'S REMEDY THEREUNDER ARE SOLELY AND EXCLUSIVELY AS STATED HEREIN.

The limitations and protections against liability afforded UltraForm herein shall apply to any action or claim in connection with the products sold by UltraForm, whether based on contract, tort, statute or otherwise (including negligence, warranty and strict liability). UltraForm's cumulative limit of liability for such actions or claims shall not exceed the purchase price of the products which prove to be defective. UltraForm shall not be liable to the Dealer, the Customer or any other person or entity for any indirect, special, incidental, punitive or consequential damages, arising from the sale of products or in connection with the use or inability to use the products for any purpose whatsoever, irrespective of whether the claims or actions for such damages are based upon contract, tort, negligence, strict liability, warranty, guarantee or otherwise.

The Dealer's and the Customer's remedies are specifically limited to the repair or replacement at UltraForm's option of products found to be defective and are exclusive of all other remedies. Should these remedies be found inadequate or to have failed of their essential purpose for any reason whatsoever, each of the Dealer and the Customer agrees that return to Dealer by UltraForm of that portion of the purchase price relating to the defective products shall prevent the remedies from failing of their essential purpose and shall be considered by the Dealer and the Customer as a fair and adequate remedy.

UltraForm reserves the right to determine the final resolution of all warranty claims. Verbal approval for claims may be granted upon the initial information provided by the Dealer via phone or fax. However, if it is determined that the defect or damage is excluded from this warranty as set forth below, the Dealer will be responsible for all costs including, but not limited to, production time, materials, and freight costs incurred by UltraForm.

A return authorization must be approved prior to return. The Dealer should contact UltraForm's Customer Service Department for instruction related to the return authorization. If the Dealer fails to request a return authorization prior to making a return of goods, UltraForm will not be responsible for lost or misdirected shipments. It is the Dealer's responsibility to coordinate with UltraForm to meet required deadlines and need dates.

UltraForm will pay round trip freight charges on all valid warranty- related shipments up to 90 days from initial ship date. The ship method for these returns will be left to UltraForm's discretion. For warranty claims placed after 90 days from initial ship date, Purchaser pays all expenses to and from UltraForm's Scottsville, New York location.

Exclusions from UltraForm's Warranty:

UltraForm's warranty does not extend to: normal wear and tear (i.e. scratches, loose screws, scuffs and marks on cases, etc.); bending or warping due to improper storage (parts must be stored properly and in temperature-controlled environments); delamination caused by inappropriate use; or damage caused by misuse of abuse (i.e. damaged corners, cracks in laminate, etc.), including damage as a result of failure to follow repacking instructions. This list should not be considered all-inclusive.

PEDESTAL CABINETS

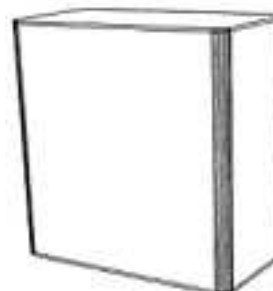
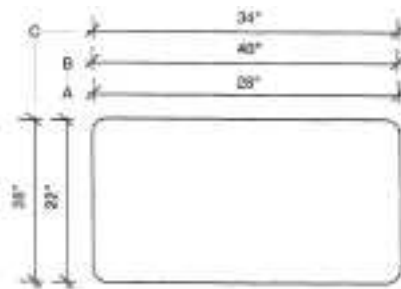

Rectangle 22" x 28" *Dimensions A*

| Order # | Description | Price | Weight |
|---------|--|--------|--------|
| 2228-24 | 24" High | 483.00 | 27 |
| 2228-33 | 33" High | 539.00 | 33 |
| 2228-42 | 42" High | 597.00 | 33 |
| S2228K | 22" x 28" Shelf kit with poles & collars | 89.00 | 07 |

* Packs two per UF4325 case at \$330.00 ea.

Rectangle 22" x 40" *Dimensions B*

| | | | |
|---------|------------------------------|--------|----|
| 2240-24 | 24" High with support poles | 638.00 | 36 |
| 2240-33 | 33" High with support poles | 706.00 | 42 |
| 2240-42 | 42" High with support poles | 784.00 | 49 |
| S2240C | 22" x 40" Shelf with collars | 54.00 | 07 |

* Packs two per UF4325 case at \$330.00 ea

Rectangle 28" x 34" *Dimensions C*

| | | | |
|---------|------------------------------|--------|----|
| 2834-24 | 24" High with support poles | 638.00 | 36 |
| 2834-33 | 33" High with support poles | 706.00 | 42 |
| 2834-42 | 42" High with support poles | 784.00 | 49 |
| S2834C | 28" x 34" Shelf with collars | 54.00 | 07 |

* Packs in one UF4331 case at \$330.00 ea

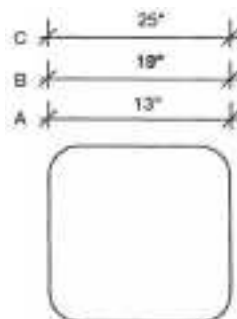

Square 13" x 13" *Dimensions A*

| | | | |
|---------|----------|--------|----|
| 1313-24 | 24" High | 276.00 | 12 |
| 1313-33 | 33" High | 304.00 | 14 |
| 1313-42 | 42" High | 333.00 | 15 |

* Packs three per UF4325 case at \$330.00 ea

Square 19" x 19" *Dimensions B*

| | | | |
|---------|----------|--------|----|
| 1919-24 | 24" High | 396.00 | 17 |
| 1919-33 | 33" High | 442.00 | 21 |
| 1919-42 | 42" High | 488.00 | 25 |

* Packs two per UF4325 case at \$330.00 ea

Square 25" x 25" SEE NEXT PAGE

PEDESTAL CABINETS

Square 25" x 25" *Dimensions C*

| Order # | Description | Price | Weight |
|---------|--|--------|--------|
| 2525-24 | 24" High | 483.00 | 27 |
| 2525-33 | 33" High | 539.00 | 32 |
| 2525-42 | 42" High | 597.00 | 33 |
| S2525K | 25" x 25" Shelf kit with poles & collars | 89.00 | 07 |

* Packs two in UF4331 case at \$330.00 ea

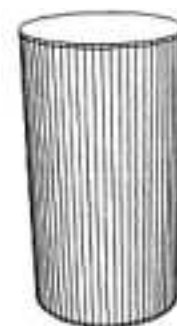
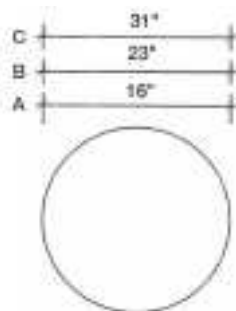

Round 16" diameter *Dimensions A*

| | | | |
|--------|----------|--------|----|
| R16-24 | 24" High | 276.00 | 12 |
| R16-33 | 33" High | 304.00 | 15 |
| R16-42 | 42" High | 333.00 | 15 |

* Packs three per UF4325 case at \$330.00 ea

Round 23" diameter *Dimensions B*

| | | | |
|--------|----------|--------|----|
| R23-24 | 24" High | 396.00 | 18 |
| R23-33 | 33" High | 442.00 | 22 |
| R23-42 | 42" High | 488.00 | 26 |

* Packs two per UF4325 case at \$330.00 ea

Round 31" diameter *Dimensions C*

| | | | |
|--------|--|--------|----|
| R31-24 | 24" High | 494.00 | 27 |
| R31-33 | 33" High | 550.00 | 32 |
| R31-42 | 42" High | 608.00 | 33 |
| SR31K | 31" Round Shelf kit with poles & collars | 89.00 | 08 |

* Packs one in UF4331 case at \$330.00 ea

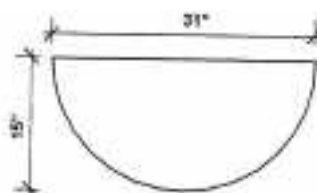

Half Round 31" x 15"--open back

| | | | |
|----------|---|--------|----|
| R3115-24 | 24" High, for use against other cabinet or backwall | 276.00 | 17 |
| R3115-33 | 33" High, for use against other cabinet or backwall | 304.00 | 20 |
| R3115-42 | 42" High, for use against other cabinet or backwall | 333.00 | 20 |
| PR3115 | Panel to close back | 132.00 | 04 |

* Packs two per UF4325 case at \$330.00 ea

* NOT SUITABLE FOR FREESTANDING USE



PEDESTAL CABINETS

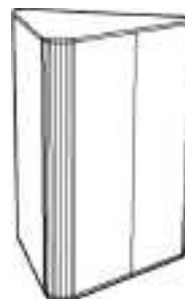
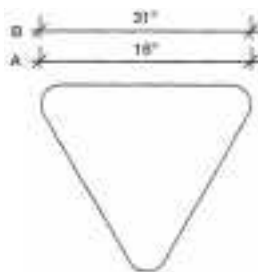

Triangle 16" *Dimensions A*

| Order # | Description | Price | Weight |
|---------|-------------|--------|--------|
| T16-24 | 24" High | 276.00 | 12 |
| T16-33 | 33" High | 304.00 | 14 |
| T16-42 | 42" High | 333.00 | 15 |

* Packs three per UF4325 case at \$330.00 ea

Triangle 31" *Dimensions B*

| | | | |
|--------|---|--------|----|
| T31-24 | 24" High | 494.00 | 25 |
| T31-33 | 33" High | 550.00 | 31 |
| T31-42 | 42" High | 608.00 | 31 |
| ST31K | 31" Triangle Shelf kit with poles & collars | 89.00 | 08 |

* Packs in one UF4331 case at \$330.00 ea

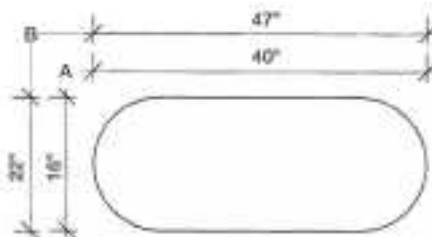

Oval 16" x 40" *Dimensions A*

| | | | |
|----------|--|--------|----|
| O1640-24 | 24" High | 483.00 | 27 |
| O1640-33 | 33" High | 539.00 | 33 |
| O1640-42 | 42" High | 597.00 | 33 |
| SO1640K | 16" x 40" Shelf kit with poles & collars | 89.00 | 07 |

* Packs two per UF4325 case at \$330.00 ea

Oval 22" x 47" *Dimensions B*

| | | | |
|----------|------------------------------|--------|----|
| O2247-24 | 24" High with poles | 638.00 | 36 |
| O2247-33 | 33" High with poles | 706.00 | 42 |
| O2247-42 | 42" High with poles | 784.00 | 49 |
| SO2247C | 22" x 47" Shelf with collars | 57.00 | 07 |

* Packs two per UF4825 case at \$330.00 ea

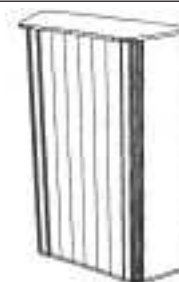
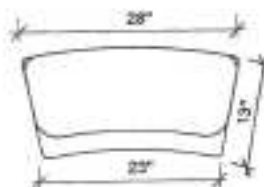

Curved Cabinet 13" x 28" for pop-up backwalls

| | | | |
|----------|--|--------|----|
| P1328-24 | 24" High curved back to match pop-up backwalls | 396.00 | 17 |
| P1328-33 | 33" High curved back to match pop-up backwalls | 442.00 | 20 |
| P1328-42 | 42" High curved back to match pop-up backwalls | 488.00 | 25 |

* Packs two per UF4325 case at \$330.00 ea

PEDESTAL CABINETS

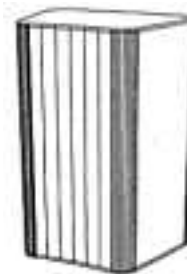
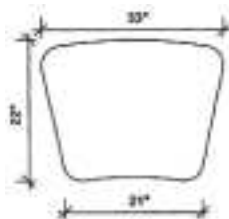

Curved Cabinet 22" x 33" for pop-up backwalls

| Order # | Description | Price | Weight |
|----------|---|--------|--------|
| P2233-24 | 24" High, curved back to match pop-up backwalls | 483.00 | 27 |
| P2233-33 | 33" High, curved back to match pop-up backwalls | 539.00 | 33 |
| P2233-42 | 42" High, curved back to match pop-up backwalls | 597.00 | 33 |

* Packs two per UF4325 case at \$330.00 ea

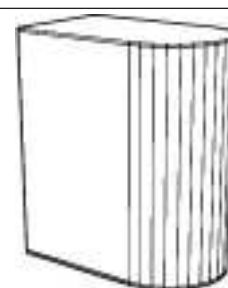
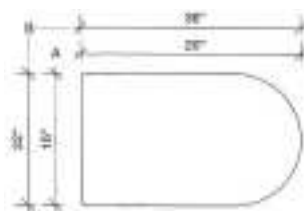

Half Oval 16" x 20"--open back *Dimensions A*

| | | | |
|-----------|---|--------|----|
| HO1620-24 | 24" High, for use against other cabinet or backwall | 276.00 | 14 |
| HO1620-33 | 33" High, for use against other cabinet or backwall | 304.00 | 17 |
| HO1620-42 | 42" High, for use against other cabinet or backwall | 333.00 | 17 |
| PHO1620 | Panel to close back | 132.00 | 03 |

* Packs two per UF4325 case at \$330.00 ea

* NOT SUITABLE FOR FREESTANDING USE

Half Oval 22" x 36"--fully enclosed *Dimensions B*

| | | | |
|-----------|--|--------|----|
| HO2236-24 | 24" High | 483.00 | 29 |
| HO2236-33 | 33" High | 539.00 | 34 |
| HO2236-42 | 42" High | 597.00 | 37 |
| SHO2236K | 22" x 36" Half oval shelf kit with poles & collars | 89.00 | 07 |

* Packs two per UF4325 case at \$330.00 ea

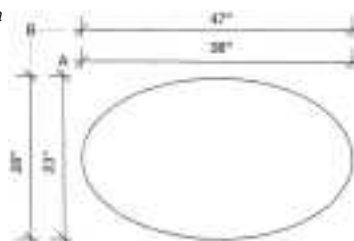

Ellipse 23" x 38" *Dimensions A*

| | | | |
|----------|--|--------|----|
| E2338-24 | 24" High | 494.00 | 27 |
| E2338-33 | 33" High | 550.00 | 32 |
| E2338-42 | 42" High | 608.00 | 33 |
| SE2338K | 23" x 38" Shelf kit with poles & collars | 89.00 | 08 |

* Packs two per UF4325 case at \$330.00 ea

Ellipse 28" x 47" *Dimensions B*

| | | | |
|----------|--------------------------------------|--------|----|
| E2847-24 | 24" High with support poles | 638.00 | 36 |
| E2847-33 | 33" High with support poles | 706.00 | 42 |
| E2847-42 | 42" High with support poles | 784.00 | 49 |
| SE2847C | 28" x 47" Ellipse shelf with collars | 57.00 | 07 |

* Packs in one UF4831 case at \$330.00 ea

PEDESTAL CABINETS

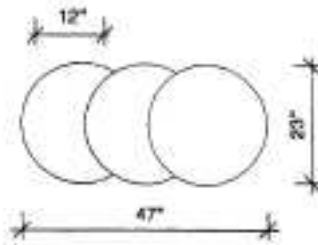

Three Cabinet Crescent Set: Round 23" diameter with two crescents

| Order # | Description | Price | Weight |
|---------|--------------------|----------|--------|
| CA323 | 42", 33", 24" High | 1,104.00 | 58 |

* Packs in one UF4325 case at \$330.00 ea

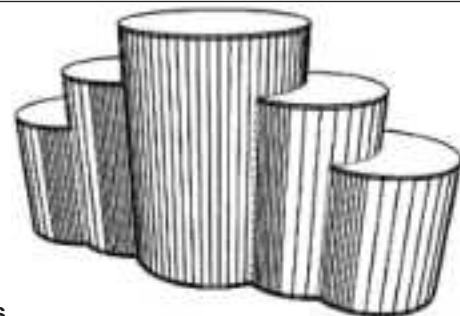
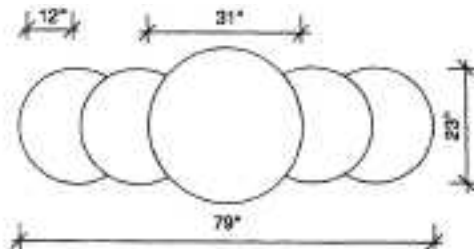

Five Cabinet Crescent Set: Round 31" diameter with four crescents

| | | | |
|-------|--------------------|----------|----|
| CA531 | 42", 33", 24" High | 1,840.00 | 99 |
|-------|--------------------|----------|----|

* Packs in one UF4331 case and one UF4325 case at \$330.00 ea

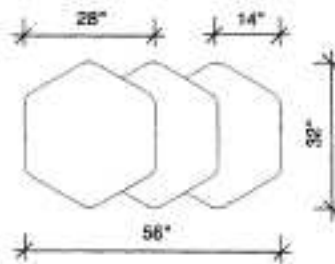

Three Cabinet Hex Crescent Set: Hexagon 32" with two hex crescents

| | | | |
|--------|--------------------|----------|----|
| XCA332 | 42", 33", 24" High | 1,538.00 | 84 |
|--------|--------------------|----------|----|

* Packs in two UF4331 cases at \$330.00 ea

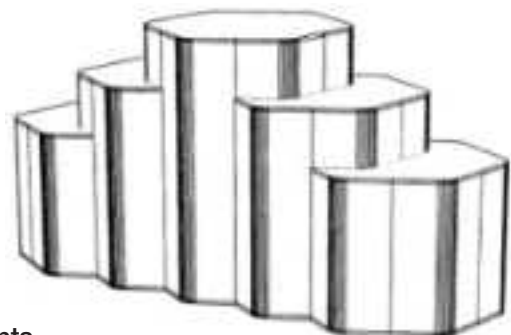
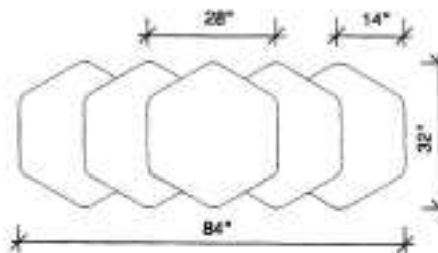

Five Cabinet Hex Crescent Set: Hexagon 32" with four hex crescents

| | | | |
|--------|--------------------|----------|-----|
| XCA532 | 42", 33", 24" High | 2,468.00 | 135 |
|--------|--------------------|----------|-----|

* Packs in three UF4331 cases at \$330.00 ea

PEDESTAL CABINETS

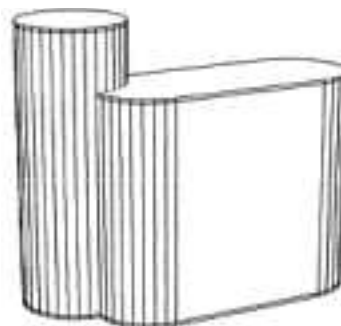
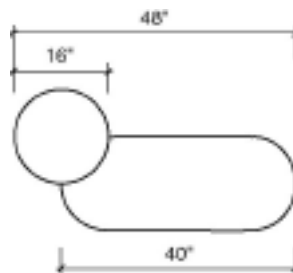

SHY200R

Oval Crescent 16" x 40" and 16" round

| Order # | Description | Price | Weight |
|----------|---|--------|--------|
| SHY200R | Right oval crescent and round set 42" and 33" high | 841.00 | 43 |
| SHY200L | Left oval crescent and round set 42" and 33" high | 841.00 | 43 |
| SOC1640K | Shelf Kit, Oval crescent 16" x 40" with poles and collars | 89.00 | 07 |

* Packs in one UF4325 case at \$330.00 ea

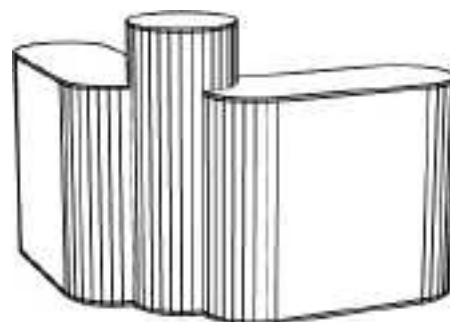
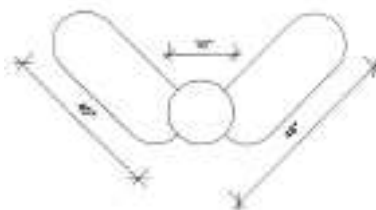

Right and Left Oval Crescent 16" x 40" and 16" round

| | | | |
|----------|---|----------|----|
| SHY300 | Right and left oval crescent and round set 42" and 33" high | 1,349.00 | 72 |
| SOC1640K | Shelf Kit, Oval crescent 16" x 40" with poles and collars | 89.00 | 07 |

* Packs in two UF4325 cases at \$330.00 ea



CTR31

Round 31" Conference Table on 16" round base

| | | | |
|----------|----------|--------|----|
| CTR31-29 | 29" High | 345.00 | 17 |
| CTR31-42 | 42" High | 374.00 | 20 |

* Packs two per UF4331 case at \$330.00 ea

Round 46" Conference Table with split top on 23" round base

| | | | |
|----------|----------|--------|----|
| CTR46-29 | 29" High | 632.00 | 44 |
| CTR46-42 | 42" High | 678.00 | 50 |

* Packs in one UF4831 case at \$330.00 ea

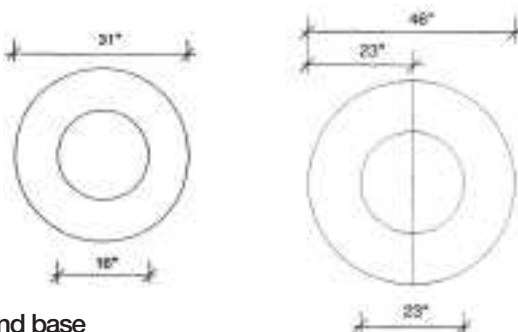

CTR46

PEDESTAL CABINETS

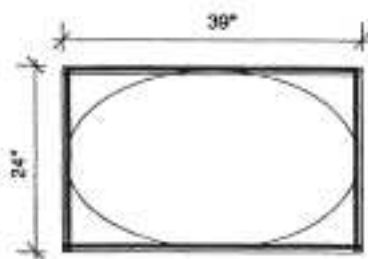

Select material for base and pad

Locking Jewelry Case 24" x 39" x 7" high on 33" high elliptical base - 40" overall
Acrylic w/abrasion resistant coating and black anodized aluminum frame

| Order # | Description | Price | Weight |
|---------|--|----------|--------|
| LJ7-40E | 40" High on elliptical base | 1,418.00 | 69 |
| LJ7 | 7" High without base | 925.00 | 44 |
| SCL | Showcase light option--17 Watt Fluorescent | 278.00 | 02 |

* Packs in one UF4325 case at \$330.00 ea

* Jewelry case size can be customized

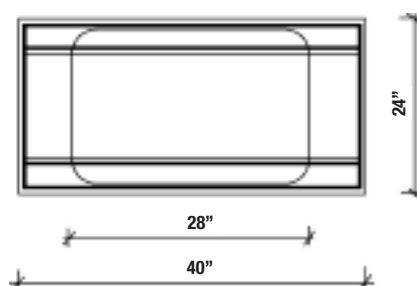

Select material for base, case ends and pad

Folding Display Case 24" x 40" x 12" high on 33" high rectangular base - 45" overall.
Hinged acrylic panels w/abrasion resistant coating

| | | | |
|-----------|---|----------|----|
| FD12-45R | 45" High on rectangular base | 945.00 | 68 |
| FD12 | 12" High without base | 466.00 | 43 |
| FDL12-45R | 45" High on rectangular base, Locking model | 1,109.00 | 70 |
| FDL12 | 12" High without base, Locking model | 630.00 | 44 |
| SCL | Showcase light option--17 Watt Fluorescent | 278.00 | 02 |

* Packs in one UF4331 case at \$330.00 ea

* Jewelry case size can be customized

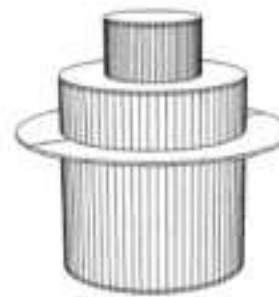
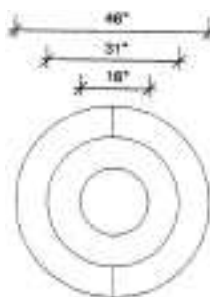

Multi-Level Round 46", 31", 16" diameter

| | | | |
|-------|--------------------|----------|----|
| RML46 | 24", 33", 42" High | 1,234.00 | 71 |
|-------|--------------------|----------|----|

* Packs in two UF4831 cases at \$330.00 ea

PEDESTAL CABINETS

Corner Cabinet 22"

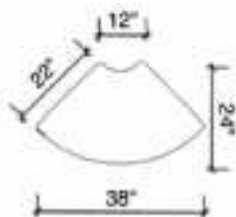

| Order # | Description | Price | Weight |
|----------|-------------|--------|--------|
| COR22-33 | 33" High | 539.00 | 30 |
| COR22-42 | 42" High | 597.00 | 33 |

* Packs in one UF4325 case at \$330.00 ea

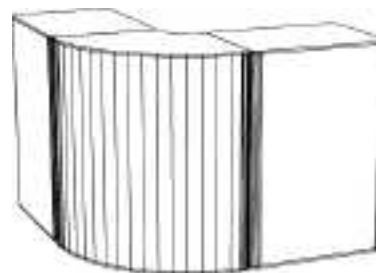
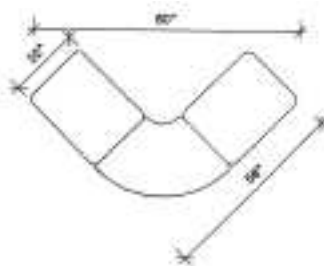

Three Cabinet Corner Set: Corner cabinet 22" and two 22" x 28" rectangles

| | | | |
|--------|---|----------|-----|
| SHY400 | 42" High | 1,791.00 | 100 |
| S2228K | Shelf kit, 22" x 28" with poles and collars | 89.00 | 07 |

* Packs in two UF4325 cases at \$330.00 ea

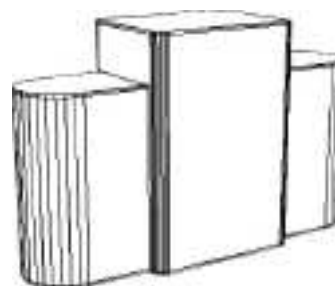
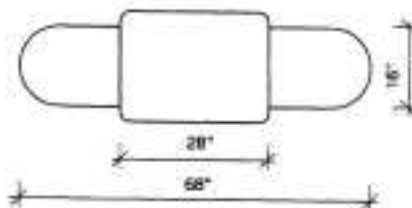

Rectangle Half Oval Set: 22" X 28" rectangle and two 16" x 20" half ovals

| | | | |
|---------|------------------|----------|----|
| SHY2228 | 42" and 33" High | 1,205.00 | 66 |
|---------|------------------|----------|----|

* Packs in one UF4325 case at \$330.00 ea

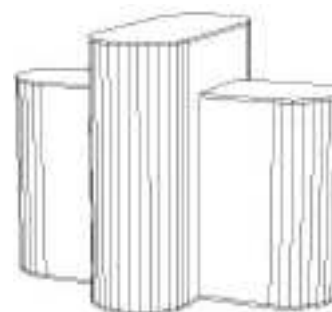
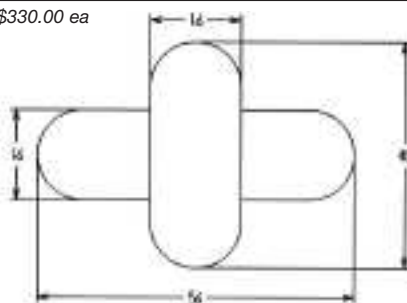

Oval, Half Oval Set: 16" x 40" oval and two 16" x 20" half ovals

| | | | |
|---------|------------------|----------|----|
| SHY1640 | 42" and 33" High | 1,205.00 | 66 |
|---------|------------------|----------|----|

* Packs in one UF4325 case at \$330.00 ea

COMPUTER STANDS



CS2232-42

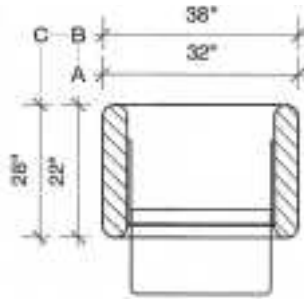

MULTI-STANDS

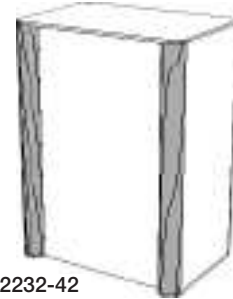

MB2232-42

Rectangular Computer Stand 22" x 32"--open back *Dimensions A*

| Order # | Description | Price | Weight |
|-----------|---|--------|--------|
| CS2232-29 | 29" High desk with one inside shelf, one keyboard pullout | 868.00 | 42 |
| CS2232-42 | 42" High desk with one inside shelf, one keyboard pullout | 937.00 | 50 |
| WM153 | 1.5" x 3" Rectangular wire management grommet, (specify location) | 19.00 | 00 |
| SM1424 | 14" x 24" Shelf | 43.00 | 04 |
| 24D | Door | 184.00 | 12 |
| 24LD | Locking Door | 226.00 | 12 |

* Packs in one UF4325 case at \$330.00 ea

Rectangular Multi-Stand 22" x 32"--open back *Dimensions A*

| | | | |
|-----------|-----------------|--------|----|
| MB2232-29 | 29" High desk | 746.00 | 32 |
| MB2232-33 | 33" High | 746.00 | 37 |
| MB2232-42 | 42" High | 815.00 | 40 |
| SM1424 | 14" x 24" Shelf | 43.00 | 04 |
| 24D | Door | 184.00 | 12 |
| 24LD | Locking Door | 226.00 | 12 |

* Packs in one UF4325 case at \$330.00 ea

Rectangular Computer Stand 22" x 38"--open back *Dimensions B*

| | | | |
|-----------|---|--------|----|
| CS2238-29 | 29" High desk with one inside shelf, one keyboard pullout | 868.00 | 46 |
| CS2238-42 | 42" high desk with one inside shelf, one keyboard pullout | 937.00 | 54 |
| WM153 | 1.5" x 3" Rectangular wire management grommet, (specify location) | 19.00 | 00 |
| SM1430 | 14" x 30" Shelf | 43.00 | 05 |
| 30D | Door | 184.00 | 13 |
| 30LD | Locking Door | 226.00 | 13 |

* Packs in one UF4331 case at \$330.00 ea

Rectangular Multi-Stand 22" x 38"--open back *Dimensions B*

| | | | |
|-----------|-----------------|--------|----|
| MB2238-29 | 29" High desk | 746.00 | 34 |
| MB2238-33 | 33" High | 746.00 | 40 |
| MB2238-42 | 42" High | 815.00 | 43 |
| SM1430 | 14" x 30" Shelf | 43.00 | 05 |
| 30D | Door | 184.00 | 13 |
| 30LD | Locking Door | 226.00 | 13 |

* Packs in one UF4331 case at \$330.00 ea

Continued--SEE NEXT PAGE

COMPUTER STANDS

MULTI-STANDS

Rectangular Computer Stand 28" x 38"--open back *Dimensions C (See images on previous page)*

| Order # | Description | Price | Weight |
|-----------|--|----------|--------|
| CS2838-29 | 29" High desk with one inside shelf, one keyboard pullout | 1,009.00 | 55 |
| CS2838-42 | 42" High desk with one inside shelf, one keyboard pullout | 1,098.00 | 67 |
| WM153 | 1.5" x 3" Rectangular wire management grommet , (specify location) | 19.00 | 00 |
| SM2030 | 20" x 30" Shelf | 43.00 | 06 |
| 30D | Door | 184.00 | 13 |
| 30LD | Locking Door | 226.00 | 13 |

* Packs in one UF4331 case at \$330.00 ea

Rectangular Multi-Stand 28" x 38"--open back *Dimensions C*

| | | | |
|-----------|-----------------|--------|----|
| MB2838-29 | 29" High desk | 887.00 | 43 |
| MB2838-33 | 33" High | 887.00 | 46 |
| MB2838-42 | 42" High | 976.00 | 54 |
| SM2030 | 20" x 30" Shelf | 43.00 | 06 |
| 30D | Door | 184.00 | 13 |
| 30LD | Locking Door | 226.00 | 13 |

* Packs in one UF4331 case at \$330.00 ea

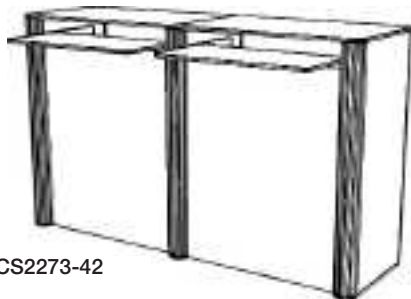

CS2273-42

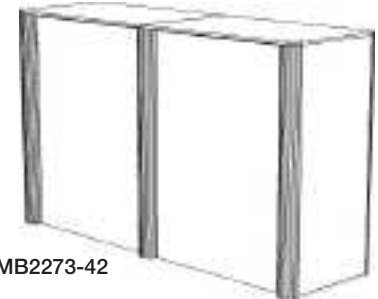
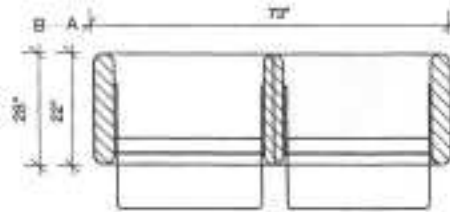

MB2273-42

Rectangular Computer Stand 22" x 73"--open back, 2 sections *Dimensions A*

| | | | |
|-----------|--|----------|----|
| CS2273-29 | 29" High desk with two inside shelves, two keyboard pullouts | 1,532.00 | 82 |
| CS2273-42 | 42" High desk with two inside shelves, two keyboard pullouts | 1,641.00 | 95 |
| WM153 | 1.5" x 3" Rectangular wire management grommet , (specify location) | 19.00 | 00 |
| SM1430 | 14" x 30" Shelf | 43.00 | 05 |
| 30D | Door | 184.00 | 13 |
| 30LD | Locking Door | 226.00 | 13 |

* Packs in one UF4331 case and one UF4825 case at \$330.00 ea

Rectangular Multi-Stand 22" x 73"--open back, 2 sections *Dimensions A*

| | | | |
|-----------|-----------------|----------|----|
| MB2273-29 | 29" High desk | 1,288.00 | 58 |
| MB2273-33 | 33" High | 1,288.00 | 68 |
| MB2273-42 | 42" High | 1,397.00 | 73 |
| SM1430 | 14" x 30" Shelf | 43.00 | 05 |
| 30D | Door | 184.00 | 13 |
| 30LD | Locking Door | 226.00 | 13 |

* Packs in two UF4331 cases at \$330.00 ea

Continued--SEE NEXT PAGE

COMPUTER STANDS

MULTI-STANDS

Rectangular Computer Stand 28" x 73"--open back, 2 sections *Dimensions B (See images on previous page)*

| Order # | Description | Price | Weight |
|-----------|--|----------|--------|
| CS2873-29 | 29" High desk with two inside shelves, two keyboard pullouts | 1,726.00 | 99 |
| CS2873-42 | 42" High desk with two inside shelves, two keyboard pullouts | 1,865.00 | 115 |
| WM153 | 1.5" x 3" Rectangular wire management grommet , (specify location) | 19.00 | 00 |
| SM2030 | 20" x 30" Shelf | 43.00 | 06 |
| 30D | Door | 184.00 | 13 |
| 30LD | Locking Door | 226.00 | 13 |

* Packs in two UF4331 cases at \$330.00 ea

Rectangular Multi-Stand 28" x 73"--open back, 2 sections *Dimensions B*

| | | | |
|-----------|-----------------|----------|----|
| MB2873-29 | 29" High desk | 1,482.00 | 71 |
| MB2873-33 | 33" High | 1,482.00 | 77 |
| MB2873-42 | 42" High | 1,621.00 | 89 |
| SM2030 | 20" x 30" Shelf | 43.00 | 06 |
| 30D | Door | 184.00 | 13 |
| 30LD | Locking Door | 226.00 | 13 |

* Packs in one UF4331 case and one UF4825 case at \$330.00 ea

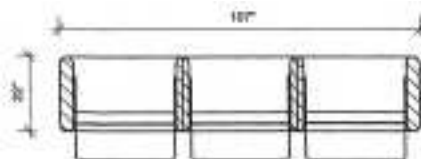

Rectangular Computer Stand 22" x 107"--open back, 3 sections

| | | | |
|------------|--|----------|-----|
| CS22107-29 | 29" High desk with three inside shelves, three keyboard pullouts | 2,165.00 | 119 |
| CS22107-42 | 42" High desk with three inside shelves, three keyboard pullouts | 2,314.00 | 137 |
| WM153 | 1.5" x 3" Rectangular wire management grommet , (specify location) | 19.00 | 00 |
| SM1430 | 14" x 30" Shelf | 43.00 | 05 |
| 30D | Door | 184.00 | 13 |
| 30LD | Locking Door | 226.00 | 13 |

* Packs in three (one UF4331 and two UF4825) cases at \$330.00 ea

Continued--SEE NEXT PAGE

COMPUTER STANDS

MULTI-STANDS

Rectangular Multi-Stand 28" x 107"--open back, 3 sections *(See images on previous page)*

| Order # | Description | Price | Weight |
|------------|-----------------|----------|--------|
| MB22107-29 | 29" High desk | 1,799.00 | 82 |
| MB22107-33 | 33" High | 1,799.00 | 95 |
| MB22107-42 | 42" High | 1,948.00 | 103 |
| SM1430 | 14" x 30" Shelf | 43.00 | 06 |
| 30D | Door | 184.00 | 13 |
| 30LD | Locking Door | 226.00 | 13 |

* Packs in one UF4331 case and one UF4825 case at \$330.00 ea

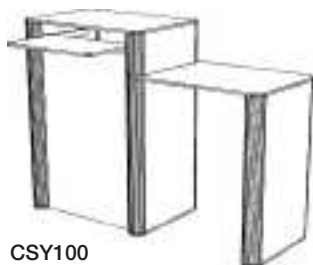

CSY100

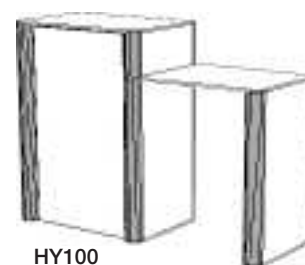
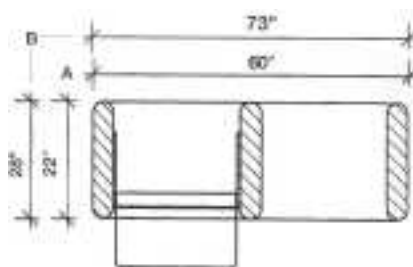

HY100

Rectangular Computer Stand 22" x 60" one straight extension--open back, 2 sections *Dimensions A*

| | | | |
|--------|---|----------|----|
| CSY100 | 42" High with extension at 33" high, one inside shelf, one keyboard pullout | 1,429.00 | 73 |
| WM153 | 1.5" x 3" Rectangular wire management grommet , (specify location) | 19.00 | 00 |
| SM1424 | 14" x 24" Shelf | 43.00 | 04 |
| 24D | Door | 184.00 | 12 |
| 24LD | Locking Door | 226.00 | 12 |

* Packs in one UF4325 case at \$330.00 ea-- additional case required for options

Bi-Level Rectangle 22" x 60" one straight extension--open back, 2 sections *Dimensions A*

| | | | |
|--------|--|----------|----|
| HY100 | 42" High with straight extension at 33" high | 1,307.00 | 63 |
| SM1424 | 14" x 24" Shelf | 43.00 | 04 |
| 24D | Door | 184.00 | 12 |
| 24LD | Locking Door | 226.00 | 12 |

* Packs in one UF4325 case at \$330.00 ea

Rectangular Computer Stand 28" x 73" one straight extension--open back, 2 sections *Dimensions B*

| | | | |
|--------|---|----------|----|
| CSY300 | 42" High with extension at 33" high, one inside shelf, one keyboard pullout | 1,695.00 | 94 |
| WM153 | 1.5" x 3" Rectangular wire management grommet , (specify location) | 19.00 | 00 |
| SM2030 | 20" x 30" Shelf | 43.00 | 04 |
| 30D | Door | 184.00 | 13 |
| 30LD | Locking Door | 226.00 | 13 |

* Packs in two UF4331 cases at \$330.00 ea

Bi-Level Rectangle 28" x 73" one straight extension--open back, 2 sections *Dimensions B*

| | | | |
|--------|--|----------|----|
| HY300 | 42" High with straight extension at 33" high | 1,573.00 | 81 |
| SM2030 | 20" x 30" Shelf | 43.00 | 06 |
| 30D | Door | 184.00 | 13 |
| 30LD | Locking Door | 226.00 | 13 |

* Packs in one UF4325 at \$330.00 ea

COMPUTER STANDS

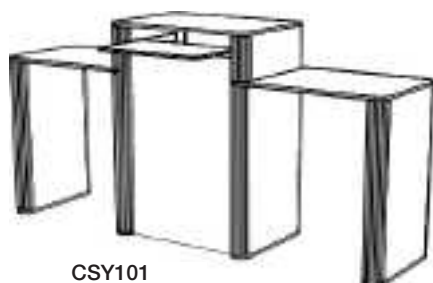

CSY101

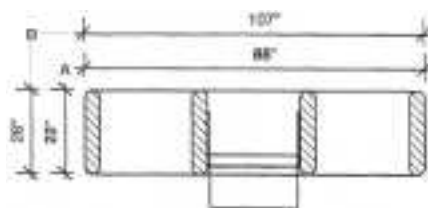

MULTI-STANDS

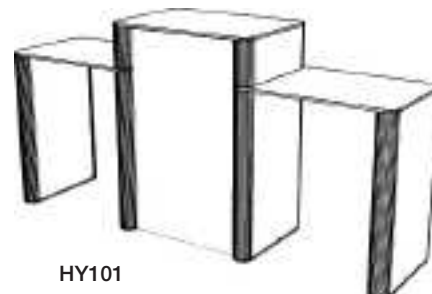

HY101

Rectangular Computer Stand 22" x 88" two straight extensions--open back, 3 sections *Dimensions A*

| Order # | Description | Price | Weight |
|---------|--|----------|--------|
| CSY101 | 42" High with extensions at 33" high, one inside shelf, one keyboard pullout | 1,921.00 | 96 |
| WM153 | 1.5" x 3" Rectangular wire management grommet , (specify location) | 19.00 | 00 |
| SM1424 | 14" x 24" Shelf | 43.00 | 04 |
| 24D | Door | 184.00 | 12 |
| 24LD | Locking Door | 226.00 | 12 |

* Packs in two UF4325 cases at \$330.00 ea

Bi-Level Rectangle 22" x 88" two straight extensions--open back, 3 sections *Dimensions A*

| | | | |
|--------|---|----------|----|
| HY101 | 42" High with two straight extensions at 33" high | 1,799.00 | 86 |
| SM1424 | 14" x 24" Shelf | 43.00 | 04 |
| 24D | Door | 184.00 | 12 |
| 24LD | Locking Door | 226.00 | 12 |

* Packs in two UF4325 cases at \$330.00 ea

Rectangular Computer Stand 28" x 107" two straight extensions--open back, 3 sections *Dimensions B*

| | | | |
|--------|--|----------|-----|
| CSY301 | 42" High with extensions at 33" high, one inside shelf, one keyboard pullout | 2,292.00 | 122 |
| WM153 | 1.5" x 3" Rectangular wire management grommet , (specify location) | 19.00 | 00 |
| SM2030 | 20" x 30" Shelf | 43.00 | 04 |
| 30D | Door | 184.00 | 13 |
| 30LD | Locking Door | 226.00 | 13 |

* Packs in two UF4331 cases at \$330.00 ea

Bi-Level Rectangle 28" x 107" two straight extensions--open back, 3 sections *Dimensions B*

| | | | |
|--------|---|----------|-----|
| HY301 | 42" High with two straight extensions at 33" high | 2,170.00 | 109 |
| SM2030 | 20" x 30" Shelf | 43.00 | 06 |
| 30D | Door | 184.00 | 13 |
| 30LD | Locking Door | 226.00 | 13 |

* Packs in two UF4331 cases at \$330.00 ea

COMPUTER STANDS

MULTI-STANDS

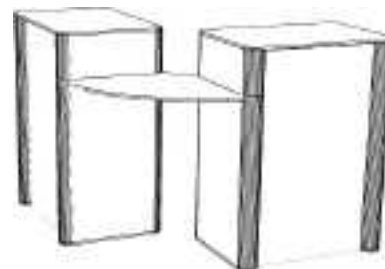
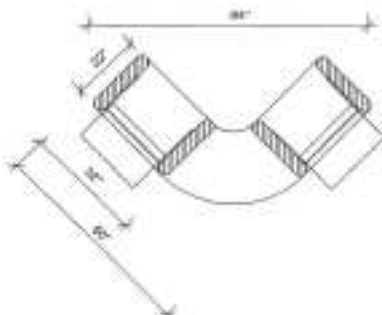

Two Rectangular Computer Stands 22" x 32" with 90 degree curving connection--open back

| Order # | Description | Price | Weight |
|-----------|---|----------|--------|
| CSY108-90 | 42" High with connecting top at 33" high, two inside shelves, two keyboard pullouts | 2,231.00 | 115 |
| WM153 | 1.5" x 3" Rectangular wire management grommet , (specify location) | 19.00 | 00 |
| SM1424 | 14" x 24" Shelf | 43.00 | 04 |
| 24D | Door | 184.00 | 12 |
| 24LD | Locking Door | 226.00 | 12 |

* Packs in two UF4325 cases at \$330.00 ea -- additional case required for options

Two Rectangular Multi-Stands 22" x 32" with 90 degree curving connection--open back

| | | | |
|----------|--|----------|----|
| HY108-90 | 42" High with connecting top at 33" high | 1,987.00 | 96 |
| SM1424 | 14" x 24" Shelf | 43.00 | 04 |
| 24D | Door | 184.00 | 12 |
| 24LD | Locking Door | 226.00 | 12 |

* Packs in two UF4325 cases at \$330.00 ea

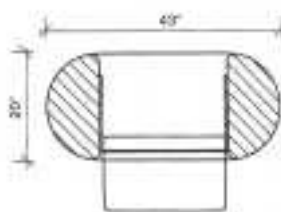

Oval Computer Stand 20" x 43"

| | | | |
|------------|--|--------|----|
| CSO2043-29 | 29" High desk with one inside shelf, one keyboard pullout | 868.00 | 44 |
| CSO2043-42 | 42" High desk with one inside shelf, one keyboard pullout | 937.00 | 51 |
| WM153 | 1.5" x 3" Rectangular wire management grommet , (specify location) | 19.00 | 00 |
| SM1424 | 14" x 24" Shelf | 43.00 | 05 |
| 24D | Door | 184.00 | 12 |
| 24LD | Locking Door | 226.00 | 12 |

* Packs in one UF4825 case at \$330.00 ea

Continued--SEE NEXT PAGE

COMPUTER STANDS

MULTI-STANDS

Oval Multi-Stand 20" x 43"--open back (See previous page for image)

| Order # | Description | Price | Weight |
|------------|-----------------|--------|--------|
| OMB2043-29 | 29" High desk | 746.00 | 33 |
| OMB2043-33 | 33" High | 746.00 | 39 |
| OMB2043-42 | 42" High | 815.00 | 42 |
| SM1424 | 14" x 24" Shelf | 43.00 | 04 |
| 24D | Door | 184.00 | 12 |
| 24LD | Locking Door | 226.00 | 12 |

* Packs in one UF4825 case at \$330.00 ea

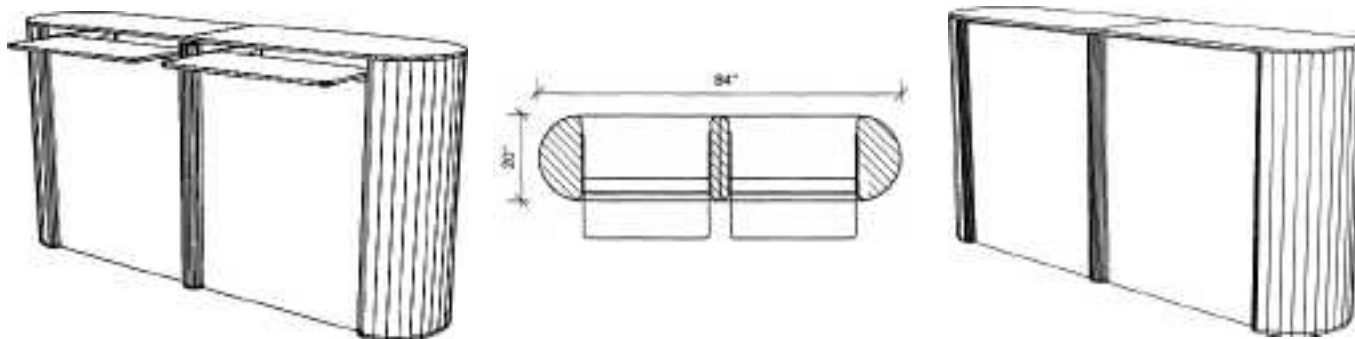

Oval Computer Stand 20" x 84"--open back, 2 sections

| | | | |
|------------|--|----------|----|
| CSO2084-29 | 29" High desk with two inside shelves, two keyboard pullouts | 1,524.00 | 82 |
| CSO2084-42 | 42" High desk with two inside shelves, two keyboard pullouts | 1,633.00 | 94 |
| WM153 | 1.5" x 3" Rectangular wire management grommet , (specify location) | 19.00 | 00 |
| SM1430 | 14" x 30" Shelf | 43.00 | 04 |
| 30D | Door | 184.00 | 13 |
| 30LD | Locking Door | 226.00 | 13 |

* Packs in one UF4325 case and one UF4331 case at \$330.00 ea

Oval Multi-Stand 20" x 84"--open back, 2 sections

| | | | |
|------------|-----------------|----------|----|
| OMB2084-29 | 29" High desk | 1,280.00 | 57 |
| OMB2084-33 | 33" High | 1,280.00 | 65 |
| OMB2084-42 | 42" High | 1,389.00 | 72 |
| SM1430 | 14" x 30" Shelf | 43.00 | 05 |
| 30D | Door | 184.00 | 13 |
| 30LD | Locking Door | 226.00 | 13 |

* Packs in one UF4325 case and one UF4331 case at \$330.00 ea

COMPUTER STANDS

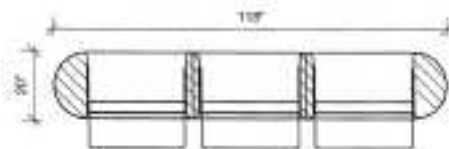

MULTI-STANDS



Oval Computer Stand 20" x 118"--open back, 3 sections

| Order # | Description | Price | Weight |
|-------------|--|----------|--------|
| CSO20118-29 | 29" High desk with three inside shelves, three keyboard pullouts | 2,153.00 | 117 |
| CSO20118-42 | 42" High desk with three inside shelves, three keyboard pullouts | 2,302.00 | 135 |
| WM153 | 1.5" x 3" Rectangular wire management grommet , (specify location) | 19.00 | 00 |
| SM1430 | 14" x 30" Shelf | 43.00 | 05 |
| 30D | Door | 184.00 | 13 |
| 30LD | Locking Door | 226.00 | 13 |

* Packs in three (two UF4825 and one UF4331) cases at \$330.00 ea

Oval Multi-Stand 20" x 118"--open back, 3 sections

| | | | |
|-------------|-----------------|----------|-----|
| OMB20118-29 | 29" High desk | 1,787.00 | 80 |
| OMB20118-33 | 33" High | 1,787.00 | 90 |
| OMB20118-42 | 42" High | 1,936.00 | 101 |
| SM1430 | 14" x 30" Shelf | 43.00 | 05 |
| 30D | Door | 184.00 | 13 |
| 30LD | Locking Door | 226.00 | 13 |

* Packs in three (two UF4825 and one UF4331) cases at \$330.00 ea

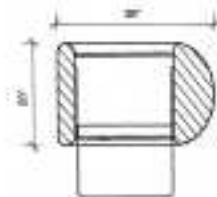

Half Oval Computer stand 20" x 38"

| | | | |
|-------------|---|----------|----|
| CSHO2038-42 | 42" High with 38"high door under keyboard, one inside shelf, one keyboard pullout | 1,121.00 | 60 |
| WM153 | 1.5" x 3" Rectangular wire management grommet , (specify location) | 19.00 | 00 |
| SM1424 | 14" x 24" Shelf | 43.00 | 06 |
| 24LD | Locking Door Upgrade | 42.00 | 00 |

* Packs in one UF4325 case at \$330.00 ea

Half Oval Multi-Stand 20" x 38"--open back

| | | | |
|-------------|-----------------------------|--------|----|
| HOMB2038-33 | 33" High with 33" High door | 930.00 | 44 |
| HOMB2038-42 | 42" High with 42" High door | 999.00 | 51 |
| SM1424 | 14" x 24" Shelf | 43.00 | 05 |
| 24LD | Locking Door Upgrade | 42.00 | 00 |

* Packs in one UF4325 case at \$330.00 ea

COMPUTER STANDS

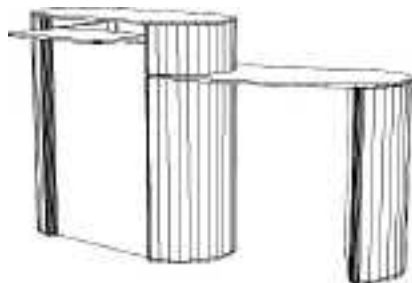

CSY105R

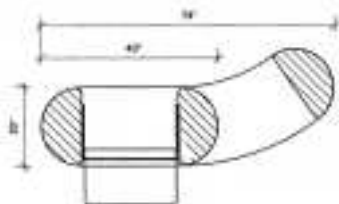

MULTI-STANDS

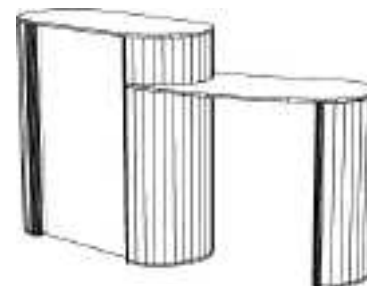

HY105R

Bi-Level Oval Computer Stand 20" x 43" with one curving extension, 2 sections--open back

| Order # | Description | Price | Weight |
|---------|---|----------|--------|
| CSY105R | 42" High with right extension at 33" high, one inside shelf, one keyboard pullout | 1,428.00 | 75 |
| CSY105L | 42" High with left extension at 33" high, one inside shelf, one keyboard pullout | 1,428.00 | 75 |
| WM153 | 1.5" x 3" Rectangular wire management grommet , (specify location) | 19.00 | 00 |
| SM1424 | 14" x 24" Shelf | 43.00 | 05 |
| 24D | Door | 184.00 | 12 |
| 24LD | Locking Door | 226.00 | 12 |

* Packs in one UF4825 case at \$330.00 ea -- additional case required for options

Bi-Level Oval Multi-Stand 20" x 43" with one curving extension, 2 sections--open back

| | | | |
|--------|---|----------|----|
| HY105R | 42" High with right extension at 33" high | 1,306.00 | 66 |
| HY105L | 42" High with left extension at 33" high | 1,306.00 | 66 |
| SM1424 | 14" x 24" Shelf | 43.00 | 05 |
| 24D | Door | 184.00 | 12 |
| 24LD | Locking Door | 226.00 | 12 |

* Packs in one UF4825 case at \$330.00 ea--additional case required for options

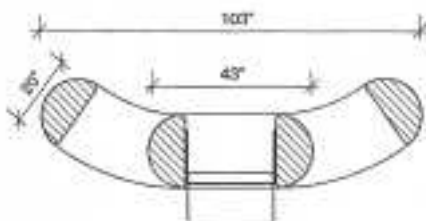
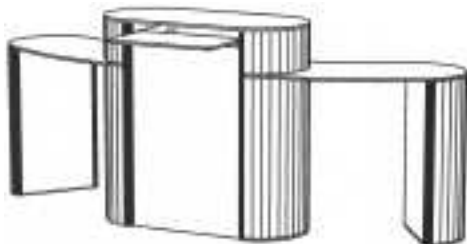

Bi-Level Oval Computer Stand 20" x 43" with two curving extensions, 3 sections--open back

| | | | |
|--------|--|----------|-----|
| CSY104 | 42" High with extensions at 33" high, one inside shelf, one keyboard pullout | 1,919.00 | 100 |
| WM153 | 1.5" x 3" Rectangular wire management grommet , (specify location) | 19.00 | 00 |
| SM1424 | 14" x 24" Shelf | 43.00 | 04 |
| 24D | Door | 184.00 | 12 |
| 24LD | Locking Door | 226.00 | 12 |

* Packs in two UF4825 cases at \$330.00 ea

Continued--SEE NEXT PAGE

COMPUTER STANDS

See previous page for image

Bi-Level Oval Multi-Stand 20" x 43" with two curving extensions, 3 sections--open back

| Order # | Description | Price | Weight |
|---------|--------------------------------------|----------|--------|
| HY104 | 42" High with extensions at 33" high | 1,797.00 | 90 |
| SM1424 | 14" x 24" Shelf | 43.00 | 05 |
| 24D | Door | 184.00 | 12 |
| 24LD | Locking Door | 226.00 | 12 |

* Packs in two UF4825 cases at \$330.00 ea

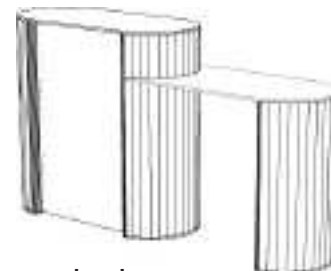
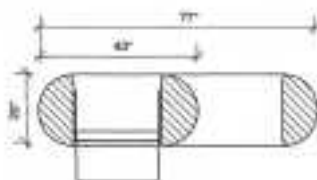
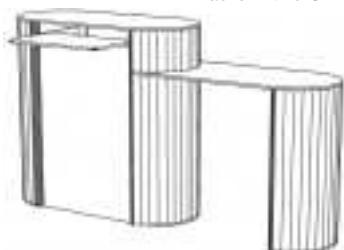

Bi-Level Oval Computer Stand 20" x 43" with one straight extension, 2 sections--open back

| | | | |
|--------|---|----------|----|
| CSY106 | 42" High with extension at 33" high, one inside shelf, one keyboard pullout | 1,428.00 | 75 |
| WM153 | 1.5" x 3" Rectangular wire management grommet , (specify location) | 19.00 | 00 |
| SM1424 | 14" x 24" Shelf | 43.00 | 05 |
| 24D | Door | 184.00 | 12 |
| 24LD | Locking Door | 226.00 | 12 |

* Packs in one UF4825 case at \$330.00 ea-- additional case required for options

Bi-Level Oval Multi-Stand 20" x 43" with one straight extension, 2 sections--open back

| | | | |
|--------|-------------------------------------|----------|----|
| HY106 | 42" High with extension at 33" high | 1,340.00 | 67 |
| SM1424 | 14" x 24" Shelf | 43.00 | 05 |
| 24D | Door | 184.00 | 12 |
| 24LD | Locking Door | 226.00 | 12 |

* Packs in one UF4825 case at \$330.00 ea--additional case required for options

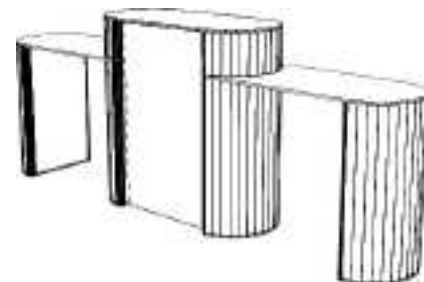
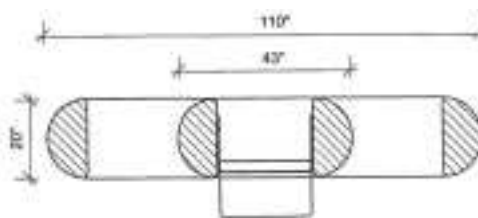
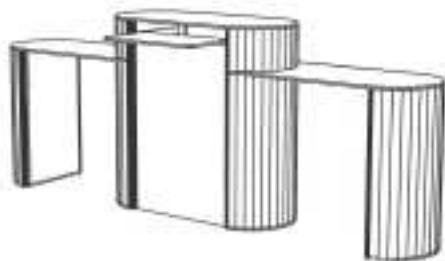

Bi-Level Oval Computer Stand 20" x 43" with two straight extensions, 3 sections--open back

| | | | |
|--------|---|----------|-----|
| CSY107 | 42" High with extension at 33" high, one inside shelf, one keyboard pullout | 1,919.00 | 100 |
| WM153 | 1.5" x 3" Rectangular wire management grommet , (specify location) | 19.00 | 00 |
| SM1424 | 14" x 24" Shelf | 43.00 | 05 |
| 24D | Door | 184.00 | 12 |
| 24LD | Locking Door | 226.00 | 12 |

* Packs in two UF4825 cases at \$330.00 ea

Continued--SEE NEXT PAGE

COMPUTER STANDS

MULTI-STANDS

See previous page for image

Bi-Level Oval Multi-Stand 20" x 43" with two straight extensions, 3 sections--open back

| Order # | Description | Price | Weight |
|---------|--------------------------------------|----------|--------|
| HY107 | 42" High with extensions at 33" high | 1,797.00 | 90 |
| SM1424 | 14" x 24" Shelf | 43.00 | 05 |
| 24D | Door | 184.00 | 12 |
| 24LD | Locking Door | 226.00 | 12 |

* Packs in two UF4825 cases at \$330.00 ea

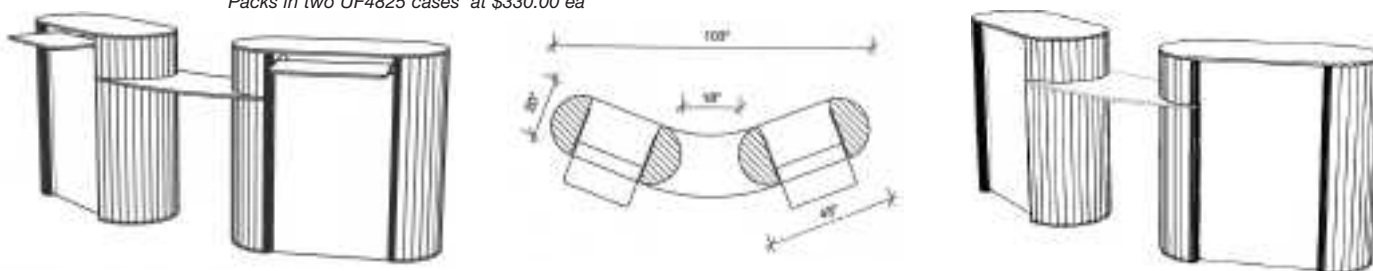

Two Oval Computer Stands 20" x 43" with curving connection, 2 sections--open back

| | | | |
|-----------|---|----------|-----|
| CSY110-42 | 42" High with connecting shelf at 33" high, two inside shelves, two keyboard pullouts | 2,231.00 | 117 |
| WM153 | 1.5" x 3" Rectangular wire management grommet , (specify location) | 19.00 | 00 |
| SM1424 | 14" x 24" Shelf | 43.00 | 05 |
| 24D | Door | 184.00 | 12 |
| 24LD | Locking Door | 226.00 | 12 |

* Packs in two UF4825 cases at \$330.00 ea

Two Oval Multi-Stands 20" x 43" with curving connection, 2 sections--open back

| | | | |
|----------|--|----------|----|
| HY110-42 | 42" High with connecting shelf at 33" high | 1,987.00 | 98 |
| SM1424 | 14" x 24" Shelf | 43.00 | 05 |
| 24D | Door | 184.00 | 12 |
| 24LD | Locking Door | 226.00 | 12 |

* Packs in two UF4825 cases at \$330.00 ea

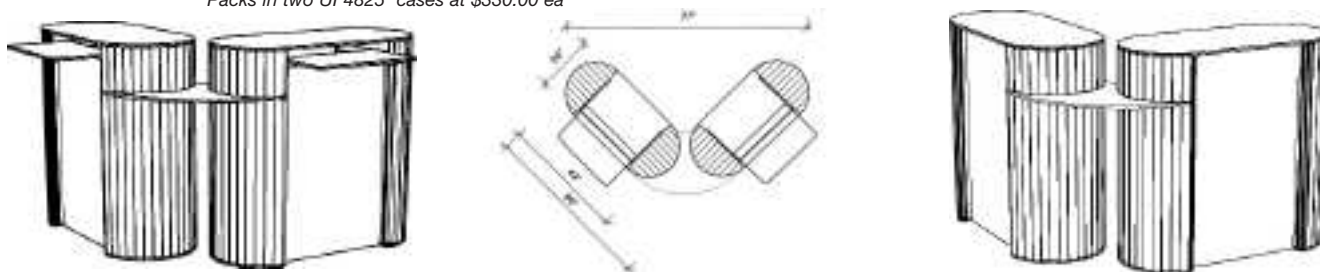

Two Oval Computer Stands 20" x 43" with 90 degree curving connection, 2 sections--open back

| | | | |
|-----------|---|----------|-----|
| CSY110-90 | 42" High with connecting shelf at 33" high, two inside shelves, two keyboard pullouts | 2,231.00 | 116 |
| WM153 | 1.5" x 3" Rectangular wire management grommet , (specify location) | 19.00 | 00 |
| SM1424 | 14" x 24" Shelf | 43.00 | 05 |
| 24D | Door | 184.00 | 12 |
| 24LD | Locking Door | 226.00 | 12 |

* Packs in two UF4825 cases at \$330.00 ea

Continued-SEE NEXT PAGE

COMPUTER STANDS

MULTI-STANDS

(See previous page for image)

Two Oval Multi-Stands 20" x 43" with 90 degree curving connection, 2 sections--open back

| Order # | Description | Price | Weight |
|----------|--|----------|--------|
| HY110-90 | 42" High with connecting shelf at 33" high | 1,987.00 | 97 |
| SM1424 | 14" x 24" Shelf | 43.00 | 05 |
| 24D | Door | 184.00 | 12 |
| 24LD | Locking Door | 226.00 | 12 |

* Packs in two UF4825 cases at \$330.00 ea

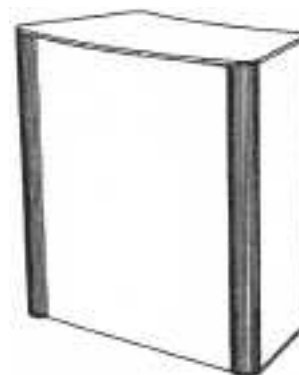
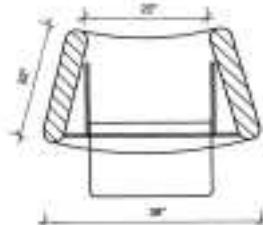

Curving Computer Stand 22" x 38"--open back

| | | | |
|------------|---|--------|----|
| CSC2238-29 | 29" High desk with one inside shelf, one keyboard pullout | 879.00 | 49 |
| CSC2238-42 | 42" High desk with one inside shelf, one keyboard pullout | 937.00 | 59 |
| WM153 | 1.5" x 3" Rectangular wire management grommet, (specify location) | 19.00 | 00 |
| SMC1430 | 14" x 30" Curving Shelf | 43.00 | 04 |
| 22DC | Door | 184.00 | 11 |
| 22LDC | Locking Door | 226.00 | 11 |

* Packs in one UF4331 cases at \$330.00 ea-- additional case required for options

Curving Multi-Stand 22" x 38"--open back

| | | | |
|------------|-------------------------|--------|----|
| MBC2238-29 | 29" High desk | 746.00 | 36 |
| MBC2238-33 | 33" High | 746.00 | 42 |
| MBC2238-42 | 42" High | 815.00 | 45 |
| SMC1430 | 14" x 30" Curving Shelf | 43.00 | 04 |
| 22DC | Door | 184.00 | 11 |
| 22LDC | Locking Door | 226.00 | 11 |

* Packs in one UF4331 case at \$330.00 ea

COMPUTER STANDS

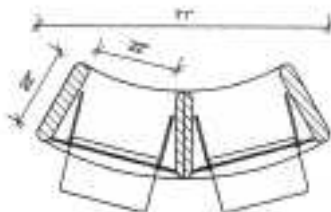
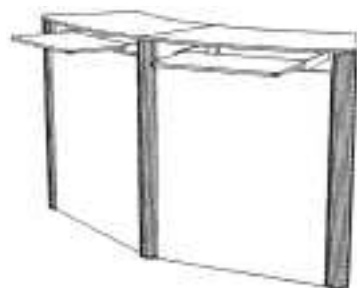

MULTI-STANDS

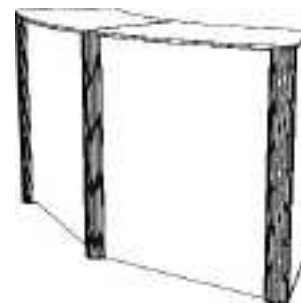

Curving Computer Stand 22" x 71", 2 sections--open back

| Order # | Description | Price | Weight |
|------------|--|----------|--------|
| CSC2271-29 | 29" High desk with two inside shelves, two keyboard pullouts | 1,554.00 | 88 |
| CSC2271-42 | 42" High desk with two inside shelves, two keyboard pullouts | 1,641.00 | 104 |
| WM153 | 1.5" x 3" Rectangular wire management grommet , (specify location) | 19.00 | 00 |
| SMC1430 | 14" x 30" Curving Shelf | 43.00 | 04 |
| 22DC | Door | 184.00 | 11 |
| 22LDC | Locking Door | 226.00 | 11 |

* Packs in two UF4331 cases at \$330.00 ea

Curving Multi-Stand 22" x 71", 2 sections--open back

| | | | |
|------------|-------------------------|----------|----|
| MBC2271-29 | 29" High desk | 1,288.00 | 60 |
| MBC2271-33 | 33" High | 1,288.00 | 70 |
| MBC2271-42 | 42" High | 1,397.00 | 75 |
| SMC1430 | 14" x 30" Curving Shelf | 43.00 | 04 |
| 22DC | Door | 184.00 | 11 |
| 22LDC | Locking Door | 226.00 | 11 |

* Packs in two UF4331 cases at \$330.00 ea

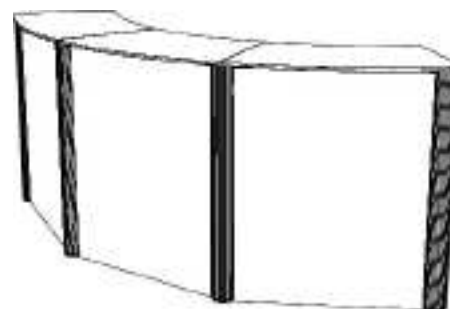
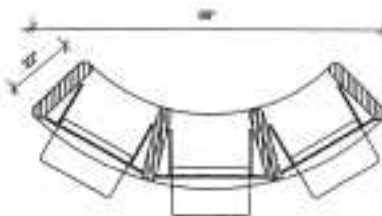

Curving Computer Stand 22" x 99", 3 sections--open back

| | | | |
|------------|--|----------|-----|
| CSC2299-29 | 29" High desk with three inside shelves, three keyboard pullouts | 2,198.00 | 125 |
| CSC2299-42 | 42" High desk with three inside shelves, three keyboard pullouts | 2,314.00 | 148 |
| WM153 | 1.5" x 3" Rectangular wire management grommet , (specify location) | 19.00 | 00 |
| SMC1430 | 14" x 30" Curving Shelf | 43.00 | 04 |
| 22DC | Door | 184.00 | 11 |
| 22LDC | Locking Door | 226.00 | 11 |

* Packs in three UF4331 cases at \$330.00 ea

COMPUTER STANDS

MULTI-STANDS

Curving Multi-Stand 22" x 99", 3 sections--open back (See previous page for image)

| Order # | Description | Price | Weight |
|------------|-------------------------|----------|--------|
| MBC2299-29 | 29" High desk | 1,799.00 | 84 |
| MBC2299-33 | 33" High | 1,799.00 | 98 |
| MBC2299-42 | 42" High | 1,948.00 | 105 |
| SMC1430 | 14" x 30" Curving Shelf | 43.00 | 04 |
| 22DC | Door | 184.00 | 11 |
| 22LDC | Locking Door | 226.00 | 11 |

* Packs in three UF4331 cases at \$330.00 ea

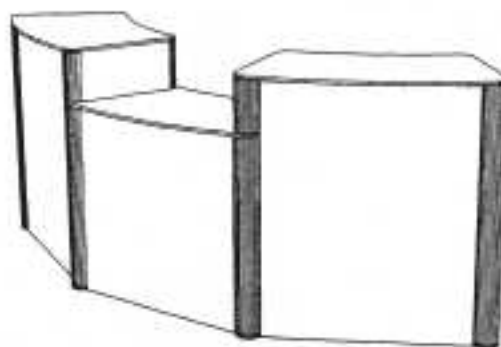
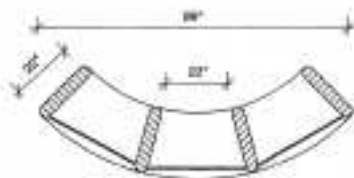

Bi-Level Curving Multi-Stand 20" x 99", 3 sections--open back

| | | | |
|---------|---------------------------------------|----------|-----|
| HY123 | 42" High with 33" High center section | 2,109.00 | 116 |
| SMC1430 | 14" x 30" Curving Shelf | 43.00 | 05 |
| 22DC | Door | 184.00 | 11 |
| 22LDC | Locking Door | 226.00 | 11 |

* Packs in three UF4331 cases at \$330.00 ea

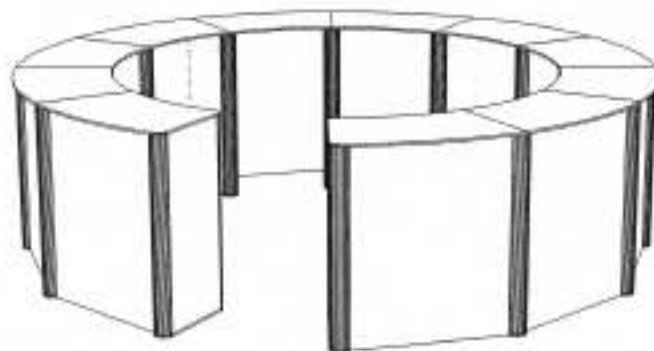
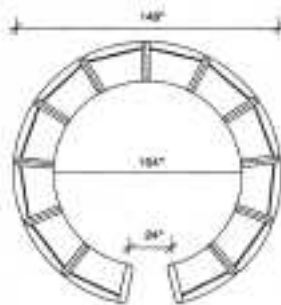

Curving Multi-Stand 20" x 148", 12 sections--open back

| | | | |
|-------------|-------------------------|----------|-----|
| MBC22148-42 | 42" High | 6,907.00 | 374 |
| SMC1430 | 14" x 30" Curving Shelf | 41.00 | 05 |
| 22DC | Door | 184.00 | 11 |
| 22LDC | Locking Door | 226.00 | 11 |

* Packs in one UF4848 jumbo case (check page C-1 for prices on Jumbo case)--additional case required for options

MULTI-STANDS

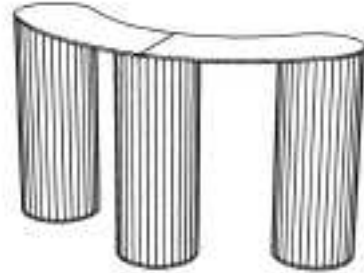
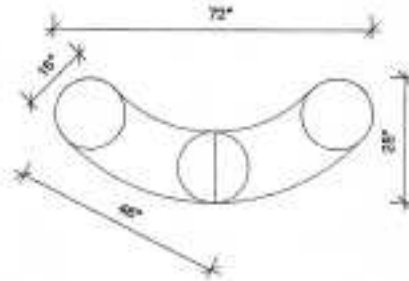

Continuous Counter 16" x 72" curving top

| Order # | Description | Price | Weight |
|---------|-------------|----------|--------|
| CC2-24 | 24" High | 946.00 | 43 |
| CC2-33 | 33" High | 1,030.00 | 51 |
| CC2-42 | 42" High | 1,117.00 | 52 |

* Packs in one UF4825 case at \$330.00 ea

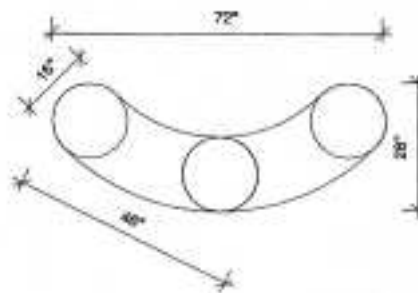

Bi-Level Continuous Counter 16" x 72" curving top

| | | | |
|-----|-----------------------|----------|----|
| CC4 | 42" High and 33" High | 1,174.00 | 57 |
|-----|-----------------------|----------|----|

* Packs in one UF4825 case at \$330.00 ea

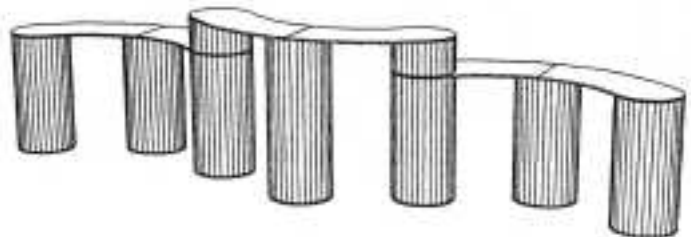
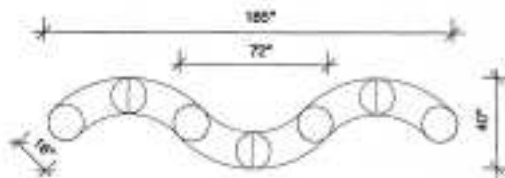

Bi-Level Continuous Counter 16" x 185" curving top

| | | | |
|-----|-----------------------|----------|-----|
| CC7 | 42" High and 33" High | 2,909.00 | 138 |
|-----|-----------------------|----------|-----|

* Packs in three UF4825 cases at \$330.00 ea

COMPUTER CABINETS

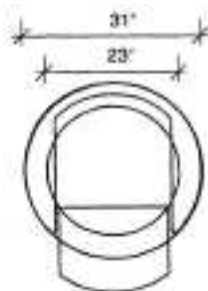
CCR31

Round 31" Computer Cabinet on 31" round base

| Order # | Description | Price | Weight |
|---------|---|----------|--------|
| CCR31 | 37" High | 1,061.00 | 53 |
| CCR31D | 37" High with locking door in base | 1,368.00 | 70 |
| SR31K | 31" Round shelf kit, with poles & collars | 89.00 | 08 |

* Packs in one UF4331 case at \$330.00 ea. *WM153- wire management, (specify location) \$19.00

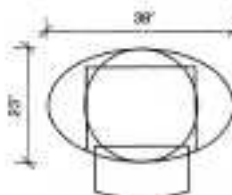
CCE2338

Ellipse Computer Cabinet on ellipse base

| | | | |
|----------|---|----------|----|
| CCE2338 | 37" High | 1,072.00 | 54 |
| CCE2338D | 37" High with locking door in base | 1,368.00 | 70 |
| SE2338K | 23" x 38" Ellipse shelf kit, with poles & collars | 89.00 | 08 |

* Packs in one UF4325 case at \$330.00 ea * WM153- wire management, (specify location) \$19.00

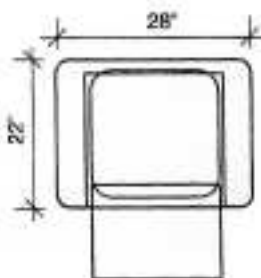
CC2228

Rectangular 22" x 28" Computer Cabinet on rectangle base

| | | | |
|---------|---|----------|----|
| CC2228 | 37" High | 1,058.00 | 53 |
| CC2228D | 37" High with locking door in base | 1,368.00 | 67 |
| S2228K | 22" x 28" Rectangle shelf kit, with poles & collars | 89.00 | 07 |

* Packs in one UF4325 case at \$330.00 ea * WM153- wire management, (specify location) \$19.00

COMPUTER PEDESTALS



Round 31" Computer Pedestal on 23" round base

| Order # | Description | Price | Weight |
|---------|-------------|----------|--------|
| CPR31 | 38" High | 1,005.00 | 47 |

* Packs in one UF4331 case at \$330.00 ea

* WM153- wire management, (specify location) \$19.00



Round 23" Computer Pedestal with Monitor Riser

| | | | |
|--------------|---|--------|----|
| CPR23-36-6AR | 36" High with 6" High Riser | 634.00 | 35 |
| CPR23-36 | 36" High | 498.00 | 29 |
| AR-R16-6 | Aluminum Riser Pole Kit 16" Round 6" High | 146.00 | 04 |
| SR23K | Shelf Kit, 23" Round with Poles & Collars | 89.00 | 07 |

* Packs in one UF4325 case at \$330.00 ea

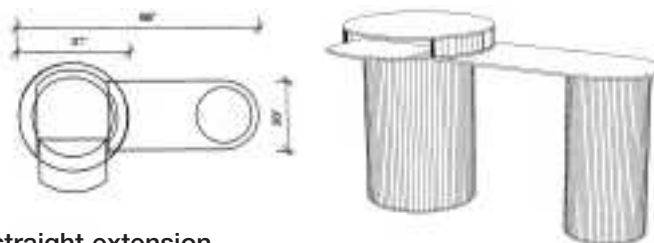

Round 31" Computer Pedestal on 23" round base with straight extension

| | | | |
|------------|---|----------|----|
| CPR31-XS | 38" High with straight extension at 33" high | 1,398.00 | 68 |
| CPR31-XSRL | 38" High with two straight extensions at 33" high | 1,791.00 | 90 |

* Packs in two (one UF4325 case and one UF4331 case) cases at \$330.00 ea

* WM153- wire management, (specify location) \$19.00

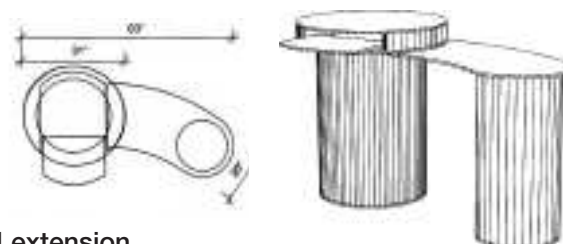

Round 31" Computer Pedestal on 23" round base with curved extension

| | | | |
|------------|--|----------|----|
| CPR31-XCR | 38" High with right curved extension at 33" high | 1,398.00 | 68 |
| CPR31-XCL | 38" High with left curved extension at 33" high | 1,398.00 | 68 |
| CPR31-XCRL | 38" High with two curved extensions at 33" high | 1,791.00 | 90 |

* Packs in two (one UF4825 case and one UF4331 case) cases at \$330.00 ea *WM153- wire management, (specify location) \$19.00

COMPUTER PEDESTALS

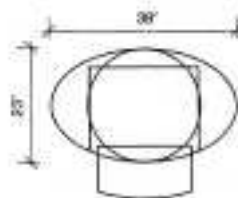

CPE2338

Ellipse Computer Pedestal on 23" round base

| Order # | Description | Price | Weight |
|---------|-------------|----------|--------|
| CPE2338 | 38" High | 1,005.00 | 47 |

* Packs in one UF4325 case at \$330.00 ea * WM153- wire management, (specify location) \$19.00

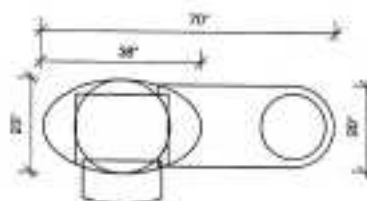

CPE2338-XS

Ellipse Computer Pedestal on 23" round base with straight extension

| | | | |
|--------------|---|----------|----|
| CPE2338-XS | 38" High with straight extension at 33" high | 1,398.00 | 69 |
| CPE2338-XSRL | 38" High with two straight extensions at 33" high | 1,791.00 | 90 |

* Packs in two (one UF4825 case and one UF4325 case) cases at \$330.00 ea * WM153- wire management, (specify location) \$19.00

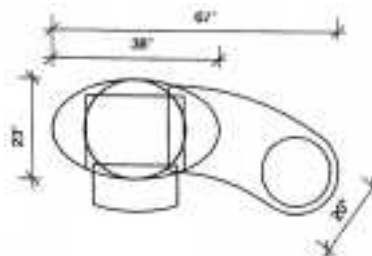

CPE2338-XCR

Ellipse Computer Pedestal on 23" round base with curving extension

| | | | |
|--------------|--|----------|----|
| CPE2338-XCR | 38" High with right curved extension at 33" high | 1,398.00 | 69 |
| CPE2338-XCL | 38" High with left curved extension at 33" high | 1,398.00 | 69 |
| CPE2338-XCRL | 38" High with two curved extensions at 33" high | 1,791.00 | 90 |

* Packs in two (one UF4825 case and one UF4325 case) cases at \$330.00 ea * WM153- wire management, (specify location) \$19.00

COMPUTER PEDESTALS

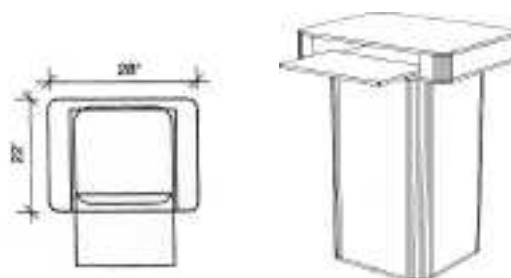
CP2228

Rectangular 22" x 28" Computer Pedestal on 19" x 19" square base

| Order # | Description | Price | Weight |
|---------|-------------|----------|--------|
| CP2228 | 38" High | 1,005.00 | 46 |

* Packs in one UF4325 case at \$330.00 ea * WM153- wire management, (specify location) \$19.00

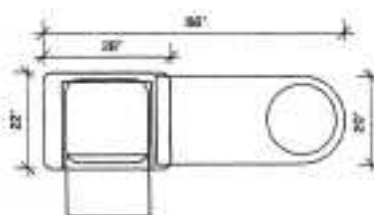
CP2228-XS

Rectangle 22" x 28" Computer Pedestal on 19" square base with straight extension

| | | | |
|-------------|---|----------|----|
| CP2228-XS | 38" High with straight extension at 33" high | 1,398.00 | 67 |
| CP2228-XSRL | 38" High with two straight extensions at 33" high | 1,791.00 | 89 |

* Packs in two (one UF4825 case and one UF4325) cases at \$330.00 ea * WM153- wire management, (specify location) \$19.00

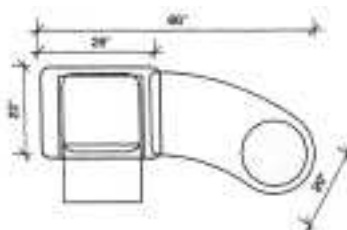
CP2228-XCR

Rectangle 22" x 28" Computer Pedestal on 19" square base with curved extension.

| | | | |
|-------------|--|----------|----|
| CP2228-XCR | 38" High with right curved extension at 33" high | 1,398.00 | 67 |
| CP2228-XCL | 38" High with left curved extension at 33" high | 1,398.00 | 67 |
| CP2228-XCRL | 38" High with two curved extensions at 33" high | 1,791.00 | 89 |

* Packs in two (one UF4825 case and one UF4325) cases at \$330.00 ea * WM153- wire management, (specify location) \$19.00p

TOWERS

Oval 22" x 47"

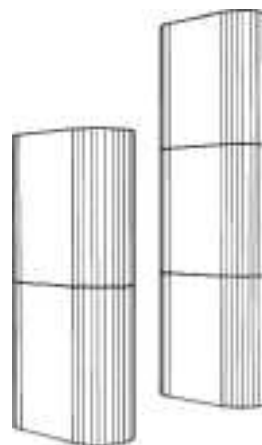
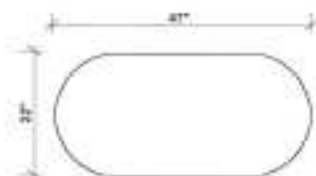

| Order # | Description | Price | Weight |
|-----------|-------------|----------|--------|
| O2247-144 | 12' High | 2,438.00 | 122 |
| O2247-96 | 8' High | 1,637.00 | 84 |

* 12' tower packs in two UF4825 cases at \$330.00 ea; 8' tower packs in one UF4825 case at \$330.00 ea

Ellipse 28" x 47"

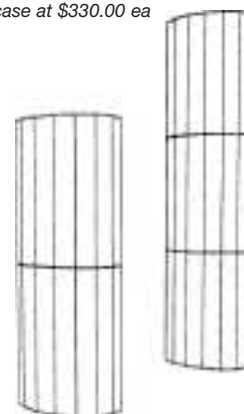
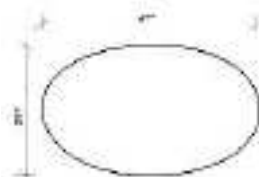

| | | | |
|-----------|----------|----------|-----|
| E2847-144 | 12' High | 2,518.00 | 131 |
| E2847-96 | 8' High | 1,677.00 | 88 |

* Each tower packs in two UF4831 cases at \$330.00 ea

Round 31"

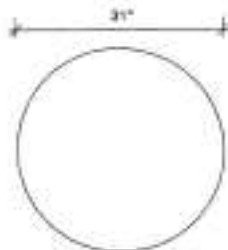

| | | | |
|---------|----------|----------|----|
| R31-144 | 12' High | 1,958.00 | 92 |
| R31-96 | 8' High | 1,317.00 | 63 |

* Each tower packs in two UF4831 cases at \$330.00 ea

TOWERS



Round 38"

| Order # | Description | Price | Weight |
|----------|-------------|----------|--------|
| R38-144J | 12' High | 2,518.00 | 133 |
| R38-96J | 8' High | 1,677.00 | 90 |

* This tower will only pack in the UF4848 jumbo case (check page C-1 for prices on Jumbo cases)

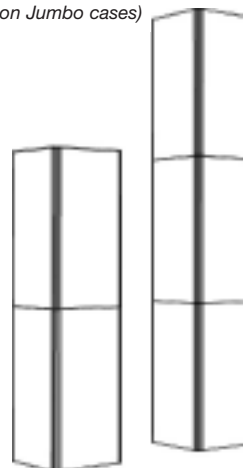
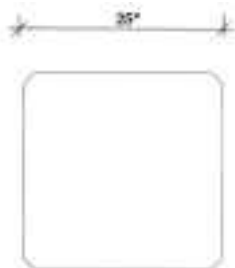

Square 25" x 25"

| | | | |
|----------|----------|----------|----|
| 2525-144 | 12' High | 1,948.00 | 94 |
| 2525-96 | 8' High | 1,310.00 | 65 |

* Each tower packs in two UF4831 cases at \$330.00 ea

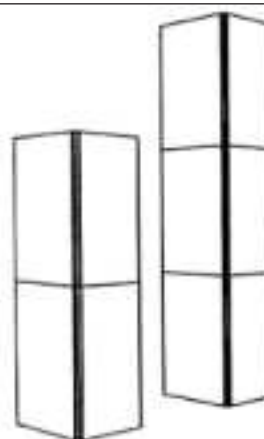
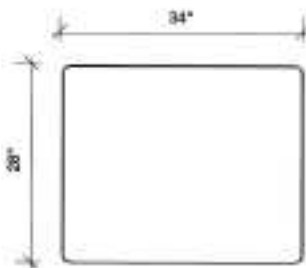

Rectangle 28" x 34"

| | | | |
|----------|----------|----------|-----|
| 2834-144 | 12' High | 2,518.00 | 131 |
| 2834-96 | 8' High | 1,677.00 | 88 |

* Each tower packs in two UF4831 cases at \$330.00 ea

TOWERS

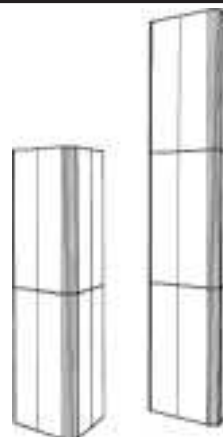
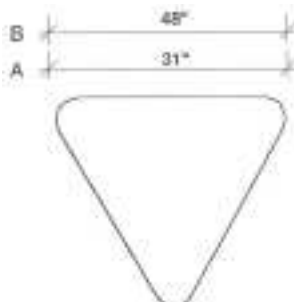

Triangle 31" Dimensions A

| Order # | Description | Price | Weight |
|---------|-------------|----------|--------|
| T31-144 | 12' High | 1,948.00 | 91 |
| T31-96 | 8' High | 1,307.00 | 62 |

* Each tower packs in two UF4831 cases at \$330.00 ea

Triangle 48" Dimensions B

| | | | |
|----------|----------|----------|-----|
| T48-144J | 12' High | 2,921.00 | 145 |
| T48-96J | 8' High | 1,952.00 | 97 |

* This tower will only pack in the UF4848 jumbo case (check page C-1 for prices on Jumbo cases)

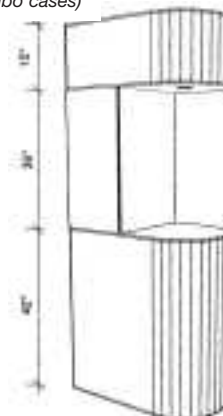
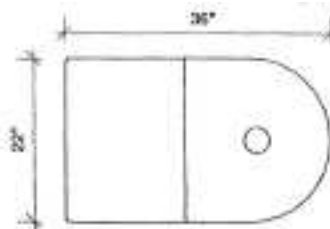

Half Oval 22" x 36"

| | | | |
|-------------|---|----------|----|
| PDHO2236-93 | 7'9" High, includes one 60 watt recessed spotlight | 1,607.00 | 79 |
| SHO2236K | 22" x 36" Half oval shelf kit, with poles & collars | 89.00 | 07 |

* This tower packs in two UF4325 cases at \$330.00 ea

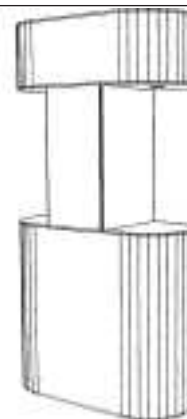
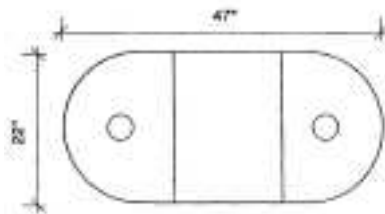

Oval 22" x 47"

| | | | |
|------------|---|----------|----|
| PDO2247-93 | 7'9" High, includes two 60 watt recessed spotlights | 1,985.00 | 93 |
|------------|---|----------|----|

* This tower packs in two UF4825 cases at \$330.00 ea

TOWERS

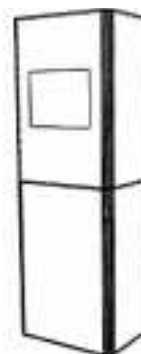
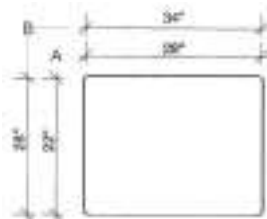

M2228-84

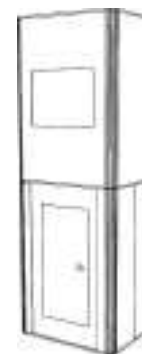

M2228-84D

Rectangle Monitor Tower 22" x 28" *Dimensions A*

| Order # | Description | Price | Weight |
|----------|---|----------|--------|
| M2228-84 | 7' High, includes custom monitor opening and inside shelf | 1,325.00 | 73 |

** Tower packs in one UF4325 case at \$330.00 ea*

Rectangle Monitor Tower 28" x 34" *Dimensions B*

| | | | |
|----------|---|----------|-----|
| M2834-96 | 8' High, includes custom monitor opening and inside shelf | 1,777.00 | 102 |
|----------|---|----------|-----|

** Tower packs in two UF4831 cases at \$330.00 ea*

Rectangle Monitor Tower 22" x 28" with locking door *Dimensions A*

| | | | |
|-----------|---|----------|----|
| M2228-84D | 7' High, with locking door, custom monitor opening and inside shelf | 1,673.00 | 89 |
|-----------|---|----------|----|

** Tower packs in two UF4325 cases at \$330.00 ea*

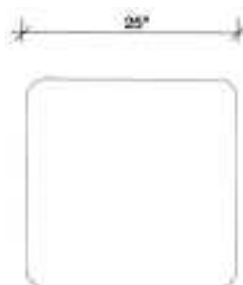

Square Monitor Tower 25" x 25"

| | | | |
|----------|---|----------|----|
| M2525-84 | 7' High, includes custom monitor opening and inside shelf | 1,325.00 | 72 |
|----------|---|----------|----|

** Tower packs in two UF4331 cases at \$330.00 ea*

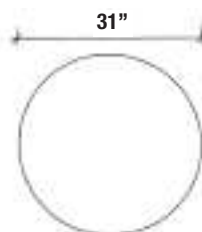

Round Monitor Tower 31"

| | | | |
|---------|--|----------|----|
| MR31-84 | 7' High, includes monitor opening and inside shelf | 1,345.00 | 73 |
|---------|--|----------|----|

** Tower packs in two UF4331 cases at \$330.00 ea*

TOWERS



Elliptical Monitor Tower 23" x 38" or 28" x 47"

| Order # | Description | Price | Weight |
|-----------|--|----------|--------|
| ME2338-84 | 7' High, includes custom monitor opening and inside shelf (Dimensions A) | 1,350.00 | 74 |
| ME2847-96 | 8' High, includes custom monitor opening and inside shelf (Dimensions B) | 1,790.00 | 102 |

* 7' Tower packs in one UF4325 case at \$330.00 ea
* 8' Tower packs in two UF4831 cases at \$330.00 ea

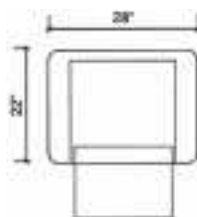

MCC2228-82



MCC2228-82D

Rectangle Computer Monitor Tower 22" x 28"

| | | | |
|------------|--|----------|----|
| MCC2228-82 | 6'10" High, includes custom monitor opening, inside shelf and keyboard pullout | 1,779.00 | 91 |
|------------|--|----------|----|

* Tower packs in two UF4325 cases at \$330.00 ea

Rectangle Computer Monitor Tower 22" x 28" with locking door

| | | | |
|-------------|--|----------|-----|
| MCC2228-82D | 6'10" High, with locking door, custom monitor opening, inside shelf and keyboard pullout | 2,089.00 | 106 |
|-------------|--|----------|-----|

* Tower packs in two UF4325 cases at \$330.00 ea

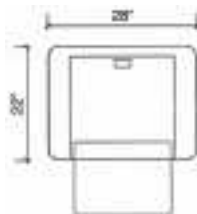

MCC2228-64



MCC2228-64D

Rectangular Computer Monitor Stand 22" x 28"

| | | | |
|------------|---|----------|----|
| MCC2228-64 | 5'4" High, includes keyboard pullout, 1.5" x 3" rectangular wire management grommet | 1,601.00 | 83 |
|------------|---|----------|----|

* Tower packs in two UF4325 cases at \$330.00 ea

Rectangular Computer Monitor Stand 22" x 28" with locking door

| | | | |
|-------------|---|----------|----|
| MCC2228-64D | 5'4" High, with locking door, keyboard pullout, 1.5" x 3" rectangular grommet | 1,911.00 | 98 |
|-------------|---|----------|----|

* Tower packs in two UF4325 cases at \$330.00 ea

TOWERS

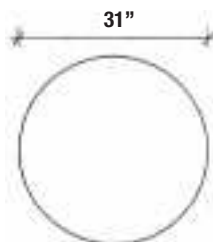

MCCR31-82



MCCR31-64

Round Computer Monitor Tower 31"

| Order # | Description | Price | Weight |
|---|--|----------|--------|
| MCCR31-82 | 6'10" High, includes custom monitor opening, inside shelf and keyboard pullout | 1,791.00 | 92 |
| <i>* Tower packs in two UF4331 cases at \$330.00 ea</i> | | | |

Round Computer Monitor Stand 31"

| | | | |
|---|---|----------|----|
| MCCR31-64 | 5'4" High, includes keyboard pullout, and 1.5" x 3" wire management grommet | 1,614.00 | 83 |
| <i>* Tower packs in two UF4331 cases at \$330.00 ea</i> | | | |

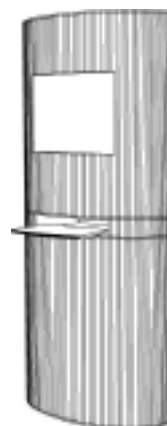
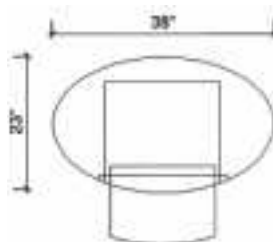

MCCE2338-82



MCCE2338-64

Elliptical Computer Monitor Tower 23" x 38"

| | | | |
|---|--|----------|----|
| MCCE2338-82 | 6'10" High, includes custom monitor opening, inside shelf and keyboard pullout | 1,807.00 | 93 |
| <i>* Tower packs in two UF4325 cases at \$330.00 ea</i> | | | |

Elliptical Computer Monitor Stand 23" x 38"

| | | | |
|---|---|----------|----|
| MCCE2338-64 | 5'4" High, includes keyboard pullout, and 1.5" x 3" rectangular wire management grommet | 1,636.00 | 84 |
| <i>* Tower packs in two UF4325 cases at \$330.00 ea</i> | | | |

COMPUTER

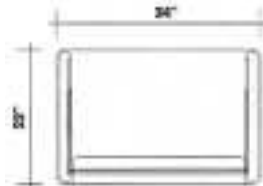

STANDARD



Rectangular Computer Cabinet 22" x 34"--open back

| Order # | Description | Price | Weight |
|------------|--|----------|--------|
| EPCS341-43 | 43" High | 1,047.00 | 58 |
| WM153 | Wire management grommet, 1.5" x 3" rectangular, (specify location) | 19.00 | 00 |
| SM1430 | 14" x 30" Shelf | 43.00 | 05 |
| 30LD | Locking Door | 226.00 | 13 |

* Packs in two (one UF4331 case and one UF4325 case) cases at \$330.00 ea--additional case may be required for options

Rectangular Cabinet 22" x 34"--open back

| | | | |
|----------|-----------------|--------|----|
| EP341-29 | 29" High | 876.00 | 35 |
| EP341-36 | 36" High | 887.00 | 40 |
| EP341-43 | 43" High | 931.00 | 47 |
| SM1430 | 14" x 30" Shelf | 43.00 | 05 |
| 30LD | Locking Door | 226.00 | 13 |

* Packs in one UF4331 case at \$330.00 ea

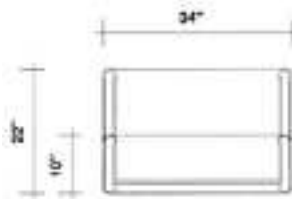

Rectangular Cabinet 22" x 34" with riser--open back

| | | | |
|-------------|-----------------------------------|----------|----|
| EP341-29-14 | 29" High with 14" riser--43" high | 1,588.00 | 60 |
| EP341-36-7 | 36" High with 7" riser--43" high | 1,599.00 | 53 |
| SM1430 | 14" x 30" Shelf | 43.00 | 05 |
| 30LD | Locking Door | 226.00 | 13 |

* Packs in two (one UF4331 case and one UF4325 case) cases at \$330.00 ea--additional case may be required for options

COMPUTER

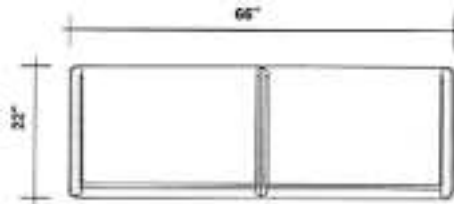

STANDARD



Rectangular Computer Cabinet 22" x 66", 2 sections--open back

| Order # | Description | Price | Weight |
|------------|--|----------|--------|
| EPCS662-43 | 43" High with two inside shelves, two keyboard pullouts | 1,807.00 | 101 |
| WM153 | Wire management grommet, 1.5" x 3" rectangular, (specify location) | 19.00 | 00 |
| SM1430 | 14" x 30" Shelf | 43.00 | 05 |
| 30LD | Locking Door | 226.00 | 13 |

* Packs in two (one UF4331 case and one UF4325 case) cases at \$330.00 ea--additional case may be required for options

Rectangular Cabinet 22" x 66", 2 sections--open back

| | | | |
|----------|-----------------|----------|----|
| EP662-29 | 29" High | 1,487.00 | 60 |
| EP662-36 | 36" High | 1,510.00 | 68 |
| EP662-43 | 43" High | 1,576.00 | 79 |
| SM1430 | 14" x 30" Shelf | 43.00 | 05 |
| 30LD | Locking Door | 226.00 | 13 |

* Packs in two (one UF4331 case and one UF4325 case) cases at \$330.00 ea--additional case may be required for options

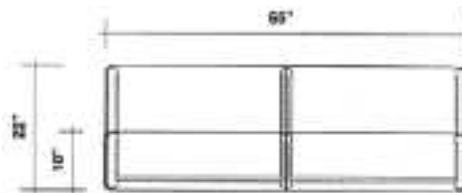

Rectangular Cabinet 22" x 66" with riser, 2 sections--open back

| | | | |
|-------------|-----------------------------------|----------|-----|
| EP662-29-14 | 29" High with 14" riser--43" high | 2,711.00 | 100 |
| EP662-36-7 | 36" High with 7" riser--43" high | 2,734.00 | 91 |
| SM1430 | 14" x 30" Shelf | 43.00 | 05 |
| 30LD | Locking Door | 226.00 | 13 |

* Packs in three (one UF4331 case and two UF4325 cases) cases at \$330.00 ea--additional case may be required for options

COMPUTER

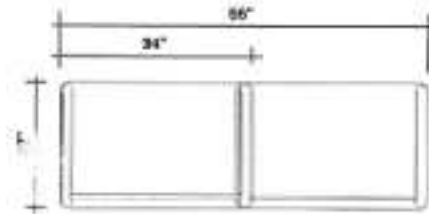

STANDARD



Rectangular Computer Multi-Level Cabinet 22" x 66" with two brace panels, 2 sections--open back

| Order # | Description | Price | Weight |
|----------|--|----------|--------|
| EPCSM662 | 43" High with one inside shelf, one keyboard pullout | 1,846.00 | 92 |
| WM153 | Wire management grommet, 1.5" x 3" rectangular, (specify location) | 19.00 | 00 |
| SM1430 | 14" x 30" Shelf | 43.00 | 05 |
| 30LD | Locking Door | 226.00 | 13 |

* Packs in three (one UF4331 case and two UF4325 cases) cases at \$330.00 ea--additional case may be required for options

Rectangular Multi-Level Cabinet 22" x 66", 2 sections--open back

| | | | |
|--------|--|----------|----|
| EPM662 | 43" High with straight extension at 36" high | 1,742.00 | 81 |
| SM1430 | 14" x 30" Shelf | 43.00 | 05 |
| 30LD | Locking Door | 226.00 | 13 |

* Packs in two (one UF4331 case and one UF4325 case) cases at \$330.00 ea--additional case may be required for options

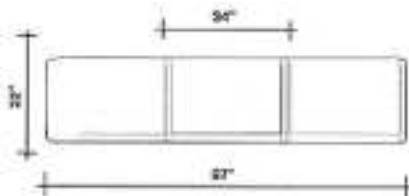

Rectangular Computer Multi-Level Cabinet 22" x 97" with three brace panels, 3 sections--open back

| | | | |
|----------|--|----------|-----|
| EPCSM973 | 43" High with one inside shelf, one keyboard pullout | 2,645.00 | 125 |
| WM153 | Wire management grommet, 1.5" x 3" rectangular, (specify location) | 19.00 | 00 |
| SM1430 | 14" x 30" Shelf | 43.00 | 05 |
| 30LD | Locking Door | 226.00 | 13 |

* Packs in three (one UF4331 case and two UF4325 cases) cases at \$330.00 ea--additional case may be required for options

Rectangular Multi-Level Cabinet 22" x 97", 3 sections--open back

| | | | |
|--------|--|----------|-----|
| EPM973 | 43" High with two extensions at 36" high | 2,553.00 | 115 |
| SM1430 | 14" x 30" Shelf | 43.00 | 05 |
| 30LD | Locking Door | 226.00 | 13 |

* Packs in three (one UF4331 case and two UF4325 cases) cases at \$330.00 ea--additional case may be required for options

COMPUTER

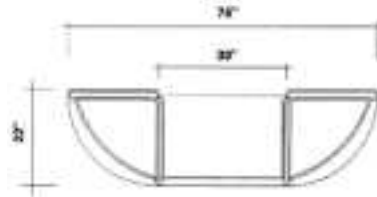

STANDARD



Rectangular Computer Cabinet 22" x 76" with 90 degree ends--open back

| Order # | Description | Price | Weight |
|------------|--|----------|--------|
| EPCS761-43 | 43" High with one inside shelf, one keyboard pullout | 2,431.00 | 125 |
| WM153 | Wire management grommet, 1.5" x 3" rectangular, (specify location) | 19.00 | 00 |
| SM1430 | 14" x 30" Shelf | 43.00 | 05 |
| 30LD | Locking Door | 226.00 | 13 |

* Packs in three (one UF4331 case and two UF4325 cases) cases at \$330.00 ea--additional case may be required for options

Rectangular Cabinet 22" x 76" with 90 degree ends--open back

| | | | |
|----------|-----------------|----------|-----|
| EP761-29 | 29" High | 2,169.00 | 86 |
| EP761-36 | 36" High | 2,202.00 | 98 |
| EP761-43 | 43" High | 2,315.00 | 113 |
| SM1430 | 14" x 30" Shelf | 43.00 | 05 |
| 30LD | Locking Door | 226.00 | 13 |

* Packs in three (one UF4331 case and two UF4325 cases) cases at \$330.00 ea--additional case may be required for options

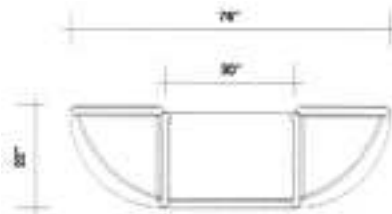

Rectangular Computer Multi-Level Cabinet 22" x 76" with 90 degree ends--open back

| | | | |
|----------|--|----------|-----|
| EPCSM761 | 43" High with ends at 36" high, one inside shelf, one keyboard pullout | 2,748.00 | 129 |
| WM153 | Wire management grommet, 1.5" x 3" rectangular, (specify location) | 19.00 | 00 |
| SM1430 | 14" x 30" Shelf | 43.00 | 05 |
| 30LD | Locking Door | 226.00 | 13 |

* Packs in three (one UF4331 case and two UF4325 cases) cases at \$330.00 ea--additional case may be required for options

Rectangular Multi-Level Cabinet 22" x 76" with 90 degree ends--open back

| | | | |
|--------|--------------------------------|----------|-----|
| EPM761 | 43" High with ends at 36" high | 2,632.00 | 117 |
| SM1430 | 14" x 30" Shelf | 43.00 | 05 |
| 30LD | Locking Door | 226.00 | 13 |

* Packs in three (one UF4331 case and two UF4325 cases) cases at \$330.00 ea--additional case may be required for options

COMPUTER

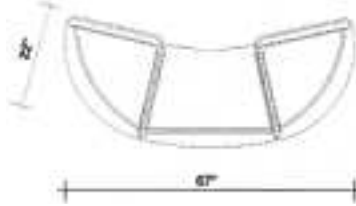

STANDARD



Curving Computer Cabinet 22" x 67" with 90 degree ends--open back

| Order # | Description | Price | Weight |
|-------------|--|----------|--------|
| EPCSY150-43 | 43" High with one inside shelf, one keyboard pullout | 2,431.00 | 128 |
| WM153 | Wire management grommet, 1.5" x 3" rectangular, (specify location) | 19.00 | 00 |
| SMC1430 | 14" x 30" Curving shelf | 43.00 | 05 |
| 22LDC | Locking Door | 226.00 | 13 |

* Packs in three (one UF4331 case and two UF4325 cases) cases at \$330.00 ea--additional case may be required for options

Curving Cabinet 22" x 67" with 90 degree ends--open back

| | | | |
|-----------|-------------------------|----------|-----|
| EPY150-29 | 29" High | 2,169.00 | 86 |
| EPY150-36 | 36" High | 2,202.00 | 98 |
| EPY150-43 | 43" High | 2,315.00 | 113 |
| SMC1430 | 14" x 30" Curving shelf | 43.00 | 05 |
| 22LDC | Locking Door | 226.00 | 12 |

* Packs in three (one UF4331 case and two UF4325 cases) cases at \$330.00 ea--additional case may be required for options

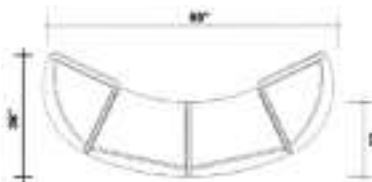

Curving Computer Cabinet 22" x 89" with 90 degree ends, 2 sections--open back

| | | | |
|-------------|---|----------|-----|
| EPCSY160-43 | 43" High with extension at 36" high, one inside shelf, one keyboard pullout | 3,180.00 | 174 |
| WM153 | Wire management grommet, 1.5" x 3" rectangular, (specify location) | 19.00 | 00 |
| SMC1430 | 14" x 30" Curving shelf | 43.00 | 05 |
| 22LDC | Locking Door | 226.00 | 13 |

* Packs in four (one UF4331 case and three UF4325 cases) cases at \$330.00 ea--additional case may be required for options

Curving Cabinet 22" x 89" with 90 degree ends, 2 sections--open back

| | | | |
|-----------|-------------------------|----------|-----|
| EPY160-36 | 36" High | 2,814.00 | 126 |
| EPY160-43 | 43" High | 2,949.00 | 145 |
| SMC1430 | 14" x 30" Curving shelf | 43.00 | 05 |
| 22LDC | Locking Door | 226.00 | 12 |

* Packs in three (one UF4331 case and two UF4325 cases) cases at \$330.00 ea--additional case may be required for options

COMPUTER

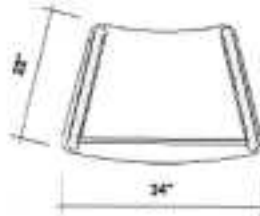

STANDARD



Rectangular Curving Computer Cabinet 22" x 34"--open back

| Order # | Description | Price | Weight |
|-------------|--|----------|--------|
| EPCSC341-43 | 43" High with one inside shelf, one keyboard pullout | 1,047.00 | 58 |
| WM153 | Wire management grommet, 1.5" x 3" rectangular, (specify location) | 19.00 | 00 |
| SMC1430 | 14" x 30" Curving shelf | 43.00 | 05 |
| 22LDC | Locking Door | 226.00 | 13 |

* Packs in two (one UF4331 case and one UF4325 case) cases at \$330.00 ea--additional case may be required for options

Rectangular Curving Cabinet 22" x 34"--open back

| | | | |
|-----------|-------------------------|--------|----|
| EPC341-29 | 29" High | 876.00 | 35 |
| EPC341-36 | 36" High | 887.00 | 40 |
| EPC341-43 | 43" High | 931.00 | 47 |
| SMC1430 | 14" x 30" Curving shelf | 43.00 | 05 |
| 22LDC | Locking Door | 226.00 | 13 |

* Packs in one UF4331 case at \$330.00 ea--additional case may be required for options

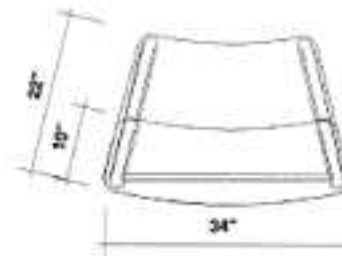

Rectangular Curving Cabinet 22" x 34" with riser--open back

| | | | |
|--------------|-----------------------------------|----------|----|
| EPC341-29-14 | 29" High with 14" riser--43" high | 1,588.00 | 60 |
| EPC341-36-7 | 36" High with 7" riser--43" high | 1,599.00 | 53 |
| SMC1430 | 14" x 30" Curving shelf | 43.00 | 05 |
| 22LDC | Locking Door | 226.00 | 13 |

* Packs in two (one UF4331 case and one UF4325 case) cases at \$330.00 ea--additional case may be required for options

COMPUTER

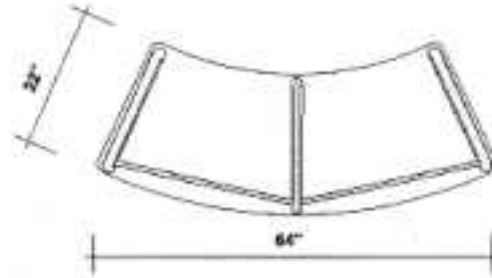

STANDARD



Rectangular Curving Computer cabinet 22" x 64", 2 sections--open back

| Order # | Description | Price | Weight |
|-------------|--|----------|--------|
| EPCSC642-43 | 43" High with two inside shelves, two keyboard pullouts | 1,807.00 | 107 |
| WM153 | Wire management grommet, 1.5" x 3" rectangular, (specify location) | 19.00 | 00 |
| SMC1430 | 14" x 30" Curving shelf | 43.00 | 05 |
| 22LDC | Locking Door | 226.00 | 13 |

* Packs in two (one UF4331 case and one UF4325 case) cases at \$330.00 ea--additional case may be required for options

Rectangular Curving Cabinet 22" x 64", 2 sections--open back

| | | | |
|-----------|-------------------------|----------|----|
| EPC642-29 | 29" High | 1,487.00 | 60 |
| EPC642-36 | 36" High | 1,510.00 | 68 |
| EPC642-43 | 43" High | 1,576.00 | 79 |
| SMC1430 | 14" x 30" Curving shelf | 43.00 | 05 |
| 22LDC | Locking Door | 226.00 | 13 |

* Packs in two (one UF4331 case and one UF4325 case) cases at \$330.00 ea--additional case may be required for options

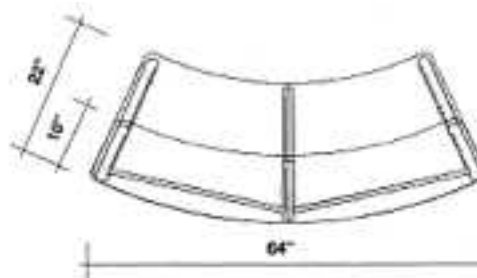

Rectangle Curving Cabinet 22" x 64" with riser, 2 sections--open back

| | | | |
|-------------|----------------------------------|----------|----|
| EPC642-36-7 | 36" High with 7" riser--43" high | 2,734.00 | 91 |
| SMC1430 | 14" x 30" Curving shelf | 43.00 | 05 |
| 22LDC | Locking Door | 226.00 | 13 |

* Packs in three (one UF4331 case and two UF4325 cases) cases at \$330.00 ea--additional case may be required for options

COMPUTER

STANDARD

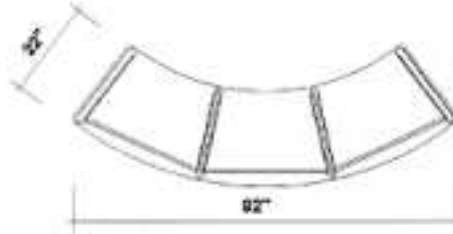

Rectangular Curving Computer cabinet 22" x 92" with three brace panels, 3 sections--open back

| Order # | Description | Price | Weight |
|-------------|--|----------|--------|
| EPCSC923-43 | 43" High with three inside shelves, three keyboard pullouts | 2,557.00 | 153 |
| WM153 | Wire management grommet, 1.5" x 3" rectangular, (specify location) | 19.00 | 00 |
| SMC1430 | 14" x 30" Curving shelf | 43.00 | 05 |
| 22LDC | Locking Door | 226.00 | 13 |

* Packs in three (one UF4331 case and two UF4325 cases) cases at \$330.00 ea--additional case may be required for options

Rectangular Curving Cabinet 22" x 92", 3 sections--open back

| | | | |
|-----------|-------------------------|----------|-----|
| EPC923-29 | 29" High | 2,087.00 | 84 |
| EPC923-36 | 36" High | 2,122.00 | 96 |
| EPC923-43 | 43" High | 2,210.00 | 110 |
| SMC1430 | 14" x 30" Curving shelf | 43.00 | 05 |
| 22LDC | Locking Door | 226.00 | 13 |

* Packs in three (one UF4331 case and two UF4325 cases) cases at \$330.00 ea--additional case may be required for options

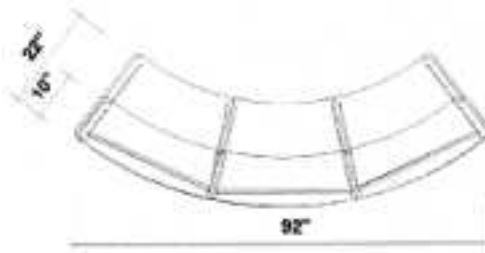

Rectangular Curving Cabinet 22" x 92" with riser, 3 sections--open back

| | | | |
|-------------|----------------------------------|----------|-----|
| EPC923-36-7 | 36" High with 7" riser--43" high | 3,848.00 | 129 |
| SMC1430 | 14" x 30" Curving shelf | 43.00 | 05 |
| 22LDC | Locking Door | 226.00 | 13 |

* Packs in four (one UF4331 case and three UF4325 cases) cases at \$330.00 ea--additional case may be required for options

COMPUTER

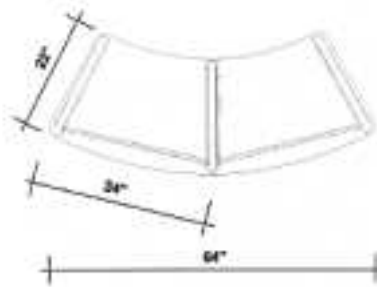

STANDARD



Rectangular Curving Multi-Level Computer Cabinet 22" x 64" with two brace panels, 2 sections--open back

| Order # | Description | Price | Weight |
|------------|---|----------|--------|
| EPCSCM642R | 43" High with right extension at 36" high, one internal shelf, one keyboard pullout | 1,857.00 | 95 |
| EPCSCM642L | 43" High with left extension at 36" high, one internal shelf, one keyboard pullout | 1,857.00 | 95 |
| WM153 | Wire management grommet, 1.5" x 3" rectangular, (specify location) | 19.00 | 00 |
| SMC1430 | 14" x 30" Curving shelf | 43.00 | 05 |
| 22LDC | Locking Door | 226.00 | 13 |

* Packs in two (one UF4331 case and one UF4325 case) cases at \$330.00 ea--additional case may be required for options

Rectangular Curving Multi-Level Cabinet 22" x 64" with two brace panels, 2 sections--open back

| | | | |
|----------|---|----------|----|
| EPCM642R | 43" High with right extension at 36" high | 1,742.00 | 81 |
| EPCM642L | 43" High with left extension at 36" high | 1,742.00 | 81 |
| SMC1430 | 14" x 30" Curving shelf | 43.00 | 05 |
| 22LDC | Locking Door | 226.00 | 13 |

* Packs in two (one UF4331 case and one UF4325 case) cases at \$330.00 ea--additional case may be required for options

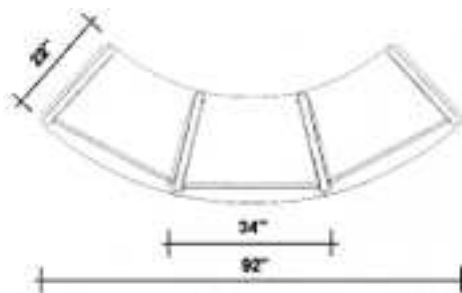

Rectangular Curving Multi-Level Computer Cabinet 22" x 92" with three brace panels, 3 sections--open back

| | | | |
|-----------|--|----------|-----|
| EPCSCM923 | 43" High with extensions at 36" high, one inside shelf, one keyboard pullout | 2,668.00 | 129 |
| WM153 | Wire management grommet, 1.5" x 3" rectangular, (specify location) | 19.00 | 00 |
| SMC1430 | 14" x 30" Curving shelf | 43.00 | 05 |
| 22LDC | Locking Door | 226.00 | 13 |

* Packs in three (one UF4331 case and two UF4325 cases) cases at \$330.00 ea--additional case may be required for options

Rectangular Curving Multi-Level Cabinet 22" x 92" with three brace panels, 3 sections--open back

| | | | |
|-----------|--------------------------------------|----------|-----|
| EPCM923RL | 43" High with extensions at 36" high | 2,553.00 | 115 |
| SMC1430 | 14" x 30" Curving shelf | 43.00 | 05 |
| 22LDC | Locking Door | 226.00 | 13 |

* Packs in three (one UF4331 case and two UF4325 cases) cases at \$330.00 ea--additional case may be required for options

COMPUTER

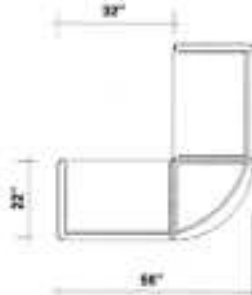

STANDARD



Rectangular Computer Cabinet 56" x 56" with 90 degree corner, 3 cabinet corner set--open back

| Order # | Description | Price | Weight |
|-------------|--|----------|--------|
| EPCS9055-43 | 43" High with two inside shelves, two keyboard pullouts | 2,494.00 | 134 |
| WM153 | Wire management grommet, 1.5" x 3" rectangular, (specify location) | 19.00 | 00 |
| SM1430 | 14" x 30" Shelf | 43.00 | 05 |
| 30LD | Locking Door | 226.00 | 13 |

* Packs in three (one UF4331 case and two UF4325 cases) cases at \$330.00 ea--additional case may be required for options

Rectangle Cabinet 56" x 56" with 90 degree corner, 3 cabinet corner set--open back

| | | | |
|-----------|-----------------|----------|-----|
| EP9056-36 | 36" High | 2,162.00 | 97 |
| EP9056-43 | 43" High | 2,263.00 | 112 |
| SM1430 | 14" x 30" Shelf | 43.00 | 05 |
| 30LD | Locking Door | 226.00 | 13 |

* Packs in two (one UF4331 case and one UF4325 case) cases at \$330.00 ea--additional case may be required for options

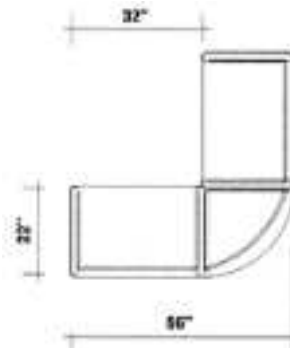

Rectangular Multi-Level Computer Cabinet 56" x 56" with 90 degree corner, 3 cabinet corner set--open back

| | | | |
|------------|---|----------|-----|
| EPCSM9055C | 43" High with corner at 36" high, two inside shelves, two keyboard pullouts | 2,868.00 | 146 |
| WM153 | Wire management grommet, 1.5" x 3" rectangular, (specify location) | 19.00 | 00 |
| SM1430 | 14" x 30" Shelf | 43.00 | 05 |
| 30LD | Locking Door | 226.00 | 13 |

* Packs in three (one UF4331 case and two UF4325 cases) cases at \$330.00 ea--additional case may be required for options

Rectangle Multi-Level Cabinet 56" x 56" with 90 degree corner, 3 cabinet corner set--open back

| | | | |
|----------|----------------------------------|----------|-----|
| EPM9056C | 43" High with corner at 36" high | 2,637.00 | 124 |
| SM1430 | 14" x 30" Shelf | 43.00 | 05 |
| 22LDC | Locking Door | 226.00 | 13 |

* Packs in two (one UF4331 case and one UF4325 case) cases at \$330.00 ea--additional case may be required for options

COMPUTER

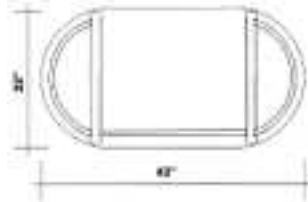

STANDARD



Oval Computer Cabinet 22" x 43"--open back

| Order # | Description | Price | Weight |
|-------------|--|----------|--------|
| EPCSO431-43 | 43" High with one inside shelf, one keyboard pullout | 1,395.00 | 73 |
| WM153 | Wire management grommet, 1.5" x 3" rectangular, (specify location) | 19.00 | 00 |
| SM1424 | 14" x 24" Shelf | 43.00 | 05 |
| 24LD | Locking Door | 226.00 | 13 |

* Packs in two UF4825 cases at \$330.00 ea--additional case may be required for options

Oval Cabinet 22" x 43"--open back

| | | | |
|-----------|-----------------|----------|----|
| EPO431-29 | 29" High | 1,178.00 | 47 |
| EPO431-36 | 36" High | 1,199.00 | 54 |
| EPO431-43 | 43" High | 1,280.00 | 64 |
| SM1424 | 14" x 24" Shelf | 43.00 | 05 |
| 24LD | Locking Door | 226.00 | 12 |

* Packs in one UF4825 case at \$330.00 ea--additional case may be required for options

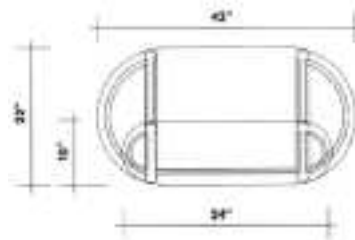

Oval Cabinet 22" x 43" with riser--open back

| | | | |
|--------------|-----------------------------------|----------|----|
| EPO431-29-14 | 29" High with 14" riser--43" high | 2,033.00 | 72 |
| EPO431-36-7 | 36" High with 7" riser--43" high | 2,054.00 | 68 |
| SM1424 | 14" x 24" Shelf | 43.00 | 05 |
| 24LD | Locking Door | 226.00 | 13 |

* Packs in two UF4825 cases at \$330.00 ea--additional case may be required for options

COMPUTER

STANDARD

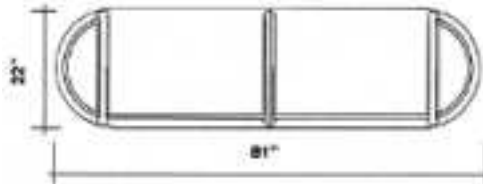

Oval Computer Cabinet 22" x 81", 2 sections--open back

| Order # | Description | Price | Weight |
|-------------|--|----------|--------|
| EPCSO812-43 | 43" High with two inside shelves, two keyboard pullouts | 2,156.00 | 121 |
| WM153 | Wire management grommet, 1.5" x 3" rectangular, (specify location) | 19.00 | 00 |
| SM1430 | 14" x 30" Shelf | 43.00 | 05 |
| 30LD | Locking Door | 226.00 | 13 |

* Packs in three (one UF4331 case and two UF4325 cases) cases at \$330.00 ea--additional case may be required for options

Oval Cabinet 22" x 81", 2 sections--open back

| | | | |
|-----------|-----------------|----------|----|
| EPO812-29 | 29" High | 1,789.00 | 75 |
| EPO812-29 | 36" High | 1,833.00 | 85 |
| EPO812-29 | 43" High | 1,925.00 | 98 |
| SM1430 | 14" x 30" Shelf | 43.00 | 05 |
| 30LD | Locking Door | 226.00 | 13 |

* Packs in two (one UF4331 case and one UF4325 case) cases at \$330.00 ea--additional case may be required for options

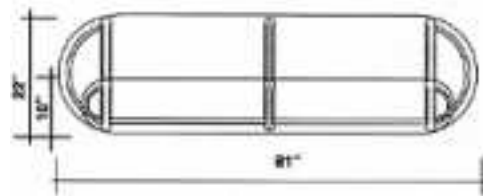

Oval Cabinet 22" x 81" with riser, 2 sections--open back

| | | | |
|--------------|-----------------------------------|----------|-----|
| EPO812-29-14 | 29" High with 14" riser--43" high | 3,156.00 | 116 |
| EPO812-36-7 | 36" High with 7" riser--43" high | 3,200.00 | 110 |
| SM1430 | 14" x 30" Shelf | 43.00 | 05 |
| 30LD | Locking Door | 226.00 | 13 |

* Packs in three (one UF4331 case and two UF4325 cases) cases at \$330.00 ea--additional case may be required for options

COMPUTER

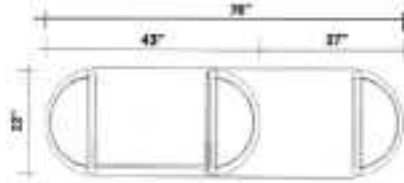

STANDARD



Oval Multi-Level Computer Cabinet 22" x 70" with two brace panels, 2 sections--open back

| Order # | Description | Price | Weight |
|-----------|--|----------|--------|
| EPCSOM702 | 43" High with extension at 36" high | 2,283.00 | 109 |
| WM153 | Wire management grommet, 1.5" x 3" rectangular, (specify location) | 19.00 | 00 |
| SM1424 | 14" x 24" Shelf | 43.00 | 04 |
| 24LD | Locking Door | 226.00 | 12 |

* Packs in two (one UF4825 case and one UF4331 case) cases at \$330.00 ea--additional case may be required for options

Oval Multi-Level Cabinet 22" x 70" with two brace panels, 2 sections--open back

| | | | |
|---------|-------------------------------------|----------|-----|
| EPOM702 | 43" High with extension at 36" high | 2,160.00 | 100 |
| SM1424 | 14" x 24" Shelf | 43.00 | 04 |
| 24LD | Locking Door | 226.00 | 12 |

* Packs in two (one UF4825 case and one UF4331 case) cases at \$330.00 ea--additional case may be required for options

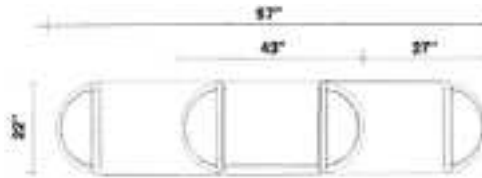

Oval Multi-Level Computer Cabinet 22" x 97" with three brace panels, 3 sections--open back

| | | | |
|-----------|---|----------|-----|
| EPCSOM973 | 43" High with two extensions at 36" high, one inside shelf one keyboard pullout | 3,164.00 | 146 |
| WM153 | Wire management grommet, 1.5" x 3" rectangular, (specify location) | 19.00 | 00 |
| SM1424 | 14" x 24" Shelf | 43.00 | 05 |
| 24LD | Locking Door | 226.00 | 12 |

* Packs in three (one UF4331 case and two UF4825 cases) cases at \$330.00 ea--additional case may be required for options

Oval Multi-Level Cabinet 22" x 97" with three brace panels, 3 sections--open back

| | | | |
|---------|-------------------------------------|----------|-----|
| EPOM973 | 43" High with extension at 36" high | 3,040.00 | 137 |
| SM1424 | 14" x 24" Shelf | 43.00 | 04 |
| 24LD | Locking Door | 226.00 | 12 |

* Packs in three (one UF4331 case and two UF4825 cases) cases at \$330.00 ea--additional case may be required for options

COMPUTER

STANDARD

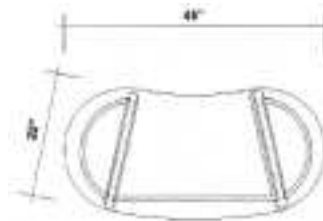

Oval Curving Computer Cabinet 22" x 45"--open back

| Order # | Description | Price | Weight |
|--------------|--|----------|--------|
| EPCSOC451-43 | 43" High with one inside shelf, one keyboard pullout | 1,395.00 | 79 |
| WM153 | Wire management grommet, 1.5" x 3" rectangular, (specify location) | 19.00 | 00 |
| SMC1430 | 14" x 30" Curving shelf | 43.00 | 05 |
| 22LDC | Locking Door | 226.00 | 13 |

* Packs in two (one UF4331 case and one UF4825 case) cases at \$330.00 ea--additional case may be required for options

Oval Curving Cabinet 22" x 45"--open back

| | | | |
|------------|-------------------------|----------|----|
| EPOC451-29 | 29" High | 1,178.00 | 48 |
| EPOC451-36 | 36" High | 1,211.00 | 56 |
| EPOC451-43 | 43" High | 1,280.00 | 65 |
| SMC1430 | 14" x 30" Curving shelf | 43.00 | 05 |
| 22LDC | Locking Door | 226.00 | 12 |

* Packs in two (one UF4331 and one UF4825 case) at \$330.00 ea

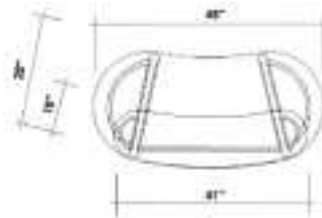

Oval Curving Cabinet 22" x 45" with riser--open back

| | | | |
|--------------|----------------------------------|----------|----|
| EPOC451-36-7 | 36" High with 7" riser--43" high | 1,923.00 | 70 |
| SMC1430 | 14" x 30" Curving shelf | 43.00 | 05 |
| 22LDC | Locking Door | 226.00 | 12 |

* Packs in two (one UF4331 case and one UF4825 case) cases at \$330.00 ea--additional case may be required for options

COMPUTER

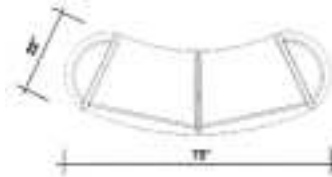

STANDARD



Oval Curving Computer Cabinet 22" x 72", 2 sections--open back

| Order # | Description | Price | Weight |
|--------------|--|----------|--------|
| EPCSOC722-43 | 43" High with two inside shelves, two keyboard pullouts | 2,156.00 | 127 |
| WM153 | Wire management grommet, 1.5" x 3" rectangular, (specify location) | 19.00 | 00 |
| SMC1430 | 14" x 24" Curving shelf | 43.00 | 05 |
| 22LDC | Locking Door | 226.00 | 13 |

* Packs in three (one UF4331 case and two UF4325 cases) cases at \$330.00 ea--additional case may be required for options

Oval Curving Cabinet 22" x 72", 2 sections--open back

| | | | |
|------------|-------------------------|----------|----|
| EPOC722-36 | 36" High | 1,833.00 | 85 |
| EPOC722-43 | 43" High | 1,925.00 | 98 |
| SMC1430 | 14" x 30" Curving shelf | 43.00 | 05 |
| 22LDC | Locking Door | 226.00 | 12 |

* Packs in two (one UF4331 case and one UF4325 case) cases at \$330.00 ea--additional case may be required for options

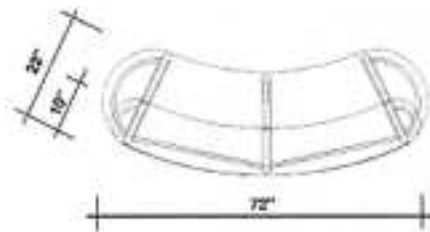

Oval Curving Cabinet 22" x 72" with riser, 2 sections--open back

| | | | |
|--------------|----------------------------------|----------|-----|
| EPOC722-36-7 | 36" High with 7" riser--43" high | 3,200.00 | 110 |
| SMC1430 | 14" x 30" Curving shelf | 43.00 | 05 |
| 22LDC | Locking Door | 226.00 | 12 |

* Packs in three (one UF4331 case and two UF4325 cases) cases at \$330.00 ea--additional case may be required for options

COMPUTER

STANDARD

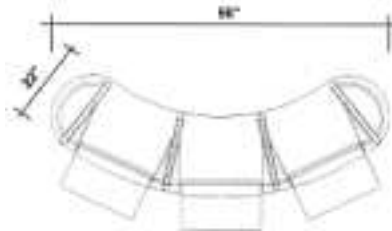

Oval Curving Computer Cabinet 22" x 96", 3 sections--open back

| Order # | Description | Price | Weight |
|--------------|--|----------|--------|
| EPCSOC963-43 | 43" High with two inside shelves, two keyboard pullouts | 2,905.00 | 173 |
| WM153 | Wire management grommet, 1.5" x 3" rectangular, (specify location) | 19.00 | 00 |
| SMC1430 | 14" x 30" Curving shelf | 43.00 | 05 |
| 22LDC | Locking Door | 226.00 | 13 |

* Packs in four (one UF4331 case and three UF4325 cases) cases at \$330.00 ea--additional case may be required for options

Oval Curving Cabinet 22" x 96", 3 sections--open back

| | | | |
|------------|---|----------|-----|
| EPOC963-43 | 43" High with two inside shelves, two keyboard pullouts | 2,559.00 | 129 |
| SMC1430 | 14" x 30" Curving shelf | 43.00 | 05 |
| 22LDC | Locking Door | 226.00 | 13 |

* Packs in four (one UF4331 case and three UF4325 cases) cases at \$330.00 ea--additional case may be required for options

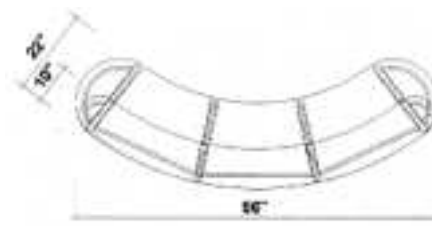

Oval Curving Cabinet 22" x 96"with riser, 3 sections--open back

| | | | |
|--------------|---|----------|-----|
| EPOC963-36-7 | 43" High with right extension at 36" high | 4,314.00 | 147 |
| SMC1430 | 14" x 30" Curving shelf | 43.00 | 05 |
| 22LDC | Locking Door | 226.00 | 13 |

* Packs in four (one UF4331 case and three UF4325 cases) cases at \$330.00 ea--additional case may be required for options

COMPUTER

STANDARD

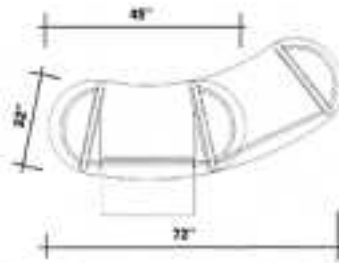

Oval Curving Multi-Level Computer Cabinet 22" x 72" with two brace panels, 2 sections--open back

| Order # | Description | Price | Weight |
|--------------|---|----------|--------|
| EPCSOCM721CR | 43" High with right extension, one internal shelf, one keyboard pullout | 2,275.00 | 116 |
| EPCSOCM721CL | 43" High with left extension, one internal shelf, one keyboard pullout | 2,275.00 | 116 |
| WM153 | Wire management grommet, 1.5" x 3" rectangular, (specify location) | 19.00 | 00 |
| SMC1430 | 14" x 30" Curving shelf | 43.00 | 05 |
| 22LDC | Locking Door | 226.00 | 13 |

* Packs in three (one UF4331 case and one UF4325 case and one UF4825 case) cases at \$330.00 ea
--additional case may be required for options

Oval Curving Multi-Level Cabinet 22" x 72" with one brace panel, 2 sections--open back

| | | | |
|------------|---|----------|-----|
| EPOCM721CR | 43" High with right extension at 36" high | 2,189.00 | 102 |
| EPOCM721CL | 43" High with left extension at 36" high | 2,189.00 | 102 |
| SMC1430 | 14" x 30" Curving shelf | 43.00 | 05 |
| 22LDC | Locking Door | 226.00 | 13 |

* Packs in two (one UF4331 case and one UF4825 case) cases at \$330.00 ea--additional case may be required for options

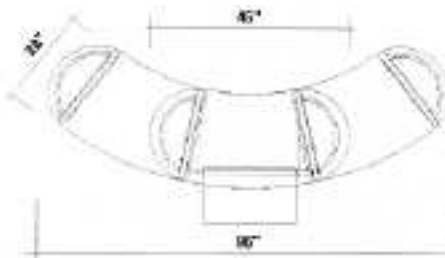

Oval Curving Multi-Level Computer Cabinet 22" x 96" with one brace panel, 3 sections--open back

| | | | |
|------------|--|----------|-----|
| EPCSOCM961 | 43" High with two extensions, one inside shelf, one keyboard pullout | 3,214.00 | 153 |
| WM153 | Wire management grommet, 1.5" x 3" rectangular, (specify location) | 19.00 | 00 |
| SMC1430 | 14" x 30" Curving shelf | 43.00 | 05 |
| 22LDC | Locking Door | 226.00 | 13 |

* Packs in four (one UF4331 case and two UF4325 cases and one UF4825 case) cases at \$330.00 ea
--additional case may be required for options

Oval Curving Multi-Level Cabinet 22" x 72" with two extensions, one brace panel, 3 sections--open back

| | | | |
|----------|---|----------|-----|
| EPOCM961 | 43" High with right extension at 36" high | 3,099.00 | 139 |
| SMC1430 | 14" x 30" Curving shelf | 43.00 | 05 |
| 22LDC | Locking Door | 226.00 | 12 |

* Packs in three (one UF4331 case and one UF4325 case and one UF4825 case) cases at \$330.00 ea
--additional case may be required for options

COMPUTER

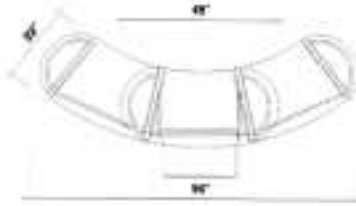

STANDARD



Oval Curving Multi-Level Computer Cabinet 22" x 96" with three brace panels, 3 sections--open back

| Order # | Description | Price | Weight |
|------------|--|----------|--------|
| EPCSOCM963 | 43" High with two extensions, one inside shelf, one keyboard pullout | 3,155.00 | 153 |
| WM153 | Wire management grommet, 1.5" x 3" rectangular, (specify location) | 19.00 | 00 |
| SMC1430 | 14" x 24" Curving shelf | 43.00 | 05 |
| 22LDC | Locking Door | 226.00 | 13 |

* Packs in four (one UF4331 case and two UF4325 cases and one UF4825 case) cases at \$330.00 ea
--additional case may be required for options

Oval Curving Multi-Level Cabinet 22" x 96" with three brace panels, 3 sections--open back

| | | | |
|----------|--|----------|-----|
| EPOCM963 | 43" High with two extensions at 36" high | 3,040.00 | 139 |
| SMC1430 | 14" x 24" Curving shelf | 43.00 | 05 |
| 22LDC | Locking Door | 226.00 | 13 |

* Packs in three (one UF4331 case and one UF4325 case and one UF4825) cases at \$330.00 ea
--additional case may be required for options

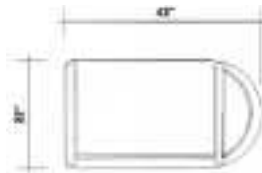

Half Oval Computer Cabinet 22" x 42"--open back

| | | | |
|--------------|--|----------|----|
| EPCSHO421-43 | 43" High with one internal shelf, one keyboard pullout | 1,221.00 | 68 |
| WM153 | Wire management grommet, 1.5" x 3" rectangular, (specify location) | 19.00 | 00 |
| SM1430 | 14" x 30" Shelf | 43.00 | 05 |
| 30LD | Locking Door | 226.00 | 13 |

* Packs in two (one UF4331 case and one UF4325 case) cases at \$330.00 ea--additional case may be required for options

Half Oval Cabinet 22" x 42"--open back

| | | | |
|------------|-----------------|----------|----|
| EPHO421-29 | 29" High | 1,027.00 | 43 |
| EPHO421-36 | 36" High | 1,049.00 | 48 |
| EPHO421-43 | 43" High | 1,106.00 | 57 |
| SM1430 | 14" x 30" Shelf | 43.00 | 05 |
| 30LD | Locking Door | 226.00 | 13 |

* Packs in one UF4331 case at \$330.00 ea--additional case may be required for options

COMPUTER

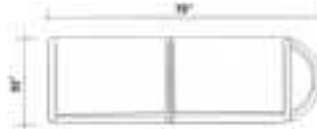

STANDARD



Half Oval Computer Cabinet 22" x 73", 2 sections--open back

| Order # | Description | Price | Weight |
|--------------|--|----------|--------|
| EPCSHO742-43 | 43" High with two inside shelves, two keyboard pullouts | 1,981.00 | 111 |
| WM153 | Wire management grommet, 1.5" x 3" rectangular, (specify location) | 19.00 | 00 |
| SM1430 | 14" x 30" Shelf | 43.00 | 05 |
| 30LD | Locking Door | 226.00 | 13 |

* Packs in three (one UF4331 case and two UF4325 cases) cases at \$330.00 ea--additional case may be required for options

Half Oval Cabinet 22" x 73", 2 sections--open back

| | | | |
|------------|-----------------|----------|----|
| EPHO732-29 | 29" High | 1,638.00 | 67 |
| EPHO732-36 | 36" High | 1,672.00 | 76 |
| EPHO732-43 | 43" High | 1,750.00 | 88 |
| SM1430 | 14" x 30" Shelf | 43.00 | 05 |
| 30LD | Locking Door | 226.00 | 13 |

* Packs in two (one UF4331 case and one UF4325 case) cases at \$330.00 ea--additional case may be required for options

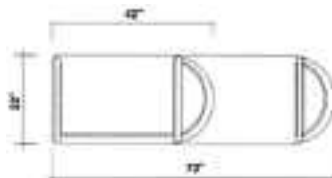

Half Oval Multi-Level Computer Cabinet 22" x 73" with one brace panel, 2 sections--open back

| | | | |
|------------|---|----------|-----|
| EPCSHOM741 | 43" High with extension at 36" high, one inside shelf, one keyboard pullout | 2,120.00 | 105 |
| WM153 | Wire management grommet, 1.5" x 3" rectangular, (specify location) | 19.00 | 00 |
| SM1430 | 14" x 30" Shelf | 43.00 | 05 |
| 30LD | Locking Door | 226.00 | 13 |

* Packs in three (one UF4331 case and two UF4325 cases) cases at \$330.00 ea--additional case may be required for options

Half Oval Multi-Level Cabinet 22" x 73" with one brace panel, 2 sections--open back

| | | | |
|----------|-------------------------------------|----------|----|
| EPHOM731 | 43" High with extension at 36" high | 2,004.00 | 94 |
| SM1430 | 14" x 30" Shelf | 43.00 | 05 |
| 22LDC | Locking Door | 226.00 | 12 |

* Packs in two (one UF4331 case and one UF4325 case) cases at \$330.00 ea--additional case may be required for options

COMPUTER

STANDARD

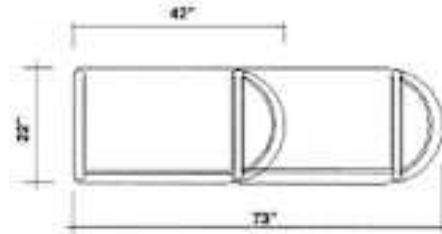

Half Oval Multi-Level Computer Cabinet 22" x 73" with two brace panels, 2 sections--open back

| Order # | Description | Price | Weight |
|------------|---|----------|--------|
| EPCSHOM742 | 43" High with extension at 36" high, one internal shelf, one keyboard pullout | 2,091.00 | 105 |
| WM153 | Wire management grommet, 1.5" x 3" rectangular, (specify location) | 19.00 | 00 |
| SM1430 | 14" x 30" Shelf | 43.00 | 05 |
| 30LD | Locking Door | 226.00 | 13 |

* Packs in three (one UF4331 case and two UF4325 cases) cases at \$330.00 ea--additional case may be required for options

Half Oval Multi-Level Cabinet 22" x 73" with two brace panels, 2 sections--open back

| | | | |
|----------|-------------------------------------|----------|----|
| EPHOM732 | 43" High with extension at 36" high | 1,975.00 | 94 |
| SM1430 | 14" x 30" Shelf | 43.00 | 05 |
| 30LD | Locking Door | 226.00 | 13 |

* Packs in two (one UF4331 case and one UF4325 case) cases at \$330.00 ea--additional case may be required for options

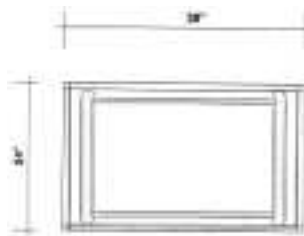

Select material for pad and base lamination

Locking Jewelry Case 24" x 39" x 7"high on 36" base, black anodized aluminum frame

| | | | |
|----------|--|----------|----|
| EPLJ7-43 | 43" High with rectangular base with locking door on back | 1,854.00 | 84 |
| SM1430 | 14" x 30" Shelf | 43.00 | 04 |
| SCL | Showcase light option | 278.00 | 02 |

* Packs in two (one UF4331 case and one UF4325 case) cases at \$330.00 ea--additional case may be required for options

* Jewelry case size can be customized, contact us.

KIOSKS

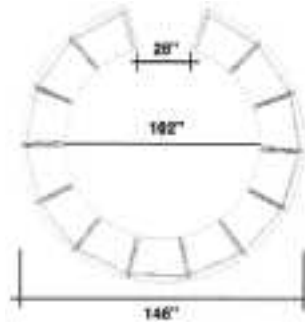

Curving Kiosk 146" diameter, 13 sections 22" x 146", 13 sections--open back

| Order # | Description | Price | Weight |
|-------------|-------------------------|----------|--------|
| EPK14613-36 | 36" High | 8,244.00 | 376 |
| EPK14613-43 | 43" High | 8,552.00 | 427 |
| SMC1430 | 14" x 30" Curving shelf | 43.00 | 05 |
| 22LDC | Locking Door | 226.00 | 13 |

* Packs in three UF4331 cases and twelve UF4325 cases at \$330.00 ea

* Or three UF4848 cases (check page C-1 for prices on jumbo cases)--additional cases may be required for options

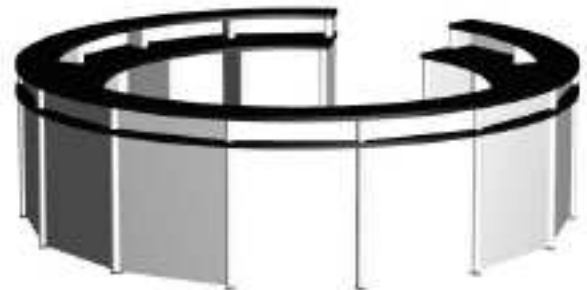
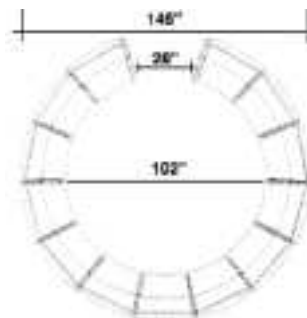

Curving Kiosk 146" diameter, 13 sections 22" x 146" with risers, 13 sections--open back

| | | | |
|---------------|----------------------------------|-----------|-----|
| EPK14613-36-7 | 36" High with 7" riser--43" high | 14,989.00 | 505 |
| SMC1430 | 14" x 30" Curving shelf | 43.00 | 05 |
| 22LDC | Locking Door | 226.00 | 13 |

* Packs in three UF4331 cases and twelve UF4325 cases at \$330.00 ea

* Or three UF4848 cases (check page C-1 for prices on jumbo cases)--additional cases may be required for options

KIOSKS/TOWERS



EPK90108-36

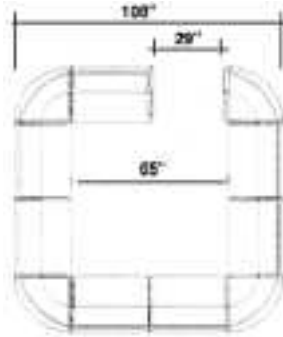

EPK90108-36-7

Rectangular Kiosk 108" x 108" with 90 degree corners--open back

| Order # | Description | Price | Weight |
|-------------|-----------------|----------|--------|
| EPK90108-36 | 36" High | 7,179.00 | 324 |
| EPK90108-43 | 43" High | 7,494.00 | 369 |
| SM1430 | 14" x 30" Shelf | 43.00 | 05 |
| 30LD | Locking Door | 226.00 | 13 |

* Packs in two UF4331 cases and seven UF4325 cases at \$330.00 ea

* Or two UF4848 cases (check page C-1 for prices on jumbo cases)--additional cases may be required for options

Rectangular Kiosk 108" x 108" with 90 degree corners and risers--open back

| | | | |
|---------------|----------------------------------|-----------|-----|
| EPK90108-36-7 | 43" High with 7" riser--43" high | 12,983.00 | 435 |
| SM1430 | 14" x 30" Shelf | 43.00 | 05 |
| 30LD | Locking Door | 226.00 | 13 |

* Packs in three UF4331 cases and nine UF4325 case at \$330.00 ea

* Or three UF4848 cases (check page C-1 for prices on jumbo cases)--additional cases may be required for options



EPCMT2834-84

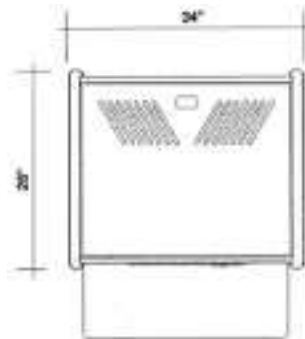

EPMT2834-84

Computer Monitor Tower 28" x 34"

| | | | |
|--------------|--|----------|-----|
| EPCMT2834-84 | 84" High with locking door, one inside shelf, one keyboard pullout | 2,683.00 | 143 |
|--------------|--|----------|-----|

* Packs in three UF4331 cases at \$330.00 ea--additional case may be required for options

Monitor Tower 28" x 34"

| | | | |
|-------------|----------------------------|----------|-----|
| EPMT2834-84 | 84" High with locking door | 2,563.00 | 129 |
| SEP2230 | 22" x 30" Shelf | 47.00 | 07 |

* Packs in three UF4331 cases at \$330.00 ea--additional case may be required for options

COMPUTER PEDESTAL

PEDESTAL

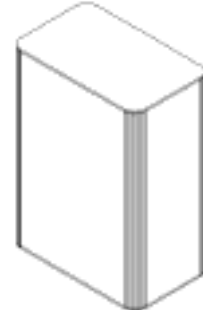
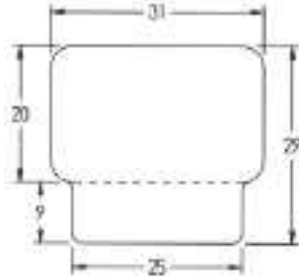
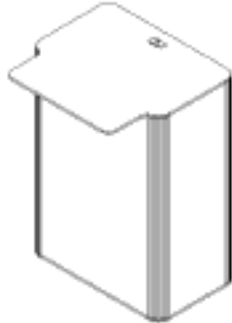

Rectangular Computer Cabinet 20" x 31"

| Order # | Description | Price | Weight |
|-------------|--|--------|--------|
| ULCS2031-36 | 20" x 31" - 36" High | 552.00 | 21 |
| ULCS2031-42 | 20" x 31" - 42" High | 566.00 | 23 |
| SUL2031K | 20" x 31" Shelf kit with poles & support clips | 65.00 | 07 |

* Packs two per UF4331 case at \$330.00 ea

Rectangular Cabinet 20" x 31"

| | | | |
|-----------|--|--------|----|
| UL2031-36 | 20" x 31" - 36" High | 514.00 | 18 |
| UL2031-42 | 20" x 31" - 42" High | 528.00 | 20 |
| SUL2031K | 20" x 31" Shelf kit with poles & support clips | 65.00 | 07 |

* Packs two per UF4325 case at \$330.00 ea

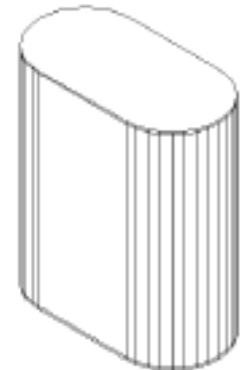
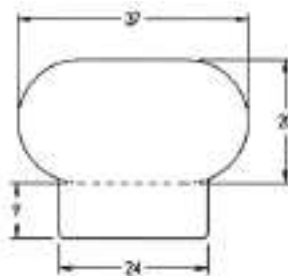

Oval Computer Cabinet 20" x 37"

| | | | |
|--------------|--|--------|----|
| ULCSO2037-36 | 20" x 37" - 36" High | 552.00 | 21 |
| ULCSO2037-42 | 20" x 37" - 42" High | 566.00 | 23 |
| SULO2037K | 20" x 37" Shelf kit with poles & support clips | 65.00 | 07 |

* Packs two per UF4331 case at \$330.00 ea

Oval Cabinet 20" x 37"

| | | | |
|------------|--|--------|----|
| ULO2037-36 | 20" x 37" - 36" High | 514.00 | 18 |
| ULO2037-42 | 20" x 37" - 42" High | 528.00 | 20 |
| SULO2037K | 20" x 37" Shelf kit with poles & support clips | 65.00 | 07 |

* Packs two per UF4325 case at \$330.00 ea

PEDESTAL

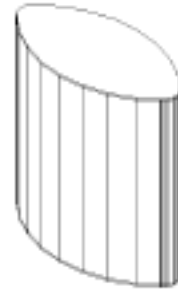

Elliptical Cabinet 20" x 41"

| Order # | Description | Price | Weight |
|------------|--|--------|--------|
| ULE2041-36 | 20" x 41" - 36" High | 514.00 | 18 |
| ULE2041-42 | 20" x 41" - 42" High | 528.00 | 20 |
| SULE2041K | 20" x 41" Shelf kit with poles & support clips | 65.00 | 07 |

* Packs two per UF4325 case at \$330.00 ea

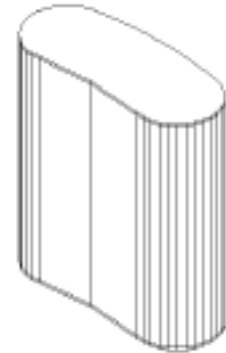
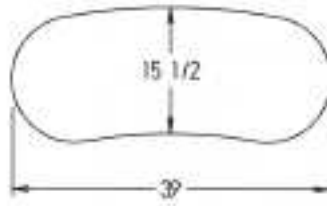

Oval Curving Cabinet 16" x 39"

| | | | |
|-------------|--|--------|----|
| ULOC1639-36 | 16" x 39" - 36" High, curve fits 10' popup or 72" radius wall system | 514.00 | 18 |
| ULOC1639-42 | 16" x 39" - 42" High, curve fits 10' popup or 72" radius wall system | 528.00 | 20 |
| SULOC1639K | 16" x 39" Shelf kit with poles & support clips | 65.00 | 07 |

* Packs two per UF4325 case at \$330.00 ea

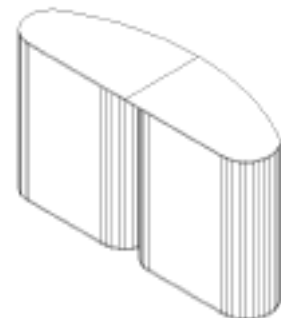
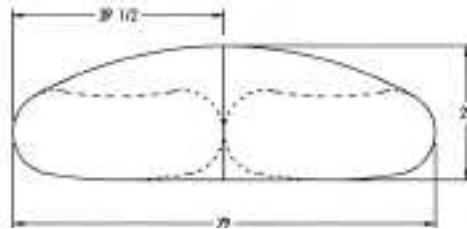

Double Oval Curving Cabinet set 25" x 79", 2 sections

| | | | |
|-------------|--|----------|----|
| ULOC2579-36 | 25" x 79" - 36" High, curve fits 10' popup or 72" radius wall system | 1,028.00 | 40 |
| ULOC2579-42 | 25" x 79" - 42" High, curve fits 10' popup or 72" radius wall system | 1,056.00 | 43 |
| SULOC1639K | 16" x 39" Shelf kit with poles & support clips | 65.00 | 07 |

* Packs one per UF4325 case at \$330.00 ea

PEDESTAL

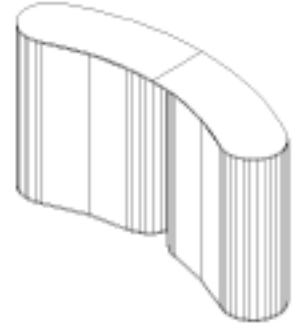
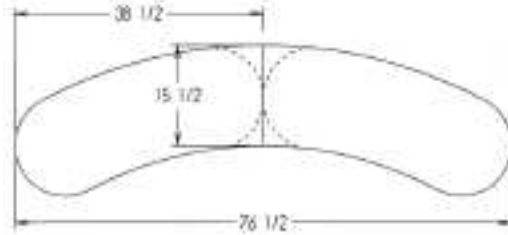

Double Oval Curving Cabinet set 16" x 77", 2 sections

| Order # | Description | Price | Weight |
|-------------|---|----------|--------|
| ULOC1677-36 | 16" x 77"- 36" High, curve fits 10' popup or 72" radius wall system | 1,028.00 | 36 |
| ULOC1677-42 | 16" x 77"- 42" High, curve fits 10' popup or 72" radius wall system | 1,056.00 | 40 |
| SULOC1639K | 16" x 39" Shelf kit with poles & support clips | 65.00 | 07 |

* Packs one per UF4325 case at \$330.00 ea

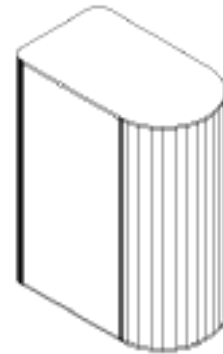
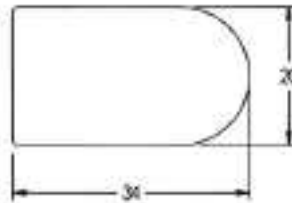

Half Oval Cabinet 20" x 34"

| | | | |
|-------------|--|--------|----|
| ULHO2034-36 | 20" x 34"- 36" High | 514.00 | 18 |
| ULHO2034-42 | 20" x 34"- 42" High | 528.00 | 20 |
| SULHO2034K | 20" x 34" Shelf kit with poles & support clips | 65.00 | 07 |

* Packs two per UF4325 case at \$330.00 ea

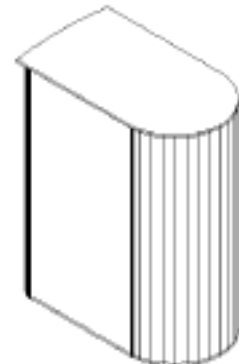
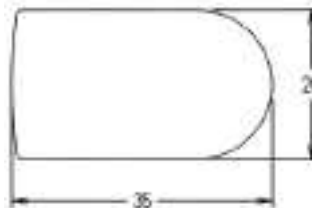

Half Oval Cabinet with curved top 20" x 35"

| | | | |
|--------------|---|--------|----|
| ULHO2035C-36 | 20" x 35"- 36" High, curve fits 10' popup or 72" radius wall system | 514.00 | 18 |
| ULHO2035C-42 | 20" x 35"- 42" High, curve fits 10' popup or 72" radius wall system | 528.00 | 20 |
| SULHO2034K | 20" x 34" Shelf kit with poles & support clips | 65.00 | 07 |

* Packs two per UF4325 case at \$330.00 ea

PEDESTAL

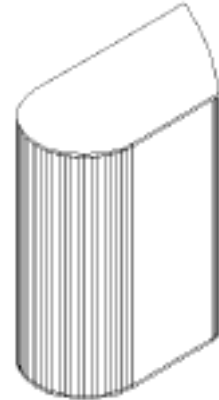
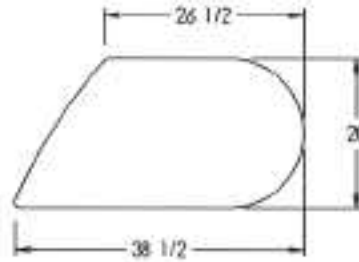

Half Oval Cabinet with right curved top 20" x 39"

| Order # | Description | Price | Weight |
|--------------|---|--------|--------|
| ULHO2039R-36 | 20" x 39"- 36" High, curve fits 10' popup or 72" radius wall system | 514.00 | 18 |
| ULHO2039R-42 | 20" x 39"- 42" High, curve fits 10' popup or 72" radius wall system | 528.00 | 20 |
| SULHO2039K | 20" x 39" Shelf kit with poles & support clips | 65.00 | 07 |

* Packs two per UF4325 case at \$330.00 ea

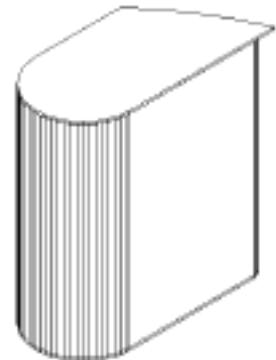
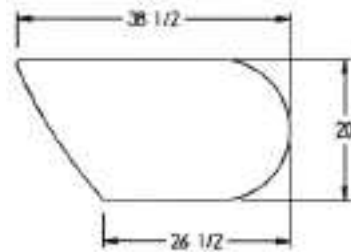

Half Oval Cabinet with left curved top 20" x 39"

| | | | |
|--------------|---|--------|----|
| ULHO2039L-36 | 20" x 39"- 36" High, curve fits 10' popup or 72" radius wall system | 514.00 | 18 |
| ULHO2039L-42 | 20" x 39"- 42" High, curve fits 10' popup or 72" radius wall system | 528.00 | 20 |
| SULHO2039K | 20" x 39" Shelf kit with poles & support clips | 65.00 | 07 |

* Packs two per UF4325 case at \$330.00 ea

COMPUTER CABINET

MULTI-CABINET

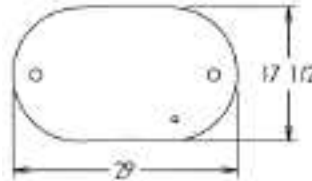
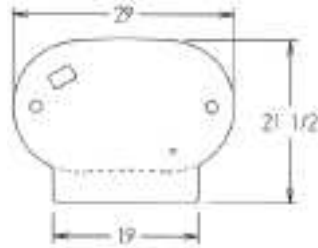

Computer Multi-Cabinet, Kidney Shape with Non-Locking Roll Door

| Order # | Description | Price | Weight |
|----------|---|--------|--------|
| ULCSK-36 | 29" x 17.5" - 36" High, curve fits all 8' and 10' popups | 442.00 | 16 |
| SULMEC | 29" x 17.5" Shelf kit with support clips | 47.00 | 07 |
| ULRD | Upgrade to Locking Door | 40.00 | 00 |
| PBP-W | Plastic banner poles, white, 1 1/2" x 84" High (set of 2) | 65.00 | 02 |

* Packs one per PCB carry bag at \$65.00 ea or packs two per UF4325 case at \$330.00 ea

Multi-Cabinet, Kidney Shape 18" x 29" x 36" with Non-Locking Roll Door

| | | | |
|---------|---|--------|----|
| ULMK-36 | 18" x 29" - 36" High, curve fits all 8' and 10' popups | 379.00 | 15 |
| SULMCK | 29" x 17.5" Shelf kit with poles & support clips | 65.00 | 07 |
| ULRD | Upgrade to Locking Door | 40.00 | 00 |
| PBP-W | Plastic banner poles, white, 1 1/2" x 84" High (set of 2) | 65.00 | 02 |

* Packs one per PCB carry bag at \$65.00 ea or packs two per UF4325 case at \$330.00 ea



ULKY105L

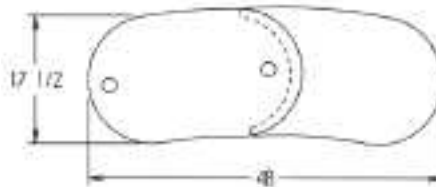

ULKY105R

Multi-Cabinet, Kidney Shape with Right or Left Extension & Non-Locking Roll Door, 2 sections

| | | | |
|----------|---|--------|----|
| ULKY105R | 36" High, curve fits all 8' and 10' popups | 748.00 | 29 |
| ULKY105L | 36" High, curve fits all 8' and 10' popups | 748.00 | 29 |
| SULMCK | 29" x 17.5" Shelf kit with poles & support clips | 65.00 | 07 |
| ULRD | Upgrade to Locking Door | 40.00 | 00 |
| PBP-W | Plastic banner poles, white, 1 1/2" x 84" High (set of 2) | 65.00 | 02 |

* Packs in two PCB carry bags at \$65.00 ea or packs one per UF4325 case at \$330.00 ea

MULTI-CABINET

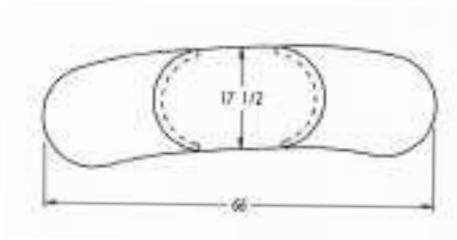

Multi-Cabinet, Kidney Shape, 36" High with Two Extensions & Non-Locking Roll Door, 3 sections

| Order # | Description | Price | Weight |
|---------|---|----------|--------|
| ULKY104 | 36" High, curve fits all 8' and 10' popups | 1,117.00 | 44 |
| SULMKK | 29" x 17.5" Shelf kit with poles & support clips | 65.00 | 07 |
| ULRD | Upgrade to Locking Door | 40.00 | 00 |
| PBP-W | Plastic banner poles, white, 1 1/2" x 84" High (set of 2) | 65.00 | 02 |

* Packs in three PCB carry bags at \$65.00 ea or packs one per UF4325 case at \$330.00 ea

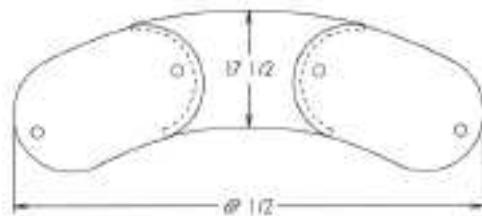

Multi-Cabinet, Kidney Shape, 36" High with Non-Locking Roll Doors, 3 sections

| | | | |
|---------|---|----------|----|
| ULKY110 | 36" High, curve fits all 8' and 10' popups | 1,127.00 | 44 |
| SULMKK | 29" x 17.5" Shelf kit with poles & support clips | 65.00 | 07 |
| ULRD | Upgrade per door to Locking Door(s) | 40.00 | 00 |
| PBP-W | Plastic banner poles, white, 1 1/2" x 84" High (set of 2) | 65.00 | 02 |

* Packs in three PCB carry bags at \$65.00 ea or packs one per UF4325 case at \$330.00 ea

COMPUTER CABINET

MULTI-CABINET

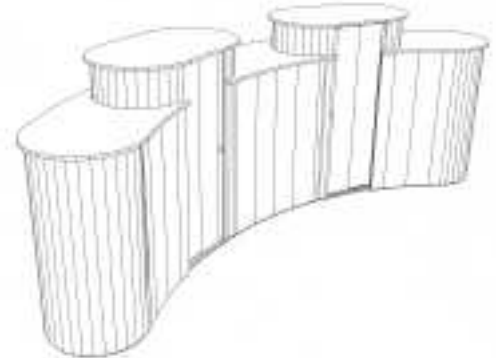
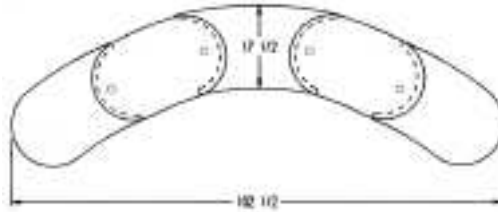

Multi-Cabinet, Kidney Shape 36" High with Non-Locking Roll Doors, 5 sections

| Order # | Description | Price | Weight |
|---------|---|----------|--------|
| ULKY120 | 36" High, curve fits all 8' and 10' popups | 1,865.00 | 73 |
| SULMKK | 29" x 17.5" Shelf kit with poles & support clips | 65.00 | 07 |
| ULRD | Upgrade per door to Locking Door(s) | 40.00 | 00 |
| PBP-W | Plastic banner poles, white, 1 1/2" x 84" High (set of 2) | 65.00 | 02 |

* Packs in four PCB carry bags at \$65.00 ea or packs two per UF4325 case at \$330.00 ea

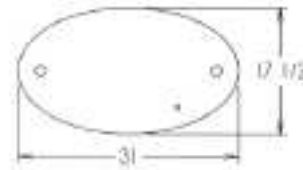
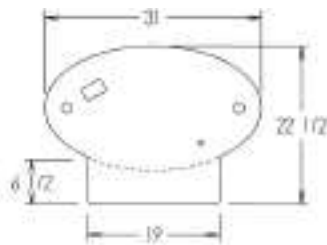

Computer Multi-Cabinet, Ellipse 36" High with Non-Locking Roll Door

| | | | |
|----------|---|--------|----|
| ULCSE-36 | 36" High | 442.00 | 16 |
| SULMEC | 31" x 22.5" Shelf kit with support clips | 47.00 | 07 |
| ULRD | Upgrade to Locking Door | 40.00 | 00 |
| PBP-W | Plastic banner poles, white, 1 1/2" x 84" High (set of 2) | 65.00 | 02 |

* Packs one per PCB carry bag at \$65.00 ea or packs two per UF4325 case at \$330.00 ea

Multi-Cabinet, Ellipse 18" x 31" x 36" High with Non-Locking Roll Door

| | | | |
|---------|---|--------|----|
| ULME-36 | 36" High | 379.00 | 15 |
| SULMEK | 31" x 22.5" Shelf kit with poles & support clips | 65.00 | 07 |
| ULRD | Upgrade to Locking Door | 40.00 | 00 |
| PBP-W | Plastic banner poles, white, 1 1/2" x 84" High (set of 2) | 65.00 | 02 |

* Packs one per PCB carry bag at \$65.00 ea or packs two per UF4325 case at \$330.00 ea

MULTI-CABINET

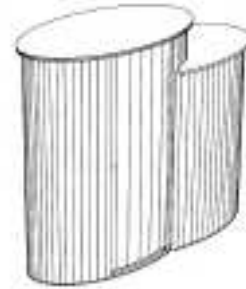
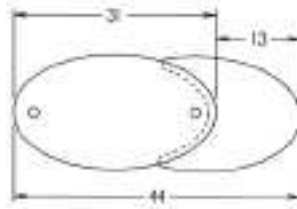

Multi-Cabinet, Ellipse 36" High with one extension & Non-Locking Roll Door, 2 sections

| Order # | Description | Price | Weight |
|---------|---|--------|--------|
| ULEY105 | 36" High | 697.00 | 29 |
| SULMEK | 31" x 22.5" Shelf kit with poles & support clips | 65.00 | 07 |
| ULRD | Upgrade to Locking Door | 40.00 | 00 |
| PBP-W | Plastic banner poles, white, 1 1/2" x 84" High (set of 2) | 65.00 | 02 |

* Packs in two PCB carry bags at \$65.00 ea or packs one per UF4325 case at \$330.00 ea

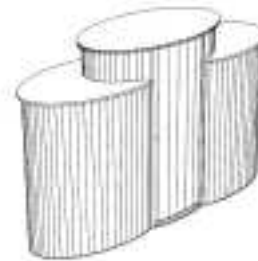
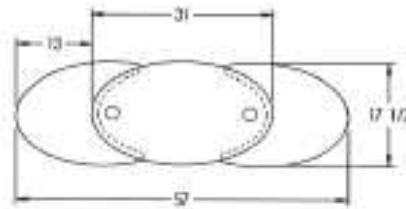

Multi-Cabinet, Ellipse 36" High with two extensions 30" High & Non-Locking Roll Door, 3 sections

| | | | |
|---------|---|----------|----|
| ULEY104 | 36" High | 1,015.00 | 43 |
| SULMEK | 31" x 22.5" Shelf kit with poles & support clips | 65.00 | 07 |
| ULRD | Upgrade to Locking Door | 40.00 | 00 |
| PBP-W | Plastic banner poles, white, 1 1/2" x 84" High (set of 2) | 65.00 | 02 |

* Packs in three PCB carry bags at \$65.00 ea or packs one per UF4325 case at \$330.00 ea

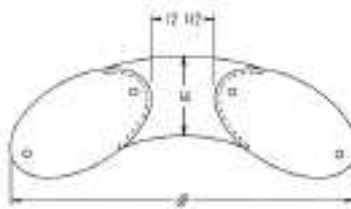

Two Connecting Multi-Cabinet Ellipse, 36" High with Non-Locking Roll Doors, 3 sections

| | | | |
|---------|---|----------|----|
| ULEY110 | 36" High | 1,127.00 | 44 |
| SULMEK | 31" x 22.5" Shelf kit with poles & support clips | 65.00 | 07 |
| ULRD | Upgrade per door to Locking Door(s) | 40.00 | 00 |
| PBP-W | Plastic banner poles, white, 1 1/2" x 84" High (set of 2) | 65.00 | 02 |

* Packs in three PCB carry bags at \$65.00 ea or packs one per UF4325 case at \$330.00 ea

MULTI-CABINET/KIOSK

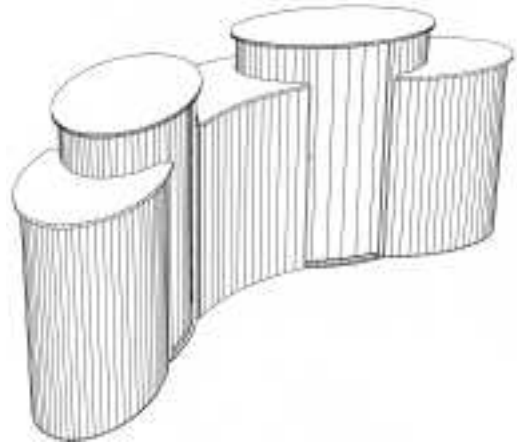
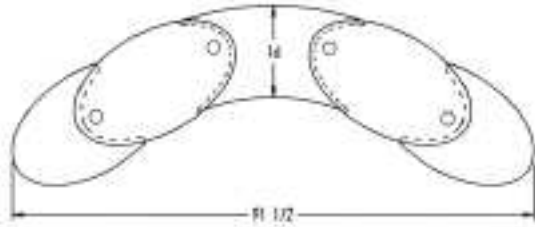

Two Connecting Multi-Cabinet Ellipse, 36" High with two extensions & Non-Locking Roll Doors, 5 sections

| Order # | Description | Price | Weight |
|---------|---|----------|--------|
| ULEY120 | 36" High | 1,763.00 | 72 |
| SULMEK | 31" x 22.5" Shelf kit with poles & support clips | 65.00 | 07 |
| ULRD | Upgrade per door to Locking Door(s) | 40.00 | 00 |
| PBP-W | Plastic banner poles, white, 1 1/2" x 84" High (set of 2) | 65.00 | 02 |

* Packs in four PCB carry bags at \$65.00 ea or packs two per UF4325 case at \$330.00 ea

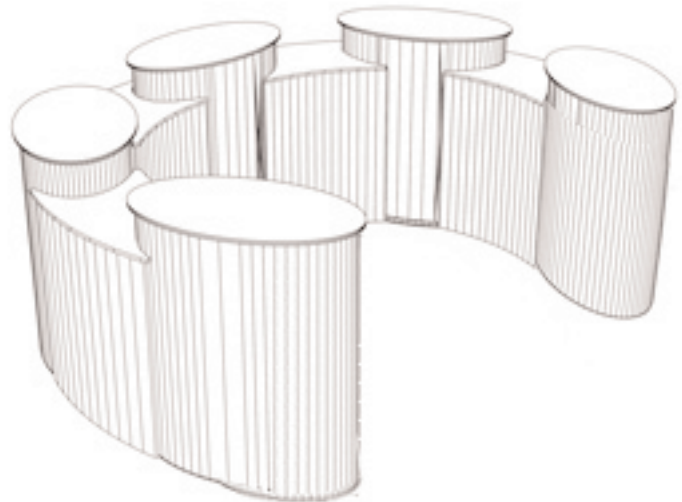
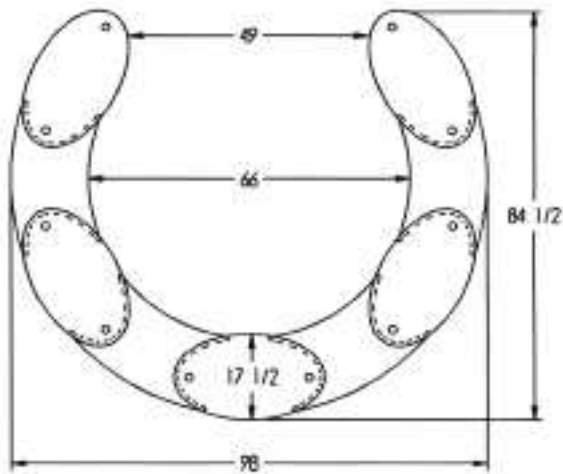

Five Ellipse Connecting Multi-Cabinet Kiosk with Non-Locking Roll Doors, 9 sections

| | | | |
|---------|---|----------|-----|
| ULEY500 | 36" High | 3,371.00 | 132 |
| SULMEK | 31" x 22.5" Shelf kit with poles & support clips | 65.00 | 07 |
| ULRD | Upgrade per door to Locking Door(s) | 40.00 | 00 |
| PBP-W | Plastic banner poles, white, 1 1/2" x 84" High (set of 2) | 65.00 | 02 |

* Packs in seven PCB carry bags at \$65.00 ea or and in three UF4325 cases at \$330.00 ea

Folding Curving Cabinet

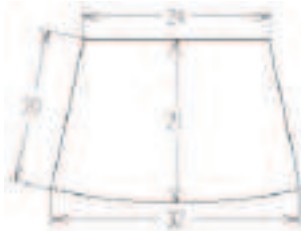
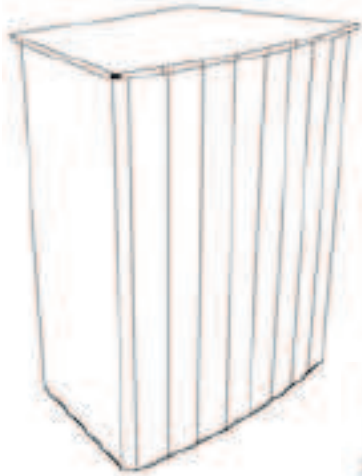

Folding Curving Cabinet 21" x 32" with Frontrunner or Prelude Fabric

| Order # | Description | Price | Weight |
|---------------|---|--------|--------|
| ULFC2132-36 | 36" High | 372.00 | 19 |
| ULFC2132-42 | 42" High | 372.00 | 21 |
| SULFCK | Cabinet Shelf with Support Clips | 35.00 | 03 |
| PCB | Polyester Cabinet Carry Bag (36" high cabinet only) | 65.00 | 03 |
| PBP-W | Plastic banner poles, white, 1 1/2" x 84" High (set of 2) | 65.00 | 02 |

* Packs in one polyester carry bag at \$65.00 ea. (36" high cabinet only.) or packs two per UF4325 case at \$330.00 ea

Folding Curving Cabinet 21" x 32", Graphic Ready

| Order # | Description | Price | Weight |
|---------------|---|--------|--------|
| GRFC2132-36 | 36" High | 229.00 | 17 |
| GRFC2132-42 | 42" High | 229.00 | 18 |
| SULFCK | Cabinet Shelf with Support Clips | 35.00 | 03 |
| PCB | Polyester Cabinet Carry Bag (36" high cabinet only) | 65.00 | 03 |
| PBP-W | Plastic banner poles, white, 1 1/2" x 84" High (set of 2) | 65.00 | 02 |

* Packs in one polyester carry bag at \$65.00 ea. (36" high cabinet only.) or packs two per UF4325 case at \$330.00 ea

FABRICS: visit www.ultraform.com for samples

FrontRunner - 33 colors available
Prelude - 20 colors available

PEDESTAL CABINETS

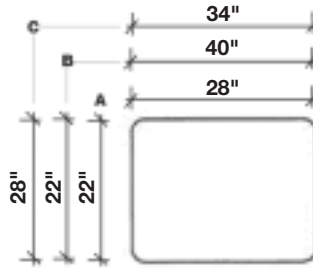

Rectangle Pedestal 22" x 28" *Dimensions A*

| Order # | Description | Suggested Rental Retail Price | Weight |
|-----------|-------------|-------------------------------|--------|
| R-2228-24 | 24" High | 203.00 | 55 |
| R-2228-33 | 33" High | 217.00 | 60 |
| R-2228-42 | 42" High | 232.00 | 61 |

* Price includes one required UF4325 shipping case.

* Note: These units can pack two per case. Please call for quote for multiple units.

Rectangle Pedestal 22" x 40" *Dimensions B*

| | | | |
|-----------|-----------------------------|--------|----|
| R-2240-33 | 33" High with support poles | 259.00 | 70 |
| R-2240-42 | 42" High with support poles | 279.00 | 76 |

* Price includes one required UF4325 shipping case.

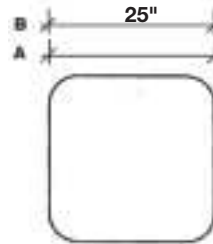

Square Pedestal 25" x 25" *Dimensions B*

| | | | |
|-----------|----------|--------|----|
| R-2525-24 | 24" High | 203.00 | 58 |
| R-2525-33 | 33" High | 217.00 | 64 |
| R-2525-42 | 42" High | 232.00 | 64 |

* Price includes one required UF4831 shipping case.

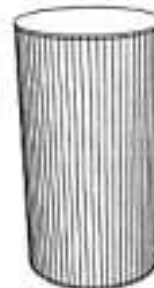
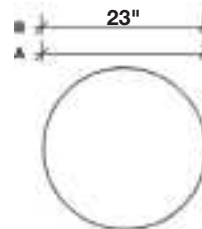

Round Pedestal 23" diameter *Dimensions B*

| | | | |
|----------|----------|--------|----|
| R-R23-33 | 33" High | 193.00 | 49 |
| R-R23-42 | 42" High | 205.00 | 54 |

* Price includes one required UF4325 shipping case.

* Note: These units can pack two per case. Please call for quote for multiple units.

PEDESTAL CABINETS

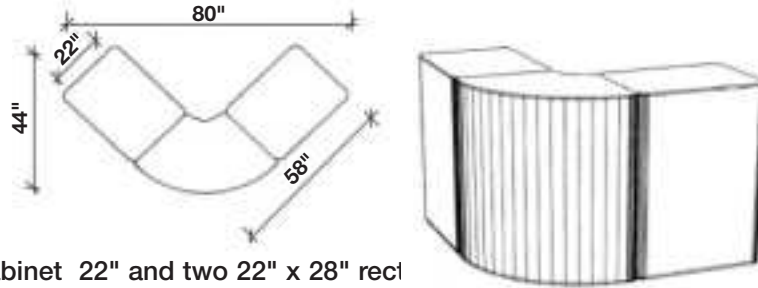

Three Cabinet Corner Set: corner cabinet 22" and two 22" x 28" rect

| Order # | Description | Suggested Rental Price | Retail Price | Weight |
|----------|-------------|------------------------|--------------|--------|
| R-SHY400 | 42" High | 613.00 | | 155 |

* Price includes two required UF4325 shipping cases.

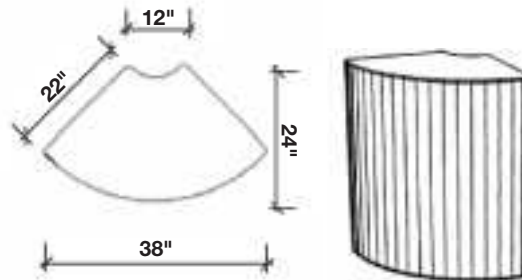

Corner Cabinet 22"

| | | | | |
|------------|----------|--------|--|----|
| R-COR22-33 | 33" High | 217.00 | | 60 |
| R-COR22-42 | 42" High | 232.00 | | 61 |

* Price includes one required UF4325 shipping case.

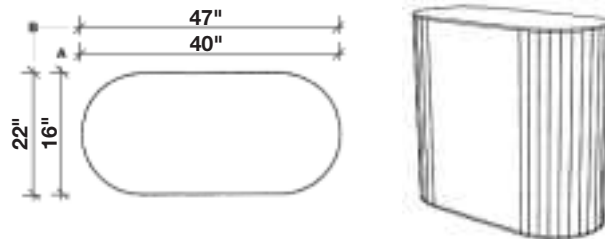

Oval Pedestal 16" x 40" Dimensions A

| | | | | |
|------------|----------|--------|--|----|
| R-O1640-24 | 24" High | 203.00 | | 55 |
| R-O1640-33 | 33" High | 217.00 | | 60 |
| R-O1640-42 | 42" High | 232.00 | | 61 |

* Price includes one required UF4325 shipping case.

* Note: These units can pack two per case. Please call for quote for multiple units.

Oval Pedestal 22" x 47" Dimensions B

| | | | | |
|------------|-----------------------------|--------|--|----|
| R-O2247-33 | 33" High with support poles | 259.00 | | 72 |
| R-O2247-42 | 42" High with support poles | 279.00 | | 79 |

* Price includes one required UF4825 shipping case.

PEDESTAL CABINETS

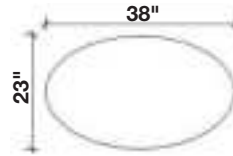

Ellipse Pedestal 23" x 38"

| Order # | Description | Detail Price | Weight |
|------------|-------------|--------------|--------|
| R-E2338-24 | 24" High | 206.00 | 55 |
| R-E2338-33 | 33" High | 220.00 | 60 |
| R-E2338-42 | 42" High | 235.00 | 61 |

* Price includes one required UF4325 shipping case.

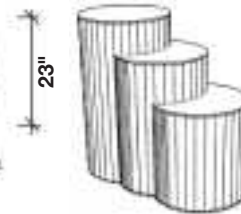
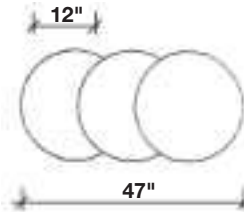

Three Cabinet Set Round 23" diameter with two crescents

| | | | |
|---------|--------------------|--------|----|
| R-CA323 | 42", 33", 24" High | 359.00 | 86 |
|---------|--------------------|--------|----|

* Price includes one required UF4325 shipping case.



Round 31" Conference Table on 16" round base

| | | | |
|------------|----------|--------|----|
| R-CTR31-29 | 29" High | 169.00 | 48 |
| R-CTR31-42 | 42" High | 176.00 | 51 |

* Price includes one required UF4831 shipping case.

* Note: These units can pack two per case. Please call for quote for multiple units.

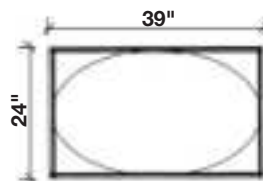

Locking Jewelry Case 24" x 39" x 7" high on 33" high elliptical base--40" overall, Acrylic w/abrasion resistant coating and black anodized aluminum frame

| | | | |
|-----------|---|--------|----|
| R-LJ7-40E | 40" High on elliptical base with showcase light | 507.00 | 99 |
| R-LJ7 | 7" High (No base)--with showcase light | 383.00 | 74 |

* Price includes one required UF4325 shipping case.

COMPUTER STANDS

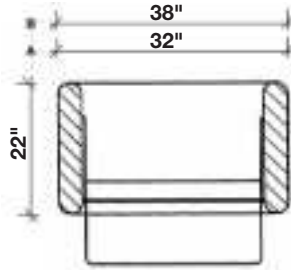

MULTI-STANDS

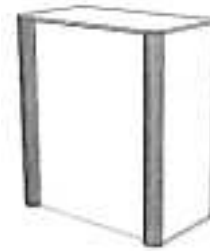

Rectangular Computer Stand 22" x 32"--open back *Dimensions A*

| Order # | Description | Suggested Rental Price | Retail Price | Weight |
|-------------|--|------------------------|--------------|--------|
| R-CS2232-42 | 42" High with one inside shelf, keyboard pullout and grommet | 322.00 | | 77 |
| 24LD | Locking door | 57.00 | | 12 |

* Price includes one required UF4325 shipping case.

Rectangular Multi-Stand 22" x 32"--open back *Dimensions A*

| | | | | |
|-------------|-------------------------------|--------|--|----|
| R-MB2232-42 | 42" High, no options included | 286.00 | | 68 |
| SM1424 | 14" x 24" Shelf | 11.00 | | 04 |
| 24LD | Locking door | 57.00 | | 12 |

* Price includes one required UF4325 shipping case.

Rectangular Computer Stand 22" x 38"--open back *Dimensions B*

| | | | | |
|-------------|--|--------|--|----|
| R-CS2238-42 | 42" High with one inside shelf, keyboard pullout and grommet | 322.00 | | 86 |
| 30LD | Locking door | 57.00 | | 13 |

* Price includes one required UF4831 shipping case.

Rectangular Multi-Stand 22" x 38"--open back *Dimensions B*

| | | | | |
|-------------|-------------------------------|--------|--|----|
| R-MB2238-42 | 42" High, no options included | 286.00 | | 74 |
| SM1430 | 14" x 30" Shelf | 11.00 | | 04 |
| 30LD | Locking door | 57.00 | | 13 |

* Price includes one required UF4831 shipping case.

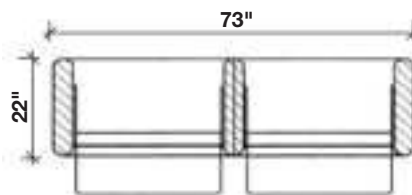
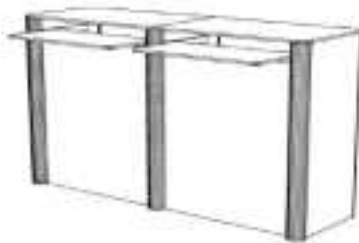

Rectangular Computer Stand 22" x 73", 2 sections --open back

| | | | | |
|-------------|--|--------|--|-----|
| R-CS2273-42 | 42" High with two inside shelves, keyboard pullouts and grommets | 585.00 | | 157 |
| 30LD | Locking door | 57.00 | | 13 |

* Price includes two required (one UF4831 case and one UF4825 case) shipping cases.

Rectangular Multi-Stand 22" x 73", 2 sections --open back

| | | | | |
|-------------|-------------------------------|--------|--|-----|
| R-MB2273-42 | 42" High, no options included | 514.00 | | 135 |
| SM1430 | 14" x 30" Shelf | 11.00 | | 04 |
| 30LD | Locking door | 57.00 | | 13 |

* Price includes two required UF4831 shipping cases.

COMPUTER STANDS

MULTI-STANDS

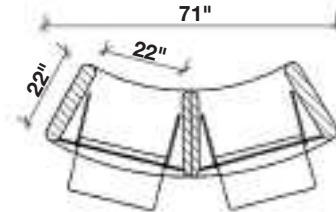
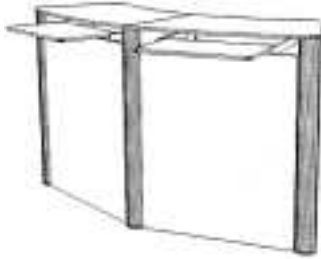

Curving Computer Stand 22" x 71", 2 sections --open back

| Order # | Description | Suggested Rental Retail Price | Weight |
|--------------|--|-------------------------------|--------|
| R-CSC2271-42 | 42" High with two inside shelves, keyboard pullouts and grommets | 585.00 | 166 |
| 22LDC | Locking door | 57.00 | 12 |

* Price includes two required UF4831 shipping cases.

Curving Multi-Stand 22" x 71", 2 sections --open back

| | | | |
|--------------|-------------------------------|--------|-----|
| R-MBC2271-42 | 42" High, no options included | 514.00 | 138 |
| SMC1430 | 14" x 30" Curving shelf | 11.00 | 05 |
| 22LDC | Locking door | 57.00 | 12 |

* Price includes two required UF4831 shipping cases.

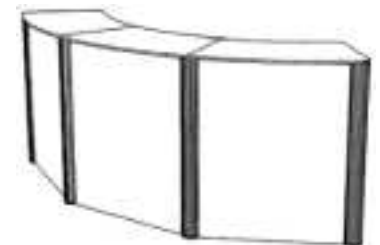
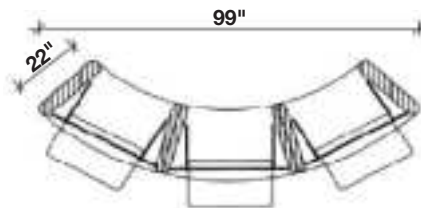

Curving Computer Stand 22" x 99", 3 sections --open back

| | | | |
|--------------|--|--------|-----|
| R-CSC2299-42 | 42" High with three inside shelves, keyboard pullouts and grommets | 840.00 | 242 |
| 22LDC | Locking door | 57.00 | 12 |

* Price includes three required UF4831 shipping cases.

Curving Multi-Stand 22" x 99", 3 sections --open back

| | | | |
|--------------|-------------------------------|--------|-----|
| R-MBC2299-42 | 42" High, no options included | 735.00 | 199 |
| SMC1430 | 14" x 30" Curving shelf | 11.00 | 05 |
| 22LDC | Locking door | 57.00 | 12 |

* Price includes three required UF4831 shipping cases.

COMPUTER STANDS

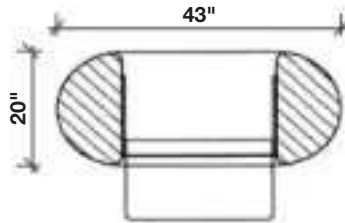

Oval Computer Stand 20" x 43"--open back

| Order # | Description | Suggested Rental Retail Price | Weight |
|--------------|--|-------------------------------|--------|
| R-CSO2043-42 | 42" High with one inside shelf, keyboard pullout and grommet | 322.00 | 81 |
| 24LD | Locking door | 57.00 | 12 |

* Price includes one required UF4825 shipping case.

Oval Multi-Stand 20" x 43"--open back

| | | | |
|--------------|-------------------------------|--------|----|
| R-OMB2043-42 | 42" High, no options included | 286.00 | 72 |
| SM1424 | 14" x 24" Shelf | 11.00 | 04 |
| 24LD | Locking door | 57.00 | 12 |

* Price includes one required UF4825 shipping case.

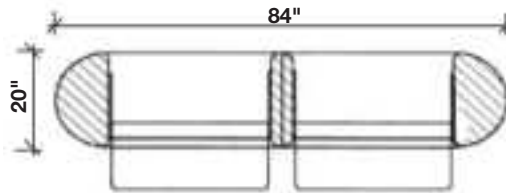

Oval Computer Stand 20" x 84", 2 sections --open back

| | | | |
|--------------|--|--------|-----|
| R-CSO2084-42 | 42" High with two inside shelves, keyboard pullouts and grommets | 583.00 | 156 |
| 30LD | Locking door | 57.00 | 13 |

* Price includes two required (one UF4331 case and one UF4825 case) shipping cases.

COMPUTER STANDS

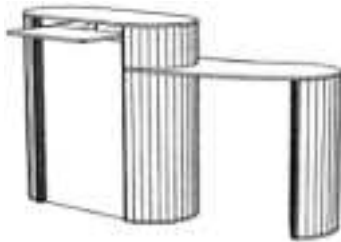

CSY105R

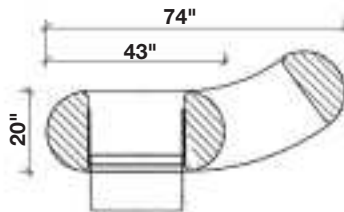

MULTI-STANDS



HY105R

Bi-Level Oval Computer Stand 20" x 43", 2 sections --open back, with one curving extension

| Order # | Description | Suggested Rental | Retail Price | Weight |
|-----------|---|------------------|--------------|--------|
| R-CSY105R | 42" High with right extension at 33" high, one inside shelf, keyboard pullout and grommet | 444.00 | | 105 |
| R-CSY105L | 42" High with left extension at 33" high, one inside shelf, keyboard pullout and grommet | 444.00 | | 105 |
| 24LD | Locking door | 57.00 | | 12 |

* Price includes one required UF4825 shipping case.

Bi-level Oval Multi-Stand 20" x 43", 2 sections --open back, with one curving extension

| | | | | |
|----------|--|--------|--|----|
| R-HY105R | 42" High with right extension at 33" high, no options included | 409.00 | | 96 |
| R-HY105L | 42" High with left extension at 33" high | 409.00 | | 96 |
| SM1424 | 14" x 24" Shelf | 11.00 | | 04 |
| 24LD | Locking door | 57.00 | | 12 |

* Price includes one required UF4825 shipping case.

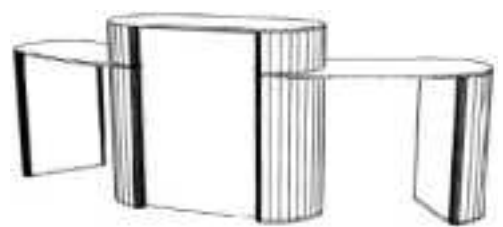
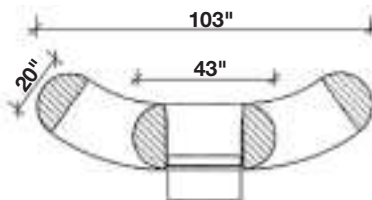
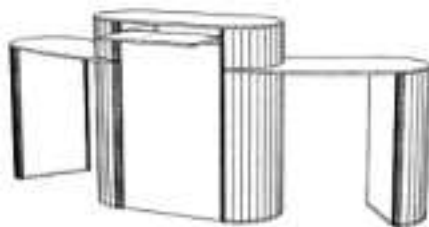

Bi-Level Oval Computer Stand 20" x 43", 3 sections --open back, with two curving extensions

| | | | | |
|----------|--|--------|--|-----|
| R-CSY104 | 42" High with extensions at 33" high, one inside shelf, keyboard pullout and grommet | 650.00 | | 160 |
| 24LD | Locking door | 57.00 | | 12 |

* Price includes two required UF4825 shipping cases.

Bi-Level Oval Multi-Stand 20" x 43", 3 sections --open back, with two curving extensions

| | | | | |
|---------|---|--------|--|-----|
| R-HY104 | 42" High with extensions at 33" high, no options included | 614.00 | | 150 |
| SM1424 | 14" x 24" Shelf | 11.00 | | 04 |
| 24LD | Locking door | 57.00 | | 12 |

* Price includes two required UF4825 shipping cases.

COMPUTER PEDESTALS

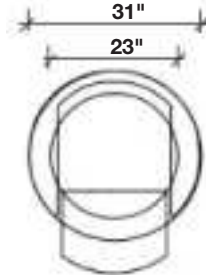

Round 31" Computer Pedestal on 23" round base

| Order # | Description | Suggested Rental | Retail Price | Weight |
|---------|-------------|------------------|--------------|--------|
| R-CPR31 | 38" High | 334.00 | | 78 |

* Price includes one required UF4831 shipping case.

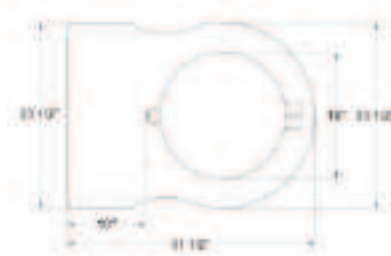

Round 23" Computer Pedestal with Monitor Riser

| | | | | |
|----------------|-----------------------------|--------|--|----|
| R-CPR23-36-6AR | 36" High with 6" High Riser | 241.00 | | 63 |
|----------------|-----------------------------|--------|--|----|

* Price includes one required UF4325 shipping case.

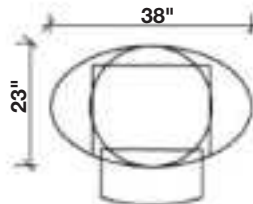

Ellipse Computer Pedestal on 23" round base

| | | | | |
|-----------|----------|--------|--|----|
| R-CPE2338 | 38" High | 334.00 | | 75 |
|-----------|----------|--------|--|----|

* Price includes one required UF4325 shipping case.

KIOSKS/TOWERS

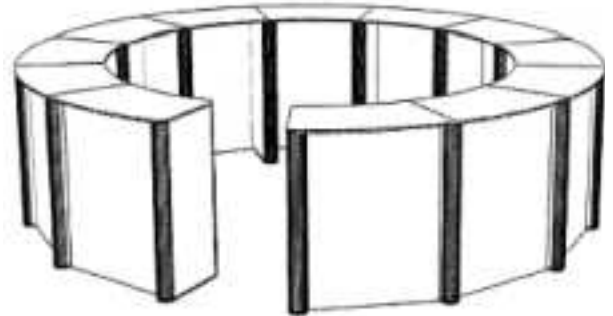
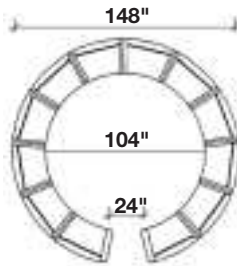

Curving Multi-Stand 22" x 148" , 12 sections -- open back

| Order # | Description | Suggested Rental | Retail Price | Weight |
|---------------|-------------------------|------------------|--------------|--------|
| R-MBC22148-42 | 42" High | 2,016.00 | | 471 |
| SMC1430 | 14" x 30" Curving shelf | 11.00 | | 05 |
| 22LDC | Locking door | 57.00 | | 12 |

* Price includes one required UF4848 jumbo shipping case -- additional cases required for options.

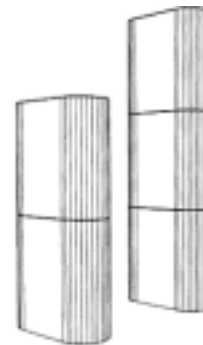
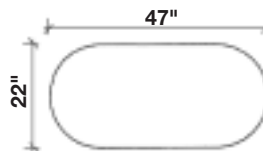

Oval Tower 22" x 47"

| | | | | |
|-------------|--|--------|--|-----|
| R-O2247-126 | 10' 6" High | 715.00 | | 171 |
| R-O2247-84 | 7' High | 452.00 | | 106 |
| LH100 | Halogen spotlight--100 Watt with pin mount | 38.00 | | 03 |

* Price includes required shipping case(s)--10'6" tower packs in two UF4825 cases; 7' tower packs in one UF4825 case.

* Additional shipping case required for lights. Call for quote.

TOWERS

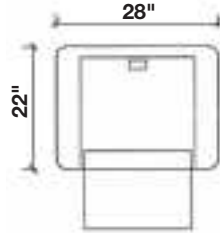

Rectangle Computer Monitor Stand 22" x 28"

R-MCC2228-64

| Order # | Description | Suggested Rental | Retail Price | Weight |
|--------------|---|------------------|--------------|--------|
| R-MCC2228-64 | 5' 4" High--Includes keyboard pullout and 1.5" x 3" rectangular wire management grommet | 565.00 | | 139 |

* Price includes two required UF4325 shipping cases.
* Refer to the Monitor Specs page R13

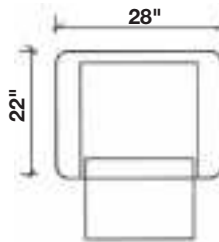

Rectangle Monitor Tower 22" x 28"

R-M2228-84

| | | | | |
|------------|--|--------|--|-----|
| R-M2228-84 | 7' High--Includes adjustable mask and inside shelf | 435.00 | | 102 |
|------------|--|--------|--|-----|

* Price includes one required UF4325 shipping case.
* Refer to the Monitor Specs page R13

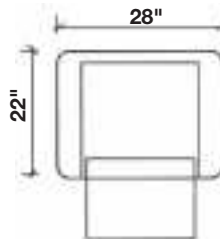

Rectangle Computer Monitor Tower 22" x 28"

R-MCC2228-82

| | | | | |
|--------------|---|--------|--|-----|
| R-MCC2228-82 | 6'10" High--Includes adjustable mask, inside shelf and keyboard pullout | 631.00 | | 149 |
|--------------|---|--------|--|-----|

* Price includes two required UF4325 shipping cases.
* Refer to the Monitor Specs page R13

RENTAL ACCESSORIES

Note: Doors and shelves listed as options with individual cabinets.

Literature Stand

| Order # | Description | Suggested Rental Retail Price | Weight |
|--------------|---|-------------------------------|--------|
| R-LS-HOR-BLK | Horizon (Black) Collapsible, cascading Literature dispenser | 99.00 | 18 |

* Image shown below

Support Poles

| | | | |
|----|---|--------|----|
| SP | Support poles -- specify cabinet height | 2.50ea | 00 |
|----|---|--------|----|

Keyboard Pullouts

| | | | |
|---------|-------------|-------|----|
| KBP-24 | 24" Wide | 20.00 | 07 |
| KBP-30 | 30" Wide | 20.00 | 07 |
| KBP-30C | 30" Curving | 20.00 | 09 |

Lights

| | | | |
|-------|--|-------|----|
| LH100 | Halogen spotlight -- 100 Watt with pin mount | 38.00 | 03 |
|-------|--|-------|----|

RENTAL SHIPPING CASES

Roto-Molded Shipper

| | | | |
|--------|--|--------|----|
| UF4325 | Case 43" x 25" -- 7"-13" Deep with wheels | 83.00 | 28 |
| UF4825 | Case 48" x 25" -- 7"-13" Deep with wheels | 83.00 | 30 |
| UF4831 | Case 48" x 31" -- 6"-10" Deep with wheels | 83.00 | 32 |
| UF4848 | Case 48" x 48" -- 25" Deep jumbo shipper (cannot ship via UPS) | 289.00 | 97 |



UF4325



UF4825



UF4831

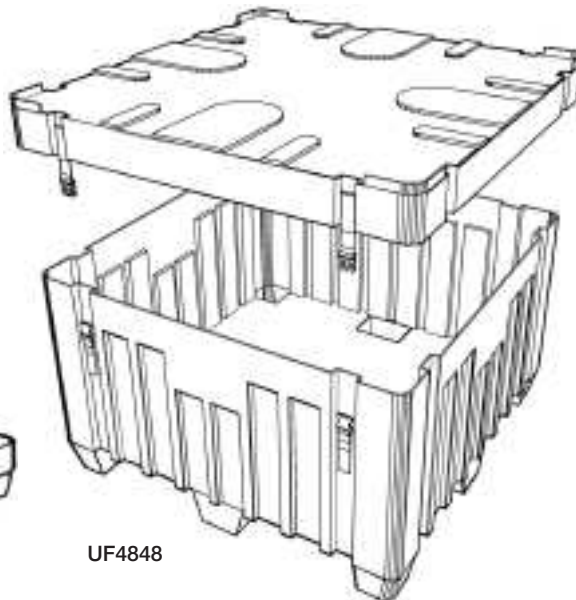

UF4848



R-LS-HOR-BLK

TERMS AND CONDITIONS OF RENTAL PROGRAM

EQUIPMENT

- a. Rental equipment may be selected from standard UltraForm equipment as described in the UltraForm Rental Price List.
- b. Rental inventory is limited and therefore subject to availability. A purchase order or valid written request must be received and confirmed to guarantee availability.
- c. All equipment available in FrontRunner Coal or Silver fabric with Wilsonart Graphite Nebula laminate tops.
- d. Shipping cases are required for all rentals. No rental equipment will be shipped without the required number of reusable shippers.

RENTAL PERIOD

The base rental period is 30 calendar days, being counted from the date of shipment from UltraForm to the date of return to UltraForm. (Weekends and holidays must be included.)

BASE CHARGES

- a. The dealer's rental price is based on the dealer's discount off of the suggested rental retail value of the equipment as listed in the UltraForm Rental Price List.
- b. Required cases are included in the suggested rental retail price. Options are in addition to the rented equipment.
- c. Base rental charges, plus estimated outbound freight, must be prepaid.
- d. UltraForm will provide a written confirmation of all charges prior to shipping.

EXTENDED RENTAL CHARGE

- a. Dealer may contract to use rental equipment beyond the 30 day rental period.
- b. Requests for additional days must be made at time purchase order is placed.
- c. Extended rental charges will be based on five-percent (5%) of the original rental price per additional day.

FREIGHT

- a. All outgoing freight charges are to be prepaid or billed direct to the dealer or enduser through the carrier.
- b. All return freight charges are the responsibility of the dealer.
- c. Any shipments returned to UltraForm on a collect or COD basis will be rebilled to the dealer. An additional 15% service charge will be included.
- d. See inside back cover of the UltraForm Rental Price List for a complete listing of Freight Terms & Responsibilities.

ADDITIONAL CHARGES AND LATE FEES

- a. All additional charges for rental beyond the contracted date will be invoiced and payable upon receipt.

- b. Additional charges include, but are not limited to, damaged equipment, missing equipment and freight charges.
- c. Late fees will be billed to the dealer and are based on a per-day basis.

CANCELLATION FEE

Any orders cancelled within 48 hours of a scheduled ship time will incur a charge equal to 10% of the total order cost, or a minimum of \$50. All cancellations must be in writing by fax, mail or email.

DAMAGES

- a. The dealer is responsible for reasonable use and safe return of the rented equipment in good condition to UltraForm's facility in Scottsville, NY.
- b. Dealer will be billed for damaged or loss of equipment, as determined by UltraForm System Cabinetry.
- c. Damage or loss will be defined as negligence by dealer or enduser to practice reasonable care in use or failure to follow repacking instructions for return shipment.
- d. Dealer will not be held accountable for damage incurred in transit by freight carriers if equipment is repacked properly. Dealer may be required to file for damage reimbursement, however.

ULTRAFORM CO-OP PURCHASE PLAN

Within 30 days following the return of the rental to UltraForm, the same dealer may purchase new UltraForm equipment the same as the equipment rented for the same enduser, with a portion of the dealer's rental charge being applied to the purchase.

DISCLAIMER OF WARRANTIES

Dealer and enduser acknowledge that the equipment is used and that the equipment is rented "as is." UltraForm makes no warranties, express or implied, concerning the property, including without limitation the warranty of fitness for a particular purpose or of merchantability. To the fullest extent permitted by law, dealer and enduser waive any claim (including any claim based on strict or absolute liability) they may have for any loss, damage (including incidental or consequential damage) or expense caused by the property.

UltraForm will make every effort to make delivery of equipment as designated by dealer or enduser. UltraForm will not be liable for any failure to deliver resulting from circumstances beyond its control. These include, but are not limited to, suppliers' failure to provide required materials, weather conditions, and errors in shipping by freight carriers.

MISCELLANEOUS

Dealer and enduser acknowledge acceptance of the terms of this agreement each time a purchase order is placed for use of UltraForm rental equipment. No terms of this Agreement may be amended without written authorization by UltraForm System Cabinetry.

Prices subject to change without notice.
All dimensions are approximate.

MONITOR TOWER SPECIFICATIONS

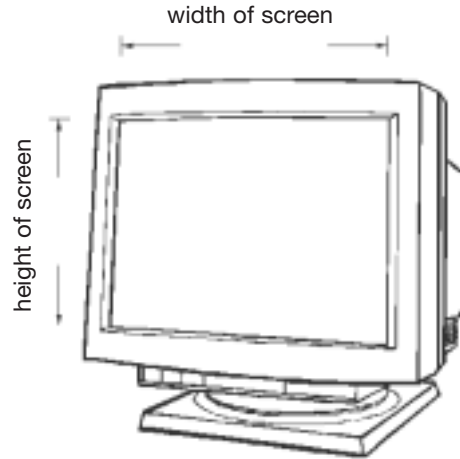

Window dimensions are needed to determine mask size.
Please provide the following dimensions with your purchase order.

1. width of screen: _____ "
2. height of screen: _____ "

** Note: Part with monitor opening (mask) may be purchased if exact dimensions are required. Please call for quote.*

We will supply a Standard size mask to Velcro into the panel to better fit the exact monitor dimensions (please specify which): 9-1/2"H x 17"W; 10-1/2"H x 12"W; 10-1/2"H x 13-1/2"W; or 12"H x 15-1/2"W.

If you are using a monitor that is larger than 14"H x 17"W, you will need to purchase a custom panel (Part No. 48SHJ-42W at \$267.00 retail). If you require a non-standard mask, order Part "MASK" and specify opening size - \$75.00 retail.

* Note: Case UF4848C not shown here.

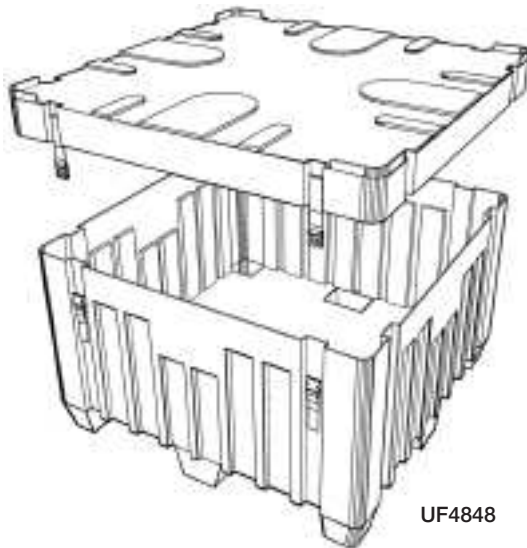

UF4848



PCB



UF4325



UF4331



UF4831

* Note: Case UF4831 does not have side handles



UF4825

SHIPPING CASES

Roto-Molded Shipper

| Order # | Description | Price | Weight |
|---------|---|----------|--------|
| UF4325 | Case *43" x 25" -- 7"-13" deep with wheels | 330.00 | 28 |
| UF4331 | Case *43" x 31" -- 7"-13" deep with wheels | 330.00 | 30 |
| UF4825 | Case *48" x 25" -- 7"-13" deep with wheels | 330.00 | 30 |
| UF4831 | Case *48" x 31" -- 6"-10" deep with wheels | 330.00 | 32 |
| UF4848 | Case *48" x 48" -- 25.5"-28.5" deep jumbo shipper (cannot ship via UPS) | 1,155.00 | 97 |
| UF4848C | Case *48" x 48" -- 25.5"-28.5" deep jumbo shipper with casters (cannot ship via UPS) | 1,320.00 | 100 |
| PCB | Peddler Carrying Bag with handle 37" x 23" x 5" | 65.00 | 04 |

* These are the interior dimensions

CASE OPTIONS

| | | | |
|-----------|--|---------|-----|
| CSS | Case strap: 1strap, 1 buckle, 2 rivets for UF4831, UF4825, UF4331 and UF4325 | 10.00 | 0.2 |
| WHEEL SET | Replacement wheel set-1 wheel, 1 bolt, 1 locknut for UF4831, UF4825, UF4331 and UF4325 | 8.00 | 0.2 |
| CASTOR | Castor for UF4848 | 23.00ea | 0.2 |
| CSSJ | Case strap for UF4848 | 9.00ea | 0.2 |

* Four CSS and CSSJ straps are needed for an entire case. (2 inside, 2 outside)



COLLAPSIBLE CASCADING LITERATURE DISPENSER



LS-HOR-BLK



LS-HOR-SLVR

Holds 250 sheets of standard weight 8.5" x 11" paper per pocket

| Order # | Description | Price | Weight |
|-------------|--|--------|--------|
| LS-HOR-BLK | Horizon (Black) Folding literature dispenser, with carrying bag | 378.00 | 18 |
| LS-HOR-SLVR | Horizon (Silver) Folding literature dispenser, with carrying bag | 378.00 | 18 |



ROLL-UP LITERATURE STANDS



LS-ROLL4



LS-ROLL8

Holds 50 sheets of standard weight 8.5" x 11" paper per pocket

| Order # | Description | Price | Weight |
|----------|--|--------|--------|
| LS-ROLL4 | Roll-Lit-Up literature stand, 4 pocket, includes carry bag | 196.00 | 05 |
| LS-ROLL8 | Roll-Lit-Up literature stand, 8 pocket, includes carry bag | 240.00 | 06 |



**UltraForm
System Cabinetry Inc.**
P.O. Box 1. 963 North Rd.
Scottsville, NY 14546



ACCESSORIES

Support Poles

| Order # | Description | Price | Weight |
|---------|--------------------------------------|---------|--------|
| SP | Support Poles-Specify cabinet height | 10.00ea | 00 |

Keyboard Pullouts

| | | | |
|---------|------------------------------|-------|----|
| KBP-24 | 24" Wide | 79.00 | 07 |
| KBP-30 | 30" Wide | 79.00 | 07 |
| KBP-22C | 22" Wide for curving cabinet | 79.00 | 10 |
| KBP-30C | 30" Wide for curving cabinet | 79.00 | 10 |

Wire Management Grommets - Installed

| | | | |
|-------|-----------------------|-------|----|
| WM15R | 1.5" Diameter round | 10.00 | 00 |
| WM153 | 1.5" x 3" Rectangular | 19.00 | 00 |

Lights

| | | | |
|-------|--------------------------------------|--------|----|
| LH100 | Halogen spotlight-100 Watt pin mount | 152.00 | 03 |
|-------|--------------------------------------|--------|----|

Replacement Bulbs

| | | | |
|--------|---|-------|----|
| LCB618 | Can light-60 Watt Halogen | 59.00 | 00 |
| LHB100 | Halogen lightbulb for LH100 Spot light-100 Watt | 28.00 | 00 |