

TOSHIBA
Leading Innovation >>>

REGZA

AV/RV Digital Series

This standard Owner's Manual is designed to show you how to connect and tune in your Toshiba television and to operate the most commonly used functions.

If you want to view advanced functions for your television you can do so by visiting www.toshiba-om.net

Toshiba estimates that the initiative of making the extended functions available online rather than in this book will save over 20,000 trees per year (1.5 Million kg CO²)*.

**If you wish to view the extended functions but do not have access to a computer or the internet then please contact your local Owner's Manual Helpline number.
(Contact details are shown on the back of this book).**

Safety Precautions

This equipment has been designed and manufactured to meet international safety standards but, like any electrical equipment, care must be taken to obtain the best results and for safety to be assured. Please read the points below for your own safety. They are of a general nature, intended to help with all electronic consumer products and some points may not apply to the goods you have just purchased.

Air Circulation

Leave more than 10cm clearance around the television to allow adequate ventilation. This will prevent overheating and possible damage to the television. Dusty places should also be avoided.

Heat Damage

Damage may occur if the television is left in direct sunlight or near a heater. Avoid places subject to extremely high temperatures or humidity. Place in a location where the temperature remains between 5°C (41°F) min. and 35°C (94°F) max.

Mains Supply

The mains supply required for this equipment is 220-240v AC 50/60Hz. Never connect to a DC supply or any other power source. DO ensure that the television is not standing on the mains lead. DO NOT cut off the mains plug from this equipment, this incorporates a special Radio Interference Filter, the removal of which will impair its performance.

In the UK, the fuse fitted in the plug is approved by ASTA or BSI to BS1362. It should only be replaced by a correctly rated and approved type and the fuse cover must be refitted.

IF IN DOUBT PLEASE CONSULT A COMPETENT ELECTRICIAN.

Do

DO read the operating instructions before you attempt to use the equipment.

DO ensure that all electrical connections (including the mains plug, extension leads and inter-connections between pieces of equipment) are properly made and in accordance with the manufacturers' instructions. Switch off and withdraw the mains plug before making or changing connections.

DO consult your dealer if you are ever in doubt about the installation, operation or safety of your equipment.

DO be careful with glass panels or doors on equipment.

DO NOT REMOVE ANY FIXED COVERS AS THIS WILL EXPOSE DANGEROUS AND 'LIVE' PARTS.

THE MAINS PLUG IS USED AS A DISCONNECTING DEVICE AND THEREFORE SHOULD BE READILY OPERABLE.

Do not

DO NOT obstruct the ventilation openings of the equipment with items such as newspapers, tablecloths, curtains, etc. Overheating will cause damage and shorten the life of the equipment.

DO NOT allow electrical equipment to be exposed to dripping or splashing or objects filled with liquids, such as vases, to be placed on the equipment.

DO NOT place hot objects or naked flame sources, such as lighted candles or nightlights on, or close to equipment. High temperatures can melt plastic and lead to fires.

DO NOT use makeshift stands and NEVER fix legs with wood screws. To ensure complete safety, always fit the manufacturers' approved stand, bracket or legs with the fixings provided according to the instructions.

DO NOT leave equipment switched on when it is unattended, unless it is specifically stated that it is designed for unattended operation or has a standby mode. Switch off by withdrawing the plug, make sure your family know how to do this. Special arrangements may need to be made for people with disabilities.

DO NOT continue to operate the equipment if you are in any doubt about it working normally, or it is damaged in any way – switch off, withdraw the mains plug and consult your dealer.

WARNING – excessive sound pressure from earphones or headphones can cause hearing loss.

ABOVE ALL – NEVER let anyone, especially children, push or hit the screen, push anything into holes, slots or any other openings in the case.

NEVER guess or take chances with electrical equipment of any kind – it is better to be safe than sorry.

Installation and important information

Where to install

Locate the television away from direct sunlight and strong lights, soft, indirect lighting is recommended for comfortable viewing. Use curtains or blinds to prevent direct sunlight falling on the screen.

Place the TV on a stable, level surface that can support the weight of the TV. As an additional safety measure you can secure the TV to the level surface or a wall, as shown in the illustration, using a sturdy strap.

The LCD display panels are manufactured using an extremely high level of precision technology, however sometimes some parts of the screen may be missing picture elements or have luminous spots. This is not a sign of a malfunction.

Make sure the television is located in a position where it cannot be pushed or hit by objects, as pressure will break or damage the screen, and that small items cannot be inserted into slots or openings in the case.

Cleaning the screen and cabinet...

Turn off the power, clean the screen and cabinet with a soft, dry cloth. We recommend that you **do not** use any proprietary polishes or solvents on the screen or cabinet as this may cause damage.

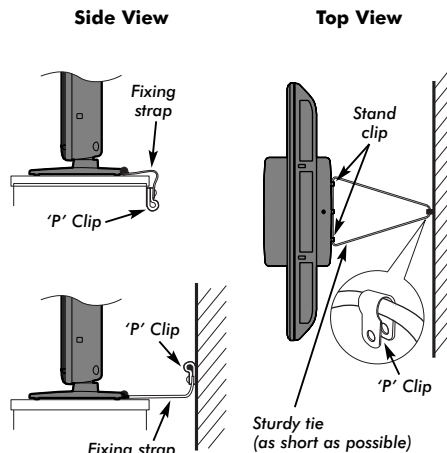

Please take note

The digital reception function of this television is only effective in the countries listed in the "COUNTRY SET UP" section of the "DIGITAL MENU". Depending on country/area some of this television's functions may not be available. Reception of future additional or modified services can not be guaranteed with this television.

If stationary images generated by 4:3 broadcasts, text services, channel identification logos, computer displays, video games, on screen menus, etc. are left on the television screen for any length of time they could become conspicuous, it is always advisable to reduce both the brightness and contrast settings.

Very long, continuous use of the 4:3 picture on a 16:9 screen may result in some retention of the image at the 4:3 outlines, this is not a defect of the LCD TV and is not covered under the manufacturers warranty. Regular use of other size modes (eg. Superlive) and varying the "side panel" brightness (if available on the model) will prevent permanent retention.

EXCLUSION CLAUSE

Toshiba shall under no circumstances be liable for loss and/or damage to the product caused by:

- i) fire;
- ii) earthquake;
- iii) accidental damage;
- iv) intentional misuse of the product;
- v) use of the product in improper conditions;
- vi) loss and/or damage caused to the product whilst in the possession of a third party;
- vii) any damage or loss caused as a result of the owner's failure and/or neglect to follow the instructions set out in the owner's manual;
- viii) any loss or damage caused directly as a result of misuse or malfunction of the product when used simultaneously with associated equipment;

Furthermore, under no circumstances shall Toshiba be liable for any consequential loss and/or damage including but not limited to the following, loss of profit, interruption of business, the loss of recorded data whether caused during normal operation or misuse of the product.

NOTE: A Toshiba wall bracket or stand, where available, must be used to maintain the product's BEAB approval.

Digital switchover

When does switchover happen?



Television in the UK is going digital, bringing us all more choice and new services. Starting in late 2007 and ending in 2012, television services in the UK will go completely digital, TV region by TV region.

Please see above to find out when your area switches to digital.

Digital UK is the independent, non-profit organisation leading the process of digital TV switchover in the UK. Digital UK provides impartial information on what people need to do to prepare for the move to digital, and when they need to do it.

How the switchover affects your TV equipment:

Your new TV has a digital tuner built in, which means it is ready to receive the Freeview signal by simply plugging it into your aerial socket (check if you can get digital TV through your aerial now, or whether you'll have to wait until switchover, at www.digitaluk.co.uk).

When the TV switchover happens in your area, there are at least two occasions when you will need to re-tune your TV in order to continue receiving your existing TV channels, and also to pick up new ones, Digital UK, the body leading the digital TV switchover, will advise you when you need to re-tune during the switchover.

If you choose to connect your TV to satellite or cable with a digital box then it will not be affected by switchover, and you won't need to re-tune.

Keep this important information about how to re-tune your TV during the TV switchover

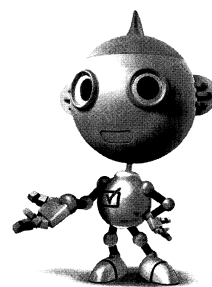

get set for digital

How to re-tune:

As new services are broadcast it will be necessary to re-tune the television in order to view them. **Auto tuning** will completely retune the television and can be used to update the channel list.

- 1 Press **MENU** button on the remote control unit. Select Auto tuning option.
- 2 A screen will appear warning that previous digital programmes and settings will be deleted.

You must allow the television to complete the search.....

When the search is complete the **Auto tuning** screen will display the total number of service found.

NOTE: Further detailed instructions on **Auto tuning** can be found in the TV owners manual.

If you are missing channels, it may be that they are not available in your area, or that your aerial needs upgrading.

*If you have any further questions, please contact your equipment supplier or call Digital UK on **08456 50 50 50** or visit www.digitaluk.co.uk*

The remote control

Simple at-a-glance reference of your remote control.

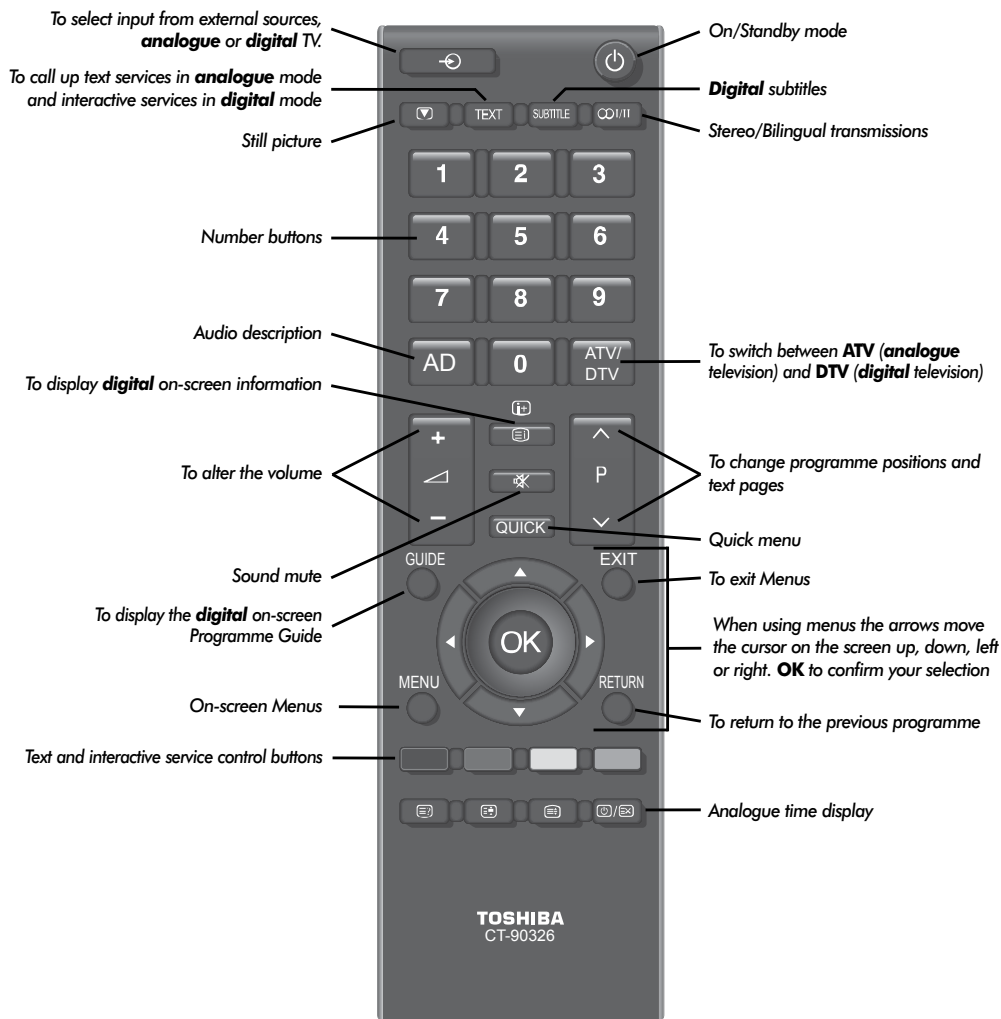

Inserting batteries and effective range of the remote



Remove the back cover to reveal the battery compartment and make sure the batteries are inserted the right way round. Suitable battery types for this remote are AAA, IEC R03 1.5V.

Do not combine a used, old battery with a new one or mix battery types. Remove dead batteries immediately to prevent acid from leaking into the battery compartment. Dispose of them in accordance with the disposal instructions in this manual. **Warning:** batteries must not be exposed to excessive heat such as sunshine, fire or the like.

The performance of the remote control will deteriorate beyond a distance of five metres or outside an angle of 30 degrees from the centre of the television. If the operating range becomes reduced the batteries may need replacing.

Connecting external equipment

Before connecting any external equipment, turn off all main power switches. If there is no switch remove the mains plug from the wall socket.

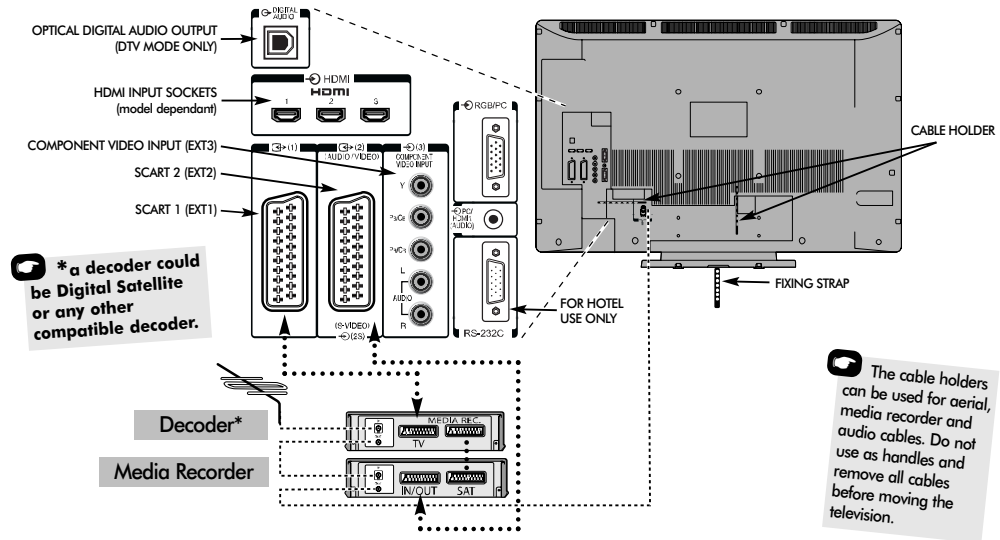

Aerial cables: --- --- ---
 Connect the aerial to the socket on the rear of the television. If you use a decoder* and/or a media recorder it is essential that the aerial cable is connected through the decoder and/or through the media recorder to the television.

SCART leads:
 Connect the video recorder **IN/OUT** socket to the television. Connect the decoder **TV** socket to the television. Connect the media recorder **SAT** socket to the decoder **MEDIA REC.** socket.

Before running **Auto tuning** put your decoder and media recorder to **Standby**.

The phono sockets alongside the COMPONENT VIDEO INPUT sockets will accept L and R audio signals.

The Digital Audio Output socket enables the connection of a suitable surround sound system. **NOTE: this output is always active.**

HDMI (High-Definition Multimedia Interface) is for use with a DVD, decoder or electrical equipment with digital audio and video output. It is designed for best performance with 1080i and 1080p high-definition video signals but will also accept and display VGA, 480i, 480p, 576i, 576p and 720p signals.

PLEASE NOTE: Although this television is able to connect to HDMI equipment it is possible that some equipment may not operate correctly.

A wide variety of external equipment can be connected to the back of the television, therefore the relevant owners manuals for all additional equipment must be referred to.

We recommend **SCART 1** for a decoder and **SCART 2** for a media recorder.

If connecting S-VIDEO equipment, set the **INPUT** for **EXT2**. See page 31.

If the television automatically switches over to monitor external equipment, return to normal television by pressing the desired programme position button. To recall external equipment, press **↺** to select between **TV, EXT1, EXT2, EXT3C, HDMI1, HDMI2, HDMI3, HDMI4** or **PC**.

HDMI HDMI, the HDMI logo and High-Definition Multimedia Interface are trademarks or registered trademarks of HDMI Licensing, LLC.

Using the Controls

Whilst all the necessary adjustments and controls for the television are made using the remote control, the buttons on the television may be used for some functions.

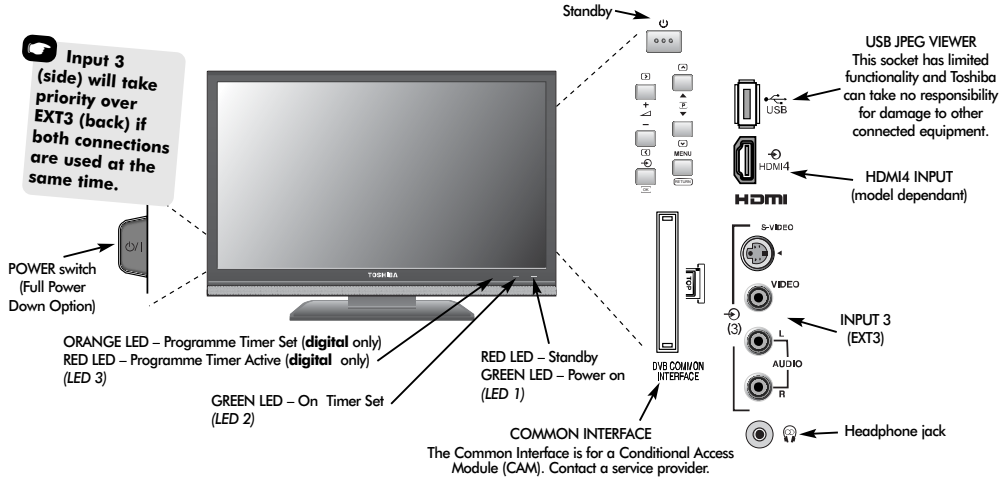

Switching On

If the RED LED is unlit check that the mains plug is connected to the power supply and press the **POWER** button on the left side of the television. If the picture does not appear press **POWER** on the remote control, it may take a few moments, the GREEN LED will be lit.

To put the television into Standby press **POWER** on the remote control. To view the television press **POWER** again. The picture may take a few seconds to appear.

NOTE: When the **POWER** switch is turned off, the digital channel position you previously viewed may not be memorised in the television memory.

Using the Remote Control

Press the **MENU** button on the remote control to see the menus.

The menu appears as a list of five topics. As each symbol is selected by pressing **Left** or **Right** on the navigation ring on the remote control, its respective options will appear below.

IMPORTANT: At the bottom of the screen will be a bar displaying a selection of control functions, i.e. Select, Watch, Back, Watch TV.

NOTE: The same menu is displayed in **DTV** (Digital TV) and **ATV** (Analogue TV) modes, however, where some items are not available in a mode they will appear greyed out.

To use the options press the **Up** and **Down** button on the remote control to move up and down through them and **OK**, **Left** or **Right** to select the required choice. Follow the on screen instructions. The functions of each menu are described in detail throughout the manual.

Using the Controls

To alter the volume press **Volume Down** or **Volume Up**.

To alter the programme position press **Previous** or **Next**.

Press **MENU** and **Left**, **Right**, **Down** or **Up** to control the sound and picture options.

Press **MENU** to finish.

When connecting sound equipment to **EXT3**, connect the audio output of the equipment to the phono sockets on the television.

To select the external input, press **Input** and select the required input source.

Please always refer to the owner's manual of the equipment to be connected for full details.









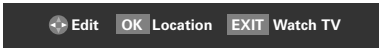
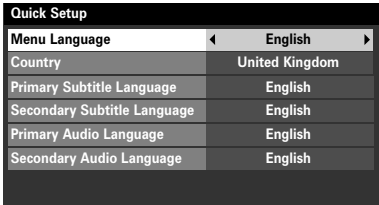



Please note: Inserting the headphone plug will mute the sound from all speakers.

Tuning the television for the first time

Before switching on the television put your decoder and media recorder to **Standby** if they are connected and ensure the aerial is connected. To set up the television use the buttons on the remote control as detailed on page 5.

- 1 Press the  button, the **Quick Setup** screen will appear. This screen will appear the first time that the television is switched on and each time **Reset TV** is selected.



- 2 Using  highlight **Menu Language**, then  or  to select.
- 3 Press  to highlight **Country** and  or  to select. The television will now tune the stations for your country. Press **OK**.
- 4 The **Location** screen will appear, press  or  to select between **Home** or **Store** (for normal home use select **Home**) then press **OK**.
- 5 The **Ant/Cable In** screen will appear, press  or  to select between **Antenna** or **Cable** then press **OK**.
- 6 The **Auto Tuning** start up screen will appear with the option to select between **DTV** and **ATV**, **DTV** or **ATV**. Using  or  select **ATV** and **DTV** then press  to highlight **Start Scan**.
- 7 Press **OK** again to start **Auto Tuning**. The television will start to search for all available **DTV** and **ATV** stations. The progress bar will indicate progress.

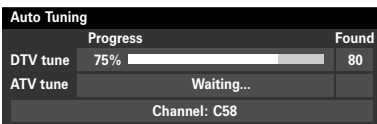

You must allow the television to complete the search.





When the search is complete the television will automatically select position one.

The **Auto Tuning** screen will display the total number of services found.



- 8 Press  or  to view the **DTV** (digital channels) or **ATV** (analogue channels) lists.



- 9 Use  or  to move through the list to select a channel then press **EXIT** to view.

In **ATV** mode some areas may receive duplicate stations. There may not be a clear picture or the signal may be weak, so the station order can be changed using **ATV Manual Tuning**.

NOTE: The time will be set automatically by transmission but can be advanced or decreased by up to 3 hours using **Local Time Settings** in the **DTV Settings** screen.

PLEASE NOTE

The **Reset TV** menu can also be accessed at any time from the **SETUP** menu.

General information

How to: add new services using Auto tuning, select programme positions and information, use the sound controls, select **DTV**, **ATV** and external equipment.

Auto Tuning

Auto tuning will completely re-tune the television and can be used to up date the channel list.

It is recommended that DTV Auto tuning is run periodically to ensure that new services are added.

All current programmes and settings, i.e. favourites and locked programmes, will be lost.

- 1 Press **MENU** and use ◀ or ▶ to select **SETUP**. Use ▼ to highlight **Ant/Cable In** and then ◀ or ▶ to select **Antenna** or **Cable**.
- 2 Use ▼ to highlight **Auto Tuning**. Press **OK**.

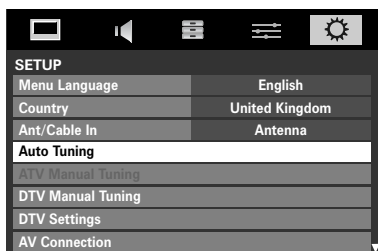

A screen will appear warning that previous digital channels and settings will be deleted.

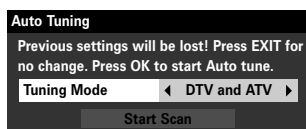

- 2 Use ◀ or ▶ to select **DTV** then press ▼ to select **Start Scan**, press **OK** to start **Auto tuning**.

The television will start to search for all available **DTV** stations.

You must allow the television to complete the search.

When the search is complete the **Auto Tuning** screen will display the services found.

- 3 Use ▼ or ▲ to move through the list to select a channel then press **OK** to view.

Selecting Programme Positions

To select a programme position use the numbered buttons on the remote control.

Programme positions can also be selected using **P▲** and **P▼**.

To revert to the previous programme position press **RETURN**.

To display on-screen information i.e. programme position, channels, stereo/mono signal, signal strength, date and time, press **(I+)**. Press again to cancel. The information shown will vary depending on whether the television is in **DTV** or **ATV** mode.

Press **ATV/DTV** at any time to select between **ATV**, **DTV Radio**, **DTV Data** and **DTV** modes.

Sound Controls

Volume

Press  or  to adjust the volume.

Sound Mute

Press  once to turn the sound off and again to cancel.

Input Selection

- 1 At any time by pressing  a list will appear on screen showing modes and all stored external equipment. Use ▼ and ▲ to highlight and **OK** to select.



For explanation of inputs please see specification page.

Features in brief

Listed below is a brief description of the some of the features available on this television. Full details of all the features and how to use them are in the enhanced Owner's Manual which is available to view, or if required download, from the Toshiba website at <http://toshiba-om.net>

Quick Menu

The Quick Menu gives fast access to various features, i.e. Picture Mode, Picture Size, Sleep Timer, Media Player etc. The availability of the various features is dependant on the current mode and input source.

Stable Sound®

The Stable sound feature limits high volume levels on the TV speakers, preventing the extreme changes in volume that can occur when channels are changed or a programme switches to a commercial.

Advanced Sound Settings

The Stereo Extension, Voice Enhancement and Dynamic Bass Boos features in the Advanced Sound Settings help to create an intense pseudo surround sound experience, making the television's audio sound richer and fuller.

Black/White Level

Black/White Level increases the strength of dark areas of the picture which improves the definition.

Cinema mode

If there are lines or jagged edges in the film or programme being viewed, selecting Cinema mode can help correct this by smoothing out the picture.

Base Colour Adjustment

The Base Colour Adjustment feature allows the adjustment of individual colours to suit personal preference. This can be useful when using an external source.

Static Gamma

The Static Gamma feature allows the adjustment of levels of black in the picture.

Resolution +

This features modifies SD quality pictures to HD quality levels, the levels can be selected for personal preference.

Programme Guide

The programme guide gives access to details and times on all available channels for programmes currently being shown and for the next seven days.

Automatic Format (Widescreen)

When this television receives a true Widescreen picture and Auto Format is On, it will automatically be displayed in Widescreen format, irrespective of the television's previous setting.

Side Panel Adjustment

The Side Panel feature lightens or darkens the band each side of the screen when in 4:3 or 14:9 format. This helps prevent image retention of the band and can also make viewing in bright or dark conditions more comfortable.

Favourite Programmes

Programme Options creates a list of the digital channels that are watched most. Four lists can be created, these can be a mixture of television and radio programmes.

Subtitles

When in digital mode this feature will show subtitles on the bottom of the screen in the selected language provided they are being broadcast.

Audio Languages

This feature allows a programme or film to be viewed with a choice of soundtrack language, provided they are currently being broadcast.

On-screen information

When viewing in digital mode, the on-screen information and programme guide give access to programme details for all available channels.

Information

- 1 Select information by pressing **(i+)**, the information screen will appear giving details of the channel and programme currently being viewed.



- 2 To see details of the next programme scheduled for the channel, press **▼** to select **Next**.
- 3 Press **▼** to select **Also**. Details of programmes that have started on other channels will be shown. Use **◀** or **▶** to change the display contents.
- 5 To set a reminder for the following programme, select **Next** then press **OK**. The **SET TIMER** screen will appear.



- 6 The details of the programme will have been added to the screen. Press **OK** to save. The timer icon will appear on the information screen.
- 7 To record the programme use **◀** or **▶** to change the **Timer Type** to **Record**. This will allow more options to be available. Press **▼** and **◀** or **▶** to select options. Press **OK** to save.

On-screen Information Icons

Icons will appear on the Information screen giving details about the programmes being broadcast. Details of these icons are listed below:

Service info

- Service type (TV, Radio)
- Skip
- Teletext

Audio Info

- Mono
- Stereo
- Dual mono

Audio/Subtitle info

- Hard of Hearing

Event Info

- SD Video format
- Video aspect
- Teletext
- Subtitle (Single, Multi)
- Multi-audio track
- Encrypted

Timer Info

- Timer status

Interactive Services

The **digital** interactive services are the up-to-date way of viewing service information, using computer-style formats, incorporating pictures and interactive views.

They offer high quality on-screen images with multi-colour photographic still images, advanced text and graphics and are user-friendly. These services are free to anyone with a digital television, however, they are not available for all digital stations and are dependant on the broadcaster.

- 1 Ensure that **digital** mode has been selected. Press the **RED** button or press **TEXT**, it may take a few moments to load.
- 2 To navigate the pages and use the pull-down menus, use the coloured buttons and **▲**, **▼**, **◀** and **▶** as directed.
- 3 Press **TEXT** again at any time to cancel.

Questions and Answers

Below are the answers to some of the most common queries.
For more information go to <http://toshiba-om.net>

Q Why is there no sound or picture?

A Check the television is not in standby mode. Check the mains plug and all mains connections.

Q There is a picture, but why is there little or no colour?

A When using an **external** source, for instance, a poor quality video tape, if there is little or no colour, improvements may sometimes be achieved. The colour is factory set to **Auto**, to automatically display the best colour system.

To check that you have the best colour:

- 1 With the external source playing, select **Manual Setting** from the **SETUP** menu.

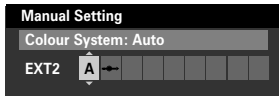

- 2 With **▲** or **▼** choose between **Auto**, **PAL**, **SECAM**, **NTSC 4.43** or **3.58**.

Q Why doesn't the media being played show on screen?

A Make sure the media player is connected to the television as shown on page 6, then select the correct input by pressing **↵**.

Q Why is the media picture in black and white?

A Check the correct **input** has been chosen, **S-VIDEO** or **AV**. See **Input selection** page 9.

Q Why doesn't the remote control work?

A Check the batteries aren't dead or inserted incorrectly.

Q Why is there a message permanently on the screen?

A Remove it by pressing **[i+]**.

Q Why is the **DTV** main menu unavailable?

A Another mode is selected. Press **ATV/DTV** to select **DTV**.

Q Why is there incorrect or no sound when in **DTV** mode?

A Press **ODI/II** to check if the hard of hearing option has been selected.

Q Why when **digital** subtitles have been selected are they not showing on screen?

A Subtitles are not currently being transmitted by the broadcaster.

Q Why is there no **digital** text service?

A The **digital** programme being viewed is not broadcasting digital text. Try another **digital** programme.

Q Why is there no sound or picture when in **HDMI** mode?

A Make sure that the cables used have the HDMI logo on them (**HDMI**). Some early HDMI equipment may not work properly with the latest HDMI television products, due to new standard adoption. Try setting **Lip Sync**, **Instaport** and **RGB Range** to **Off**.

Specifications and accessories

DVB-T Broadcast systems/channels

UK	UHF 21-68
France	VHF 05-10 (VHF 01-05) UHF 21-69
Germany	VHF 05-12 UHF 21-69
Austria	VHF 05-12 UHF 21-69
Switzerland	VHF 05-12 UHF 21-69
Italy	VHF 05-12 (D,E,F,G,H,H1,H2) UHF 21-69
Spain	UHF 21-69
Netherlands	VHF 05-12 UHF 21-69
Sweden	VHF 05-12 UHF 21-69
Finland	VHF 05-12 UHF 21-69
Greece	VHF 05-12 UHF 21-69

Video Input PAL, SECAM, NTSC 3.58/4.43

External connections

EXT1	Input/Output	21-pin SCART	RGB, A/V
EXT2	Input/Output	21-pin SCART	A/V, S-video Selectable output
EXT3	Input	Phono jacks Phono jacks	Y, P _B /C _B , P _R /C _R Audio L + R
EXT3	Input (Side)	Phono jacks Phono jacks	Video, S-Video Audio L + R
HDMI1/2/3	Input	HDMI (Audio LIP SYNC, Deep Colour supported)	
HDMI4	Input (Side)	HDMI (Audio LIP SYNC, Deep Colour supported)	
PC	Input	Mini D-sub 15-pin	Analog RGB signal
PC/HDMI1 Audio		3.5mm mini jack	Audio
Digital Audio Output (S/PDIF)		Optical	
USB Port		Interface version: USB2.0 USB class: Mass storage, PTP	

DVB is a registered trademark of the DVB Project

© Toshiba Information Systems (UK) Limited

All rights reserved.

Reproduction in whole or part without written permission is strictly prohibited.

Origination by Zushi Digital, Bristol, UK.

Broadcast systems/channels

PAL-I	UHF UK21-UK69
PAL-B/G	UHF E21-E69 VHF E2-E12, S1-S41
SECAM-L	UHF F21-F69 VHF F1-F10, B-Q
SECAM-D/K	UHF R21-R69 VHF R1-R12

Stereo

Nicam
2 carrier system

Visible Screen Size

(approx.) Model 32 A/RV 80cm
37 A/RV 94cm
42 A/RV 107cm

Display

16:9

Sound output (at 10% distortion)

Main 10W + 10W

Power consumption

(approx.) Model 32 AV 118W
37 AV 152W
42 AV 205W
Model 32 RV ???W
37 RV 124W
42 RV 144W

Standby (approx.)

Model 32 A/RV 0.8W
37 A/RV 0.8W
42 A/RV 0.8W

Dimensions

(approx.) Model 32 A/RV 57cm (H) 79cm (W) 26cm (D)
37 A/RV 64cm (H) 91cm (W) 26cm (D)
42 AV 69cm (H) 101cm (W) 27cm (D)
42 RV 70cm (H) 101cm (W) 31cm (D)
(Height dimension includes foot stand)

Weight (approx.)

Model 32 AV 12kg
37 AV 16kg
42 AV 20.5kg
32 RV 15.5kg
37 RV 19.5kg
42 RV 20.5kg

Headphone socket

3.5mm stereo

Accessories

Remote control
2 batteries
(AAA, IEC R03 1.5V)
Cleaning Cloth
P Clip

License Information used with Toshiba Televisions

To view the licenses for software used in this television, go to **Software Licenses** in the **SETUP** menu.

Toshiba Information Systems (UK) Limited

Consumer Products Division,
Toshiba Court, Weybridge Business Park,
Addlestone Road, Weybridge,
Surrey, KT15 2UL
England

Specification is subject to change without notice.

Country	Contact Number
Österreich	01 970210
Belgique / België	02 391 01 01
България	0294 21141
Hrvatska	01 653 9737
Κύπρος	22 872 111
Česká republika	323 204191
Danmark	0046 8 730 45 47
Eesti Vabariik	69 97 800
Suomen tasavalta	0046 8 730 45 47
France	09 69 32 64 84
Deutschland	0 18 05 66 00 55
Gibraltar	200 76334
Ελληνική Δημοκρατία	210 9554298
Magyar Köztársaság	23 428 870
Ísland	5207900
Yisra'el	03 953 5911
Italia	039 609 9301
Latvijas	00 372 69 97 800
Lietuvos	00 372 69 97 800
Luxembourg	00 32 2 391 01 01
Malta	663722
Nederlanden	00 32 2 391 01 01
Norge	23 03 75 75
Polska	0 71 796 95 05

Country	Contact Number
Portugal	707 265 265
Republic of Ireland	01 466 6858
România	021 3169 393
Российская Федерация	8495 6428920
Slovensko	0042 323 20419 1
España	902 33 22 34
Sverige	08 730 45 47
Schweiz / Suisse	044 949 22 11
Türkiye	0 212 340 6080
U.K.	0844 856 0730
Україна	8(044) 351 13 17

Remember...

For television operation queries, please ring the helpline...



0844 856 0730

UK ONLY

DISPOSAL...

The following information is only for EU-member states:

Disposal of products

The crossed out wheeled dust bin symbol indicates that products must be collected and disposed of separately from household waste. Integrated batteries and accumulators can be disposed of with the product. They will be separated at the recycling centres.

The black bar indicates that the product was placed on the market after August 13, 2005.

By participating in separate collection of products and batteries, you will help to assure the proper disposal of products and batteries and thus help to prevent potential negative consequences for the environment and human health.

For more detailed information about the collection and recycling programmes available in your country, please contact your local city office or the shop where you purchased the product.

Disposal of batteries and/or accumulators

The crossed out wheeled dust bin symbol indicates that batteries and/or accumulators must be collected and disposed of separately from household waste.

If the battery or accumulator contains more than the specified values of lead (Pb), mercury (Hg), and/or cadmium (Cd) defined in the Battery Directive (2006/66/EC), then the chemical symbols for lead (Pb), mercury (Hg) and/or cadmium (Cd) will appear below the crossed out wheeled dust bin symbol.

By participating in separate collection of batteries, you will help to assure the proper disposal of products and batteries and thus help to prevent potential negative consequences for the environment and human health.

For more detailed information about the collection and recycling programmes available in your country, please contact your local city office or the shop where you purchased the product.



EU



Hg Cd Pb



Printed on recycled paper. 100% Chlorine free.

VX1A00129800

If you wish to view the extended functions but do not have access to a computer or the internet then please contact your local Owner's Manual Helpline number from the numbers shown above.

Please note the telephone number only applies to extended Owner's Manual enquiries and not general operation of your TV.