

Hoshizaki America, Inc.

Commercial Refrigerators & Freezers Undercounter & Worktop Series

Models

Refrigerators

HUR40A(-D) HWR40A(-D)

HUR68A(-D) HWR68A(-D)

HUR96A(-D) HWR96A(-D)

Freezers

HUF40A(-D) HWF40A(-D)

HUF68A(-D) HWF68A(-D)



“A Superior Degree
of Reliability”

www.hoshizaki.com

SERVICE MANUAL



Number: 73123
Issued: 2-4-2005
Revised: 9-30-2008

IMPORTANT

Only qualified service technicians should attempt to service or maintain this unit. No such service or maintenance should be undertaken until the technician has thoroughly read this Service Manual.

Hoshizaki provides this manual primarily to assist qualified service technicians in the service and maintenance of the unit.

Should the reader have any questions or concerns which have not been satisfactorily addressed, please call, write or send an e-mail message to the Hoshizaki Technical Support Department for assistance.

HOSHIZAKI AMERICA, INC.
618 Highway 74 South
Peachtree City, GA 30269

Attn: Hoshizaki Technical Support Department

Phone: 1-800-233-1940 Technical Support

(770) 487-2331

Fax: 1-800-843-1056

(770) 487-3360

E-mail: techsupport@hoshizaki.com

Web Site: www.hoshizaki.com

NOTE: To expedite assistance, all correspondence/communication MUST include the following information:

- Model Number _____
- Serial Number _____
- Complete and detailed explanation of the problem.

ENERGY STAR®

Products earning the ENERGY STAR prevent greenhouse gas emissions by meeting strict energy efficiency guidelines set by the U.S. Environmental Protection Agency and the U.S. Department of Energy. Several models of Hoshizaki undercounters have earned the ENERGY STAR. To easily determine if your unit has earned the ENERGY STAR, see the nameplate attached to the right wall on the inside of the cabinet.



Please review this manual. It should be read carefully before the unit is serviced or maintenance operations are performed. Only qualified service technicians should service and maintain the unit. This manual should be made available to the technician prior to service or maintenance.

CONTENTS

I. Specifications.....	5
A. Nameplate Ratings.....	5
B. Dimensions	5
1. HUR40A, HUF40A	6
1a. HUR40A-D, HUF40A-D	6
2. HWR40A, HWF40A.....	7
2a. HWR40A-D, HWF40A-D.....	7
3. HUR68A, HUF68A	8
3a. HUR68A-D, HUF68A-D	8
4. HWR68A, HWF68A.....	9
4a. HWR68A-D, HWF68A-D.....	9
5. HUR96A	10
5a. HUR96A-D.....	10
6. HWR96A	11
6a. HWR96A-D.....	11
II. General Information	12
A. Construction	12
B. Sequence of Operation and Timing Charts	13
1. Refrigerators – Continuous Operating Mode	13
2. Freezers – Continuous Operating Mode	15
3. Refrigerators – Energy Saving Operating Mode	17
4. Freezers – Energy Saving Operating Mode	19
C. Control Board	21
1. Start-Up Delay.....	21
2. Control Board Layout.....	22
D. Settings and Diagnostics.....	23
1. Gaining Access to Settings and Diagnostics	23
2. Temperature Display	24
a) Switching the Display Between Fahrenheit and Celsius (F5)	24
b) Adjusting the Setpoint Temperature	24
c) Cabinet Temperature Correction (calibration factor).....	25
3. Settings and Diagnostics Menu	26
a) Defrost Interval (F0).....	27
b) Defrost Termination Temperature (F1)	27
c) Setpoint Temperature Differential (F2).....	28
d) High Temperature Alarm Delay Time (F3).....	29
e) Low Temperature Alarm Delay Time (F4).....	29
f) Temperature Display Scale (F5).....	30
g) Alarm History (F6).....	30
h) Compressor Run Time (F7)	31

4. Operating Modes	31
a) Continuous	32
b) Energy Saving	32
c) Automatic Corrections Made During Energy Saving Operating Mode.....	32
E. Perimeter Frame Heater	32
III. Service Diagnosis	33
A. Alarm Codes	33
1. Alarm Display Priority	34
2. Alarm Details and Countermeasures	35
a. High Temperature Alarm (E1)	35
b. Low Temperature Alarm (E2)	36
c. Defrost Alarm (E3)	37
d. High Pressure Alarm (E4)	37
e. Clogged Filter Alarm (E7)	38
f. Defrost Temperature Sensor Malfunction Alarm (E8)	39
g. Clogged Filter Sensor Malfunction Alarm (E9)	40
h. Control Board Error Alarms (EA and ED)	41
B. Diagnosis Chart	42
C. Thermistor Check	45
IV. Removal and Replacement of Components	46
A. Service for Refrigerant Lines	46
1. Refrigerant Recovery	46
2. Brazing	46
3. Evacuation and Recharge	47
B. Removal and Replacement of Refrigeration Unit	48
C. Removal and Replacement of Compressor	48
D. Removal and Replacement of Evaporator	49
E. Removal and Replacement of Capillary Tube / Suction Line Assembly	51
F. Removal and Replacement of Thermistors	52
G. Removal and Replacement of Door Gasket	53
H. Removal and Replacement of Defrost Heater	53
I. Removal and Replacement of Control Board	54
J. Removal and Replacement of Fan Motors	55
K. Door Re-Hinging and Drawer Conversion	55
V. Cleaning and Maintenance Instructions	56
A. Cleaning	56
B. Maintenance	57
VI. Wiring Diagrams	58
A1. HUR40A, HWR40A (auxiliary code Q5 and earlier)	58
A2. HUR40A(-D), HWR40A(-D) (auxiliary code Q6 and later)	59
B. HUF40A(-D), HWF40A(-D)	60
C1. HUR68A, HWR68A (auxiliary code Q5 and earlier)	61
C2. HUR68A(-D), HWR68A(-D) (auxiliary code Q6 and later)	62
D. HUF68A(-D), HWF68A(-D)	63
E. HUR96A(-D), HWR96A(-D)	64

I. Specifications

A. Nameplate Ratings

Model	AC Supply Voltage	Amperes	Design Pressure (PSIG)		Refrigerant (oz.)	
			HI	LO	404A	134a
HUR40A(-D), HWR40A(-D)	115/60/1	5.0	240	120		15.2
HUR68A(-D), HWR68A(-D)	115/60/1	5.0	240	120		15.2
HUR96A(-D), HWR96A(-D)	115/60/1	6.0	240	120		15.2
HUF40A(-D), HWF40A(-D)	115/60/1	5.5	450	250	14.1	
HUF68A(-D), HWF68A(-D)	115/60/1	10.0	450	250	13.0	

Undercounter Model Names

The undercounter models covered in this service manual initially had different model names. If you have a unit with an auxiliary code of N-6 and a serial number ending in "H", refer to the table below.

Model Name on Nameplate	Current Name
UR1-SSB	HUR40A
UR2-SSB	HUR68A
UF1-SSB	HUF40A
UF2-SSB	HUF68A

B. Dimensions

Model	Door Opening mm		Total Refrigerated Volume ft ³	Total Shelf Space ft ²	Hotel Pan Capacity (-D)
	Width	Height			
HUR40A(-D), HWR40A(-D), HUF40A(-D), HWF40A(-D)	570.2	616.2	8.5	7.6	4
HUR68A(-D), HWR68A(-D), HUF68A(-D), HWF68A(-D)			18.8	17.1	8
HUR96A(-D), HWR96A(-D)			29.1	26.6	12

1. HUR40A, HUF40A

Units: mm (in.)

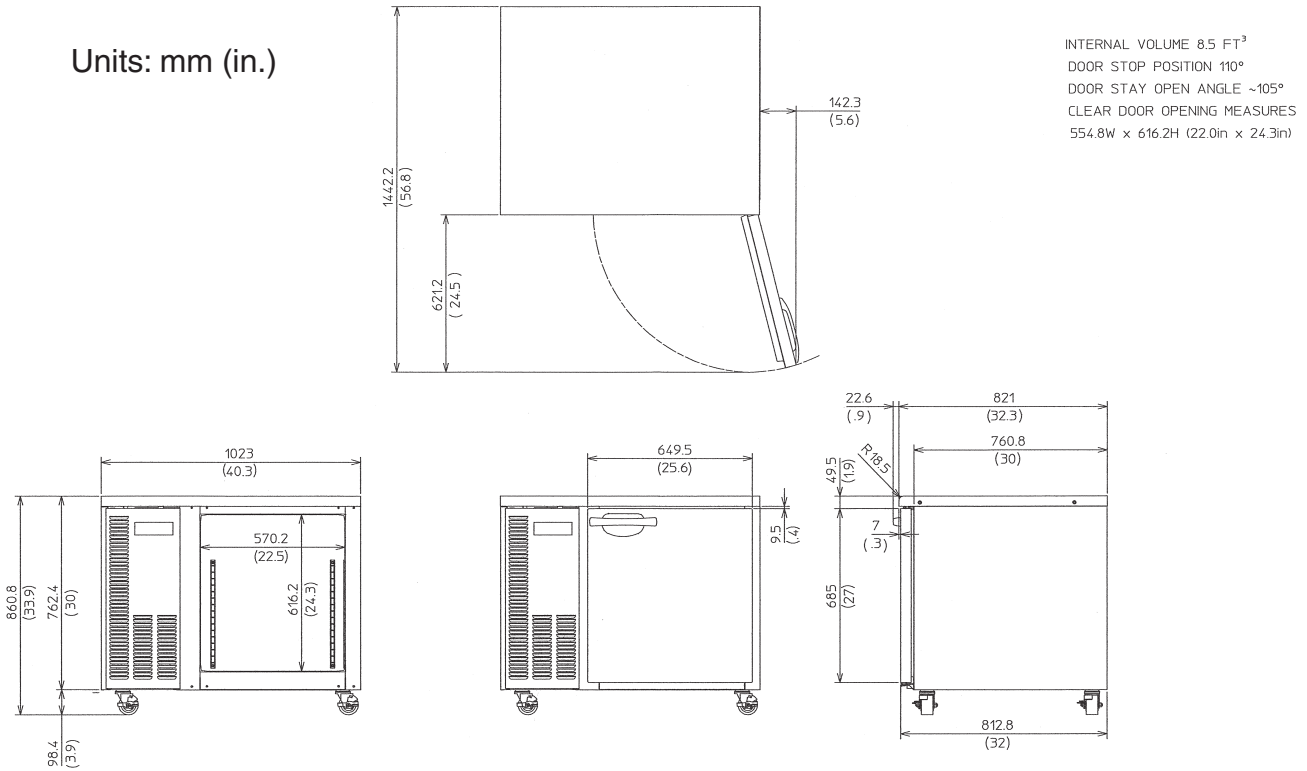

1a. HUR40A-D, HUF40A-D

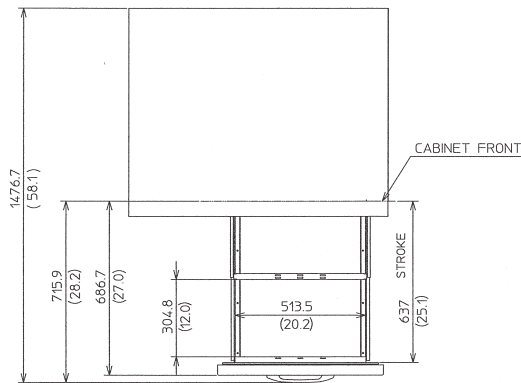

DRAWER CARTRIDGE: SIZED FOR A MAXIMUM OF FOUR 1/1 PANS (SEE SKETCH BELOW):
 WIDTH: 12 7/8" = 327.025 mm
 LENGTH: 20 7/8" = 530.225 mm

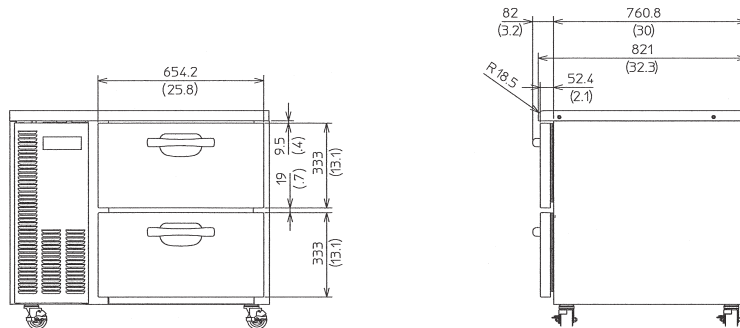
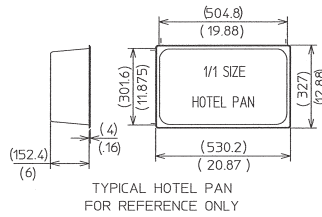

2. HWR40A, HWF40A

Units: mm (in.)

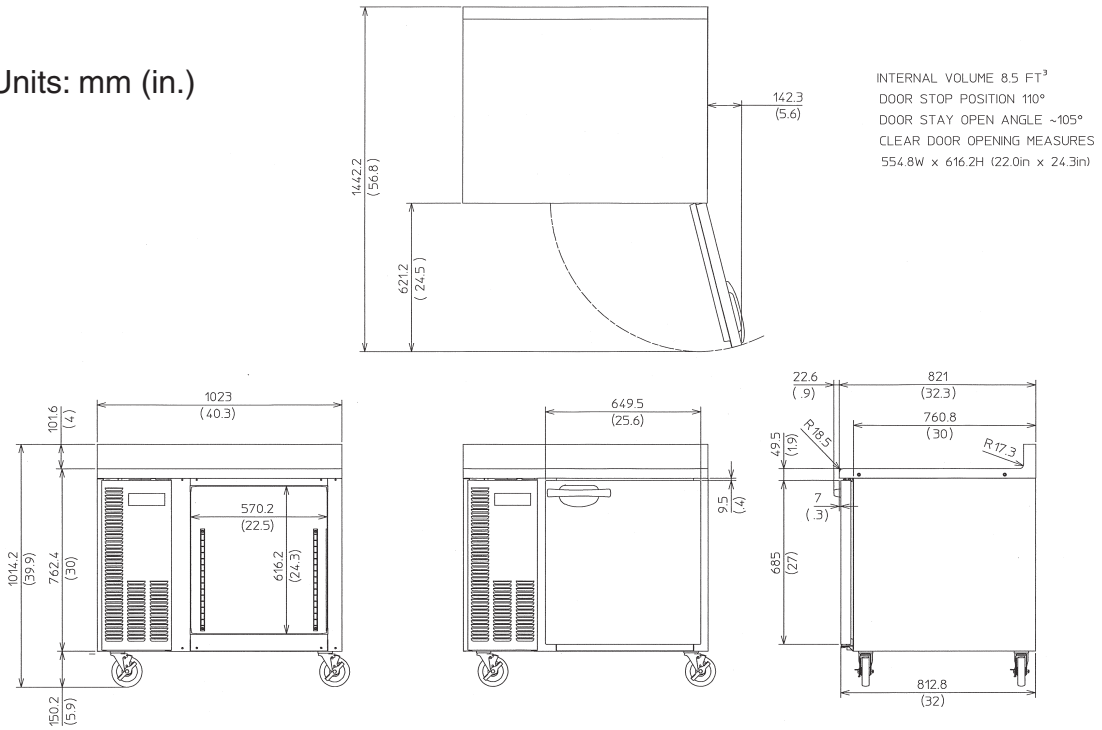

2a. HWR40A-D, HWF40A-D

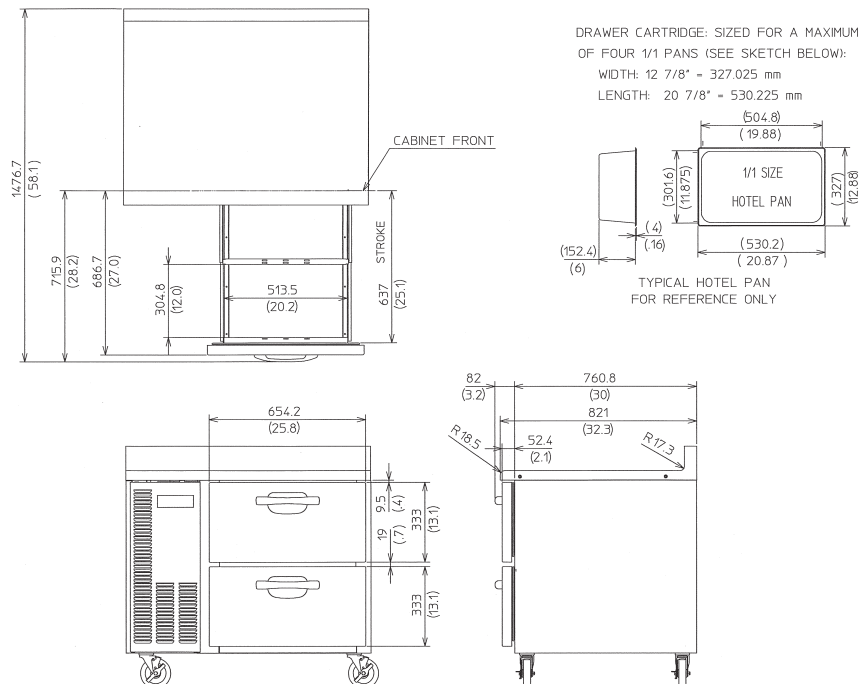

3. HUR68A, HUF68A

Units: mm (in.)

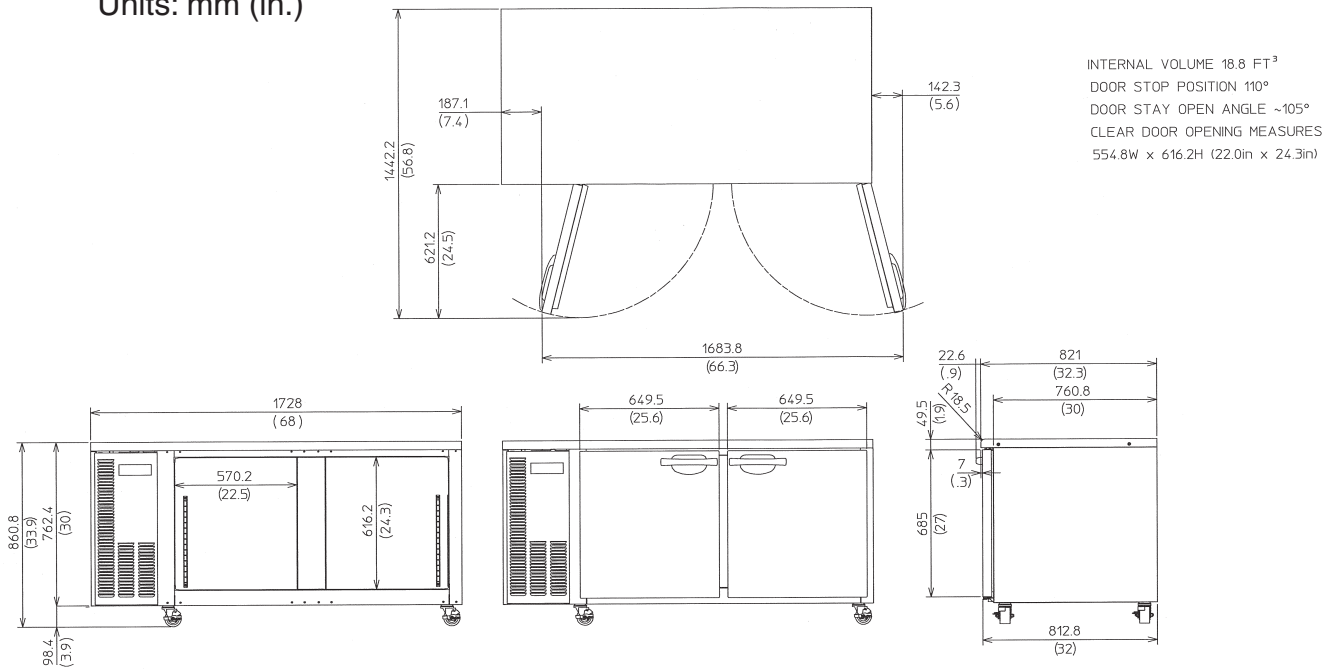

3a. HUR68A-D, HUF68A-D

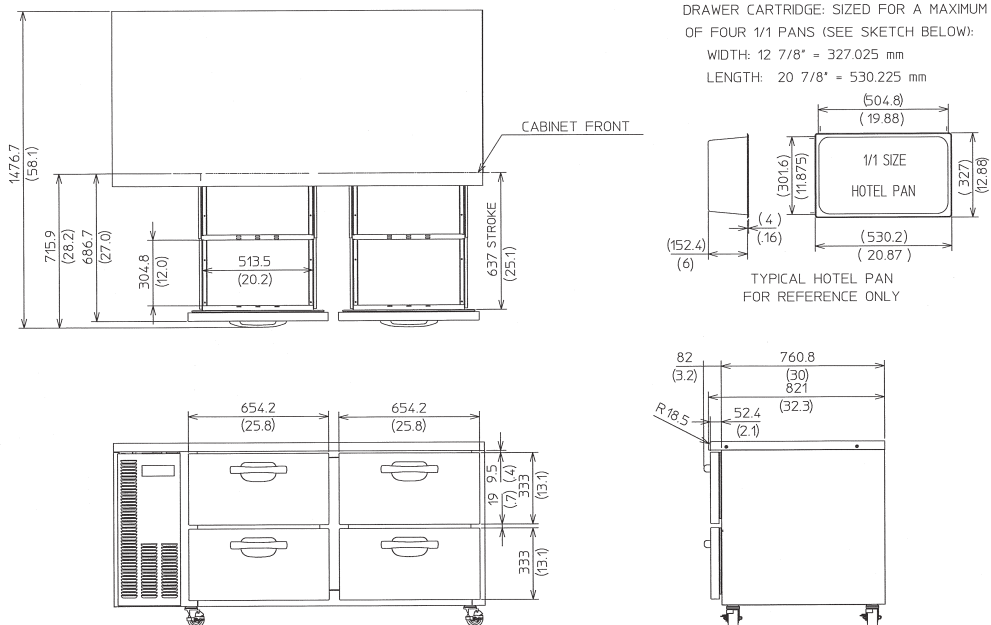

4. HWR68A, HWF68A

Units: mm (in.)

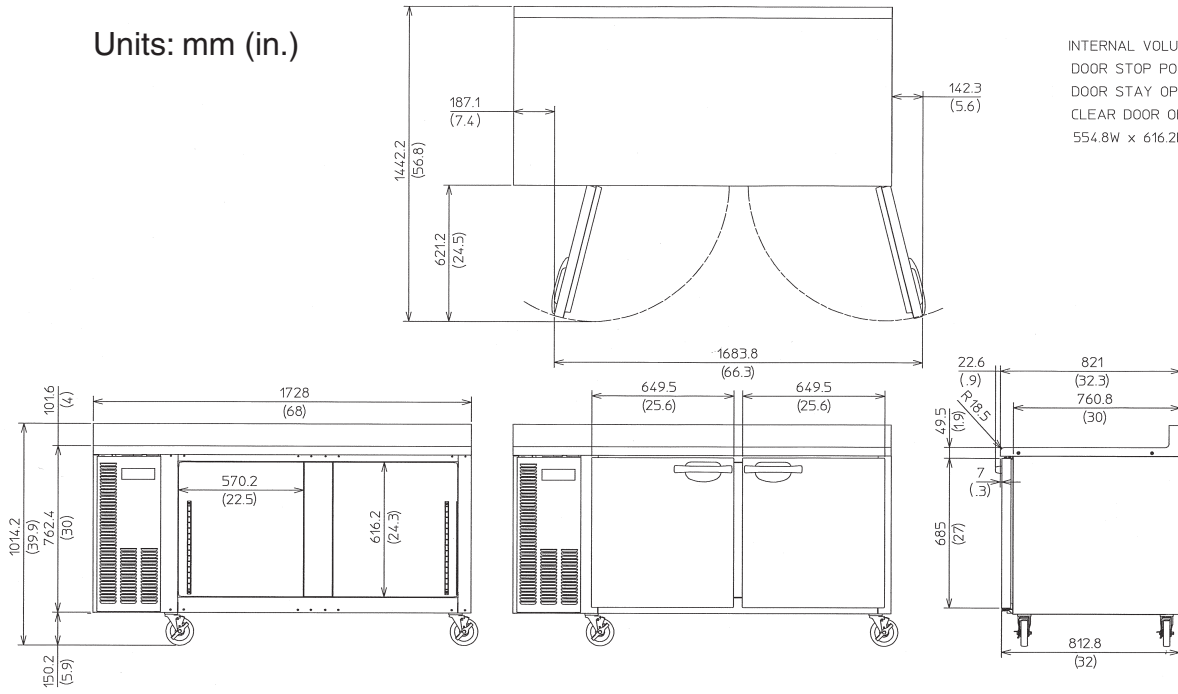

4a. HWR68A-D, HWF68A-D

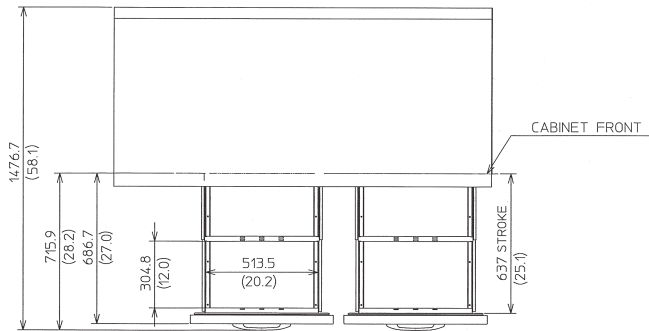

DRAWER CARTRIDGE: SIZED FOR A MAXIMUM OF FOUR 1/1 PANS (SEE SKETCH BELOW):
 WIDTH: 12 7/8" = 327.025 mm
 LENGTH: 20 7/8" = 530.225 mm

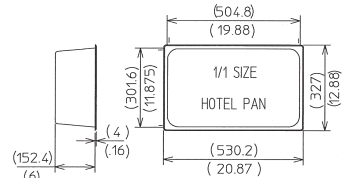

TYPICAL HOTEL PAN FOR REFERENCE ONLY

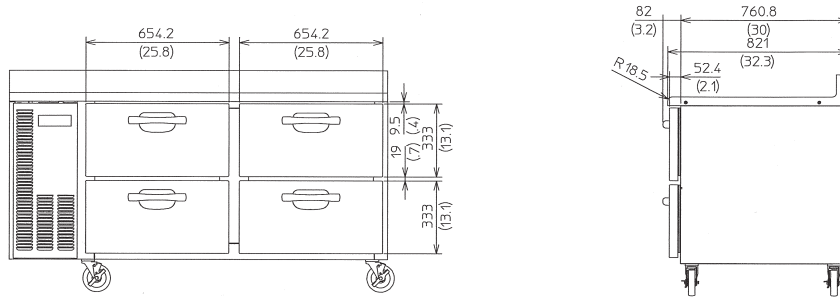

5. HUR96A

Units: mm (in.)

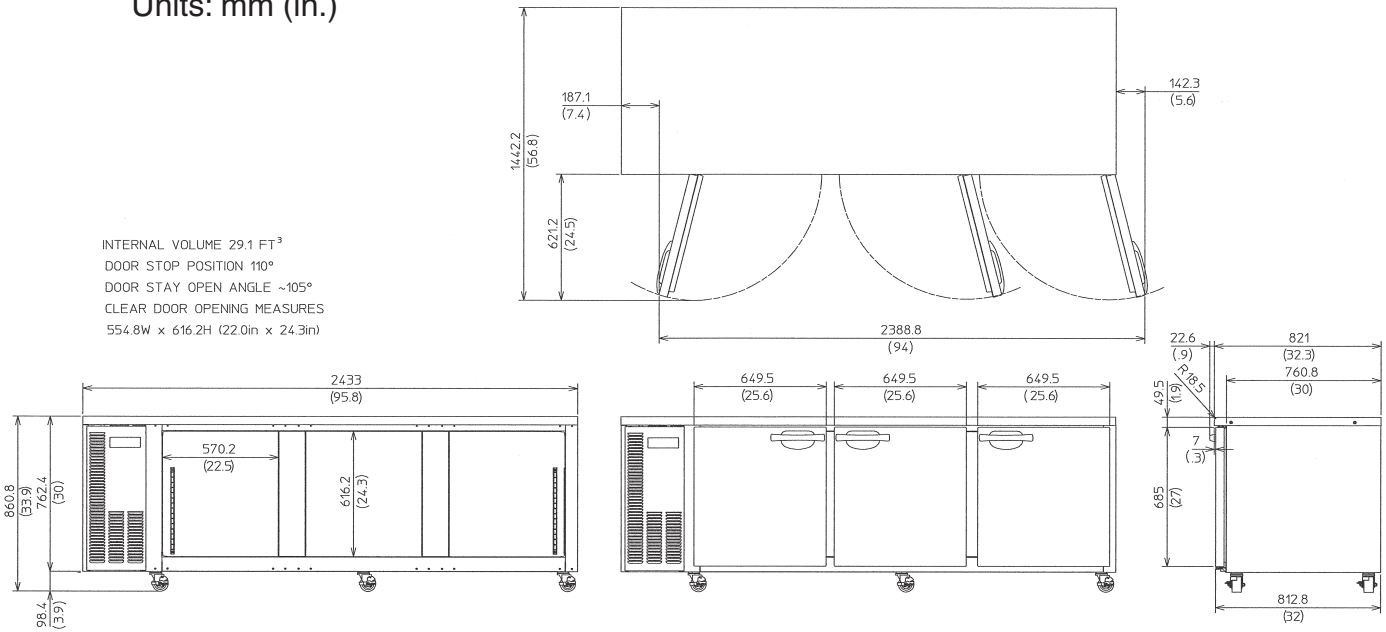

5a. HUR96A-D

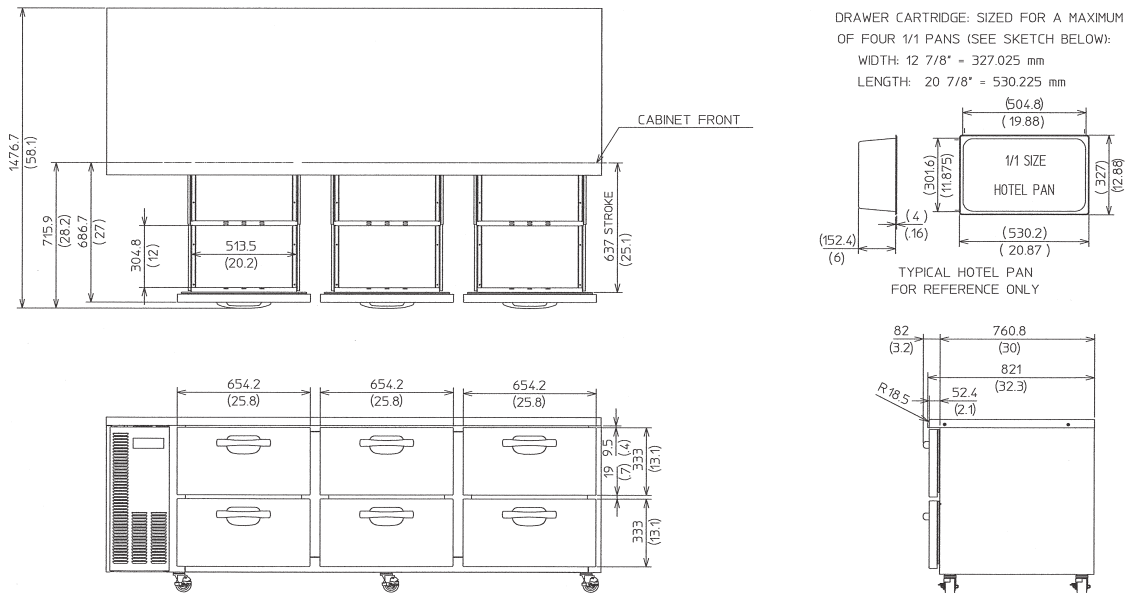

6. HWR96A

Units: mm (in.)

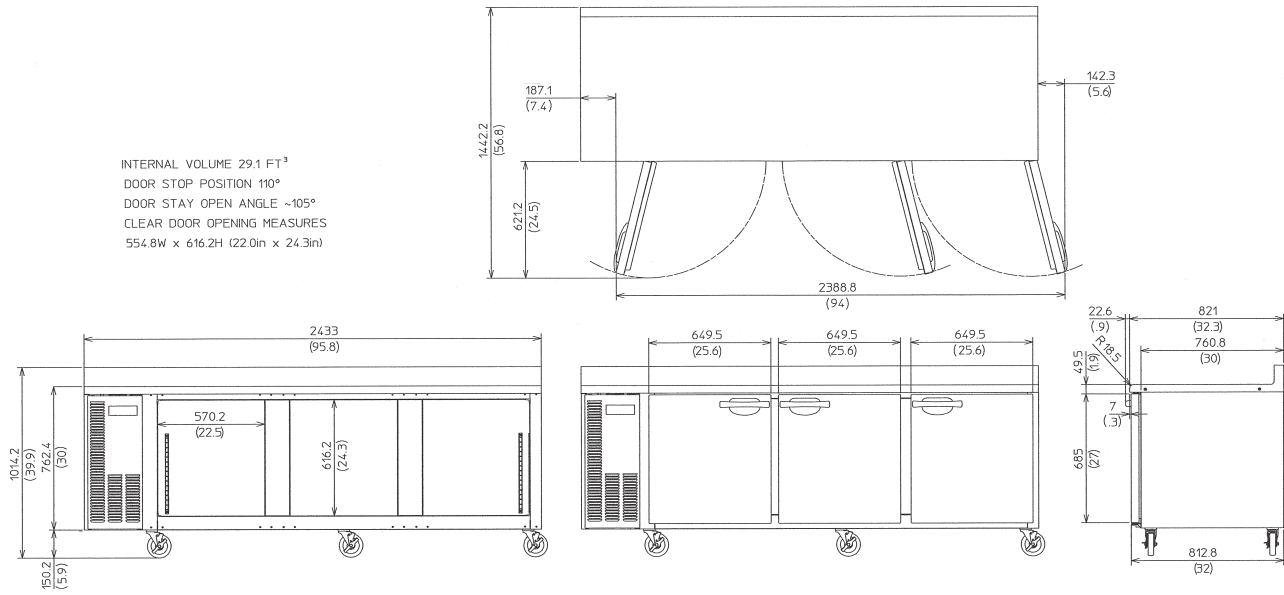

6a. HWR96A-D

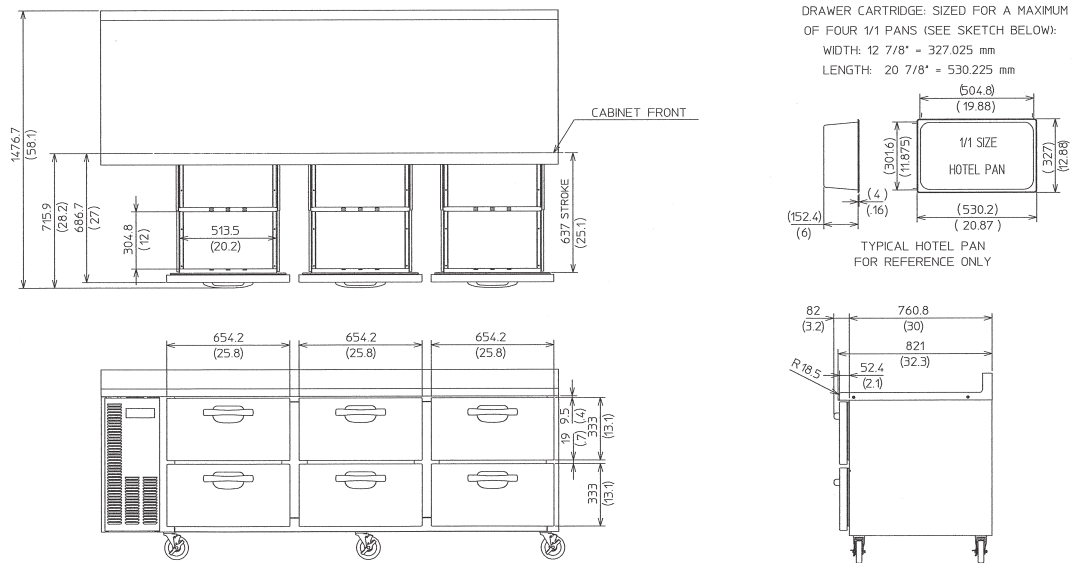

II. General Information

A. Construction

Hoshizaki undercounters feature a cartridge-type refrigeration unit that can be removed without taking off the top and side panels.

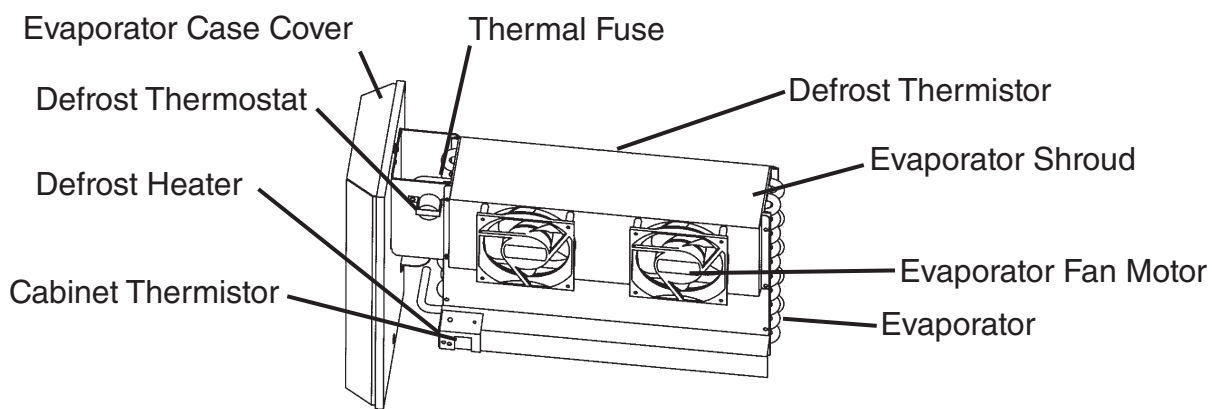
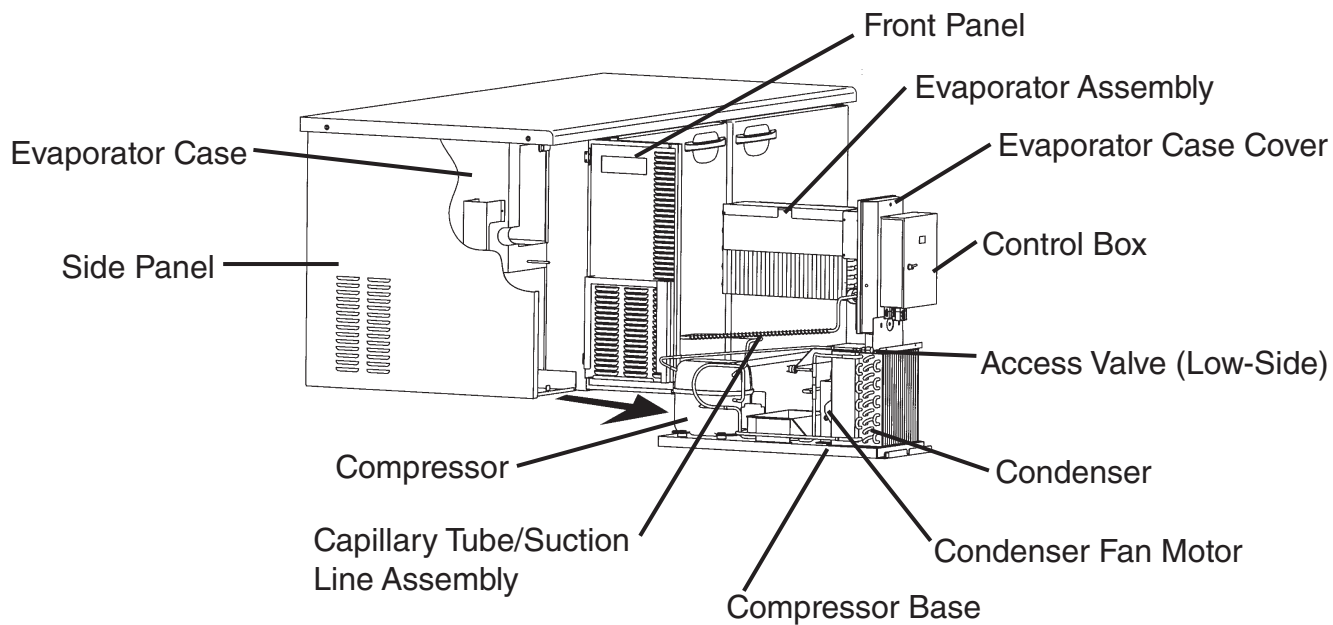

Evaporator Case

B. Sequence of Operation and Timing Charts

For details on operating modes, see "II.D.4. Operating Modes."

1. Refrigerators – Continuous Operating Mode

a) Sequence of Operation

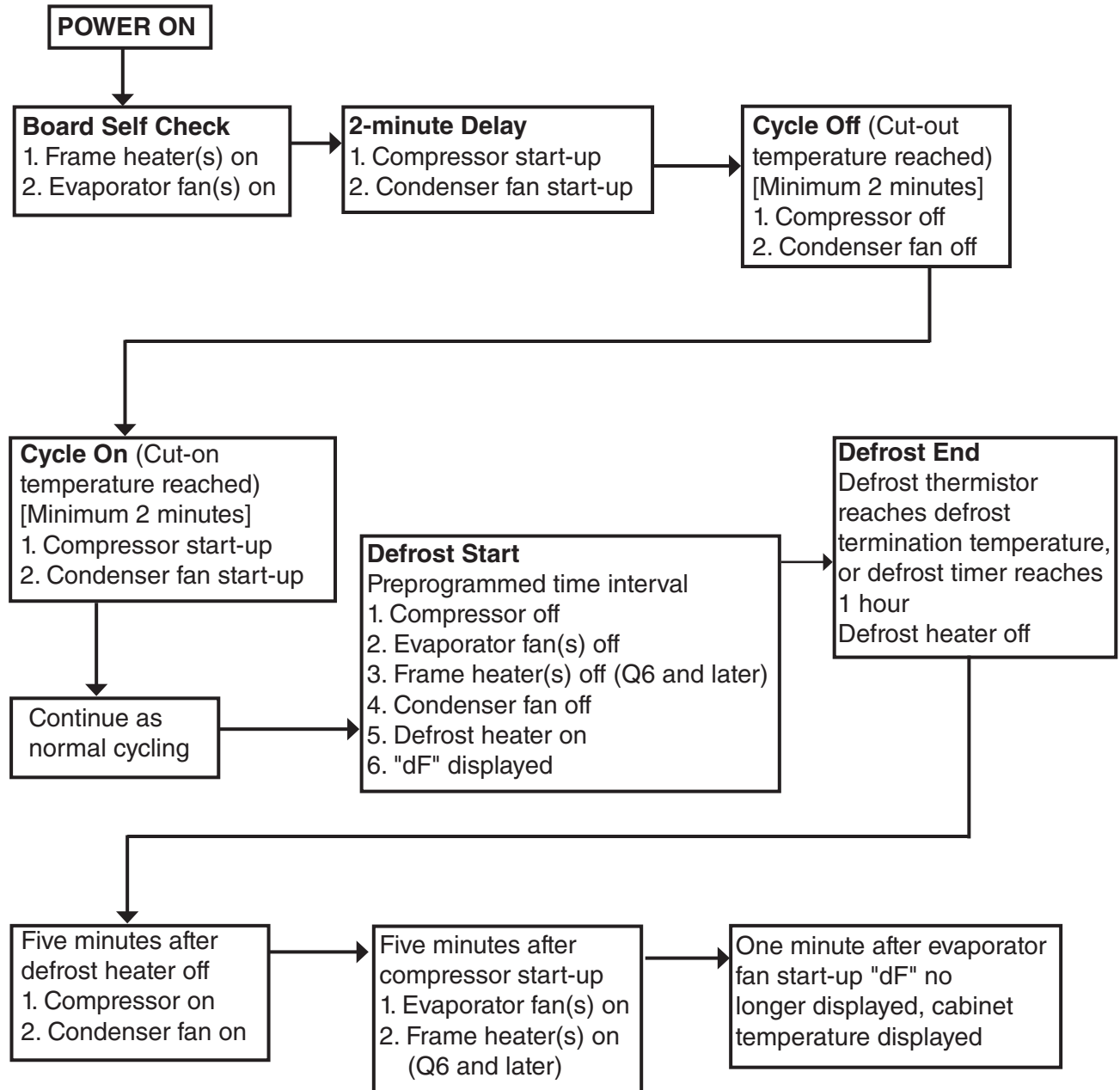

Note:

- 1) Cut-on, cut-off, and cabinet temperature are read by the same sensor, called the "cabinet thermistor."
- 2) The defrost thermistor reads the evaporator temperature.
- 3) There is a five second evaporator fan startup delay when the compressor and fan would otherwise start together.

b) Timing Chart
Refrigerators – Continuous Operating Mode

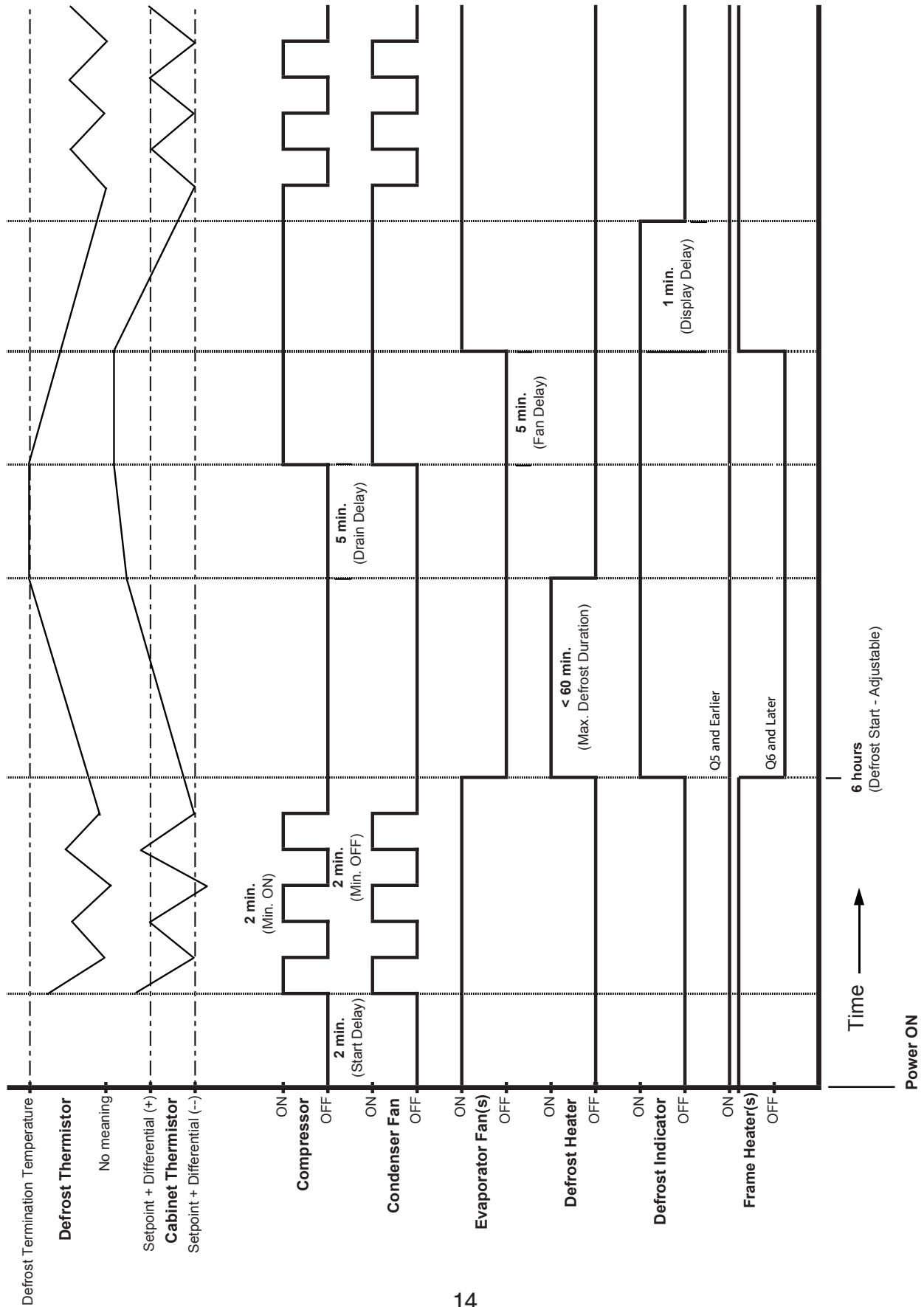

2. Freezers – Continuous Operating Mode

a) Sequence of Operation

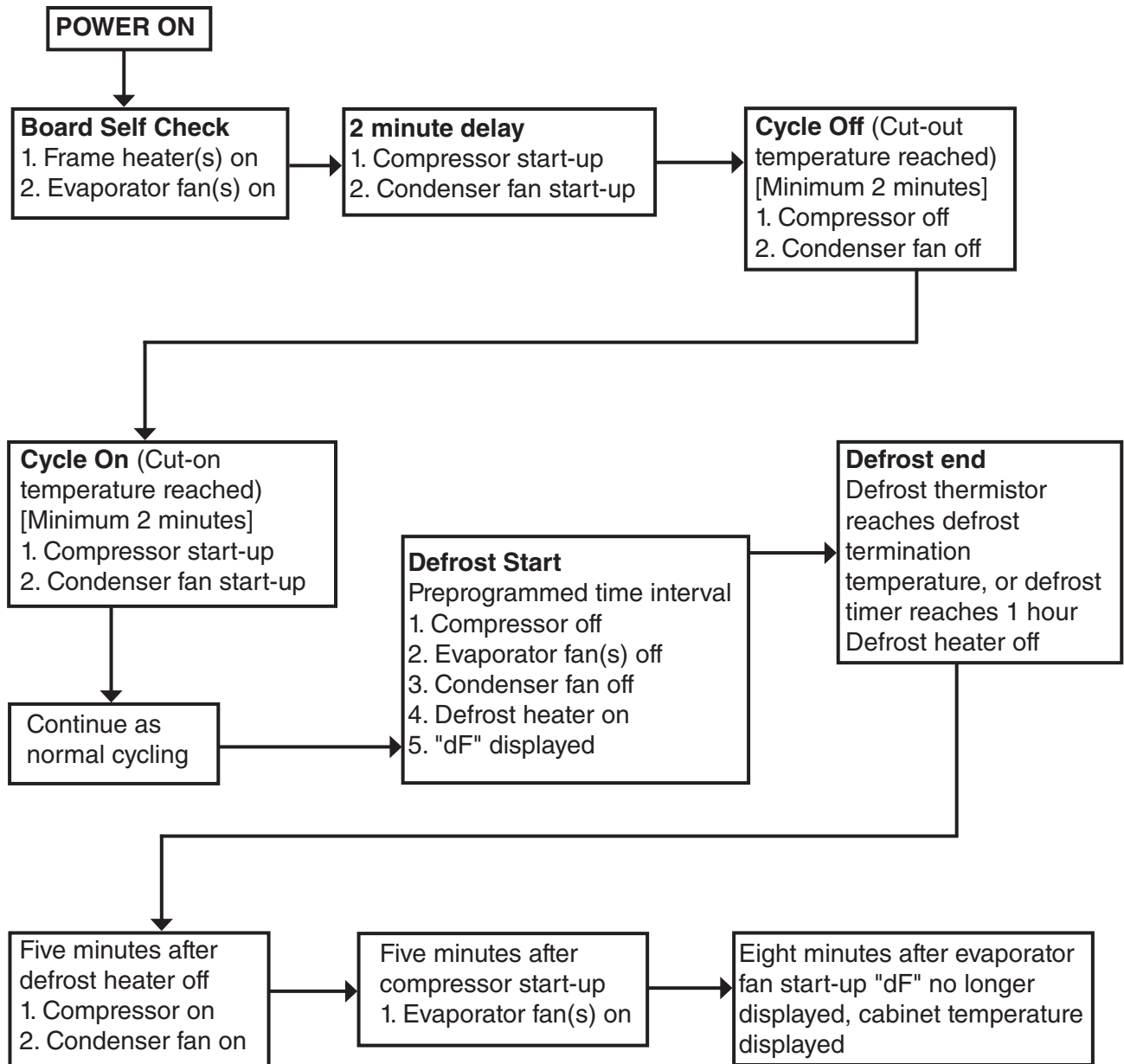

Note:

- 1) Cut-on, cut-off, and cabinet temperature are read by the same sensor, called the "cabinet thermistor."
- 2) The defrost thermistor reads the evaporator temperature.
- 3) There is a five second evaporator fan startup delay when the compressor and fan would otherwise start together.

b) Timing Chart
Freezers – Continuous Operating Mode

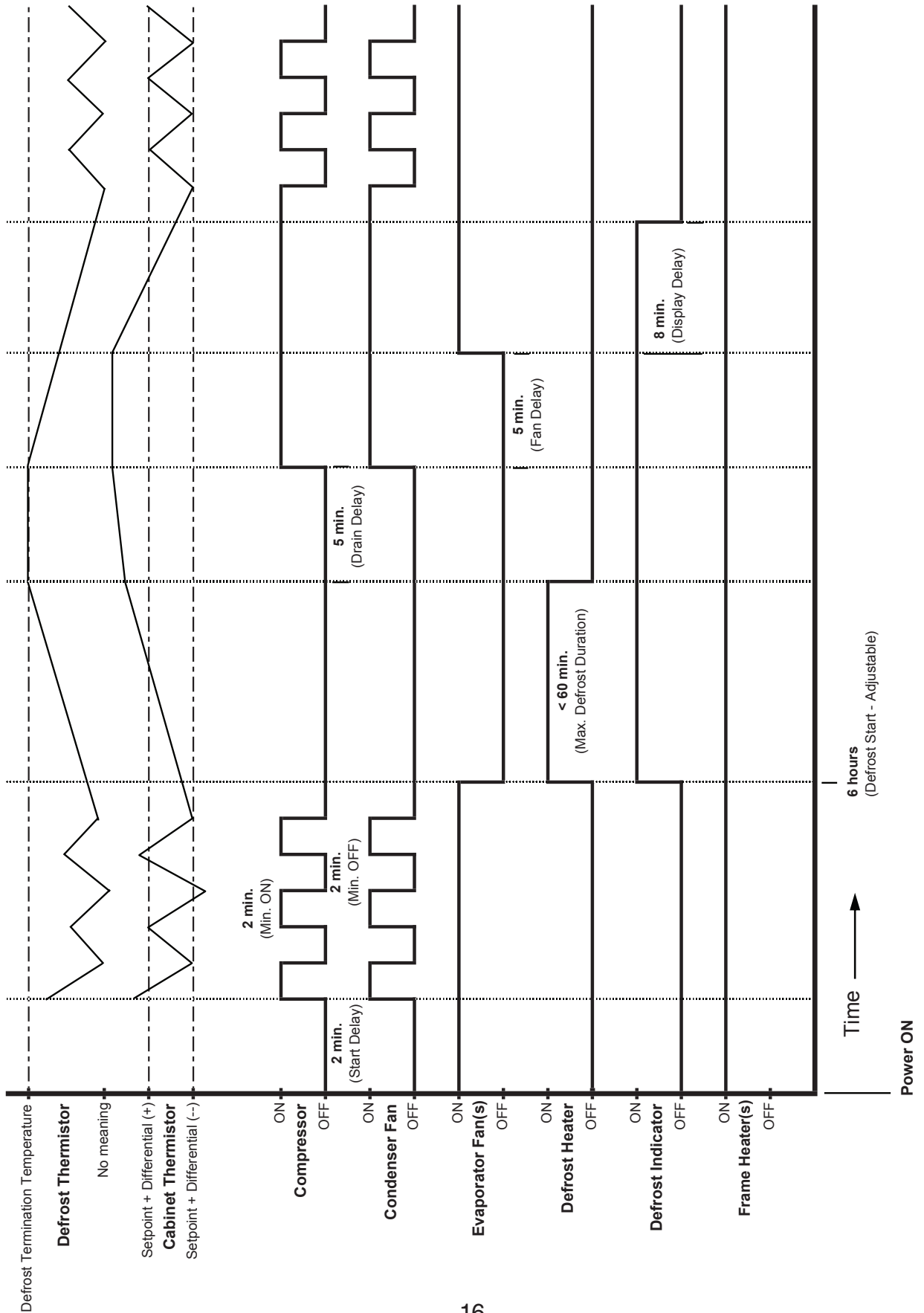

3. Refrigerators – Energy Saving Operating Mode

a) Sequence of Operation

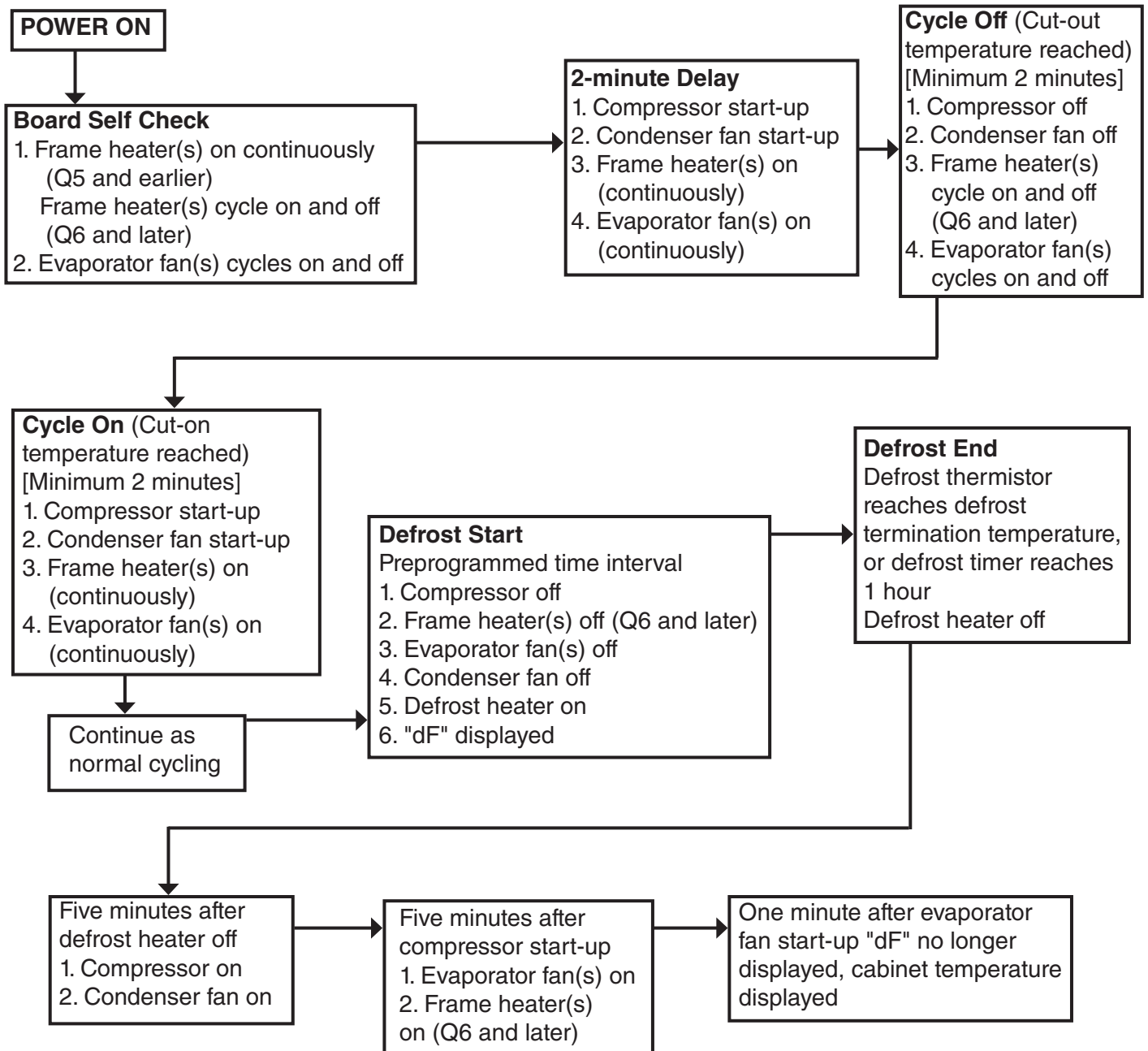

Note:

- 1) Cut-on, cut-off, and cabinet temperature are read by the same sensor, called the "cabinet thermistor."
- 2) The defrost thermistor reads the evaporator temperature.

b) Timing Chart
Refrigerators – Energy Saving Operating Mode

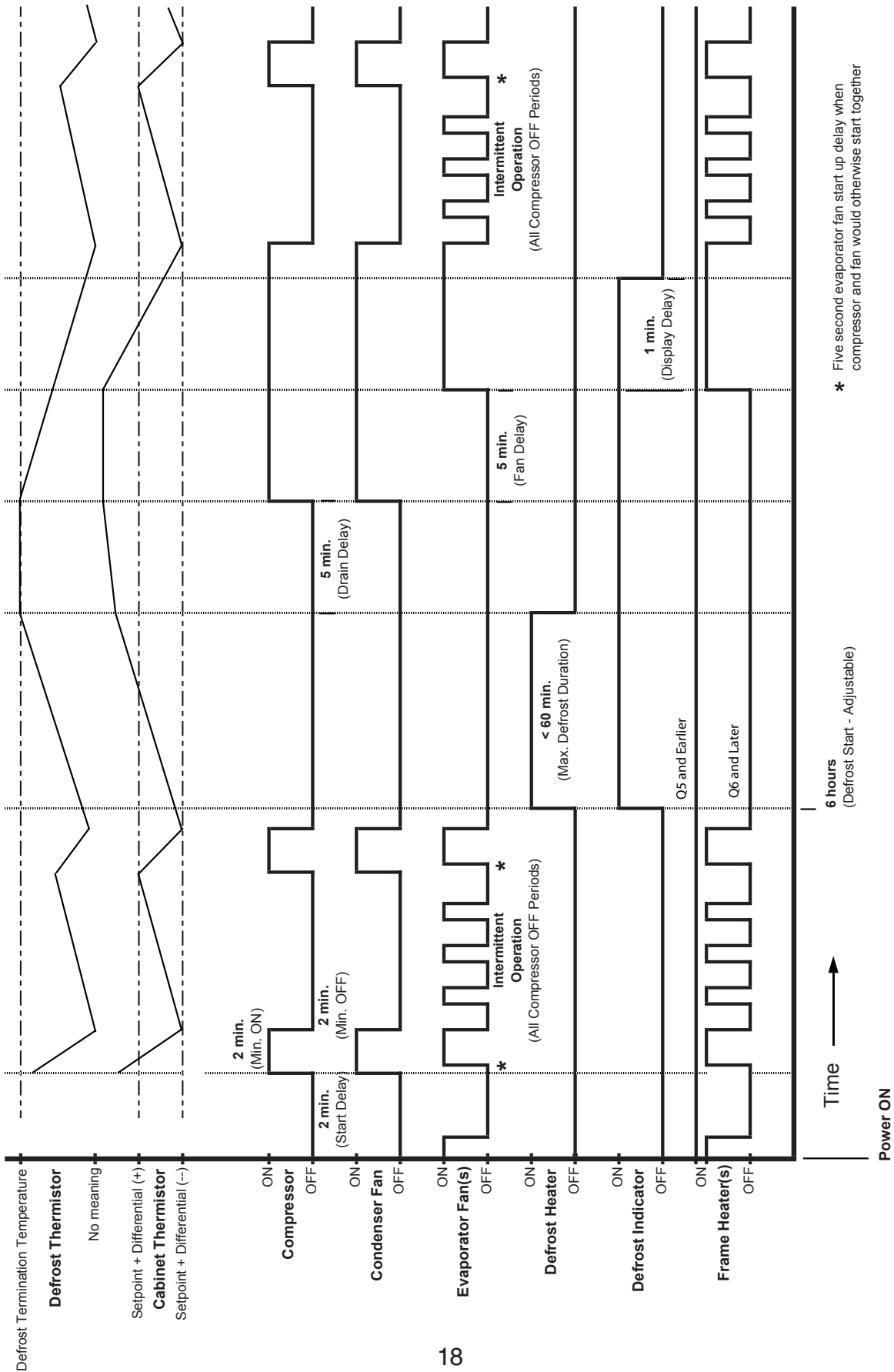

4. Freezers – Energy Saving Operating Mode

a) Sequence of Operation

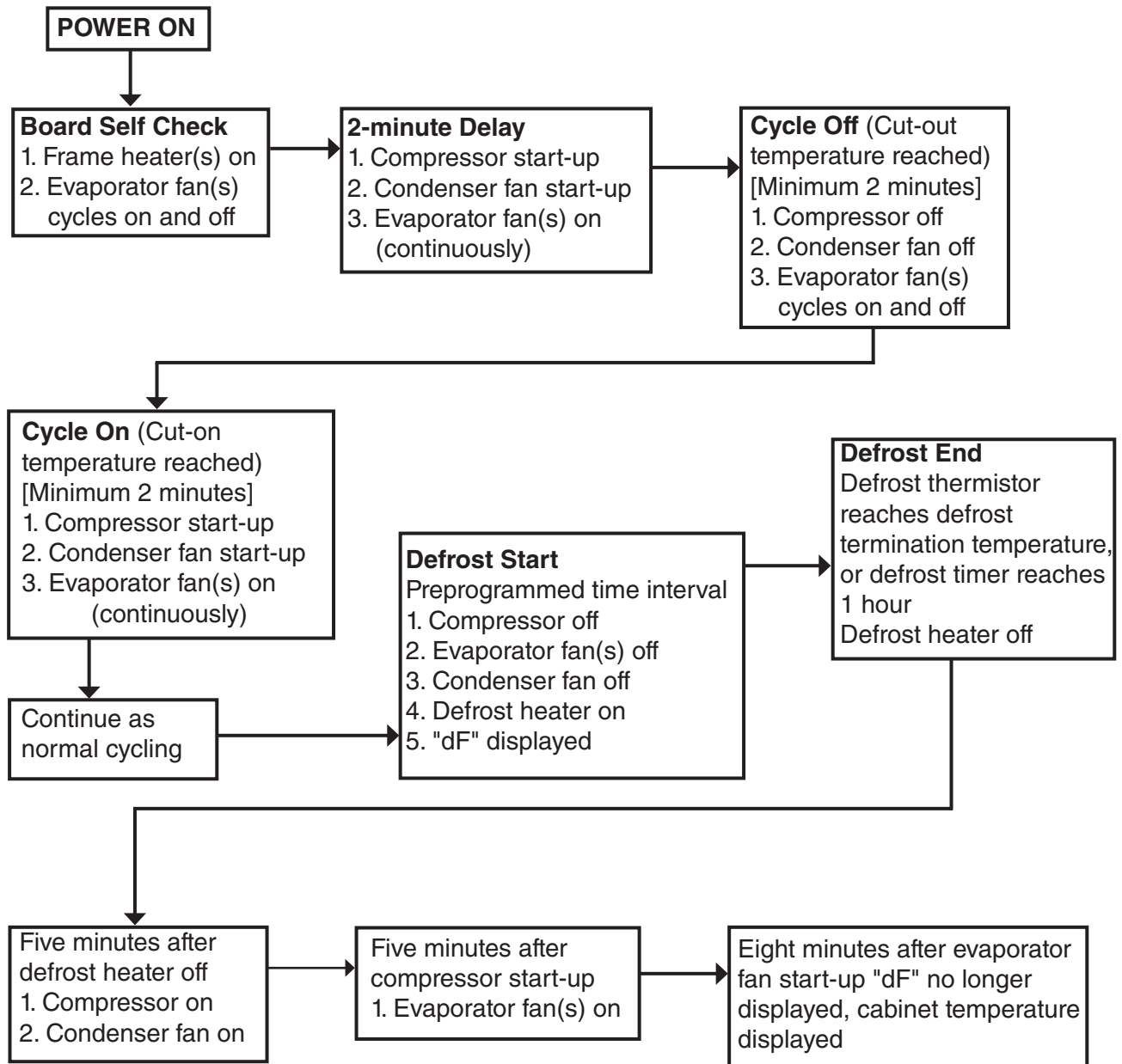

Note:

- 1) Cut-on, cut-off, and cabinet temperature are read by the same sensor, called the "cabinet thermistor."
- 2) The defrost thermistor reads the evaporator temperature.

b) Timing Chart
Freezers – Energy Saving Operating Mode

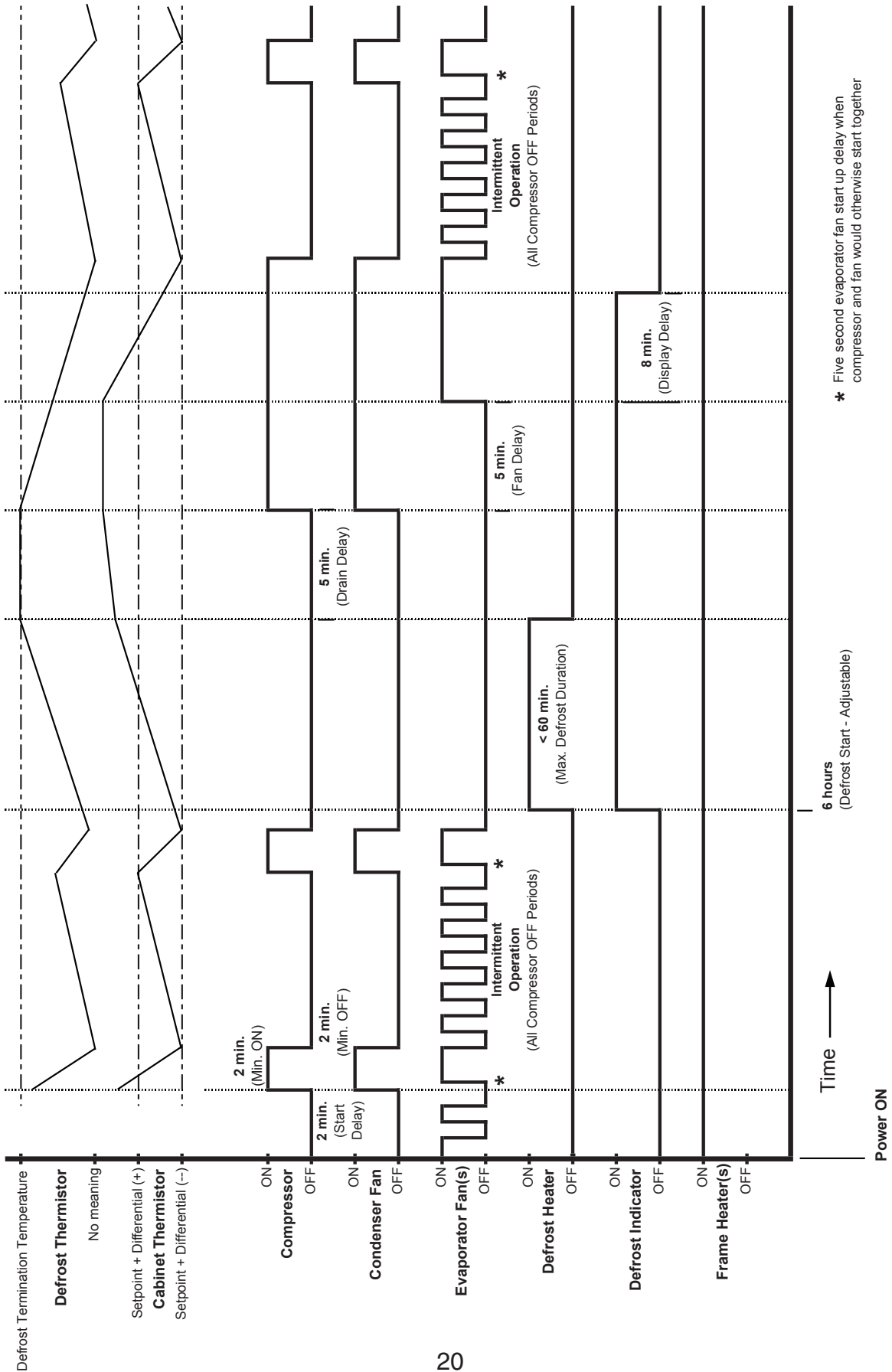

C. Control Board

- A Hoshizaki exclusive solid-state control board is employed in all Hoshizaki refrigerators and freezers.
- All models are pretested and factory-adjusted.

CAUTION

1. Fragile, handle very carefully.
2. The control board contains integrated circuits, which are susceptible to failure due to static discharge. It is especially important to touch the metal part of the unit when handling or replacing the board.
3. Do not touch the electronic devices on the board or the back of the board to prevent damage to the board.
4. Do not attempt to repair the board in the field. Always replace the whole board assembly if it goes bad.
5. Do not short out power supply to test for voltage.
6. Keep the thermistor leads, clogged filter sensor leads, and pressure switch leads at least 1.5" away from high voltage leads (AC 100 volts or more) to protect against electrical noise.

1. Start-Up Delay

The start circuit of the compressor is timed such that at power-up and during any compressor off time, there will be at least a 2-minute delay before the compressor will start. This delay is controlled through the control board. To bypass the startup delay, move the power switch to the "OFF" position. Then press and hold the up arrow key while moving the power switch to the "ON" position.

Note: The compressor must run a minimum of three minutes during each run cycle.

2. Control Board Layout

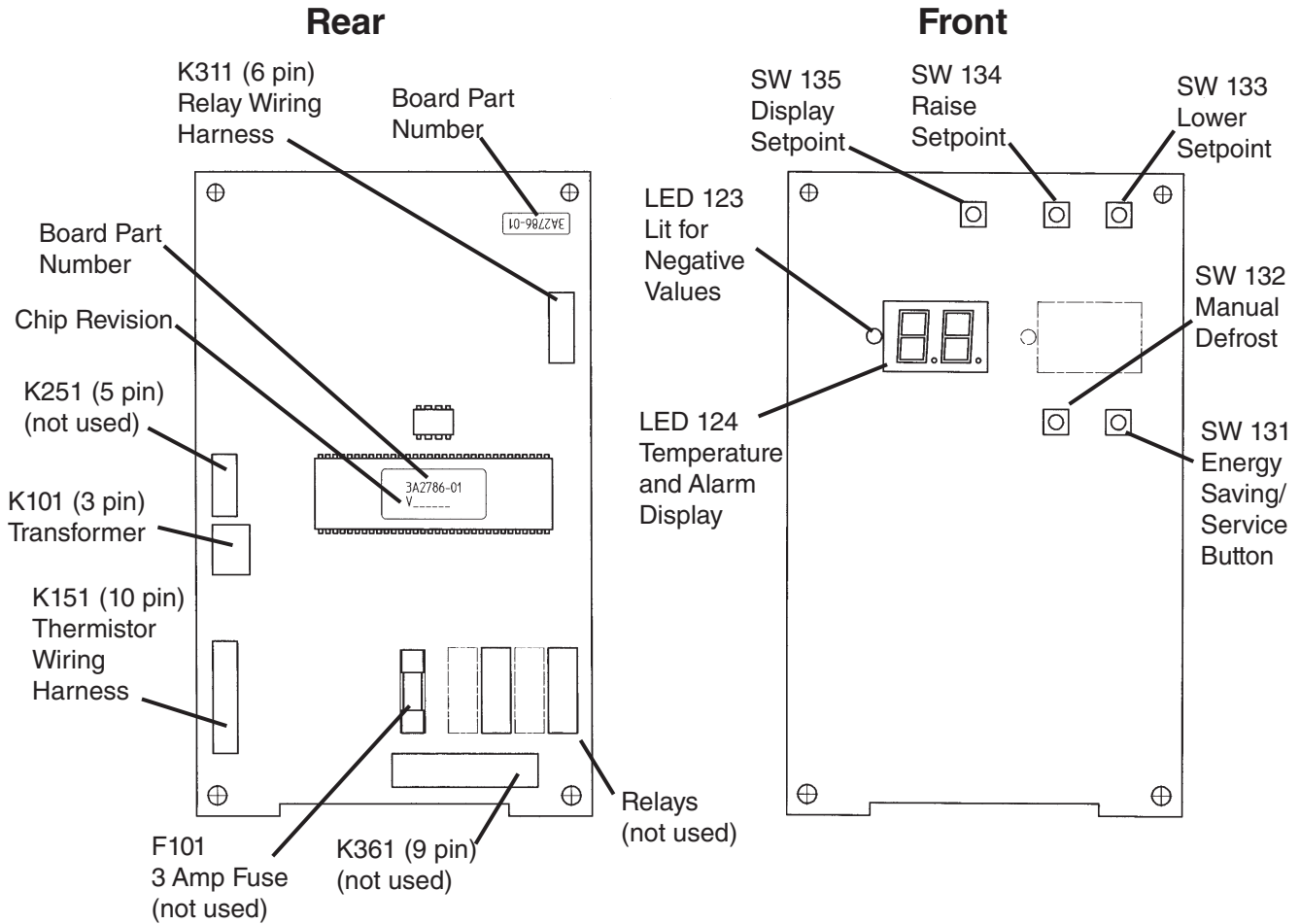

Note: Fuse at position F101 on board is not currently used. The board can function without this fuse.

Relay Wiring Harness (K311)

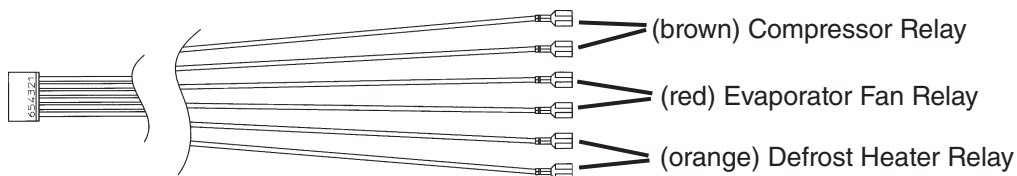

Thermistor Wiring Harness (K151)

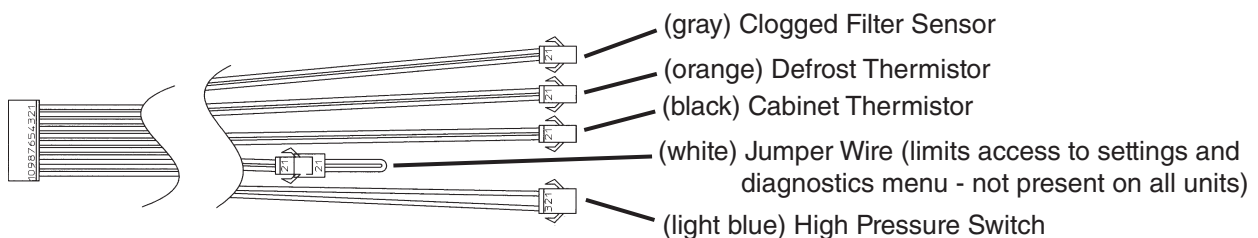

D. Settings and Diagnostics

Various settings and diagnostic information can be controlled via the display panel. The display panel is located behind the front panel. To open the front panel, grip the outer edge of the panel near the top and bottom and pull it open. This permits access to the display panel and control box. The unit has a 2 minute startup delay. To bypass the startup delay, move the power switch to the "OFF" position. Then press and hold the up arrow key while moving the power switch to the "ON" position. Follow the instructions and warnings below and on the display panel for safe and efficient operation of the unit.

1. Gaining Access to Settings and Diagnostics

Generally, the only two settings that can change are the temperature display scale (°F or °C) and the temperature setpoint. The restriction to these two settings is achieved by the presence of a jumper between connector K151 pins 7 and 8 on the control board. To access other settings, the jumper must be removed. To see if the jumper is present press and hold both the **SET** button and the **●** unmarked, blank button for 5 seconds. If "F5" appears in the display window, the jumper is present and must be removed in order to access other settings. If "F0" is displayed, no jumper is present and all settings are unrestricted and accessible. See the rest of this section for details about each setting.

Note: If there is no input for 60 seconds, the display will revert to normal.

■ CABINET TEMPERATURE SETTING

- Push SET Point Button to display the current set point temperature.
- Hold down SET Point Button and press Temperature Control Button (▲) or (▼) until Temperature Display Window shows the desired temperature.

TEMP. CONTROL — setting buttons

CABINET TEMP. — temperature display window

MANUAL DEFROST — blank button

MANUAL DEFROST button

POWER

ON

+

OFF

■ DEFROST

- Temperature Display Window shows "dF" during defrost cycle.

■ MANUAL DEFROST

- Hold down Manual Defrost Button for 5 seconds to start defrost cycle.

■ ERROR CODE DISPLAY

- Temperature Display Window flashes alternately between one of the error codes from "E1" to "E9" and cabinet temperature in case of trouble.
- E1 - Cabinet temperature too high:
 - * Door(s) left open.
 - * Warm or hot foods inside.
 - * Installed near high heat producing equipment.
- E7 - Condenser clogged or ambient temperature too high:
 - * Air Filter clogged.
 - * Installed near high heat producing equipment.
- If an error code other than "E1" or "E7" is displayed, contact an authorized Hoshizaki service company.

■ HOW TO RESET ERROR CODE

- E1 - Automatically resets when a proper cabinet temperature is resumed.
- E7 - After checks and corrections, turn power supply off and back on again. If the error code still appears, contact an authorized Hoshizaki service company.

WARNING

⚠	Risk of injury Do not touch the Condenser or Evaporator Fins directly.
⚠	Risk of injury Do not put anything inside. The Fan is rotating rapidly inside.
⚠	Risk of burn Do not touch the hot parts inside.
⚠	Risk of electric shock and injury Before servicing, turn off Power Switch and unplug the unit or disconnect main power.









354126-01B

2. Temperature Display

- Displays the cabinet temperature. The factory setting is °F. To change the display to the °C scale, see "a) Switching the Display Between Fahrenheit and Celsius (F5)" below.
- The cabinet temperature is updated every 30 seconds.
- During defrost, "dF" is displayed in place of the cabinet temperature.





a) Switching the Display Between Fahrenheit and Celsius (F5)

The factory setting is °F. To change the display to °C, follow the steps below.

- 1) Press and hold both the  button and the  unmarked, blank button for 5 seconds. "F5" appears in the display window. (If "F0" is displayed, press the MANUAL DEFROST button until "F5" appears.)
- 2) Press the  unmarked, blank button to display the current setting (default: "F"). Press the  up or  down button to switch to °C. Press the  unmarked, blank button again to save the setting.
- 3) Press and hold both the  button and the  unmarked, blank button for 5 seconds. The cabinet temperature will be displayed using the newly saved temperature scale.
- 4) Affix the "°C" label supplied with the unit to the display panel, covering "°F" but not the display window.

b) Adjusting the Setpoint Temperature

The setpoint temperature is the temperature at which the compressor turns on. To set the setpoint temperature, follow the steps below.

- 1) Press the  button to display the current setpoint temperature.
- 2) To change the setpoint, press and hold the  button while pressing the  up or  down button to raise or lower the setpoint.

Model	Allowable Setpoint Range	Default
Refrigerator (auxiliary code Q5 and earlier)	+21 to +53°F (-6 to +12°C)	39°F (4°C)
Refrigerator (auxiliary code Q6 and later)		37°F (3°C)
Freezer (Door)	-13 to +19°F (-25 to -7°C)	0°F (-18°C)
Freezer (Drawer)		2°F (-17°C)

- 3) After 10 seconds, the new setpoint will be saved automatically.

Note: For refrigerators, the temperature differential for the compressor to turn off is -4.5°F (-2.5°C) for auxiliary code Q5 and earlier and -3.6°F (-2.0°C) for auxiliary code Q6 and later. For 1-section freezers, it is -6.3°F (-3.5°C) and for 2-section freezers, it is -3.6°F (-2.0°C).

c) Cabinet Temperature Correction (calibration factor)

In cases where there is a discrepancy between the actual cabinet center temperature and the displayed temperature for a particular model, a calibration factor is used to correct the displayed temperature.

WARNING

This unit has been factory tested with the default settings listed. Avoid using this function except to confirm that the setting is correct. If set incorrectly, the display could show an acceptable temperature even though the temperature is out of the proper range. This value should only be changed after consulting with the factory.

To view the current value, follow the steps below.

- 1) Turn the power on while pressing the ▲ up button. The current correction calibration factor will be shown. If "18" is displayed, the value is 1.8°F (1.0°C). See the table below for the default values.

Cabinet Temperature Correction (Calibration Factor)		Default		
Model	Setting Range	1-Section	2-Section	3-Section
Refrigerator	-9.9 to 9.9°F in 0.9°F increments (-9.5 to 9.5°C in 0.5°C increments)	00 (0.0°F) (00 (0.0°C))		36 (3.6°F) (20 (2.0°C))
Freezer		18 (1.8°F) (10 (1.0°C))	45 (4.5°F) (25 (2.5°C))	

- 2) If it is determined through discussion with the factory that the setting needs to be changed, press the ▲ up or ▼ down button to increase or decrease the value.
- 3) Press the SET button to save the new value.
- 4) Turn the power off and then back on. The unit will start running with the new value.

[Example]

When the average cabinet temperature is 5.4°F (3.0°C) higher than the thermistor detected temperature, change the correction calibration factor to 5.4°F (3.0°C).

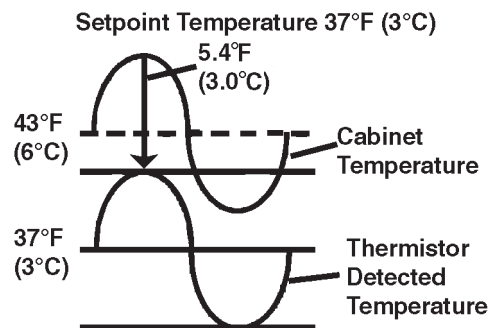









3. Settings and Diagnostics Menu

To gain access to the settings, see "II.D.1. Gaining Access to Settings and Diagnostics." Once inside this menu, press the MANUAL DEFROST button to scroll through the menu and the  unmarked, blank button at any point to view the current setting. Press the MANUAL DEFROST button to return to the menu screen.

Code	Item	Setting and Display Range	Default			
			Refrigerator		Freezer	
			Auxiliary Code		1 section	2 section
			Q5 and earlier	Q6 and later		
F0	Defrost Interval	1 to 12 hours in 1 hour increments	6	6	6	
F1	Defrost Termination Temperature	Refrigerator: 59 to 68°F (15 to 20°C) in one degree increments Freezer: 41 to 68°F (5 to 20°C) in one degree increments	59°F	59°F	41°F	
F2	Setpoint Temperature Differential (upper and lower)	0 to 6.3°F in increments of .9°F (0 to 3.5°C in increments of .5°C)	0°F, -45°F (0°C, -2.5°C) (decimal is not displayed)	0°F, -36°F (2.0, -2.0°C) (decimal is not displayed)	0°F, -63°F (0°C, -3.5°C) (decimal is not displayed)	0°F, -36°F (2.0, -2.0°C) (decimal is not displayed)
F3	High Temperature Alarm Delay Time	0 to 180 minutes in 60 minute increments (0=0; 1=60; 2=120; 3=180 minutes)	2	2	2	
F4	Low Temperature Alarm Delay Time	0 or 60 minutes (0=0; 1=60 minutes)	1	1	1	
F5	Temperature Display	Fahrenheit or Celsius	°F	°F	°F	
F6	Alarm History	Displays alarm history - maximum 8 alarms	NA	NA	NA	
F7	Compressor Run Time	Displays run time between two most recent defrosts	NA	NA	NA	
F8	Not Used		NA	NA	NA	
F9	Not Used		NA	NA	NA	

a) Defrost Interval (F0)

This unit is preset at the factory to defrost once every 6 hours for general conditions. However, if it is determined that this interval does not suit actual conditions, the interval can be changed. To change the defrost interval, follow the steps below.



- 1) Make sure the jumper is removed between connector K151 pins 7 and 8 on the control board. Otherwise you will not be able to access this setting. For details, see "D.1. Gaining Access to Settings and Diagnostics."
- 2) Press and hold both the  button and the  for 5 seconds. If "F0" is not displayed, press the MANUAL DEFROST button until "F0" appears in the display window.
- 3) Press the  to display the current setting (default: "6"). Press the  up or  down button to increase or decrease the number of hours between each defrost. The interval can be from 1 to 12 hours in increments of 1 hour.
- 4) Press the  to save the setting.
- 5) Press the MANUAL DEFROST button to return to the menu screen. Press and hold both the  button and the  for 5 seconds to exit the setting mode and return to the temperature display.
- 6) If a jumper was present between connector K151 pins 7 and 8, reconnect it after all setting and diagnostic work is complete.

Note:

- The defrost is a heated defrost, and therefore has a tendency to raise cabinet temperature.
- When the unit goes into defrost during energy saving mode, evaporator fan(s) and/or perimeter frame heaters will turn off.
- Cabinet temperature is not displayed during defrost; "dF" is displayed in its place.
- The change in the defrost setting will take effect immediately. The next defrost will take place after the newly set time interval has elapsed.
- Initiating a manual defrost will restart the defrost timer.
- The evaporator temperature must be below the defrost completion temperature for any defrost (manual or auto) to be initiated.

b) Defrost Termination Temperature (F1)

To change the defrost termination temperature, follow the steps below.

- 1) Make sure the jumper is removed between connector K151 pins 7 and 8 on the control board. Otherwise you will not be able to access this setting. For details, see "D.1. Gaining Access to Settings and Diagnostics."
- 2) Press and hold both the  button and the  for 5 seconds. "F0" should appear in the display window. Press the MANUAL DEFROST button until "F1" appears in the display window.

- 3) Press the ● unmarked, blank button to display the current setting. Press the ▲ up or ▼ down button to increase or decrease the defrost termination temperature.
 Note: The defrost termination temperatures can be adjusted within the following ranges:
 - Refrigerator: 59 to 68°F (15 to 20°C) in one degree increments
 - Freezer: 41 to 68°F (5 to 20°C) in one degree increments
- 4) Press the ● unmarked, blank button to save the setting.
- 5) Press the MANUAL DEFROST button to return to the menu screen. Press and hold both the SET button and the ● unmarked, blank button for 5 seconds to exit the setting mode and return to the temperature display.
- 6) If a jumper was present between connector K151 pins 7 and 8, reconnect it after all setting and diagnostic work is complete.





c) **Setpoint Temperature Differential (F2)**

To change the differential, follow the steps below.



- 1) Make sure the jumper is removed between connector K151 pins 7 and 8 on the control board. Otherwise you will not be able to access this setting. For details, see "D.1. Gaining Access to Settings and Diagnostics."
- 2) Press and hold both the SET button and the ● unmarked, blank button for 5 seconds. "F0" should appear in the display window. Press the MANUAL DEFROST button until "F2" appears in the display window.
- 3) Press the ● unmarked, blank button to display the current + setting (the decimal between the digits is not shown). Press the ▲ up or ▼ down button to increase or decrease the + (plus) differential in .9°F increments.
 Note:
 - Both the + and - values can be adjusted between 0.0 and 6.3°F in .9°F increments (0.0 to 3.5°C in .5°C increments).
 - You cannot set both + and - to 0.0.
- 4) Press the ● unmarked, blank button to save the + setting and move to the - (minus) differential setting.
- 5) Press the ▲ up or ▼ down button to increase or decrease the - (minus) differential in .9F increments.
 Note:
 - Both the + and - values can be adjusted between 0.0 and 6.3°F in .9°F increments (0.0 to 3.5°C in .5°C increments).
 - You cannot set both + and - to 0.0.
- 6) Press the ● unmarked, blank button to save the - (minus) setting. The - (minus) sign will turn off and the display will change to the + (plus) differential setting.
- 7) Press the MANUAL DEFROST button to return to the menu screen. Press and hold both the SET button and the ● unmarked, blank button for 5 seconds to exit the setting mode and return to the temperature display.
- 8) If a jumper was present between connector K151 pins 7 and 8, reconnect it after all setting and diagnostic work is complete.

d) High Temperature Alarm Delay Time (F3)

To change the high temperature alarm delay time, follow the steps below.





- 1) Make sure the jumper is removed between connector K151 pins 7 and 8 on the control board. Otherwise you will not be able to access this setting. For details, see "D.1. Gaining Access to Settings and Diagnostics."
- 2) Press and hold both the  button and the  unmarked, blank button for 5 seconds. "F0" should appear in the display window. Press the MANUAL DEFROST button until "F3" appears in the display window.
- 3) Press the  unmarked, blank button to display the current setting. Press the  up or  down button to increase or decrease the high temperature alarm delay time.
Note: The time can be adjusted between 0 and 180 minutes in 60 minute increments.
The display corresponds to time as follows:

Display	Detection Time (minutes)
0	0
1	60
2	120
3	180



- 4) Press the  unmarked, blank button to save the setting.
- 5) Press the MANUAL DEFROST button to return to the menu screen. Press and hold both the  button and the  unmarked, blank button for 5 seconds to exit the setting mode and return to the temperature display.
- 6) If a jumper was present between connector K151 pins 7 and 8, reconnect it after all setting and diagnostic work is complete.

e) Low Temperature Alarm Delay Time (F4)

To change the low temperature alarm delay time, follow the steps below.

- 1) Make sure the jumper is removed between connector K151 pins 7 and 8 on the control board. Otherwise you will not be able to access this setting. For details, see "D.1. Gaining Access to Settings and Diagnostics."
- 2) Press and hold both the  button and the  unmarked, blank button for 5 seconds. "F0" should appear in the display window. Press the MANUAL DEFROST button until "F4" appears in the display window.
- 3) Press the  unmarked, blank button to display the current setting. Press the  up or  down button to increase or decrease the low temperature alarm delay time.
Note: The time can be 0 or 60 minutes. The display corresponds to time as follows:

Display	Detection Time (minutes)
0	0
1	60



- 4) Press the  unmarked, blank button to save the setting.
- 5) Press the MANUAL DEFROST button to return to the menu screen. Press and hold both the  button and the  unmarked, blank button for 5 seconds to exit the setting mode and return to the temperature display.
- 6) If a jumper was present between connector K151 pins 7 and 8, reconnect it after all setting and diagnostic work is complete.

f) Temperature Display Scale (F5)

For information about switching the display between °F and °C, see "D.2.a) Switching the Display Between Fahrenheit and Celsius (F5)."



g) Alarm History (F6)

To view the alarm history, follow the steps below.

- 1) Make sure the jumper is removed between connector K151 pins 7 and 8 on the control board. Otherwise you will not be able to access this setting. For details, see "D.1. Gaining Access to Settings and Diagnostics."
- 2) Press and hold both the  button and the  unmarked, blank button for 5 seconds. "F0" should appear in the display window. Press the MANUAL DEFROST button until "F6" appears in the display window.
- 3) Press the  unmarked, blank button to display the alarm history. The alarms will be displayed in reverse chronological order (newest to oldest - up to 8 alarms). When "--" is displayed, you have reached the end of the alarm history and the display will begin again.





Note: The alarms are as follows:

Alarm Code	Description
E1	High Temperature Alarm
E2	Low Temperature Alarm
E3	Defrost Alarm
E4	High Pressure Alarm
E7	Clogged Filter Alarm
E8	Defrost Temperature Sensor Malfunction Alarm
E9	Clogged Filter Sensor Malfunction Alarm
EA	EEPROM Write Error Alarm
ED	EEPROM Verification or Read Error Alarm

- 4) To reset the alarm history, press and hold both the  unmarked, blank button and the MANUAL DEFROST button for 5 seconds.
- 5) Press the MANUAL DEFROST button to return to the menu screen. Press and hold both the  button and the  unmarked, blank button for 5 seconds to exit the setting mode and return to the temperature display.
- 6) If a jumper was present between connector K151 pins 7 and 8, reconnect it after all setting and diagnostic work is complete.

h) Compressor Run Time (F7)

To display the compressor run time between the two most recent defrosts, follow the steps below.

- 1) Make sure the jumper is removed between the connector K151 pins 7 and 8 on the control board. Otherwise you will not be able to access this feature.
- 2) Press and hold both the  button and the  for 5 seconds. "F0" should appear in the display window. Press the MANUAL DEFROST button until "F7" appears in the display window.
- 3) Press the  to display the run time. The number displayed indicates what percent of the time the compressor was running.
- 4) Press the MANUAL DEFROST button to return to the menu screen. Press and hold both the  button and the  for 5 seconds to exit the setting mode and return to the temperature display.
- 5) If a jumper was present between connector K151 pins 7 and 8, reconnect it after all setting and diagnostic work is complete.

4. Operating Modes

Hoshizaki undercounters and worktops feature two operating modes, energy saving and continuous. Always use the default setting of your unit. To determine the default setting of your unit, see the chart below.

Model	Default Setting
Refrigerator (auxiliary code Q5 and earlier)	Continuous Operating Mode
Refrigerator (auxiliary code Q6 and later)	Energy Saving Operating Mode
Freezer - 1 section	Continuous Operating Mode
Freezer - 2 section	Energy Saving Operating Mode

To determine the operating mode your unit is in, look at the unit's cabinet temperature display. If a period does not appear after the temperature, the unit is in continuous operating mode. If a period appears after the temperature, the unit is in energy saving operating mode.

To switch between operating modes, press and hold the  for 5 seconds.

Note: It takes 5 seconds for this setting to be saved. Once saved, the setting you made will be remembered even if the power is turned off.

Continuous
(no period after temperature)

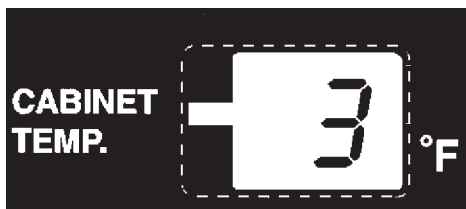

Energy Saving
(period after temperature)



a) Continuous

The evaporator fan runs constantly (except in defrost). The frame heaters are on continuously.

b) Energy Saving

The evaporator fan runs when the compressor is on, but only intermittently when the compressor is off. The frame heaters cycle on and off with the evaporator fan for refrigerators auxiliary code Q6 and later, but are on continuously for refrigerators auxiliary code Q5 and earlier and all freezers. Intermittent fan operation saves energy by reducing heat leak, especially around the gasket, and by extending compressor off time. Fan on/off time is dependent on the setpoint temperature.

Model	Setpoint Temperature	Off Time (seconds)	On Time (seconds)
Refrigerator	23 to 30°F (-5 to -1°C)	90	15
	32 to 52°F (0 to 11°C)	150	15
Freezer	-13 to +19°F (-25 to -7°C)	30	30

c) Automatic Corrections Made During Energy Saving Operating Mode

(1) Temperature Display Correction

When the unit is in energy saving mode and the evaporator fan shuts off, the temperature at the cabinet thermistor drops due to its close proximity to the evaporator. Therefore, the temperature at the cabinet thermistor does not accurately reflect the true cabinet temperature. To compensate for this, the cabinet temperature registered at compressor shutoff is displayed for 120 seconds after shutoff when in energy saving mode. After 120 seconds, the cabinet temperature plus 1.8°F (1°C) will be displayed. Once the compressor turns back on, the display will return to the normal display.

(2) Temperature Differential Correction

During energy saving mode, the cabinet temperature tends to be higher than during normal operation because the evaporator fan operates only intermittently when the compressor is off. The upper setpoint differential for turning the compressor on is automatically adjusted to compensate.

E. Perimeter Frame Heater

This unit is equipped with a perimeter frame heater. This prevents the formation of condensate on the front frame of the unit under high humidity conditions.

Note: On refrigerators with auxiliary code Q6 and later, perimeter frame heater(s) operate together with the evaporator fan(s).

III. Service Diagnosis

A. Alarm Codes

If an error occurs, the alarm code and cabinet temperature are displayed in 1-second intervals. See the table below for a general description of the problem, then see the rest of this section for detailed instructions.

Alarm Signals		
Alarm Code	Problem	Notes
E1	High Temperature Alarm Cabinet temperature has exceeded set temperature by 14.4°F (10°C) for more than x hours. The default value of x is "2" (2 hours).	When temperature returns to setpoint range, alarm code "E1" will clear. The value of x can be changed under F3 on the Settings and Diagnostics Menu. (0=No delay; 1=1 hour; 2=2 hours; 3=3 hours)
E2	Low Temperature Alarm Cabinet temperature has remained below setpoint by 9°F (5°C) for more than y hours. The default value of y is "1" (1 hour).	When temperature returns to setpoint range, alarm code "E2" will clear. The value of y can be changed under F4 on the Settings and Diagnostics Menu. (0=No delay; 1=hour)
E3	Defrost Alarm Defrost has taken longer than 1 hour. Control board has terminated defrost.	E3 may alternate with "dF" instead of the temperature.
E4	High Pressure Alarm Compressor discharge pressure is outside normal operating range. Pressure switch has been triggered 5 or more times in 1 hour. Condenser filter may need cleaning.	Clean filter if necessary. Allow time for pressure switch to react, then turn power off and back on again to reset. If switch trips 5 times in 1 hour, and the above steps do not clear alarm code, see the procedure contained in this section.
E7	Clogged Filter Alarm Condenser temperature is outside of normal operating range. Condenser filter needs cleaning.	Clean filter. Allow time for sensor to react, then turn power off and back on again to reset.
E8	Defrost Temperature Sensor Malfunction Alarm Defrost temperature sensor has failed.	After replacing sensor, alarm will reset.
E9	Clogged Filter Sensor Malfunction Alarm Clogged filter sensor has failed.	After replacing sensor, alarm will reset.
EA	EEPROM Write Error Alarm Control board is defective.	After replacing the control board, alarm will reset.
ED	EEPROM Verification or Read Error Alarm Control board is defective.	After replacing the control board, alarm will reset.

1. Alarm Display Priority

If multiple alarms occur simultaneously, only the alarm with the higher priority is displayed.

Error Code	Priority	Description
ED	1	EEPROM Verification or Read Error Alarm
EA	2	EEPROM Write Error Alarm
E8	3	Defrost Temperature Sensor Malfunction Alarm
E9	4	Clogged Filter Sensor Malfunction Alarm
E4	5	High Pressure Alarm
E7	6	Clogged Filter Alarm
E3	7	Defrost Alarm
E1	8	High Temperature Alarm
E2	9	Low Temperature Alarm

2. Alarm Details and Countermeasures

a. High Temperature Alarm (E1)

If the cabinet temperature exceeds the setpoint temperature by 14.4°F (8°C) or more for more than x hours, "E1" is displayed. The default value of x is "2" (2 hours). The value of x can be changed under F3 on the Settings and Diagnostics Menu. (0=No delay; 1=1; 2=2; 3=3 hours)

Note:

- After the machine has been turned off and then turned back on, the high temperature alarm feature is not active until the cabinet temperature reaches the lower setpoint temperature differential.
- The high temperature alarm feature operates even during defrost.

Reset Options

The alarm will automatically reset once the cabinet temperature reaches the lower setpoint temperature differential.

Possible Causes

- The door is opened frequently or is not completely closed.
- Trouble with the compressor or a gas leak.
- Trouble with the cabinet thermistor (black).

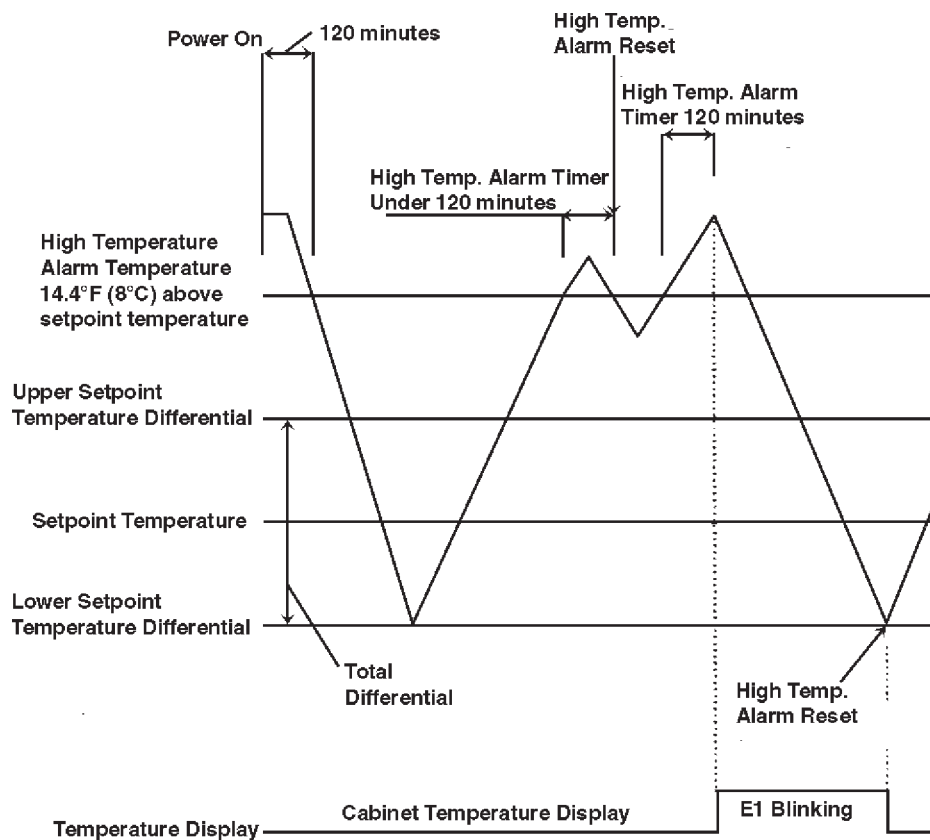

b. Low Temperature Alarm (E2)

If the cabinet temperature drops below the setpoint temperature by 9°F (5°C) or more for more than y minutes, "E2" is displayed. The default value of y is "1" (1 hour). The value of y can be changed under F4 on the Settings and Diagnostics Menu. (0=No delay; 1=1 hour)

Note:

- The low temperature alarm timer starts once the cabinet temperature drops 9°F (5°C) below the setpoint temperature.
- The low temperature alarm feature operates even during defrost.

Reset Options

The alarm will automatically reset once the cabinet temperature reaches the upper setpoint temperature differential.

Possible Causes

- Ambient temperature is low.
- Trouble with the cabinet thermistor (black).

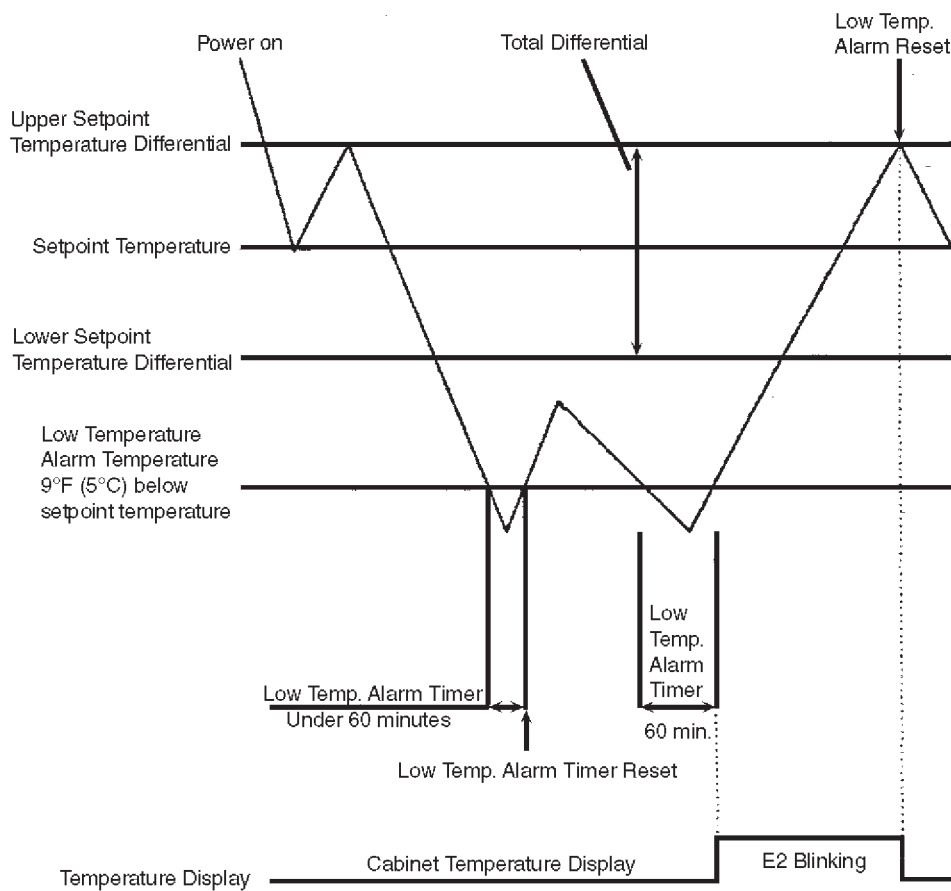

c. Defrost Alarm (E3)

If the defrost thermistor does not turn off in one hour after defrost begins, "E3" is displayed. When "E3" is displayed, the next step in the defrost termination process (drain - fan delay - defrost display delay) begins.

Reset Options

To reset the alarm, turn the unit off and then back on.

Possible Causes

- Trouble with the defrost heater.
- The temperature fuse is blown.
- Trouble with the defrost thermistor (orange).

d. High Pressure Alarm (E4)

In order to protect the compressor if the discharge pressure reaches a preset value (outside the normal operating range), a switch will temporarily stop the compressor. At another preset pressure, the compressor will attempt to restart. If the switch is triggered 5 or more times in one hour, "E4" will be displayed.

Reset Options

To reset the alarm, turn the unit off and then back on.

Possible Causes

- The condenser air filter is dirty.
- There is blockage or contamination inside the capillary tube or elsewhere in the refrigeration circuit.
- The condenser fan motor is locked or otherwise not functioning.

e. Clogged Filter Alarm (E7)

The unit is equipped with a filter for protecting the condenser from dirt, oils, grease, etc. The filter promotes clean condenser surfaces and efficient operation and should be checked twice monthly and cleaned when necessary. The unit is also equipped with a sensor to determine if this filter is excessively dirty. If the unit detects that the condenser filter is excessively dirty by sensing a temperature at the condenser outlet of at least 136.4°F (58°C) for over 2 minutes, "E7" will be displayed.

Reset Options

After cleaning the filter, the alarm will automatically reset once the temperature at the condenser outlet drops below 136.4°F (58°C).

Possible Causes

- The condenser air filter is dirty.
- The condenser fan motor is locked or otherwise not functioning.

IMPORTANT

If this alarm occurs frequently, the compressor discharge temperature is consistently too high.

Note:

- If the unit is turned off and then back on while the alarm code is displayed, the alarm may be reset even if the filter is not yet clean. However, the alarm will recur once the compressor discharge temperature reaches 136.4°F (58°C).

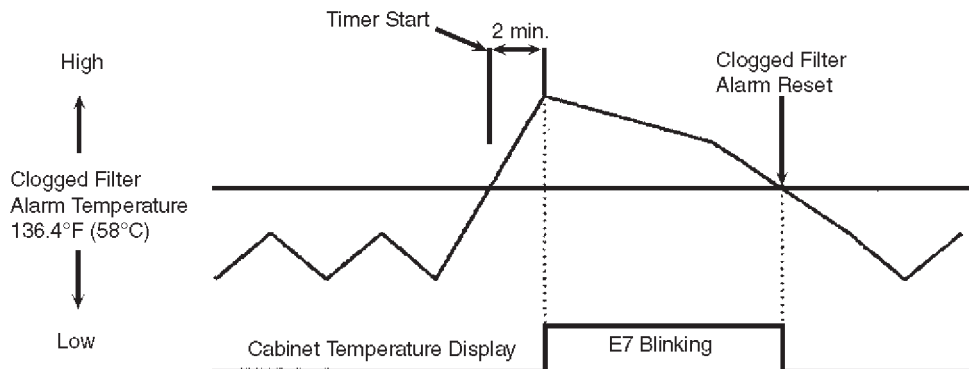

f. Defrost Temperature Sensor Malfunction Alarm (E8)

If input from the defrost thermistor is below the defrost open circuit detection point (equivalent to -67°F (-55°C)), "E8" is displayed. "E8" is also displayed when input from the defrost thermistor is above the defrost thermistor short circuit detection point (equivalent to 122°F (50°C)) for 10 minutes or more.

Note:

- If this alarm appears, first make sure that the sensor is properly connected.
- A short circuit will not be detected during the first hour after power is turned on. However, a short circuit can be detected immediately by turning on the power while pressing the **SET** button. In this case, "E8" will be displayed immediately if a short circuit is detected.
- A short circuit will not be detected during defrost or fan delay.

Reset Options

The alarm automatically resets when one of the following conditions is met:

- The input from the defrost thermistor exceeds the open circuit detection point (equivalent to -67°F (-55°C)).
- The input from the defrost thermistor drops below the short circuit detection point (equivalent to 122°F (50°C)).
- A functioning defrost thermistor (orange) is installed.

Possible Causes

- Trouble with the defrost thermistor (orange).

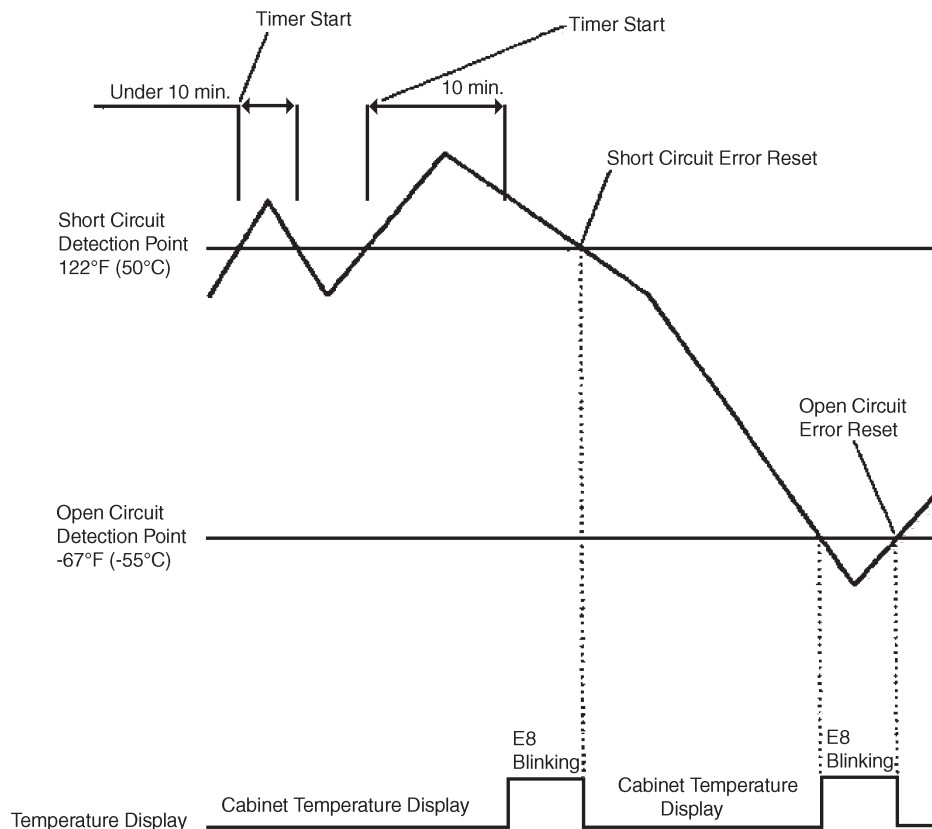

g. Clogged Filter Sensor Malfunction Alarm (E9)

If the input from the clogged filter sensor is below the clogged filter sensor open circuit detection point (equivalent to -7.6°F (-22°C)), "E9" is displayed. "E9" is also displayed when input from the clogged filter sensor is above the clogged filter sensor short circuit detection point (equivalent to 186.8°F (86°C)) for 10 minutes or more.

Note:

- If this alarm appears, first make sure that the sensor is properly connected.
- A short circuit can be detected immediately by turning on the power while pressing the **SET** button. In this case, "E9" will be displayed immediately if a short circuit is detected.

Reset Options

The alarm automatically resets when one of the following conditions is met:

- The input from the clogged filter sensor exceeds the open circuit detection point (equivalent to -7.6°F (-22°C)).
- The input from the clogged filter sensor drops below the short circuit detection point (equivalent to 186.8°F (86°C)).
- A functioning clogged filter sensor (gray) is installed.

Possible Causes

- Trouble with the clogged filter sensor (gray).

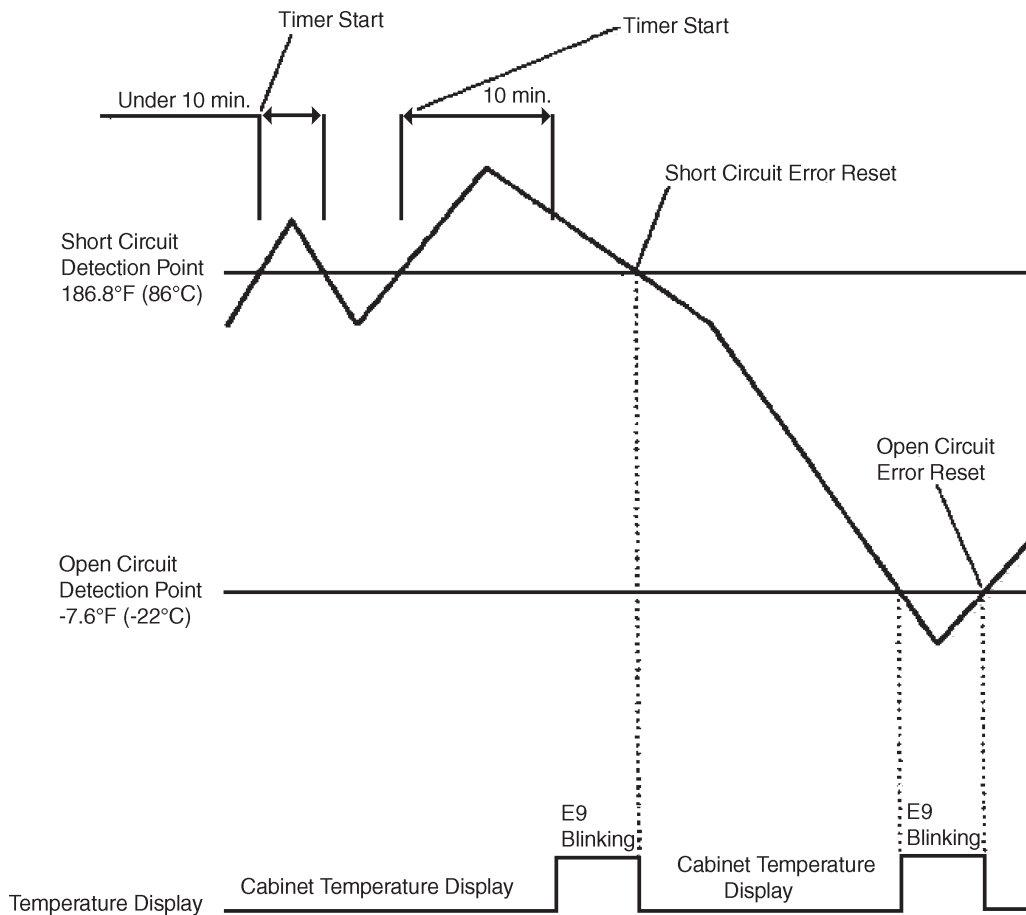

h. Control Board Error Alarms (EA and ED)

"EA" is displayed when an EEPROM write error is detected. "ED" is displayed when an EEPROM verification or read error is detected.

Reset Options

Replacing the control board with a functioning replacement control board will eliminate this error condition.

B. Diagnosis Chart

Problem	Possible Cause	Remedy	
[1] Compressor will not start—no current draw.	a) Power Supply	1. "OFF" position.	1. Move to "ON" position.
		2. Loose connection(s).	2. Tighten or reconnect.
		3. Failure.	3. Call electrician.
	b) Cord and Plug	1. Defective.	1. Replace.
	c) Circuit Breaker (kitchen)	1. Tripped.	1. Check and reset. Call electrician if breaker trips repeatedly.
		2. Defective.	2. Call electrician.
	d) Transformer	1. Open coil winding.	1. Check continuity and replace.
	e) Wiring to Control Board	1. Loose connection(s).	1. Tighten.
		2. Faulty.	2. Check continuity and replace.
	f) Voltage	1. Too low.	1. Call electrician.
		2. Too high.	2. Call electrician.
	g) High Pressure Switch	1. Bad contacts.	1. Check continuity and replace.
		2. Has operated 5 or more times in one hour. (E4 should be displayed)	2. Determine why pressure switch is activated.
h) Thermistor	1. Defective.	1. Check and replace.	
i) Control Board	1. Defective.	1. Replace control board.	
j) Compressor Overload	1. Defective. (Contacts open)	1. Replace.	
k) Compressor	1. Open windings.	1. Check continuity and replace.	
l) Relay (Condensing Unit)	1. Bad contacts.	1. Replace.	
	2. Open coil winding.	2. Check and replace.	
[2] Compressor will not run—draws current and trips on overload.	a) Voltage	1. Too low.	1. Call electrician.
	b) Start Relay	1. Bad contacts.	1. Replace.
		2. Open coil windings.	2. Replace.
	c) Compressor	1. Locked rotor.	1. Replace.
d) Start Capacitor	1. Defective.	1. Check and replace.	
[3] Compressor runs intermittently and trips on overload.	a) Voltage	1. Too low.	1. Call electrician.
		2. Too high.	2. Call electrician.
	b) Condenser Filter	1. Clogged.	1. Clean filter.
	c) Refrigerant Line or Component	1. Plugged or restricted.	1. Clean and replace drier. Clean and replace capillary tube heat exchanger assembly.
	d) Condenser Fan Motor	1. Failed.	1. Replace.
	e) Refrigerant	1. Overcharged.	1. Evacuate and recharge.
		2. Non-condensibles in system.	2. Evacuate and recharge.
f) Location of Unit	1. Restricted air flow to condenser.	1. Move unit or increase ventilation.	
[4] Cabinet temperature too high; compressor will not start.	a) Thermistor	1. Defective.	1. Check and replace.
	b) Compressor Relay	1. Defective.	1. Check and replace.
	c) Control Board	1. Defective.	1. Replace.

Problem	Possible Cause		Remedy
[5] Cabinet temperature too high.	a) Setpoint and/or Differential	1. Incorrect.	1. Correct setting(s). See sections "II.D.2.b)" and "II.D.3.c)" for defaults.
	b) Door	1. Not sealing, opened frequently or open for long intervals.	1. Check for sealing, check for door open at time of warm cabinet temperature.
	c) Defrost	1. Defrost time insufficient to remove frost. Operation in humid conditions.	1. See "[8] Evaporator does not defrost completely."
	d) Refrigerant	1. Leak.	1. Repair leak and recharge.
	e) Fan Motor	1. Defective.	1. Check and replace.
	f) Air Filter	1. Clogged.	1. Clean.
	g) Condenser	1. Dirty.	1. Clean.
	h) Thermistor	1. Defective.	1. Check and replace.
	i) Control Board	1. Defective.	1. Replace.
	j) Outside Heat Source	1. Too close to unit.	1. Separate unit from heat source.
	k) Air Flow	1. Blockage inside interior.	1. Remove blockage by removing or redistributing food product.
l) Warm Food	1. Warm food recently placed in refrigerator.	1. Allow time for unit to return to setpoint temperature.	
[6] Cabinet temperature display indicator does not illuminate properly.	a) Power Supply	1. "OFF" position.	1. Move to "ON" position.
		2. Loose connection(s).	2. Tighten or reconnect.
		3. Failure or tripped breaker.	3. Call electrician and/or reset breaker.
b) Control Board	1. Defective.	1. Replace.	
[7] Cabinet temperature too low.	a) Setpoint and/or Differential	1. Incorrect.	1. Correct setting(s). See sections "II.D.2.b)" and "II.D.3.c)" for defaults.
	b) Frozen Food	1. Frozen food recently placed in refrigerator.	1. Allow time for unit to return to setpoint temperature.
	c) Thermistor	1. Defective.	1. Check and replace.
	d) Compressor Relay	1. Defective; contacts welded.	1. Replace.
	e) Control Board	1. Defective.	1. Replace.
[8] Evaporator does not defrost completely.	a) Defrost Thermistor	1. Defective.	1. Check and replace.
	b) Defrost	1. Not enough defrosts occurring per day. Operation in humid conditions.	1. Factory default is once every 6 hours. If coil is frosting too much, can shorten defrost interval.
	c) Defrost Heaters	1. Defective.	1. Replace heaters.
	d) Safety Defrost Thermostat	1. Defective, turning off heaters prematurely, or fused open.	1. Replace safety defrost thermostat.
	e) Defrost Heater Temperature Fuse	1. Blown.	1. Determine why fuse blew. Replace fuse.

Problem	Possible Cause		Remedy
[9] Defrost cycle lasts too long.	a) Defrost Thermistor	1. Defective.	1. Replace.
	b) Control Board	1. Defective.	1. Replace.
	c) Defrost	1. Not enough defrosts occurring per day. Operation in humid conditions.	1. Factory default is once every 6 hours. If coil is frosting too much, can shorten defrost interval.
	d) Defrost Heater	1. Defective.	1. Replace heaters.
	e) Safety Defrost Thermostat	1. Defective, turning off heaters prematurely, or fused open.	1. Replace safety defrost thermostat.
[10] Condensate water overflow.	a) Cabinet Contents	1. Loading of large volumes of warm, moist, uncovered product.	1. Cover product with plastic wrap.
	b) Location of Unit	1. Unit located near high humidity source such as fryer, steamer, etc.	1. Relocate.
	c) Seals	1. Poor sealing around evaporator, door gaskets.	1. Adjust or replace.
	d) Environment	1. Extreme environment and door-opening conditions.	1. Adjust conditions.
[11] Abnormal Noise	a) Fasteners	1. Loose fasteners allow vibration of part.	1. Tighten fasteners.
	b) Compressor	1. Problem with mount.	1. Properly mount compressor. Replace any missing grommets.
		2. Floodback to compressor.	2. Check for signs of floodback to compressor. Evacuate and recharge if necessary.
		3. Defective.	3. Replace.
	c) Fan	1. Fan blade loose.	1. Adjust and tighten.
		2. Defective motor.	2. Replace.
d) Relay	1. Chattering.	1. Replace.	

C. Thermistor Check

A thermistor (semiconductor) is used for the cabinet control sensor and defrost termination sensor. The resistance varies depending on temperature. No adjustment is required. If necessary, check for resistance between thermistor leads and visually check the thermistor mounting.

Temperature		Resistance (kΩ)	
°F	°C	Cabinet/Defrost Thermistors	Clogged Filter Thermistor
0	-17.8	14.2	-
10	-12.2	10.7	-
32	0.0	6.0	160
50	10.0	3.9	100
70	21.1	2.5	59
90	32.2	1.6	36

Cabinet & Defrost Thermistor T-R Curve

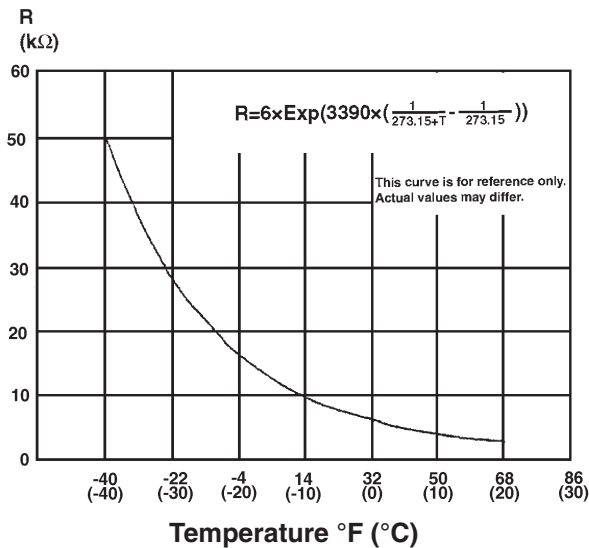

Clogged Filter Thermistor T-R Curve

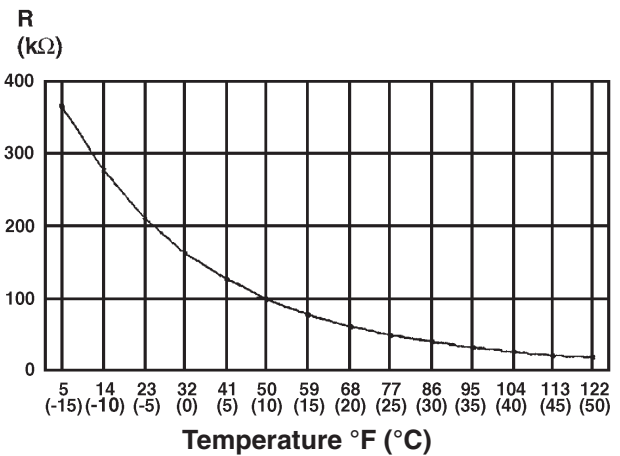

To check a thermistor's resistance, follow the steps below.

- 1) Disconnect the connector for the thermistor in question under the control box and behind the wire guard.
- 2) Remove the thermistor. See "IV.F. Removal and Replacement of Thermistors."
- 3) Immerse the thermistor sensor portion in a glass or cup containing ice and water for 2 or 3 minutes.
- 4) Check for a resistance between thermistor leads. Normal reading is from 5 to 6.5kΩ for the cabinet and defrost thermistors and 145 to 175kΩ for the clogged filter sensor. Replace the thermistor if it exceeds the normal reading.

IV. Removal and Replacement of Components

IMPORTANT

1. Ensure all components, fasteners, and thumbscrews are securely in place after the equipment is serviced.
2. The Polyol Ester (POE) oils used in all units can absorb moisture quickly. Therefore it is important to prevent moisture from entering the system when replacing or servicing parts.
3. Always install a new drier every time the sealed refrigeration system is opened. Do not replace the drier until after all other repair or replacement has been made.
4. Do not leave the system open for longer than 15 minutes when replacing or servicing parts.

A. Service for Refrigerant Lines

WARNING

Use an electronic leak detector or soap bubbles to check for leaks. Add a trace of refrigerant to the system (if using an electronic leak detector), and then raise the pressure using nitrogen gas (140 PSIG). DO NOT use R-404A or R-134a as a mixture with pressurized air for leak testing.

1. Refrigerant Recovery

The undercounter unit is provided with a refrigerant access valve. Using proper refrigerant practices, recover the refrigerant from the access valve and store it in an approved container. Do not discharge the refrigerant into the atmosphere.

2. Brazing

WARNING

1. R-404A and R-134a are not flammable at atmospheric pressure and temperatures up to 176°F (80°C).
2. R-404A and R-134a themselves are not explosive or poisonous. However, when exposed to high temperatures (open flames), these refrigerants can be decomposed to form hydrofluoric acid and carbonyl fluoride both of which are hazardous.
3. Always recover the refrigerant and store it in an approved container. Do not discharge the refrigerant into the atmosphere.
4. Do not use silver alloy or copper alloy containing arsenic.
5. Use an electronic leak detector or soap bubbles to check for leaks. Add a trace of refrigerant to the system (if using an electronic leak detector), and then raise the pressure using nitrogen gas (140 PSIG). DO NOT use R-404A or R-134a as a mixture with pressurized air for leak testing.

- 1) Always install a new drier every time the sealed refrigeration system is opened. Do not replace the drier until after all other repair or replacement has been made. Install the new drier with the arrow on the drier in the direction of the refrigerant flow.
- 2) Braze all fittings while purging with nitrogen gas flowing at a pressure of 3 to 4 PSIG
Note: Because the pipes in the evaporator case are specially coated to resist corrosion, it is important to make connections outside the evaporator case when possible. If it is necessary to braze inside the evaporator case, use sandpaper to remove the coating from the brazing connections before unbrazing the components.
- 3) Use an electronic leak detector or soap bubbles to check for leaks. Add a trace of refrigerant to the system (if using an electronic leak detector), and then raise the pressure using nitrogen gas (140 PSIG). DO NOT use R-404A or R-134a as a mixture with pressurized air for leak testing.

3. Evacuation and Recharge

- 1) Attach a vacuum pump to the system using the low-side access valve.

IMPORTANT

The vacuum level and vacuum pump may be the same as those for current refrigerants. However, the rubber hose and gauge manifold to be used for evacuation and refrigerant charge should be exclusively for POE oils.

- 2) Turn on the vacuum pump. Open the low-side service manifold valve. Never allow the oil in the vacuum pump to flow backwards.
- 3) Allow the vacuum pump to pull down to a 29.9" Hg vacuum. Evacuating period depends on pump capacity.
- 4) Close the low-side service manifold valve.
- 5) Turn off the vacuum pump. Disconnect the vacuum pump hose and attach it to a refrigerant service cylinder. Remember to loosen the connection, and purge the air from the hose. See the nameplate for the required refrigerant charge. Hoshizaki recommends only virgin refrigerant or reclaimed refrigerant which meets ARI Standard No. 700 (latest edition) be used.
- 6) A liquid charge is required for charging an R-404A system and optional for charging an R-134a system. Invert the service cylinder and place it on scales. Open the low-side service manifold valve.

IMPORTANT

In order to prevent compressor damage, use caution in charging large quantities of liquid into the low side.

- 7) Allow the system to charge with liquid until the proper charge weight is met.
- 8) Close the refrigerant service cylinder access valve and disconnect the hose. Close the service manifold valve and disconnect the low-side hose.
- 9) Cap the access valve to prevent a possible leak.

B. Removal and Replacement of Refrigeration Unit

- 1) Turn off the power supply, and unplug the unit.
- 2) Remove the front panel, then remove the wire guard located below the display panel.
- 3) Unhook the wiring connectors at the control box, then remove the two hex-head M6 attachment nuts and the M5 bolt.
- 4) Very carefully slide out the refrigeration unit. Support the evaporator as it clears the evaporator case.
- 5) Replace the removed parts in the reverse order of which they were removed.
- 6) Replace the front panel and all other guards in their correct positions.
- 7) Plug in the unit, and turn on the power supply.

CAUTION

1. To avoid a gas leak, be sure to prevent the refrigeration piping from coming into contact with the body when taking out and returning the refrigeration unit to its original position.
2. Do not let the fan motor or high pressure pipe touch wires.

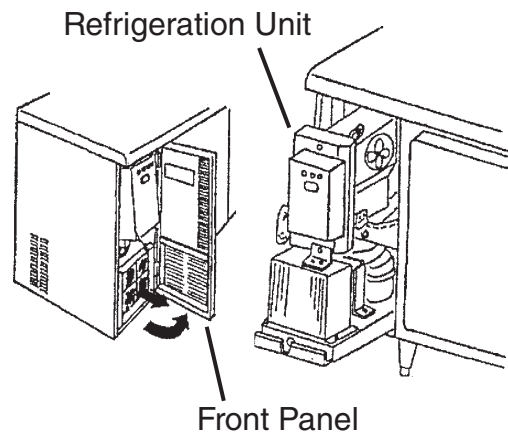

C. Removal and Replacement of Compressor

IMPORTANT

Always install a new drier every time the sealed refrigeration system is opened. Do not replace the drier until after all other repair or replacement has been made.

Note: When replacing a compressor with a defective winding, be sure to install a new start capacitor, overload and start relay. Due to the ability of the POE oil in the compressor to absorb moisture quickly, the compressor must not be opened more than 15 minutes for replacement or service. Do not mix lubricants of different compressors even if both are charged with the same type of refrigerant, except when they use the same lubricant.

- 1) Turn off the power supply, and unplug the unit.
- 2) Remove the front panel, then remove the wire guard located below the display panel.
- 3) Unhook the wiring connectors at the control box, then remove the two hex-head M6 attachment nuts and the M5 bolt.
- 4) Very carefully slide out the refrigeration system. Support the evaporator as it clears the evaporator case.
- 5) Recover the refrigerant and store it in an approved container.
- 6) Remove the terminal cover on the compressor and disconnect the compressor wiring.
- 7) Remove the discharge, process, and suction pipes.
- 8) Remove the hold-down bolts, washers, rubber grommets, and sleeves.
- 9) Remove the compressor. Unpack the new compressor. Attach the rubber grommets and sleeves of the prior compressor.
- 10) Place the new compressor in position, and secure it using the bolts and washers.
- 11) Remove the drier, then place the new drier in position.
- 12) Remove the plugs from the suction, discharge and process pipes.
- 13) Braze all fittings while purging with nitrogen gas flowing at a pressure of 3 to 4 PSIG.
- 14) Use an electronic leak detector or soap bubbles to check for leaks. Add a trace of refrigerant to the system (if using an electronic leak detector), and then raise the pressure using nitrogen gas (140 PSIG). DO NOT use R-404A or R-134a as a mixture with pressurized air for leak testing.
- 15) Evacuate the system, and charge it with refrigerant; see the nameplate for the required refrigerant charge.
- 16) Connect the terminals, then replace the terminal cover in its correct position.
- 17) Return the refrigeration unit to its proper position in the reverse order of the removal procedure.
- 18) Plug in the unit, and turn on the power supply.

D. Removal and Replacement of Evaporator

IMPORTANT

Always install a new drier every time the sealed refrigeration system is opened. Do not replace the drier until after all other repair or replacement has been made. Install the new drier with the arrow on the drier in the direction of the refrigerant flow.

- 1) Turn off the power supply, and unplug the unit.
- 2) Remove the front panel, then remove the wire guard located below the display panel.
- 3) Unhook the wiring connectors at the control box, then remove the two hex-head M6 attachment nuts and the M5 bolt.

- 4) Very carefully slide out the refrigeration system. Support the evaporator as it clears the evaporator case.
- 5) Recover the refrigerant and store it in an approved container.
- 6) Remove the four 4×8 T2 screws holding the evaporator to the evaporator bracket and provide a safe means for supporting the evaporator away from the ABS liner of the evaporator case cover.
- 7) Remove the thermistors and thermal fuse. Protect any wiring from damage due to the brazing torch.
- 8) Remove the insulation tubing, and disconnect the evaporator inlet and outlet tubing.

CAUTION

Be careful when handling the evaporator shroud assembly. This assembly includes a defrost heater sheathed in a glass tube. This sheathing can be easily damaged and may also cause cuts if broken. Heater will also be hot after a defrost. Use gloves when handling and avoid touching the glass directly. Also prevent heaters from touching other parts.

- 9) Remove the six 4×8 T2 screws attaching the shrouds to the evaporator unit and remove the shrouds. Remove the defrost thermistor if necessary to remove the shrouds.
- 10) Remove the evaporator and drier.
- 11) Place the new evaporator and new drier in position.
- 12) Braze all fittings while purging with nitrogen gas flowing at a pressure of 3 to 4 PSIG.

CAUTION

1. Care must be taken to ensure that the capillary tube is not blocked or contaminated during this process.
2. Ensure that the capillary tube extends inside the mating tubing 1 to 1 3/8" (25 to 35 mm).

- 13) Use an electronic leak detector or soap bubbles to check for leaks. Add a trace of refrigerant to the system (if using an electronic leak detector), and then raise the pressure using nitrogen gas (140 PSIG). DO NOT use R-404A or R-134a as a mixture with pressurized air for leak testing.
- 14) Evacuate the system, and charge it with refrigerant. See the nameplate for the required refrigerant charge.
- 15) Replace the removed parts in the reverse order of which they were removed.
- 16) Replace the front panel and all other guards in their correct positions.
- 17) Plug in the unit, and turn on the power supply.

E. Removal and Replacement of Capillary Tube / Suction Line Assembly

IMPORTANT

Always install a new drier every time the sealed refrigeration system is opened. Do not replace the drier until after all other repair or replacement has been made. Install the new drier with the arrow on the drier in the direction of the refrigerant flow.

- 1) Turn off the power supply, and unplug the unit.
- 2) Remove the front panel, then remove the wire guard located below the display panel.
- 3) Unhook the wiring connectors at the control box, then remove the two hex-head M6 attachment nuts and the M5 bolt.
- 4) Very carefully slide out the refrigeration system. Support the evaporator as it clears the evaporator case.
- 5) Recover the refrigerant and store it in an approved container.
- 6) Remove the insulation on the suction line.
- 7) Remove the four 4x8 T2 screws holding the evaporator to the evaporator bracket and provide a safe means for supporting the evaporator away from the ABS liner of the evaporator case cover. Protect any wiring from damage due to the brazing torch.
- 8) Remove the capillary tube / suction line assembly and drier.
- 9) Place the new capillary tube / suction line assembly and new drier in position.
- 10) Braze all fittings while purging with nitrogen gas flowing at a pressure of 3 to 4 psig.

CAUTION

1. Care must be taken to ensure that the capillary tube is not blocked or contaminated during this process.
2. Ensure that the capillary tube extends inside the mating tubing 1 to 1 3/8" (25 to 35 mm).

- 11) Use an electronic leak detector or soap bubbles to check for leaks. Add a trace of refrigerant to the system (if using an electronic leak detector), and then raise the pressure using nitrogen gas (140 PSIG). DO NOT use R-404A or R-134a as a mixture with pressurized air for leak testing.
- 12) Insulate the entire suction line between the compressor and evaporator case.
- 13) Evacuate the system, and charge it with refrigerant; see the nameplate for the required refrigerant charge.
- 14) Return the refrigeration unit to its proper position in the reverse order of the removal procedure.
- 15) Plug in the unit, and turn on the power supply.

F. Removal and Replacement of Thermistors

- 1) Turn off the power supply, and unplug the unit.
- 2) Remove the front panel, then remove the wire guard located below the display panel.
- 3) Unhook the wiring connectors at the control box, then remove the two hex-head M6 attachment nuts and the M5 bolt.
- 4) Very carefully slide out the refrigeration system. Support the evaporator as it clears the evaporator case. For the remainder of the procedure, see the appropriate section below.

Cabinet Thermistor

- 5) Cut the cable tie holding the cabinet thermistor to the bracket attached to the fan motor side of the evaporator shroud. Remove the thermistor.
- 6) Remove the thermistor wire connection (below the control box).
- 7) Install the new thermistor and return the refrigeration unit to its proper position in the reverse order of the removal procedure.
- 8) Plug in the unit, and turn on the power supply.

Defrost Thermistor

- 5) The defrost thermistor element is secured to the top of the evaporator with aluminum tape, and the wire is secured with a cable tie. Remove each with care.
- 6) Remove the thermistor wire connection (below the control box).
- 7) Install the new thermistor and return the refrigeration unit to its proper position in the reverse order of the removal procedure.
- 8) Plug in the unit, and turn on the power supply.

Clogged Filter Thermistor (sensor)

- 5) The thermistor element is secured to the condenser outlet pipe with aluminum tape, and the wire is secured with a cable tie. Remove each with care.
- 6) Remove the thermistor wire connection (below the control box).
- 7) Install the new thermistor and return the refrigeration unit to its proper position in the reverse order of the removal procedure.
- 8) Plug in the unit, and turn on the power supply.

G. Removal and Replacement of Door Gasket

Remove old gasket by pulling it directly out of the vinyl gasket retainer. Thoroughly clean the gasket area with mild soap and water prior to installing the new gasket. The new gasket should be installed by assembling it at the corners first, then working toward the center at the top, bottom and sides. The arrow-shaped portion of the gasket should be firmly seated in the retainer groove for proper assembly. This can be checked by lifting the edge of the gasket and observing the engagement.

CAUTION

In order to get a proper gasket fit, it is important not to stretch gasket material during assembly.

H. Removal and Replacement of Defrost Heater

- 1) Turn off the power supply, and unplug the unit.
- 2) Remove the front panel, then remove the wire guard located below the display panel.
- 3) Unhook the wiring connectors at the control box, then remove the two hex-head M6 attachment nuts and the M5 bolt.
- 4) Very carefully slide out the refrigeration system. Support the evaporator as it clears the evaporator case.
- 5) Remove the connection lead wire for the defrost heater.
- 6) Remove the two 4x8 T2 evaporator shroud screws above each end of the defrost heater.
- 7) Carefully remove the defrost heater by twisting the ends together and removing the ends from the slots in the shroud.
- 8) Return the refrigeration unit to its proper position in the reverse order of the removal procedure.
- 9) Plug in the unit, and turn on the power supply.

CAUTION

Be careful when handling both the old and new defrost heaters. The heaters are sheathed in glass tubes and can possibly cause cuts if broken. Heater will also be hot after a defrost. Use gloves when handling. Avoid touching the glass directly; hold the heaters by the ends.

I. Removal and Replacement of Control Board

IMPORTANT

When receiving a service call, please ask the customer to turn the power off, then turn it back on and monitor the condition for awhile. Even if the control board malfunctions for some reason, it may resume normal operation after the power is turned off once.

CAUTION

1. Fragile, handle very carefully.
2. The control board contains integrated circuits, which are susceptible to failure due to static discharge. It is especially important to touch the metal part of the unit when handling or replacing the board.
3. Do not touch the electronic devices on the board or the back of the board to prevent damage to the board.
4. Do not attempt to repair the board in the field. Always replace the whole board assembly if it goes bad.
5. Do not short out power supply to test for voltage.
6. Keep the thermistor leads, clogged filter sensor leads, and pressure switch leads at least 1.5" away from high voltage leads (AC 100 volts or more) to protect against electrical noise.

- 1) Turn off power and unplug the unit.
- 2) Remove the front panel.
- 3) Remove the wire guard, then remove all wiring connections at the bottom of the control box.
- 4) Remove the control box by loosening the 4x8 T2 screw securing the bottom control box bracket to the evaporator case cover.
- 5) Remove the three 4x8 T2 screws from the control box top and bottom, then carefully remove the control box cover.
- 6) Unhook all wiring connections to the control board.
- 7) Remove the control board by carefully removing the four 4x8 T2 attachment screws.
- 8) Identify the part number and software revision of the new board and make sure it is interchangeable with the old board.
- 9) Install the new board in the control box taking care not to damage it.
- 10) Hook all wiring connections back to the control board.
- 11) Check to make sure that the switches and buttons line up appropriately on the display panel and that they operate.
- 12) Replace all panels and guards.
- 13) Plug in the unit and turn on the power supply.

J. Removal and Replacement of Fan Motors

- 1) Turn off the power supply, and unplug the unit.
- 2) Remove the front panel, then remove the wire guard located below the display panel.
- 3) Unhook the wiring connectors at the control box, then remove the two hex-head M6 attachment nuts and the M5 bolt.
- 4) Very carefully slide out the refrigeration system. Support the evaporator as it clears the evaporator case. For the remainder of the procedure, see the appropriate section below.

Condenser Fan Motor

- 5) Disconnect the lead wire to the condenser fan motor.
- 6) Remove the two 5×10 condenser fan motor bracket attachment bolts and remove the condenser fan motor assembly.
- 7) Remove the fan motor from the attachment base and remove the fan blade from the fan motor.
- 8) Install the new fan motor and return the refrigeration unit to its proper position in the reverse order of the removal procedure.
- 9) Plug in the unit, and turn on the power supply.

Evaporator Fan Motor

- 5) Disconnect the lead wire to the evaporator fan motor.

CAUTION

Be careful when handling the evaporator shroud assembly. This assembly includes a defrost heater sheathed in a glass tube. This sheathing can be easily damaged and may also cause cuts if broken. Heater will also be hot after a defrost. Use gloves when handling and avoid touching the glass directly. Also prevent heaters from touching other parts.

- 6) Remove the eight 4×8 T2 screws attaching the shroud to the evaporator unit and remove the shroud. Remove the defrost thermistor if necessary to remove the shroud.
- 7) Remove the four 4×12 T2 evaporator fan motor attachment screws and remove the evaporator fan motor.
- 8) Install the new fan motor and return the refrigeration unit to its proper position in the reverse order of the removal procedure.
- 9) Plug in the unit, and turn on the power supply.

K. Door Re-Hinging and Drawer Conversion

Contact your local Hoshizaki distributor or Hoshizaki Technical Support (1-800-233-1940) if door reversing or drawer conversion is desired.

V. Cleaning and Maintenance Instructions

WARNING

1. Do not splash water directly onto the unit. This might cause short circuit, electric shock, corrosion or failure.
2. When cleaning or inspecting the unit, turn off the power switch and unplug the unit or disconnect the main power source to prevent electric shock, by unexpected entrance of water into the unit, or injury by any moving parts.
3. To prevent frostbite, do not touch foods or containers (especially metallic) in the freezer compartment with damp hands.
4. Before using a sanitizer such as inert soap and sodium hypochlorite, thoroughly read the manufacturer's instructions on the proper usage and amount.

IMPORTANT

1. To prevent damage to the painted or plastic surfaces, do not use the following: thinner, benzine, alcohol, petroleum, soap powder, polishing powder, alkaline cleaner, acid, scouring pad and especially those strong cleaners for use on a ventilating fan or a cooking range. Also, to prevent corrosion, do not use a chlorine bleach such as sodium hypochlorite on the stainless steel surfaces.
2. Use clean cloth and hands for cleaning.
3. Before cleaning the cabinet interior, move the stored foods into another clean refrigerator/freezer.

A. Cleaning

1. Stainless Steel Exterior

Wipe the exterior occasionally with a clean, soft cloth. Use a damp cloth containing a neutral cleaner to wipe off oil or dirt build up.

2. Stainless Steel Interior

Spills should be wiped up promptly to avoid unpleasant odors. The cabinet interior should be cleaned periodically with a mild soap or detergent.

3. Gaskets

Gaskets should be cleaned regularly with mild soap and water to remove dirt and grease.

4. Condenser

Check the condenser once a year and use a brush or vacuum cleaner to clean the unit as required.

5. Air Filter

As the air filter becomes clogged with dirt or dust, the unit's performance will be reduced. Do not operate the unit with the air filter removed. This will accelerate clogging of the condenser and result in failure. Check the filter at least twice each month. If it is dirty, use warm water and a neutral cleaner to wash the filter. To avoid damaging the air filter, do not use water hotter than 104°F (40°C). The filter is located behind the front panel. This filter can be removed by opening the front panel and lifting the filter away from the condenser. Reinstall the filter after cleaning.

6. Shelves

Remove and clean regularly.

7. Drawers

On units with drawers, the drawers can be removed for cleaning either individually or as an entire assembly.

- To remove an individual drawer, first remove all food product from the drawer. Pull the drawer out to its fully extended position and lift up on the handle to disengage the drawer. Before removing the drawer, carefully support the rear and front of the drawer and then slowly remove it from the cabinet.
- To remove the drawer frame assembly, first remove the drawers and then remove the fasteners in the thermal break and in the rear of the cabinet. Carefully slide the frame out of the cabinet, making sure not to damage the thermal break. Reinstall in the reverse order, making sure not to overtighten the screws in the thermal break.
- To remove the drawer slide (center slide containing rollers) for cleaning, rotate the top of the slide away from the frame while the slide is completely inside the cabinet. Drawer slides do not require lubrication, but slides should be kept clean and free of food.
Note: Drawer slides are dishwasher safe.

B. Maintenance

1. Air Filter

The air filter promotes clean condenser surfaces and efficient unit operation by removing dirt and grease from circulating air. The filter should be checked monthly and cleaned when necessary—as described in "A.5. Air Filter".

All other maintenance or service on this unit should be performed in accordance with the Hoshizaki Service Manual by a qualified service technician.

VI. Wiring Diagrams

A1. HUR40A, HWR40A (auxiliary code Q5 and earlier)

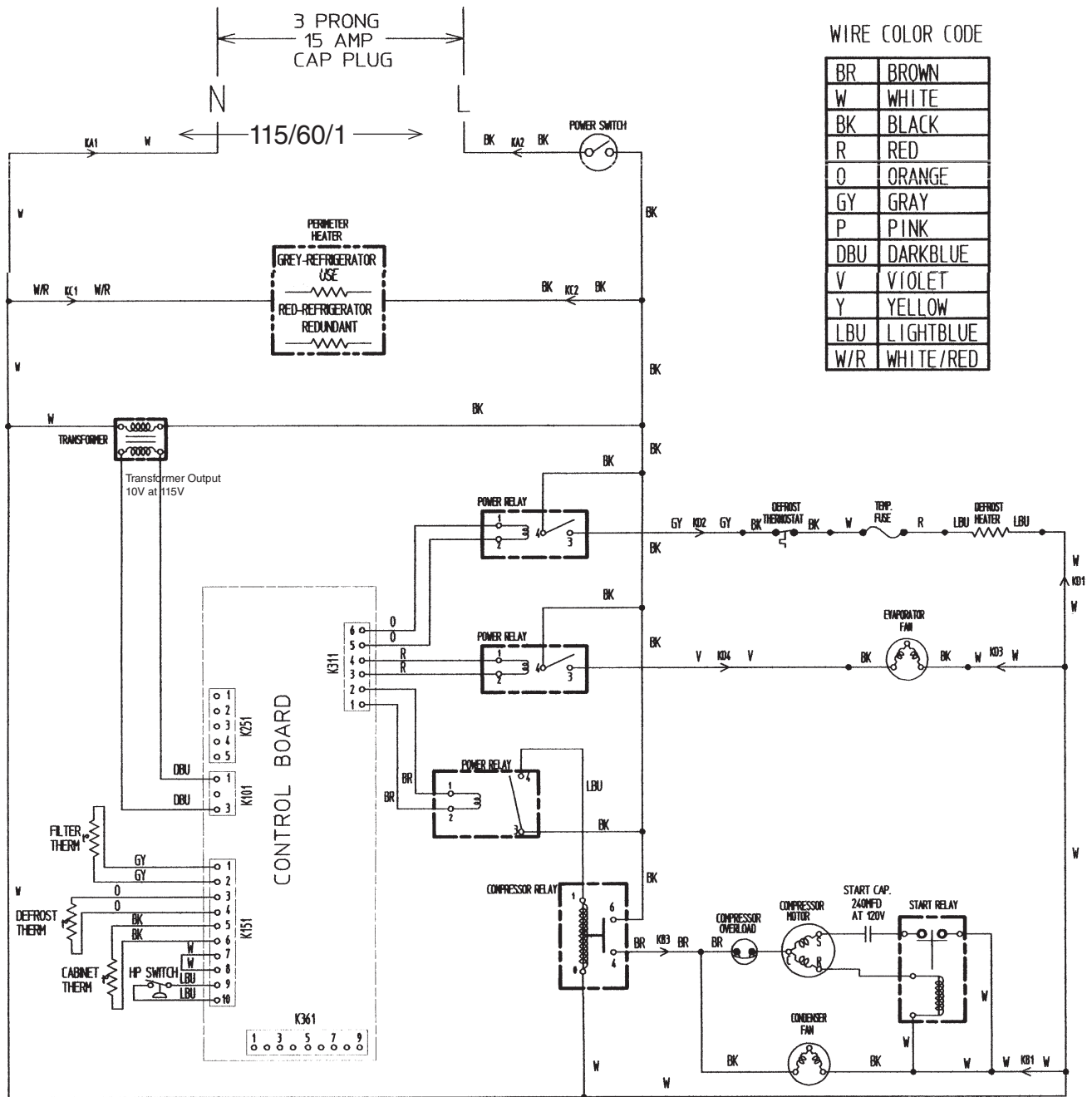

Note: Jumper (color: white) between pins 7 and 8 of connector K151 may not be present on all units, but this will not adversely affect performance.

CAUTION

Before diagnosing and/or servicing the unit, confirm that you have the proper wiring diagram by checking against the diagram located inside the front panel.

B. HUF40A(-D), HWF40A(-D)

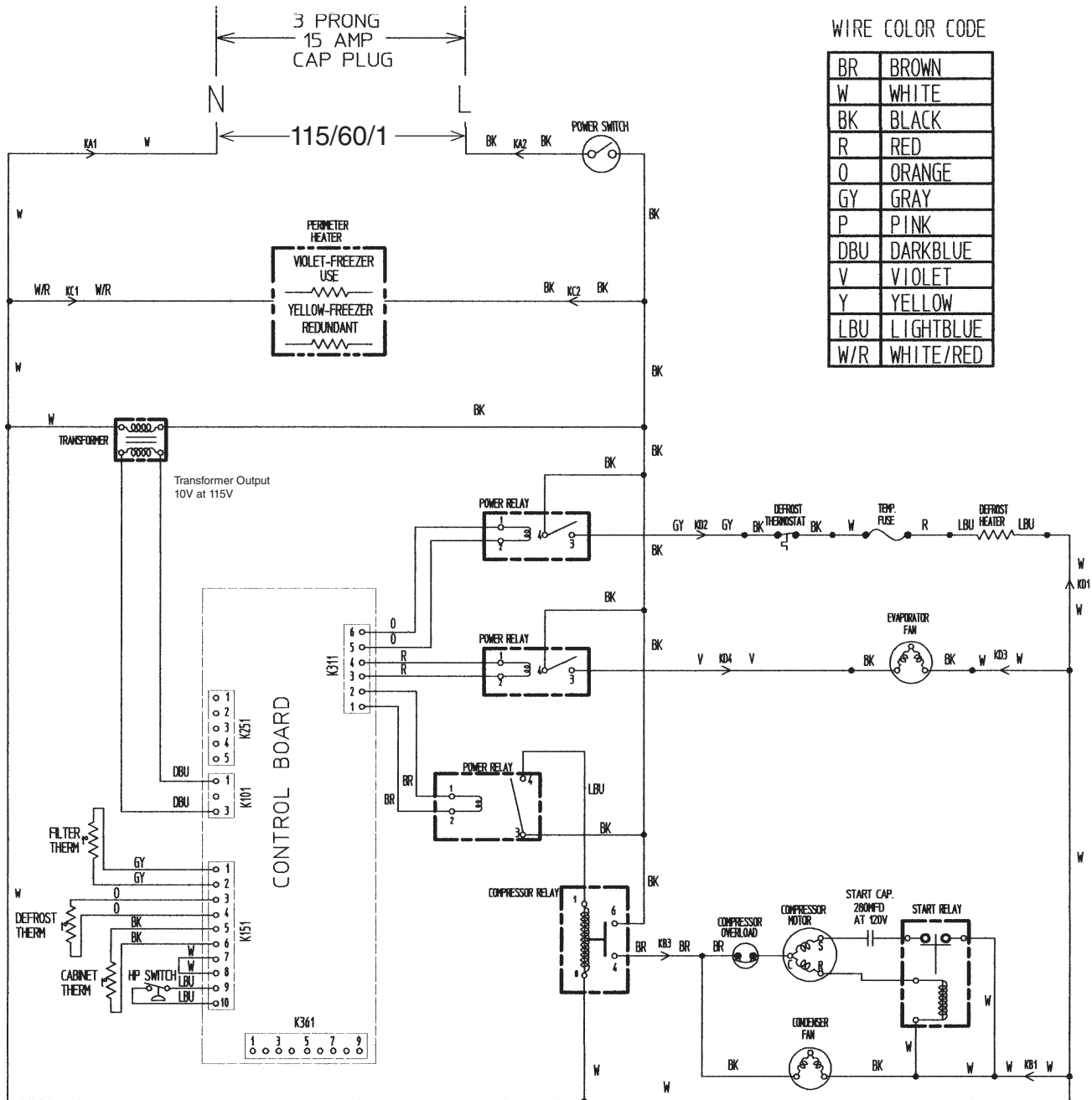

Note: Jumper (color: white) between pins 7 and 8 of connector K151 may not be present on all units, but this will not adversely affect performance.

CAUTION

Before diagnosing and/or servicing the unit, confirm that you have the proper wiring diagram by checking against the diagram located inside the front panel.

C1. HUR68A, HWR68A (auxiliary code Q5 and earlier)

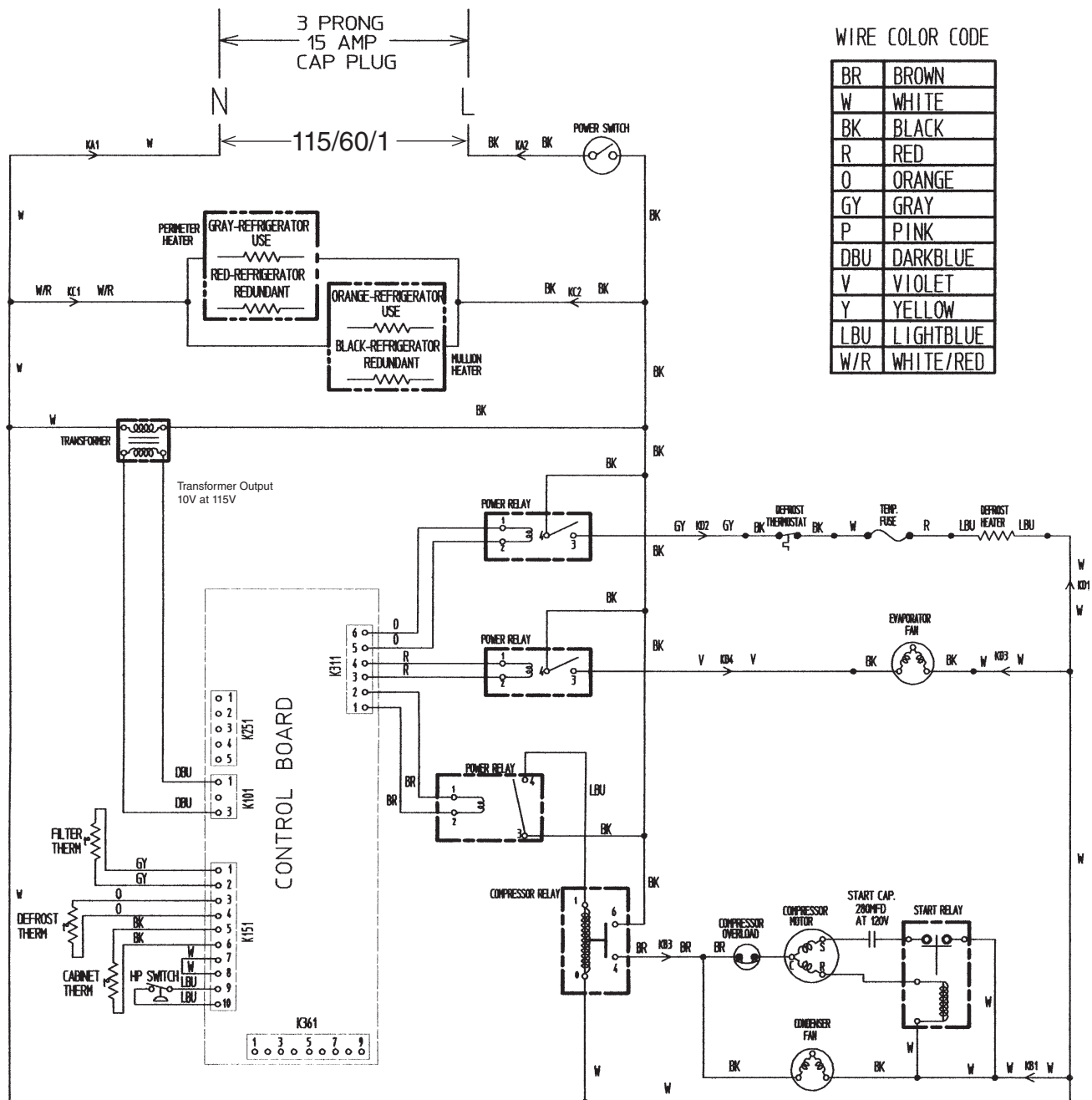

Note: Jumper (color: white) between pins 7 and 8 of connector K151 may not be present on all units, but this will not adversely affect performance.

CAUTION

Before diagnosing and/or servicing the unit, confirm that you have the proper wiring diagram by checking against the diagram located inside the front panel.

D. HUF68A(-D), HWF68A(-D)

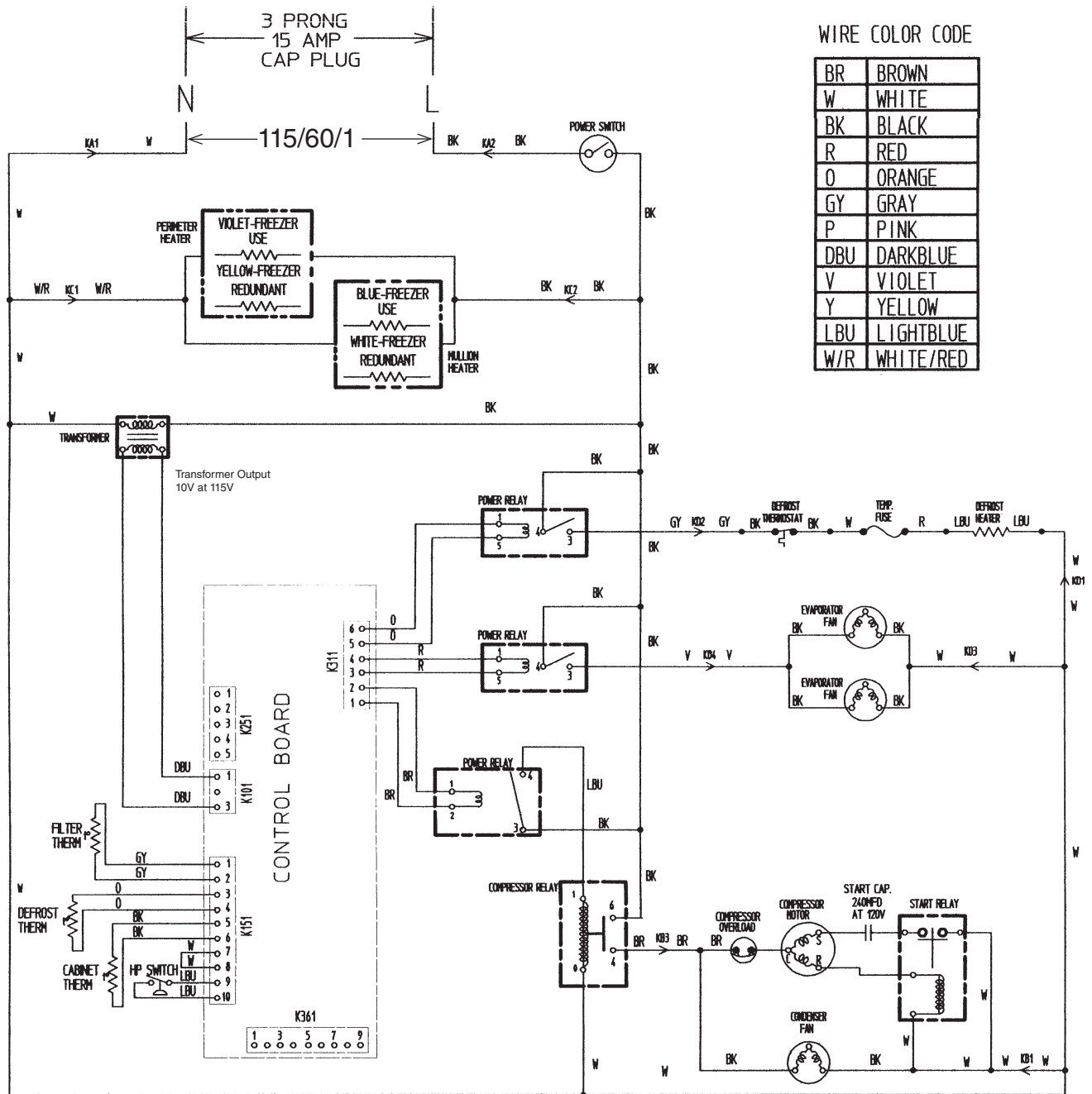

Note: Jumper (color: white) between pins 7 and 8 of connector K151 may not be present on all units, but this will not adversely affect performance.

CAUTION

Before diagnosing and/or servicing the unit, confirm that you have the proper wiring diagram by checking against the diagram located inside the front panel.

E. HUR96A(-D), HWR96A(-D)

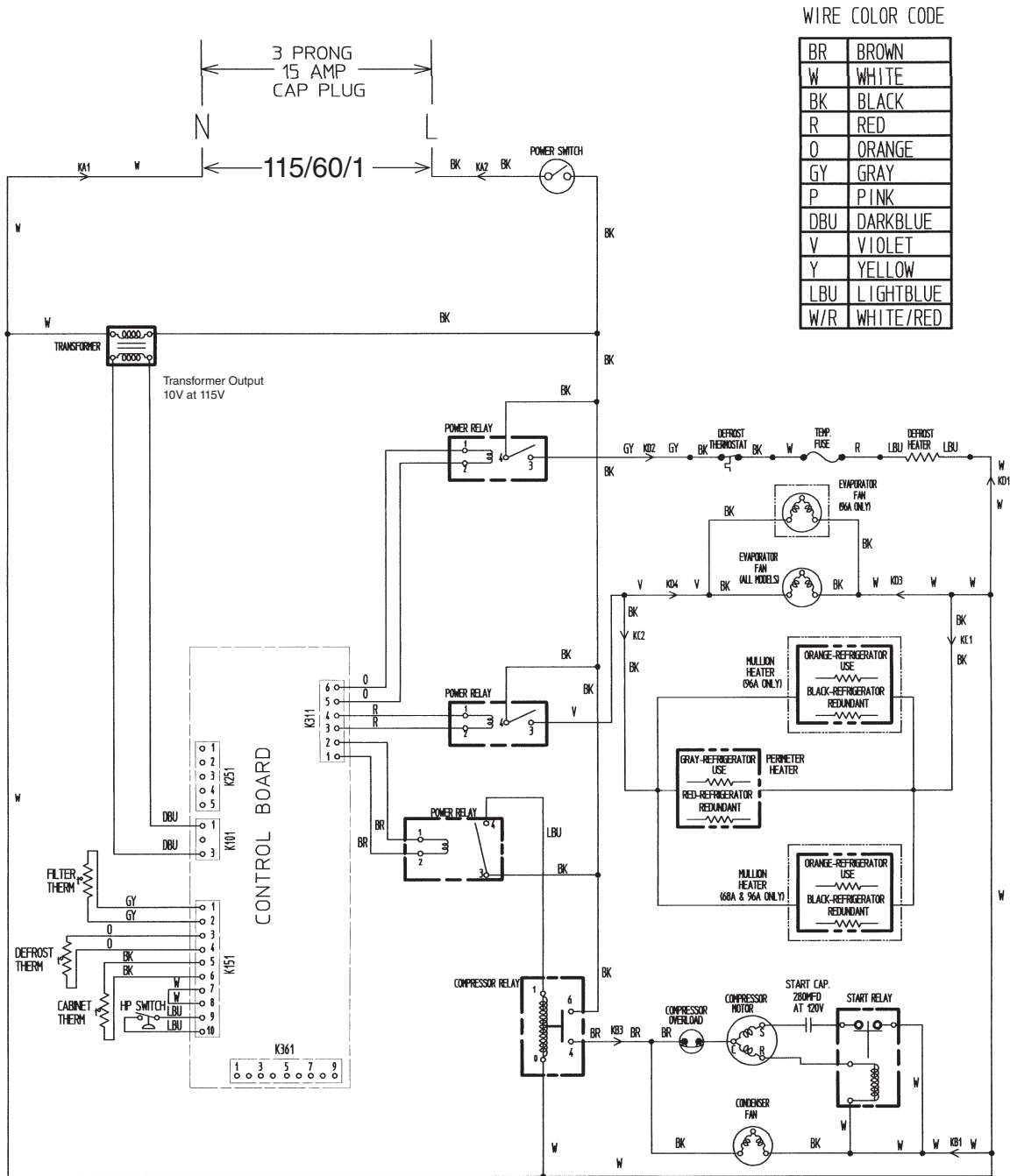

WIRE COLOR CODE

BR	BROWN
W	WHITE
BK	BLACK
R	RED
O	ORANGE
GY	GRAY
P	PINK
DBU	DARKBLUE
V	VIOLET
Y	YELLOW
LBU	LIGHTBLUE
W/R	WHITE/RED

Note: Jumper (color: white) between pins 7 and 8 of connector K151 may not be present on all units, but this will not adversely affect performance.

CAUTION

Before diagnosing and/or servicing the unit, confirm that you have the proper wiring diagram by checking against the diagram located inside the front panel.