

# CAR SEAT/ STROLLER INSTRUCTION MANUAL

Century®

DEDICATED TO QUALITY

4-in-1  
System  
Adventure™

Do not use this 4-in-1 System until you read and understand these instructions!

# IMPORTANT INFORMATION

Thank you for selecting this 4-in-1 Car Seat/Stroller which can be used as:

- Infant Car Seat
- Infant Carrier
- Car Seat/Stroller
- Stroller



## Need Help?

If you need help with this product, **call toll-free 1-800-837-4044** from anywhere in the U.S. or Canada. Outside these areas please call 330-963-2800 8:00 AM until 6:00 PM E.S.T. **Monday through Friday.**

Or write us at: Century Products Company  
9600 Valley View Road  
Macedonia, OH 44056-2096  
Attention: Consumer Relations Department

Please have available the following information. See label on leg of stroller.

Date of Purchase: \_\_\_\_\_

Model Number: \_\_\_\_\_

Manufacture Date: \_\_\_\_\_

## Safety First Check List

- ✓ Read and understand instruction manual before using stroller.
- ✓ Read and understand car seat instruction manual before using car seat in a vehicle.
- ✓ Use the SmartFit® Plus Base provided with this product only with a Century Assura™, SmartFit® or SmartFit® Plus Infant Car Seat.
- ✓ Never leave child unattended.
- ✓ Use with only one (1) child at a time.
- ✓ Do not use accessories other than those provided by Century.

**NOTE:** All warnings and instructions apply whether stroller is being used with or without napper bar in the use position.

## Weight & Height Limits

- Car Seat/Stroller Use:
  - Less than 9 kg (20 lbs.)
  - Less than 69 cm (27 inches)
- Stroller Use:
  - Up to 15.9 kg (35 lbs.)
  - Up To 101 cm (40 inches)

1

**Save instruction manual for future reference.**

## Table of Contents

### Page:

#### 1 Important Information

#### 2 Warnings

#### 3 Car Seat/Stroller Assembly

- Opening Stroller
- Front Wheel Assembly
- Locking Footrest
- Rear Wheel Assembly
- Attaching Car Seat Adapter

#### 5 Car Seat/Stroller Use

- To Use Brakes
- To Lock Or Unlock Front Wheel Swivels
- To Attach Car Seat
- To Remove Car Seat

#### 7 Stroller Use

- To Use Brakes
- To Lock Or Unlock Front Wheel Swivels
- To Remove Car Seat Adapter
- Canopy Positions
- To Use Napper Bar
- Seat Back Positions
- To Secure Child With Harness

#### 9 Folding and Storing

#### 10 Maintenance

- Cleaning
- To Remove Front Wheel Assembly
- To Remove Rear Wheel Assembly
- Dented Wheels

#### 11 Replacement Parts



Visit us at our Web site!  
[www.centuryproducts.com](http://www.centuryproducts.com)

# ⚠ WARNINGS ⚠

• Never leave child unattended. Always keep child in view, even when sleeping.

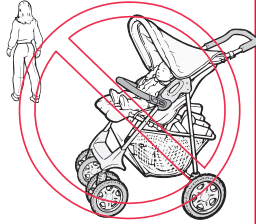

- Children may become tangled in harness straps and suffocate.

- Stroller may roll away, crash and seriously injure child, even with brakes engaged.

• Avoid serious injury from falling or sliding out. Always use seat belt.

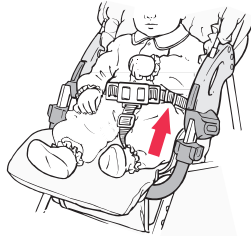

• Avoid serious injury or strangulation, **DO NOT** place child in stroller seat when car seat adapter is attached. Remove adapter assembly **BEFORE** using stroller seat.

• **DO NOT** pull or carry stroller on stairs or escalators with child in it because child could fall out and be injured.



• **DO NOT** lift car seat/stroller unit by car seat handle or car seat shell. • Handle may break.



• **DO NOT** allow child to climb unassisted into stroller as stroller may tip over and injure child.

• **DO NOT** allow children to play, hang or pull down on car seat or stroller handle.

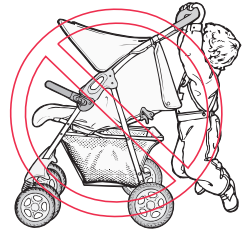

- Stroller may tip over.

- Car seat handle may break.

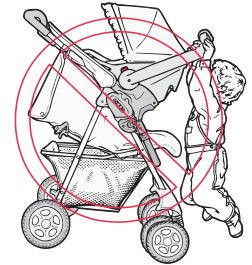

• **DO NOT** jog with stroller. Push stroller at a normal walking speed only.

Fast walking, jogging or running can cause loss of control and injure child.



• **DO NOT** overload basket. Maximum basket weight is 4.5 kg (10 lbs.). Stroller may become unstable and tip over and injure child.



• **DO NOT** hang anything on handlebar or canopy as stroller could tip over and injure child.

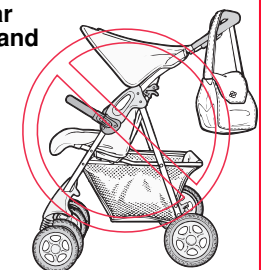

• **DO NOT** use accessories other than those provided by Century.

# CAR SEAT/STROLLER ASSEMBLY

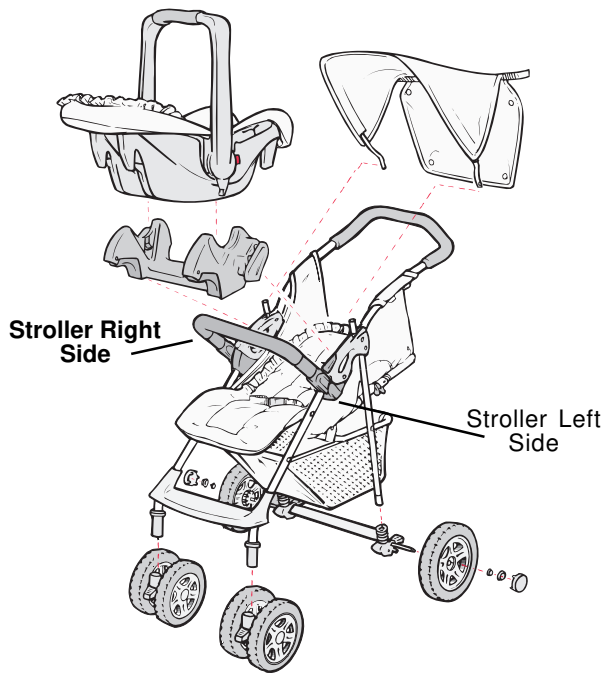

## Front Wheel Assembly

1 Hold swivel wheel assembly upright (tab pointing down).

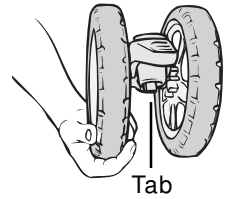

2 Tilt stroller slightly back and push wheel assembly onto leg until it **locks** in place.

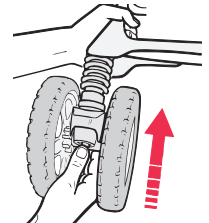

Repeat steps 1 and 2 for opposite leg.

**CAUTION:** After wheel assembly is complete, pull on wheels to check that they are **locked** in place.

## Opening Stroller

1 Stand stroller upright and pull tab to release latch.

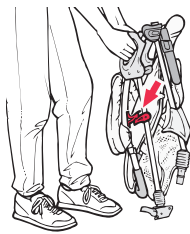

2 Raise napper bar over lower edge of seat and push into slots.

**NOTE:** Stroller may be used without napper bar raised. If using stroller without napper bar raised, skip step 2.



3 Spread handle and rear legs until both fold locks **"click"** into position.

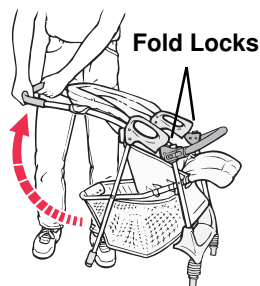

## Locking Footrest

Push footrest down so that frame cross tube is centered between three (3) tabs on bottom of footrest until it snaps in place.

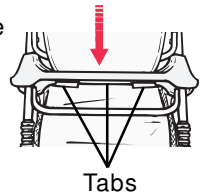

## Rear Wheel Assembly

1 Remove axle protectors from ends of axle and discard.

2 With stroller laying face down on floor, slide brake lever brackets onto rear legs until you hear a click.

**NOTE:** Brake lever **must** face stroller handle.

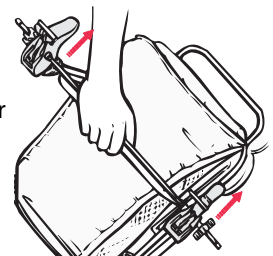

3 With connector ribs facing out, push connector onto wheel ribs.

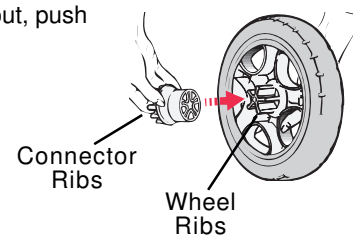

## CAR SEAT/STROLLER ASSEMBLY continued

- 4 Slide wheel connector onto end of axle rod with ribs and connector facing in.

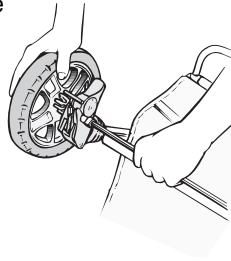

- 5 Secure wheel to axle:

- Snap wheel retainer onto grooved end of axle. Make sure large end of wheel retainer is towards wheel.
- Snap wheel retainer cap over wheel retainer.
- Line up hub cap tabs with slots in wheel and snap hub cap in place.

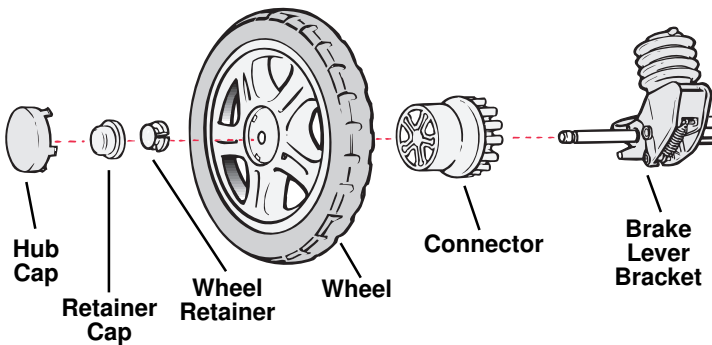

### CAUTION:

- Failure to install retainer cap may cause wheels to come off of stroller.
- After wheel assembly is complete, pull on wheels to check that they are locked into place.

### ⚠ WARNING

Prevent a possible choking hazard, discard axle protectors and polybag which contained rear wheel parts.

## Attaching Car Seat Adapter

Before using car seat/stroller, you **MUST** attach car seat adapter to stroller.

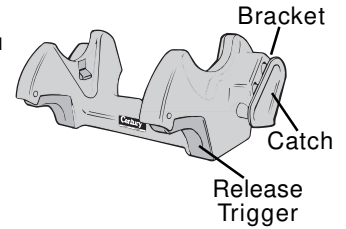

- 1 Set footbrakes to prevent stroller from moving.

**NOTE:** It is only necessary to push down on one brake lever. Both brakes are locked from either side.

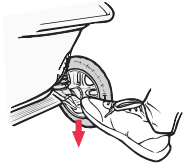

- 2 Stroller seat back **MUST** be in the reclined position to use car seat adapter.

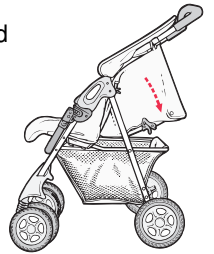

- 3 Align sides of adapter brackets so that stroller handle grip buttons are below adapter brackets.

**NOTE:** Adapter release triggers **MUST** face away from stroller.

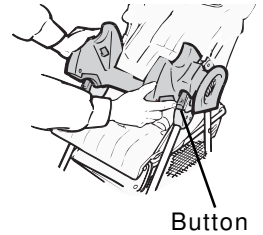

- 4 Rotate adapter brackets into handle grip openings while sliding catch down.

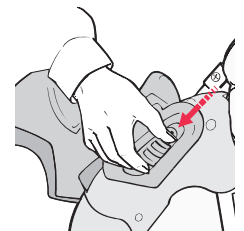
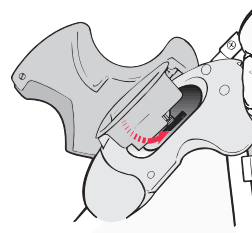

- 5 Release catch when in place.

**Pull on adapter to be sure it is securely attached.**

# CAR SEAT/STROLLER USE

## To Use Brakes

1 To **LOCK**, push down on brake lever.

**NOTE:** It is only necessary to push down on one brake lever. Both brakes are locked from either side.

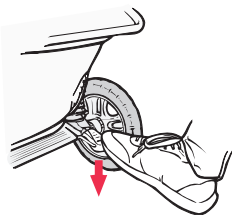

2 To **UNLOCK**, push up on brake lever.

**NOTE:** It is only necessary to push up on one brake lever. Both brakes are unlocked from either side.

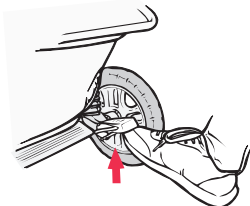

## To Lock Or Unlock Front Wheel Swivels

### Smooth Surfaces:

Use swivel wheels for **smooth** surfaces. Push up lever on front of wheel with toe so that wheels can swivel freely.

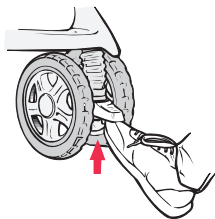

### Rough Surfaces:

Use straight wheels for **rough** surfaces. Push down lever on front of wheel with toe. When wheels are straight, they will lock in place for straight tracking.

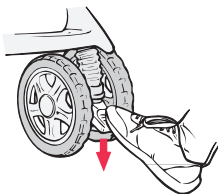

## To Attach Car Seat

1 Set footbrakes to prevent stroller from moving.

**NOTE:** It is only necessary to push down on one brake lever. Both brakes are locked from either side.

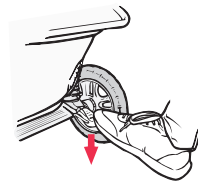

2 Position stroller back support in reclined position:

- Release both levers on sides of seat back.



3 With car seat handle in **locked** carrying position (upright), place round car seat handle hubs into curved slots of car seat adapter.

Both sides must **“click”** in position.

**NOTE:** Car seat may be placed in car seat adapter facing either direction.

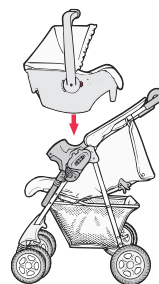

Rear Facing

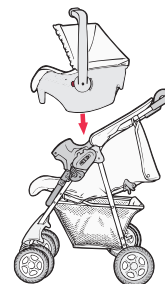

Forward Facing

4 Push in red button **on each car seat handle hub** and rotate handle back until it **“clicks”** and **locks** just behind car seat.

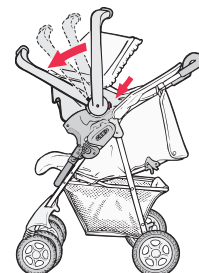



## CAR SEAT/STROLLER USE *continued*

- 5 Pull up on **both** car seat handle hubs to be sure car seat is **locked** in car seat adapters.

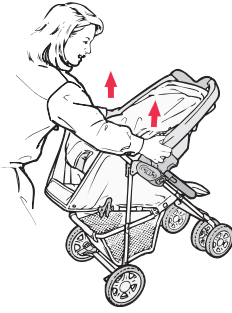

**NOTE:** Car seat comes with a level indicator which is **not** applicable when car seat is used in stroller frame.

### **WARNING**

Avoid serious injuries from falls:

- Always use harness straps to restrain child.
- Always be sure car seat handle is in locked carrying position when lifting or carrying child.
- Always make sure car seat is locked into adapters before each use.
- Always make sure car seat handle is rotated behind car seat when being used with stroller frame.
- Always be sure stroller is fully set up and locked before using.
- Always be sure brakes are locked when attaching and removing car seat from stroller frame.

## To Remove Car Seat

- 1 Set footbrakes to prevent stroller from moving.

**NOTE:** It is only necessary to push down on one brake lever. Both brakes are locked from either side.

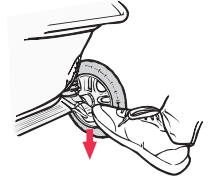

- 2 Push red buttons on car seat handle and rotate handle up until it “clicks” into the **locked** carrying position (upright).

**DO NOT** lift car seat from car seat adapter until you have heard a “click” sound and have checked that handle is locked.

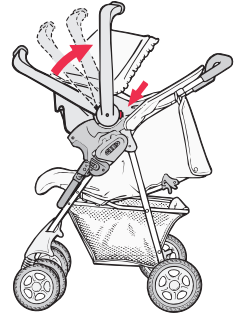

- 3 Press in release trigger on either side of car seat adapter.

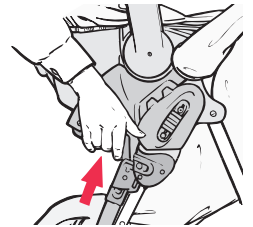

- 4 While pressing in release trigger, lift car seat out of car seat adapter.

**NOTE:** Release trigger on either side of car seat adapter may be used.



# STROLLER USE

## To Use Brakes

1 To **LOCK**, push down on brake lever.

**NOTE:** It is only necessary to push down on one brake lever. Both brakes are locked from either side.

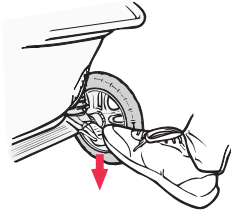

2 To **UNLOCK**, push up on brake lever.

**NOTE:** It is only necessary to push up on one brake lever. Both brakes are unlocked from either side.



## To Lock Or Unlock Front Wheel Swivels

### Smooth Surfaces:

Use swivel wheels for **smooth** surfaces. Push up lever on front of wheel with toe so that wheels can swivel freely.

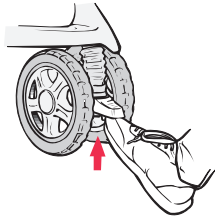

### Rough Surfaces:

Use straight wheels for **rough** surfaces. Push down lever on front of wheel with toe. When wheels are straight, they will lock in place for straight tracking.

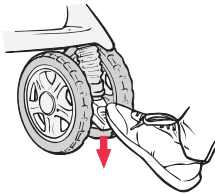

## To Remove Car Seat Adapter

### **WARNING**

**STRANGULATION HAZARD!** Remove car seat adapter **BEFORE** using as a stroller seat.

1 Squeeze catch in adapter bracket to unlock bracket.

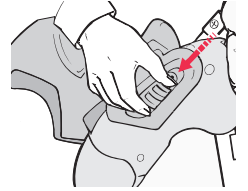

2 Lift adapter bracket out of handle grip opening.

Repeat steps 1 and 2 for opposite side and lift car seat adapter away from stroller.

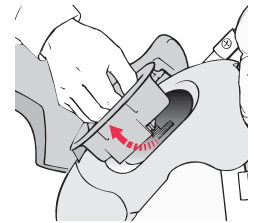

Store adapter assembly for future use.

## Canopy Positions

Canopy has two (2) positions: opened and closed.

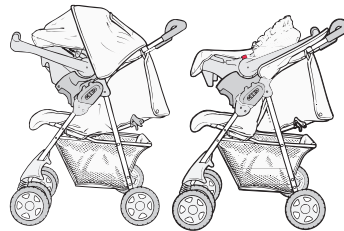

With Car Seat

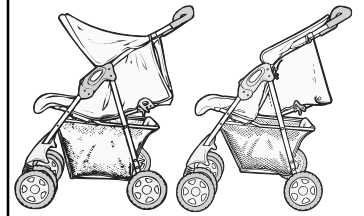

Without Car Seat

### **WARNING**

Prevent serious injuries:

• Make sure child is clear of any moving parts when you adjust stroller.

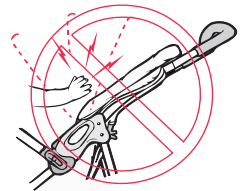

• **DO NOT** place parcels on top of canopy.





## STROLLER USE continued

### To Use Napper Bar

Stroller may be used **with** or **without** napper bar in the use position.

Napper bar has two (2) positions: use and stowed.

#### 1 For **use** (up) position:

- Push napper bar into slots.

Pull on napper bar to be sure it is securely **locked**.

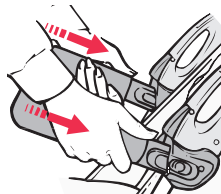

#### 2 For **stowed** (down) position:

- Push napper bar release buttons on **sides** of fold locks.

- Pull napper bar out until it stops. Allow napper bar to drop on to seat.

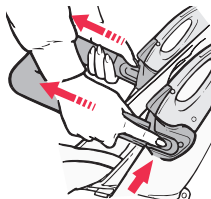

- Partially fold stroller to allow napper bar to drop under seat.

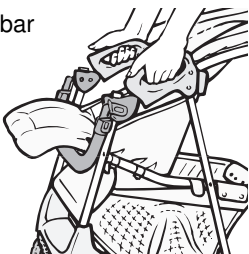

### To Secure Child With Harness

#### **WARNING**

Avoid serious injury from falling or sliding out:

- Always use waist and crotch straps to restrain child, even when sleeping.
- To prevent child from standing or sliding out of stroller, be sure waist and crotch straps are **SNUG** and do not slip loose.
- Periodically check waist and crotch straps to be sure they are **snug** around child.

Secure child with harness system:

- Pull waist straps around child's waist.
- Place crotch strap between child's legs.
- Snap both buckle tongues into buckle.

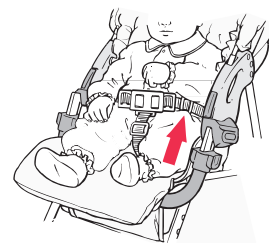

Adjust harness system:

- Adjust length of waist straps by pulling slider rings (**A**) and ends of waist straps (**B**).
- Adjust length of crotch strap by pulling slider ring (**C**).
- Pull on straps to be sure they are **buckled** and **snug**.

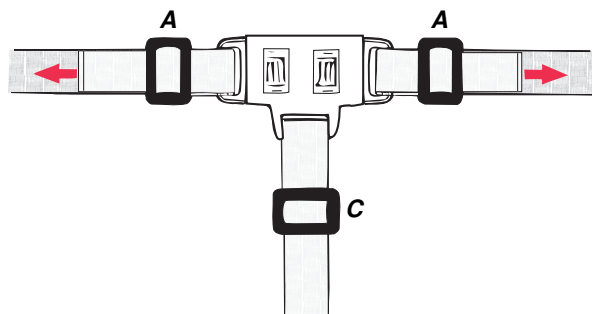

### Seat Back Positions

Seat back has two (2) positions: upright and reclined.

#### 1 For **upright** position, lift seat back forward until back support pins hook into seat back latches.

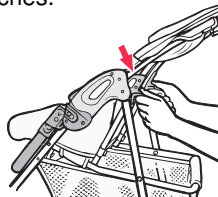

#### 2 For **reclined** position, release both levers on sides of seat back.

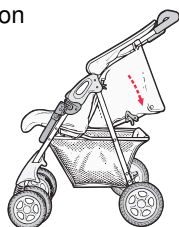

# FOLDING AND STORING

- 1 Set footbrakes to prevent stroller from moving.

**NOTE:** It is only necessary to push down on one brake lever. Both brakes are locked from either side.

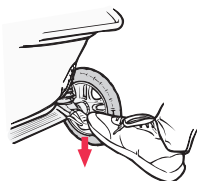

- 2 Remove car seat from stroller frame (see page 6).

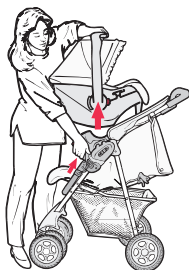

- 3 Place seat back in reclined position.

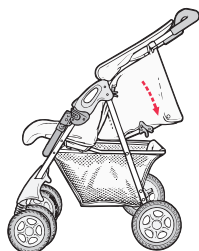

- 4 Release quick snap fold locks on each side by grasping handle grips and pressing on both buttons.

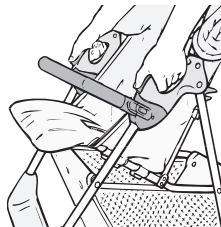

- 5 Continue holding buttons in and lift upward on handle to fold stroller.

**NOTE:** This can be done with napper bar up or down.

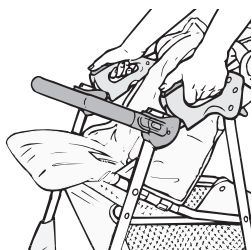

With Napper Bar Up

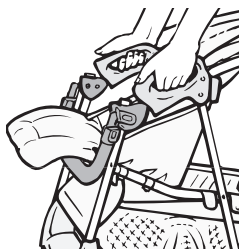

With Napper Bar Down

## IMPORTANT:

- When folding stroller, turn stroller front wheels to straddle frame.

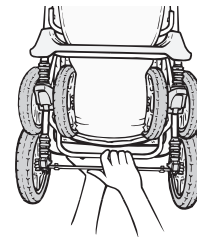

- **DO NOT** allow front wheels to rest on frame. Doing so will cause wheels to warp and they will not roll correctly.

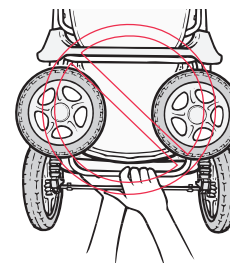

- 6 Engage latch on side of stroller to retain stroller in its folded position.

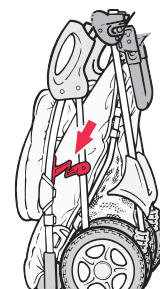

# MAINTENANCE

## Cleaning

- Wipe fabric and frame with damp cloth and mild soap. **DO NOT USE** abrasives, solvents, strong detergents, or household cleaners: they can weaken plastic.
- **DO NOT** machine wash or dry seat pads that have boards in them.

- 1 Remove screws and unwrap straps securing seat pad to frame.

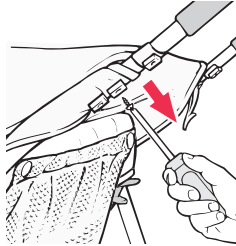

- 2 When re-attaching seat pad, wrap seat strap around frame and insert screw.

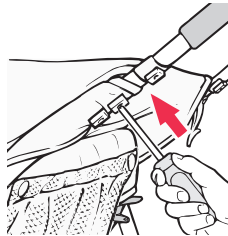

## To Remove Front Wheel Assembly

Push tab away from leg while pulling down on wheel assembly.

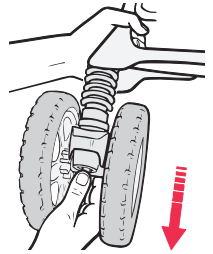

## To Remove Rear Wheel Assembly

Pry wheel retainer and cap off axle.

Slide wheel off end of axle.

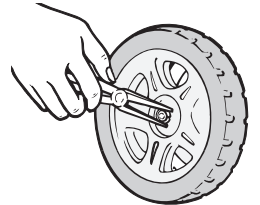

## Dented Wheels





Sometime wheels become “**dented**” from shipment or from normal use. You may try the following procedure for repairing the dented wheel before calling our Consumer Relations Department.

- Blow warm air from hair dryer over dented area for 1 to 3 minutes.

## **WARNING**

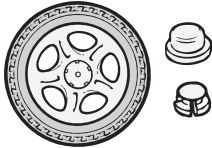
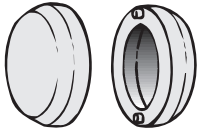
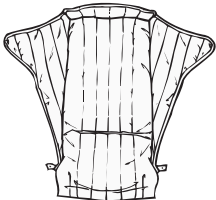
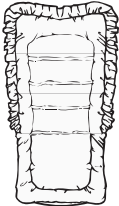
To avoid serious injury to child, periodically check anchoring straps beneath seat pad to ensure they are secured to frame.

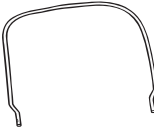
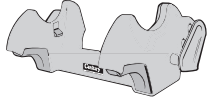
# REPLACEMENT PARTS

PARTS LIST	PRICE	PART	
<b>A. Front Wheel Assembly</b> 2-Preassembled Wheels (11-77X)	US \$ 11.00	<b>A</b>	
<b>B. Rear Wheel Kit</b> 1-Wheel, Wheel Retainer Clip & Retainer Cap (11-77X)	US \$ 5.00	<b>B</b>	
<b>C. Hub Cap Set (2) (11-77X)</b>	US \$ 1.00	<b>C</b>	
<b>D. Seat Pad (11-77X)</b>	US \$ 16.00	<b>D</b>	
<b>E. Comfort Pad (11-77X)</b>	US \$ 9.50	<b>E</b>	
<b>F. Canopy Pad with Window (11-77X)</b>	US \$ 8.00	<b>F</b>	
<b>G. Canopy Frame (11-77X)</b>	US \$ 2.00	<b>G</b>	
<b>H. Car Seat Adapter Assembly (11-77X)</b>	US \$ 24.00	<b>H</b>	
<b>I. Mesh Basket (11-77X)</b>	US \$ 7.00	<b>I</b>	
<b>J. Instructions &amp; Parts Order Form (11-77X)</b>	FREE	<b>J</b>	

**NOTE:** Prices subject to change.

**Add-On Chart**  
\$ 5.00 = Canada

**Shipping & Handling Chart**  
 \$ .01 to \$ 5.00 = \$ 4.00  
 \$ 5.01 to \$ 50.00 = \$ 5.00  
 \$ 50.01 to \$200.00 = 10% of Order Total  
 \$201.00 and over = 5% of Order Total

# 4-in-1 System

## Adventure™



### REPLACEMENT PARTS ORDER FORM

Please fill out and return this form to address shown on next of page.

- |   |             |
|---|-------------|
| <input type="checkbox"/> A. Front Wheel Assembly      | \$ _____    |
| <input type="checkbox"/> B. Rear Wheel Kit            | \$ _____    |
| <input type="checkbox"/> C. Hub Cap Set               | \$ _____    |
| <input type="checkbox"/> D. Seat Pad                  | \$ _____    |
| <input type="checkbox"/> E. Comfort Pad               | \$ _____    |
| <input type="checkbox"/> F. Canopy Pad with Window    | \$ _____    |
| <input type="checkbox"/> G. Canopy Frame              | \$ _____    |
| <input type="checkbox"/> H. Car Seat Adapter Assembly | \$ _____    |
| <input type="checkbox"/> I. Mesh Basket               | \$ _____    |
| <input type="checkbox"/> J. Instructions & Parts Form | <u>FREE</u> |

Subtotal Amount \$ \_\_\_\_\_  
 Shipping & Handling (see chart page 11) \$ \_\_\_\_\_  
 Add-On Chart (see chart page 11) \$ \_\_\_\_\_  
 Total Amount of Order \$ \_\_\_\_\_

#### \*\* IMPORTANT \*\*

We must have this information to process your order. See label on right rear leg of stroller.

Model Number: \_\_\_\_\_

Manufacturer Date: \_\_\_\_\_

Charge to credit card    Visa    MasterCard

Card Number: \_\_\_\_\_

Expiration Date: \_\_\_\_\_

Cardholder's Name: \_\_\_\_\_

Check Enclosed

Please make checks payable in **US currency** to:  
**Century Products Company**

#### SHIP TO:

Customer Name: \_\_\_\_\_

Street Address: \_\_\_\_\_

City, State, Zip: \_\_\_\_\_

Telephone Number: (\_\_\_\_\_) \_\_\_\_\_

Send order with check, money order, or charge card number,  
in an envelope to:

**Century Products Company**  
**9600 Valley View Road**  
**Macedonia, OH 44056-2096**



**You put more than your trust in us.™**



