



**INSTALLATION INSTRUCTIONS &  
MANUAL FOR MAINTENANCE**

# UNICA-2 40

Gas fire with open combustion system

Bellfires wishes you many cosy evenings with your new Bellfires gas fire

This document is an essential part of your gas fire. Read it carefully before installation and maintenance of the gas fire and keep it in a safe place!



Serial number:

Production date:



**BELLFIRES GAS FIRE WITH OPEN COMBUSTION SYSTEM:**

Unica-2 40

(UNC-2 40)



# CONTENTS

	Page
1. INTRODUCTION .....	7
2. INSTALLATION .....	14
3. ANNUAL MAINTENANCE .....	37
4. FAULTS .....	41
5. DISMANTLING / ASSEMBLING OF THE GLASS, THE REGULATOR AND BURNER .....	42
6. CONNECTING DIAGRAM .....	43
7. DIMENSIONS .....	44
8. TECHNICAL DETAILS/REGULATIONS .....	46
9. REPLACEMENT PARTS LIST .....	48
10. DISPOSAL OF PACKAGING AND APPLIANCE .....	50

## IMPORTANT



**The installation must only be carried out by a  
“Gas Safe Register” registered installation engineer.**



## 1 INTRODUCTION

### 1.1 GENERAL

The gas fire must be positioned and connected as an “open” appliance by a “Gas Safe Register” registered gas installation engineer in accordance with the following installation instructions, nationally and locally applicable regulations (see “Technical Details / Regulations” at the rear of this manual). If you have any queries regarding the installation, please consult your local gas company.

This manual contains directions for both positioning and for connecting the appliance. It also contains indications for the annual maintenance, technical data for the appliance, parts information and directions in the event of problems.

Study the Installation instructions carefully before using the appliance. We recommend you keep this manual in a safe place for reference purposes.

Read the “Instructions for use & maintenance manual” before operating the appliance

**Important:**  **Before beginning the installation, check that the details on the rating plate correspond to the gas type and pressure to which the appliance will be connected.**

If an existing chimney is to be used, please consult your installer first. If the chimney was previously used for a wood or coal fire, then it should be cleaned by an expert. A chimney draw of approximately 5 Pa (=0,05 mbar) is sufficient for full load of the appliance. If the chimney draw is more than 20 Pa (=0,2 mbar), then it is recommended to reduce it.

The appliance is factory set to the correct nominal heat input. The pilot light is set to the correct level of consumption.

The gas fire can be installed as an **insert** into an existing open fire place or as a **built-in** appliance in a new fire place.

### 1.2 SAFETY

- Do not place embers, wood logs or shingles against the pilot light burner. Make sure that the pilot flame can burn at all times freely over the main burner. Only in this way is proper ignition of the main burner ensured. Ignoring these directions could lead to a dangerous situation.
- Do not place flammable objects within 100 cm of the appliance. Pay special attention to furnishings and ornaments around the fire.
- When igniting the pilot light and burner, always keep a minimum distance of 100 cm from the front of the appliance.

- If the pilot flame goes out for any reason, wait for 5 minutes before attempting to re-light it.
- It is essential that the appliance, the complete flue system and the room ventilation openings are cleaned and inspected annually by a recognised fitter/gas specialist. The safe operation of the appliance will thus remain guaranteed. See Chapter 3: Annual maintenance.
- The gas fire must never be used with the door open or the door glass removed.
- Never place flammable material on the ceramic log set.
- The filling of the main burner with embers, wood logs or pebbles may not under any circumstances be changed or added to.
- Do not place easily-flammable materials, such as nylon clothing or flammable liquids, in the vicinity of the gas fire.
- Ensure at all times that children and other people who are not aware of the operation of the gas appliance are only in the vicinity of the appliance exclusively under supervision.
- Use a fireguard to protect the people and children mentioned above against possible burns.

### 1.3 BUILT-IN PROTECTION OF THE APPLIANCE

The appliance is fully protected by means of a thermo-electric pilot light shut off in the event of a gas escape from the main burner.

Flue gas exhaust protection:

Also the appliance is fitted with an atmosphere protection facility. This is an “oxy-stop” pilot flame that turns off the burner if the flue gas is insufficiently exhausted

When the flame is blue and hazy (when the appliance is burning for some time), this means that combustion is not correct, and that the “oxy-stop” will be activated within a certain period.

If the “oxy-stop” pilot flame is activated then check that the air supply and the flue exhaust are open. Following isolation of the cause, the appliance can be put back into operation.

Always contact your installer in the event of continual problems.

It is not permitted to disable or modify the protection.



In the event that the “oxy-stop” pilot flame is to be replaced, then only the original model should be applied.

**This atmosphere protection; the “oxy-stop” pilot light, is not a substitute for an independent-mounted carbon monoxide detector.**

#### 1.4 INCLUDED

Set documentation	<ul style="list-style-type: none"> <li>- Instructions for use</li> <li>- Installation instructions</li> </ul>
Attributes	<ul style="list-style-type: none"> <li>- Ceramic log set, or marble shingles white or marble shingles grey</li> </ul>

N.B. If any part is missing, please contact your dealer.

#### 1.5 ACCESSORIES

The following accessories can be supplied by your dealer:

<u>Part no</u>	<u>Accessorie</u>
302092	AC Power adaptor 230 VAC - Power supply “receiver”
337100	Black mirror, rear wall Unica-2 40
333892	<u>Ambient lighting set Unica-2 series:</u> Set, consisting of two lamps (230 VAC/2x 25 W), cables and assembly material.
333605	<u>Module:</u> 230 VAC Power supply, required for the option Ambient lighting set. Including connecting cable.
334275	Conversion kit: “Lined” → “Unlined” flue connection.
334276	Conversion kit: “Unlined” → “Lined” flue connection.
301206	Ø5” Flue adapter for conversion: Ø4” → Ø5”.

## 1.6 PREPARATIONS BEFORE INSTALLATION

Before installing the appliance, first observe the following instructions.

### 1.6.1 The most important facilities according to the regulations

#### 1 NATURALLY VENTILATED HOUSE (see Figure 1)

- Check that the room in which the appliance is to be fitted has non-closable ventilation openings, according the national and local applicable building regulations. The minimum dimensions are detailed in “Technical Details / Regulations” at the rear of this manual.
- The flue gas exhaust must exit at “outlet area I”.

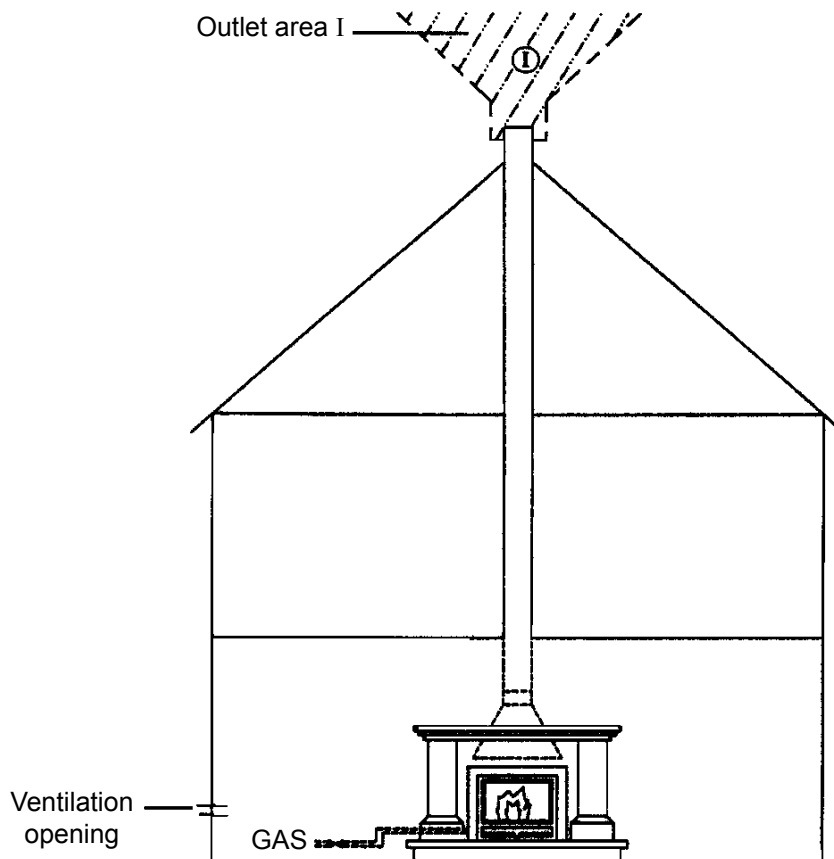

**Figure 1: Naturally ventilated house**

## 2 MECHANICALLY VENTILATED HOUSE (see Figure 2)

- Check that the room in which the appliance is to be fitted has non-closable ventilation openings according the national and local applicable building regulations. The minimum dimensions are detailed in “Technical Details / Regulations” at the rear of this manual.
- The flue gases must be extracted by means of a flue extraction fan.

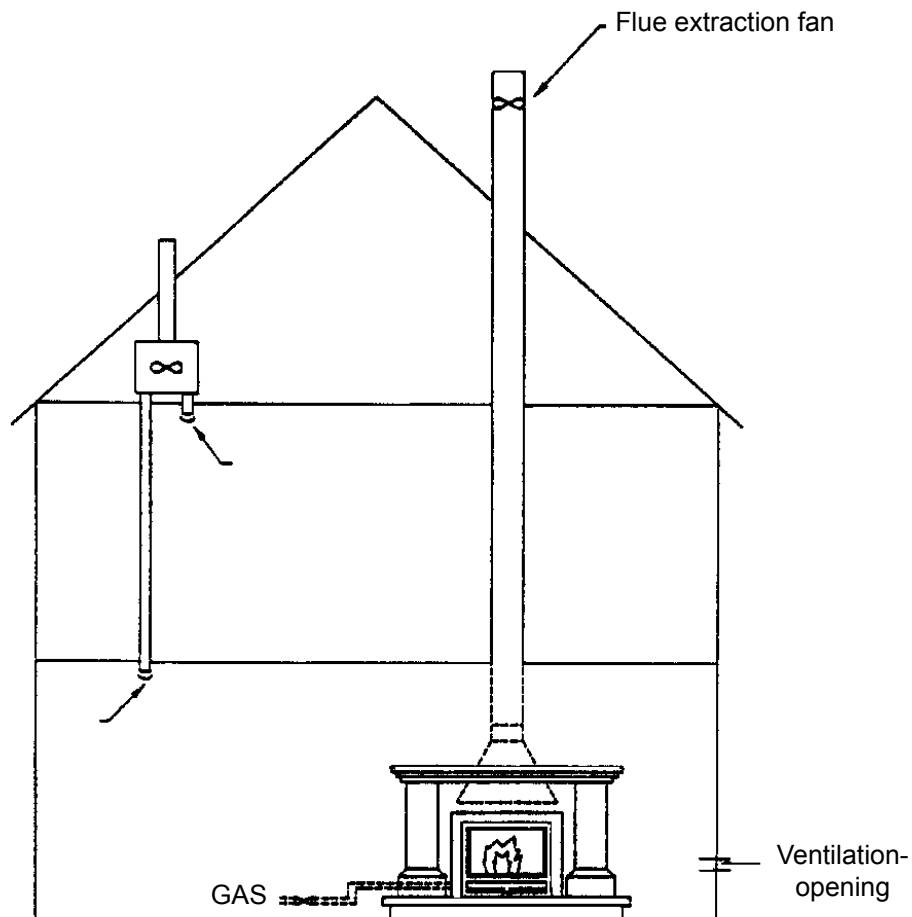

**Figure 2: Mechanically ventilated house**

## 1.7 GENERAL SERVICES

### 1 FLUE

There are 3 possible conventional flue connections:

- ① Appliance installed into a new chimney (e.g. stud work)  
Top exit only: Ø4" (Ø100 mm for rigid pipe sleeved, or twin wall or Ø106 mm for flexible pipe sleeved, or twin wall) for a "Lined" installation.  
Ø5" with adapter (option) for rigid or flexible pipe.
- ② Appliance installed into an existing chimney
  - Ⓐ Top exit For a "Lined" installation  
Ø4" (Ø106 mm) or Ø5" (Ø127 mm) with adapter.
  - Ⓑ Rear exit For an "Unlined" installation → Use a flue Ø7" (Ø178 mm) minimum. Rear exit flue opening appliance is  $\nabla$  217 x 34.5 mm (U.K. only).



**Use of the rear flue exit, for an "unlined" installation, is only allowed in the U.K.**

Before installation, it must be verified that the flue has sufficient draw. Remove all flue gas dampers (if present) in the flue or fix them in the open position. The flue must be at least 2 metres long. In order to prevent condensation in a masonry flue and, if necessary, to improve correct operation of the appliance, it is recommended that the flue be fitted with an, (insulated) aluminium or (flexible) stainless steel pipe of Ø100 mm (4" or 5" minimum) (Top exit) or Ø178 mm (7" minimum) (Rear exit). An protective cap must be placed on top of the chimney to prevent rain entering.

Where it concerns a new aluminium or (flexible) stainless steel pipe, you need to encase the entire flue pipe with fireproof material. This in connection with the high external temperatures of the flue pipe (up to  $\pm$  300°C.). You must also never apply and/or position flammable materials in the vicinity of the encased pipe.

### 2 VENTILATION OF THE ROOM

The ventilation of the room has to comply with national and local building regulations. The minimum dimensions of the ventilation opening(s) are detailed in "Technical Details/Regulations" at the rear of this manual. The ventilation opening(s) must be non-closable !!!

### 3 GAS CONNECTION

The Ø8 mm gas connection is located, factory fit, on the rear side of the appliance. During installation the gas connection can also be made underneath or on either side. Connect the gas supply to the appliance using a compression coupling. Use only gas piping with a minimum diameter of 1/2" G with a shut-off valve. A small gas tap is located, in the appliance, right-under the main burner.

Position the gas supply pipe such that it can be easily mounted after installation.

#### 4 ELECTRICAL CONNECTION

If the appliance is equipped with ambient lighting or AC Power adaptor, there must be a wall socket with earth connection, preferably at the right-hand side of the appliance. The socket should be accessible at all times.

The powercable ( $\pm 0.5$  m) is coming from the rear of the appliance, near the gas inlet pipe.

## 2 INSTALLATION

### 2.1 POSITIONING THE APPLIANCE

Important:



- **Never use combustible materials during the installation. The appliance may not be installed against a flammable rear wall.**
- **During installation of the gas fire, a clearance of 3 mm should be maintained on all sides of the appliance to allow for expansion of the appliance during operation.**

- **Do not insulate the appliance! Only the top and sides may be fitted with a strip of white, loose insulation wool (heat-resistant to 1000°C), width 15 cm max. to protect the wall.**

**Do not use fibreglass or Rockwool, or any other sort of insulating material. These emit a pungent odour.**

**This is considered extremely unpleasant. They may also cause discolouring of the chimney.**

- **Flammable materials, such as curtains, should not be placed in the vicinity of the gas fire.**

**Minimum safe distance: 100 cm.**

- **Position the appliance at least 12 cm above the floor height. If the appliance is fitted less than 12 cm from the floor, then it will require a hearth to protect the floor. The hearth should have a minimum dimension of 12 mm thick, laying completely under the appliance and projecting 30 cm in front and 15 cm either side of the appliance.**

- **A hearth is not required with a non combustible floor.**

- **Ensure that the temperature of the floor under and in front of the appliance can never rise above 85°C!**

**Make use of a temperature protection plate (of nonflammable material) on the floor if necessary.**

**Take care with a floor made of a flammable material.**

- **Minimum distance between the appliance and a front wooden fireplace; with a depth of less than 10 cm, is:**

**\* 5 cm on the sides: (min. distance: side appliance - leg wooden fireplace surround)**

**\* 40 cm at the top: (min. distance: top appliance - bottom of beam wooden fireplace surround)**

**The temperature on the underside of the beam of the wooden fireplace must never exceed 85°C. Optional: insulate the bottom of the wooden beam with a fireproof plate.**

Read one of the following instructions for fitting the appliance, as applicable:

Paragraph 2.1.1 Fitting into a new chimney

Paragraph 2.1.2 Fitting into an existing opening larger than the appliance

Paragraph 2.1.3 Fitting into an existing opening equal or smaller than the appliance

### 2.1.1 Fitting into a new chimney

The fireplace must be mounted on a concrete floor. If there is no concrete floor, it is essential to re-enforce the floorboards underneath with concrete. Build in the fire insert up to the top of the fireplace opening. Push the appliance into the opening and make the chimney connection using an (insulated) aluminium or (flexible) stainless steel pipe of Ø100 mm (Ø4") (or Ø127 mm (Ø5") with an adapter) for a "Lined" installation. An "Unlined" installation is not allowed in a new chimney.

Connect the gas supply using the separately provided gas inlet connector. Ensure that the gas regulating block is straight during the connection. Ensure that the gas regulating block and pipework are not put under stress.

Make the electrical connection. (Only applicable if the appliance is provided with ambient lighting or a AC Power adaptor)

During subsequent installation, protect the gas piping against encasement by cement etc.

**Important:**      **Cement and chalk can damage the gas piping and can, in turn, lead to gas leaks.**



The appliance can now be built in.

First determine the places for the ventilation ducts (grates, at the top and bottom of the fireplace).

The appliance can be built in using brickwork or by means of fire-resistant plates that are screwed to a metal frame. You can, if you like, erect a natural stone mantelpiece in front of this.

If desired, the frame can be removed temporarily, during the installation of the appliance. First remove the door (including glass); see paragraph 2.1.2 point 1. After that loosen the nuts on the corners, on the inside, a few turns. Take the frame forwards and remove. When the installation is completely finished one can place back the frame. Make sure the nuts are fixed well.



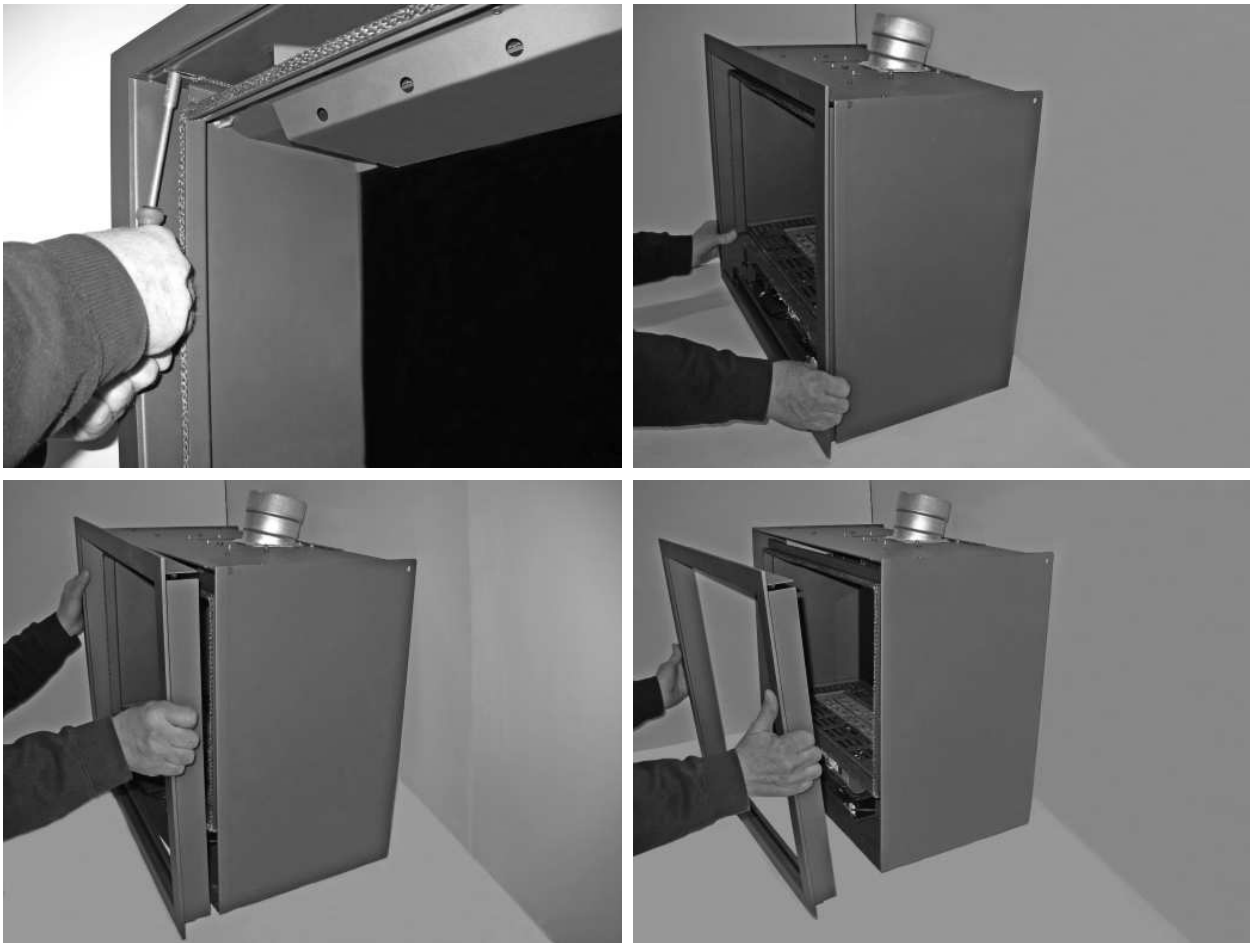

The brickwork must be built up around the hearth. In connection with the hearth expanding during burning: there must be at least 3 mm clearance on either side of the appliance. Do not build up the brickwork farther than the top of the appliance (keep in mind the thickness of any plastering!).

The appliance is supplied with a straight pressed steel lintel as option to allow installation against a flat wall or in a fireplace. The mantle iron is intended for supporting the brickwork above the appliance. The mantle iron must rest on the brickwork on both sides so that upward building is possible. The brickwork therefore must not rest on the fireplace; there must be approx. 3 mm clearance in connection with the weight.

A heat-resistant sealing cord should be placed between the appliance and the lower side of the lintel to allow vertical expansion of the appliance and to prevent cracking the fireplace.



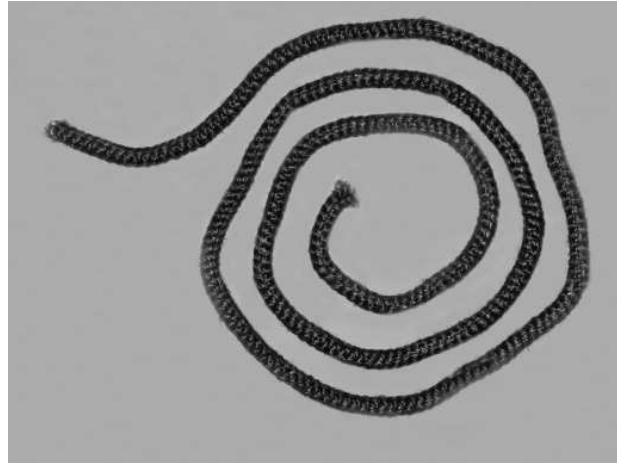

**Do not use masking tape on the appliance when installing and plastering. Tape can damage the finish of the hearth.**

The brickwork or the fire-resistant sheet construction can now be continued to ceiling height.

If using other materials, such as stone or heat-resistant plating, you should follow the supplier's instructions.

For further positioning instructions: See Paragraph 2.1.3.

Check that all connections are completely gas tight using soapy water or a leak tester. As a check, allow the fire to burn briefly (maximum 1 minute). Following verification that there are no leaks, finish off building in the appliance.

**After installation in a new fireplace and/or applying new cement work, the appliance cannot be used for at least four weeks.**

## 2.1.2 Fitting into an existing opening larger than the appliance

### “Lined” installation:

Place an (insulated) aluminium or (flexible) stainless steel pipe of Ø100 mm (Ø4”) (or Ø127 mm (Ø5”) with an adapter) into the flue for the connection between the flue spigot of the appliance and the chimney and then position the appliance into the fire-place. Push the aluminium or stainless steel pipe into the flue spigot of the appliance. For further installation procedures, refer to paragraph 2.1.1 and 2.1.3.

### “Unlined” installation (U.K. only):

Transformation from a “Lined” flue (top exit) connection to an “Unlined” flue (rear exit):

Use for this: Conversion kit “Lined” → “Unlined” flue connection.

#### 1 Removal of the door and glass:

Remove the door (including glass) by left and right screw loosening a few turns. Carefully lift the door slightly, tilt forward and remove. Wear gloves!

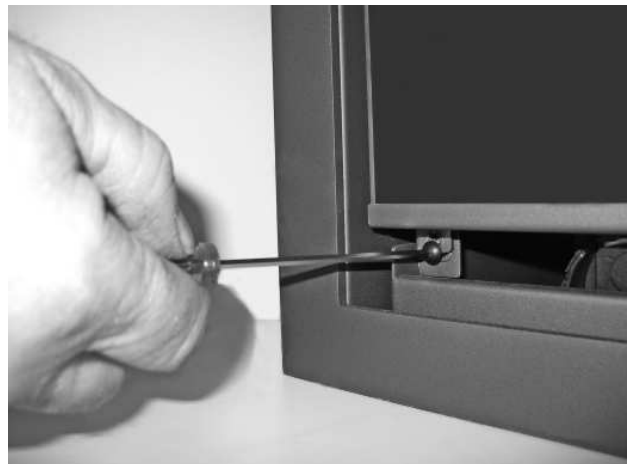



## 2 Removal of the top exit flue connection piece:

Disassemble the top flue outlet connection piece from the inside of the appliance.

- a. Disassemble first the baffle plate at the top of the combustion chamber, by a front screw loosening, and take the plate out.

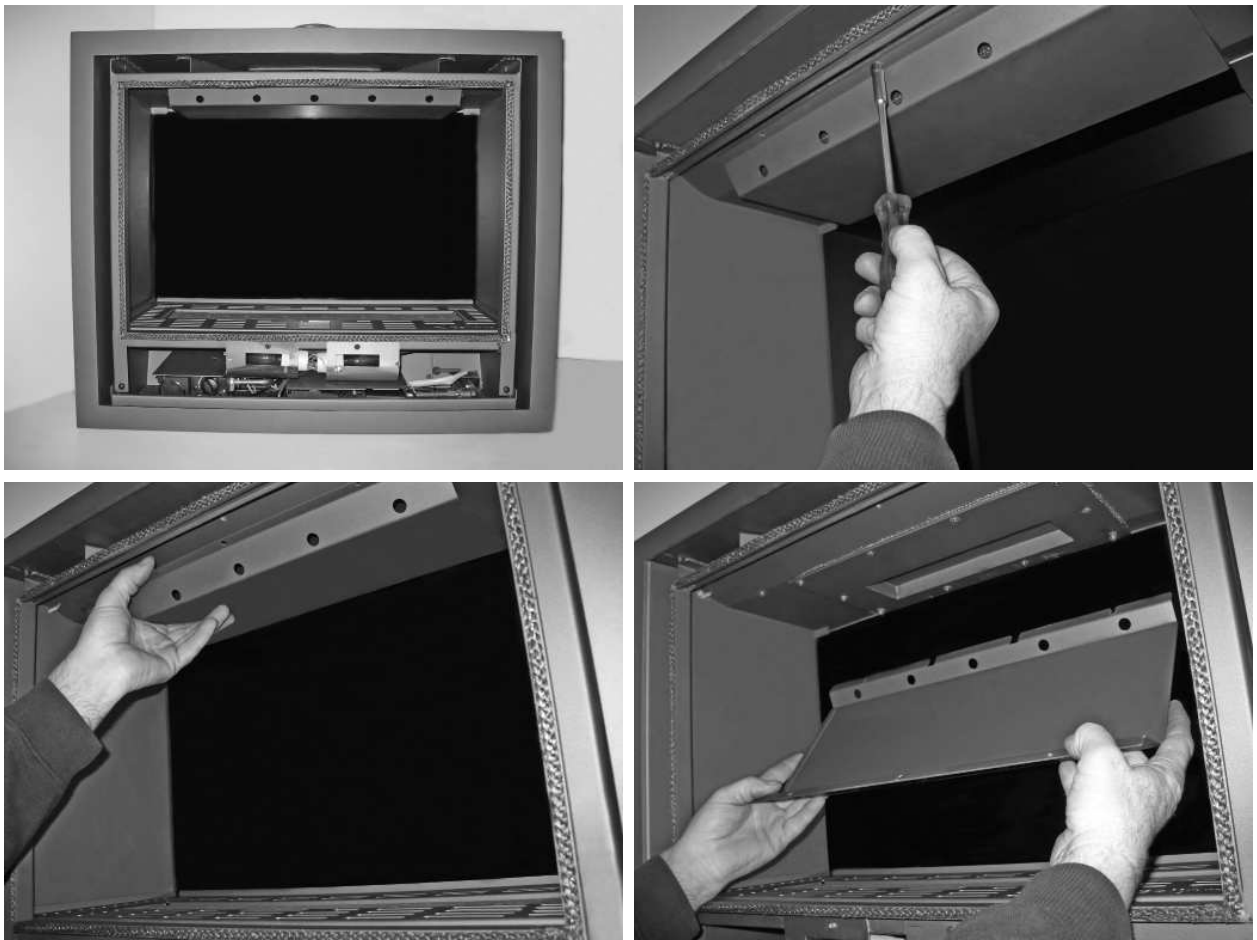

- b. Disassemble after this the draft diverter from the top of the combustion chamber, by loosening the screws around and take it out.



- c. Disassemble the plate with flue outlet connection piece, by loosening the bolts on the outer edge. Do not fully unscrew the bolts around the flue outlet connection piece! The plate with the flue outlet can now be removed.



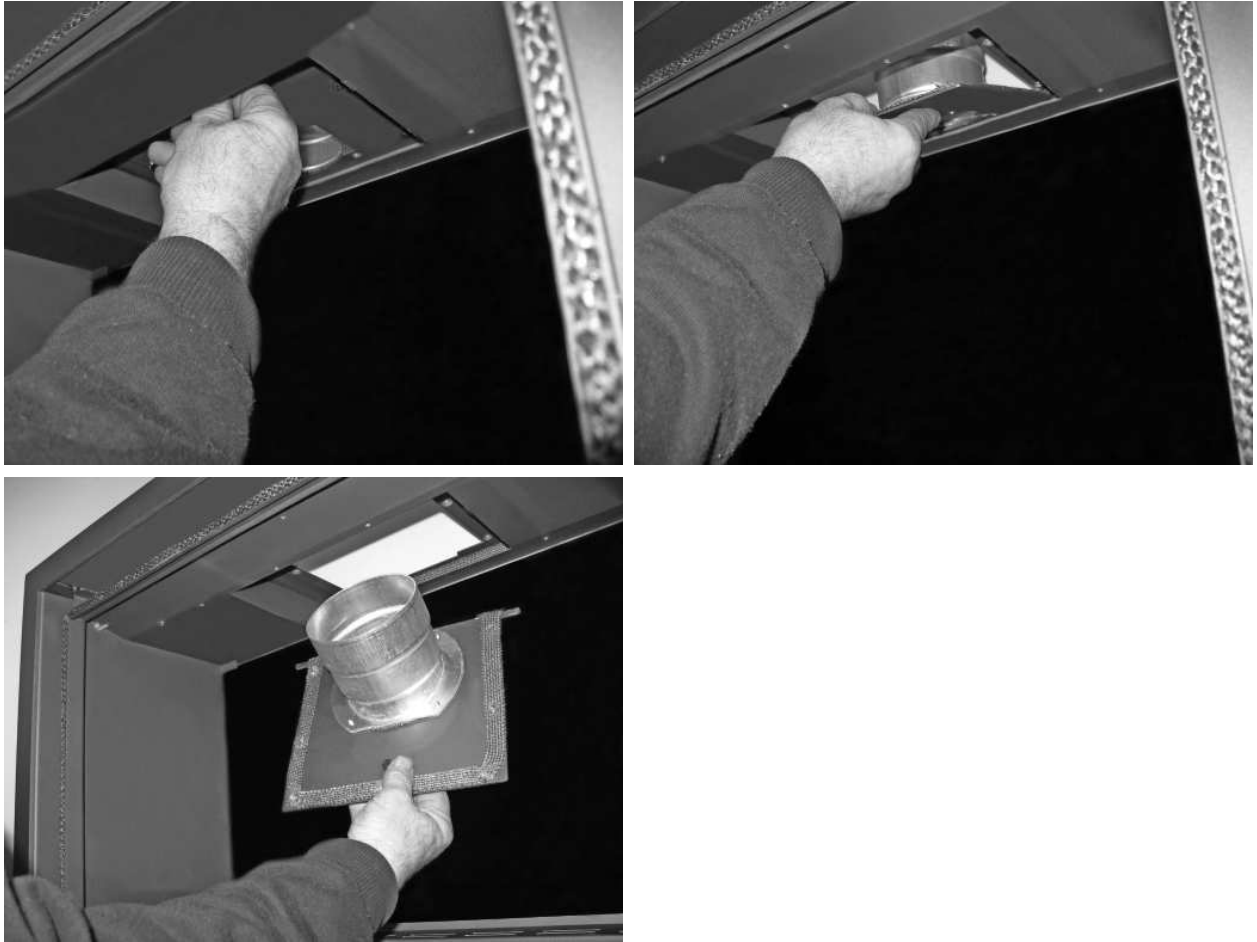

- 3 Removal of the rear exit flue opening cover plate:  
Disassemble the rear exit flue opening cover plate from the back of the appliance.

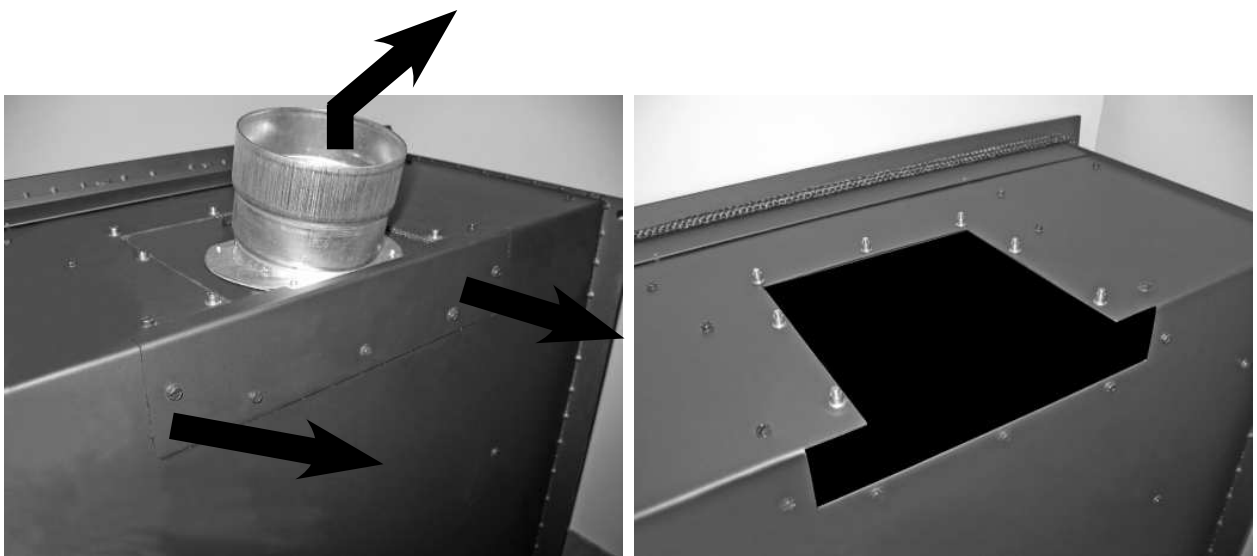

#### 4 Mounting of the top cover plate, draft diverter and baffle plate:

Assemble the top cover plate (comes with the conversion kit; “Lined” → “Unlined” flue connection) from the inside of the appliance. Refit the draft diverter and baffle plate. Check all connections are properly connected and there are no interstices!

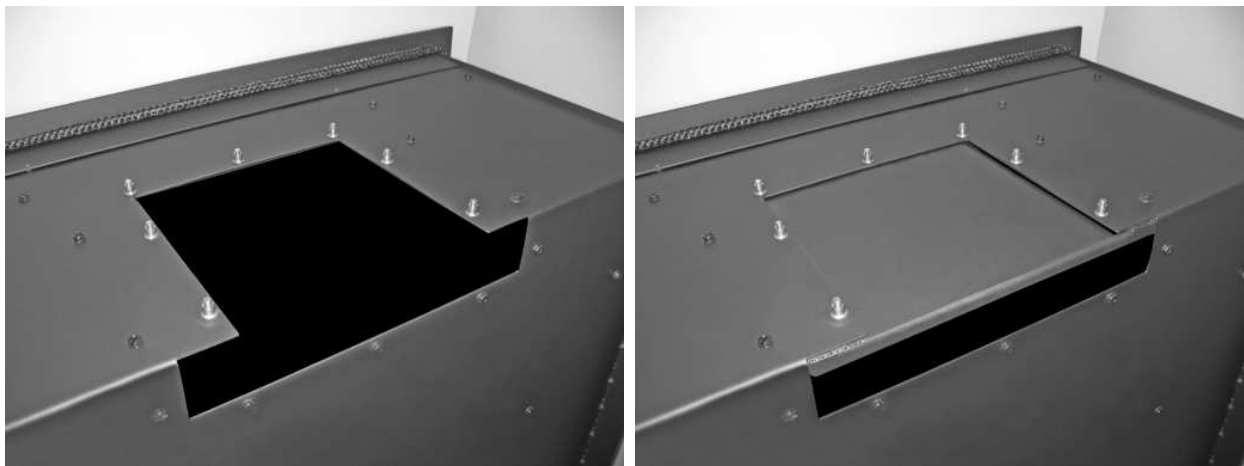

#### 5 Mounting the door with glass:

Install the door (including glass) by hooking in on the top, and then tighten the screws left and right under. Wear gloves!

Check that the sealing of the door fits well on the appliance!

#### “Unlined” installation (UK only!):

From the ceiling of the fireplace opening till the roof terminal: Make sure that the existing flue has a diameter of minimal  $\text{Ø}180 \text{ mm}$  ( $\text{Ø}7''$ ).

Place an (insulated) aluminium or (flexible) stainless steel pipe of  $\text{Ø}180 \text{ mm}$  ( $\text{Ø}7''$ ) if the brick chimney flue is more than  $\text{Ø}200 \text{ mm}$ .

Do not block the rear exit flue opening!

The space between the top of the appliance and the ceiling must have a free height of minimal 50 mm.

Seal the appliance to the wall with a fireproof ceramic fibre rope. This rope comes with the conversion kit; “Lined” → “Unlined” flue connection.

Fix the appliance solidly to the bottom of the fireplace. Use for this the two screws and plugs supplied.

They have to be mounted at the left and right side corner of the bottom plate of the appliance.

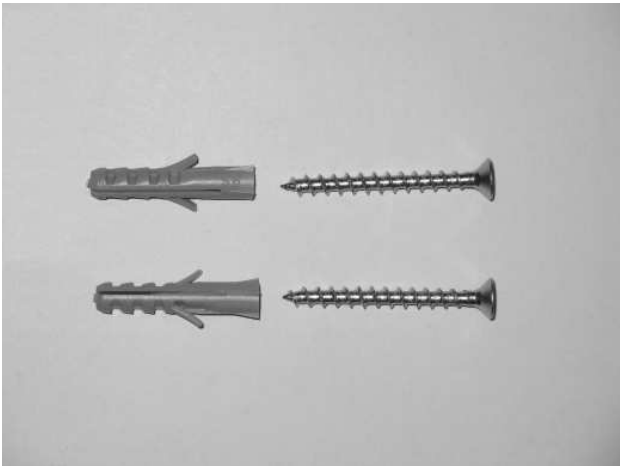

For further installation procedures, refer to paragraph 2.1.1 and 2.1.3.

“Unlined” installation (UK only!):

Minimum installation sizes

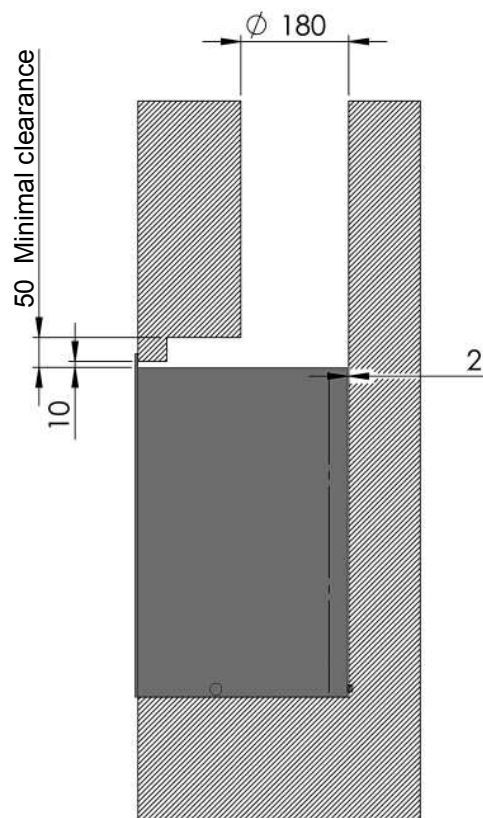
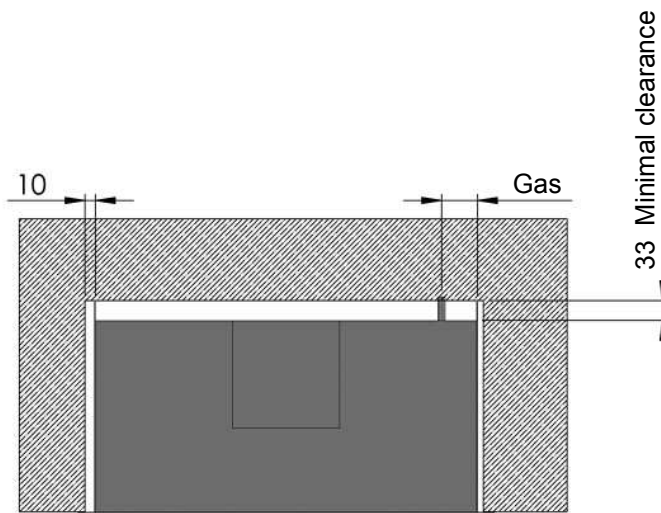

All sizes in mm.



### 2.1.3 Fitting into an existing opening equal to or smaller than the appliance

If the opening in the fireplace is too small for the appliance, it must be enlarged by a recognised installer in accordance with applicable building regulations.

#### “Lined” installation:

Please follow the installation chronology below when positioning a fireplace:

#### 1 Positioning of the appliance / Gas supply / Electrical connection:

Place the appliance in the open fire place and position it by the wall. Install the appliance using a level. Ensure the gas supply pipe has already been fed through the designated opening at the rear (tunnel), bottom or on the side. A gas tap must be installed in the vicinity of the appliance that must remain accessible at all times.

The Netherlands: placement of the appliance’s gas tap is permitted in the meter cupboard.

U.K./Ireland: the appliance is factory equipped with a gas tap.

If the appliance is equipped with an electrical connection (applicable if the appliance has ambient lighting and/or AC Power adaptor), this can now be connected to a wall socket. Ensure that during installation there is no power supply to the wall socket. The wall socket must remain accessible at all times.

#### 2 Dismantling the door and glass: (see pictures 2.1.2)

Dismantle the door (including the glass) by loosening left- and right under a screw a few turns. Carefully raise the door slightly, tilt forwards and take out. Remember to wear work gloves!

#### 3 Removing the grate:

Remove the grate around the burner by raising it and taking it out.





4 Dismantle the flue gas outlet connection: (see pictures 2.1.2)

In order to connect the (insulated) aluminium or (flexible) stainless steel flue (Ø100 mm) onto the appliance, the flue gas outlet connection must first be dismantled from inside the appliance.

- a. Disassemble first the baffle plate at the top of the combustion chamber, by a front screw loosening, and take the plate out.
- b. Disassemble after this the draft diverter from the top of the combustion chamber, by loosening the screws around and take it out.
- c. Disassemble the plate with flue outlet connection piece, by loosening the bolts on the outer edge. Do not fully unscrew the bolts around the flue outlet connection piece! The plate with the flue outlet can now be removed.

5 Assembling the flue:

Carefully pull the flue downwards through the appliance and secure to the flue gas outlet connection. If necessary secure the connection with a few stainless steel parker screws and/or a hose clip.

Ø4" Flue:



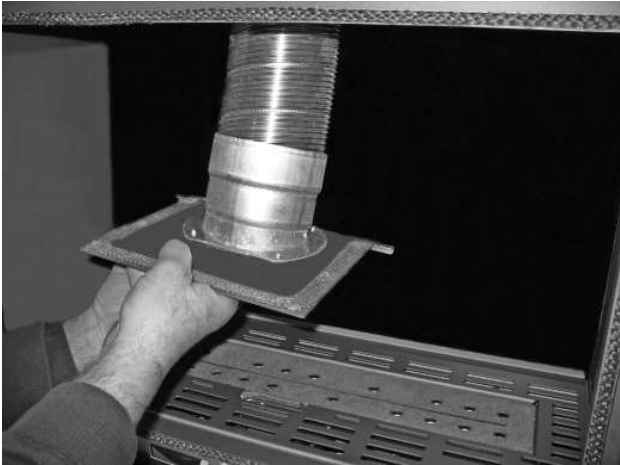

Ø5" Flue:



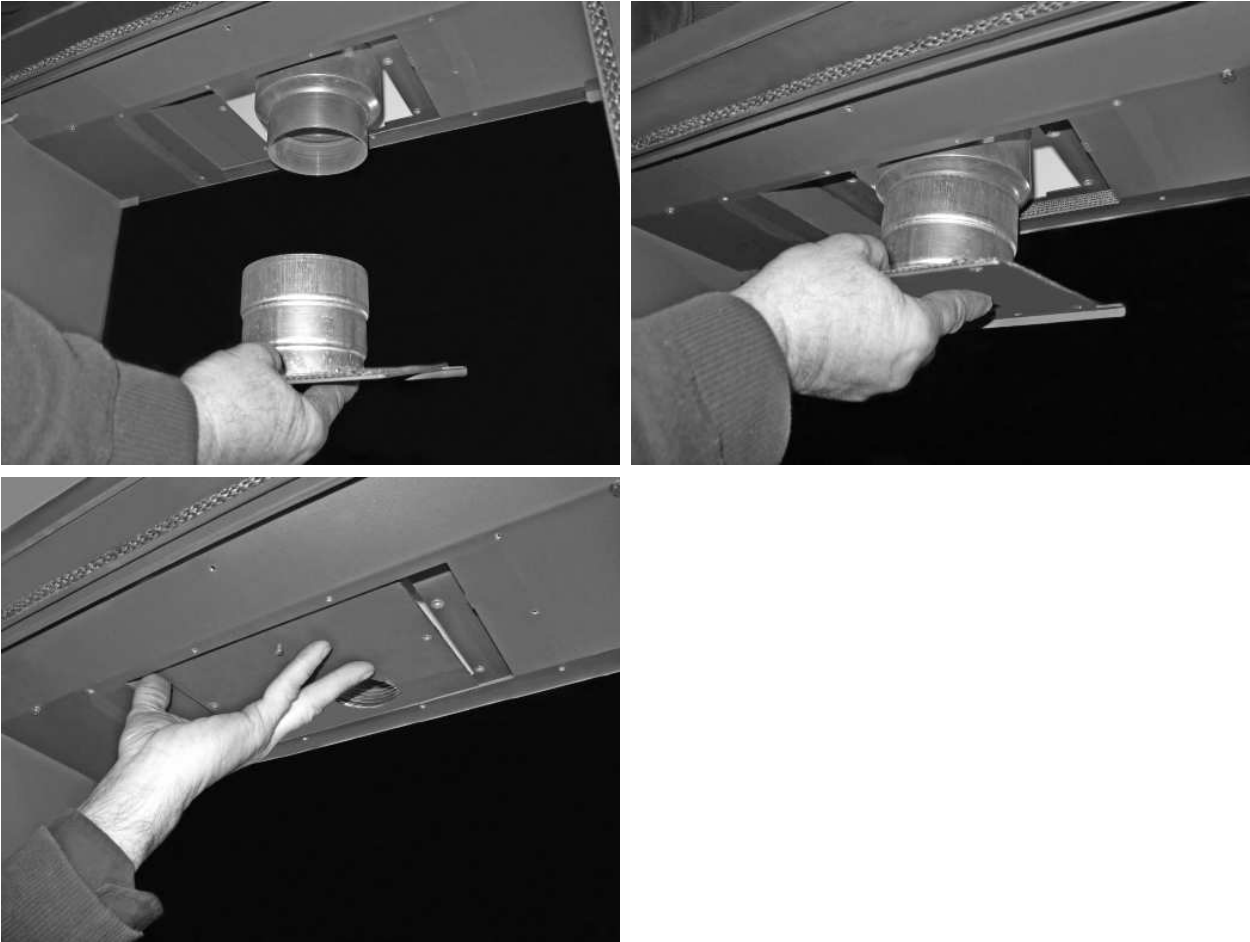

6 Assembling the flue gas outlet connection:

Push the plate with the flue gas outlet connection back upwards and secure. Then assemble the draft diverter and baffle plate. Check all connections connect properly and check for tightness !

7 Gas and electricity connection:

Using a compression fitting you can connect the gas to the appliance. Beware that during connection there is no power supply to the gas regulating block and pipes. The power supply can now be reconnected to the wall socket. (Only applicable if the appliance is equipped with an ambient lighting and/or a AC power adaptor.) Prevent the power cord touches the side of the unit. This is due to the high temperatures of the appliance. Keep this in mind when making the connection to the wall socket.

8 Check for gas-tightness and appliance functioning:

After assembly check all gas (compression) connections for gas-tightness using soapy water or a gas leak detector. Also leave the appliance to burn for a while (maximum 1 minute !) before proceeding. Please consult the instructions for use, supplied separately with the appliance.

9 Positioning the grate:

Position the grate around the burner.

10 Positioning the ceramic log set or marble shingles:

The appliance can be supplied with:

- Ceramic log set + embers
- Marble shingles white (small, white marble stones)
- Marble shingles grey (small, grey marble stones)

**Important:**

- **Carefully place the chips of wood/embers/log set or marble shingles, on and around the main burner according to the directions in this chapter.**
- **Do not place any chips of wood/embers/log set or marble shingles against the pilot light burner. Make sure that the pilot flame can burn at all times freely over the main burner. Only in this way is proper ignition of the main burner ensured. Ignoring these directions could lead to a dangerous situation.**
- **Make sure that all burner orifices remains free at all times!**
- **The burner bed (with chips of wood/embers) and the positioning of the logs or marble shingles must not be changed.**
- **Only use those items supplied! These been rigorously checked and the quantities adapted to the appliance.**
- **Replacement parts, including the ceramic mat are available from your dealer.**
- **Fitting may only be carried out by a qualified person.**

Remove the glass according to the instructions in chapter 5; DISMANTLING / ASSEMBLING OF THE GLASS, THE REGULATOR AND BURNER.

### 10.1 Ceramic log set + chips of wood + embers

- 1 Place the ceramic mat on the burner in such a way that the holes in the mat are in line with the burner openings.
- 2 Remove the embers carefully from their packaging and spread them evenly over the burner mat and the grate around the burner.



Note ! :



- **Small embers and their residue should not be scattered on the burner. This can cause a blockage on the burner orifices.**
- **Embers must not be placed next to the pilot light burner.**
- **Important: make sure that all burner openings remain free !! Burner orifices, which are not open, could lead to a dangerous situation.**

3 Place the logs on the burner:

<u>Appliance</u>	<u>Natural gas-burner</u> see figure:	<u>Propane / Butane-burner</u> see figure:
Unica-2 40	3	4

Keep the burner orifices unblocked !!!

4 Place the chips of wood around the burner.

**Logs:**



Log no ❶



Log no. ❷



Log no ❸



Log no ❹



Log no ❺



Log no ❻



Log no ❼



Log no ❽



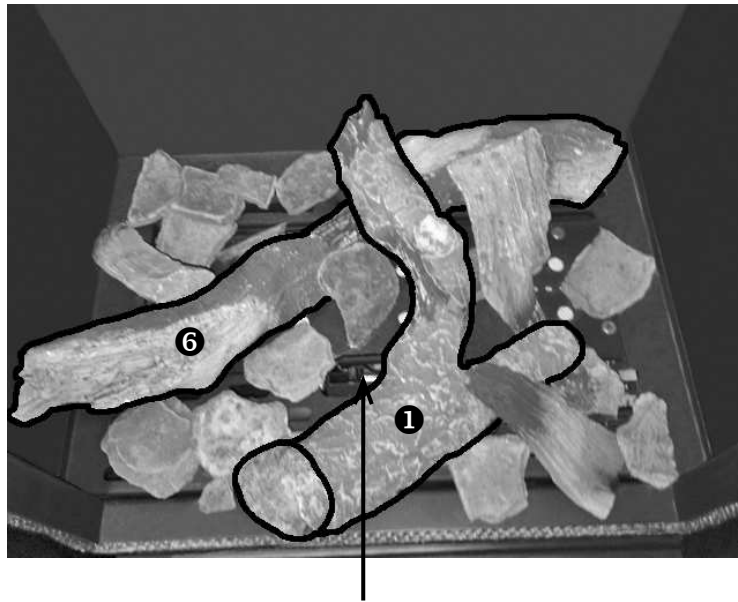

Embers must not be placed next to the pilot light burner

Keep the burner orifices unblocked!

**Figure 3: Log set Unica-2 40**  
**Position natural gas burner**

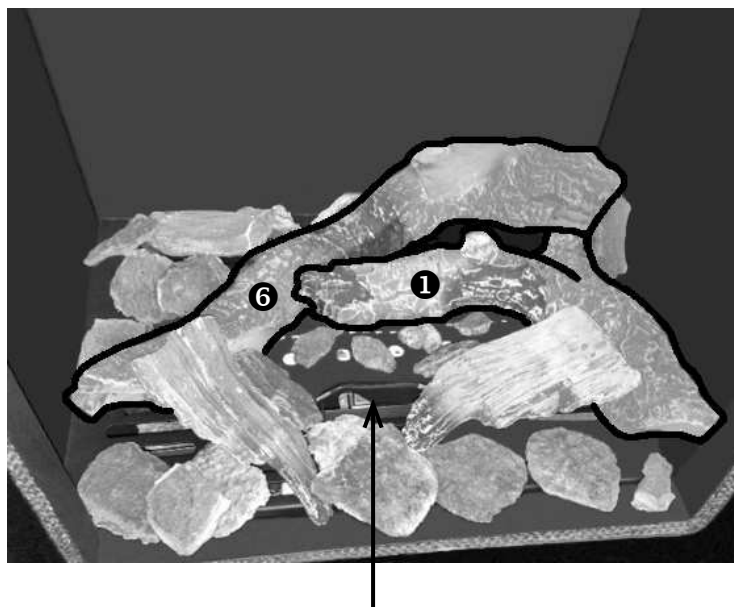

Embers must not be placed next to the pilot light burner

Keep the burner orifices unblocked!

**Figure 4: Log set Unica-2 40**  
**Position propane/butane burner**

## 10.2 Marble shingles

- 1 Place the ceramic mat on the burner in such a way that the holes in the mat are in line with the burner openings.
- 2 Spread the shingles over the whole burner bed (burner and grid around the burner). Make sure that the pilot light remains free.

Unica-2 40 : see figure 6

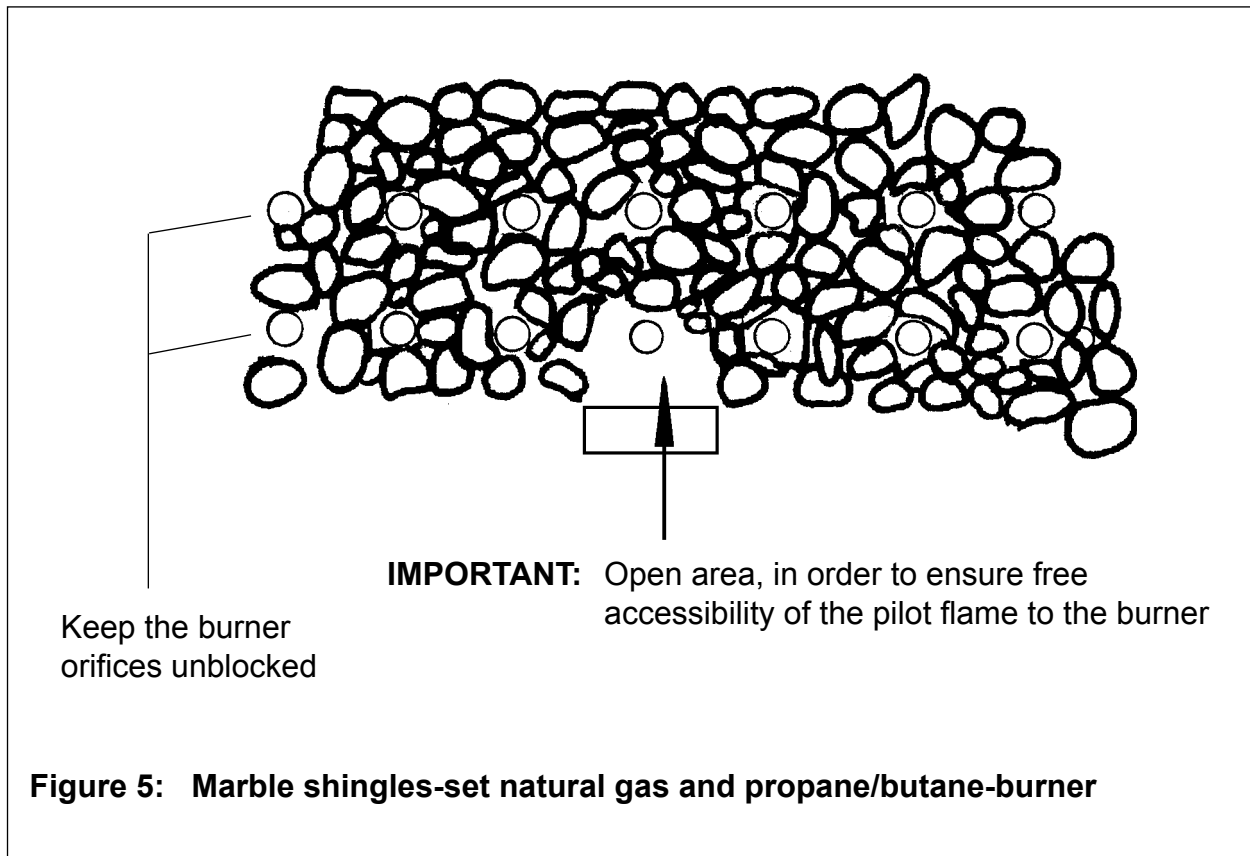

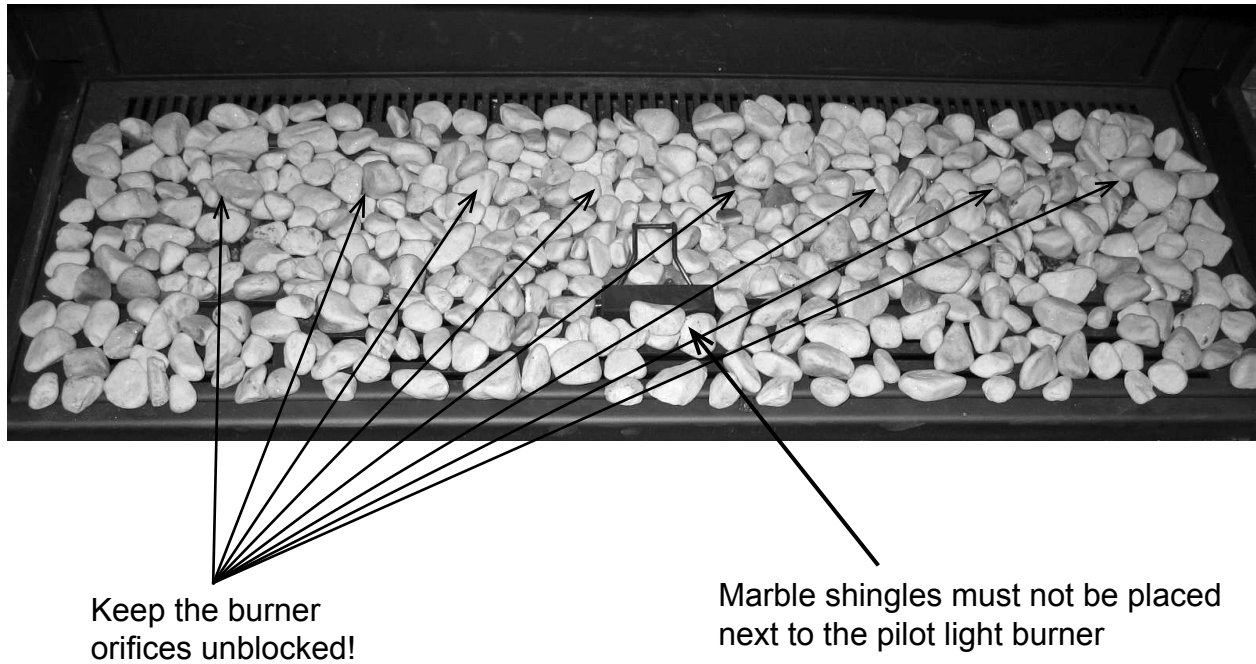

Keep the burner orifices unblocked!

**Figure 6: Marble shingles Unica-2 40**  
**Position natural gas and propane/butane burner**

**Important:**



- **Do not place any marble shingles in front of the pilot light. Make sure that the pilot light can burn freely over the main burner.**
- **Keep the burner orifices unblocked.**

**Only this way a proper ignition of the main burner is ensured.**

Once the logs / marble shingles have been positioned, replace the glass in the appliance, following the instructions in chapter 5: DISMANTLING / ASSEMBLING OF THE GLASS, THE REGULATOR AND BURNER.

**11 Assembling the glass door:**

Assemble the door (including the glass) by hooking it in at the top, and then screwing it into place at the bottom left and right. Remember to wear work gloves ! Check whether the door's sealing cord fits snugly on the appliance!

**12 Checking the appliance after installation:**

Having installed the appliance the installer must check the following:

- a. Full functioning of the appliance. Please consult the "Instructions for use & maintenance manual" supplied separately with the appliance.
- b. The flue gas outlet. 10 Minutes after initial use of the appliance there must be no flue gas escape. (See  below.)
- c. Combustion air supply. The combustion air supply opening in the space where the appliance is positioned must equate to the minimal size as outlined in Chapter 8.
- d. The fire's visual flame picture. Upon ignition you will see short blue/yellow flames. These flames will gradually lengthen and become yellower. Once all the flames are yellow the appliance has reached the right temperature.

The appliance is now ready for use.

**Attention: Spillage of flue gases into the room may not occur !**

Check if there is spillage of flue gases, after installing the appliance, and after the yearly maintenance.

- Close all windows and doors in the room
- Check if all ventilation openings according the building regulations are open
- Ignite the fire and let the appliance run on maximum position for 10 minutes
- Position a lighted smoke match just in front of the draught diverter opening. This opening is just above the glass door, in the middle. The smoke must be drawn fully into the opening.
- During the test NO SMOKE may enter into the room !
  
- If there is any doubt: Let the appliance run for another 5 minutes and do the test again.
  
- Run all extractor fans ,air conditioning ,or air recirculation systems in this and any adjoining rooms, on full, prior to performing the spillage test .

**When spillage of flue gases occurs during one of the tests, disconnect the appliance immediately and ask your dealer for advice.**

### 3 ANNUAL MAINTENANCE



It is **essential** that the appliance, the flue and the combustion air supply outlet are cleaned and inspected **annually** by a recognised fitter/gas specialist. The safe operation of the appliance will thus remain guaranteed.

Maintenance consists of the following:

① Inside of the gas fire:

- Temporarily remove the door by unscrewing the screws bottom left and right, by pulling forwards slightly at the bottom and by carefully raising the door and taking it out.
- Check the door's seal. Replace the sealing cord if necessary.
- Regularly clean the glass on the inside of the appliance with glass spray or ceramic hob cleaner.

*Caution! : Careful with glass cleaner!*

*Make sure that no glass cleaner liquid flows in the sealing of the inside of the glass pane at the bottom of the door. Spray each time a little glass cleaner liquid on the glass, and polish it off immediately. Glass cleaner liquid in the sealing of the door can cause dissolving of the black border on the inside of the glass. It will become very spotty and can't be repaired.*



- If the glass is broken or cracked, it must be immediately replaced before operating the fire again.



*Broken ceramic heat-resistant glass may not be disposed in a glass recycling container, but must be included in normal household waste.*

- Remove first the embers and logs set from the main burner and carefully clean these with a soft brush.
- Clean and inspect (visually) the main burner, pilot light and combustion chamber. Dust can be removed using a vacuum cleaner.
- After cleaning; Carefully replace the embers, logs set or shingles on and around the main burner according to the installation directions in this instruction manual. **Do not place any embers, logs or shingles against the pilot light burner. Make sure that the pilot flame can burn at all times freely over the main burner. Only in this way is proper ignition of the main burner ensured. Ignoring these directions could lead to a dangerous situation.**
- Check the whole gas route for leaks.

- Check the correct operation of the gas regulating block, thermocouple circuit and the ignition of the main burner.
- Check the gas inlet-pressure (both when the appliance is off and when it burns at maximum) and the burner pressure.

② Flue:

- Inspect and clean the whole flue pipe and chimney outlet on the roof. Check for cracks, loose parts, flue gas leakage and the overall condition of the flue. If in doubt, use an inspection camera !

③ Combustion air supply appliance:

- Check the combustion air path from the outside air into the appliance.
- Clean the combustion air supply openings in the appliance. Dust can be removed using a vacuum cleaner.
- Clean the combustion air intake openings (exterior grille).

④ Convection air appliance:

- Check the convection air route.
- Turn off the power to the appliance.
- Clean the convection air intake openings, channels and outflow openings.

⑤ Ambient lighting (option):

- Disconnect the power to the appliance.
- Carefully clean the ambient lamps.



Replacing of the ambient lamps when broken:

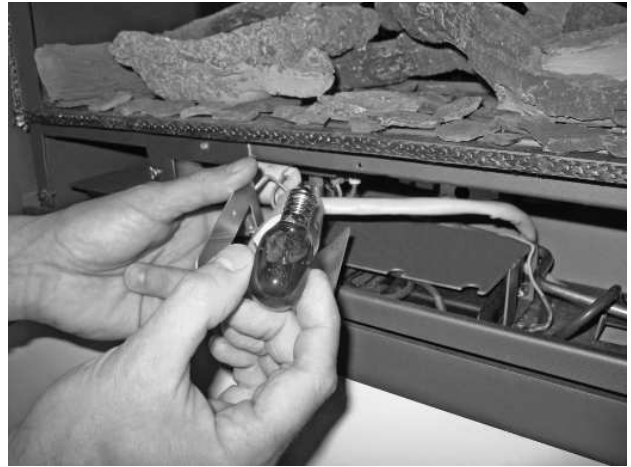

- First carefully separate the aluminum caps, left and right, with a nut driver No. 7 (or standard screwdriver).

- Carefully unscrew the broken light bulbs from the ceramic fitting.



- Carefully turn the new light bulbs, left and right, in the ceramic fittings. Use only the Bellfires Fire Glow light bulb.
-  Turn the Fire Glow light bulbs completely into the socket
- Assemble the aluminum caps.
- Plug the unit into the wall socket.
- Check the operation of the lamps using the remote control. See Instructions for use,  **Setting light / dimmer.**

⑥ Outside appliance:

- Clean the outside of the appliance with a dry, lint-free cloth.
- Only when the appliance has cooled, it can be cleaned. Never use abrasive, corrosive agents or fireplace cleaner.
- Any damage to paintwork can be repaired with an aerosol BELLFIRES heat-resistant paint. (Note that the appliance has sufficiently cooled down !)

⑦ House ventilation:

- Make sure that the room where the appliance is installed has adequate ventilation in accordance with applicable national and local standards.
- Avoid too much dust and particles of cigarette smoke, candles and oil lamps in the air of your home. Heating of these particles through the convection system of the appliance may lead to discoloration of walls and ceiling. Therefore, always ventilate the room sufficiently, where the appliance is installed.

⑧ Final check:

- Replace the door onto the appliance.
- Turn the power back on.
- Check the operation of the pilot burner, main burner, flame picture and ambient lighting (option).
- Check for flue gas spillage above the door in the middle.  
10 Minutes after the ignition of the main burner flue gas spillage is not allowed.  
(△ See also 2.1.3, point 12)

⑨ General:

- Parts:  
Individual parts for replacement or accessories are available from your BELLFIRES-dealer. Use only original parts.
- Modifications:  
Introduced modifications to the appliance are not permitted.



## 4 FAULTS

### 4.1 POSSIBLE REASONS

Possible reasons for the gas fire going out are:

- Atmosphere protection (= "oxy-stop" pilot flame) reacts (= pilot flame extinguishes) when the flue gases are insufficiently exhausted.
- Atmosphere protection (= "oxy-stop" pilot flame) is contaminated or defective.
- Insufficient gas pressure.
- Thermocouple voltage is too low. This is usually caused by insufficient heating of the thermocouple by the pilot light.
- Dirty electrical contacts in the thermo-electrical system; for example, the thermocouple connection.
- Batteries in receiver or remote control are flat.

### 4.2 SAFETY MEASURE IN THE APPLIANCE

#### 4.2.1 Thermo-electric pilot light shut off

The appliance is protected by means of a thermo-electric pilot light shut off in the event of a gas escape from the main burner.

#### 4.2.2 Atmosphere protection (flue exhaust protection) (= "oxy-stop" pilot light)

Also the appliance is fitted with an atmosphere protection facility. This is an "oxy-stop" pilot flame that turns off the burner if the flue gas is insufficiently exhausted

When the flame is blue and hazy (when the appliance is burning for some time), this means that combustion is not correct, and that the "oxy-stop" will be activated within a certain period.

If the "oxy-stop" pilot flame is activated then check that the air supply and the flue exhaust are open. Following isolation of the cause, the appliance can be put back into operation.

Always contact your installer in the event of continual problems.

It is not permitted to disable or modify the protection.

In the event that the "oxy-stop" pilot flame is to be replaced, then only the original model should be applied.

**This atmosphere protection; the "oxy-stop" pilot light, is not a substitute for an independent-mounted carbon monoxide detector.**

## 5 DISMANTLING / ASSEMBLING OF THE GLASS, REGULATOR AND BURNER

### 5.1 DISMANTLING

- 1 Close the gas supply tap.
- 2 Unscrew with several turns the 2 screws (to fix the door) left and right below.
- 3 Remove the door by lifting it and pulling it forwards out.



**Use working gloves when removing the door !**

- 4 Remove the log set and the embers, or the marble shingles.
- 5 Carefully remove the grate (around the burner). Avoid damaging the walls!
- 6 Dismantling pilot light: Dismantling pilot light: Unscrew the 2 screws next to the pilot light. Remove the wind guard. You can now dismantle the complete “oxy-stop” pilot light in the front.
- 7 Dismantling the main burner: Unscrew the 2 bolts (Left and Right) from the main burner. Loosen the compression fitting with the mainburner pipe. You can now remove the main burner.
- 8 All components are now available and removable.

### 5.2 ASSEMBLY

Assemble in the reverse order.

Ensure that the sealing cord from the glass plate mate correctly.

Re-check all re-fitted gas connections for leaks using soapy water or a leak tester.

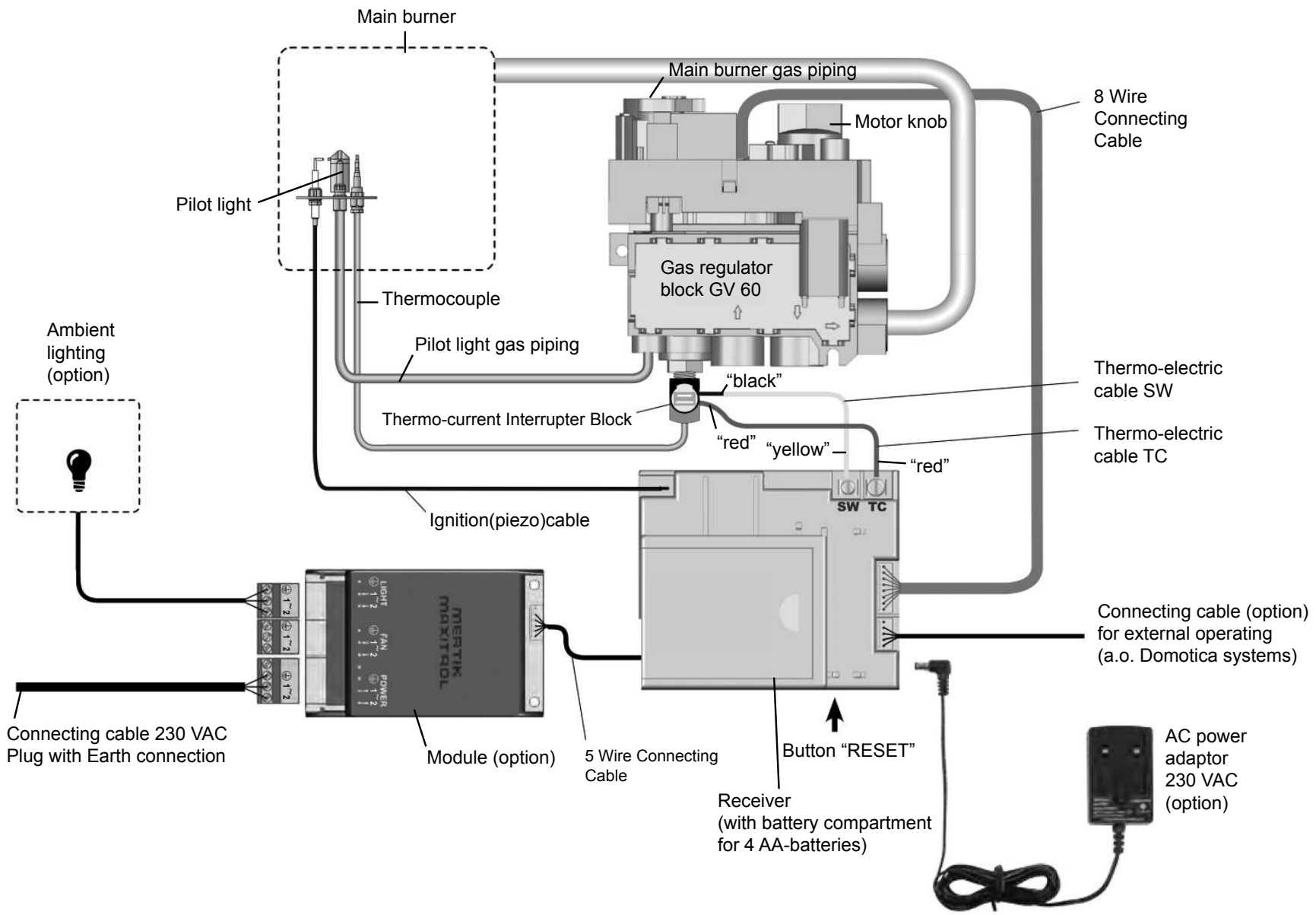

6 CONNECTING DIAGRAM

7 DIMENSIONS

7.1 UNICA-2 40

Lined flue: Ø4" or Ø5"

Top flue opening: Ø100/106 mm

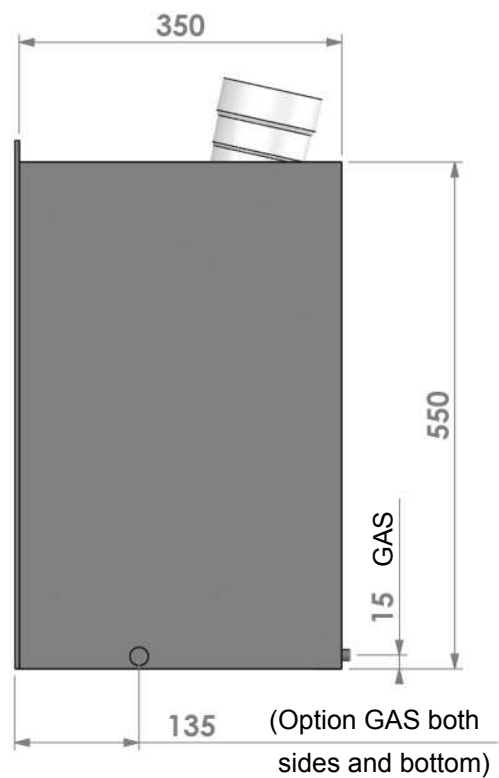
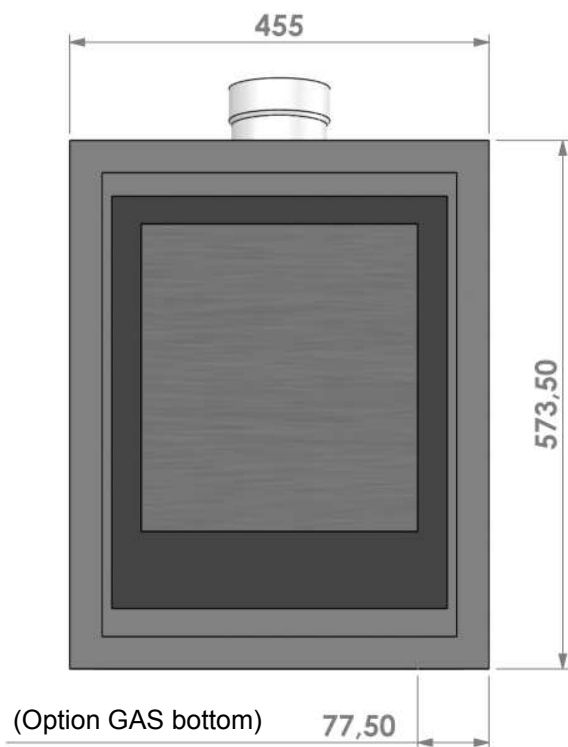
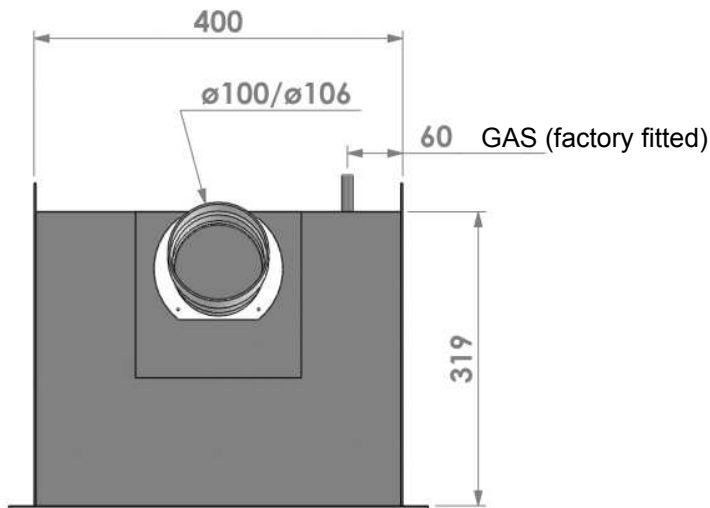

7.2 UNICA-2 40 (U.K. only!)

Unlined flue: Ø7" (180 mm) Minimal

Rear flue opening: ▧ 217 x 34.5 mm

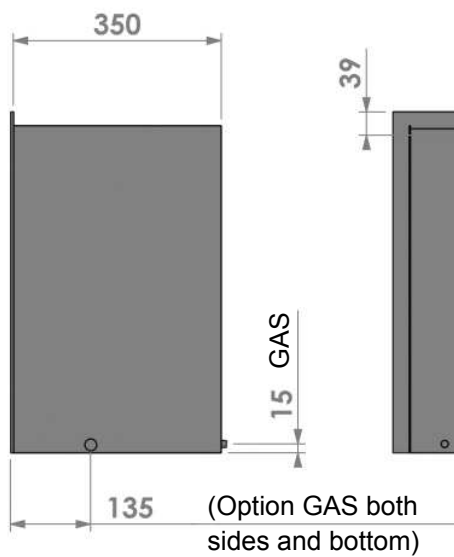
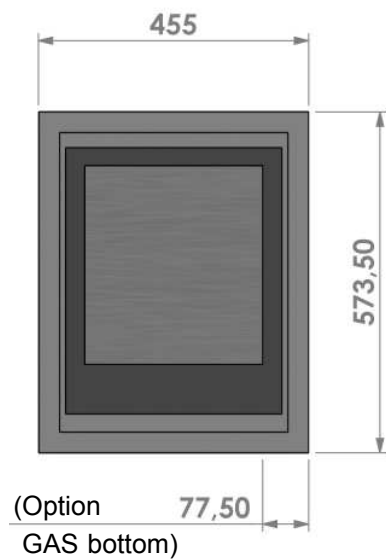
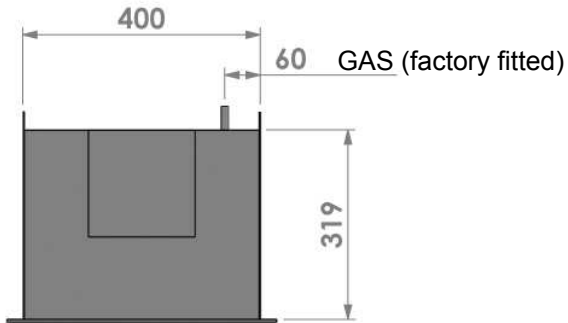

## 8 TECHNICAL DETAILS/REGULATIONS

### National installation regulations:

- Gas safety installation and use regulations 1998 plus all relevant safety and building regulations concerning fire installation
- Document J: Combustion appliances and fuel storage systems

<b>Model</b>	: UNICA-2 40	
<b>Gas</b>	: NATURAL GAS	: BUTANE/PROPANE
<b>Country</b>	: GB; Great Britain/IE; Ireland	: GB; Great Britain/IE; Ireland
Product identification no	: 0063AU3899	: 0063AU3899
Type of appliance under CE-norm	: B <sub>11AS</sub>	: B <sub>11AS</sub>
Category of appliance	: I <sub>2H</sub> natural gas G20	: I <sub>3B/P</sub> butane/propane G30/G31
Nominal heat input (Gross calorific value)	: 6.0 kW	: Butane (G30) : 5.5 kW Propane (G31): 4.7 kW
Nominal heat output	: 4.4 kW	: 3.4- 4.0 kW
Efficiency class	: 2 (80%)	: 2 (80%)
NOx-class	: 5	: 5
Gas rate (max.)	: 0.59 m <sup>3</sup> <sub>s</sub> /hr.	: Butane (G30) : 420 gr/hr. Propane (G31): 360 gr/hr.
Supply pressure	: 20.0 mbar	: Butane (G30) : 37.0 mbar Propane (G31): 37.0 mbar
Burner pressure (max.) Hot	: 10.8 mbar(*)	: 29.0 mbar
Burner pressure (max.) Cold	: 10.1 mbar(**)	: 29.0 mbar
Burner pressure (min.)	: 1.7 mbar	: 5.0 mbar
Primary air inlet burner	: Ø15 mm (side)	: 15 x 20 mm + 20 x 25 mm
Required minimal ventilation opening (***)	: 30 cm <sup>2</sup>	: 30 cm <sup>2</sup>
Gas regulator block (remote control)	: Mertik GV 60	: Mertik GV 60
Main burner	: 300 x 100 mm	: 300 x 100 mm
Main burner injector	: no 210 (= 1x Ø2.10 mm)	: no 120 (= 1x Ø1.20 mm)
Pilot light burner - Oxy-stop	: SIT 9040	: SIT 9226
Gas connection	: 3/8" G / Ø8 mm	: 3/8" G / Ø8 mm
Flue connection: Lined	: Ø100 mm - Ø106 mm (4")	: Ø100 mm - Ø106 mm (4")
Unlined (UK only)	: Ø180 mm (7")	: Ø180 mm (7")
	<input checked="" type="checkbox"/> Appliance: 217 x 34 mm	<input checked="" type="checkbox"/> Appliance: 217 x 34 mm

<b>Model</b>	<b>: UNICA-2 40</b>	
<b>Gas</b>	<b>: NATURAL GAS</b>	<b>: BUTANE/PROPANE</b>
<b>Country</b>	<b>: GB; Great Britain/IE; Ireland</b>	<b>: GB; Great Britain/IE; Ireland</b>
Batteries remote control		
- Receiver	: 4x 1.5V AA	: 4x 1.5V AA
- Hand-transmitter	: 1x 9V block	: 1x 9V block
Electrical supply(****)	: 230 VAC / 50 Hz	: 230 VAC / 50 Hz
Electricity consumption(****)	: 50 W (max.) / IP 20	: 50 W (max.) / IP 20
Weight	: 41 kg	: 41 kg

(\*) : When the appliance has reached its thermal equilibrium.

(\*\*) : Burner at maximum. Appliance is cold.

(\*\*\*) : UK only: The appliance has a nominal input not exceeding 7.0 kW and does not normally require any additional permanent ventilation.

(\*\*\*\*) : When the appliance is equipped with an ambient lighting

Heat changing surface: Entire front of the appliance.

## 9 REPLACEMENT PARTS LIST

When requesting service or ordering replacement parts, please quote the model type and serial number. All parts listed in this manual may be ordered from a Bellfires dealer.

No	Article no	Description
1	336923	Main burner <u>Natural gas G20/G25.3</u> / <u>Butane/Propane G30/G31</u> G20: 1x Ø15 mm (side venturi) G30/G31: 15x20 mm + 20x25 mm (side+underside venturi)
2	337098	Burner mat Top L = 295 mm
3	334876	Main burner injector <u>Natural gas</u> ; no 210 (1x Ø2.10 mm)
4	334874	Main burner injector <u>Butane/Propane</u> ; no 120 (1x Ø1.20 mm)
5	333597	Gas regulator block; GV 60 (M10 Thermocouple connection)
6	302083	Plug 3/8 GV 60
7	302084	Nut Ø8 mm for burner supply GV 60
8	302089	Olive Ø8 mm for burner supply GV 60
9	302086	Cut-off nipple Ø4 mm GV 60
10	333601	Cable (sw): Receiver - Thermocouple interrupter, L = 500 mm
11	333602	Cable (tc): Receiver - Thermocouple interrupter, L = 500 mm
12	333598	Hand-held transmitter: Display: Temperature and two programmes
13	333600	Receiver GV 60 - EU
14	302068	8 Wire connecting cable - Receiver, L = 500 mm
15	325640	Piezo ignition cable, $\sphericalangle$ 2.8 x 0.8 mm, L = 500 mm
16	333604	Thermocouple interrupter M10
17	333648	Oxy-stop Pilot light set 9040, <u>Natural gas</u>
18	333649	Oxy-stop Pilot light set 9226, <u>Butane/Propane</u>
19	330954	Pilot light pipe; Ø4 mm, L = 300 mm, Flexible, Stainless steel
20	330953	Burner pipe; Ø8 mm, L = 300 mm, Flexible, Stainless steel
21	337099	Glass Unica-2 40 (447.5 x 364 x 4 mm)
22	333605	Module 230 VAC (Light)
23	333912	Fuse T 2,5 A 250 V Module
24	333606	Wire connecting cable Module - Receiver
25	333748	Lamp ambient-lighting 230 VAC, E14, 25 W (Fire glow light bulb)
26	337504	Log set (2-parts) <u>Natural gas</u> / <u>Butane/Propane</u> incl. set chips of wood and 125 gram embers
27	301669	Tube ceramic glue
28	311006	Black fibre glass tape 20 x 2 mm, adhesive
29	301617	Black fibre glass cord Ø10 mm



Appliance	Log set									Chips of wood set	Embers with Glow-effect Anthracite	Marble shingles set (white)	Marble shingles set (grey)		
	Set	Log no										3 pieces	Bag: 125 gr.	Bag: 2.5 kg.	Bag: 2.5 kg.
		1	2	3	4	5	6	7	8						
	Art. no:	331357	331358	331359	331360	331361	331362	331363	331364			.....	301863	310937	325758
Unica-2 40	337504	1x	-	-	-	-	1x	-	-	1x	1x	1x	1x		

## 10 DISPOSING OF PACKAGING AND APPLIANCE

The appliance comes in recyclable packaging.

This can include:

- Cardboard
- Wood
- Plastic
- Paper

Such materials must be disposed of responsibly, in line with local regulations.

Batteries should be disposed of as chemical waste. Batteries must be disposed of responsibly, in line with local regulations.

The authorities or fitter can provide you with information on responsible disposal of obsolete appliances.





**Your Bellfires dealer**

01 - 010414 - 337106