





## THREE EASY WAYS TO CONTACT US FOR ALL 3M CUSTOM WOODWORKING PRODUCTS:

*3M can provide additional products and accessories to meet your needs.  
Please contact us in any of the following ways that you prefer:*

- *Contact your local 3M authorized distributor directly. For information on a 3M distributor or sales representative in your area contact us at the numbers below:*

*For the contiguous 48 states*

*call* \_\_\_\_\_ **1-866-279-1235**  
*fax* \_\_\_\_\_ **651-778-4244**

*For*

*Alaska* \_\_\_\_\_ **907-522-5200**

*Canada* \_\_\_\_\_ **519-451-2500**

*Hawaii* \_\_\_\_\_ **808-422-2721**

*Puerto Rico* \_\_\_\_\_ **787-620-3000**

- *Email us at* **3MIndustrial@mmm.com**
- *Visit the 3M Custom Woodworking and Cabinet Shop Website at* **www.3M.com/woodworking-catalog**

*For additional 3M product information or material safety data sheets call* **1-800-3M Helps**  
*or visit us at* **www.3M.com**

# Table of Contents



## Abrasives

page 1 – 39

3M™ Woodworking Belt Selection Guide _____	1 – 2	3M™ Hookit™ Systems _____	27
3M™ Wide Belts _____	3 – 9	3M™ Hookit™ Discs _____	27 – 28
3M™ Portable Tool Belts _____	10	3M™ Hookit™ Accessories _____	28 – 29
3M™ Edge Sanding Belts _____	11 – 12	3M™ Hookit™ II Systems _____	30
Scotch-Brite™ Radial Bristle Discs _____	12	3M™ Hookit™ II Discs _____	30 – 31
3M™ Mandrel _____	12	3M™ Hookit™ II Accessories _____	32 – 34
Random Orbital Sanding _____	13 – 14	3M™ PSA Discs _____	34
3M™ Stikit™ Systems _____	15	3M™ Abrasive Sheets _____	35 – 36
3M™ Stikit™ Discs _____	15 – 21	3M™ Professional Shop Rolls & Cloth Sheets _____	37
3M™ Stikit™ Accessories _____	22 – 24	Scotch-Brite™ Hand Pads _____	37
3M™ Stikit™ Sheet Roll System _____	25	3M™ Sanding Sponges _____	38
3M™ Stikit™ Sheet Rolls _____	26	3M™ SandBlaster™ Sanding Sponges _____	39
3M™ Stikit™ Refill Roll System _____	26		

## Solid Surfaces

page 40 – 46

Sanding Sequence Recommendations _____	41	3M™ Finesse-it™ Products _____	43
3M™ Microfinishing Film _____	42	3M™ Aluminum Foil Tape _____	44
3M™ Trizact™ Film Discs _____	42	3M™ Protective Tapes _____	44
Scotch-Brite™ Discs _____	43	3M™ Scotch-Weld™ Adhesives _____	45
3M™ Polishing Film _____	43	3M™ Jet-melt™ Adhesives™ _____	46
3M™ Wetordry™ Disc _____	43		

## Adhesives

page 47 – 56

3M™ Aerosol Adhesives _____	48 – 49	3M™ Assembly Adhesives _____	52 – 56
3M™ Contact Adhesives _____	50 – 51	3M™ Structural Assembly Adhesives _____	56

## Tapes and Masking Systems

page 58 – 64

Masking Tapes _____	58 – 60	Scotch® Filament Tapes _____	62
Scotch® Box Sealing Tapes _____	61	Filament and Stretchable Tape Dispensers _____	63
Scotch® Box Sealing Tape Dispensers _____	61	3M™ Duct Tapes _____	63
Scotch® Box Sealing Accessories _____	62	3M™ Hand-Masker™ Masking Systems _____	64
Scotch® Pallet Wrap Tapes _____	62		

## Protective Products

page 65 – 69

3M™ Bumpon™ Protective Products _____	66 – 67	3M™ Aluminum Foil Tapes _____	69
3M™ Protective Tapes _____	68		

## Safety Products

page 70 – 85

3M™ Particulate Respirators _____	71	3M™ Replacement Parts and Accessories 7500 Series _____	79
Respirator Selection Guide _____	72	3M™ Air Monitors _____	79
3M™ Filtering Facepiece Respirators _____	73 – 75	3M™ Health and Safety Services _____	80 – 81
3M™ Half Facepiece Respirators _____	76	3M™ Hearing Protection _____	81 – 82
3M™ Filters and Retainers, 5000/6000 Series _____	77	3M™ Eye Protection _____	83 – 84
3M™ Cartridges/Combination Cartridges/ P100 Particulate Filters 6000 Series _____	78	3M™ Maintenance Sorbents _____	84
3M™ Particulate Filters 2000 Series _____	79	3M™ Matting _____	85

## Miscellaneous Products

page 86 – 89

3M™ PPS™ Paint Preparation System _____	87	3M™ Silicone Lubricant _____	89
3M™ Tack Cloth and Pad _____	88	3M™ 5-Way Penetrant _____	89
3M™ Citrus Base Cleaner _____	88	3M™ Lightweight Body Filler _____	89
3M™ Vetrap™ Bandaging Tape _____	88	3M™ Creme Hardener _____	89



# Abrasives

3M™ Woodworking Belt  
Selection Guide

3M™ Wide Belts

3M™ Portable Tool Belts

3M™ Edge Sanding Belts

Scotch-Brite™ Radial  
Bristle Discs

3M™ Mandrel

Random Orbital Sanding

3M™ Stikit™ Systems

3M™ Stikit™ Discs

3M™ Stikit™ Accessories

3M™ Stikit™ Sheet Roll System

3M™ Stikit™ Sheet Rolls

3M™ Stikit™ Refill Roll System

3M™ Hookit™ Systems

3M™ Hookit™ Discs

3M™ Hookit™ Accessories

3M™ Hookit™ II Systems

3M™ Hookit™ II Discs

3M™ Hookit™ II Accessories

3M™ PSA Discs

3M™ Abrasive Sheets

3M™ Professional Shop Rolls  
& Cloth Sheets

Scotch-Brite™ Hand Pads

3M™ Sanding Sponges

3M™ SandBlaster™  
Sanding Sponges

# 3M™ Woodworking Belt Selection Guide

	3M ID	Backing	Wide Belt Sanding	Edge Sanding	Portable Belt Sanding
<b>High Performance Purple*</b> designed to provide the lowest overall manufacturing costs	761D	Y			X
	900DZ	J			
	930DZ	X		X	
	961UZ	F	X		
	970DZ	X or Y	X	X	
<b>Engineered</b> the standard of the industry	200D	J		X	
	200DZ	J		X	
	240A	X	X	X	
	270D	Y	X	X	
	362UZ	F	X		
	363UZ	F	X		
<b>General Use</b> the best product when price is a major consideration	240D	X	X	X	X
	241D	X	X	X	X
	251U	E	X		

\*The Purple color of the abrasive is a trademark of 3M.

## YOUR 3M SOLUTIONS HOTLINES:

3M can provide additional products and accessories to meet your needs.

Please contact us in any of the following ways that you prefer:

- 3M distributor or 3M sales representative in your area
- 3M Customer Response Center **1-866-279-1235**
- 3M Custom Woodworking and Cabinet Shop Website [www.3M.com/woodworking-catalog](http://www.3M.com/woodworking-catalog)

# 3M™ Woodworking Belt Selection Guide

*continued*



## Wide Belt Sanding

Recommend a stock removal of a few thousandths of an inch before entering the finishing sanding head to leave a flat and sanded surface. Avoid high sanding pressure to increase belt life. The platen head's performance is affected by the makeup of the platen pad. Use a soft platen pad cushion to produce a milder sanding scratch pattern. Confine soft cushions for operations using 180-grit and finer abrasives. Soft cushions used with coarse sanding will cause over-cutting of soft grains and edge dumping.



## Edge Sanding

Edge sanding involves the sanding of flat, narrow surfaces with small surface areas like panel edges. Additionally, a variety of cases, tables and chairs (some having band sawn surfaces) are sanded on this type of equipment.



## Portable Belt Sanding

Coarse grades remove wood stock to a uniform dimension, leaving enough wood to develop the final finish. The finishing grade(s) remove all previous abrasive grit scratches. Have no more than a two-grade jump between rough and finish sanding. For example, rough sand with 36-grit, followed by no finer than 50-grit.



## INTERNATIONAL MEASUREMENT CONVERSION CHART

*All specifications in this catalog are presented in U.S. units of measurement. To the right is a chart for converting these measurements to international units of measure.*

U.S. unit of measure	Conversion formula	International unit of measure
Inch	x 25.4	Millimeter
Pound	x .454	kg
PSI	÷ 14.7	Bar
SFPM	x .3048	SMPM
SCFM	x 28.32	LPM
HP	x 745.7	W



## 3M™ Wide Belts – Cloth

### General Use

#### 240D/241D

- Aluminum oxide on a durable X wt. cotton cloth backing
- 240D is an open coat belt that provides good cut with less loading
- 241D is a closed coat belt that provides great finish
- Excellent all-around abrasive belt for everyday use



Width x Length	Grade	UPC Number	Min /Case
25" x 60" 241D	P80	051144-11400-9	3
	P120	051144-70482-8	5
	P150	051144-77377-0	5
	P180	051144-74194-6	5
25" x 75" 241D	P60	051144-32557-3	3
	P80	051144-26269-4	3
	P100	051144-26268-7	5
	P120	051144-26267-0	5
36" x 75" 240D	P60	891040-03968-5	5
	P80	891040-03969-2	5
	P100	891040-03970-8	5
	P120	891040-03971-5	5
	P150	891040-06885-2	5
	P220	051144-32443-9	5
36" x 75" 241D	P80	051144-34706-3	3
	P180	051144-26259-5	5
36" x 84" 241D	P100	051111-66744-6	5
	P120	051111-66970-9	5
	P150	051111-66972-3	5
37" x 60" 240D	P50	051144-76900-1	3
	P60	891040-03949-4	5
	P80	891040-03950-0	5
	P100	891040-03951-7	5
	P120	891040-03952-4	5
	P150	891040-06828-9	5
	P180	891040-06829-6	5
	P220	891040-06830-2	5
	37" x 60" 241D	P80	051144-71992-1
P100		051144-71528-2	5
P120		051144-74271-4	5
P320		051111-69055-0	5

Width x Length	Grade	UPC Number	Min /Case
37" x 75" 240D	P50	051144-70479-8	3
	P60	891040-03929-6	5
	P80	891040-03930-2	5
	P100	891040-03931-9	5
	P120	891040-03932-6	5
	P150	891040-06822-7	5
	P180	891040-06823-4	5
	P220	891040-06824-1	5
37" x 75" 241D	P80	051144-14420-4	3
	P120	051144-33061-4	5
	P150	051144-32515-3	5
	P180	051144-14508-9	5
37" x 103" 240D	P220	051111-68751-2	5
37" x 103" 241D	P180	051111-66973-0	5
42" x 75" 241D	P100	051111-66968-6	5
	P180	051111-66974-7	5
43" x 75" 240D	P60	051144-70472-9	3
	P80	891040-03993-7	5
	P100	891040-03994-4	5
	P120	891040-03995-1	5
	P150	891040-06889-0	5
	P180	891040-06890-6	5
	P220	891040-06891-3	5
43" x 103" 240D	P120	051111-68753-6	5
	P150	051111-68752-9	5
50" x 103" 240D	P60	891040-03919-7	5
	P80	891040-03920-3	5
	P100	891040-03921-0	5
	P120	891040-03922-7	5



### 240D/241D *continued*

Width x Length	Grade	UPC Number	Min /Case
50" x 103" 241D	P320	051111-66976-1	5
	P400	051111-66978-5	5
52" x 75" 240D	P80	891040-06900-2	5
	P120	891040-04003-2	5
	P150	891040-06902-6	5
	P180	891040-06903-3	5
52" x 75" 241D	P60	051111-69054-3	3
52" x 103" 240D	P80	891040-04011-7	5
	P120	891040-04013-1	5
	P150	891040-06906-4	5

*For additional sizes and grades, contact your local 3M Authorized Distributor.*

## 3M™ Wide Belts – Paper

### General Use

#### 251U

- Aluminum oxide on E wt. paper – open coat
- Excellent all-purpose woodworking belt
- Excellent finishing product in fine grades

Width x Length	Grade	UPC Number	Min /Case
36" x 75"	P120	891040-03974-6	5
37" x 60"	P120	891040-03955-5	5
37" x 75"	P100	891040-03934-0	5
	P120	891040-03935-7	5
	P150	891040-03936-4	5
	P180	891040-03937-1	5
	P220	891040-03938-8	5
43" x 75"	P120	051111-68775-8	5
43" x 103"	P150	051111-68776-5	5
	P180	051111-68777-2	5
52" x 75"	P100	891040-04007-0	5
	P120	891040-04008-7	5
	P150	891040-04009-4	5
	P180	891040-04010-0	5
52" x 85"	P150	051111-66990-7	5
	P180	051111-66992-1	5
52" x 103"	P120	891040-04014-8	5
	P150	891040-04015-5	5
	P180	051111-68778-9	5
	P220	051111-68777-2	5

*For additional sizes and grades, contact your local 3M Authorized Distributor.*

### YOUR 3M SOLUTIONS HOTLINES:

*3M can provide additional products and accessories to meet your needs.*

*Please contact us in any of the following ways that you prefer:*

- 3M distributor or 3M sales representative in your area
- 3M Customer Response Center **1-866-279-1235**
- 3M Custom Woodworking and Cabinet Shop Website [www.3M.com/woodworking-catalog](http://www.3M.com/woodworking-catalog)

## 3M™ Wide Belts – Cloth *Engineered*

### 240A

- Premium aluminum oxide on a durable X wt. polyester/cotton cloth backing
- Open coat resists loading
- Excellent for wood and soft substrates

Width x Length	Grade	UPC Number	Min /Case
25" x 60"	P100	051144-11395-8	5
36" x 75"	P80	051111-68749-9	3
	P100	051111-66732-3	5
	P120	051144-27342-3	5
	P120	051111-66737-8	5
37" x 60"	P80	051144-34292-1	3
	P120	051144-34290-7	5
	P150	051144-34289-1	5
37" x 75"	P80	051144-27339-3	3
	P120	051144-30418-9	5
43" x 75"	P100	051144-33782-8	5
	P150	051144-71592-3	5
50" x 103"	P80	051144-27190-0	3
	P100	051144-27186-3	5
	P150	051144-27184-9	5
	P180	051111-66960-0	5
52" x 103"	P100	051111-66733-0	5
	P120	051111-66738-5	5



*For additional sizes and grades, contact your local 3M Authorized Distributor.*



### TECH TIP: Mineral Grading Systems

*There are four mineral grading systems used throughout most of the world. To the right is a comparison of mineral size. This is not a finish comparison and should be used only as a general guide.*

MICRO-ABRASIVE GRADES	ANSI GRADES	EUROPEAN "P" GRADE	3M™ TRIZACT™ ABRASIVES
9μ	800	— P2000	— A6
15μ	600	— P1200	— A16
		— P1000	— A30
30μ	500	— P800	— A45
	400	— P600	
	360	— P500	
40μ	320	— P400	
	280	— P360	
		— P320	
	240	— P280	— A65
60μ		— P240	— A80
	220	— P220	— A100
	180	— P180	
80μ		— P150	
100μ	150	— P120	
	120	— P100	
	100	— P80	
	80		

## 3M™ Wide Belts – Cloth

### *Engineered* (continued)

#### 270D

- Premium aluminum oxide mineral open coated on a durable Y weight backing
- Designed for intermediate wood sanding operations where premature loading or clogging may be a problem

Width x Length	Grade	UPC Number	Min /Case
25" x 60"	80	051144-77195-0	3
	100	051144-77363-3	5
	120	051144-77366-4	5
25" x 75"	36	051144-76915-5	3
36" x 75"	36	051144-77205-6	3
	40	051144-80899-1	3
	50	051144-14771-7	3
	60	051144-11506-8	3
	80	051144-73968-4	3
	100	051144-74370-4	5
	120	051144-74361-2	5
	150	051144-14450-1	5
37" x 60"	180	051144-80734-5	5
	36	051144-76916-2	3
	60	051144-14528-7	3
	80	051144-14686-4	3
	100	051144-76917-9	5
	120	051144-74362-9	5
37" x 75"	150	051144-76928-5	5
	180	051144-81094-9	5
	36	051144-11392-7	3
	50	051144-76910-0	3
	80	051144-73970-7	3
	100	051144-74372-8	5
	120	051144-74358-2	5
	150	051144-14685-7	5

Width x Length	Grade	UPC Number	Min /Case
43" x 75"	36	051144-77157-8	3
	60	051111-50873-2	3
	80	051144-77608-5	3
	100	051144-80347-7	5
	120	051144-80733-8	5
	150	051111-50874-9	5
50" x 103"	36	051144-73963-9	3
	60	051144-11855-7	3
	80	051144-73971-4	3
	100	051144-74336-0	5
	120	051144-73967-7	5
	180	051144-82518-9	5
52" x 75"	36	051144-77365-7	3
	40	051111-68804-5	3
	60	051144-14529-4	3
	80	051144-77197-4	3
	100	051144-77558-3	5
	120	051144-74359-9	5
52" x 103"	150	051144-77696-2	5
	60	051144-77549-1	3
	80	051144-14770-0	3
	100	051144-76863-9	5
	120	051144-76859-2	5
	150	051144-85363-2	5
	180	051111-67049-1	5

*For additional sizes and grades, contact your local 3M Authorized Distributor.*

#### YOUR 3M SOLUTIONS HOTLINES:

3M can provide additional products and accessories to meet your needs.

Please contact us in any of the following ways that you prefer:

- 3M distributor or 3M sales representative in your area
- 3M Customer Response Center **1-866-279-1235**
- 3M Custom Woodworking and Cabinet Shop Website [www.3M.com/woodworking-catalog](http://www.3M.com/woodworking-catalog)

## 3M™ Wide Belts – Paper

### Engineered

#### 362UZ/363UZ

- Premium aluminum oxide mineral on a heavy F wt. paper backing
- 362UZ is an open coat belt that provides good cut with less loading
- 363UZ is a closed coat belt that provides great finish
- Excellent general use, long lasting paper belt
- 3M™ Xodust™ Technology reduces static and airborne dust level when coupled with an efficient dust collection system

Width x Length	Grade	UPC Number	Min /Case
36" x 75" 362UZ	P100	051144-83230-9	5
	P120	051144-83225-5	5
	P150	051144-83222-4	5
	P180	051111-67256-3	5
36" x 75" 363UZ	P180	051144-84875-1	5
	P220	051144-83232-3	5
37" x 75" 362UZ	P100	051144-84880-5	5
	P120	051144-83879-0	5
	P150	051144-84881-2	5
	P180	051144-83929-2	5
37" x 75" 363UZ	P180	051144-83931-5	5
	P220	051144-83535-5	5

Width x Length	Grade	UPC Number	Min /Case
50" x 103" 362UZ	P120	051144-83226-2	5
	P150	051144-83223-1	5
	P180	051144-83219-4	5
50" x 103" 363UZ	P220	051144-83233-0	5
52" x 75" 362UZ	P120	051144-83227-9	5
	P150	051144-82819-7	5
	P180	051144-83220-0	5
52" x 75" 363UZ	P180	051144-83538-6	5
	P220	051144-83536-2	5
52" x 103" 362UZ	P100	051144-84883-6	5
	P120	051144-83228-6	5
	P150	051144-83224-8	5
	P180	051144-83221-7	5
	P220	051144-83218-7	5
52" x 103" 363UZ	P150	051144-84878-2	5
	P180	051144-83234-7	5

*For additional sizes and grades, contact your local 3M Authorized Distributor.*

#### TECH TIP: Final Finish Wide Belt Sanding

Upon entering the finishing head, the sanded finish and surface flatness should be such that stock removal of only a few thousandths of an inch will complete the sanding. For maximum belt life, be sure to avoid excessive sanding pressure. When a sanding platen is used for abrasive belt support, the make-up of the platen affects the performance of the head. The softer the platen, the milder the sanding scratch pattern. It is good practice to confine very soft or mushy platens to operations using grade 220 and finer. When used in coarse sanding, a soft platen tends to cause over-cutting in soft grain and edge dumping.

## 3M™ Wide Belts – Cloth

### High Performance

#### 970DZ (Purple\*)

- 3M™ Cubitron™ Abrasive Grain on a heavy cloth backing, open coat
- Provides extremely long life, and uniform finish
- Performs well on all wood species
- Reduced burning when performing “end-grain” sanding applications
- 3M™ Xodust™ Technology reduces static and airborne dust levels when used with an efficient dust-collection system



Width x Length	Grade	Backing Wt.	UPC Number	Min /Case
25" x 60"	80	Y	051111-50840-4	3
	P100	Y	051111-50841-1	5
	P120	Y	051111-50842-8	5
	P150	Y	051111-50843-5	5
	P180	X	051111-50844-2	5
36" x 60"	P100	Y	051111-50782-7	5
	P220	X	051111-50786-5	5
36" x 75"	60	Y	051111-68399-6	2
	80	Y	051119-55797-8	3
	P100	Y	051119-55798-5	5
	P120	Y	051119-55799-2	5
	P150	Y	051119-55800-5	5
	P180	X	051111-69157-1	5
37" x 60"	80	Y	051119-55805-0	3
	P100	Y	051119-55806-7	5
	P120	Y	051119-55807-4	5
	P150	Y	051119-55808-1	5
	P180	X	051111-69158-8	5
37" x 75"	80	Y	051119-55809-8	3
	P100	Y	051119-55810-4	5
	P120	Y	051119-55811-1	5
	P150	Y	051119-55812-8	5
	P180	X	051111-69159-5	5
	P220	X	051111-68474-0	5
43" x 60"	80	Y	051111-50846-6	3
	P100	Y	051111-50847-3	5
	P120	Y	051111-50848-0	5
	P150	Y	051111-50849-7	5
	P220	X	051111-50851-0	5

Width x Length	Grade	Backing Wt.	UPC Number	Min /Case
50" x 103"	36	YN	051111-69141-0	2
	40	Y	051111-68394-1	2
	50	Y	051111-68403-0	2
	80	Y	051111-68427-6	3
	P100	Y	051111-68981-3	5
	P120	Y	051119-55803-6	5
	P150	Y	051119-55804-3	5
	P180	X	051111-68473-3	5
	P220	X	051111-68477-1	5
	52" x 103"	24	YN	051111-68385-9
36		YN	051111-69142-7	2
60		Y	051111-68408-5	2
80		Y	051111-50834-3	3
P100		Y	051111-50835-0	5
P120		Y	051111-50836-7	5
P150		Y	051111-50837-4	5
P180		X	051111-50838-1	5
P220	X	051111-50839-8	5	

For additional sizes and grades, contact your local 3M Authorized Distributor.

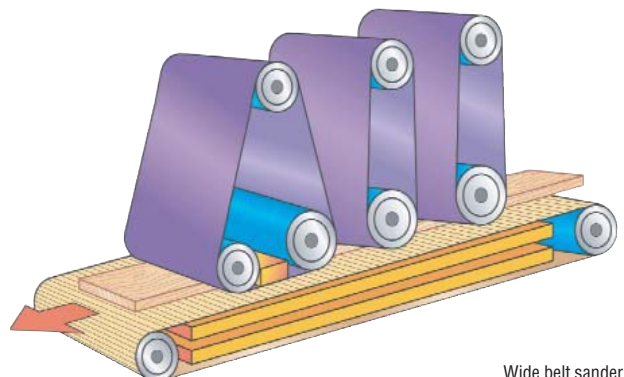

Wide belt sander

\*The Purple color of the abrasive is a trademark of 3M.

## 3M™ Wide Belts – Paper

### High Performance

#### 961UZ (Purple\*)

- 3M™ Cubitron™ Abrasive Grain on a heavy F wt. paper.
- Provides extremely long life and uniform finish
- Cup resistant treatment allows belt to lay flatter
- 3M™ Xodust™ Technology reduces static and airborne dust levels when used with an efficient dust-collection system

Width x Length	Grade	UPC Number	Min /Case
36" x 75"	P100	051111-68954-7	5
	P120	051119-55788-6	5
	P150	051119-55789-3	5
	P180	051119-55790-9	5
	P220	051111-68092-6	5
37" x 75"	P120	051111-50891-6	5
	P150	051111-68072-8	5
	P180	051111-68085-8	5
	P220	051111-68094-0	5
50" x 103"	P120	051119-55793-0	5
	P150	051119-55794-7	5
	P180	051119-55795-4	5
52" x 103"	80	051111-68052-0	3
	P100	051111-68057-5	3
	P120	051111-68062-9	3
	P150	051111-50887-9	5
	P180	051111-50888-6	5
	P220	051111-68099-5	5

For additional sizes and grades, contact your local 3M Authorized Distributor.



#### TECH TIP: Factors Affecting Belt Life

*In the sanding of wood it is wise to be aware of those conditions which may adversely affect abrasive belt life. Here are the major ones:*

- High humidity
- Insufficient dust evacuation
- Too heavy a rate of cut
- Too high a feed-speed
- Metal or other impurities in the wood
- A high percentage of resinous wood material
- Ill-suited or poorly maintained sanding equipment

#### What's so special about Purple\* belts?

Count on 3M Purple products to offer state-of-the-art technology designed to lower your production costs.

This family of woodworking products feature 3M's premier technology: It is the result of extensive research and process development.

Revolutionary performance has made this the flagship of our coated abrasive product line.

\*The Purple color of the abrasive is a trademark of 3M.

## 3M™ Portable Tool Belts

### Cloth – General Use

#### 240D/241D

- Aluminum oxide on a durable X wt. cotton cloth backing
- 240D is an open coat belt that provides good cut with less loading
- 241D is a closed coat belt that provides great finish
- Excellent all-around abrasive belt for everyday use

Width /Length	Grade	UPC Number	Min/Case
3" x 18" 240D	P50	051144-71512-1	5/25
	P80	051144-30639-8	10/50
	P120	051144-71785-9	10/50
	P150	051144-71512-1	5/25
3" x 18" 241D	P36	051144-70969-4	5/25
	P50	051144-33832-0	5/25
	P80	051144-30066-2	10/50
	P120	051144-32517-7	10/50
3" x 21" 240D	P50	051144-27499-4	5/25
	P60	051144-27498-7	10/50
	P80	051144-27497-0	10/50
	P100	051144-27496-3	10/50
	P120	051144-27495-6	10/50
3" x 21" 241D	P36	891040-01422-4	5/40
	P40	891040-01423-1	5/40
	P50	891040-01424-8	5/40
	P60	891040-01425-5	5/40
	P80	891040-01426-2	10/40
	P100	891040-01427-9	10/40
	P120	891040-01428-6	10/40
3" x 24" 240D	P50	051144-27474-1	5/25
	P60	051144-27473-4	10/50
	P80	051144-27472-7	10/50
	P100	051144-27471-0	10/50
	P120	051144-27470-3	10/50
3" x 24" 241D	P36	891040-01429-3	5/40
	P40	891040-01430-9	5/40
	P50	891040-01431-6	5/40
	P60	891040-01432-3	5/40
	P80	891040-01433-0	10/40
	P100	891040-01434-7	10/40
	P120	891040-01435-4	10/40
4" x 24" 240D	P50	051144-27464-2	5/25
	P60	051144-27463-5	10/50
	P80	051144-27462-8	10/50
	P100	051144-27461-1	10/50
	P120	051144-27460-4	10/50
4" x 24" 241D	P36	891040-01436-1	5/40
	P40	891040-01437-8	5/40
	P50	891040-01438-5	5/40
	P60	891040-01439-2	5/40
	P80	891040-01440-8	10/40
	P100	891040-01441-5	10/40
	P120	891040-01442-2	10/40



## 3M™ Portable Tool Belts

### Cloth – High Performance

#### 761D (Purple\*)

- 3M™ Cubitron™ Abrasive Grain and premium aluminum oxide blended minerals on a heavy Y wt. cloth backing
- Film splice allows for the belt to be run bi-directional
- Purple\* color indicates leading edge technology...designed to provide you with the lowest possible manufacturing costs

Width x Length	Grade	UPC Number	Min /Case
3" x 18"	P50	051144-81393-3	5/25
	P60	051144-81394-0	5/25
	P80	051144-81395-7	5/25
	P100	051144-81396-4	5/25
	P120	051144-81397-1	5/25
	P150	051144-81398-8	5/25
3" x 21"	P50	051144-81399-5	5/25
	P60	051144-81400-8	5/25
	P80	051144-81401-5	5/25
	P100	051144-81402-2	5/25
	P120	051144-81403-9	5/25
	P150	051144-81404-6	5/25
3" x 24"	P50	051144-81410-7	5/25
	P60	051144-81411-4	5/25
	P80	051144-81412-1	5/25
	P100	051144-81413-8	5/25
	P120	051144-81414-5	5/25
	P150	051144-81415-2	5/25
4" x 24"	P50	051144-81429-9	5/25
	P60	051144-81430-5	5/25
	P80	051144-81431-2	5/25
	P100	051144-81432-9	5/25
	P120	051144-81433-6	5/25
	P150	051144-81434-3	5/25

For additional sizes and grades, contact your local 3M Authorized Distributor.

\*The Purple color of the abrasive is a trademark of 3M.



# 3M™ Edge Sanding Belts

## Cloth – General Use

### 240D/241D

- Aluminum oxide on a durable X wt. cotton cloth backing
- 240D is an open coat belt that provides good cut with less loading
- 241D is a closed coat belt that provides great finish
- Excellent all-around abrasive belt for everyday use

Width x Length	Grade	UPC Number	Min /Case
2" x 132" 241D	P60	051144-31775-2	25/50
	P80	051144-25840-6	25/50
	P400	051111-66977-8	25/50
4" x 60" 241D	P36	051144-26371-4	10/50
	P60	051144-26370-7	25/50
	P80	051144-26535-0	25/50
4" x 84" 241D	P120	051111-68756-7	25/50
4" x 132" 240D	P80	051144-32474-3	25/50
	P100	051144-70446-0	25/50
	P120	051144-11393-4	25/50
4" x 132" 241D	P36	051144-25661-7	5/25
	P50	051144-25655-6	10/50
	P60	051144-33647-0	25/25
	P80	051144-25642-6	25/25
	P120	051144-25635-8	25/50
6" x 48" 240D	P50	051144-27426-0	10/20
	P60	051144-27425-3	10/20
	P80	051144-27423-9	10/20
	P100	051144-27422-2	10/20
	P120	051144-27421-5	10/20

Width x Length	Grade	UPC Number	Min /Case
6" x 48" 241D	P24	051144-26533-6	10/20
	P36	891040-01454-5	10/20
	P40	891040-01455-2	10/20
	P50	891040-01456-9	10/20
	P60	891040-01457-6	10/20
	P80	891040-10454-3	20
	P120	891040-10456-7	20
	P150	051144-26517-6	20
	P180	051144-26515-2	20
	P240	051144-26513-8	20
	P320	051144-26512-1	20
6" x 60" 241D	P60	051144-26358-5	20
	P80	051144-26357-8	20
6" x 68" 240D	P100	051144-76507-2	20
6" x 108" 240D	P80	051144-11035-3	20
6" x 108" 241D	P80	051144-26025-6	20
	P80	051144-11036-0	20
6" x 132" 240D	P100	051144-83902-5	20
	P100	051144-83902-5	20
6" x 132" 241D	P36	051144-82150-1	5/10
	P100	051144-25599-3	20

*For additional sizes and grades, contact your local 3M Authorized Distributor.*

### TECH TIP: Selecting the Grade

- The purpose of the roughing grade is to remove stock and come to a uniform dimension, leaving just enough material to develop the final finish.
- The purpose of the finishing grade or grades is to remove all previous grade scratches.
- There should be no more than a two-grade jump between roughing and the next grade size – i.e. 36-50, 40-60, 80-120.

## 3M™ Edge Sanding Belts

### Cloth – High Performance



#### 970DZ

- Premium Purple\* belt featuring 3M™ Cubitron™ Abrasive Grain on a heavy cloth backing, open coat
- Provides extremely long life and uniform finish
- Performs well on all wood species
- Reduced burning when performing “end-grain” sanding applications
- 3M™ Xodust™ Technology reduces static and airborne dust levels when used with an efficient dust-collection system

Width x Length	Grade	Backing Wt.	UPC Number	Min /Case
4" x 132"	36	YN	051111-50800-8	5/25
	60	Y	051111-50803-9	5/25
	80	Y	051111-50804-6	5/25
	P100	Y	051111-50805-3	5/25
	P120	Y	051111-50806-0	5/25
	P150	Y	051111-68461-0	5/25
	P220	X	051111-50809-1	5/25
6" x 48"	36	YN	051111-50810-7	10
	50	Y	051111-50812-1	10
	60	Y	051111-50813-8	10
	P100	Y	051111-50815-2	10
	P120	Y	051111-50816-9	10
	6" x 132"	60	Y	051111-50827-5
80		Y	051111-50828-2	10
P100		Y	051111-50829-9	10
P120		Y	051111-50830-5	10
P150		Y	051111-50831-2	10

For additional sizes and grades, contact your local 3M Authorized Distributor.

\*The Purple color of the abrasive is a trademark of 3M.

## Scotch-Brite™ Radial Bristle Discs



#### Scotch-Brite Radial Bristle Discs

- Curved thin bristles sweep into grooves, crevices, carvings, inset corners and other tricky-to-finish areas
- Use for light sanding and polishing, vein sanding, defuzzing, denibbing and sanding raised grain between sealer coats
- Slow-wearing resin construction
- Non loading
- Safe handling and operation-no flying wires
- Use on die grinders (3200 RPM or less) or on electric or pneumatic drills with operating speeds of 1500–3200 RPM

Size	Grade	Color	UPC Number	Box /Case
3" x 3/8"	80	yellow	048011-30126-6	40/80
	120	white	048011-30127-3	40/80
	220	red	048011-30128-0	40/80
	400	blue	048011-30129-7	40/80

## 3M™ Mandrel 990

Brush Size	UPC Number	Min /Case
1/8"-1/2" wide	048011-15012-3	1



Brush Assembly

# Random Orbital Sanding

## Unfinished Wood

### Starting Point Recommendations

- Step 1.** Initial sanding should level the work piece if not previously sanded by a wide belt machine. For quick leveling and aggressive, coarse sanding operations, use a disc in grade 80 or 100.
- Step 2.** Intermediate sanding should use a disc in grade 120 or 150, depending on the abrasive grade used on the previous step. It is recommended to skip no more than one grade between sanding steps.
- Step 3.** Recommend finishing using either grade 180 or 220. The wood species, machine parameters and finish used will determine the appropriate abrasive grade.

Work Piece Starting Point	Hardwood			Softwood		
	Step 1	Step 2	Step 3	Step 1	Step 2	Step 3
<b>Heavy Sanding</b> required  has a 60 or 80 grit wide belt finish or an 80 grit ROS finish	734U P100	734U P150	255L P220 415U 180*	734U P100	734U P120	734U P180 415U 150*
<b>Intermediate Sanding</b> required  has a 100 or 120 grit wide belt finish or a 120 grit ROS finish	734U P150	255L P220 415U 180*		734U P180 415U 150*		
<b>Light Sanding</b> required  has a 150 – 180 grit wide belt finish or a 150 grit ROS finish	255L P220 415U 180*			734U P180 415U 180*		

\* 415U is a final step option when finish is the most critical criteria.

When a finer finish is required for very hard woods such as hard maple or hickory, it might be necessary to use a disc that is one grade finer for the final step.

### YOUR 3M SOLUTIONS HOTLINES:

3M can provide additional products and accessories to meet your needs.

Please contact us in any of the following ways that you prefer:

- 3M distributor or 3M sales representative in your area
- 3M Customer Response Center **1-866-279-1235**
- 3M Custom Woodworking and Cabinet Shop Website **[www.3M.com/woodworking-catalog](http://www.3M.com/woodworking-catalog)**

## Random Orbital Sanding

*3M™ Stikit™ Discs, 3M™ Hookit™ Discs and 3M™ Hookit™ II Discs*



### 734U

Use 734U when you need a long lasting, durable paper product. 734U is made with 3M™ Cubitron™ Abrasive Grain on a C wt. paper backing. The C wt. paper backing provides tear resistance and longer life versus lighter A wt. & B wt. papers. It also features a load resistant coating. 734U is an exceptionally long lasting disc that offers a good finish.



### 255L

255L provides a consistent, high quality finish, while offering great life. The disc is made with a high-grade aluminum-oxide mineral on a polyester film backing. The film backing provides excellent tear resistance versus paper discs. Combined with a load resistant coating, the film disc delivers a fast long-lasting cut rate.



### 415U

415U features a silicon-carbide mineral on an A wt. paper backing to provide the best finish possible. An open coat with a load resistant coating delivers a consistent cut rate over the life of the disc.

### Random Orbital (Dual Action or D/A) Sanding

*Large areas such as tops and end panels are commonly sanded with random orbital disc sanders. Cross grain scratches are removed with this process. A precautionary measure to help prevent swirl marks is to place the sander flat on the wood surface before applying power and maintaining flatness during use.*

## 3M™ Stikit™ Systems



### Stikit™ Systems: Versatile, Convenient and Efficient...A New Level of Productivity

3M manufactures a complete line of Stikit coated abrasives to handle your range of sanding and finishing needs. These are high quality, coated abrasive products with a pressure sensitive adhesive coating on the backside to allow easy application and removal.

### Stikit™ Disc Rolls For Dust Evacuation Sanding

3M manufactures a broad assortment of Stikit discs for use with the dust evacuation sanders that are becoming increasingly popular. The benefits of using this type of sander are: a cleaner environment for the operator; less cleanup of the workpiece before the next sanding or finishing step. Since the sanding dust is removed from the workpiece, less loading on the abrasive surface, which translates into longer disc life, fewer disc changes and a lower abrasive cost.

## 3M™ Stikit™ Disc – Cloth

### General Use

#### 300D

- Aluminum oxide – J wt. Cloth
- Excellent for all types of wood sanding.
- Flexible cloth backing provides excellent durability
- Open coat resists loading
- Individual discs with liners



Diameter	Grade	UPC Number	Min /Case
5" no dust hole	80	051111-50450-5	50/250
	P100	051111-50451-2	50/250
	P120	051111-50452-9	50/250
	P150	051111-50453-6	50/250
	P180	051111-50454-3	50/250
	P220	051111-50455-0	50/250
6" no dust hole	80	051111-50459-8	50/250
	P100	051111-50460-4	50/250
	P120	051111-50461-1	50/250
	P150	051111-50462-8	50/250
	P180	051111-50463-5	50/250
	P220	051111-50464-2	50/250

#### **TECH TIP: Start on... Stop off...**

*A simple rule of thumb to prevent unnecessary swirl marks on the work surface. Start the sander on the work surface, stop the tool as it is removed from the work surface.*

*For best results, operate tool at 90 PSI air pressure.*

## 3M™ Stikit™ Disc Roll – Paper

### General Use



### 316U

- Aluminum oxide – A wt. Paper
- Discs for paint, primer, wood and fiberglass
- Load resistant coating
- Convenient disc roll form, 100 discs per roll

Width x Diameter	Grade	UPC	Min /Case
5" no dust hole	80	051131-01237-0	1/6
	P100	051131-01236-3	1/6
	P120	051131-01235-6	1/6
	P150	051131-01234-9	1/6
	P180	051131-01233-2	1/6
	P220	051131-01232-5	1/6
	P240	051131-01231-8	1/6
	P320	051131-01229-5	1/6
6" no dust hole	80	051131-01248-6	1/6
	P100	051131-01247-9	1/6
	P120	051131-01246-2	1/6
	P150	051131-01245-5	1/6
	P180	051131-01244-8	1/6
	P220	051131-01243-1	1/6
	P240	051131-01231-8	1/6
	P320	051131-01240-0	1/6

### 415U/415N

- Silicon carbide – A wt. Paper
- General purpose discs for whitewood and sealer sanding
- Load resistant coating
- Unique construction provides excellent finish
- Convenient disc roll form, 125 or 250 discs per roll

Diameter	Grade	UPC Number	Min /Case	Discs Per Roll	
5"	80	051144-77223-0	1/8	125	
	no dust hole	100	051144-77227-8	1/8	125
	415U/415N	120	051144-77230-8	1/8	125
	150	051144-77234-6	1/4	250	
	180	051144-77237-7	1/4	250	
	220	051144-77241-4	1/4	250	
	240	051144-77244-5	1/4	250	
	280	051144-77247-6	1/4	250	
320	051144-77249-0	1/4	250		
5"	80	051144-77224-7	1/8	125	
	5 dust holes	100	051144-77228-5	1/8	125
	415U/415N	120	051144-77231-5	1/8	125
	150	051144-77235-3	1/4	250	
	180	051144-77238-4	1/4	250	
	220	051144-77242-1	1/4	250	
	240	051144-77245-2	1/4	250	
	6"	80	051144-77225-4	1/8	125
no dust holes		100	051144-77229-2	1/8	125
415U		120	051144-77232-2	1/8	125
150		051144-77236-0	1/4	250	
180		051144-77239-1	1/4	250	
220		051144-77243-8	1/4	250	
6"	80	051144-77226-1	1/8	125	
	6 dust holes	120	051144-77233-9	1/8	125
	415U	180	051144-77240-7	1/4	250

# 3M™ Stikit™ Disc Roll – Paper

## Engineered

### 216U

- Aluminum oxide – A wt. paper
- Load resistant coating
- Convenient disc roll form, 125 or 175 discs/roll

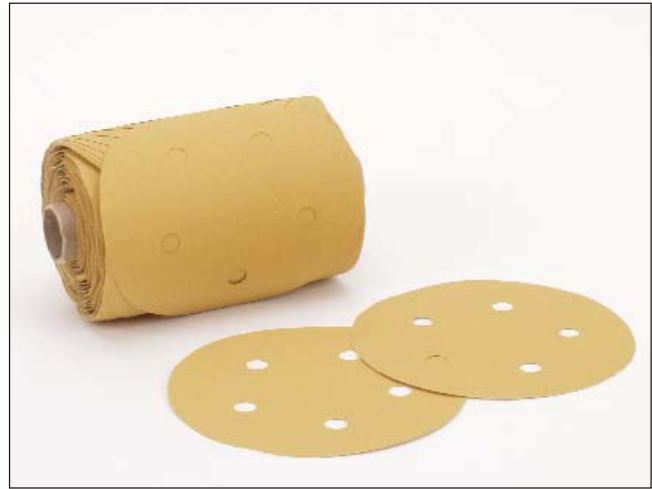

Diameter	Grade	UPC Number	Discs /Roll	Min /Case	
5" no dust hole	P80	051111-49909-2	125	1/10	
	P100	051111-49910-8	125	1/10	
	P120	051111-49911-5	125	1/10	
	P150	051111-49912-2	175	1/6	
	P180	051111-49913-9	175	1/6	
	P220	051144-01423-1	175	1/6	
	P240	051144-01422-4	175	1/6	
	P280	051144-01421-7	175	1/6	
	P320	051144-01420-0	175	1/6	
	P360	051131-01418-3	175	1/6	
	P400	051131-01419-0	175	1/6	
	6" no dust hole	P80	051111-49914-6	125	1/10
		P100	051111-49915-3	125	1/10
P120		051111-49916-0	125	1/10	
P150		051111-49917-7	175	1/6	
P180		051111-49918-4	175	1/6	
P220		051144-01438-5	175	1/6	
P240		051144-01437-8	175	1/6	
P280		051144-01436-1	175	1/6	
P320		051144-96434-5	175	1/6	
P360		051131-01433-6	175	1/6	
P500		051131-01432-9	175	1/6	

Diameter	Grade	UPC Number	Discs /Roll	Min /Case
5" 5 dust holes	P80	051131-01628-6	125	1/10
	P100	051131-01627-9	125	1/10
	P120	051131-01626-2	125	1/10
	P150	051131-01625-5	175	1/6
	P180	051131-01624-8	175	1/6
	P220	051131-01623-1	175	1/6
	P240	051131-01622-4	175	1/6
	P280	051131-01621-7	175	1/6
	P320	051131-01620-0	175	1/6
	P400	051131-01619-4	175	1/6
6" 6 dust holes	P80	051131-01643-9	125	1/10
	P100	051131-01642-2	125	1/10
	P120	051131-01641-5	125	1/10
	P150	051131-01640-8	175	1/6
	P180	051131-01639-2	175	1/6
	P240	051131-01637-8	175	1/6
	P320	051131-01635-4	175	1/6

### 👉 YOUR 3M SOLUTIONS HOTLINES:

3M can provide additional products and accessories to meet your needs.

Please contact us in any of the following ways that you prefer:

- 3M distributor or 3M sales representative in your area
- 3M Customer Response Center **1-866-279-1235**
- 3M Custom Woodworking and Cabinet Shop Website [www.3M.com/woodworking-catalog](http://www.3M.com/woodworking-catalog)

## 3M™ Stikit™ Disc Roll – Paper

*Engineered* continued

### 236U

- Aluminum oxide – C wt. paper – open coat “Gold Color”
- Durable, tear resistant backing
- Load resistant coating
- Convenient disc roll form, 100 discs per roll



Diameter	Grade	UPC Number	Min /Case
5" no dust hole	P80	051144-86488-1	1/4
	P100	051144-86489-8	1/4
	P120	051144-86490-4	1/4
	P150	051144-86491-1	1/4
	P180	051144-86492-8	1/4
	P220	051144-86493-5	1/4
	P240	051144-86494-2	1/4
	P320	051144-86495-9	1/4
	P400	051144-86496-6	1/4
	P500	051144-86497-3	1/4
6" no dust hole	P80	051144-86468-3	1/4
	P100	051144-86469-0	1/4
	P120	051144-86470-6	1/4
	P150	051144-86471-3	1/4
	P180	051144-86472-0	1/4
	P220	051144-86473-7	1/4
	P240	051144-86474-4	1/4
	P320	051144-86475-1	1/4
	P400	051144-86476-8	1/4
	P500	051144-86477-5	1/4
5" 5 dust holes	P80	051144-86498-0	1/4
	P100	051144-86499-7	1/4
	P120	051144-88700-2	1/4
	P150	051144-88701-9	1/4
	P180	051144-88702-6	1/4
	P220	051144-88703-3	1/4
	P240	051144-88704-0	1/4
	P320	051144-88705-7	1/4
	P400	051144-88706-4	1/4
	P500	051144-88707-1	1/4

Diameter	Grade	UPC Number	Min /Case
6" 6 dust holes	P80	051144-86478-2	1/4
	P100	051144-86479-9	1/4
	P120	051144-86480-5	1/4
	P150	051144-86481-2	1/4
	P180	051144-86482-9	1/4
	P220	051144-86483-6	1/4
	P240	051144-86484-3	1/4
	P320	051144-86485-0	1/4
P400	051144-86486-7	1/4	

### TECH TIP: Stikit Disc Finish Life Characteristics

*Best finish*  
(comparing grade 180 on wood, least amount of swirl marks)

*Longest life*  
(as it relates to the mineral dulling, comparing grade 180)

↑ 415U  
316U  
214U  
216U  
236U  
255L  
734U  
300D  
900DZ  
↓

*Coarsest finish*

↑ 900DZ  
734U  
300D  
255L  
236U  
216U  
214U  
316U  
415U  
↓

*Least life*



## 3M™ Stikit™ Disc – Film

*Engineered*



### 255L

- Aluminum oxide – strong, flexible, tear resistant film backing – “Gold Film”
- Provides sharp cut, durability, outstanding finish
- Long, heat-resistant life
- Load resistant coating
- Convenient disc roll form, 125 discs per roll

Diameter	Grade	UPC Number	Min /Case
5" no dust hole	P80	051144-82471-7	1/4
	P100	051144-82470-0	1/4
	P120	051144-82469-4	1/4
	P150	051144-82468-7	1/4
	P180	051144-82467-0	1/4
	P220	051144-82466-3	1/4
	P240	051144-82465-6	1/4
	P280	051144-82464-9	1/4
	P320	051144-82463-2	1/4
6" no dust hole	P80	051131-01363-6	1/4
	P100	051131-01362-9	1/4
	P120	051131-01361-2	1/4
	P150	051131-01360-5	1/4
	P180	051131-01359-9	1/4
	P220	051131-01358-2	1/4
	P240	051131-01357-5	1/4
	P280	051131-01356-8	1/4

## 3M™ Stikit™ Disc – Cloth

*High Performance*



### 900DZ

- Premium Purple\* disc – durable, long lasting 3M™ Cubitron™ Abrasive Grain
- J wt. cloth – open coat
- Flexible, tear resistant cloth
- 3M™ Xodust™ Technology reduces static and airborne dust levels when coupled with an efficient dust-collection system
- Individual discs with liner

Width x Diameter	Grade	UPC Number	Min /Case
5" no dust hole	80	051111-49639-8	50/250
	P100	051111-49640-4	50/250
	P120	051111-49641-1	50/250
	P150	051111-49643-5	50/250
	P180	051111-49642-8	50/250
	P220	051111-49644-2	50/250

\*The Purple color of the abrasive is a trademark of 3M.

## 3M™ Stikit™ Disc – Paper

### High Performance

#### 734U/334U

(734U 3M™ Cubitron™ Mineral blend available in P80 – P180 and 334U Aluminum Oxide available in P220)

- C wt. paper
- Sharp-cutting and durable
- Ideal for wood, soft metals, fiberglass and solid surface



Diameter	Grade	UPC Number	Discs /Roll	Min /Case
5" no dust hole 734U	P80	051131-00309-5	75	1/4
	P100	051131-00308-8	75	1/4
	P120	051131-00307-1	75	1/4
	P150	051131-00306-4	75	1/4
	P180	051131-00305-7	75	1/4
5" no dust hole 334U	P220	051131-00304-0	75	1/4

Diameter	Grade	UPC Number	Discs /Roll	Min /Case
6" no dust hole 734U	P80	051131-00333-0	75	1/4
	P100	051131-00332-3	75	1/4
	P120	051131-00331-6	75	1/4
	P150	051131-00330-9	75	1/4
	P180	051131-00329-3	75	1/4
6" no dust hole 334U	P220	051131-00328-6	75	1/4

#### SAFETY TIPS:

To prevent injury, use eye, face and body protection at all times while operating power tools, and in areas where power tools are being operated. Follow safety procedures posted in work area.

- Always disconnect power before changing abrasives or making machine adjustments and repair.
- Always use recommended air hose, fittings and couplers and inspect them for wear and damage and replace when necessary.
- Do not use damaged, bent or severely worn accessories.
- Electric Machines – Make sure proper electrical codes are followed, including safe wiring and proper grounding.

#### YOUR 3M SOLUTIONS HOTLINES:

3M can provide additional products and accessories to meet your needs.

Please contact us in any of the following ways that you prefer:

- 3M distributor or 3M sales representative in your area
- 3M Customer Response Center **1-866-279-1235**
- 3M Custom Woodworking and Cabinet Shop Website [www.3M.com/woodworking-catalog](http://www.3M.com/woodworking-catalog)

# Selecting the right 3M™ Stikit™ Backup Pad

## Three Basic Pads – Standard, Low Profile, and Low Profile Finishing

### Standard – *Most Aggressive*

- Offers the most aggressive sanding of the three pads
- Can be used on the edge or flat sanding
- 45 degree taper edge for good disc support with tip flexibility to use on profile edges
- Available in three face colors:
  - Blue** vinyl face pad provides good adhesion for easy removal and use in most operations
  - Red** nylon face pad provides a high adhesion surface for use in dusty work environments
  - Silver** cloth face pad provides a low adhesion surface for use in high heat, PSA transfer
- Available in 5, 6, and 8" diameters
- Available in no-hole, 5-hole, 6-hole, and 8-hole dust collection systems
- Also available as 3M™ Hookit™ and Hookit™ II Backup Pads

### Low Profile – *Mid Range*

- Offers a mid-range sanding when compared to a Standard and Low Profile Finishing Pads
- Can be used for sanding edges, but recommend more for flat sanding operations
- 75 degree taper edge for good flat sanding into the sharpest of edges
- Available in two face colors:
  - Blue** vinyl face pad provides good adhesion for easy removal and use in most operations
  - Silver** cloth face pad provides a low adhesion surface for use in high heat, PSA transfer
- Available in 5, 6, and 8" diameters
- Available in no-hole, 5-hole, 6-hole, and 8-hole dust collection systems
- Also available as 3M™ Hookit™ and Hookit™ II Backup Pads

### Low Profile Finishing – *Best Finishing*

- Offers the best finishing, least sanding of the three pads
- Can be used for sanding edges, but recommend sanding only on flat surfaces
- 75 degree taper edge for good flat sanding into the sharpest of edges
- Available in one face color:
  - Brown** vinyl face pad provides good adhesion for easy removal and use in most operations
- Available in 5, 6, and 8" diameters
- Available in no-hole, 5-hole, 6-hole, and 8-hole dust collection systems
- Also available as 3M™ Hookit™ and Hookit™ II Backup Pads

# 3M™ Stikit™ Accessories

## No Dust Holes



### Stikit™ Disc Pads

- Use with Stikit Discs
- Good adhesion, easy removal
- Durable plastic hub
- Conformable foam body

Size	Thread	UPC Number	Min /Case
5" x 3/4" Blue Face 10000 RPM 12000 OPM	5/16-24 EXT	051144-05575-3	1/10
			
5" x 3/4" Red Face 12000 RPM 12000 OPM	5/16-24 EXT	051144-81821-1	1/10
			
5" x 3/4" 6" x 3/4" Silver Face 10000 RPM 12000 OPM	5/16-24 EXT 5/16-24 EXT	051144-45215-6 051144-45216-3	1/10 1/10
			

### Stikit™ Low Profile Disc Pads

- Low profile for improved accessibility
- Less conformability

Size	Thread	UPC Number	Min /Case
5" x 3/8" 6" x 3/8" Blue 12000 RPM 12000 OPM	5/16-24 EXT 5/16-24 EXT	051131-05555-1 051131-05556-8	1/10 1/10
			
5" x 3/8" Silver 10000 RPM 12000 OPM	5/16-24 EXT	051144-85104-1	10
			

### Stikit™ Low Profile Finishing Pads

- Soft foam body
- For fine finish and outstanding conformability
- Use on random orbital sanders only



#### TECH TIP:

The color of the face side on Stikit back up pads will have a direct impact upon the performance of that pad.

**SILVER:** Slightly lower than standard adhesion, easiest removal characteristics.  
Use: Lightweight papers and very fine grades.

**BLUE:** Standard level of adhesion, standard removal characteristics.  
Use: General Purpose.

**RED:** Improved level of adhesion, decreased removal characteristics.  
Use: Cloth and Heavy Weight Papers in coarse grades.

Size	Thread	UPC Number	Min /Case
5" x 11/16" Brown 12000 RPM 12000 OPM	5/16-24 EXT	051131-05545-2	1/10
6" x 11/16" Brown 12000 RPM 12000 OPM	5/16-24 EXT	051131-05546-9	1/10

# 3M™ Stikit™ Accessories

## Dust Free Pads

### Stikit™ Dust-Free Disc Pads

- Use with pre-punched discs for dust evacuation
- Lightweight, durable and well-balanced

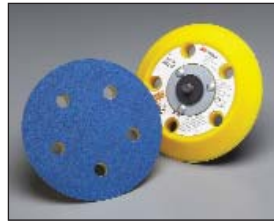

Size	Thread	UPC Number	Min /Case
5" x 3/4"	5/16-24 EXT	051144-45217-0	1/10
6" x 3/4"	5/16-24 EXT	051144-45218-7	1/10
Blue Face 10000 RPM 12000 OPM			

### Stikit™ Dust-Free Low Profile Finishing Disc Pads

- For 5" Stikit dust-free discs
- Works on most standard dust-free sanders
- Use on random orbital sanders only



Size	Thread	UPC Number	Min /Case
5" x 11/16" Brown	5/16-24 EXT	051131-05645-9	1/10
12000 RPM 12000 OPM			

### Stikit™ Dust-Free Low Profile Disc Pads

- For 5" and 6" Stikit dust-free discs
- Use with standard and dust-free Stikit discs
- Works on most standard dust-free sanders



Size	Thread	UPC Number	Min /Case
5" x 3/8" Blue Face	5/16-24 EXT	051131-05655-8	10
12000 RPM 12000 OPM			
6" x 3/8" Blue Face	5/16-24 EXT	051131-05656-5	10
12000 RPM 12000 OPM			

### TECH TIP: For Peak Performance...

*...avoid tipping the tool/pad when operating. Best results will be achieved when keeping the pad as flat on the work surface as possible. Remember, let the tool/abrasive do the work!*

### YOUR 3M SOLUTIONS HOTLINES:



*3M can provide additional products and accessories to meet your needs. Please contact us in any of the following ways that you prefer:*

- 3M distributor or 3M sales representative in your area
- 3M Customer Response Center **1-866-279-1235**
- 3M Custom Woodworking and Cabinet Shop Website [www.3M.com/woodworking-catalog](http://www.3M.com/woodworking-catalog)

# 3M™ Stikit™ Accessories

*continued*

## Stikit™ Manufacturer Specific Disc Pads

Size/Thread	UPC Number	Min /Case
5" x 1/2" Porter-Cable Models 333 & 334 12000 RPM 12000 OPM	3 Bolt Holes	051111-50206-8 5
		
5" x 1/2" DeWALT® DW421, 422 & 423 12000 RPM 12000 OPM	3 Bolt Holes	051111-50207-5 5
		
DeWALT is a registered trademark of DeWALT Industrial Tool Company		
5" x 1/2" Bosch Model #3107 DWS	3 Bolt Holes	051111-50208-2 5
		

## Stikit™ Disc Roll Dispensers





- Metal dispensers for Stikit disc rolls
- This dispenser holds two disc rolls



Size	UPC Number	Min /Case
5" or 6" dia. 1" core double	051144-05450-3	1

## Stikit™ Disc Hand Pads

A unique method for hand sanding of wood and metal is possible with Stikit discs and the Stikit disc hand pads. Constructed of neoprene rubber with a nylon cloth face and an elastic handband on the back. Designed to securely hold the disc but allows easy removal.

Size	Description	UPC Number	Min /Case
5" x 1"	Rubber Face	051144-11063-6	1/10
			
5"	Molded	051144-88742-2	10
			
5" x 1/8" 6" x 1/8"	Blue Face	051144-45188-3 051144-45198-2	20/120 20/120
			
5" x 1/4" 6" x 1/4"	Blue Face	051144-45189-0 051131-05591-9	20/120 20/120
			
5" x 1" 6" x 1"	Blue Face	051144-84229-2 051131-05589-6	10 10
			

# 3M™ Stikit™ Sheet Roll System

## Stikit™ Sheet Rolls

Stikit sheet rolls are one long continuous strip of abrasive with the adhesive already applied. Operators use ALL the abrasive taken from the roll...with conventional methods, a great deal of the abrasive is wasted since it must be wrapped around a block and is not used for sanding. Stikit abrasives, used in conjunction with a sanding block, also eliminate many of the problems associated with hand sanding, such as splinters and finger marks on the wood surface from uneven sanding pressure. And Stikit sheet rolls, unlike dry sheets, do not end up on the floor of the plant where they are apt to be swept up at the end of the day, causing unnecessary waste.



### 216U

P-graded aluminum oxide mineral coated on a durable A-weight paper backing with a load resistant coating. Excellent for sanding varnish, sealers and light-colored substrates and whitewood. Grades P80-P800

### 415U

Silicon carbide mineral coated on a durable A-weight paper backing with a load resistant coating. This product is used for hand or light portable tool sanding of wood, sealer, varnish and lacquer. Grade range 80-220.

Width x Length	Grade	UPC Number	Min /Case
2 3/4" x 25 yd <b>216U</b>	P80	051131-02599-8	1/10
2 3/4" x 30 yd <b>216U</b>	P100	051131-02598-1	1/10
	P120	051131-02597-4	1/10
2 3/4" x 45 yd <b>216U</b>	P150	051131-02596-7	1/10
	P180	051131-02595-0	1/10
	P220	051131-02594-3	1/10
	P240	051131-02593-6	1/10
	P320	051131-02591-2	1/10
	P400	051131-02590-5	1/10
2 3/4" x 25 yd <b>415U</b>	80	051131-02565-3	1/10
2 3/4" x 35 yd <b>415U</b>	100	051144-02563-3	1/10
	120	051144-02562-6	1/10

### 415N

Silicon carbide mineral coated on a durable A-weight paper backing with a load resistant coating for whitewood and sealer sanding. Grade range 240-320.

Width x Length	Grade	UPC Number	Min /Case
2 3/4" x 50 yd <b>415U</b>	150	051144-02561-9	1/10
	180	051144-02560-2	1/10
	220	051144-02559-6	1/10
2 3/4" x 50 yd <b>415N</b>	240	051144-02558-9	1/10
	320	051144-02556-5	1/10
4 1/2" x 20 yd <b>216U</b>	P80	051131-02698-8	1/6
	P100	051131-02697-1	1/6
	P120	051131-02696-4	1/6
4 1/2" x 25 yd <b>216U</b>	P150	051131-02695-7	1/6
	P180	051131-02694-0	1/6
	P220	051131-02693-3	1/6
	P320	051131-02691-9	1/6
	P400	051131-02689-6	1/6
4 1/2" x 10 yd <b>415U</b>	80	051115-00395-0	1/10
	100	051115-00396-7	1/10
	120	051115-00397-4	1/10
	150	051115-00643-2	1/10
	180	051115-00398-1	1/10
	220	051115-00399-8	1/10
4 1/2" x 10 yd <b>415N</b>	320	051144-83004-6	1/10

### 👉 YOUR 3M SOLUTIONS HOTLINES:

3M can provide additional products and accessories to meet your needs. Please contact us in any of the following ways that you prefer:

- 3M distributor or 3M sales representative in your area
- 3M Customer Response Center **1-866-279-1235**
- 3M Custom Woodworking and Cabinet Shop Website [www.3M.com/woodworking-catalog](http://www.3M.com/woodworking-catalog)

## 3M™ Stikit™ Sheet Rolls

### Accessories

#### Stikit™ Sheet Roll Dispensers

- Portable, sturdy unit holds two sheet-rolls
- Keeps abrasive flat and protects adhesive backing



Size	UPC Number	Min /Case
2 3/4" for 2 3/4" wide rolls	051144-05452-7	1

#### Stikit™ Hand Blocks

- Sturdy, durable high strength
- Good adhesion for Stikit Sheet-Rolls and Stikit Sheets



Size	UPC Number	Min /Case
2 3/4" x 5" hard	051144-05440-4	1/10
2 3/4" x 5" soft	051144-05442-8	1/10

#### 3M™ Stikit™ Sanding Blocks

Sanding blocks are made of a tough plastic for long life and durability. Sand into corners with the flat end. Sand into curved or contoured areas with the rounded end. The cushioned back-up pad is durable and holds the abrasive firmly in place. Discover their versatility in top coat sanding, sealer and whitewood sanding, paint repair areas and more.

Size	UPC Number	Min /Case
2 1/2" wide	051144-45203-3	1/6
3 1/4" wide	051144-45204-0	1/6

## 3M™ Stikit™ Refill Roll System



#### Stikit™ Refill Roll System

The Stikit refill roll system is designed for your comfort and utility. The blocks are made of tough plastic for long life and durability. They allow you to sand into corners with the flat end and into curved or contoured areas with the rounded end. When the abrasive on the surface is used up, simply peel back the used portion, and pull down on the roll end to expose fresh abrasive. The abrasive used is silicon carbide coated on an A wt. paper backing with a load resistant coating.

#### 415U

Width x Length	Grade	UPC Number	Min/Case
2 1/2" x 45"	80	051144-14475-4	10/50
2 1/2" x 55"	100	051144-16287-1	10/50
2 1/2" x 70"	120	051144-16286-4	10/50
2 1/2" x 85"	150	051144-16285-7	10/50
2 1/2" x 85"	180	051144-16284-0	10/50
2 1/2" x 95"	220	051144-16283-3	10/50
3 1/4" x 45"	80	051144-14476-1	10/50
3 1/4" x 55"	100	051144-16295-6	10/50
3 1/4" x 70"	120	051144-16294-9	10/50
3 1/4" x 85"	150	051144-16293-2	10/50
3 1/4" x 85"	180	051144-16292-5	10/50
3 1/4" x 95"	220	051144-16291-8	10/50

#### 415N

Width x Length	Grade	UPC Number	Min/Case
2 1/2" x 100"	240	051144-16282-6	10/50
2 1/2" x 115"	280	051144-16281-9	10/50
2 1/2" x 125"	320	051144-16280-2	10/50
3 1/4" x 100"	240	051144-16290-1	10/50
3 1/4" x 115"	280	051144-16289-5	10/50
3 1/4" x 125"	320	051144-16288-8	10/50



# 3M™ Hookit™ Systems

## 3M™ Hookit™ Abrasives

3M Hookit abrasive discs are attached using a conventional hook and loop system.

- Easy to change and reuse the disc
- Discs attach firmly to the backup pads
- Clean removal from the backup pad

## Hookit™ Discs - Film

### Engineered

#### Hookit™ Gold Film Disc 255L

- Aluminum oxide – strong, flexible, tear resistant film backing
- “Gold Color” film backing provides sharp cut, durability, outstanding finish
- Load resistant coating
- Longer life



Diameter	Grade	UPC Number	Min/Case
5" no dust hole	P80	051131-00967-7	75/300
	P100	051131-00966-0	100/400
	P120	051131-00965-3	100/400
	P150	051131-00964-6	100/400
	P180	051131-00963-9	100/400
	P220	051131-00962-2	100/400
5" 5 dust holes	P320	051131-00959-2	100/400
	P80	051131-01067-3	75/300
	P100	051131-01066-6	100/300
	P120	051131-01065-9	100/400
	P150	051131-01064-2	100/400
	P180	051131-01063-5	100/400
6" no dust hole	P220	051131-01062-8	100/400
	P320	051131-01059-8	100/400
	P80	051111-69637-8	75/300
	P100	051111-69638-5	100/400
	P120	051111-69639-2	100/400
	P150	051111-69640-8	100/400
6" 6 dust holes	P180	051111-69641-5	100/400
	P220	051111-69642-2	100/400
	P320	051111-69645-3	100/400
	P80	051111-69625-5	75/300
	P100	051111-69626-2	100/400
	P120	051111-69627-9	100/400
6" 6 dust holes	P150	051111-69628-6	100/400
	P180	051111-69629-3	100/400
	P220	051111-69630-9	100/400
	P320	051111-69633-0	100/400

# Hookit™ Discs – Paper

## High Performance

### 734U/334U

(734U 3M™ Cubitron™ mineral blend available in P80 – P180 and 334U Aluminum Oxide available in P220)



- C wt. paper
- Sharp-cutting and durable
- Ideal for wood, soft metals, fiberglass and solid surface

Diameter	Grade	UPC Number	Min /Case
5" no dust hole 734U	P80	051131-01767-2	50/200
	P100	051131-01766-5	50/200
	P120	051131-01765-8	50/200
	P150	051131-01764-1	50/200
	P180	051131-01763-4	50/200
5" no dust hole 334U	P220	051131-01762-7	50/200
5" 5 dust holes 734U	P80	051131-01805-1	50/200
	P100	051131-01804-4	50/200
	P120	051131-01803-7	50/200
	P150	051131-01802-0	50/200
	P180	051131-01801-3	50/200
5" 5 dust holes 334U	P220	051131-01800-6	50/200
6" no dust hole 734U	P80	051131-01782-5	50/200
	P100	051131-01781-8	50/200
	P120	051131-01780-1	50/200
	P150	051131-01779-5	50/200
6" no dust hole 334U	P180	051131-01778-8	50/200
	P220	051131-01777-1	50/200
6" 6 dust holes 734U	P80	051131-01820-4	50/200
	P100	051131-01819-8	50/200
	P120	051131-01818-1	50/200
	P150	051131-01817-4	50/200
	P180	051131-01816-7	50/200
6" 6 dust holes 334U	P220	051131-01815-0	50/200

## 3M™ Hookit™ Discs – Film

### High Performance



### 3M™ Microfinishing Film 366L

- Micron graded for consistent finishes with no wild scratches
- Use for leveling and finishing acrylic and polyester solid surfaces

Diameter	Grade	UPC Number	Min/Case
5" no holes	100 micron	051144-84169-1	50/500
	60 micron	051144-84167-7	50/500
	30 micron	051144-84164-6	50/500
	15 micron	051144-84162-2	50/500
6" no holes	60 micron	051111-61025-1	50/500

## 3M™ Hookit™ Accessories

### No Dust Holes

### Hookit™ Disc Pads

- Conformable foam body
- Durable plastic hub



Size	Thread	UPC Number	Min/Case
5" x 3/4" For 5" Discs 12000 RPM 12000 OPM	5/16-24 EXT	051131-05775-3	1/10
6" x 3/4" For 5" Discs 12000 RPM 12000 OPM	5/16-24 EXT	051131-05776-0	1/10

### Hookit™ Low Profile Disc Pads

- Low profile for improved accessibility
- Less conformability



Size	Thread	UPC Number	Min/Case
5" x 3/8" 12000 RPM 12000 OPM	5/16-24 EXT	051131-05755-5	1/10
6" x 3/8" 12000 RPM 12000 OPM	5/16-24 EXT	051131-05756-2	1/10

### Hookit™ Low Profile Finishing Disc Pads

- Soft foam body
- For fine finishing and outstanding conformability



Size	Thread	UPC Number	Min/Case
5" x 11/16" 12000 RPM 12000 OPM	5/16-24 EXT	051144-77855-3	1/10

# 3M™ Hookit™ Accessories

## Dust Free Pads

### Hookit™ Dust-Free Disc Pads

- For use with Hookit dust-free discs



Size	Thread	UPC Number	Min /Case
5" x 3/4" 12000 RPM 12000 OPM	5/16-24 EXT	051144-82659-9	10
6" x 3/4" 12000 RPM 12000 OPM	5/16-24 EXT	051144-05876-7	10

### Hookit™ Dust-Free Low Profile Finishing Disc Pads

- For use with 5" Hookit D/F discs
- Soft foam construction
- Recommended for grades 220 and finer



Size	Thread	UPC Number	Min /Case
5" x 11/16" 12000 RPM 12000 OPM	Vacuum Groove PN84226	051111-51042-1	10
5" x 11/16" 12000 RPM 12000 OPM	5/16-24 EXT	051144-77856-0	1/10

### Hookit™ Manufacturer Specific Disc Pads

Size	Thread	UPC Number	Min/Case
5" x 1/2" Fits DeWALT DW421, 422 & 423 12000 RPM 12000 OPM	3 Bolt Holes	051111-50204-4	1/5
5" x 1/2" Fits Porter-Cable 333 & 334 12000 RPM 12000 OPM	3 Bolt Holes	051111-50205-1	1/5
5" x 1/2" x 11/8" Fits Bosch 13107DVS 12000 RPM 12000 OPM	7mm Bolt Holes	051111-50203-7	1/5

DeWALT is a registered trademark of DeWALT Industrial Tool Company

\* Center hole diameter

### Hookit™ Disc Hand Pads

- Excellent for hand sanding with A wt. or C wt. Hookit discs

Size	UPC Number	Min /Case
5" molded	051144-85095-2	10
5" x 1/4" 6" x 1/4"	051144-77752-5 051144-05791-3	20/120 20/120
5" x 1" 6" x 1"	051144-77750-1 051144-05791-3	10 10



Patented capped stems



## 3M™ Hookit™ II Systems

### Hookit II Abrasives

Hookit II abrasives offer a better alternative to conventional hook and loop attachment systems. We replaced the “hooks” with patented capped stems (see photo at left) for secure attachment and easy release. The stems are on the disc side for greater strength, durability and flexibility. Additional benefits include: better finishes, longer disc life and longer back-up pad life.

## 3M™ Hookit™ II Discs

### General Use



### 415U

- Silicon carbide – A wt. paper
- Hookit II backing provides a finer more uniform finish
- Whitewood and sealer sanding
- Load resistant coating

Diameter	Grade	UPC Number	Min /Case
5" no dust hole	100	051111-49645-9	50/250
	120	051111-49646-6	50/250
	150	051111-49647-3	50/250
	180	051111-49648-0	50/250
	220	051111-49649-7	50/250

## 3M™ Hookit™ II Discs

### Engineered

### 236U

- Aluminum oxide mineral coated on a tear-resistant C weight paper backing
- “Gold Color”
- Designed to resist loading and provide an excellent finish



Diameter	Grade	UPC Number	Min/Case
5" no dust hole	P80	051111-50418-5	50/250
	P100	051144-86393-8	50/250
	P120	051144-86394-5	50/250
	P150	051144-86395-2	50/250
	P180	051144-86396-9	50/250
	P220	051144-86433-1	50/250
	P320	051144-86435-5	50/250
6" no dust hole	P80	051144-86448-5	50/250
	P100	051144-86449-2	50/250
	P120	051144-86450-8	50/250
	P150	051144-86451-5	50/250
	P180	051144-86452-2	50/250
	P320	051144-86455-3	50/250
	P500	051144-86457-7	50/250
5" 5 dust holes	P120	051144-86440-9	50/250
	P180	051144-86442-3	50/250
	P220	051144-86443-0	50/250
	P320	051144-86445-4	50/250
	6" 6 dust holes	P80	051144-86458-4
P120		051144-86460-7	50/250

## 3M™ Hookit™ II Discs – Paper *High Performance*

### 734U/334U

(734U 3M™ Cubitron™ Mineral blend available in P80 – P180 and 334U Aluminum Oxide available in P220)

- C wt. paper
- Sharp-cutting and durable
- Ideal for wood, soft metals, fiberglass and solid surface



Diameter	Grade	UPC Number	Min/Case
5" no dust hole 734U	P80	051131-00667-6	50/200
	P100	051131-00666-9	50/200
	P120	051131-00665-2	50/200
	P150	051131-00664-5	50/200
	P180	051131-00663-8	50/200
5" no dust hole 334U	P220	051131-00662-1	50/200
6" no dust hole 734U	P80	051131-00683-6	50/200
	P100	051131-00682-9	50/200
	P120	051131-00681-2	50/200
	P150	051131-00680-5	50/200
	P180	051131-00679-8	50/200
6" no dust hole 334U	P220	051131-00678-2	50/200

## 3M™ Hookit™ II Discs – Film *High Performance*



### 3M™ Microfinishing Film 366L

- Micron graded for consistent finishes with no wild scratches
- Use for leveling and finishing acrylic and polyester solid surfaces

Diameter	Grade	UPC Number	Min/Case
5" no holes	100 micron	051111-50187-0	25/500
	60 micron	051111-49723-4	25/500
	30 micron	051111-54592-8	25/500
	15 micron	051111-54593-5	25/500
6" no holes	100 micron	051111-50188-7	25/500
	60 micron	051111-54418-1	25/500
	30 micron	051111-54417-4	25/500
	15 micron	051111-54416-7	25/500

### YOUR 3M SOLUTIONS HOTLINES:

3M can provide additional products and accessories to meet your needs.

Please contact us in any of the following ways that you prefer:

- 3M distributor or 3M sales representative in your area
- 3M Customer Response Center **1-866-279-1235**
- 3M Custom Woodworking and Cabinet Shop Website [www.3M.com/woodworking-catalog](http://www.3M.com/woodworking-catalog)

## 3M™ Hookit™ II Accessories

### No Dust Holes

#### Hookit™ II Disc Pads

- Conformable foam body
- Durable plastic hub



Size	Thread	UPC Number	Min /Case
5" x 3/4" 12000 RPM 12000 OPM	5/16-24 EXT	051131-05275-8	1/10
6" x 3/4" 12000 RPM 12000 OPM	5/16-24 EXT	051131-05276-5	1/10

#### Hookit™ II Low Profile Disc Pads

- Low profile for improved accessibility
- Less conformability

Size	Thread	UPC Number	Min /Case
5" x 3/8" 12000 RPM 12000 OPM	5/16-24 EXT	051131-05255-0	10
6" x 3/8" 12000 RPM 12000 OPM	5/16-24 EXT	051131-056508-7	10

#### Hookit™ II Low Profile Finishing Disc Pads

- Soft foam body
- For fine finishing and outstanding conformability



Size	Thread	UPC Number	Min /Case
5" x 11/16" Soft 12000 RPM 12000 OPM	5/16-24 EXT	051131-05245-1	10

## 3M™ Hookit™ II Accessories

### Dust Free Pads

#### Hookit™ II Dust-Free Disc Pads

- For use with Hookit II dust-free discs

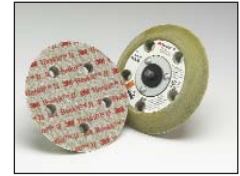

Size	Thread	UPC Number	Min /Case
5" x 3/4" 5 dust holes 12000 RPM 12000 OPM	5/16-24 EXT	051131-05375-5	10
6" x 3/4" 6 dust holes 12000 RPM 12000 OPM	5/16-24 EXT	051131-09352-2	5

#### Hookit™ II Dust-Free Low Profile Disc Pads

- For use with Hookit II dust-free discs

Size	Thread	UPC Number	Min /Case
5" x 3/8" 12000 RPM 12000 OPM	5/16-24 EXT	051131-05355-7	1/10
6" x 3/8" 12000 RPM 12000 OPM	5/16-24 EXT	051131-09352-2	5

#### Hookit™ II Dust-Free Low Profile Finishing Disc Pads





- For use with Hookit II dust-free discs

Size	Thread	UPC Number	Min /Case
5" x 11/16" 12000 RPM 12000 OPM	5/16-24 EXT	051131-05345-8	10

# 3M™ Hookit™ II Accessories

# 3M™ Hookit™ II Accessories

## Hookit™ II Manufacturer Specific Disc Pads

Size	Thread	UPC Number	Min /Case
5" x 1/2" 5 dust holes fits DeWALT DW 420, 422, 423 12000 RPM 12000 OPM	3 Bolt Holes	051111-50201-3	1/5
			
5" x 1/2" 5 dust holes fits Porter-Cable 332, 333, 334 12000 RPM 12000 OPM	3 Bolt Holes	051111-50202-0	1/5
5"x1/2"x11/8" 5 dust holes fits Bosch 3107DVS 12000 RPM 12000 OPM	7 mm Bolt Holes	051111-50200-6	1/5
			
8" x 3/8" fits National Detroit 900 or Dynabrade 5000 RPM	5 Bolt Holes	051131-05281-9	1/10
			
8" x 3/8" fits Chicago Pneumatic 777 5000 RPM	6 Bolt Holes	051131-05282-6	1/10
			

DeWALT is a registered trademark of DeWALT Industrial Tool Company

## Hookit™ II Soft Interface Disc Pads

- Soft durable foam
- Increases conformability when used with a standard Hookit II back-up pad



Size	UPC Number	Min /Case
5" x 1/2" x 1" 5 dust holes	051131-05273-4	1/10
6" x 1/2" x 1" 6 dust holes	051131-05274-1	1/10

## Hookit™ II Disc Hand Pads

- Excellent for hand sanding with A wt. or C wt. Hookit II discs





Size	Description	UPC Number	Min /Case
5"	Molded	051144-85088-4	10
5" x 1"		051144-85089-1	10

## 3M™ Hookit™ II Accessories

### Hookit™ II Conversion Face

A conversion face that converts an existing Hookit or Stikit™ pad to a Hookit II disc pad. This accessory can be used for applications where the existing disc pad accessories are designed for the original Hookit or Stikit materials and the user wants to use the new Hookit II attachment system.

Size	UPC Number	Min /Case
5"– no holes	051111-51074-2	10
6"– no holes	051111-51073-5	10
Hookit to Hookit II 12000 RPM 12000 OPM PN 02327		
5"– no holes	051111-51072-8	10
6"– no holes	051111-51071-1	10
Stikit to Hookit II 12000 RPM 12000 OPM PN 02331		

Note: Conversion pads also available for use with Scotch-Brite™ discs with Hookit and Hookit II backup pads.

## 3M™ PSA Discs

### General Use



### 248D

- Aluminum oxide – X wt. Cloth
- Heavy duty cloth backed discs for more aggressive applications
- Provides excellent adhesion while removing easily

Diameter	Grade	UPC Number	Min /Case
12"	P36	051144-88906-8	10
	P40	051144-88905-1	10
	P50	051144-88904-4	10
	P60	051144-88903-7	10
	P80	051144-88902-0	10
	P100	051144-88901-3	10

## 3M™ PSA Discs

### Engineered

### 777F

- 3M™ Cubitron™ Abrasive Grain
- Water resistant cloth backing – YF weight
- Resin bonded for heat resistance

Diameter	Grade	UPC Number	Min /Case
12"	36	051144-88869-6	10
	40	051144-88873-3	10
	50	051144-88872-6	10
	60	051144-88871-9	10
	80	051144-88870-2	10



# 3M™ Abrasive Sheets

## Aluminum Oxide & Garnet

### 110N – General Use

- A wt. paper, garnet mineral
- Open coat for non-loading
- Traditional choice for woodworkers for producing fine finishes

### 140N – General Use

- D wt. paper, garnet mineral
- Open coat for non-loading
- Choice of many cabinet makers and woodworkers

### 216U – Engineered

- Aluminum oxide – A wt. paper
- Provides an aggressive open coat material
- Designed for final hand or machine sanding of wood; also serves well for finishing, sealer sanding or defect repair



Width x Length	Grade	UPC Number	Min /Case
9" x 11" <b>110N</b>	100	051144-10006-4	100/1000
	120	051144-10005-7	100/1000
	150	051144-10004-0	100/1000
	180	051144-10003-3	100/1000
	220	051144-10002-6	100/1000
9" x 11" <b>140N</b>	50	051144-10035-4	50/500
	60	051144-10034-7	50/500
	80	051144-10033-0	50/500
9" x 11" <b>216U</b>	P 80	051131-02549-3	50/250
	P100	051131-02548-6	50/250
	P120	051131-02547-9	50/250
	P150	051131-02546-2	50/250
	P180	051131-02545-5	50/250
	P220	051131-02544-8	50/250
	P240	051131-02543-1	50/250
	P280	051131-02542-4	50/250
	P320	051131-02541-7	50/250
	P400	051131-02539-4	50/250
	P500	051131-02538-7	50/250
	P600	051131-02537-0	50/250
	P800	051131-02536-3	50/250

#### YOUR 3M SOLUTIONS HOTLINES:

3M can provide additional products and accessories to meet your needs.

Please contact us in any of the following ways that you prefer:

- 3M distributor or 3M sales representative in your area
- 3M Customer Response Center **1-866-279-1235**
- 3M Custom Woodworking and Cabinet Shop Website [www.3M.com/woodworking-catalog](http://www.3M.com/woodworking-catalog)

## 3M™ Abrasive Sheets

### *Silicon Carbide*

#### 405N – Engineered

- A wt. paper – open coat
- Ideal for dry sanding between coats of varnish and other wood finishes
- Provides exceptional finishes and excellent conformability for contour sanding
- Silicon carbide cuts fast and satin smooth

#### 415U/415N – General Use

- A wt. paper – open coat
- Surface treated with load resistant coating to extend abrasive life.

#### 435N – Engineered

- C wt. paper, silicon carbide mineral
- Open coat and load resistant coating

Width x Length	Grade	UPC Number	Min /Case
4 1/2" x 5 1/2" <b>405N</b>	150	051144-10333-1	400/4000
	180	051144-10332-4	400/4000
	220	051144-10331-7	400/4000
	240	051144-10330-0	400/4000
	280	051144-10329-4	400/4000
	320	051144-10328-7	400/4000
4 1/2" x 11" <b>405N</b>	220	051144-10260-0	200/2000
	320	051144-81439-8	200/2000
9" x 11" <b>405N</b>	150	051144-10248-8	100/1000
	180	051144-10247-1	100/1000
	220	051144-10246-4	100/1000
	240	051144-10245-7	100/1000
	280	051144-10244-0	100/1000
	320	051144-10243-3	100/1000
	360	051144-10242-6	100/1000
	400	051144-10241-9	100/1000
9" x 11" <b>415U</b>	100	051144-14175-3	100/1000
	120	051144-14177-7	100/1000
9" x 11" <b>415N</b>	240	051144-14186-9	100/1000
	280	051144-14188-3	100/1000
	320	051144-14190-6	100/1000
9" x 11" <b>435N</b>	100	051144-02356-1	100/1000
	120	051144-02355-4	100/1000
	150	051144-02354-7	100/1000
	180	051144-02353-0	100/1000



## 3M™ Abrasive Sheets

### *Wetordry™ Paper*

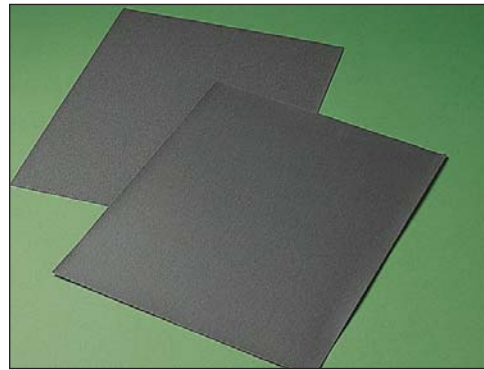

#### 413Q – General Use

- Silicon carbide – A wt. paper
- Excellent conformability

Width x Length	Grade	UPC Number	Min /Case
9" x 11"	220	051144-02007-2	50/500
	240	051144-02006-5	50/250
	280	051144-02005-8	50/250
	320	051144-02004-1	50/500
	360	051144-02003-4	50/250
	400	051144-02002-7	50/500
	500	051144-02001-0	50/500
	600	051144-02000-3	50/500

# Scotch-Brite™ Hand Pads

## General Use

### Scotch-Brite™ Hand Pads

Excellent products for hand finishing and cleaning of composites. Ideal for wood finishing, paint prep, general cleaning.

- Sealer scuffing
- Defuzzing white wood
- Denibbing coatings
- Scuffing between coats
- Produce a final hand rubbed finish



No.	Color	UPC Number	Pads/Case
7440	Tan	048011-04050-9	40
7445	Gold	051131-07445-3	60
7446	Gray	048011-04051-6	40
7448	Light Gray	048011-04028-8	60
7447	Maroon	048011-04029-5	60

### Scotch-Brite™ Clean & Finish Rolls

- Highly conformable Scotch-Brite web can be cut to desired length
- For hand sanding or oscillating sanders



Size	Grade	UPC Number	Min/Case
4" x 30 ft	S ULF	048011-04096-7	1/3
6" x 30 ft	A MED	048011-00274-3	1/2
10" x 30 ft	A MED	048011-18402-9	1/2

### Scotch-Brite™ Multi-Flex Sheet Rolls

- Handy dispenser package
- Tough, highly conformable and sharp-cutting
- Great for cleaning and finishing surfaces by hand
- Denibbing coatings



Size	Color/Grade	UPC Number	Rolls/Case
8" x 20 ft	Gray/ULF	051131-07522-1	4
8" x 20 ft	Maroon/VFN	051131-07521-4	4

Each roll contains 60 – 4" x 8" sheets.

### 👉 YOUR 3M SOLUTIONS HOTLINES:

3M can provide additional products and accessories to meet your needs. Please contact us in any of the following ways that you prefer:

- 3M distributor or 3M sales representative in your area
- 3M Customer Response Center  
**1-866-279-1235**
- 3M Custom Woodworking and Cabinet Shop Website  
**www.3M.com/woodworking-catalog**

## 3M™ Sanding Sponges

### General Use

#### 3M™ Full Size Sanding Sponges

- Abrasive on four sides
- Conformable, flexible and convenient



Size	Grade	UPC Number	Min/Case
3 3/4" x 2 5/8" x 1"	Fine	051115-00409-4	1/24
	Medium	051115-00408-7	1/24
	Fine	051115-06968-0	250
	Medium	051115-06967-3	250

#### 3M™ High Flexibility Sponges

- Abrasive on three sides
- Conformable flexible and convenient



Size	Grade	UPC Number	Min/Case
3 3/4" x 2 5/8" x 1/2"	Fine	051115-00631-9	108
	Medium	051115-00630-2	108

#### 3M™ Woodworking Sanding Pad

- Abrasive on two sides
- Conformable flexible and convenient



Size	Grade	UPC Number	Min/Case
4 3/4" x 3 3/4" x 1/2"	Fine	051111-51066-7	250
	Medium	051111-51065-0	250

## 3M™ Sanding Sponges

### Engineered

#### 3M™ Softback Sanding Sponges

- Abrasive on one side
- Conformable flexible and convenient



Size	Grade	UPC Number	Min/Case
5 1/2" x 4 1/2" x 3/16"	MicroFine	051131-02600-1	20/120
	UltraFine	051131-02601-8	20/120
	SuperFine	051131-02602-5	20/120
	Fine	051131-02604-9	20/120
	Medium	051131-02606-3	20/120
5 1/2" x 4 1/2" x 3/16"	SuperFine	051115-07107-2	24
	Fine	051115-07108-9	24
	Medium	051115-07109-6	24
5 1/2" x 4 1/2" x 3/16" Bulk Pack	SuperFine	051115-06964-2	250
	Fine	051115-06965-9	250
	Medium	051115-06966-6	250

### 👉 YOUR 3M SOLUTIONS HOTLINES:

3M can provide additional products and accessories to meet your needs. Please contact us in any of the following ways that you prefer:

- 3M distributor or 3M sales representative in your area
- 3M Customer Response Center  
**1-866-279-1235**
- 3M Custom Woodworking and Cabinet Shop Website  
**www.3M.com/woodworking-catalog**

# 3M™ SandBlaster™ Sanding Sponges

*High Performance*



- Sand faster and last longer than 3M conventional abrasives of comparable grit
- Clog resistant
- Color-coded by function with grit numbers printed on the sponge

## 3M™ SandBlaster™ Sanding Sponges

- Ideal for both flat and contoured surfaces such as raised panel doors and cabinets
- Easy to hold and comfortable to use

Description	Grade	UPC Number	Qty.
<b>3.7" x 2.6" x 1"</b>			
<b>SLEEVED BLOCKS</b>			
Green/Coarse	36	051111-11515-2	12
	60	051111-11516-9	12
Maroon/Medium	80	051111-50679-0	12
	100	051111-50675-2	12
	150	051111-50677-6	12
Gold/Fine	180	051111-11517-6	12
	320	051111-50673-8	12
<b>3.7" x 2.6" x 1"</b>			
<b>NO SLEEVE BLOCKS</b>			
Green/Coarse	36	051111-50681-3	12
	60	051111-50682-0	12
Maroon/Medium	80	051111-50680-6	12
	100	051111-50676-9	12
	150	051111-50678-3	12
Gold/Fine	180	051111-50672-1	12
	320	051111-50674-5	12

## 3M™ SandBlaster™ Sanding Pads

- Flat, flexible pads conform to almost any surface
- Designed specifically for highly contoured surfaces like spindles, handrails, corners and crevices

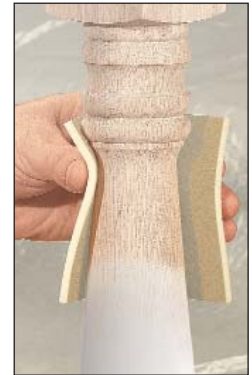

Description	Grade	UPC Number	Qty.
<b>4.5" x 5.5" x 3/16"</b>			
<b>SLEEVED PADS</b>			
Green/Coarse	60	051111-50695-0	12
	80	051111-50691-2	12
	100	051111-50687-5	12
Maroon/Medium	150	051111-50689-9	12
	180	051111-50683-7	12
Gold/Fine	320	051111-50685-1	12
	<b>4.5" x 5.5" x 3/16"</b>		
<b>NO SLEEVE PADS</b>			
Green/Coarse	60	051111-50696-7	12
	80	051111-50692-7	12
	100	051111-50688-2	12
Maroon/Medium	150	051111-50690-5	12
	Gold/Fine	180	051111-50684-4
320		051111-50686-8	12



# Solid Surfaces

## Sanding Surface Recommendations

3M™ Microfinishing Film

3M™ Trizact™ Film Discs

Scotch-Brite™ Discs

3M™ Polishing Film

3M™ Wetordry™ Discs

3M™ Finesse-it™ Products

3M™ Aluminum Foil Tape

3M™ Protective Tapes

3M™ Scotch-Weld™ Adhesives

3M™ Jet-melt™ Adhesives

# 3M Products for Solid Surface Materials

## Recommended Sequence for Acrylic-Filled and Polyester-Filled Solid Surfaces (damp sequence)

	Matte Finish		Semi-Gloss Finish		High Gloss Finish	
					Standard Sequence	Alternate Sequence <sup>4</sup>
<b>Step 1</b>	366L 100 micron <sup>1</sup> dry		366L 100 micron <sup>1</sup> dry		366L 100 micron <sup>1</sup> dry	366L 100 micron <sup>1</sup> dry
<b>Step 2</b>	268XA A35 damp		268XA A35 damp		268XA A35 damp	268XA A35 damp
<b>Step 3</b>	Scotch-Brite™ A VFN <sup>2</sup>		268XA A10 damp		268XA A10 damp	268XA A10 damp
<b>Step 4</b>	Gloss = 12–15		Scotch-Brite™ S ULF <sup>3</sup>		268XA A5 damp	268XA A5 damp
<b>Step 5</b>			Gloss = 45		acrylic: 568XA CeO damp polyester: Finesse-it™ Finishing Material Easy Clean-up with 968M	286Q 9micron damp
<b>Step 6</b>					Gloss = 80	Finesse-it™ Finishing Material Easy Clean-up or Finesse-It™ Final Finish (reduces haze) Gloss = 80+

<sup>1</sup> Many scratches can be removed with 366L 60micron, which can save time in Step 2.  
<sup>2</sup> For acrylic, 268XA A10 damp can be used instead of Scotch-Brite A VFN if desired.  
<sup>3</sup> For acrylic, 268XA A5 damp can be used instead of Scotch-Brite S ULF if desired.  
<sup>4</sup> Use this method if you encounter swirl marks using the standard sequence or if you desire a very high gloss (over 80).

**NOTE:** Rinse debris from Trizact™ discs after each use, and wipe the surface clean following each step to minimize contamination scratches.

## 3M™ Solid Surface Finishing Dry Sanding Sequence

	Matte Finish		Semi-Gloss Finish		High Gloss Finish	
	Product	Grade	Product	Grade	Product	Grade
<b>Step 1</b>	366L	100μ	366L	100μ	366L	100μ
<b>Step 2</b>	366L	60μ	366L	60μ	366L	60μ
<b>Step 3</b>	Scotch-Brite™	7447	366L	30μ	366L	30μ
<b>Step 4</b>			Scotch-Brite™	7448	366L	15μ
<b>Step 5</b>					968M	with Finesse-it™ Finishing Material Easy Clean-up compound

## 3M Products for Solid Surface Materials

*continued*

### 3M™ Microfinishing Film 366L

- Micron graded for consistent finishes with no wild scratches
- Use for leveling and finishing acrylic and polyester solid surfaces



Diameter	Grade	UPC Number	Min/Case	
5" no holes	100 micron	051111-50187-0	25/500	
Hookit™ II	60 micron	051111-49723-4	25/500	
Attachment	30 micron	051111-54592-8	25/500	
System	15 micron	051111-54593-5	25/500	
6" no holes	100 micron	051111-50188-7	25/500	
Hookit™ II	60 micron	051111-54418-1	25/500	
Attachment	30 micron	051111-54417-4	25/500	
System	15 micron	051111-54416-7	25/500	
5" no holes	100 micron	051144-84169-1	50/500	
Hookit™	60 micron	051144-84167-7	50/500	
Attachment	30 micron	051144-84164-6	50/500	
System	15 micron	051144-84162-2	50/500	
6" no holes	Hookit™	60 micron	051111-61025-1	50/500
Attachment	System			
5" no holes	100 micron	051144-84182-0	125/500	
PSA Disc Rolls	60 micron	051144-84161-5	125/500	
	30 micron	051144-84177-6	125/500	
	15 micron	051111-61522-5	125/500	
6" no holes	100 micron	051111-54412-9	125/500	
PSA Disc Rolls	60 micron	051111-54413-6	125/500	
	30 micron	051111-54414-3	125/500	
	15 micron	051111-54415-0	125/500	

### 3M™ Trizact™ Film Discs 268XA/568XA

- Use after leveling step
- Consistent cut rate and longer life than other conventional abrasives
- Mist the surface with water during use
- Often eliminates the need for messy compounds



Diameter	Grade	UPC Number	Min/Case
5" no holes	268XA A35 (green)	051111-49962-7	50/100
Hookit™ II	268XA A10 (blue)	051111-49963-4	50/100
Attachment	268XA A5 (orange)	051111-49971-9	50/100
System	568XA none (white)	051111-50004-0	50/100
6" no holes	268XA A35 (green)	051111-50006-4	50/100
Hookit™ II	268XA A10 (blue)	051111-50047-7	50/100
Attachment	268XA A5 (orange)	051111-50061-3	50/100
System	568XA none (white)	051111-49951-1	50/100
11-1/4"	268XA A35 (green)	051111-54604-8	25/25
no holes	268XA A10 (blue)	051111-54603-1	25/25
Hookit™ II	268XA A5 (orange)	051111-54605-5	25/25
Attachment	System		
5" no holes	268XA A35 (green)	051111-49744-9	25/100
PSA	268XA A10 (blue)	051111-49749-4	25/100
Disc Rolls	268XA A5 (orange)	051111-49748-7	25/100
	568XA none (white)	051111-49674-9	25/100
6" no holes	268XA A35 (green)	051111-54616-1	25/100
PSA	268XA A10 (blue)	051111-54615-4	25/100
Disc Rolls	268XA A5 (orange)	051111-54617-8	25/100
	568XA none (white)	051111-54630-7	25/100

### 👉 YOUR 3M SOLUTIONS HOTLINES:

*3M can provide additional products and accessories to meet your needs.*

*Please contact us in any of the following ways that you prefer:*

- 3M distributor or 3M sales representative in your area
- 3M Customer Response Center **1-866-279-1235**
- 3M Custom Woodworking and Cabinet Shop Website [www.3M.com/woodworking](http://www.3M.com/woodworking)



# 3M Products for Solid Surface Materials

*continued*

## Scotch-Brite™ Production Clean and Finish Discs

- Delivers high cut, long life and fine finish
- Used to achieve low gloss finishes (less than 45) on solid surface materials
- Aluminum Oxide mineral

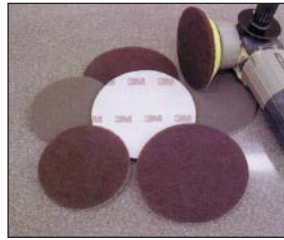

Diameter	Grade	UPC Number	Qty/Case
5" Hookit™ II Attachment System	A VFN	048011-33223-9	40
	S ULF	048011-33220-8	40
6" Hookit™ II Attachment System	A VFN	048011-33224-6	40
	S ULF	048011-33221-5	40
11-1/4" Hookit™ II Attachment System	A VFN	048011-33225-3	10
	S ULF	048011-33222-2	10
5" Hookit™ Attachment System	A VFN	048011-29292-2	40
	S ULF	048011-29294-6	40
6" Hookit™ Attachment System	A VFN	048011-29293-9	40
	S ULF	048011-29295-3	40

## 3M™ Wetordry™ Disc 286Q

- Superflexible non-woven backing for polishing of interior shapes and contours
- Precision micron grading for uniform, consistent finish
- Use damp on solid surface material to achieve high gloss (80+)

Diameter	Grade	UPC Number	Min/Case
5" no holes Hookit™ II Attachment System	9 micron	051111-54409-9	50/100
	3 micron	051111-53895-1	50/100
6" no holes Hookit™ II Attachment System	9 micron	051111-54407-5	50/100
	3 micron	051111-5406-8	50/100

## 3M™ Polishing Film 968M

- Non-abrasive disc used as a carrier for a polishing compound
- Use with 3M™ Finesse-it™ Compound to achieve high gloss on solid surface material (80 and higher)

Diameter	UPC Number	Min/Case
5" no holes	051111-53896-8	50/100
6" no holes Hookit™ II Attachment System	051111-54405-1	50/100
5" no holes	051144-14121-0	50/500
6" no holes PSA Disc Rolls	051111-49931-3	50/500

## 3M™ Finesse-it™ Finishing Material Easy Clean-up

- Use with 3M™ Polishing Film 968M to achieve a high gloss (80 and higher) on solid surface materials



Size	UPC Number	Qty/Case
Quart	051144-81235-6	12
Gallon	051144-13084-9	4

## 3M™ Finesse-it™ Final Finish

- Use to achieve high gloss on solid surface materials



Size	UPC Number	Qty/Case
Quart	051144-82877-7	12
Gallon	051144-82878-4	4

## 3M Products for Solid Surface Materials

*continued*

### 3M™ Wetordry™ Rubber Squeegee

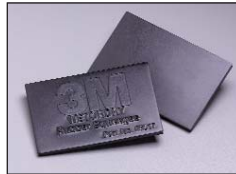

Size	UPC Number	Min /Case
2 3/4" x 4 1/4"	051144-05517-3	50



### 3M™ Aluminum Foil Tape 425

- Use when installing countertops in areas where heat resistance is important, such as around stoves
- Moisture and chemical resistant
- Thermally conductive
- Heat and light reflective
- Flame resistant\*
- Outdoor weatherable
- Vibration damping

UPC Number	Size	Rolls Per Case
021200-60572-7	1" x 60 yds.	36
021200-60574-1	2" x 60 yds.	24
021200-60597-0	3" x 60 yds.	12

\*Meets U.L. 746C (File E 122798) and 723, Class "L" low flammability rating (File R 7311).

### 3M™ Protective Tapes

When choosing a protective tape, consider your specific application requirements, especially:

- Type of surface to protect
- Abrasive resistance/film thickness requirements
- Adhesion Level/tack requirements – which can be affected by the presence of dust or debris from sanding or polishing

Starting Point		Higher Tack	
2 mil	2A25	2 mil	2A26
2.5 mil	25A25	2.5 mil	25A26

### Ordering Information - see page 68 for more information

3M Protective Tapes are custom ordered products.

Please contact your local 3M Authorized distributor or your 3M Sales Specialist for ordering information.

Minimum order is \$500, not assortable.

# 3M Products for Solid Surface Materials

*continued*

## Adhesives ideal for attaching solid surface materials to wood:

- Attaching solid surface material to countertops and cabinets
- Attaching wood blocks to the bottom of solid surface materials

**NOTE:** Check with solid surface manufacturers for specifications in color match situations.



## 3M™ Scotch-Weld™ Polyurethane Reactive Adhesives

- 100% solids, single component
- Moisture curing polyurethane
- Eliminates metering, mixing and curing
- Low VOC - no drying equipment
- 10.0 fl. oz. cartridge

Description	Open time	Set time	UPC Number	Conts./ Case
TE031	2 min	30 sec	021200-83694-7	6
TS230	4 min	2.5 min	021200-83643-5	6

## 3M™ Scotch-Weld™ Adhesives

Epoxy and acrylic-based adhesives that cure at room temperature or with heat to provide tough, impact-resistant bonds with high peel strengths. Practical bond strength is at least 1,000 psi on overlap shear at 75°F (24°C).

Description	Features/ Size	Approx. Worklife* at 75°F (24°C)	UPC Number	Cont./ Case
<b>Epoxy</b>				
DP105 Clear	Fast cure Very flexible Excellent peel strength	5 min 1.7 fl. oz.	021200-87203-7	12
<b>Acrylic</b>				
DP820 Yellow	High shear and peel strengths Medium worklife	15-20 min 1.6 fl. oz.	021200-89347-6	12

\* The time during which an adhesive will adequately wet-out on a substrate.

### YOUR 3M SOLUTIONS HOTLINES:

*3M can provide additional products and accessories to meet your needs.*

*Please contact us in any of the following ways that you prefer:*

- 3M distributor or 3M sales representative in your area
- 3M Customer Response Center  
**1-866-279-1235**
- 3M Custom Woodworking and Cabinet Shop Website  
**www.3M.com/woodworking-catalog**

## 3M™ Assembly Adhesives

*continued*

### 3M™ Jet-melt™ Adhesives

- 100% solid, solvent free thermoplastic resins
- Assemblies can be moved immediately
- No space or energy consumed for drying
- Also available in low temperature applied versions
- Reaches handling strength in seconds
- Applied through 3M™ Polygun™ Applicators

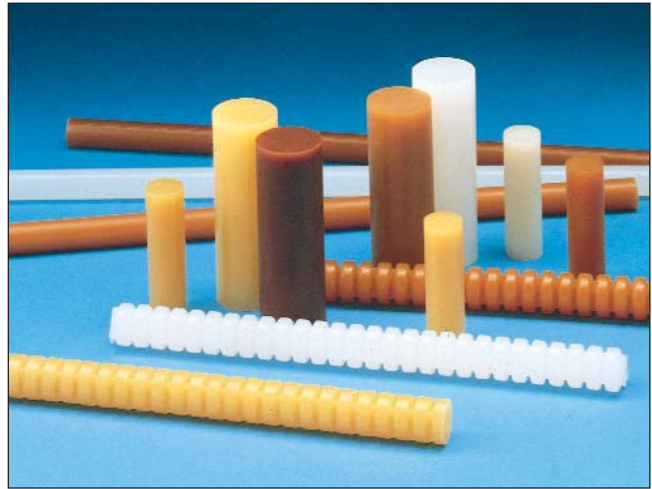

Description	Features	Size	UPC Number	Lbs./Case
<b>3738</b> Tan applied at 350-375°F	High delivery rate and long bonding range. General purpose for wood bonding, corrugated selected plastics and chipboard.	5/8" x 8" Q	021200-65262-2	11
		1" x 3" PG	021200-82609-2	22
		5/8" x 2" TC	021200-82610-8	11
		1/2" x 12" AE	021200-82594-1	11
<b>3747</b> Tan applied at 350-375°F	Excellent hot melt adhesive for bonding wood when heat resistant bonds are required. Offers good impact resistance and flexibility. Bonds good on MDF.	5/8" x 8" Q	021200-82561-3	11
		1" x 3" PG	021200-82221-6	22
		5/8" x 2" TC	021200-82560-6	11
		1/2" x 12" AE	021200-82220-9	11
<b>3750</b> Tan applied at 350-375°F	General purpose adhesive with high flow rate for increased production.	1/2" x 12" AE	021200-96269-1	11
<b>3762</b> Tan applied at 350-375°F	Excellent "hot tack," fast-setting. Bonds to a variety of corrugated packaging, beadboard. Economical, general purpose. Can bond chipboard and wood.	5/8" x 8" Q	021200-65261-5	11
		1" x 3" PG	021200-82614-6	22
		5/8" x 2" TC	021200-82615-3	11
		1/2" x 12" AE	021200-82596-5	11
<b>3762LM</b> Lt. Amber applied at 265°F	Low temperature (265° F/129°C) applied version of 3762.	5/8" x 8" Q	021200-49125-2	11
		1" x 3" PG	021200-49128-3	22
		5/8" x 2" TC	021200-49134-4	11
<b>3764</b> Clear applied at 350-375°F	Bonds to a variety of plastics including polycarbonate, polyethylene and polypropylene. Flexible at low temperatures.	5/8" x 8" Q	021200-76054-9	11
		1" x 3" PG	021200-82598-9	22
		5/8" x 2" TC	021200-82599-6	11
		1/2" x 12" AE	021200-82597-2	11
<b>3792</b> Clear applied at 350-375°F	Clear, multi-purpose product for wood, corrugated, and lightweight substrates. Can bond fabric.	5/8" x 8" Q	021200-65263-9	11
		1" x 3" PG	021200-82606-1	22
		5/8" x 2" TC	021200-82589-7	11
		1/2" x 12" AE	021200-82583-5	11
<b>3792LM</b> Clear applied at 265°F	Low temperature (265° F/129°C) applied version of 3792.	5/8" x 8" Q	021200-82454-8	11
		1" x 3" PG	021200-83491-2	22
		5/8" x 2" TC	021200-82456-2	11



# Adhesives

3M™ Aerosol Adhesives

3M™ Contact Adhesives

3M™ Assembly Adhesives

3M™ Structural Assembly Adhesives

## 3M™ Aerosol Adhesives

### 3M™ FoamFast 74 Spray Adhesive\*

- Gives fast tack with foam tearing strength and a soft, non-dimpling glue line
- General upholstery foam bonding, to bond small foam pieces together to save foam, to form foam shapes by knife edge bonding, boxing, and edge turning
- It attaches foam to metal and bonds most fabrics
- Precise spray control

*Bond Type:* Permanent

*Bonding Time:* One side – not recommended; two sides – 15 minutes

*Spray Width:* 1 to 4-1/2 inches, variable

*Spray Pattern:* Controlled Lace

*Color:* Orange and Clear

*Temperature Resistance:* 49°C/120°F

*Coverage:* 260 square feet (24,99m<sup>2</sup>)



UPC Number	Color	Can Size	Net Wt.	Cans Per Case
021200-82242-1	Orange	24 fl. oz.	16.9 oz.	12
021200-50045-9	Clear	24 fl. oz.	16.9 oz.	12



#### TECH TIP:

\* Meets current California Air Resource Board aerosol adhesive VOC limits.

### 3M™ Super 77 Multipurpose Adhesive\*

- High coverage, fast, aggressive tack, and a long-bonding range
- Versatile – securely bonds most lightweight materials, plus it has low soak-in for long-lasting bonds
- Excellent for jobs in display and furniture – it bonds thin decorative film, foils, and fabrics

*Bond Type:* Temporary or Permanent

*Bonding Time:* One side – 15 minutes; two sides – 30 minutes

*Spray Width:* 1-1/2 to 4 inches

*Spray Pattern:* Particle (fan) Color: Nearly clear

*Temperature Resistance:* 43°C/110°F

*Coverage:* 220 square feet (7,15 - 20,44m<sup>2</sup>)



UPC Number	Can Size	Net Wt.	Cans Per Case
021200-21210-9	24 fl. oz.	16.75 oz.	12

### 3M™ Hi-Strength 90 Spray Adhesive\*

- High contact strength and a one-minute dry time
- Bonds decorative laminates to tables, cabinets, and shelving, kick plates to desks, and plastic sign lettering to wood
- Adheres polyethylene and polypropylene to wood, metal, and more

*Bond Type:* Permanent

*Bonding Time:* One side – not recommended; two sides – 15 minutes

*Spray Width:* 1 to 4-1/2 inches, variable

*Spray Pattern:* Controlled Lace

*Color:* Translucent

*Temperature Resistance:* 71°C/160°F

*Coverage:* 100 square feet (9,29m<sup>2</sup>)



UPC Number	Can Size	Net Wt.	Cans Per Case
021200-30023-3	24 fl. oz.	17.6 oz.	12

## 3M™ Aerosol Adhesives

*continued*

### 3M™ Cylinder Spray Adhesives

*(not available in California)*

- No-clog pressurized cylinder
- Go where you want—bonds in minutes

### 3M™ Hi-Strength 90 Cylinder Spray Adhesive

- Quickly adheres edge bonding to flat and curved surfaces
- Cabinets—lamine surfaces



UPC Number	Size (Net Wt.)	Qty. Per Case
021200-41554-8	28.8 lbs.	1



### SPRAY EQUIPMENT FOR CYLINDERS

*Please contact Shopware*

*Phone: 800-877-9344*

*Fax: 952-392-2018*

*Web Address: [www.shopwareinc.net](http://www.shopwareinc.net)*

### Scotch® Adhesive Remover Pen Citrus Base

- Easy to control
- Removes adhesive residue



Size	UPC Number	Units Per Case
.35 oz.	021200-50021-3	12

### 3M™ Adhesive Remover

- Leaves surfaces clean and dry
- No residue
- Citrus-based



UPC Number	Size	Units Per Case	Net Wt.
021200-39296-2	6.25 fl. oz.	6 cans	5 oz.
021200-49048-4	24 fl. oz.	6 cans	18.5 oz.
021200-49142-9	1 gallon	4 pails	—
021200-49143-6	5 gallons	1 pail	—



### YOUR 3M SOLUTIONS HOTLINES:

*3M can provide additional products and accessories to meet your needs.*

*Please contact us in any of the following ways that you prefer:*

- 3M distributor or 3M sales representative in your area
- 3M Customer Response Center **1-866-279-1235**
- 3M Custom Woodworking and Cabinet Shop Website [www.3M.com/woodworking-catalog](http://www.3M.com/woodworking-catalog)

## 3M™ Contact Adhesives

### 3M™ Fastbond™ Contact Adhesive 2000NF

- Water-dispersed high solids, activated adhesive
- Provides immediate bonding without forced drying
- Post-formable and heat resistant



Description	Size	UPC Number	Qty. Per Case
Blue	5 Gal. Pail	021200-87965-4	1
Light Orange	5 Gal. Pail	021200-87953-1	1
Neutral	5 Gal. Pail	021200-89337-7	1
Spray Activator #1*	Quart	021200-56533-5	2

\* **NOTE:** The spray activator quart (021200-56533-5) will not automatically ship. It must be ordered along with the adhesive.



### SPRAY EQUIPMENT FOR FASTBOND™ ADHESIVE 2000NF

Please contact US Legends

Phone: **530-477-4312**

Fax: **530-477-4316**

Web Address: **www.uslegends.com**

### 3M™ Fastbond™ Contact Adhesives 30H NF Green

- Water-based
- High viscosity version of 3M™ Fastbond™ Contact Adhesive 30NF for roll coating

Description	Size	UPC Number	Qty. Per Case
<b>GREEN</b>			
Contact Adhesive	55 Gal. Drum	021200-30078-3	1

### 3M™ Fastbond™ Contact Adhesives 30NF Green and Neutral

- Water-based
- Spray, roll or brush apply
- Post-formable and heat resistant



Description	Size	UPC Number	Qty. Per Case
<b>GREEN</b>			
Contact Adhesive	Quart	021200-21185-0	12
Contact Adhesive	Gallon	021200-21186-7	4
Contact Adhesive	5 Gal. Pail	021200-21187-4	1
Contact Adhesive	52 Gal. Drum	021200-21188-1	1

#### **NEUTRAL**

Contact Adhesive	Quart	021200-21180-5	12
Contact Adhesive	Gallon	021200-21181-2	4
Contact Adhesive	5 Gal. Pail	021200-21182-9	1
Contact Adhesive	52 Gal. Drum	021200-21183-6	1

### 3M™ Scotch-Grip™ Contact Adhesive 5

- Sprayable, neoprene, contact adhesive rapidly builds strength
- Bonds high pressure plastic laminates to wood, particle board, metal and other surfaces
- Heat and creep resistant bond

Description	Size	UPC Number	Qty. Per Case
Green	5 Gallon Pail	021200-21232-1	1
Neutral	5 Gallon Pail	021200-20333-6	1



#### **TECH TIP:**

Water-based adhesives typically cover up to 3x the area of solvent-based adhesives.



# 3M™ Contact Adhesives

*continued*

## 3M™ Scotch-Grip™ Contact Adhesive 10

- Neoprene contact adhesive. Can be applied with brush or roller
- Bonds high pressure plastic laminates to wood, particle board, metal and other surfaces
- Heat and creep resistant bond



## 3M™ Scotch-Grip™ High Performance Contact Adhesive 1357

- Sprayable neoprene contact adhesive provides a long bonding range and excellent initial strength
- Adheres exceptionally well to many decorative plastic laminates, cloth, wood, and foamed glass
- Meets all requirements of MIL-A21366A-121



Description	Size	UPC Number	Qty. Per Case
Neutral	Quart	021200-20272-8	12
Neutral	Gallon	021200-20274-2	4
Neutral	5 Gallon Pail	021200-20276-6	1

Description	Size	UPC Number	Qty. Per Case
Gray Olive	5 oz. tube	021200-19887-8	36
Gray Olive	Pint	021200-19890-8	12
Gray Olive	Quart	021200-19892-2	12
Gray Olive	1 Gallon	021200-19894-6	4
Gray Olive	5 Gallon Pail	021200-19897-7	1
Neutral	1 Gallon	021200-22586-4	4
Neutral	5 Gallon Pail	021200-64963-9	1

## 3M™ Scotch-Grip™ Construction Mastic 4323 Gray

High performance panel and construction adhesive for both interior and exterior use. This versatile adhesive bonds to many hardwoods, plywoods, concrete, aluminum, steel polystyrene foam, FRP, and some plastics.

- Ideal for building construction, remodeling, paneling, and repair of furniture
- Smooth easy caulking characteristics
- Resistant to wear, heat, and dead load creep

Description	UPC Number	Qty. Per Case
1/10 Gallon Cartridge	021200-87987-6	12
1 Quart Cartridge	021200-87988-3	12
5 Gallon Pail	021200-87990-6	1

### YOUR 3M SOLUTIONS HOTLINES:

*3M can provide additional products and accessories to meet your needs.*

*Please contact us in any of the following ways that you prefer:*

- 3M distributor or 3M sales representative in your area
- 3M Customer Response Center **1-866-279-1235**
- 3M Custom Woodworking and Cabinet Shop Website [www.3M.com/woodworking-catalog](http://www.3M.com/woodworking-catalog)

## 3M™ Assembly Adhesives



### 3M™ Scotch-Weld™ Epoxy and Acrylic Adhesives

Epoxy based adhesives/sealants with a 1:1 or 2:1 mix ratio that is ideal for bonding many substrates with different coefficients of expansion and contraction. As an alternative to mechanical or fusion fastening, the reasons for Scotch-Weld Adhesives are many: greater design latitude, cleaner lines, material substitution, less machining, lighter weight, more durability, and often less cost.

Description	Size (duo-pak)	UPC Number	Qty. Per Case
DP100 Clear	1.7 fl. oz.	021200-22648-9	12
DP100NS Translucent	1.7 fl. oz.	021200-82255-1	12
DP105 Clear	1.7 fl. oz.	021200-87203-7	12
DP190 Gray	1.7 fl. oz.	021200-22647-2	12
DP810 Tan	1.7 fl. oz.	021200-31310-3	12



### 3M™ EPX™ Applicators and Accessories

Description	UPC Number	Qty. Per Case
EPX Pneumatic Applicator 50 ml	021200-83528-5	1
EPX Plus II Applicator 50ml	021200-50004-6	10
EPX Mixing Nozzle #9742	021200-21791-3	72
EPX Mixing Nozzle #9742 (Bulk)	021200-85801-7	1200
EPX 2:1 Plunger Assembly	021200-50006-0	10
EPX 1:1 Plunger Assembly	021200-50005-3	10

Product (color)	Features	Mix Ratio (Volume) B:A	Approximate <sup>2</sup> Viscosity 75°F (24°C) (CPS)	Approximate <sup>3</sup> Worklife at 75°F (24°C)	Average T-Peel <sup>4</sup> at 75°F (24°C) PIW	Overlap Strength <sup>5</sup> PSI			
						-67°F (-55°C)	75°F (24°C)	180°F (82°C)	250°F (121°C)
DP100 Clear	<ul style="list-style-type: none"> <li>Fast cure adhesive</li> <li>Rigid epoxy</li> <li>15-20 min. handling strength</li> <li>Machinable product</li> </ul>	1:1	13,000	4 Min.	2	900	1500	300	200
DP100NS Translucent	<ul style="list-style-type: none"> <li>25-30 min. handling strength</li> <li>Translucent low flow version of DP100 Adhesive</li> </ul>	1:1	95,000	6 Min.	2	900	1500	300	200
DP105 Clear	<ul style="list-style-type: none"> <li>Water clear</li> <li>Fast cure</li> <li>Very flexible</li> <li>Excellent peel strength</li> </ul>	1:1	6,500	5 Min.	35	3500	2000	150	100
DP190 Gray	<ul style="list-style-type: none"> <li>Long worklife adhesive</li> <li>Flexible epoxy</li> <li>8-12 hrs. handling strength</li> <li>Can bond metals, Plastics and many other dissimilar materials</li> </ul>	1:1	80,000	90 Min.	20	1500	2500	400	300
DP810 Tan	<ul style="list-style-type: none"> <li>Bonds many metals and plastics without surface preparation</li> <li>Extremely fast strength build up</li> <li>Fully cured in 6 hours</li> </ul>	1:1	20,000	8-10 Min.	30	1200	4200	500	300 <sup>6</sup>

Note: The technical information and data on these pages should be considered representative or typical only, and should not be used for specification purposes.

(1) Color is mixed if two-part product. (2) Brookfield viscometer viscosity values are typical values for the mixed product. (3) The time during which an adhesive will adequately wet-out on a substrate. (4) 180° peel tested on .030" aluminum per ASTM D 1876-61T. (5) Tested per ASTM D 1002-64. (6) Tested 200° F (93°).

# 3M™ Assembly Adhesives

continued

## 3M™ Scotch-Weld™ Instant Adhesives

- A combination of bond strength, cure time, and viscosity
- These clear, one-part, cyanoacrylate instant adhesives reach handling strength at room temperature in five to ten seconds without a catalyst
- A single drop per square inch can bond many plastics, rubber, metal, etc. with tensile strength up to 5,000 PSI
- Base material is Ethyl



- Resistance to any fuels, lubricating oils, and other chemicals from -40°C/-40°F to 93°C/200°F gap filling; extended cure rates for repositionability; high peel and impact strength

Description	Size	UPC Number	Qty. Per Case
CA4 Instant Adhesive	1 oz. Bottle	021200-96600-2	12
CA8 Instant Adhesive	1 oz. Bottle	021200-21066-2	12
CA9 Instant Adhesive	1 oz. Bottle	021200-21068-6	12
CA40 Instant Adhesive	1 oz. Bottle	021200-74290-3	12

Description	Size	UPC Number	Qty. Per Case
CA40H Instant Adhesive	1 oz. Bottle	021200-21073-0	12
CA50 Instant Adhesive	20 gram Tube Gel	021200-82332-9	12
CA100 Instant Adhesive	1 oz. Bottle	021200-82334-3	12
Surface Activator	2 oz. Bottle	021200-87937-1	6

Description	Features	Base	Time <sup>1</sup> To Handling Strength (Sec.)	Viscosity (CPS)	Average <sup>2</sup> T-Pel at 75°F (24°C)	Overlap Shear Strength <sup>3</sup> at 75°F (24°C) PSI					Rigid PVC
						Steel	Aluminum	Nitrile Rubber	Neoprene Rubber	ABS	
<b>CA4</b>	Fast-setting, multi-purpose cyanoacrylate adhesive for bonding a variety of plastics and rubbers. Meets MIL-A-46050C Type II, Class 2.	ethyl	5-40	60-120	1-2	1500	1500	35*	55*	900*	1000*
<b>CA8</b>	Fast setting with excellent adhesion to many metals, plastics and rubbers. Slower setting than CA-7. Meets MIL-A-46050C Type II, Class 2	ethyl	5-40	70-120	2-4	2000	2100	35*	55*	900*	1000*
<b>CA9</b>	Slower-setting version of CA-8 for wire tacking and coil terminating used with surface activator. Meets MIL-A-46050C Type II, Class 3.CA-40	ethyl	20-70	1000-1700	2-4	2000	2440	35*	55*	900*	1000*
<b>CA40</b>	Very fast-setting adhesive with excellent adhesion to many substrates, including including flexible vinyl and EPDM rubber. Meets MIL-A-46050C Type II, Class 1.	ethyl	1-30	2-10	1-2	1400	1400	35*	55*	900*	1000*
<b>CA40H</b>	A higher-viscosity, slower-setting version of CA-40, with better void-filling capabilities. Meets MIL-A-46050C Type II, Class 3.	ethyl	5-40	400-600	1-2	1500	1500	35*	55*	900*	1000*
<b>CA50 Gel</b>	A high-viscosity gel consistency CA for many applications needing non-sag properties. Less sensitive to acidic surfaces.	ethyl	60-120	45,000-85,000	1-2	2000	900	105*	130*	850*	690*
<b>CA100</b>	Toughened material that provides high peel and impact strength, thermal shock resistance and improved heat resistance.	ethyl	20-70	2500-4500	15	2000	2900	95*	120*	600*	710*
<b>Surface Activator</b>	A clear, colorless, organic-based liquid. Bottle comes with brush in lid and spray pump	Helps speed curing and primes surfaces.									

(1) The time it takes assembled parts to reach a strength where further handling and processing can take place. Times will depend surface to be bonded, temperature and humidity.

(2) Tested per ASTM D 1876-61T. (3) Tested per ASTM D 1002-64. \* Substrate failure.

Note: The technical information and data on these pages should be considered representative or typical only, and should not be used for specification purposes.

## 3M™ Assembly Adhesives

*continued*

### 3M™ Jet-melt™ Adhesives



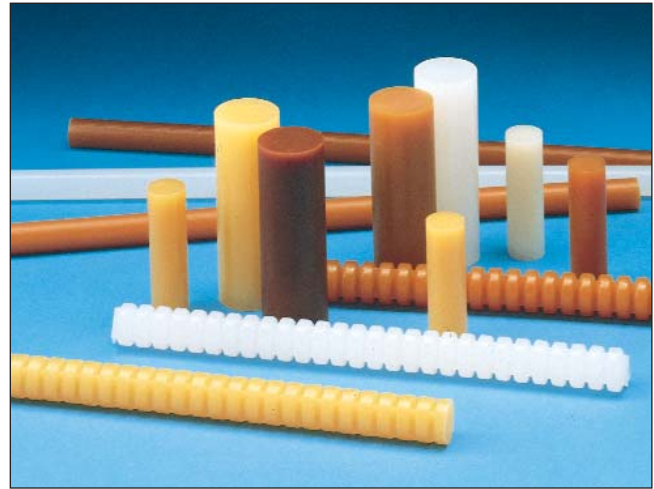



- 100% solid, solvent free thermoplastic resins
- Assemblies can be moved immediately
- No space or energy consumed for drying
- Also available in low temperature applied versions
- Reaches handling strength in seconds
- Applied through 3M™ Polygun™ Applicators



Description	Features	Size	UPC Number	Lbs./Case
<b>3738</b> Tan applied at 350-375°F	High delivery rate and long bonding range. General purpose for wood bonding, corrugated selected plastics and chipboard.	5/8" x 8" Q	021200-65262-2	11
		1" x 3" PG	021200-82609-2	22
		5/8" x 2" TC	021200-82610-8	11
		1/2" x 12" AE	021200-82594-1	11
<b>3747</b> Tan applied at 350-375°F	Excellent hot melt adhesive for bonding wood when heat resistant bonds are required. Offers good impact resistance and flexibility. Bonds good on MDF.	5/8" x 8" Q	021200-82561-3	11
		1" x 3" PG	021200-82221-6	22
		5/8" x 2" TC	021200-82560-6	11
		1/2" x 12" AE	021200-82220-9	11
<b>3750</b> Tan applied at 350-375°F	General purpose adhesive with high flow rate for increased production.	1/2" x 12" AE	021200-96269-1	11
<b>3762</b> Tan applied at 350-375°F	Excellent "hot tack," fast-setting. Bonds to a variety of corrugated packaging, beadboard. Economical, general purpose. Can bond chipboard and wood.	5/8" x 8" Q	021200-65261-5	11
		1" x 3" PG	021200-82614-6	22
		5/8" x 2" TC	021200-82615-3	11
		1/2" x 12" AE	021200-82596-5	11
<b>3762LM</b> Lt. Amber applied at 265°F	Low temperature (265° F/129°C) applied version of 3762.	5/8" x 8" Q 1" x 3" PG 5/8" x 2" TC	021200-49125-2 021200-49128-3 021200-49134-4	11 22 11
<b>3764</b> Clear applied at 350-375°F	Bonds to a variety of plastics including polycarbonate, polyethylene and polypropylene. Flexible at low temperatures.	5/8" x 8" Q	021200-76054-9	11
		1" x 3" PG	021200-82598-9	22
		5/8" x 2" TC	021200-82599-6	11
		1/2" x 12" AE	021200-82597-2	11
<b>3792</b> Clear applied at 350-375°F	Clear, multi-purpose product for wood, corrugated, and lightweight substrates. Can bond fabric.	5/8" x 8" Q	021200-65263-9	11
		1" x 3" PG	021200-82606-1	22
		5/8" x 2" TC	021200-82589-7	11
		1/2" x 12" AE	021200-82583-5	11
<b>3792LM</b> Clear applied at 265°F	Low temperature (265° F/129°C) applied version of 3792.	5/8" x 8" Q	021200-82454-8	11
		1" x 3" PG	021200-83491-2	22
		5/8" x 2" TC	021200-82456-2	11

# 3M™ Assembly Adhesives

## Equipment

	Description	Adhesive Type/ Cartridge Style	UPC Number	Features
	Polygon™ AE II	AE	021200-96594-4	All electric. Designed for low to medium volume industrial applications. Triggered operated.
	Polygon™ TC	TC	021200-82244-5	Designed for standard Jet-melt™ Adhesives. Thumb controlled dispensing.
	Polygon™ LT	LM TC	021200-82245-2	For use with low temperature (265° F/129°C) applied adhesives. Thumb controlled dispensing.
	Polygon™ TC with Quadrack Converter and Palm Trigger	Q	021200-89445-9	Easy to use, simple and rugged construction. Designed for standard melt Jet-melt adhesive. Palm trigger design for dispensing of longer sticks.
	Polygon™ LT with Quadrack Converter and Palm Trigger	LM Q	021200-89447-3	Easy to use, simple and rugged construction. Designed exclusively for low melt Jet-melt adhesives. Palm trigger design for dispensing of longer sticks.
	Polygon™ EC	Q and LMQ	021200-89519-7	Multiple temperature. Uses pre-set temperature modules to operate with most 3M Jet-melt adhesives – both standard and low-melt. Stroke adjuster allows for repeatable output quantities. Palm trigger design and on-off switch.

### YOUR 3M SOLUTIONS HOTLINES:

3M can provide additional products and accessories to meet your needs.

Please contact us in any of the following ways that you prefer:

- 3M distributor or 3M sales representative in your area
- 3M Customer Response Center **1-866-279-1235**
- 3M Custom Woodworking and Cabinet Shop Website [www.3M.com/woodworking-catalog](http://www.3M.com/woodworking-catalog)

# 3M™ Structural Assembly Adhesives

## 3M™ Scotch-Weld™ Polyurethane Reactive Adhesives

- 100% solids, single component
- Moisture curing urethane
- Eliminates metering, mixing and curing
- Low VOC – no drying equipment
- 10 fl. oz. cartridges

Description	Open Time (min.)	UPC Number	Conts. Per Case
TE015	1.5	021200-39210-8	6
TE030	1.0	021200-82486-9	6
TE031	2.0	021200-83694-7	6
TE100	2.0	021200-87243-3	6
TS115 HGS	10.0	021200-89449-7	6
TE200	4.0	021200-89586-9	6
TS230	4.0	021200-83643-5	6

### Selector Guide

for bonding wood to	Shorter open time (1-2 min)	Longer open time (2-10 min)
Unfinished wood	TE015 TE030	TE100 TE200
Varnished, painted, stained or lacquered wood	TE031	TS230
Plastics (except polypropylene and polyethylene)	TE031	TS230
Solid surfaces	TE031	TS230
Fabric or leather	TE015 TE030 TE031	TE100 TE200
Most substrates when high green strength is required	n/a	TS115HGS



### Equipment

#### 3M™ Scotch-Weld™ Polyurethane Reactive Adhesive Applicator, Preheater & Accessories

- For improved productivity
- Holds up to four 10 fl. oz. cartridges
- 12 month warranty



Description	UPC Number	Per Case
Applicator	021200-89463-3	1
Preheater	021200-89464-0	1

- Optional tips are available for various outputs and specific applications



Description	UPC Number	Tips/Pack
Tip Cap	021200-87194-8	3
.72" Extension Tip (1.25")	021200-89471-8	3
.062" Low Flow Tip	021200-89472-5	3
.125" High Flow Tip	021200-89473-2	3
.090" Standard Tip	021200-87191-7	3



# Tapes and Masking Systems

## Masking Tapes

Scotch® Box Sealing Tapes

Scotch® Box Sealing Tape Dispensers

Scotch® Box Sealing Accessories

Scotch® Pallet Wrap Tapes

Scotch® Filament Tapes

Scotch® Filament and Stretchable Tape Dispensers

3M™ Duct Tapes

3M™ Hand-Masker™ Masking Systems

## Masking Tapes

### High Performance



#### Scotch® Performance Masking Tape 233+

A high performance crepe paper masking tape for most paint masking applications.

- Excellent transfer resistance to “difficult to remove from” surfaces
- Better than conventional masking tapes for sunlight resistance. It is still advised that it not be subjected to outdoor exposure or prolonged periods of sunlight. The tape may become difficult to remove.
- Found to remove cleanly at bake temperatures up to 250°F (121°C) for 30 minutes

UPC Number	Size	Rolls Per Case
051131-26334-5	18mm x 55 m	48
051131-26336-9	24mm x 55 m	24
051131-26338-3	36mm x 55 m	16
051131-26340-6	48mm x 55 m	12
051131-26341-3	72mm x 55 m	8

## Masking Tapes

### General Use



#### 3M™ Masking Tape 2307

A general purpose masking tape for holding, bundling, sealing, general paint masking and a vast number of other jobs where a pressure-sensitive tape is needed.

- Typically used at room temperature, but will function up to 200°F (93°C) for up to one hour
- Should not be subjected to outdoor exposure. Tape may become very difficult to remove.

UPC Number	Size	Rolls Per Case
021200-71117-6	18 mm x 55 m	48
021200-71118-3	24 mm x 55 m	36
021200-71119-0	36 mm x 55 m	24
021200-71120-6	48 mm x 55 m	24

#### YOUR 3M SOLUTIONS HOTLINES:

3M can provide additional products and accessories to meet your needs.

Please contact us in any of the following ways that you prefer:

- 3M distributor or 3M sales representative in your area
- 3M Customer Response Center **1-866-279-1235**
- 3M Custom Woodworking and Cabinet Shop Website [www.3M.com/woodworking-catalog](http://www.3M.com/woodworking-catalog)



## Masking Tapes

### General Use - continued

#### Tartan™ Masking Tape 200

A utility purpose paper tape for holding, bundling, sealing, non-critical masking and a vast number of other jobs where a pressure-sensitive tape is needed.

- Typically used at room temperature, but will function up to 200°F (93°C) for periods up to 1/2 hour
- Good holding power to help resist lifting or curling
- Should not be subjected to outdoor or UV exposure



UPC Number	Size	Rolls Per Case
021200-71180-0	24 mm x 55 m	36
021200-71179-4	36 mm x 55 m	24
021200-71177-0	48 mm x 55 m	24

#### 3M™ Paper Masking Tape 2214

A general purpose paper tape for holding, bundling, sealing, non-critical masking and a vast number of other jobs where a pressure-sensitive tape is needed.

- Typically used at room temperature but will function up to 150°F (66°C) for periods up to 30 minutes. Should not be subject to outdoor exposure.
- Resists lifting or curling/helps reduce rework
- Resists slivering, yet hand tearable



UPC Number	Size	Rolls Per Case
021200-26074-2	18 mm x 55 m	48
021200-26075-9	24 mm x 55 m	36
021200-26076-6	36 mm x 55 m	24
021200-26077-3	48 mm x 55 m	24

## Masking Tapes

### Specialty Masking

#### Scotch-Blue™ Painters' Tape for Multi-Surfaces 2090

- Ideal for painted walls and trim, woodwork, glass and metal
- 14-day clean removal
- For interior and exterior use
- UV and sunlight-resistant
- Medium adhesion
- Flexible crepe backing for exceptional conformability



UPC Number	Size	Rolls Per Case
051115-06817-1	3/4" x 60 yds.	48
051115-06818-8	1" x 60 yds.	36
051115-06819-5	1 1/2" x 60 yds.	24
051115-06820-1	2" x 60 yds.	24

# Masking Tapes

## Specialty Masking

### Scotch® Masking Tape for General Painting 2050

- Ideal for window, door and wall trim, cabinets, carpet, and vinyl flooring.
- 3-day clean removal
- For interior and exterior use
- Medium-High adhesion



UPC Number	Size	Rolls Per Case
021200-05617-8	.70" x 60 yds.	48
021200-05618-5	.94" x 60 yds.	36
021200-05619-2	1.41" x 60 yds.	24
021200-05620-8	2" x 60 yds.	24
021200-05621-5	3" x 60 yds.	12

### Scotch® Fine Line Masking Tape 218

A high-performance film backed tape with low profile and high adhesion to achieve excellent paint lines and for other masking and holding applications.



- Will give excellent color line separation due to its thinness.
- The specially processed film backing stretches easily for smooth curves, yet can be easily torn by hand with a quick tearing action
- The specially processed film backing will allow taping over fresh paint jobs sooner than paper tapes with less chance of imprint damage
- Has excellent moisture and solvent resistance

UPC Number	Size	Rolls Per Case
021200-04700-8	1" x 60 yds.	36
021200-04701-5	2" x 60 yds.	24

### Scotch® Solvent-Resistant Masking Tape 2040

A high performance, general purpose masking tape for new construction or when repainting.

- Functions satisfactorily during bake cycles at 250°F (121°C) for up to one hour
- Used throughout the construction industry for critical masking and a vast number of other jobs where a general purpose, pressure-sensitive tape is needed
- Should not be subjected to outdoor exposure or to prolonged periods of sunlight exposure



UPC Number	Size	Rolls Per Case
021200-02992-9	24mm x 55m.	36
021200-02993-6	36mm x 55m.	24
021200-04365-9	48mm x 55m.	24

### Scotch® Masking Tape for Hard-to-Stick Surfaces 2060

A tape to mask lacquer paints from surfaces and to mask lacquered surfaces from other types of paints and lacquers.



- Removes with little or no adhesive transfer to most surfaces for up to three days after application, even when subjected to sunlight exposure; tape should be removed at a 90° angle
- Resists curl off when coated with paints and lacquers
- Resists paint and lacquer flaking when the tape is removed from the job
- Typically used at room temperature, but will function up to 200°F (93°C) for one hour
- Should not be exposed to prolonged outdoor exposure; tape may become difficult to remove

UPC Number	Size	Rolls Per Case
021200-71131-2	18mm x 55m	48
021200-71132-9	24mm x 55m	36
021200-71133-6	36mm x 55m	24
021200-71134-3	48mm x 55m	24

# Box Sealing Tapes

## Scotch® Box Sealing Tape 375

- Biaxially-oriented polypropylene backing
- Pressure-sensitive hot melt synthetic rubber resin adhesive
- Adheres to most surfaces, even to cartons with high recycled content. Works well on double and triple wall corrugated, heavy cartons with high-value contents, overpacked and underpacked cartons. Available in tan or clear.

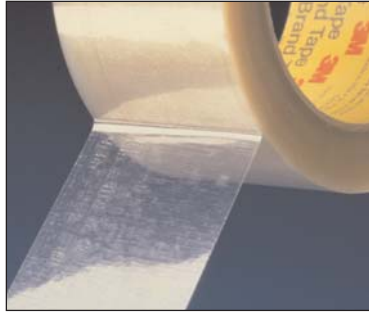

Adhesion to Steel (per inch of width)	Tensile Strength (per inch of width)	Total Thickness	Elongation at Break	Holding Power To Fiberboard
55 oz./in. (60N/100mm)	Longitudinal: 35 lb./in. (613N/100mm) Transverse: 70 lb./in. (1226N/100mm)	3.1 mil (0.079mm)	160%	12,000+ min.

UPC Number	Size (Metric)	Color	Rolls Per Case
021200-72406-0	48mm x 50m	Clear	36
021200-72407-7	72mm x 50m	Clear	24
021200-72401-5	48mm x 50m	Tan	36
021200-72402-2	72mm x 50m	Tan	24

## Scotch® Box Sealing Tape 371

- Biaxially-oriented polypropylene film backing
- Pressure-sensitive hot melt synthetic rubber resin adhesive
- Dependable performance on single wall, low burst strength RSCs with medium weight contents. Available in tan and clear.



Adhesion to Steel (per inch of width)	Tensile Strength (per inch of width)	Total Thickness	Elongation at Break	Holding Power To Fiberboard
40 oz./in. (44N/100mm)	Longitudinal: 22 lb./in. (385N/100mm) Transverse: 44 lb./in. (771N/100mm)	1.9 mil (0.048mm)	160%	3,500+ min.

UPC Number	Size (Metric)	Color	Rolls Per Case
021200-13679-5	48mm x 50m	Clear	36
021200-15873-5	48mm x 100m	Clear	36
021200-19280-7	72mm x 100m	Clear	24
021200-15872-8	48mm x 100m	Tan	36

# Box Sealing Tape Dispensers

## Scotch® Box Sealing Tape Dispenser H122

- Lightweight, compact, hand-held dispenser
- Built-in brake allows for tighter, more precise seals
- Made of high-impact plastic
- Use with tape up to 2" wide on 3" core



UPC Number	Dispensers Per Case
021200-06925-3	6

## Scotch® Box Sealing Tape Dispenser H128

- Accommodates up to 2" width of Box Sealing Tapes
- For package sealing/closing operations
- Steel construction



UPC Number	Dispensers Per Case
021200-06909-3	6

## Box Sealing Accessories

### Scotch® Pouch Tape 8240

- Use to attach and protect packing lists, shipping documents, promotional items, small parts or assembly instructions
- See-through window allows for easy identification of contents



UPC Number	Pouch Size	Pouches/ Roll	Rolls/ Case
021200-06947-5	5" x 6"	500	8

### Scotch® Pouch Tape Dispenser M727

- Dispenses Scotch® Pouch Tape 8240 and general use tapes up to 5" wide
- All metal construction that can be secured to a table, wall mounted or added to a weighted base for stability



UPC Number	Dispensers Per Case
021200-06944-4	6

## Pallet Wrap Tapes

### Scotch® Stretchable Tape 8886

- High performance tape with a clear polyethylene backing
- Use for bundling and unitizing pallets
- When optimally stretched the tape can be easily and cleanly removed by hand, without damage to boxes or graphics
- Can be recycled with low density polyethylene (LDPE) films
- Provides premium performance for pallet unitizing applications



UPC Number	Size	Rolls Per Case
021200-69314-4	36mm x 55 m	24

## Scotch® Filament Tapes

### Scotch® Filament Tape 897

- Translucent polypropylene film backed product reinforced with glass yarn filaments
- Light-duty tensile strength, nick resistance, abrasion resistance and good handling for utility applications
- Suitable for bundling and reinforcing and pallet unitizing applications



UPC Number	Size	Rolls Per Case
021200-86522-0	9 mm x 55 m	96
021200-86524-4	18 mm x 55 m	48
021200-39510-9	36 mm x 55 m	24
021200-86526-8	48 mm x 55 m	24

## Filament and Stretchable Tape Dispensers

### Scotch® Filament Tape Hand Dispenser H10

- Accommodates up to 1" (24mm) widths of filament tapes

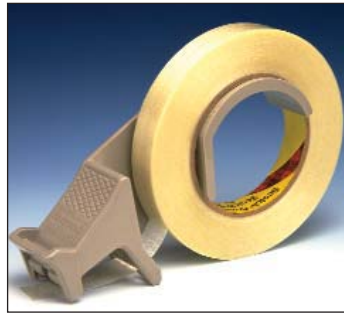

UPC Number	Dispensers Per Case
021200-06910-9	6

### Scotch® Stretchable Tape Hand Dispenser H38

- Accommodates up to 36mm (1 1/2") width of Scotch® 8886 stretchable tape
- Light weight, ergonomically friendly
- High impact plastic for easy use when bundling
- Hand break control for stretching tape



UPC Number	Dispensers Per Case
021200-73217-1	6

## Duct Tapes

### 3M™ Duct Tape 3900

- A general purpose cloth duct tape
- Offers strong tack, good adhesion and conformability
- Features include straight, easy tear rolls and low tack edges
- Ideal for general maintenance, wrapping, holding and color coding applications
- Meets UL-723, HUD and BOCA Codes
- Tensile strength 21 lbs./in.



UPC Number	Size	Color	Rolls Per Case
051131-06976-8	48mm x 54.8m	Silver	24
021200-49831-7	48mm x 54.8m	Olive	24
021200-49832-4	48mm x 54.8m	Blue	24
021200-49833-1	48mm x 54.8m	Black	24
021200-49828-7	48mm x 54.8m	Yellow	24
021200-49829-4	48mm x 54.8m	White	24

### 3M™ Duct Tape 3939

- A heavy duty cloth duct tape
- Strong backing, good adhesion, tears easily without curling, conformability and low tack edges
- Ideal for hanging poly, holding, patching, bundling, sealing and temporary repair
- Tensile strength 26 lbs./in.



UPC Number	Size	Color	Rolls Per Case
021200-85561-0	24mm x 54.8m	Silver	36
051131-06975-6	48mm x 54.8m	Silver	24
021200-85562-7	72mm x 54.8m	Silver	12
021200-85563-4	96mm x 54.8m	Silver	12

## Masking Systems

### 3M™ Hand-Masker™ M3000 Dispenser

- Applies masking tape to masking film or paper in one continuous application
- Compact and lightweight
- Saves time when preparing for painting, staining or spray applications



Description	UPC Number	Qty./Case
M3000	051131-77385-1	6

### 3M™ Hand-Masker™ Pre-Folded Masking Film++

- Specially formulated to resist paint flaking during the application of multiple coats
- Static cling holds film to surface while taping and during spray applications
- Film easily unfolds to cover small to large areas such as windows, cabinets, doors and even floor-to-ceiling applications



Description	Size	UPC Number	Qty./Case
MF24++	24" x 180'	051131-06845-2	12
MF48++	48" x 180'	051131-06848-3	12
MF72++	72" x 100'	051131-77406-3	12
MF99++	99" x 100'	051131-77407-0	9

### 3M™ Hand-Masker™ Pre-Taped Drop Cloth Dispenser

Description	Size	UPC Number	Qty./Case
PTD2090-24	24" x 30 yds.	051115-07997-9	12

### Premium Quality Masking Paper



Description UPC Number	Size Qty./Case
---------------------------	-------------------

MP3	3" x 60 yds.	051131-77401-8	12
MP6	6" x 60 yds.	051131-77402-5	12
MP9	9" x 60 yds.	051131-77403-2	12
MP15	15" x 60 yds.	051131-77400-1	12

### 3M™ Hand-Masker™ Pre-Taped Drop Cloth (with 3M™ Long-Mask™ Masking Tape 2090)



Description UPC Number	Size Qty./Case
---------------------------	-------------------

PT2090-24	24" x 25 yds.	051131-06696-0	12
-----------	---------------	----------------	----

### Masking Film Cutoff Blade

Description	Size	UPC Number	Qty./Case
FB12	12"	051131-06802-5	6

### Masking Paper Cutoff Blade

Description	Size	UPC Number	Qty./Case
CB12	12"	051131-06796-7	6
CB15	15"	051131-06797-4	6



## Protective Products

3M™ Bumpon™ Protective Products

3M™ Protective Tapes

3M™ Aluminum Foil Tape

## 3M™ Bumpon™ Protective Products

**Use almost anywhere slamming, scratching, nicking, scuffing, marring, sliding, vibration, or noise could be a problem for your product.**

- Feet on the bottom of electronic cabinetry, scales, clocks, speakers, dispensers, and computers
- Stops for cabinet doors, lids, and drawers
- Spacers for picture frames to provide alignment
- Protectors for stacked glass and wood panels

**3M™ Bumpon™ Protective Products feature a plasticizer-free urethane composition which exhibits:**

- Excellent skid resistance
- Long aging resiliency – will not crack or harden
- Alternative to mechanical fasteners
- Resistance to marring, staining and abrasion

### 3M™ Bumpon™ Protective Product Blister Packs

- Individually packaged adhesive bumpers for use as stops and spacers



Cat. Number	Size/Color	UPC Number	Qty./Case
SJ5012	Ht. .140"; Width .50" Cylindrical, Black	048011-53532-6	1,008 (56 per pad)
SJ5018	Ht. .230"; Width .50" Tapered Square, Black	048011-53536-4	1,440 (80 per pad)
SJ5201	Ht. .125"; Width .433" Hexagon, Lt. Brown	048011-53537-1	2,376 (132 per pad)
SJ5302	Ht. .085"; Width .312" Hemisphere, Transparent	048011-53535-7	1,728 (96 per pad)
SJ5312	Ht. .140"; Width .50" Cylindrical, Transparent	048011-53534-0	1,008 (56 per pad)
SJ5412	Ht. .140"; Width .50" Cylindrical, True White	048011-53533-3	1,008 (56 per pad)
SJ6553 Quiet Clear	Ht. .120"; Length .433" Hexagonal cone, Clear	048011-53538-8	2,376 (132 per pad)

### YOUR 3M SOLUTIONS HOTLINES:

*3M can provide additional products and accessories to meet your needs.*

*Please contact us in any of the following ways that you prefer:*

- 3M distributor or 3M sales representative in your area
- 3M Customer Response Center **1-866-279-1235**
- 3M Custom Woodworking and Cabinet Shop Website [www.3M.com/woodworking-catalog](http://www.3M.com/woodworking-catalog)



# 3M™ Bumpon™ Protective Products

*continued*

## 3M™ Bumpon™ Quiet Clear Protective Products

- Designed to provide optimum sound damping for cabinetry while blending in with any decor
- Sticks and stays in position



Cat. Number	Size/Color	UPC Number	Qty. /Case
<b>SJ6512</b>	Ht. .14"; Dia. .50" Cylindrical Soft, Quiet Clear	021200-45773-9	5,000
<b>SJ6506</b>	Ht. .15"; Width .375" Hemisphere Soft, Quiet Clear	021200-45774-6	5,000
<b>SJ6553</b>	Ht. .12"; Length .433" Hexagonal Cone Soft, Quiet Clear	021200-45043-3	5,000
<b>SJ6561</b>	Ht. .15"; Length .433" Hexagonal Hemisphere Soft, Quiet Clear	021200-45764-7	5,000

## Cylindrical



Cat. Number	Size/Color	UPC Number	Qty. /Case
<b>SJ5312</b>	Ht. .14"; Dia. .50" Crystal Clear	021200-19217-3	3,000

## Hemisphere



Cat. Number	Size/Color	UPC Number	Qty. /Case
<b>SJ5302</b>	Ht. .085"; Dia. .312" Crystal Clear	021200-40230-2	3,000

## Hemisphere



Cat. Number	Size/Color	UPC Number	Qty. /Case
<b>SJ5306</b>	Ht. .15"; Dia. .375" Crystal Clear	021200-67560-7	3,000

# 3M™ Protective Tapes

When choosing a protective tape, consider your specific application requirements, especially:

- Type of surface to protect
- Abrasive resistance/film thickness requirements
- Adhesion Level/tack requirements – which can be affected by the presence of dust or debris from sanding or polishing

## Selector Guide

	Starting Point	Higher Tack
Solid Surfaces	2A25 25A25	2A26 25A26
High Pressure Laminates – High Gloss	2A10	25A25
High Pressure Laminates – Matte / Wood Grain	2A88 25A88	n/a
Raw or Unfinished Wood	25A88 3188	n/a
Wood Paneling / Parquet Flooring	2A26 25A26	2A29 25A29
Painted / Lacquered Surfaces	In order to prevent imprinting on finished surface, samples should be evaluated by Polymask Corporation* to verify compatibility between adhesive system and paint/lacquer used.	



## Ordering Information

3M Protective Tapes are custom ordered products. Please contact your local 3M Authorized distributor or your 3M Sales Specialist for ordering information. Minimum order is \$500, not assortable.

## Tape Number Identification Guide

### Film Thickness

2 = 2 mil  
2.5 = 2.5 mil  
3 = 3 mil

### Adhesive Type

10 = Very Low Tack  
25, 26, 29 = Moderate Tack  
88 = High Tack

**2 5 A 2 5**

### Film Type

1 = Low density polyethylene (LDPE)  
A = Co-extruded polyethylene

**NOTE:** In most cases tapes can be machine applied or hand applied. If tape is applied by hand, a more aggressive adhesive may be necessary. Additional Protective Tape products are also available. For assistance in choosing the right tape for your application, contact PolyMask Corporation\* technical service at 1-800-624-4772 ext 133 or 153.

\* Polymask Corporation is a joint venture of 3M and Sealed Air Corporation and is marketed and sold by 3M.

## 3M™ Foil Tapes



### 3M™ Aluminum Foil Tape 425

- Use when installing countertops in areas where heat resistance is important, such as around stoves
- Moisture and chemical resistant
- Thermally conductive
- Heat and light reflective
- Flame resistant\*
- Outdoor weatherable
- Vibration damping

UPC Number	Size	Rolls Per Case
021200-60572-7	1" x 60 yds.	36
021200-60574-1	2" x 60 yds.	24
021200-60597-0	3" x 60 yds.	12

\*Meets U.L. 746C (File E 122798) and 723, Class "L" low flammability rating (File R 7311).

### YOUR 3M SOLUTIONS HOTLINES:

*3M can provide additional products and accessories to meet your needs.*

*Please contact us in any of the following ways that you prefer:*

- 3M distributor or 3M sales representative in your area
- 3M Customer Response Center **1-866-279-1235**
- 3M Custom Woodworking and Cabinet Shop Website [www.3M.com/woodworking-catalog](http://www.3M.com/woodworking-catalog)



## Safety Products

3M™ Particulate Respirators

Respirator Selection Guide

3M™ Filtering Facepiece Respirators

3M™ Half Facepiece Respirators

3M™ Filters and Retainers, 5000/6000 Series

3M™ Cartridges/Combination Cartridges/  
P100 Particulate Filters 6000 Series

3M™ Particulate Filters 2000 Series

3M™ Replacement Parts and Accessories 7500 Series

3M™ Air Monitors

3M™ Health and Safety Services

3M™ Hearing Protection

3M™ Eye Protection

3M™ Maintenance Sorbents

3M™ Matting

# 3M™ Particulate Respirators



## Cool Flow™ Exhalation Valve.

Patented one-way valve for easy exhalation and cool, dry comfort.



## M-noseclip.

Adjusts easily for fewer pressure points and greater comfort.



## Face seal.

Soft and secure conforms closely to face for long-lasting comfort.



## Patented Filter Media.

Advanced electrostatically charged microfibers help make breathing easier and cooler.

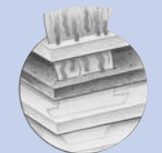

## Carbon filter material.

Carbon layers remove many nuisance level odors for greater wearer comfort.

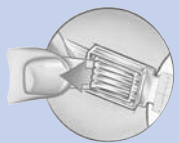

## Adjustable buckle straps.

A single tug helps provide a comfortable, secure fit.

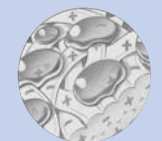

## P-series filter.

Featuring Advanced Electret Media, appropriate for prolonged use in both oil and non-oil containing environments.



## Compatibility.

Accommodates a wide range of safety equipment, including eye and hearing protection.

## Technologies/Features

The 3M line of particulate respirators can help you meet the requirements of OSHA 1910.134. These filtering facepiece respirators have many features such as comfort, lightweight materials, some have adjustable straps, and all provide economical protection. Depending on your applications, you can select a respirator that offers the benefits and technologies that best meet your needs.

## Use Limitations

- These respirators do not supply oxygen. Do not use in atmospheres containing less than 19.5% oxygen
- Do not use when concentrations of contaminant's are immediately dangerous to life and health, are unknown, or are greater than 10 times the permissible exposure limit (PEL), or exceed specific OSHA standards or applicable government regulations, whichever is lower
- Do not alter, abuse or misuse these respirators
- Do not use with beards or other facial hair or other conditions that prevent a good seal between the face and the face seal (or edge) of the respirator
- N-Series filters cannot be used in environments containing oil  
R- and P-series can be used in oil and non-oil environments

## Time Use Limitations

### N-SERIES

If the respirator becomes damaged, soiled or breathing becomes difficult, leave the contaminated area immediately and dispose of the respirator.

### R-SERIES

1. If the respirator becomes damaged, soiled or breathing becomes difficult, leave the contaminated area immediately and dispose of the respirator
2. If oil aerosols are present, time use may be limited to 8 hours of continuous or intermittent use. Refer to NIOSH User's Guide, Pub. No. 96-101

### P-SERIES

1. If the respirator becomes damaged, soiled or breathing becomes difficult, leave the contaminated area immediately and dispose of the respirator
2. If used in environments containing only oily aerosols, dispose of respirator or change filters after 40 hours of use or 30 days, whichever is first

## ⚠ WARNING



These respirators help protect against certain particulates. **Misuse may result in sickness or death.**

For proper use, see supervisor, user instructions or call 3M OH&ESD Technical Service. In U.S. call 1-800-243-4630. In Canada, call 1-800-267-4414.

# Respirator Selection Guide

## Disposable Maintenance Free Respirators

## Reusable Elastomeric Facepiece Respirators

	 <p><b>6000</b>      <b>7500</b></p> <p>Either facepiece plus:</p>
<p><b>P100</b></p>	 <p><b>2091</b></p>
<p><b>P95</b></p>  <p><b>8577</b></p>	 <p><b>2071</b></p>
<p><b>N95</b></p>  <p><b>8000</b>      <b>8210</b>      <b>8210Plus</b></p> <p><b>8247 (R95)<sup>1</sup></b>      <b>8511</b>      <b>9210</b>      <b>9211</b></p>	<p><sup>1</sup> R95 Respirator. 3M recommended for relief against nuisance levels of organic vapors. Nuisance level organic vapor refers to concentrations not exceeding OSHA PEL or applicable exposure limits, whichever is lower.</p>

### ⚠ WARNING



These respirators help protect against certain particles. **Misuse may result in sickness or death.** For proper use, see supervisor, user instructions or call 3M OH&ESD Technical Service. In U.S. call 1-800-243-4630. In Canada, call 1-800-267-4414.

**Do not use for:**

Gases and vapors, asbestos or sandblasting. Organic vapors, including those present in paint spraying operations, when concentrations exceed the OSHA PEL, or applicable government regulations whichever is lower. Aerosol concentrations that exceed 10 times the OSHA PEL, or applicable government regulations, whichever is lower. This respirator does not supply oxygen.

# 3M™ Filtering Facepiece Respirators

## 3M N95 Particulate Respirator Feature Chart

This chart shows some of the different products and comfort features in 3M N95-approved filtering facepiece respirators. By offering multiple products with different comfort features, 3M makes it easy to select a respirator that meets your needs.

Cup Style Respirators								Three Panel Respirators	
8000	8210	8210Plus	8211	8247	8511	8577	Comfort Features	9211	9210
			X		X	X	Cool Flow Exhalation Valve	X	
			X		X	X	M-shaped Noseclip		
		X	X	X	X	X	Braided Straps		
				X		X	Carbon Filter Material		
							Individually Packaged	X	X
	X	X		X		X	Nose Foam	X	X
X	X	X	X	X	X	X	Noseclip	X	X
X	X	X	X	X	X	X	Two Straps	X	X
X	X	X	X	X	X	X	Patented Filter Media	X	X

**NOTE:** All products are NIOSH N95 approved and can be used for short, medium, or long duration tasks.

### 3M™ Particle Respirator 8000, N95

- Designed for light duty, short duration applications such as sweeping, sanding, woodworking and landscaping
- Two strap design with single point attachment helps provide a secure fit
- Lightweight construction enhances worker comfort and wear time
- Patented filter media with advanced electrostatically charged microfibers helps make breathing easier and cooler for enhanced user comfort
- Meets NIOSH 42 CFR 84 N95 requirements. TC-84A-3981



UPC Number	Quantity Per Box	Boxes Per Case
051131-52967-5	20	6

### 3M™ Particulate Respirator 8210, N95

- Recommended for grinding, sanding, sweeping, bagging, and woodworking
- Lightweight construction helps increase wear time
- All filter design
  - Provides economical protection
- Meets NIOSH 42 CFR 84 N95 requirements. TC-84A-007



UPC Number	Quantity Per Box	Boxes Per Case
051138-46457-3	20	8

#### ⚠ WARNING



These respirators help protect against certain particles. **Misuse may result in sickness or death.** For proper use, see supervisor, user instructions or call 3M OH&ESD Technical Service. In U.S. call 1-800-243-4630. In Canada, call 1-800-267-4414.

#### Do not use for:

Gases and vapors, asbestos or sandblasting. Organic vapors, including those present in paint spraying operations, when concentrations exceed the OSHA PEL, or applicable government regulations whichever is lower. Aerosol concentrations that exceed 10 times the OSHA PEL, or applicable government regulations, whichever is lower. This respirator does not supply oxygen.

## 3M™ Filtering Facepiece Respirators

*continued*

### 3M™ Particulate Respirator 8210Plus, N95



- Recommended for work settings that involve sanding, grinding and other dusty operations
- Durable braided comfort strap
  - Won't get tangled or pull on hair
  - Soft against skin
- Staple-free headband attachment
  - Comfortable in hot and cold environments
- Advanced electret charged microfibres make breathing easier and cooler, resulting in enhanced wearer comfort
- Adjustable nose clip helps create a custom fit and reduces the potential for eyewear fogging
- Soft nose foam is more comfortable on the face
- Multi-layer, durable construction contributes to increased wear time
- Meets NIOSH 42 CFR 84 N95 requirements. TC-84A-007

UPC Number	Quantity Per Box	Boxes Per Case
051131-52924-8	20	8

### 3M™ Particulate Respirator 8247, R95, with Nuisance Level Organic Vapor Relief\*



- Recommended for nuisance level organic vapor relief
- Lightweight construction
  - Promotes greater worker comfort
  - Contributes to increased wear time
- All filter design
  - Provides economical protection
  - Maintenance free
  - Promotes easier communication
- Meets NIOSH 42 CFR 84 R95 requirements. TC-84A-1350

UPC Number	Quantity Per Box	Boxes Per Case
051138-54358-2	20	6

\*3M recommended for relief against nuisance levels of organic vapors. Nuisance level organic vapor refers to concentrations not exceeding OSHA PEL or applicable exposure limits, whichever is lower.

### 3M™ Particulate Respirator 8211, N95



- Ideally suited for work settings that involve heat, humidity or long wear
- 3M™ Cool Flow™ Exhalation Valve is a patented one-way valve offering easy exhalation for cool, dry comfort
- Braided straps help provide comfort and durability
- Faceseal
  - Contours easily to help provide a good seal
- All filter design
  - Provides economical protection
  - Maintenance free
  - Promotes easier communication
- Adjustable M-noseclip
  - Helps provide a custom fit and secure seal
  - Reduces the potential for eyewear fogging
- Meets NIOSH 42CFR 84 N95 requirements. TC-84A-1299

UPC Number	Quantity Per Box	Boxes Per Case
051131-52750-3	10	8

### 3M™ Particulate Respirator 8511, N95



- Recommended for grinding, sanding, sweeping, bagging, and other dusty operations
- 3M™ Cool Flow™ Exhalation Valve is a patented one-way valve offering easy exhalation for cool, dry comfort
- M-noseclip
  - Adjusts easily with fewer pressure points and greater comfort
  - Reduces the potential for eyewear fogging
  - Helps provide a custom fit and secure seal
- Lightweight construction helps increase wear time
- All filter design
  - Provides economical protection
  - Maintenance free
  - Promotes easier communication
- Braided straps
  - Provide comfort and durability
- Meets NIOSH 42CFR 84 N95 requirements. TC-84A-1299

UPC Number	Quantity Per Box	Boxes Per Case
051138-54343-8	10	8



# 3M™ Filtering Facepiece Respirators

continued

## 3M™ Particulate Respirator 8577, P95, with Nuisance Level Organic Vapor Relief\*



- Recommended for nuisance level organic vapor relief\*
- 3M™ Cool Flow™ Exhalation Valve is a patented one-way valve offering easy exhalation for cool, dry comfort
- M-noseclip
  - Adjusts easily with fewer pressure points and greater comfort
  - Reduces the potential for eyewear fogging
  - Helps provide a custom fit and secure seal
- Lightweight construction contributes to increased wear time
- All filter design
  - Provides economical protection
  - Maintenance free
  - Promotes easier communication
- Braided straps
  - Provide comfort and durability
- Meets NIOSH 42 CFR 84 P95 requirements. TC-84A-1166

UPC Number	Quantity Per Box	Boxes Per Case
051138-54371-1	20	6

\*3M recommended for relief against nuisance levels of organic vapor. Nuisance level organic vapor refers to concentrations not exceeding OSHA PEL or applicable exposure limits, whichever is lower.



### ⚠ WARNING

These respirators help protect against certain particles. **Misuse may result in sickness or death.** For proper use, see supervisor, user instructions or call 3M OH&ESD Technical Service. In U.S. call 1-800-243-4630. In Canada, call 1-800-267-4414.

#### Do not use for:

Gases and vapors, asbestos or sandblasting. Organic vapors, including those present in paint spraying operations, when concentrations exceed the OSHA PEL, or applicable government regulations whichever is lower. Aerosol concentrations that exceed 10 times the OSHA PEL, or applicable government regulations, whichever is lower. This respirator does not supply oxygen.

## 3M™ Particulate Respirator 9210, N95



- Recommended for grinding, sanding, sweeping, bagging, and other dusty operations
- Three panel respirator with innovative design
  - Low profile for better visibility and compatibility with a wide range of safety equipment
  - Conforms to a wide range of face sizes
- Soft cover web on inner panel feels comfortable against skin
- Soft, conformable noseclip
  - Adjusts easily
  - Helps provide a custom fit and secure seal
- Lightweight, collapse-resistant design
- Individually packaged
- Meets NIOSH 42CFR 84 N95 requirements. TC-84A-2669

UPC Number	Quantity Per Box	Boxes Per Case
051131-37021-5	20	12

## 3M™ Particulate Respirator 9211, N95



- Recommended for grinding, sanding, sweeping, bagging, and other dusty operations
- Three-panel respirator with innovative design
  - Low profile for better visibility and compatibility with a wide range of safety equipment
  - Conforms to a wide range of face sizes
  - Center positioning allows the 3M™ Cool Flow™ Exhalation Valve to operate efficiently
- Soft cover web on inner panel feels comfortable against skin
- Soft, conformable noseclip
  - Adjusts easily
  - Helps provide a custom fit and secure seal
- Lightweight, collapse-resistant design
- Individually packaged
- Meets NIOSH 42CFR 84 N95 requirements. TC-84A-2668

UPC Number	Quantity Per Box	Boxes Per Case
051131-37022-2	10	12

## 3M™ Half Facepiece Respirators

### 3M™ Dual Cartridge Respirator Assembly 5XP71

- Disposable
- P95 Filter/organic vapor cartridge
- Available in 3 sizes (small, medium, large) to fit many faces
- Resealable storage bag helps keep respirator clean between uses
- Low profile design provides wider field of vision and greater comfort while wearing goggles or glasses



UPC Number	Part No.	Size	Quantity Per Case
051138-66068-5	51P71	Small	12
051138-66069-2	52P71	Medium	12
051138-66070-8	53P71	Large	12

### 3M™ Half Facepiece Respirators 7501, 7502, 7503 Ultimate Reusable

- Advanced silicone material provides soft cushioning on face
- 3M™ Cool Flow™ Exhalation Valve is a patented one-way valve offering easy exhalation for cool, dry comfort
- Interchangeable filters enable wearer to match the filter with the application
- Use 3M™ Cartridge 6001 for painting, staining, varnishing



UPC Number	Part No.	Size	Quantity Per Bag	Bags Per Case
051131-37081-9	7501	Small	1	10
051131-37082-6	7502	Medium	1	10
051131-37083-3	7503	Large	1	10

### 👉 YOUR 3M SOLUTIONS HOTLINES:

3M can provide additional products and accessories to meet your needs. Please contact us in any of the following ways that you prefer:

- 3M distributor or 3M sales representative in your area
- 3M Customer Response Center **1-866-279-1235**
- 3M Custom Woodworking and Cabinet Shop Website [www.3M.com/woodworking-catalog](http://www.3M.com/woodworking-catalog)

### ⚠️ WARNING



These respirators help protect against certain particles. **Misuse may result in sickness or death.** For proper use, see supervisor, user instructions or call 3M OH&ESD Technical Service. In U.S. call 1-800-243-4630. In Canada, call 1-800-267-4414.

#### Do not use for:

Gases and vapors, asbestos or sandblasting. Organic vapors, including those present in paint spraying operations, when concentrations exceed the OSHA PEL, or applicable government regulations whichever is lower. Aerosol concentrations that exceed 10 times the OSHA PEL, or applicable government regulations, whichever is lower. This respirator does not supply oxygen.

# 3M™ Filters and Retainers, 5000/6000 Series

## 3M™ Particulate Filter 5N11, N95

- NIOSH certified as having at least 95% filtration efficiency against solid and liquid particles (excluding those containing oil)
- Replacement filter for 3M Half Facepiece Respirators 5000, 6000 and 7000 Series
- Use with 3M™ Filter Retainer 501



UPC Number	Quantity Per Box	Boxes Per Case
051138-46464-1	10	10

## 3M™ Filter Retainer 501

- For use on 3M™ Half Facepiece Respirators 5000, 6000 and 7000 Series with the 3M™ Particulate Filters 5N11 and 5P71 Filters



UPC Number	Quantity Per Box	Boxes Per Case
051138-17668-1	20	5

## 3M™ Particulate Filter 5P71, P95

- NIOSH certified as having at least 95% filtration efficiency against solid and liquid particles (including those containing oil)
- Use on 3M™ Half Facepiece Respirators 5000, 6000, and 7000 Series
- Use with 3M™ Filter Retainer 501



UPC Number	Quantity Per Box	Boxes Per Case
051131-07194-5	10	10

### ⚠ WARNING



These respirators help protect against certain particles. **Misuse may result in sickness or death.** For proper use, see supervisor, user instructions or call 3M OH&ESD Technical Service. In U.S. call 1-800-243-4630. In Canada, call 1-800-267-4414.

**Do not use for:**

Gases and vapors, asbestos or sandblasting. Organic vapors, including those present in paint spraying operations, when concentrations exceed the OSHA PEL, or applicable government regulations whichever is lower. Aerosol concentrations that exceed 10 times the OSHA PEL, or applicable government regulations, whichever is lower. This respirator does not supply oxygen.

## 3M™ Cartridges/Combination Cartridges/ P100 Particulate Filters 6000 Series

### 3M™ Organic Vapor Cartridge 6001

- For use on 3M™ Half and Full Facepiece 6000 and 7000 Series with bayonet attachments
- NIOSH approved against organic vapors
- Low profile design helps maintain good field of vision



UPC Number	Quantity Per Pouch	Quantity Per Case
051138-21674-5	2	60

### 3M™ Formaldehyde/Organic Vapor Cartridge 6005

- For use on 3M™ Half and Full Facepiece 6000 and 7000 Series with bayonet attachments
- NIOSH approved against formaldehyde and certain organic vapors
- Low profile design helps maintain good field of vision



UPC Number	Quantity Per Pouch	Quantity Per Case
051138-28883-4	2	60

### 3M™ Cartridge/Filter 60926 Multi Gas/Vapor/P100

- For use on 3M™ Half and Full Facepiece 6000 and 7000 Series with bayonet attachments
- NIOSH approved against certain organic vapors, acid gases, ammonia, methylamine, formaldehyde, hydrogen fluoride and particulates



UPC Number	Quantity Per Pouch	Quantity Per Case
051138-54187-8	2	60

### 3M™ Multi Gas/Vapor Cartridge 6006

- For use on 3M™ Half and Full Facepiece 6000 and 7000 Series with bayonet attachments
- NIOSH approved against certain organic vapors, chlorine, hydrogen chloride, chlorine dioxide, sulfur dioxide, hydrogen sulfide (escape only), ammonia, methylamine, formaldehyde and hydrogen fluoride
- Low profile design helps maintain good field of vision



UPC Number	Quantity Per Pouch	Quantity Per Case
051138-54186-1	2	60

### 3M™ Respirator Cleaning Wipes 504

- Individually wrapped towelettes
- Alcohol free formula will not damage facepiece materials
- Pleasant fragrance
- Oversized 8-1/2" x 11" – ideal for cleaning full facepiece respirators
- Convenient dispenser box



UPC Number	Quantity Per Box	Boxes Per Case
051131-07065-8	100	5

#### ⚠ WARNING



These respirators help protect against certain particles. **Misuse may result in sickness or death.** For proper use, see supervisor, user instructions or call 3M OH&ESD Technical Service. In U.S. call 1-800-243-4630. In Canada, call 1-800-267-4414.

#### Do not use for:

Gases and vapors, asbestos or sandblasting. Organic vapors, including those present in paint spraying operations, when concentrations exceed the OSHA PEL, or applicable government regulations whichever is lower. Aerosol concentrations that exceed 10 times the OSHA PEL, or applicable government regulations, whichever is lower. This respirator does not supply oxygen.

## 3M™ Particulate Filters 2000 Series

- Lightweight
- Low profile designed filter
- For use with 3M™ Half and Full Facepieces 5000, 6000 and 7000 Series with bayonet attachments
- NIOSH approved for environments containing certain oil and non-oil based particles

### 3M™ Particulate Filter 2071, P95

- P95 filter
- Low profile design



UPC Number	Quantity Per Bag	Quantity Per Case
051138-54356-8	2	100

### 3M™ Particulate Filter 2091, P100

- P100 approval
- NIOSH approved for environments containing certain oil and non-oil based particles



UPC Number	Quantity Per Bag	Quantity Per Case
051131-07000-9	2	100

#### ⚠ WARNING



These respirators help protect against certain particles. **Misuse may result in sickness or death.** For proper use, see supervisor, user instructions or call 3M OH&ESD Technical Service. In U.S. call 1-800-243-4630. In Canada, call 1-800-267-4414.

#### Do not use for:

Gases and vapors, asbestos or sandblasting. Organic vapors, including those present in paint spraying operations, when concentrations exceed the OSHA PEL, or applicable government regulations whichever is lower. Aerosol concentrations that exceed 10 times the OSHA PEL, or applicable government regulations, whichever is lower. This respirator does not supply oxygen.

## 3M™ Replacement Parts and Accessories 7500 Series

UPC Number	Model	Description	Qty/Case
051131-52753-4	7581	Head Harness Assembly	20
051131-52754-1	7582	Inhalation Valve	10
051131-52755-8	7583	Exhalation Valve	10
051131-52756-5	7586	Cartridge Filter Holder	20

## 3M™ Air Monitors

### 3M™ Organic Vapor Air Monitors 3500, 3510

The economical, accurate way to monitor your workplace

3M™ Air Monitors are simple and effective devices that collect certain airborne contaminants using the scientific principle of diffusion. They meet or exceed ±25% accuracy at a 95% confidence level for many workplace contaminants.

Note: Please see [www.3M.com/occsafety](http://www.3M.com/occsafety) for technical data bulletins on the monitors, the Organic Vapor Monitor Sampling and Analysis Guide and analysis methods.

- Single charcoal sorbent wafer for easy collection of organic vapors
- Sampling and analysis guide for over 125 vapors available
- **3510** – includes analysis for up to three compounds per monitor, selected from a list of more than 80 vapors



UPC Number	Quantity Per Box	Boxes Per Case
021200-13655-4	Organic Vapor Air Monitor 3500	10/case
021200-17309-2	Monitor 3510 with Prepaid Analysis	5/case
051138-46488-7	Organic Vapor Air Monitor 3500B, Bulk	50/case

## 3M™ Health and Safety Services

3M facilitates convenient, comprehensive tools to help you implement safety programs and achieve regulatory compliance. Our services are comprised of certain screening and OSHA regulatory compliance programs, as well as, web-enabled information management, and customized Respiratory Protection e-Tools to help optimize your compliance testing and training.

### e-Tools – [www.respexam.com](http://www.respexam.com)

3M's e-Tools are a resource for your company's health service needs. These e-Tools can be used to help effectively deliver and manage employee testing, training and records.

#### E-TOOLS INCLUDE:

- On-Line Respirator Medical Evaluations
- On-Line Respiratory Protection e-Training

#### ON-LINE RESPIRATOR MEDICAL EVALUATIONS

The OSHA Respiratory Protection Standard 29, CFR 1910.134, mandates that, among other things, employees required to use a respirator complete a medical evaluation successfully prior to wearing a respirator.

On-Line Respirator Medical Evaluations provide you with a low cost, convenient and easy to use method to help comply with regulations. 3M offers you:

#### **Convenience:**

- Respirator medical evaluation questionnaire for all brands and types of respirators
- Evaluations can be completed using any computer with Internet access— for On-Line Respirator Medical Evaluations, visit [www.respexam.com](http://www.respexam.com) or call 1-800-383-3393

#### **Speed and Productivity:**

- Most employees do not need to leave the work-site
- Employees and employers receive immediate notification of the results
- Clearance letters will be electronically mailed or faxed to the employer, and mailed to the employee

#### **Consistency and Quality:**

- All employees are evaluated using the same expanded OSHA Respirator Medical Evaluation Questionnaire
- Board-certified, occupational medicine physicians complete the reviews and, where needed, recommend further medical testing by the employee's physician

Order mail-in evaluations at [www.respexam.com](http://www.respexam.com)

#### ON-LINE RESPIRATORY PROTECTION TRAINING

The OSHA Respiratory Protection Standard 29, CFR 1910.134, mandates that, among other things, employees required to use a respirator be trained prior to initial use of a respirator, prior to use if a different respirator is assigned (size, style, make or model), and annually thereafter or whenever retraining is needed. 3M's On-Line Respiratory Protection e-Training is for certain 3M Respirator Products and includes:

- Interactive training designed to maximize learning
- Access to employee training records, test results and training curriculum, available on-line every day, any time
- Standardized training that meets OSHA, NIOSH and ANSI requirements

#### **On-Line Respiratory e-Training Services also might be used as:**

- Refresher training
- An alternate approach to respiratory training
- When management of employee respirator training records is desired
- New hire training

Order mail-in evaluations at [www.respexam.com](http://www.respexam.com)

## Audiometric Services

These services contribute information and data for your hearing conservation programs to keep employee exposures to hazardous noise levels, while helping you comply with increasingly stringent OSHA standards.

Here's how:

#### **Faster throughput:**

Mobile units are capable of testing 8 to 10 employees every 20 minutes

#### **Certified technicians:**

Each unit is staffed by CAOHC certified technicians

#### **Better technology:**

Mobile units with audiometers exceed all OSHA and ANSI standards

#### **Comprehensive reporting:**

Proprietary Oracle database helps test, analyze data and create custom reports

## 3M™ Health and Safety Services *continued*

### Regulatory Screening and Safety Compliance Services

Through a network of providers, 3M facilitates certain regulatory screening and safety compliance services.

On-site services can help improve productivity and your return on program investments by helping to reduce downtime resulting from off-site employee testing. 3M can facilitate comprehensive programs designed to help you meet regulatory requirements and internal safety goals, which can help contribute to your overall productivity and shape better business results.

OSHA Required Respirator Screening Provider utilizes mobile units and certified professionals with state-of-the-art equipment. Test scheduling can be customized to meet the demands of your organization.

#### SCREENING AND SAFETY COMPLIANCE SERVICES OFFERED:

- OSHA Required Respirator Medical Evaluations
  - Mail-In
  - On-Line
- Respirator Fit Testing
  - Qualitative/Quantitative
- Pulmonary Function Testing
- Hearing Conservation Management
  - Training
  - Notification
  - Testing
- Eye chart testing

#### OSHA Required Respirator Medical Evaluations

For respirator medical evaluations, call the 3M™ Occupational Health and Environmental Safety Division “Fax On Demand” service at 1-800-646-1655.

A “Respirator Medical Evaluation Request Form” will be faxed to you immediately. The identification number for the respirator medical evaluation is 12016.

#### WARNING: HEARING PROTECTION PRODUCTS

These hearing protection products help prevent hearing loss against certain noises. To provide proper protection, the hearing protector should be (1) suitable for the job, (2) fitted properly in/on the ear, (3) worn during all times of exposure to noise, and (4) replaced when damaged or otherwise necessary. Failure to fit and use hearing protectors according to these instructions will reduce their effectiveness. Failure to wear hearing protectors 100% of the time that you are exposed to hazardous noise may dramatically increase your risk of developing hearing loss. Keep ear plugs away from infants and small children. They may get caught in a child’s windpipe.

## 3M™ Hearing Protection

### 3M™ Foam Ear Plugs 1100 and Foam Ear Plug 1110, Corded

- Soft foam seals the ear canal comfortably
- Tapered shape to fit the ear canal comfortably
- Smooth, dirt resistant surface for hygiene
- Cord drapes comfortably around wearer’s neck and lays flat without twisting or binding (1110 only)
- NRR 29 dB\*

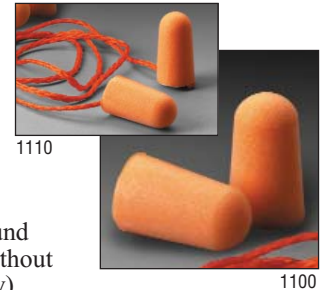

UPC Number	Part No.	Pairs Per Carton	Boxes Per Case
051138-29008-0	1100	200	5
051138-29009-7	1110	100	5

### 3M™ Soft Foam Ear Plugs 1120 and Foam Ear Plugs 1130, Corded

- Patented articulated shape for improved fit
- Rolls down small for easy insertion and fit for small ear canals
- New softer formulation for improved comfort
- Soft braided polyester cord for convenience (1130 only)
- NRR 28 dB\*

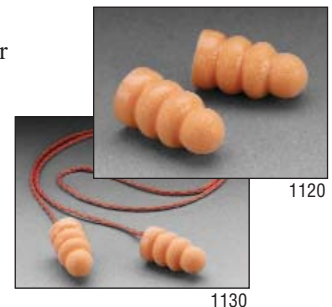

UPC Number	Part No.	Pairs Per Carton	Boxes Per Case
051131-37062-8	1120	200	5
051131-37063-5	1130	100	5

\* The NRR may overestimate the protection provided during typical use. 3M recommends reducing the NRR by 50% for estimating noise reduction provided.

## 3M™ Hearing Protection

*continued*

### 3M™ Reusable Ear Plugs 1270 Corded, and Reusable Ear Plugs 1271, with Carrying Case, Corded

- Soft cloth cord lays flat
- Storage case keeps plugs clean and protected (1271 only)
- NRR 24 dB\*
- Ideal for dusty, dirty situations

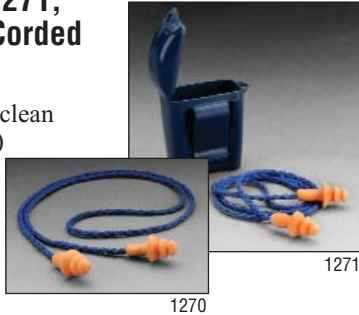

UPC Number	Part No.	Pairs Per Carton	Boxes Per Case
051131-52849-4	1270	100	5
051131-52850-0	1271	50	5

### 3M™ Banded Hearing Protector 1310

- Unique, flexible band design makes fitting easy and maintains low pressure over a wide range of head sizes for superior comfort
- NRR 21dB\* (band worn behind head) and 20 dB\* (band worn under chin)

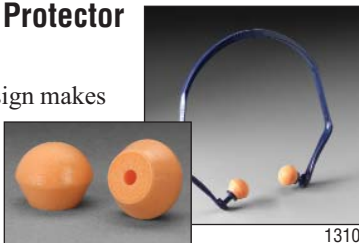

UPC Number	Part No.	Pairs Per Carton	Boxes Per Case
Banded Hearing Protection 051138-66003-6	1310	10	5
3M™ Replacement Pads 051138-66004-3	1311	20	5

#### WARNING: HEARING PROTECTION PRODUCTS

These hearing protection products help prevent hearing loss against certain noises. To provide proper protection, the hearing protector should be (1) suitable for the job, (2) fitted properly in/on the ear, (3) worn during all times of exposure to noise, and (4) replaced when damaged or otherwise necessary. Failure to fit and use hearing protectors according to these instructions will reduce their effectiveness. Failure to wear hearing protectors 100% of the time that you are exposed to hazardous noise may dramatically increase your risk of developing hearing loss. Keep ear plugs away from infants and small children. They may get caught in a child's windpipe.

### 3M™ General Purpose Ear Muff 1435

- Noise reduction rating of 23 dB\*
- Wide headband for low pressure and comfortable, secure fit
- Soft sealing cushion



UPC Number	Pairs Per Sleeve	Boxes Per Case
051138-29333-3	1	20

### 3M™ Ear Muff 1440

- Noise reduction rating of 24 dB\*
- Multi position ear cup for greater comfort and fit
- Sliding head band tension adjustment



UPC Number	Pairs Per Sleeve	Boxes Per Case
051138-29334-0	1	20

### 3M™ Ear Muff Replacement Parts Kit 1437 (for 1435) 1442 (for 1440)

- Kit includes one pair noise suppression inserts and one pair ear cushions

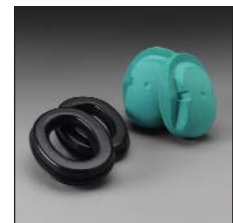

UPC Number	Part No.	Kits Per Case
051138-29341-8	1437	10
051138-29342-5	1442	10

\*The NRR may overestimate the protection provided during typical use. 3M recommends reducing the NRR by 50% for estimating noise reduction provided.



# 3M™ Eye Protection

## Protective Eyewear

### Features of 3M Protective Eyewear:

- Fashionable good looks
- Comfortable, secure fit with wraparound design
- Lightweight plastic frames
- 99% UV Protection

### 3M™ Protective Eyewear 1750, 1751, 1752

- Meets latest ANSI Z87.1-2003 standard for high impact protection
- Stylish and contemporary
- Conforms well to face helping to enhance eye protection

UPC Number	Pieces Per Bag	Bag Per Carton	Pieces Per Case*
051131-37113-7 Gray frame Clear lens <b>1750</b>	1	12	24
051131-37114-4 Gray frame Smoke lens <b>1751</b>	1	12	24
051131-37115-1 Blue frame Mirrored lens <b>1752</b>	1	12	24

\* 2 cartons per case

### 3M™ Protective Eyewear 1700, 1702

- Wraparound style frames
- Lightweight
- Low profile design



UPC Number	Pieces Per Inner Pkg	Inner Pkg Per Case	Pieces Per Case
051131-37103-8 Black Frame Clear Lens <b>1700</b>	12	2	24
051138-76801-5 Clear Frame Clear Lens <b>1702</b>	12	2	24

### 3M™ Protective Eyewear 1710

- Contemporary-styled frames
- Lens is made of durable, hard-coated polycarbonate
- 4-position adjustable temples



UPC Number	Pieces Per Inner Pkg	Inner Pkg Per Case	Pieces Per Case
051131-37104-5 Black Frame Clear Lens <b>1710</b>	12	2	24

#### WARNING

3M Protective Eyewear Products help provide limited eye and face protection against flying particles. Misuse or failure to follow warnings and instructions may result in serious personal injury, including blindness, or death. For proper use see supervisor, real instructions and warnings on the package, or call 3M Occupational Health and Environmental Safety Division (OH&ESD) Technical Service in the U.S.A. at 1-800-243-4630.

## 3M™ Eye Protection

### Protective Eyewear *continued*

#### 3M™ Protective Eyewear 1720, 1722, 1723

- Wrap-around design
- Non-slip rubber head grip for added comfort
- 5-position adjustable temple and a soft vinyl nose pad



UPC Number	Pieces Per Inner Pkg	Inner Pkg Per Case	Pieces Per Case
051138-76804-6 Black Frame Clear Lens <b>1720</b>	12	2	24
051138-76806-0 Red, White, Blue Frame Clear Lens <b>1722</b>	12	2	24
051131-37109-0 Black Frame Amber Lens <b>1723</b>	12	2	24

#### 3M™ Protective Eyewear 1730

- Stylish, one-piece wraparound design for good looks and optimal protection
- Vinyl nose pad and four-position temple adjustment for comfort
- Lens options: clear and amber
- Hard coated, polycarbonate lenses provide 99% UV protection
- One piece, hard coated lens can help protect brow and cheek areas



UPC Number	Pieces Per Inner Pkg	Inner Pkg Per Case	Pieces Per Case
051131-37105-2 Black Frame Clear Lens <b>1730</b>	12	2	24

### Visitor Specs

#### 3M™ Visitor Specs 1611

- Eye protection for visitors and other short-term users
- Can be worn alone or over prescription glasses



UPC Number	Pieces Per Inner Pkg	Inner Pkg Per Case	Pieces Per Case
051131-37101-4	25	12	300

## 3M™ Maintenance Sorbents

#### 3M™ Maintenance Sorbent, Folded M-FL550DD, High Capacity

- This is the easy-to-use solution for cleaning up spills, drips and fluid leaks
- Four sorbents in one: It can be used as a boom, pillow, pad, or roll, which means stock one product to meet your sorbent needs
- Perforations every 16 inches allow you to select the length required, so you use what you need
- The compact, handy dispenser box allows easy, on-site use
- 3M high capacity sorbent technology:
  - has increased fluid-holding capacity which means less sorbent used
  - simplifies reclamation for recycling of valuable liquids and reuse of sorbent; and minimizes sorbent waste for disposal



UPC Number	Model	Size
051138-29071-9	M-FL550DD	5 in x 50 ft/box

## 3M™ Matting

### 3M™ Safety-Walk™ Cushion Matting 3270 & 3270E

- Economical matting ideal for fatigue resistance in dry environments
- Textured, solid surface improves traction and allows debris and liquid to stay on top of the mat for easy cleanup
- Lightweight for easy moving and repositioning.
- 3270E has integral edging on the long edge of the mat and nosing on the ends.

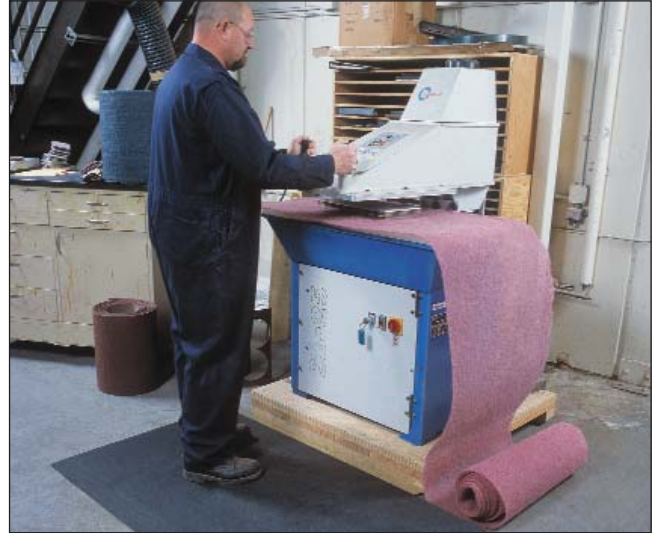

UPC Number	Size / Color	Edging	Quantity Per Case
048011-34819-3	3' x 5' Black	None	1
048011-34820-9	4' x 6' Black	None	1
048011-34821-6	3' x 10' Black	None	1
048011-34822-3	4' x 10' Black	None	1
048011-34823-0	3' x 20' Black	None	1
048011-34824-7	4' x 20' Black	None	1

UPC Number	Size / Color	Edging	Quantity Per Case
048011-34826-1	3' x 5' Black	Black	1
048011-34827-8	4' x 6' Black	Black	1
048011-34828-5	3' x 10' Black	Black	1
048011-34829-2	4' x 10' Black	Black	1
048011-34830-8	3' x 20' Black	Black	1
048011-34831-5	4' x 20' Black	Black	1

### 3M™ Safety-Walk™ Cushion Matting 3600

- More loft from less bulk
- Necessary cushion to help reduce discomfort
- A durable mat that's easily moved
- Superior traction to help prevent slips and mat movement
- Open construction allows water and small debris to pass through

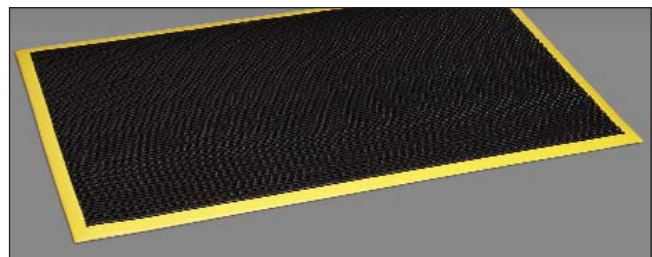

UPC Number	Size / Color	Edging Type	Edging Color	Quantity	Quantity Per Case
048011-23464-4	2' x 35" Black	None	–	–	4
048011-23477-4	2' x 35" Black	Beveled	Yellow	2 Edges	4
048011-23479-8	2' x 35" Black	Beveled	Black	2 Edges	4
048011-23478-1	2' x 38" Black	Beveled	Yellow	4 Edges	4
048011-23480-4	2' x 38" Black	Beveled	Black	4 Edges	4
048011-23465-1	5' x 35" Black	None	–	–	1
048011-23481-1	5' x 35" Black	Beveled	Yellow	2 Edges	1
048011-23483-5	5' x 35" Black	Beveled	Black	2 Edges	1
048011-23482-8	5' x 38" Black	Beveled	Yellow	4 Edges	1
048011-23484-2	5' x 38" Black	Beveled	Black	4 Edges	1

# 3M™ Matting

## PL-350-A

Description	Size	UPC	Pkg	List Price
<b>5250E</b>				
Cushion Matting Black	2 ft x 3 ft	048011-55944-5	1	\$49.38
	3 ft x 5 ft	048011-55940-7	1	\$123.43
	3 ft x 10 ft	048011-55941-4	1	\$246.87
	3 ft x 20 ft	048011-55942-1	1	\$493.74
	4 ft x 6 ft	048011-55943-8	1	\$197.49
	4 ft x 10 ft	048011-55918-6	1	\$329.16
	4 ft x 20 ft	048011-55919-3	1	\$658.32
<b>5250YE</b>				
Cushion Matting w/Yellow Edge	3 ft x 5 ft	048011-55917-9	1	\$133.40
	3 ft x 10 ft	048011-55922-3	1	\$266.80
	3 ft x 20 ft	048011-55923-0	1	\$533.62
	4 ft x 6 ft	048011-55920-9	1	\$213.45
	4 ft x 10 ft	048011-55924-7	1	\$355.74
	4 ft x 20 ft	048011-55925-4	1	\$711.48
<b>5270E</b>				
Cushion Matting Black	2 ft x 3 ft	048011-55949-0	1	\$52.32
	3 ft x 5 ft	048011-55945-2	1	\$130.79
	3 ft x 10 ft	048011-55947-6	1	\$261.58
	3 ft x 20 ft	048011-55948-3	1	\$523.16
	4 ft x 6 ft	048011-55946-9	1	\$209.28
	4 ft x 10 ft	048011-55926-1	1	\$348.79
	4 ft x 20 ft	048011-55921-6	1	\$697.56
<b>5270YE</b>				
Cushion Matting w/Yellow Edge	3 ft x 5 ft	048011-55927-8	1	\$141.25
	3 ft x 10 ft	048011-55929-2	1	\$282.47
	3 ft x 20 ft	048011-55930-8	1	\$564.95
	4 ft x 6 ft	048011-55931-5	1	\$225.98
	4 ft x 10 ft	048011-55932-2	1	\$376.63
	4 ft x 20 ft	048011-55933-9	1	\$753.27

Terms, transportation and other conditions of sale as shown on the IB-COS apply.

Prices subject to change without notice



## Miscellaneous Products

3M™ PPS™ Paint Preparation System

3M™ Tack Cloth and Pad

3M™ Citrus Base Cleaner

3M™ Vetrap™ Bandaging Tape

3M™ Silicone Lubricant

3M™ 5-Way Penetrant

3M™ Lightweight Body Filler

3M™ Creme Hardener

## Miscellaneous Products

### 3M™ PPS™ Paint Preparation System

A new, innovative system for mixing and preparing finish material prior to spraying.

- Up to 70% saving of cleaning solvent
- Only one PPS cup for mixing and spraying
- Closed system – no outside contamination
- Faster system – from mixing to disposal
- Less operator exposure to solvents and reduction of VOCs
- Spray gun functions at any angle

Part No.	Description	UPC Number	Items/Box	Boxes/Case
<b>650ml</b>				
16001	Cups and Collars,	051131-16001-9	2	4
16000	Lid and Liners,	051131-16000-2	50	1
16065	Mix Insert, 650ml	051131-16065-1	100	1
<b>850ml</b>				
16023	Large Cups and Collars,	051131-16023-1	1	4
16024	Large Lids and Liners,	051131-16024-8	25	1
16091	Mix Insert, 850ml	051131-16091-0	100	1
<b>Mini Kit</b>				
16115	Mini Cups and Collars	051131-16115-3	2	4
16114	Mini Lids and Liners	051131-16114-6	50	1
16113	Mini Cup Intro Kit includes 50 Lids and Liners	051131-16113-9	–	1
16066	Mix Insert, 6 oz (mini)	051131-16066-8	50	1
<b>Accessories</b>				
16054	Adapter, fits siphon guns*	051131-16054-5	1	4
16099	Lid Dispenser	051131-16099-6	1	1
16019	Liner Dispenser	051131-16019-4	1	1
37720	3M™ Detailing Squeeze Bottle	051131-37720-2	24	1

\* Additional adapters are available for for gravity feed guns.  
Contact your local 3M Authorized Distributor for more information.



# Miscellaneous Products

*continued*

## 3M™ All Purpose Tack Cloth

- Excellent for clean-up just before painting
- Removes dirt, lint, dust and sanding particles
- Stays soft
- Use again & again



Size	UPC Number	Wipes Per Case
17 x 36in	051144-03192-4	40

## 3M™ Tack Pad

- Final step in surface prep prior to finishing
- Leaves no drag marks behind while dust is drawn into the tack pad



Size	UPC Number	Wipes Per Case
175 x 235mm	051131-07910-6	24

## 3M™ Citrus Base Cleaner

- A multi-purpose cleaner which will dissolve and flush away dirt, grease, tar, most non-curing type adhesive films, and similar substances



- It is a citrus oil based cleaner that emulsifies when flushed with water
- It contains no petroleum distillate's
- Can be used to clean and degrease metal parts, motors, tools, concrete
- Contains no ozone depleting chemicals

Container Size	UPC Number	Containers Per Case
24 fl. oz.	021200-76394-6	12

## 3M™ Vetrap™ Bandaging Tape 2" x 5 yds

- Easy to use
- Stays in place on fingers
- Comfortable/Cooler
- Maintains your sense of touch

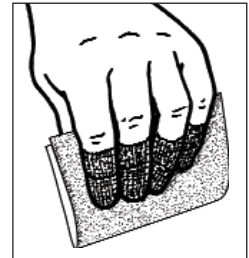

UPC Number	Product Description	Quantity Per Box	Boxes Per Case
051115-04853-1	1404B Blue	18	1

### YOUR 3M SOLUTIONS HOTLINES:

3M can provide additional products and accessories to meet your needs. Please contact us in any of the following ways that you prefer:

- 3M distributor or 3M sales representative in your area
- 3M Customer Response Center **1-866-279-1235**
- 3M Custom Woodworking and Cabinet Shop Website [www.3M.com/woodworking-catalog](http://www.3M.com/woodworking-catalog)

## Miscellaneous Products

*continued*

### 3M™ Silicone Lubricant

- Fast drying, long lasting
- Contains no petroleum oils
- 350°F (177°C) temperature resistance
- Won't stain or become gummy
- Lubricate cutting tools and tables
- Helps prevent build-up of glues, wax, inks, paints
- Should not be used near painting, staining or varnishing production areas



UPC Number	Size	Quantity Per Case
021200-85822-2	24 fl. oz.	12

### 3M™ Lightweight Body Filler

- For use over properly prepared wood surfaces, with creme hardener
- Cures tack-free in 15-20 minutes
- Features glass bubbles, making it easy to sand
- Ideal for a filler for paint-grade cabinets



UPC Number	Size	Quantity Per Case
051131-05801-9	Gallon	4
051131-05800-2	Quart	6

### 3M™ 5-Way Penetrant

- Penetrates, lubricates, demineralizes, cleans and helps prevent rust
- Frees rusted, frozen nuts
- “Dries out” electrical apparatus
- Inhibits corrosion and pitting of molded dies and extension screws



UPC Number	Size	Quantity Per Case
021200-21305-2	24 fl. oz.	12

### 3M™ Creme Hardener

- Red creme hardening agent
- Mixes easily
- Use with 3M™ Lightweight Body Filler



UPC Number	Size	Quantity Per Case
051131-05830-9	2.75 oz. tube	12





## THREE EASY WAYS TO CONTACT US FOR ALL 3M CUSTOM WOODWORKING PRODUCTS:

3M can provide additional products and accessories to meet your needs. Please contact us in any of the following ways that you prefer:

- Contact your local 3M authorized distributor directly. For information on a 3M distributor or sales representative in your area contact us at the numbers below:

For the contiguous 48 states

call \_\_\_\_\_ **1-866-279-1235**

fax \_\_\_\_\_ **651-778-4244**

For

Alaska \_\_\_\_\_ **907-522-5200**

Canada \_\_\_\_\_ **519-451-2500**

Hawaii \_\_\_\_\_ **808-422-2721**

Puerto Rico \_\_\_\_\_ **787-620-3000**

- Email us at **3MIndustrial@mmm.com**
- Visit the 3M Custom Woodworking and Cabinet Shop Website at **www.3M.com/woodworking-catalog**

For additional 3M product information or material safety data sheets call **1-800-3M Helps** or visit us at **www.3M.com**

### IMPORTANT NOTICE TO PURCHASER

**SAFETY INFORMATION:** Always read and follow all safety information included with the product. Do not exceed maximum operating RPM's. Use guards provided with machine. Follow safety operation procedures posted in work areas.

**PRODUCT USE:** All statements, technical information and recommendations contained in this document are based upon tests or experience that 3M believes are reliable. However, many factors beyond 3M's control can affect the use and performance of a 3M product in a particular application, including the conditions under which the product is used and the time and environmental conditions in which the product is expected to perform. Since these factors are uniquely within the user's knowledge and control, it is essential that the user evaluate the 3M product to determine whether it is fit for a particular purpose and suitable for the user's method of application.

**WARRANTY AND LIMITED REMEDY:** Unless stated otherwise in 3M's product literature, packaging inserts or product packaging for individual products, 3M warrants that each 3M product meets the applicable specifications at the time 3M ships the product. Individual products may have additional or different warranties as stated on product literature, package inserts or product packages. 3M MAKES NO OTHER WARRANTIES, EXPRESS OR IMPLIED, INCLUDING, BUT NOT LIMITED TO, ANY IMPLIED WARRANTY OF MERCHANTABILITY OR FITNESS FOR A PARTICULAR PURPOSE OR ANY IMPLIED WARRANTY ARISING OUT OF A COURSE OF DEALING, CUSTOM OR USAGE OF TRADE. User is responsible for determining whether the 3M product is fit for a particular purpose and suitable for user's application. If the 3M product is defective within the warranty period, your exclusive remedy and 3M's and seller's sole obligation will be, at 3M's option, to replace the product or refund the purchase price.

**LIMITATION OF LIABILITY:** Except where prohibited by law, 3M and seller will not be liable for any loss or damage arising from the 3M product, whether direct, indirect, special, incidental, or consequential, regardless of the legal theory asserted, including warranty, contract, negligence, or strict liability.

3M, Scotch-Brite, Stikit, Hookit, Finesse-it, Wetordry, Cubitron, Xodust, Scotch, Tartan, Safe-Release, Shipping Mate, Hand-Masker, Scotch-Blue, Scotch-Weld, Jet-melt, Polygun, Fastbond, Scotch-Grip, EPX, Sandblaster, Bumpon, Cool Flow, Safety-Walk, PPS, Vetrapp and the Purple color of the abrasive are all trademarks of 3M.



### Industrial Business

Customer Response Center  
900 Bush Avenue, Building 21-1W-10  
St. Paul, MN 55106



Minimum 10% Post-Consumer Fiber

© 3M 2005 60-4400-7219-1 IBD4149