

**GOSAT Level 1 Product Format Description Document**

***(Draft Version)***

**TANSO-FTS Section**

**NEB-080031**

January, 2009

***Japan Aerospace Exploration Agency***

GOSAT Level 1 Product Format Description Document  
(Draft Version)  
TANSO-FTS section

Contents

1. Introduction.....	2-1
1.1. Outline.....	2-1
1.2. Baseline Documents.....	2-1
2. Overview of products.....	2-1
2.1. Definition of processing level.....	2-1
2.2. Unit of products.....	2-7
2.3. Data Contents.....	2-12
2.4. Geometrical Information.....	2-15
2.4.1. Geolocation coverage of products.....	2-15
2.5. Land/Ocean Flag.....	2-17
2.6. Sunlint Flag.....	2-18
2.7. Sensitivity Correction Data.....	2-19
2.8. Method of geometrical correction (Derivation of sensor line of sight).....	2-19
3. Product Format.....	3-24
3.1. Data Structure.....	3-24
3.2. Details of raw ancillary data.....	3-25
3.3. Details of Interferogram.....	3-25
3.4. Format Details.....	3-30
3.5. Structure of Global Dataset.....	3-32

## 1. Introduction

### 1.1. Outline

This document describes TANSO-FTS Level 1 products produced with GOSAT data processing system.

GOSAT data processing system uses TANSO-FTS Level 0 data and then applies geometric and radiometric correction to produce following Level 1 products:

- Level 1A product
- Level 1B product
- Level 1A calibration product
- Level 1B calibration product
- Level 1A Lunar calibration product
- Level 1B Lunar calibration product

TANSO-FTS Level 1 products are in HDF5 (Hierarchical Data Format Version 5). They are produced with HDF library 1.66.

### 1.2. Baseline Documents

Following documents give the baseline for the design of products:

(1) JMP2.0

- JMP2.0 Specification (Technical Information Document of Geographical Survey Institute: E · 1-No.281, in Japanese)
- JMP2.0 Explanation (Technical Information Document of Geographical Survey Institute: E · 1-No.282)

(2) HDF5

- HDF5 Reference Manual (Release 1.6.6)
- HDF5 User's Guide (Release 1.6.6)

(3) Engineering Specification Document (ESPC)

- ESPC for global earth observation data processing system (for GOSAT), in Japanese (JX-ESPC-100149C)
- GOSAT TANSO ATBD(I) (SAT-060021)
- Algorithm design description for TANSO Level 1 Processing (draft), in Japanese (GOSAT-TANSO 処理-004\_4)
- Definition of JAXA GOSAT Products, in Japanese (NEB-0760004)

(4) CCSDS 133.0-B-1: Space Packet Protocol

## 2. Overview of products

### 2.1. Definition of processing level

Level 1A: Raw interferogram data obtained TANSO/FTS are reformatted and geometrical information are appended to produce level 1A products.

Level 1B: Non-linear correction, phase correction, and complex Fourier transformation are applied to sensor interferogram to produce level 1B products.

Table 2-1 gives definitions of TANSO-FTS processing level. (NB: Items for Level 1B processing may be subject to revise.)

**Table 2-1 Definition of TANSO-FTS Level 1 Products**

Type	Definition	Sensor Operation Mode	Appended information
Level1A	<p>Raw interferogram data obtained TANSO/FTS are reformatted and geometrical information are appended to produce level 1A products.</p> <p>One product contains followings:</p> <ul style="list-style-type: none"> <li>• Observation mode product: 1/60 data of one satellite revolution in time</li> <li>• Targeting mode product: One continuous set of target mode data</li> </ul>	<ul style="list-style-type: none"> <li>• Observation Mode (day/night)</li> <li>• Observation Mode II</li> <li>• Target Mode (Target Mode/Sunglint)</li> </ul>	<ul style="list-style-type: none"> <li>• Engineering value conversion parameters</li> <li>• Geolocation of observed point</li> <li>• Direction of Sun and Moon</li> <li>• Land/Sea flag</li> <li>• Quality Assurance Information</li> <li>• Ancillary data in Level 0</li> <li>• Ephemeris and attitude information</li> <li>• Calibration data information (Information of the closest calibration data before the observation time is given. If the closest past calibration data is not insufficient, the information of the closest calibration data after the observation time is given. Both these calibration data are insufficient, the next closest past calibration data information is given.)</li> <li>• Information on the range of wave number or optical path difference used for phase correction</li> <li>• Quality flag (Saturation flag at ZPD and flga for amplitude in lower frequencies)</li> <li>• Coefficients for non-liner correction</li> <li>• Method of Fourier transformation</li> </ul>

**Table 2-1 Definition of TANSO-FTS Level 1 Products**

Type	Definition	Sensor Operation Mode	Appended information
Level 1A Calibration	Raw interferogram data obtained TANSO/FTS are reformatted and geometrical information are appended to produce level 1A products. One product contains followings: <ul style="list-style-type: none"> <li>All calibration data except for lunar calibration in one downlink (one Level 0 dataset)</li> </ul>	<ul style="list-style-type: none"> <li>Blackbody Calibration</li> <li>Solar irradiance calibration mode</li> <li>Instrument function calibration</li> <li>Electrical calibration</li> </ul>	<ul style="list-style-type: none"> <li>Engineering value conversion parameters</li> <li>Direction of Sun and Moon</li> <li>Quality Assurance Information</li> <li>Ancillary data in Level 0</li> <li>Ephemeris and attitude information</li> <li>Information on the range of wave number or optical path difference used for phase correction</li> <li>Quality flag (Saturation flag at ZPD and flga for amplitude in lower frequencies)</li> <li>Coefficients for non-liner correction</li> <li>Method of Fourier transformation</li> </ul>
Level 1A Lunar Calibration	Raw interferogram data obtained TANSO/FTS are reformatted and geometrical information are appended to produce level 1A products. One product contains followings: <ul style="list-style-type: none"> <li>One continuous set of lunar calibration mode data</li> </ul>	<ul style="list-style-type: none"> <li>Lunar calibration</li> </ul>	<ul style="list-style-type: none"> <li>Engineering value conversion parameters</li> <li>Direction of Sun and Moon</li> <li>Quality Assurance Information</li> <li>Ancillary data in Level 0</li> <li>Ephemeris and attitude information</li> <li>Information on the range of wave number or optical path difference used for phase correction</li> <li>Quality flag (Saturation flag at ZPD and flga for amplitude in lower frequencies)</li> <li>Coefficients for non-liner correction</li> <li>Method of Fourier transformation</li> </ul>

**Table 2-1 Definition of TANSO-FTS Level 1 Products**

Type	Definition	Sensor Operation Mode	Appended information
Level 1B	<p>Non-linear correction, phase correction, and complex Fourier transformation are applied to sensor interferogram to produce spectra accompanied with information of calibration earth surface albedo value (for bands 1-3) and spectral radiance (for band 4).</p> <p>One product contains followings:</p> <ul style="list-style-type: none"> <li>• Observation mode product: 1/60 data of one satellite revolution in time</li> <li>• Targeting mode product: One continuous set of target mode data</li> </ul>	Same as Level 1A	<ul style="list-style-type: none"> <li>• Engineering value conversion parameters</li> <li>• Geolocation of observed point</li> <li>• Direction of Sun and Moon</li> <li>• Land/Sea flag</li> <li>• Quality Assurance Information</li> <li>• Ancillary data in Level 0</li> <li>• Ephemeris and attitude information</li> <li>• Phase correction information</li> <li>• Information on the range of wave number or optical path difference used for phase correction</li> <li>• Quality flag (Saturation flag at ZPD and flga for amplitude in lower frequencies)</li> <li>• Fringe count position of spike noise correction(s)</li> <li>• Coefficients for non-liner correction</li> <li>• Wave number of brightness spectrum (min, max, bin number)</li> <li>• Method of Fourier transformation</li> </ul>

**Table 2-1 Definition of TANSO-FTS Level 1 Products**

Type	Definition	Sensor Operation Mode	Appended information
Level 1B Calibration	<p>Raw interferogram are reformatted and following corrections are applied to produce the Level 1B products.</p> <p>Solar Irradiance calibration data: Solar irradiance brightness outside of atomosphere tuned with lunar calibration data after the correction of degradation of diffuse reflection plate and BRDF.</p> <p>Blackbody calibration: Observed radiance after removal of background radiance</p> <p>Deep space calibration: Same as blackbody calibration</p> <p>Instrument function calibration: Instrument function calibration data</p> <p>Electrical calibration: Invalid values are given for all elements</p> <p>One product contains followings:</p> <p>All calibration data except for lunar calibration in one downlink (one Level 0 dataset), same as L1A calibration products</p>	Same as Level 1A	<ul style="list-style-type: none"> <li>• Engineering value conversion parameters</li> <li>• Direction of Sun and Moon</li> <li>• Quality Assurance Information</li> <li>• Ancillary data in Level 0</li> <li>• Ephemeris and attitude information</li> <li>• Phase correction information</li> <li>• Information on the range of wave number or optical path difference used for phase correction</li> <li>• Quality flag (Saturation flag at ZPD and flga for amplitude in lower frequencies)</li> <li>• Fringe count position of spike noise correction(s)</li> <li>• Coefficients for non-liner correction</li> <li>• Wave number of brightness spectrum (min, max, bin number)</li> <li>• Method of Fourier transformation</li> </ul>



**Table 2-1 Definition of TANSO-FTS Level 1 Products**

Type	Definition	Sensor Operation Mode	Appended information
Level 1B Lunar Calibration	Non-linear correction, phase correction, and complex Fourier transformation are applied to sensor interferogram to produce spectra accompanied with information of calibration earth surface albedo value (for bands 1-3) and spectral radiance (for band 4), same as L1B product One product contains followings: One continuous set of lunar calibration mode data	Lunar calibration mode	<ul style="list-style-type: none"> <li>• Engineering value conversion parameters</li> <li>• Direction of Sun and Moon</li> <li>• Quality Assurance Information</li> <li>• Ancillary data in Level 0</li> <li>• Ephemeris and attitude information</li> <li>• Phase correction information</li> <li>• Information on the range of wave number or optical path difference used for phase correction</li> <li>• Quality flag (Saturation flag at ZPD and flga for amplitude in lower frequencies)</li> <li>• Fringe count position of spike noise correction(s)</li> <li>• Coefficients for non-linear correction</li> <li>• Wave number of brightness spectrum (min, max, bin number)</li> <li>• Method of Fourier transformation</li> </ul>

## 2.2. Unit of products

Level 1A/1B products contain data defined by a baseline document (“Definition of JAXA GOSAT Products”). Detailed contents are described below.

- ① For observation mode (day/night) one product contains one scene data which is defined as 1/60 data of one satellite revolution in time.
- ② If mode change (observation mode (day), observation mode (night), target mode, calibration modes) happens in one scene, the scene is divided to sub-scenes at the mode change point. But, in case there are 2 or more sub-scenes with identical observation mode are combined.
- ③ One target mode product is a set of continuous target mode observation including target observation and sunlint observation.
- ④ All FTS bands data for the same exposure are stored in the same product.
- ⑤ The same exposure data in different bands never divided to separate products.
- ⑥ Calibration product contains all calibration data except for lunar calibration in one downlink (one Level 0 dataset) all calibration data except for lunar calibration in one downlink (one L0 dataset)
- ⑦ Lunar calibration data contains one continuous set of lunar calibration mode data
- ⑧ No overlap data between two continuous products.
- ⑨ One interferogram never divided to two or more products. If scene division timing appears in one exposure, this exposure data is included in the former scene.

Product example following above rules are shown below.

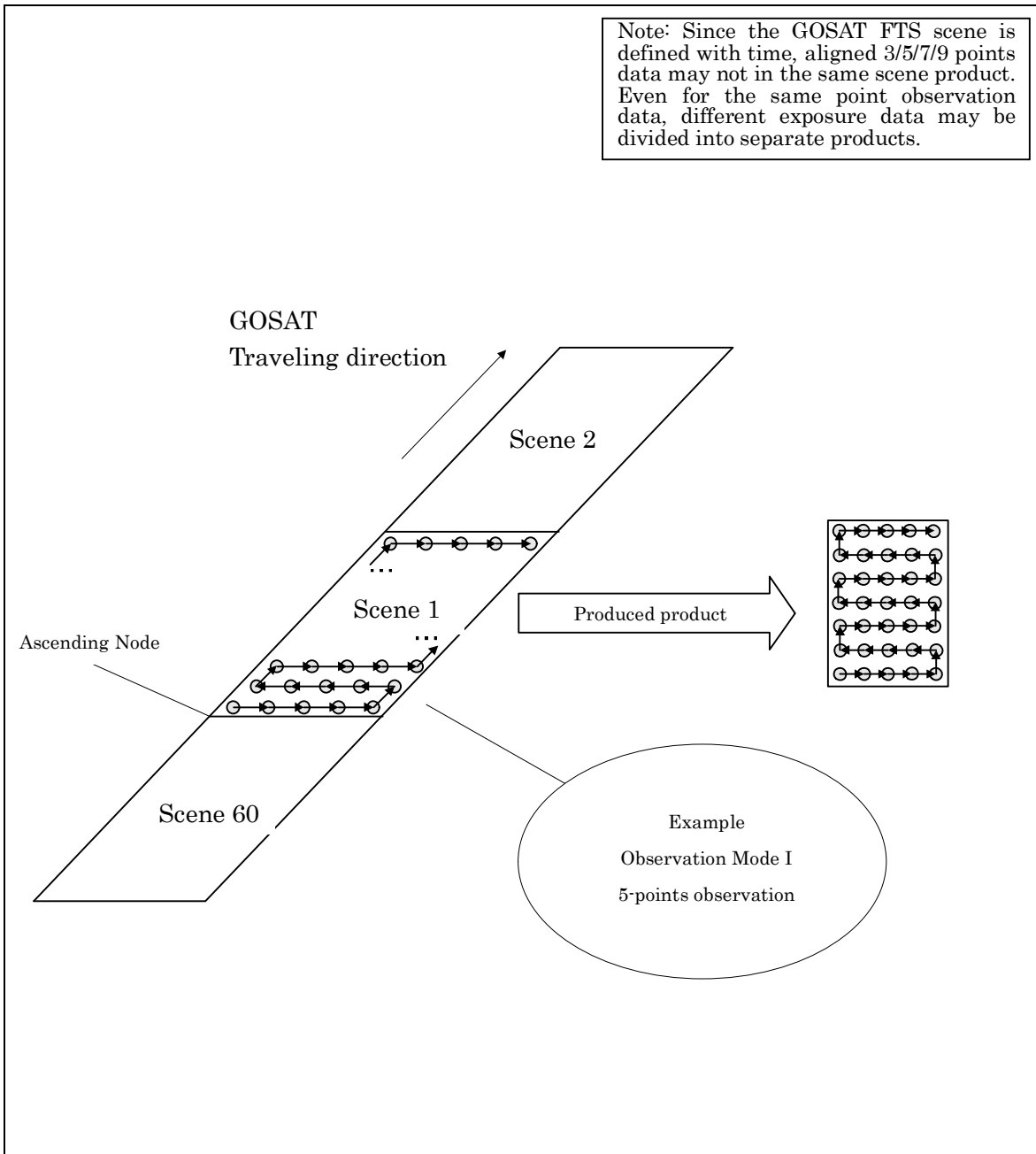
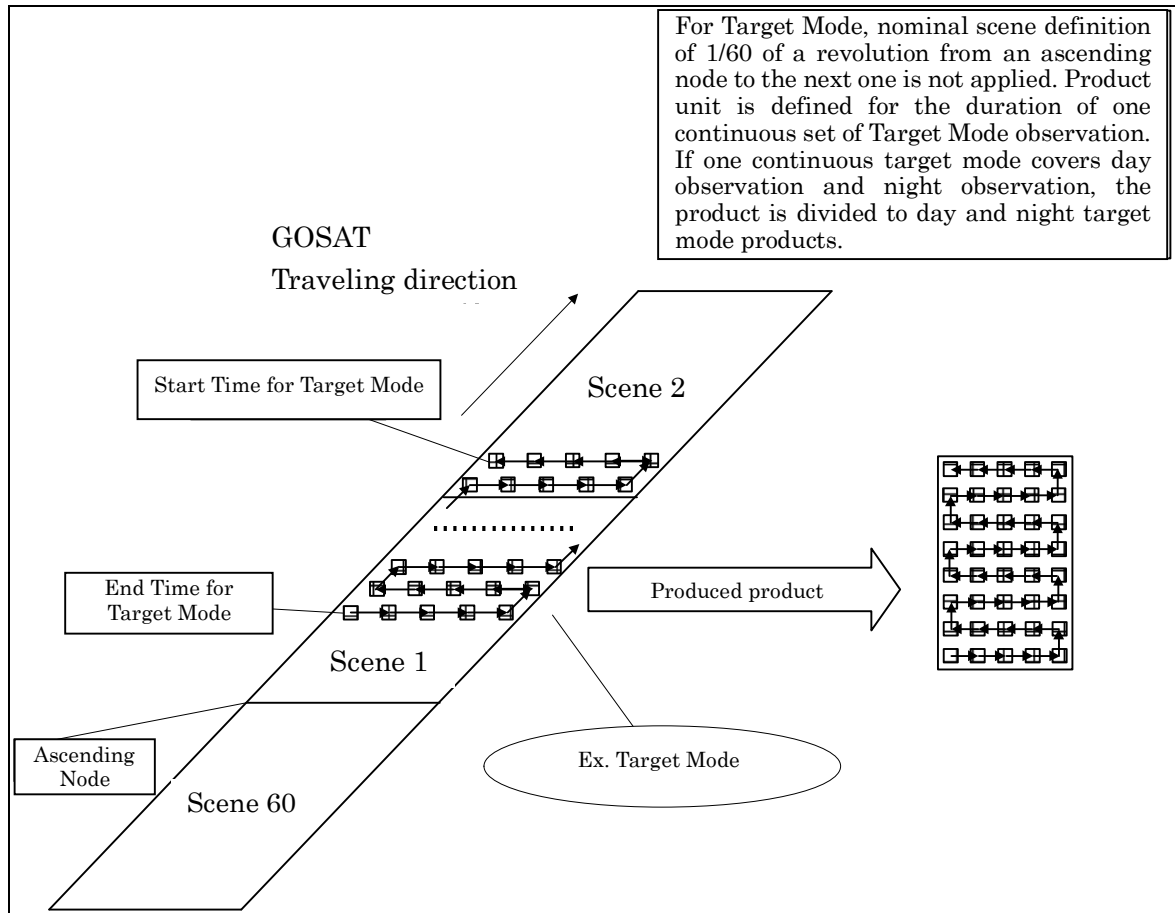
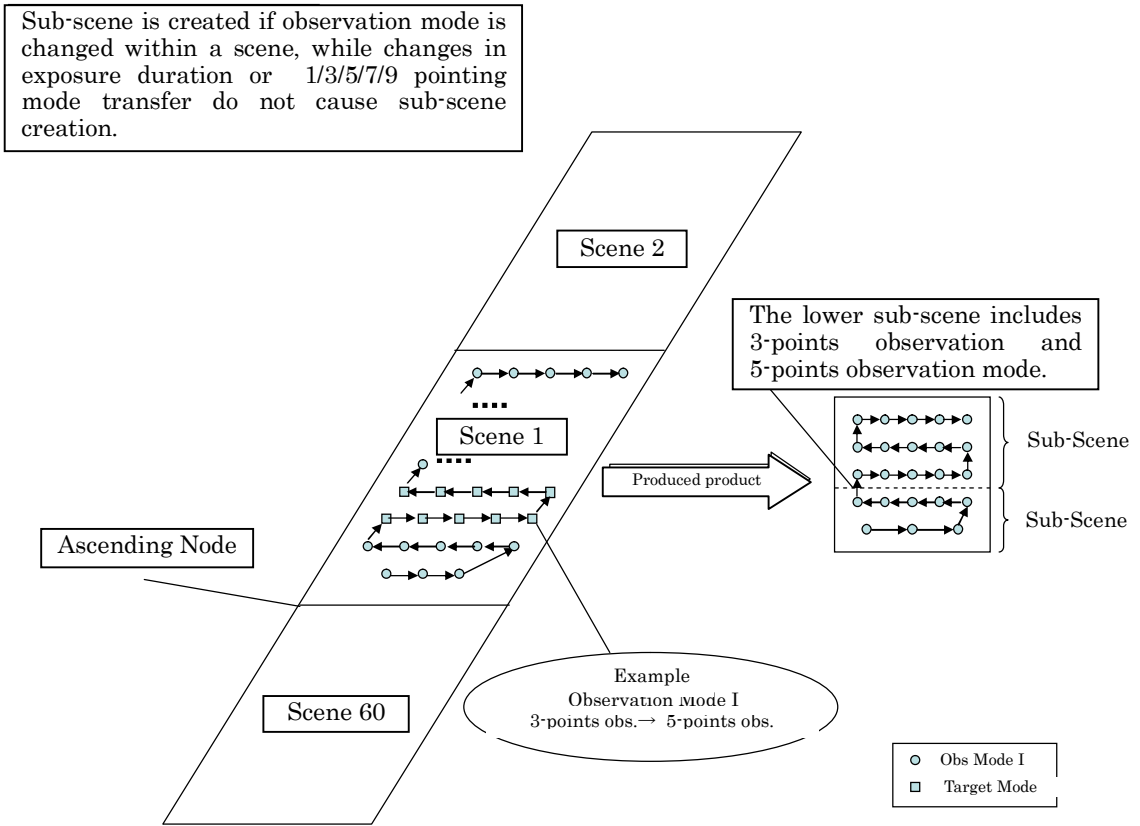

Figure 2-1: Product unit for Observation Mode I



2-2: Product unit for Target Mode



**2-3: Product unit when sub-scene is created**

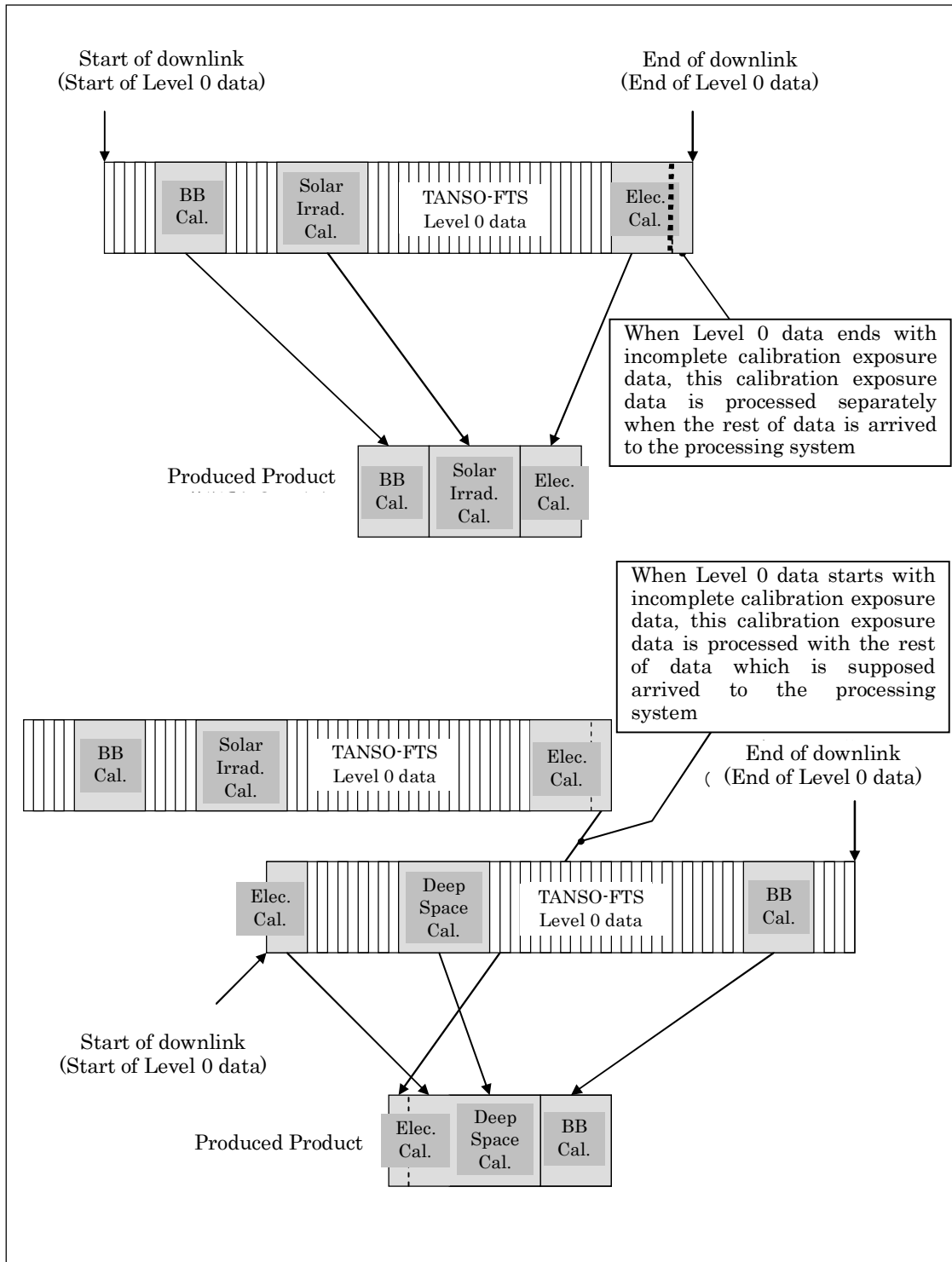

**Figure2-4 Calibration mode product and case one calibration exposure divided to 2 sequential Level 0 data**

### 2.3. Data Contents

In TANSO-FTS nominal observation mode (Observation Mode I), equivalent distanced mesh points are observed systematically. TANSO-FTS scans Earth surface for cross track direction and observe 1, 3, 5, 7, or 9 locations per one cross-track scan. For 1 or 3 points scan mode, the same position is observed three times. Figure 2-5 shows an example of 5-points observation scan pattern. Table 2-2 gives information of exposure duration and number of exposures for the same point according to the each point-mode.

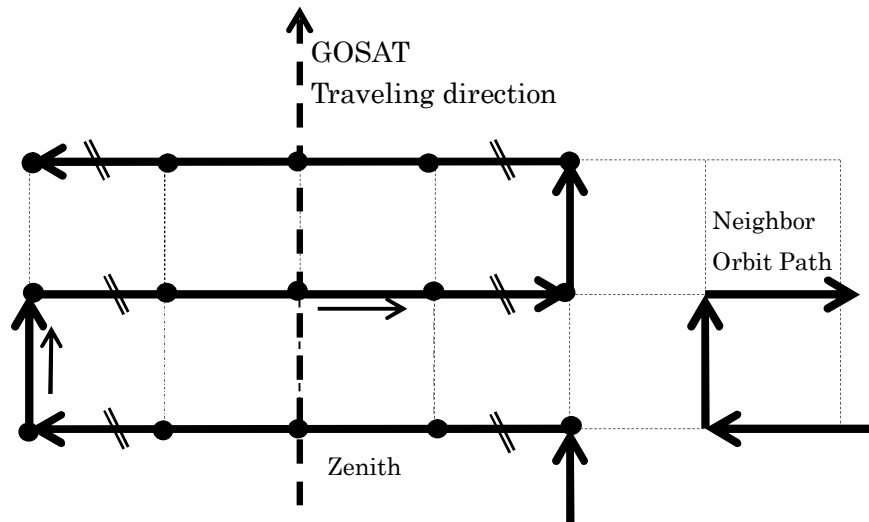

Figure 2-5 TANSO-FTS Nominal Observation Scan Pattern

Table 2-2 TANSO-FTS Scan Pattern and Exposure Pattern

Number of points For cross-track direction	Exposure Duration (sec)	Number of exposure for 1 point
1	4.0	3
3	4.0	3
5	4.0	1
7	2.0	1
9	1.1	1

For different TANSO-FTS scan pattern, exposure duration and turn-around time differ, and so product volume also differs. For Observation Mode II, AT/CT pointing direction will be fixed. Table 2-3 gives information on the data contents for each level and observation mode.

Table2-3 TANSO-FTS Data Contents

Processing Level	Observation Mode	Used Band	Data Contents (for one exposure)	Note
Level 1A	Observation Mode I (day)	SWIR(Band1-3) TIR(Band4)	SWIR band: 76,336 点×16bits	Nominal Observation
	Observation Mode I (night)	TIR	TIR: AC component 38,168 点×16bits	Ibid
	Observation Mode II	SWIR	TIR: DC component	
	Target Mode (day) (Sunlint・Target Mode)	SWIR TIR	38 点×12bits	Number of observation points differ from observation to observation.
	Target Mode (night) (Sunlint・Target Mode)	TIR		Ibid
Level 1A Calibration	Calibration Mode (Solar Irradiance)	SWIR	Ibid	Calibration using Solar Diffusion Reflector
	Calibration Mode (Blackbody)	TIR		Blackbody observation
	Calibration Mode (Deep Space)			Deep space observation
	Calibration Mode (Instrument Function)			Calibration using 1.55μm laser
	Calibration Mode (Electric)			Calibration using standard voltage signal input
Level 1A Lunar Cal.	Calibration Mode (Lunar)	SWIR TIR	Ibid	Calibration using moon for ~1.5 revolution duration
Level 1B	Observation Mode I (day)	SWIR TIR	SWIR each band: Defined wave number range × 32bits×2 (Real, Imagine)	Spectrum data are stored as real and imaginary parts for specified wave number range and no phase information is stored.
	Observation Mode I (night)	TIR		Ibid



Processing Level	Observation Mode	Used Band	Data Contents (for one exposure)	Note
	Observation Mode II	SWIR	TIR:	Ibid
	Target Mode (day) (Sunlint·Target Mode)	SWIR TIR	Defined wave number range × 32bits×2 (Real, Imagine)	Ibid
	Target Mode (night) (Sunlint·Target Mode)	TIR		Ibid
Level 1B Calibration	Calibration Mode (Solar Irradiance) ----- Calibration Mode (Blackbody) ----- Calibration Mode (Deep Space) ----- Calibration Mode (Instrument Function) ----- Calibration Mode (Electric)	SWIR TIR	SWIR each band: Defined wave number range × 32bits×2 (Real, Imagine) TIR: Defined wave number range × 32bits×2 (Real, Imagine)	Real and Imaginary part of spectral data for specified wave number region defined for each band. Phase information are not included specifically.
Level 1B Lunar Cal.	Calibration Mode (Lunar)	SWIR TIR	Ibid	Ibid

## 2.4. Geometrical Information

TANSO/FTS Level 1 products include geometrical information calculated using ephemeris, satellite attitude, and sensor geometrical configuration. The definitions of geometrical information are explained below.

### 2.4.1. Geolocation coverage of products

FTS L1 product includes Northernmost, Westernmost, Southernmost, and Easternmost points information to indicate geolocation area coverage. Northernmost point is defined as the northernmost point of the center of all geo-locations of observed interferogram (IGM) included in the product. The Westernmost point is also defined as the westernmost point of the center of all geo-locations of observed IGM included in the product. Southernmost and Easternmost points are also defined with the same way.

The Following shows an example.

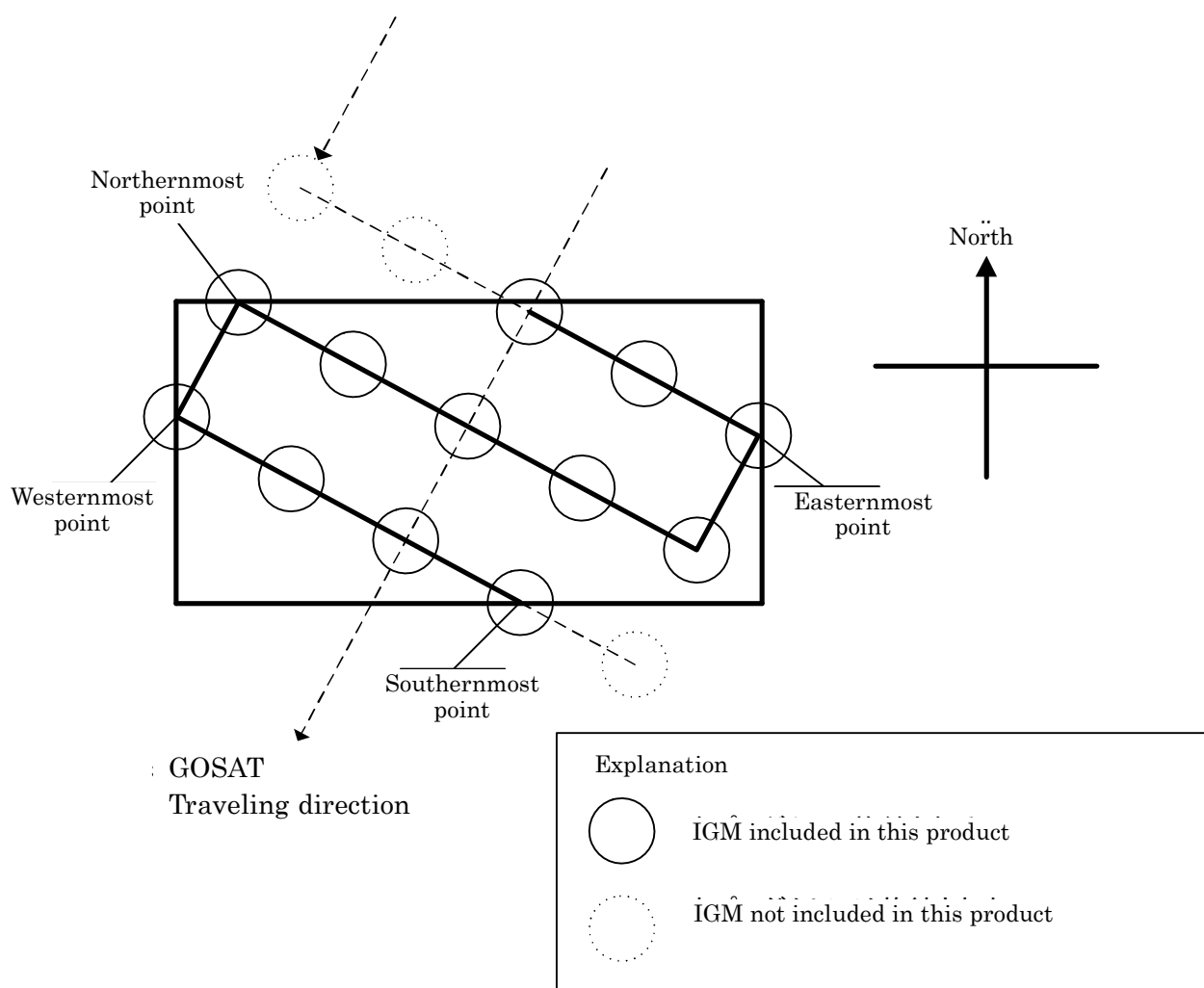

**Figure2-6 Example of Northern/Western/Southern/Eastern-most points**

As a special case, if one product includes data crossing near north or south pole Northernmost or Southernmost point is defined as the nearest point to the north pole or south pole. Easternmost and Westernmost points are defined as below:

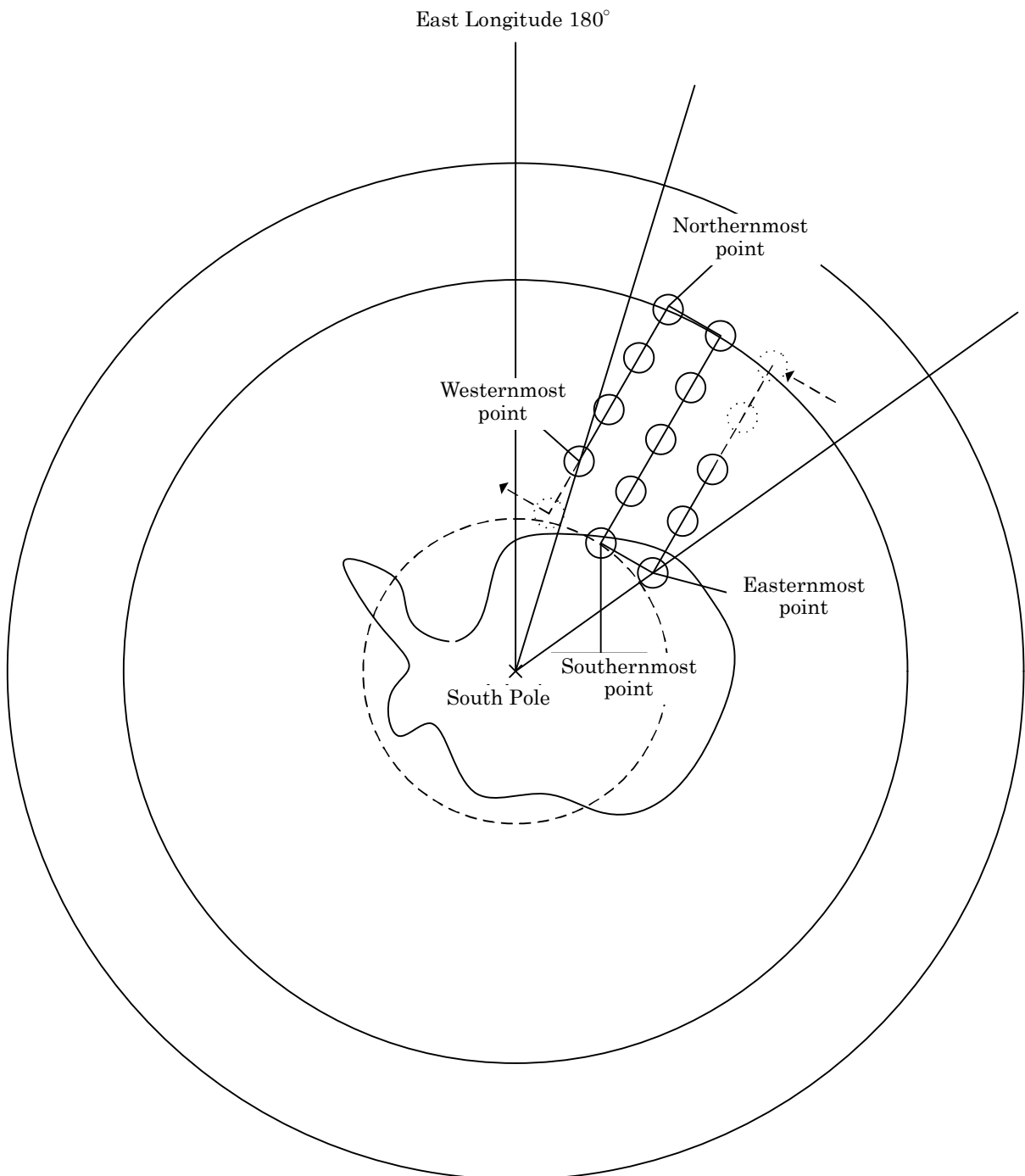

**Figure 2-7 Example of Northern/Western/Southern/Eastern-most points near South Pole**

If data included in a product crosses over the east (or west) longitude 180° line, the Westernmost and Easternmost points are defined as below, which is the same way as Figure 2-6.

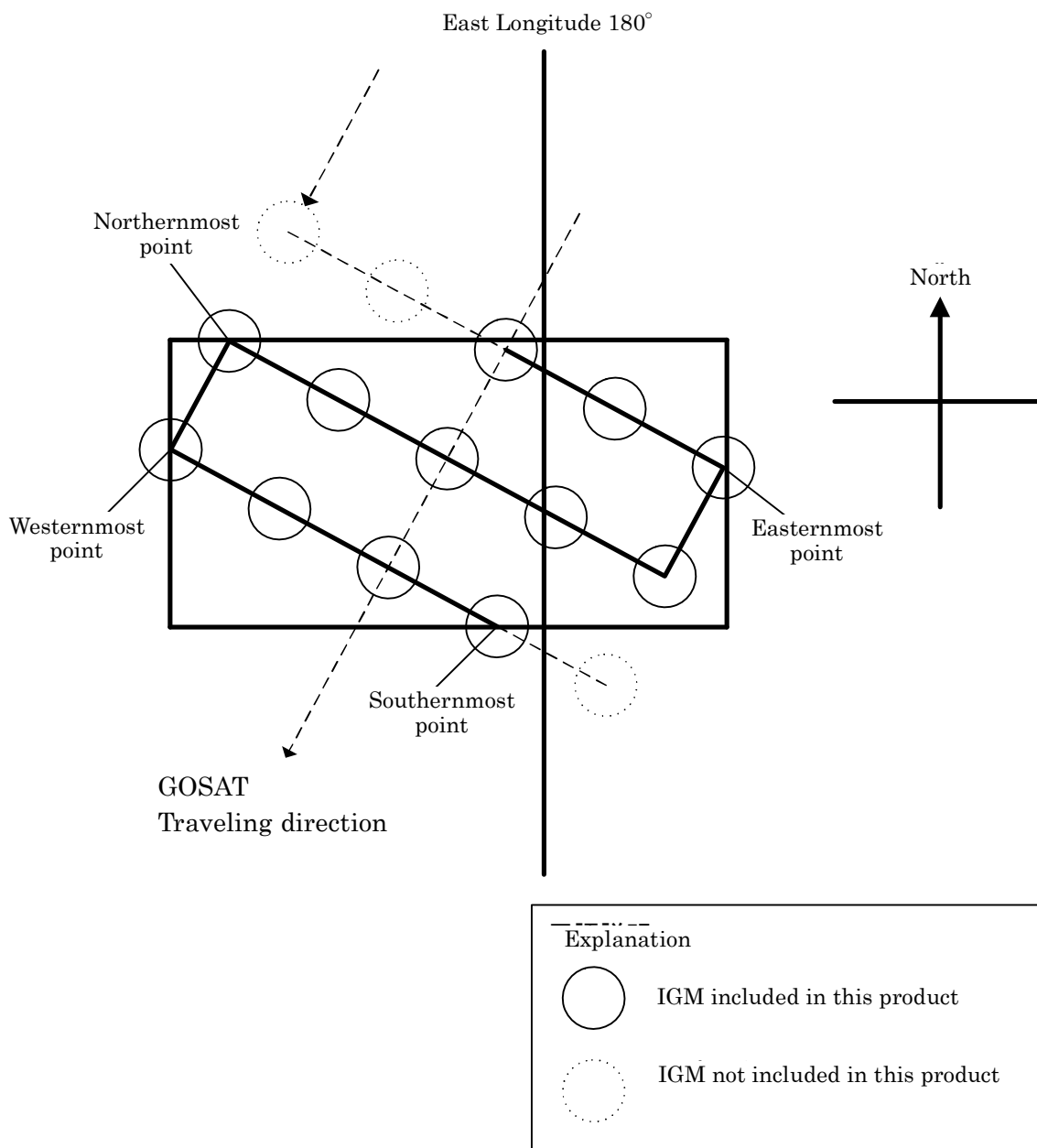

**Figure2-8 Example of Northern/Western/Southern/Eastern-most points crossing the east longitude 180° line**

**2.5. Land/Ocean Flag**

FTS Level 1 product includes Land/Ocean flag information to indicate whether the observed earth surface is land or water (ocean/lake/river). As shown in Figure 2-9, if all 5 points within an interferogram footprint are land, the flag is defined as land. If all of them are water, the flag becomes water. For the other cases, it is defined as mixed.

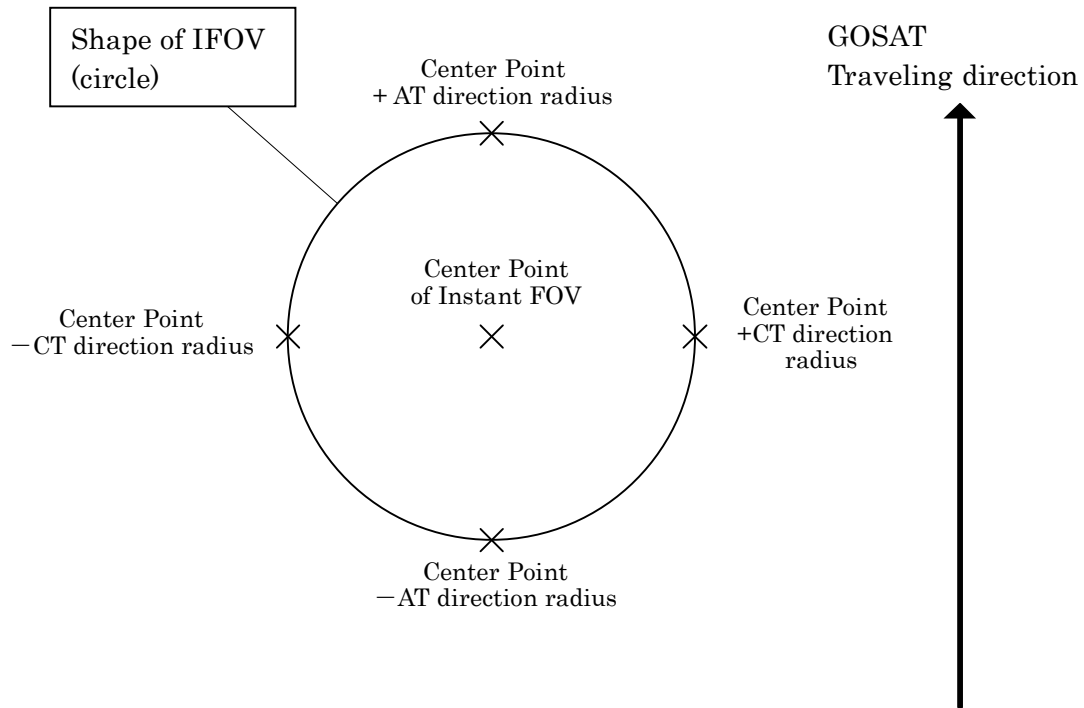

**Figure2-9 Points for Land/Ocean flag judgment**

## 2.6. Sunlint Flag

FTS L1 product includes Sunlint flag to indicate whether each exposure is sunlint observation or not. In case the land/ocean flag for a specified exposure is ocean or mixed, and if the incident angles of sun light and sensor line of sight agree at the observed earth surface point, and also if the azimuth angles of sun direction and satellite direction at the observed point differ by 180 degree, its sunlinting flag is defined as sunlint. By the way the agreement is judged with a certain criteria defined separately. Angles used for this judgment are shown in Figure 2-10.

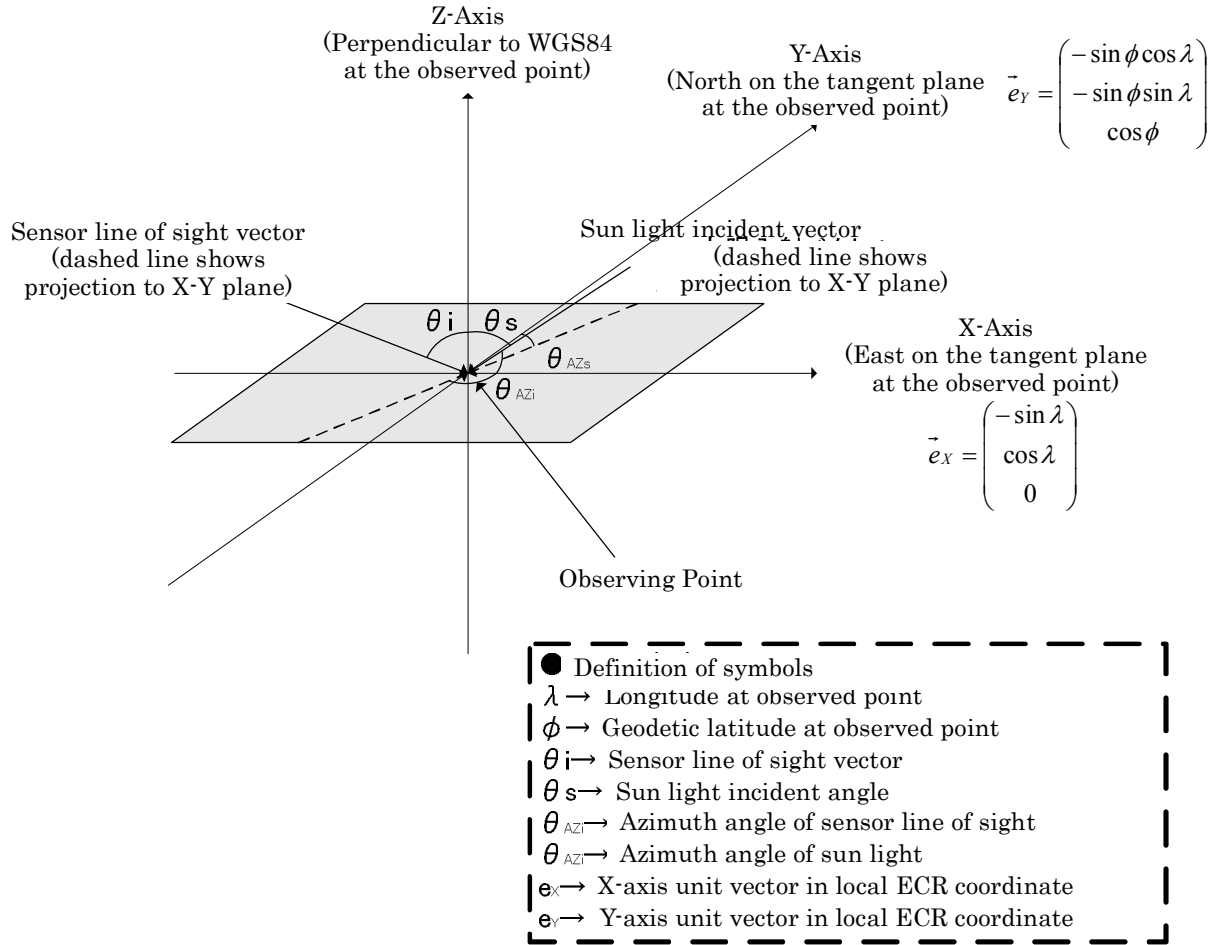

**Figure2-10 Angles for sunlint judgment (Projection to X-Y plane)**

## 2.7. Sensitivity Correction Data

Sensitivity correction data for SWIR band are not included in FTS L1 product. The information are given in a separate file.

Sensitivity correction data will be available at GOSAT web pages at JAXA and NIES. (TBD)

## 2.8. Method of geometrical correction (Derivation of sensor line of sight)

### (1) Vector of sensor line of sight

The followings describe the derivation method for the vector of sensor line of sight in sensor (FTS) coordinate. If without sensor alignment error, the satellite coordinate and the sensor coordinate are identical. FTS pointing mechanism has its own coordinate, but AT/CT angles mentioned here are in sensor coordinate. The sensor alignment error evaluated on the ground before launch are used as default value, but the values derived from on orbit geometrical calibration may be used if necessary.

If we write CT angle and AT angle of pointing mechanism as  $\theta_{CT}$  and  $\theta_{AT}$ , respectively, ( $\theta_{AT}$  has the opposite sign and half value of what is output as sensor

telemetry), vector of the sensor line of sight is given as:

$$b_{LOS}(N, n) = a_{opt}(N, n) - 2(a_{opt}(N, n) \cdot n_{PM})n_{PM},$$

where  $a_{opt}(N, 0)$  is the light vector on FTS optical bench, which is given as

$$a_{opt}(N, 0) = \begin{pmatrix} 1 \\ 0 \\ 0 \end{pmatrix} \text{ in sensor coordinate. Alignment error will be handled by trimming this}$$

optical axis vector. Alignment error may differ among each band/channel, the error values are given for each  $N$  ( $N=1P, 1S, 2P, 2S, 3P, 3S, 4$ ). Besides the optical axis vector for the center position of FTS FOV, following 4 optical axis vectors are defined using FTS FOV radius angle of  $\theta$  r, which has a default value of 0.45 degree independent of band/channel:

$$a_{opt}(N, 1) = \begin{pmatrix} \cos \theta r \\ \sin \theta r \cdot \cos \theta_{CT} \\ \sin \theta r \cdot \sin \theta_{CT} \end{pmatrix}, \quad a_{opt}(N, 2) = \begin{pmatrix} \cos \theta r \\ -\sin \theta r \cdot \sin \theta_{CT} \\ \sin \theta r \cdot \cos \theta_{CT} \end{pmatrix},$$

$$a_{opt}(N, 3) = \begin{pmatrix} \cos \theta r \\ -\sin \theta r \cdot \cos \theta_{CT} \\ -\sin \theta r \cdot \sin \theta_{CT} \end{pmatrix}, \quad \text{and} \quad a_{opt}(N, 4) = \begin{pmatrix} \cos \theta r \\ \sin \theta r \cdot \sin \theta_{CT} \\ -\sin \theta r \cdot \cos \theta_{CT} \end{pmatrix}.$$

$n_{PM}$  is the normal vector of the pointing mechanism plane and written as

$$n_{PM} = \begin{pmatrix} -\sin(\pi/4 - \theta_{AT}) \\ -\sin(\theta_{CT}) \cos(\pi/4 - \theta_{AT}) \\ \cos(\theta_{CT}) \cos(\pi/4 - \theta_{AT}) \end{pmatrix}.$$

Then the vector of sensor line of sight corresponding to the light vector on optical bench is given as

$$b_{LOS}(N, 0) = \begin{pmatrix} 1 - 2 \sin^2(\pi/4 - \theta_{AT}) \\ -2 \sin(\pi/4 - \theta_{AT}) \sin(\theta_{CT}) \cos(\pi/4 - \theta_{AT}) \\ 2 \sin(\pi/4 - \theta_{AT}) \cos(\theta_{CT}) \cos(\pi/4 - \theta_{AT}) \end{pmatrix} = \begin{pmatrix} \sin(2\theta_{AT}) \\ -\sin(\theta_{CT}) \cos(2\theta_{AT}) \\ \cos(\theta_{CT}) \cos(2\theta_{AT}) \end{pmatrix}.$$

Likewise, the vectors of line of sights for outer 4 points are given as follows:

$$b_{LOS}(N, n) = a_{opt}(N, n) - 2(a_{opt}(N, n) \cdot n_{PM})n_{PM}$$

Polarization vectors are defined as follows. When TANSO-FTS directs zenith, the polarized light detected with the sensor on Z-X plane is the prime band (P-band) and that on Y-Z plane is the secondary band (S-band). Thus, the vectors for polarization axis for P and S band on optical bench are given as

$$a_{optP} = \begin{pmatrix} 0 \\ 0 \\ 1 \end{pmatrix} \quad \text{and} \quad a_{optS} = \begin{pmatrix} 0 \\ 1 \\ 0 \end{pmatrix}, \text{ since liner polarized light becomes maximum for this}$$

direction. Therefore, polarization vectors are given as:

$$b_{LOSP} = \begin{pmatrix} 2 \cos(\theta_{CT}) \cos(\pi/4 - \theta_{AT}) \sin(\pi/4 - \theta_{AT}) \\ 2 \cos(\theta_{CT}) \cos(\pi/4 - \theta_{AT}) \sin(\theta_{CT}) \cos(\pi/4 - \theta_{AT}) \\ 1 - 2 \cos^2(\theta_{CT}) \cos^2(\pi/4 - \theta_{AT}) \end{pmatrix} = \begin{pmatrix} \cos(\theta_{CT}) \cos(2\theta_{AT}) \\ \cos(\theta_{CT}) \sin(\theta_{CT}) (1 + \sin(2\theta_{AT})) \\ 1 - \cos^2 \theta_{CT} (1 + \sin(2\theta_{AT})) \end{pmatrix}$$

$$b_{LOSS} = \begin{pmatrix} -2 \sin(\theta_{CT}) \cos(\pi/4 - \theta_{AT}) \sin(\pi/4 - \theta_{AT}) \\ 1 - 2 \sin^2(\theta_{CT}) \cos^2(\pi/4 - \theta_{AT}) \\ 2 \sin(\theta_{CT}) \cos(\theta_{CT}) \cos^2(\pi/4 - \theta_{AT}) \end{pmatrix} = \begin{pmatrix} -\sin(\theta_{CT}) \cos(2\theta_{AT}) \\ 1 - \sin^2(\theta_{CT}) (1 + \sin(2\theta_{AT})) \\ \sin \theta_{CT} \cos \theta_{CT} (1 + \sin(2\theta_{AT})) \end{pmatrix}.$$

These polarization vectors are not used in level 1 processing, but information are given for users convenience.

(2) Alignment of pointing mechanism (PM) (Correction is done within the controller of pointing mechanism [TBD])

Error angles of TANSO-FTS alignment for PM-A and PM-B when FTS optics (FTS-OPT) directs zenith (sign of values are explained separately) are given in the table below.

	PM-A	PM-B
AT(LOS) (degree)	+0.15	+0.37
CT (degree)	-1.24	-0.24

The telemetry value for AT angle of pointing mechanism is twice of that of the actual mechanical rotation angle.

(3) Alignment error between FTS optical bench and satellite

Alignment error between the FTS optical bench and the satellite is corrected within the controller of pointing mechanism (TBD). And so, in level 1 processing and MMO planning, alignment error between the sensor coordinate and the satellite coordinate is taken care. The table below gives information

	around X-axis	around Y-axis	around Z-axis
Between FTS optical bench and TANSO FTS coordinate (degree)	Refer to the figure below	Refer to the figure below	Refer to the figure below
Between FTS coordinate and satellite coordinate (degree) ※	-0.01514	-0.01906	0.03069

※ The measured value in April 2008



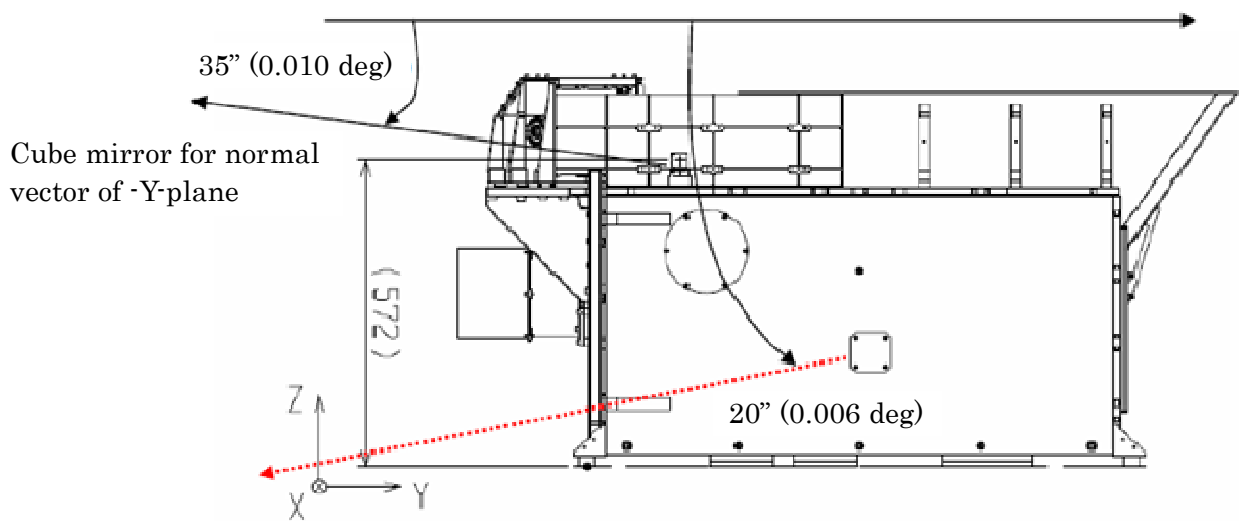
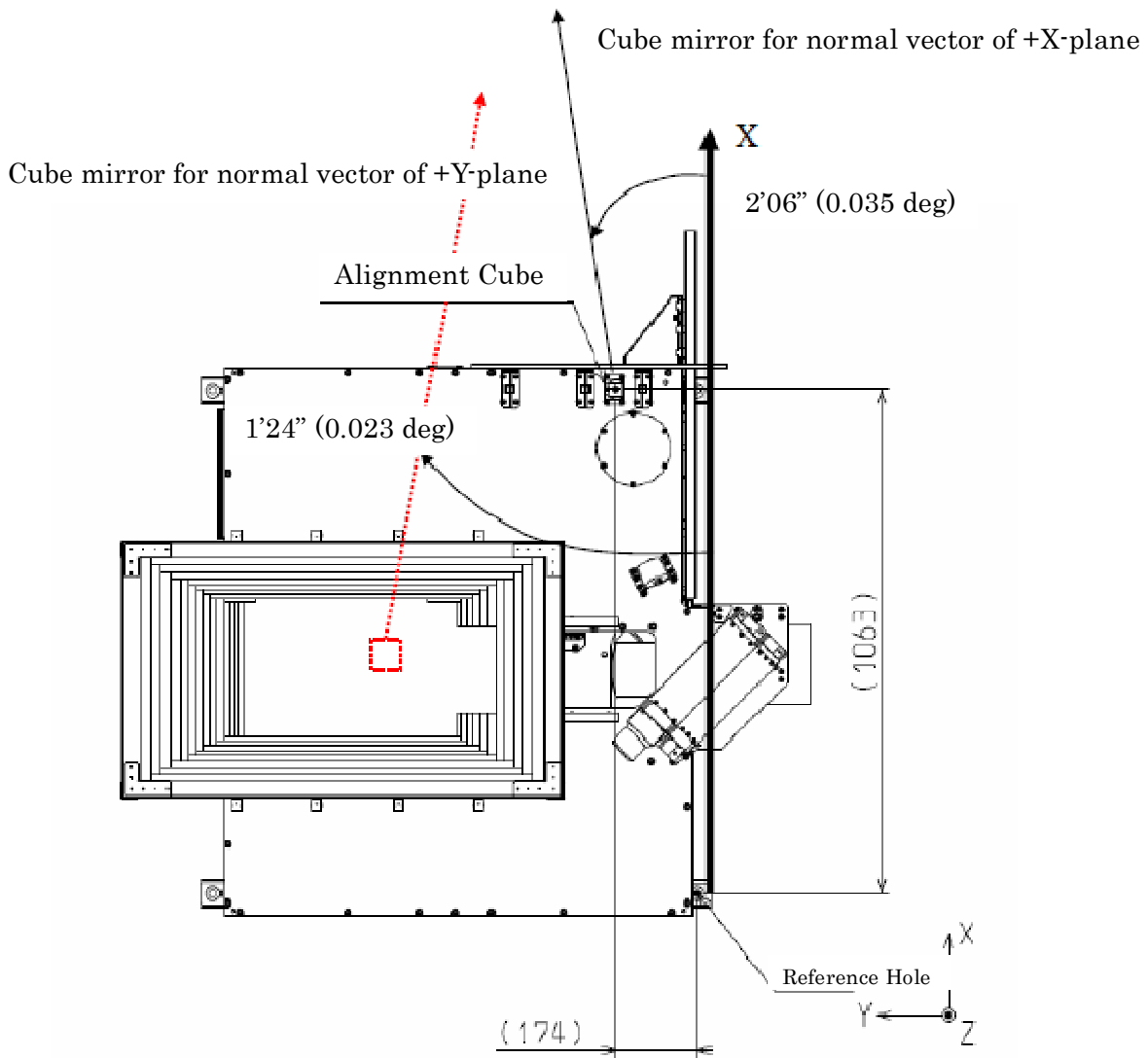

Bench mirror for normal vector of -Y-plane

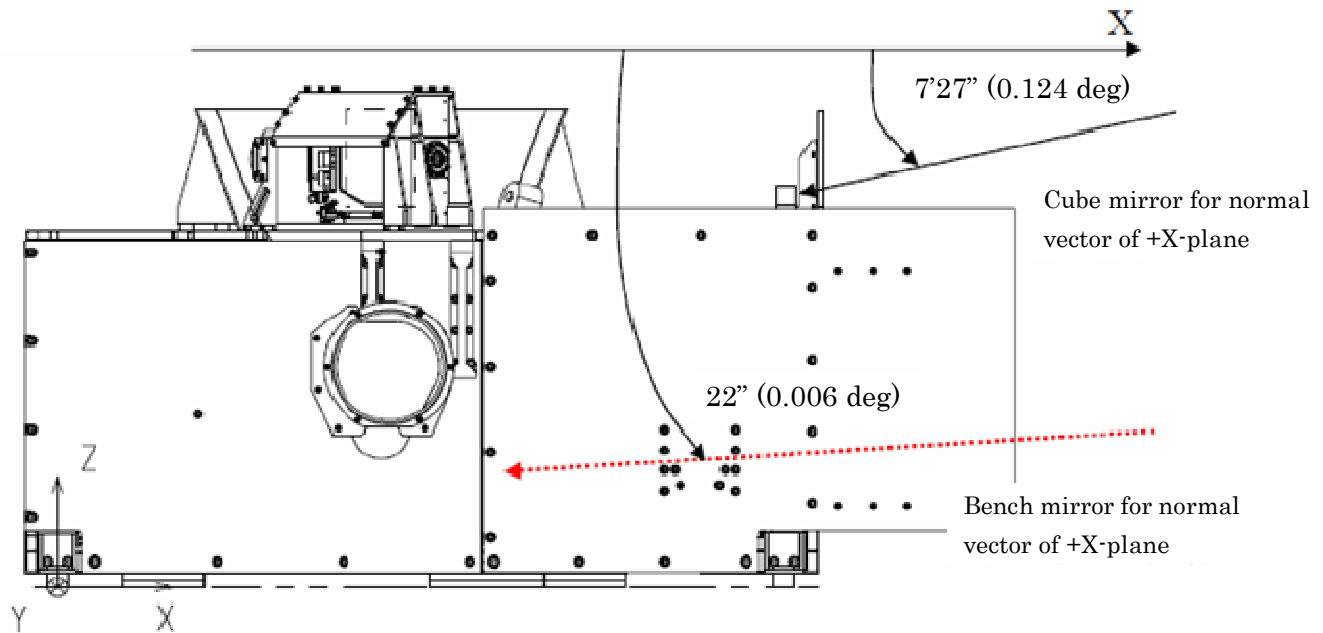

#### (4) Formula for alignment correction

In Target Mode planning in GOSAT Mission Management Organization (MMO) and geo-location derivation in level 1 processing, alignment error is taken in account. As described above, alignment errors between FTS optical bench and FTS PM and between FTS coordinate and FTS optical bench are corrected within the onboard controller of PM. No correction in ground system (MMO or L1 processing system) is necessary (To be confirmed). In the telemetry, the sign of values are in the original PM coordinate and not converted to the FTS or satellite coordinate.

The alignment correction between FTS coordinate and satellite coordinate is taken care of by MMO in planning using following formulae:

$$\begin{pmatrix} CT_{sat} \\ AT_{sat} \end{pmatrix} = \begin{pmatrix} 1 & \sin(0.003069) \\ -\sin(0.003069) & 1 \end{pmatrix} \begin{pmatrix} -1 & 0 \\ 0 & -1 \end{pmatrix} \begin{pmatrix} CT_{tc} \\ AT_{tc} \end{pmatrix} + \begin{pmatrix} -0.01906 \\ -0.01514 \end{pmatrix}.$$

Subscript sat means the variable is in satellite coordinate, and tc is for telemetry in PM coordinate whose sign is opposite to satellite coordinate.

### 3. Product Format

#### 3.1. Data Structure

TANSO-FTS Level 1 product includes metadata, global which contains the other sensor specific metadata, scan attribute which corresponds to each exposure point, ancillary data which do not coincide with each exposure, and image data, all of which follow JPM 2.0 standard.

Dataset structure of TANSO-FTS Level 1 product is given in Table 3-1.

**Table 3-1 Dataset Structure of TANSO-FTS Level 1 Product**

No	Group	Name	Outline
1	Global	Global	Items below are given as explanation of product type, contents, etc. following JMP2.0 standard. <ul style="list-style-type: none"> <li>• Product File Name</li> <li>• Sensor Name</li> <li>• Processing Level</li> <li>• Observation Mode</li> <li>• Processing Algorithm Name and its version</li> <li>• Start and end time of observation</li> <li>• Metadata items following JMP2.0 standard</li> </ul>
2	Exposure Attribute	exposureAttribute	Items below are given as information corresponding to each exposure: <ul style="list-style-type: none"> <li>• Time of observation</li> <li>• Geolocation of observed point (WGS84)</li> <li>• Quality information of data</li> <li>• Position of Sun and Moon</li> <li>• Land/Ocean flag, Sunlint flag</li> <li>• Raw ancillary data included in Level 0 data</li> <li>• Phase correction information</li> <li>• Quality flag (saturation flag at ZPD, amplitude of low frequency component)</li> </ul>
3	Interferogram	Interferogram	Sensor data are included as mission data for Level 1A <ul style="list-style-type: none"> <li>• Interferogram</li> </ul>
4	Spectrum	Spectrum	Spectral data are included which is transformed from interferogram for Level 1B <ul style="list-style-type: none"> <li>• Spectra (Real part &amp; Imaginary part)</li> </ul>
5	Ancillary	Ancillary	Items below are given as information not coincide with each exposure <ul style="list-style-type: none"> <li>• Calibration data</li> <li>• Engineering transformation coefficients for interferogram</li> <li>• Ephemeris data</li> <li>• Attitude data</li> <li>• Clock correction information</li> <li>• Non linearity correction coefficients</li> <li>• Range of wave number or optical path difference used for phase correction</li> <li>• Wave number of spectral radiance (Max, Min, &amp; elements)</li> <li>• Method of Fourier Transformation</li> </ul>

### 3.2. Details of raw ancillary data

FTS level 1 product includes raw ancillary data from sensor. Raw ancillary data is that in SP (Space Packet) format. Format of raw ancillary data is given below.

CCSDS PH	CCSDS Primary Header	6 octets
CCSDS SH	CCSDS Secondary Header	5 octets
ELU Header	Reserved	2 octets
	ANC/DATA	1 bit
	Sensor ID	7 bit
	Data Count	1 octet
	Segment Count	1 octet
Sensor Ancillary	FTS Status	6 octets
	Time Information	5 octets
	Sensor internal Counter Value	2 octets
	Reserved	1 octet
	PCD	118 octets
	FTS TLM	320 octets
Checksum	Checksum	1 octet

The increment of sensor packet sequence counter differs depending on sensor ID. Table3-2 gives increment information.

**Table3-2 Increment of Sequence Counter**

SENSOR ID (binary)	Increment
0001001	1
0000000	77 or 40

### 3.3. Details of Interferogram

FTS Level 1A products contains interferogram data. Format of interferogram data part is given below.

Interferogram data (SWIR) has following structure in L1A product.

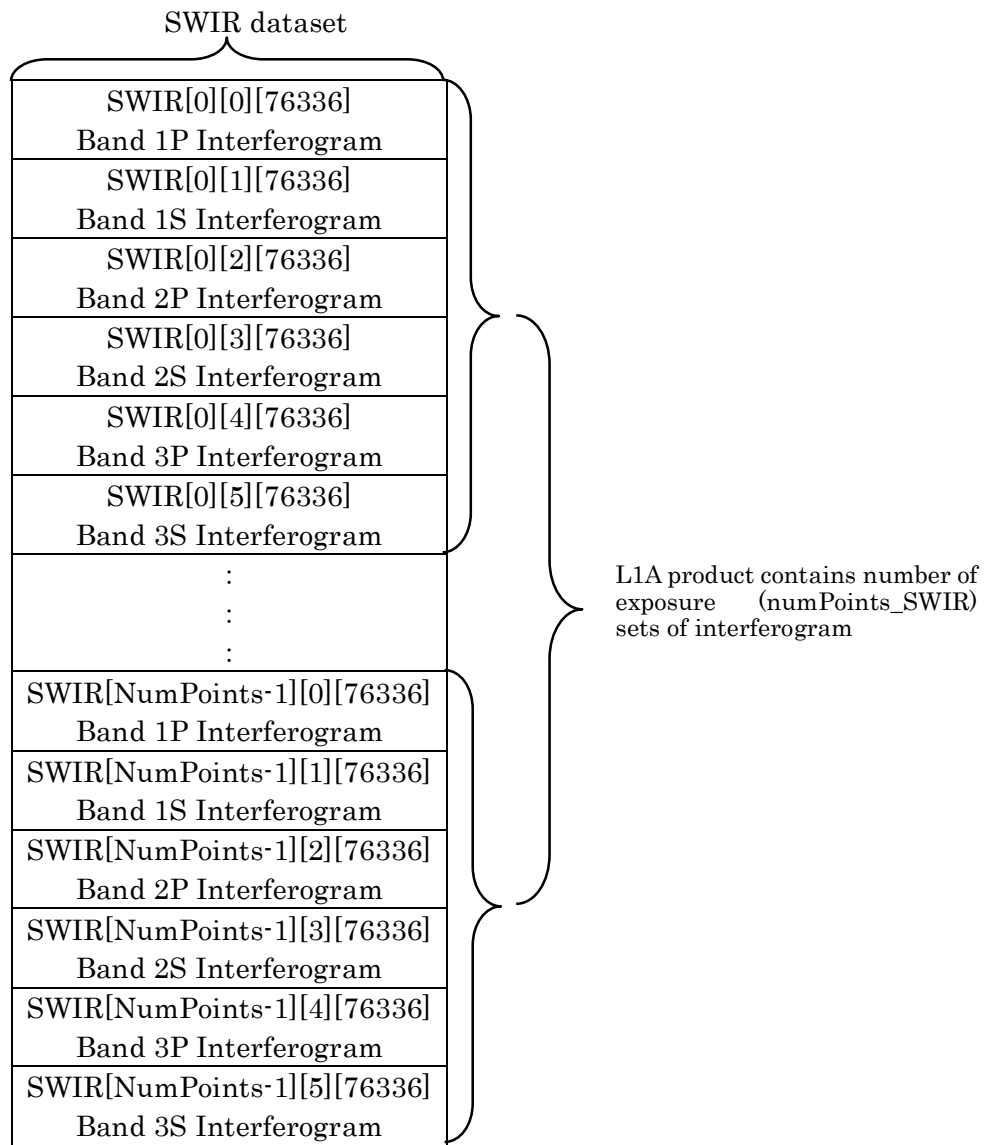

3-1 Details of Interferogram Format (SWIR)

Interferogram data (TIR) has following structure in L1A product

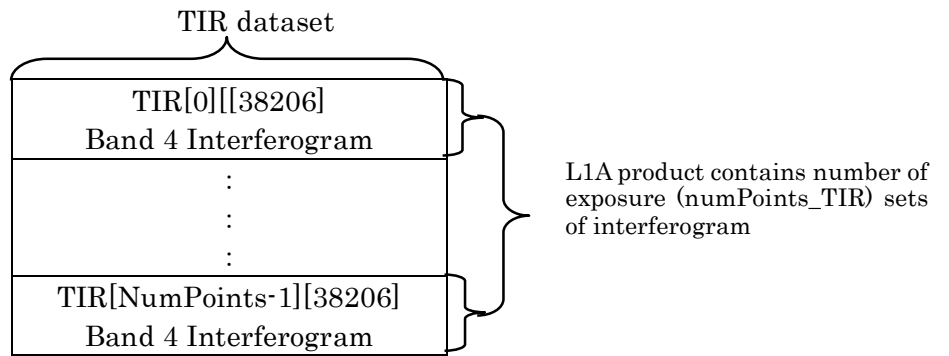

3-2 Details of Interferogram Format (TIR)

TANSO-FTS (Index\_SWIR/Index\_TIR)

In case day mode and night mode data mixed in a product, which may occur only for calibration product, the product includes index information to indicate the correspondence between SWIR and TIR interferogram/spectrum/telemetry (TLM) for each band in the following data structure.

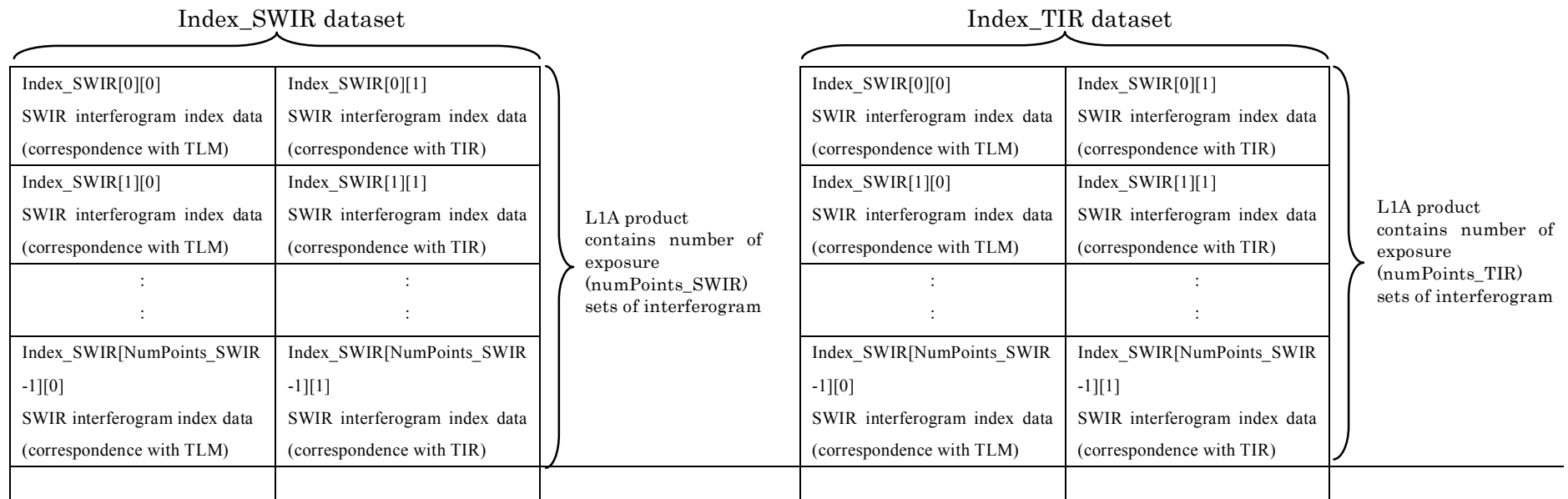

index\_SWIR[a][b] is defined for:

$$0 \leq a \leq \text{NumPoints\_SWIR}-1$$

$$0 \leq b \leq 1$$

Index\_SWIR[a][b] takes value range as follows:

$$1 \leq \text{SWIR}[a][0] \leq \text{numPoints} \text{ for } b=0$$

$$-1 \mid 1 \leq \text{SWIR}[a][1] \leq \text{numPoints\_TIR} \text{ for } b=1,$$

where -1 means no corresponding TIR data

Index\_TIR[a][b] is defined for:

$$0 \leq a \leq \text{NumPoints\_TIR}-1$$

$$0 \leq b \leq 1$$

Index\_TIR[a][b] takes value range as follows:

$$1 \leq \text{TIR}[a][0] \leq \text{numPoints} \text{ for } b=0$$

$$-1 \mid 1 \leq \text{TIR}[a][1] \leq \text{numPoints\_SWIR} \text{ for } b=1,$$

where -1 means no corresponding SWIR data

Figure 3-2 Details of Index (Index\_SWIR/Index\_TIR)

	SWIR dataset	Index_SWIR dataset	TIR dataset	Index_TIR dataset	TLM (temp, gain, etc)
Solar Irradiance Calibration SWIR + TIR 19 Exposures	SWIR[0][0][152672] 1st SWIR exposure	Index for 1 <sup>st</sup> SWIR exposure Index_SWIR[0][0]=1, corresponding TLM Index_SWIR[0][1]=1, corresponding TIR dataset	TIR[0][0][74363] 1st TIR exposure	Index for 1 <sup>st</sup> TIR exposure Index_TIR[0][0]=1, corresponding TLM Index_TIR[0][1]=1, corresponding SWIR dataset	TLM[0] 1st exposure
	:	:	:	:	:
	SWIR[18][0][152672] 19th SWIR exposure	Index for 19th SWIR exposure Index_SWIR[18][0]=19, corresponding TLM Index_SWIR[18][1]=19, corresponding TIR dataset	TIR[18][0][ 74363] 19th TIR exposure	Index for 19th TIR exposure Index_TIR[18][0]=19, corresponding TLM Index_TIR[18][1]=19, corresponding SWIR dataset	TLM[18] 19th exposure
Blackbody & Deep Space Calibration (night) TIR only No SWIR output 8 Exposures	No Data	No Data	TIR[19][0][ 74363] 20th TIR exposure	Index for 20th TIR exposure Index_TIR[19][0]=20, corresponding TLM Index_TIR[19][1]=20, corresponding SWIR dataset	TLM[19] 20th exposure
			:	:	:
			TIR[26][0][ 74363] 27th TIR exposure	Index for 20th TIR exposure Index_TIR[26][0]=27, corresponding TLM Index_TIR[27][1]=-1, corresponding SWIR dataset	TLM[26] 27th exposure
Sensor Mechanical Function Calibration SWIR only No TIR output 6 Exposures	SWIR[19][0][152672] 20th SWIR exposure	Index for 20th SWIR exposure Index_SWIR[19][0]=28, corresponding TLM Index_SWIR[19][1]=-1, corresponding TIR dataset	No Data	No Data	TLM[27] 28th exposure
	:	:			:
	SWIR[25][0][152672] 26th SWIR exposure	Index for 25th SWIR exposure Index_SWIR[24][0]=33, corresponding TLM Index_SWIR[25][1]=-1, corresponding TIR dataset			TLM[32] 33rd exposure
Blackbody & Deep Space Calibration (day) SWIR + TIR 8 Exposures	SWIR[25][0][152672] 26th SWIR exposure	Index for 26th SWIR exposure Index_SWIR[25][0]=34, corresponding TLM Index_SWIR[19][1]=28, corresponding TIR dataset	TIR[27][0][ 74363] 28th TIR exposure	Index for 28th TIR exposure Index_TIR[27][0]=34, corresponding TLM Index_TIR[27][1]=26, corresponding SWIR dataset	TLM[33] 34th exposure
	:	:	:	:	:
	SWIR[32][0][152672] 33rd SWIR exposure	Index for 33th SWIR exposure Index_SWIR[32][0]=41, corresponding TLM Index_SWIR[32][1]=35, corresponding TIR dataset	TIR[34][0][ 74363] 35th TIR exposure	Index for 35th TIR exposure Index_TIR[34][0]=41, corresponding TLM Index_TIR[34][1]=33, corresponding SWIR dataset	TLM[40] 41st exposure

Figure 3-3 Example of index contents (Index\_SWIR/Index\_TIR)



### 3.4. Format Details

Table 3-2 shows the details of TANSO-FTS Level 1 product format. Table below gives some notices on the expression used in product format description.

Expression	Note
UTC	<ul style="list-style-type: none"> <li>• Leap seconds included</li> <li>• Given by year, month, day, hour, minute, second unless otherwise specified</li> </ul>
Coordinate	<ul style="list-style-type: none"> <li>• In ECR unless otherwise specified</li> </ul>
Latitude	<ul style="list-style-type: none"> <li>• Goedetic latitude unless otherwise specified</li> </ul>
Sun Position	<ul style="list-style-type: none"> <li>•特に断りが無い限り、均時差を考慮したみかけの太陽位置で表される</li> </ul>

Each raw used in product format has following information.

Name of raw	Meanings
Grouppath/Dataset Name	If folder mark is set, it is in HDF5 group and has its name. Without folder mark, it is HDF5 dataset and has its name.
Database (Dimension)	Rand o HDF5 database. Database is given as attribute (Dimension Explanation) of dataset and in “String” data type.
Database (Size)	Size corresponding to each dimension is given.given. Ex.) If dimension is 2 and size is given as 4, 5, it can be expressed as array[4][5] in C language structure.
Attribute (Name of attribute)	Name in HDF5 attribute is given
Attribute (Number of attribute)	Number of attribute for its group/dataset is given.
Data Type	HDF5 のデータタイプを持つ。
Dataset Name (Japanese Name)	Japanese name for dataset is given
Explanation (Format)	<p>Format of contained value is given.</p> <p>If value to store is determined, candidate values are given in ””. If data type is H5T_NATIVE_CHAR, character array or 8 bit integer is given. For such cases, the expression in “ “ are given below.</p> <p>For character array, if the database (size) is larger than character array size, they are stored left-aligned and the left space are filled with null characters (0x00). If the database (size) and character array has same size, no null character is stored. In expression, null characters are omitted.</p> <p>For 8 bit integer, at the lead inside “ “, 0x indicating hex value is given in this document, while 0x is not stored in the actual string.</p> <p>If the data value has its effective range, minimum and maximum limit values are stored as string data type as attribute (Value Range).</p> <p>Inside (“ “), minimum and maximum values are given in this order separated by “,”.</p> <p>Ex.) (-90.0.90.0)</p>
Unit	If the data value has unit, this gives its unit C corresponds to temperature unit in Celsius.

Invalid value	Value given when the value cannot be derived or defined. Invalid value is given as attribute (Invalid Value) with date type of "String". Ex.) -8192
Note	Note is given if any

User definition dataset used in product format is followings. Year is given in AD with 4 digits. Month and day are given as integer starting from 1. Hour, minutes, and second are also given as integer starting from 0.

User Definition Dataset	Format
USERDATE_YMDHMS	USERDATE_YMDHMS { int year, char month, char day, char hour, char min, float sec }

### 3.5. Structure of Global Dataset

Contents included in global dataset are described below.

Table 3-2 Details of TANSO-FTS Product Format

Group Path/Dataset Name	Database		Attribute		Data Type	Dataset Name (Japanese Name)	Explanation (Format)	Unit	Invalid Value	Notes
	Dimension	Size	Name	Number						
Global										
MD_Metadata(JMP2.0 Data)										
fileIdentifier	1	60	-	0	H5T_NATIVE_CHAR	File Identifier (Granule ID) (ファイル識別子 (グラニューールID))	Granule ID Granule ID of this product (refer to NEB-060005 (Definition of EIS Granule ID "EISグラニューールID体系"), in Japanese)	-	-	Since satellite name information is included in granule ID, only granule ID is given here.
characterSet	1	3	-	0	H5T_NATIVE_CHAR	Character Set (文字集合)	"004": UTF-8 Fixed	-	-	
dateStamp	1	10	-	0	H5T_NATIVE_CHAR	Date Stamp (日付)	"YYYY-MM-DD" Date of product creation(UTC)	-	-	Time when creation job started is given.
hierarchyLevel	1	3	-	0	H5T_NATIVE_CHAR	Leven in Hierarchy (階層レベル)	"005": Header for dataset Fixed	-	-	
metadataStandardName	1	22	-	0	H5T_NATIVE_CHAR	Name of Metadata Standard (メタデータ規格の名称)	"Japan Metadata Profile" Fixed	-	-	
metadataStandardVersion	1	3	-	0	H5T_NATIVE_CHAR	Version of Metadata Standard (メタデータ規格の版)	"2.0" Fixed	-	-	
IdentificationInfo (Data Identification Information)										
MD_DataIdentification (Data Identification)										
abstract	1	256	-	0	H5T_NATIVE_CHAR	Abstract (要約)	"TBD":TBD Fixed	-	-	
purpose	1	256	-	0	H5T_NATIVE_CHAR	Purpose (目的)	Purpose of data to be given "TBD": TBD Fixed	-	-	
status	1	3	-	0	H5T_NATIVE_CHAR	Status (状態)	"001": Complete Fixed	-	-	In case processing aborts with error, this product is not output, therefore output always has value for "complete" status.
spatialRepresentationType	1	3	-	0	H5T_NATIVE_CHAR	Spatial Representation Type (空間表現型)	"001": Vector Fixed	-	-	
characterSet	1	3	-	0	H5T_NATIVE_CHAR	Character Set (文字集合)	"004": UTF-8 Fixed	-	-	
topicCategory	1	3	-	0	H5T_NATIVE_CHAR	Topics Category (主題分類)	"007": Environment Fixed	-	-	
citation(引用)										
title	1	23	-	0	H5T_NATIVE_CHAR	Title (題名)	"TANSO-FTS/GOSAT product" Fixed	-	-	
date(日付)										
date	1	10	-	0	H5T_NATIVE_CHAR	Date (日付)	"YYYY-MM-DD" Date of scene center (UTC) (year, month, day)	-	-	
dateType	1	3	-	0	H5T_NATIVE_CHAR	Date Type (日付型)	"001": creation date Fixed	-	-	

Table 3-2 Details of TANSO-FTS Product Format

NEB-080031

Group Path/Dataset Name	Database		Attribute		Data Type	Dataset Name (Japanese Name)	Explanation (Format)	Unit	Invalid Value	Notes
	Dimension	Size	Name	Number						
pointOfContact_01 (問い合わせ先)										
organisationName	1	41	-	0	H5T_NATIVE_CHAR	Organization Name (組織名)	"Japan Aerospace Exploration Agency (JAXA)" Fixed	-	-	
role	1	3	-	0	H5T_NATIVE_CHAR	Role (役割)	"005": Distributer Fixed	-	-	
contactInfo (問い合わせ情報)										
hoursOfService	1	81	-	0	H5T_NATIVE_CHAR	Hours of Service (案内時間)	"For inquiries hours: 9:30 to 17:45 (Japan Standard Time) on Monday through Friday" Fixed	-	-	
contactInstructions	1	53	-	0	H5T_NATIVE_CHAR	Instruction for Contact (問い合わせのための手引き)	"Contact point for JAXA's Principal Investigators (PI)" Fixed	-	-	
phone (電話番号)										
voice	1	14	-	0	H5T_NATIVE_CHAR	Voice Phone Number (電話番号)	"NNNN-NNNN-NNNN" Fixed (To be revised)	-	-	
facsimile	1	14	-	0	H5T_NATIVE_CHAR	Fax Number ファクシミリ番号	"NNNN-NNNN-NNNN" Fixed (To be revised)	-	-	
address (住所)										
deliveryPoint	1	35	-	0	H5T_NATIVE_CHAR	Street Address (住所詳細)	"Tsukuba space center, 2-1-1 Sengen" Fixed	-	-	
city	1	12	-	0	H5T_NATIVE_CHAR	City (市区町村)	"Tsukuba-city" Fixed	-	-	
administrativeArea	1	7	-	0	H5T_NATIVE_CHAR	Prefecture (都道府県名)	"Ibaraki" Fixed	-	-	
postalCode	1	8	-	0	H5T_NATIVE_CHAR	Zip Code (郵便番号)	"305-8505" Fixed	-	-	
country	1	3	-	0	H5T_NATIVE_CHAR	Country (国)	"jpn" Fixed	-	-	
electronicMailAddress	1	128	-	0	H5T_NATIVE_CHAR	e-mail address (電子メールアドレス)	"TBD" Fixed (To be revised)	-	-	
onlineResource (オンライン資源情報)										
linkage	1	25	-	0	H5T_NATIVE_CHAR	Linkage (リンク)	"http://www.eorc.jaxa.jp/" Fixed	-	-	
description	1	54	-	0	H5T_NATIVE_CHAR	Description (記述)	"JAXA Earth Observation Research Center (EORC) Web site" Fixed	-	-	

Table 3-2 Details of TANSO-FTS Product Format

NEB-080031

Group Path/Dataset Name	Database		Attribute		Data Type	Dataset Name (Japanese Name)	Explanation (Format)	Unit	Invalid Value	Notes
	Dimension	Size	Name	Number						
pointOfContact_02(問い合わせ先)										
organisationName	1	51	-	0	H5T_NATIVE_CHAR	Organization Name (組織名)	"National Institute for Environmental Studies (NIES)" Fixed	-	-	
role	1	3	-	0	H5T_NATIVE_CHAR	Role (役割)	"005": Distributer Fixed	-	-	
contactInfo(問い合わせ情報)										
hoursOfService	1	109	-	0	H5T_NATIVE_CHAR	Hours of Service (案内時間)	"For inquiries hours : 9:00 to 17:00 (Japan Standard Time) on Monday through Friday without Japanese holidays." Inquiries hours Fixed	-	-	
contactInstructions	1	56	-	0	H5T_NATIVE_CHAR	Instruction for Contact (問い合わせのための手引き)	"If there are any questions, please contact us by e-mail." Method for Inquiries Fixed	-	-	
phone(電話番号)										
voice	1	15	-	0	H5T_NATIVE_CHAR	Voice Phone Number (電話番号)	"+81-29-850-2035": Phone number Fixed	-	-	
facsimile	1	15	-	0	H5T_NATIVE_CHAR	Fax Number ファクシミリ番号	"+81-29-850-2219": Fax number Fixed	-	-	
address(住所)										
deliveryPoint	1	12	-	0	H5T_NATIVE_CHAR	Street Address (住所詳細)	"16-2 Onogawa": Street Address Fixed	-	-	
city	1	12	-	0	H5T_NATIVE_CHAR	City (市区町村)	"Tsukuba-city": City Address Fixed	-	-	
administrativeArea	1	7	-	0	H5T_NATIVE_CHAR	Prefecture (都道府県名)	"Ibaraki": Prefecture in Address Fixed	-	-	
postalCode	1	8	-	0	H5T_NATIVE_CHAR	Zip Code (郵便番号)	"305-8506": Zip code Fixed	-	-	
country	1	3	-	0	H5T_NATIVE_CHAR	Country (国)	"jpn" Fixed	-	-	
electronicMailAddress	1	21	-	0	H5T_NATIVE_CHAR	e-mail address (電子メールアドレス)	"gosat-prj1@nies.go.jp": e-mail address Fixed	-	-	
onlineResource(オンライン資源情報)										
linkage	1	128	-	0	H5T_NATIVE_CHAR	Linkage (リンク)	"TBD": Linkage Fixed (To be revised)	-	-	
description	1	128	-	0	H5T_NATIVE_CHAR	Description (記述)	"TBD": Description Fixed (To be revised)	-	-	

Table 3-2 Details of TANSO-FTS Product Format

NEB-080031

Group Path/Dataset Name	Database		Attribute		Data Type	Dataset Name (Japanese Name)	Explanation (Format)	Unit	Invalid Value	Notes
	Dimension	Size	Name	Number						
resourceConstraints (資源の節約)										
MD_Constraints										
useLimitation	1	1024	-	0	H5T_NATIVE_CHAR	Limitation for use (利用制限)	EULA of JAXA will be included here. "TBD":TBD Fixed	-	-	
descriptiveKeywords (記述的キーワード)										
MD_Keywords										
keyword	1	16	-	0	H5T_NATIVE_CHAR	Keyword (キーワード)	"GOSAT, TANSO-FTS" Fixed	-	-	
type	1	3	-	0	H5T_NATIVE_CHAR	Type (型)	"005": Type Fixed	-	-	
graphicOverview (概要の図示)										
MD_BrowseGraphic										
filename	1	14	-	0	H5T_NATIVE_CHAR	Filename (ファイル名)	"NO BROWSE DATA" Fixed No browse data is defined for this product	-	-	Since filename is always "NO BROWSE DATA" there is no fileDescription or FileType dataset.
spatialResolution (空間解像度)										
distance										
value	1	10	-	0	H5T_NATIVE_CHAR	Value (空間解像度の値)	"10500" Fixed Nominal value for zenith observation is given. Invalid value is given for calibration product.	-	-1	Unit is given in "name" column below.
uom										
UnitOfMeasure										
name	1	5	-	0	H5T_NATIVE_CHAR	Unit (単位の名称)	"Meter" Fixed	-	-	
measurementType	1	8	-	0	H5T_NATIVE_CHAR	Type of Measurement (測定の種類)	"distance" Fixed	-	-	
language (言語)										
isoCode	1	3	-	0	H5T_NATIVE_CHAR	ISO Code (言語コード)	"eng": English Fixed	-	-	
extent (範囲)										
TemporalElement (時間要素)										
EX_TemporalExtent										
extent										
beginEnd										
begin	1	10	-	0	H5T_NATIVE_CHAR	Start Date (データ開始日)	"YYYY-MM-DD" Date of the last exposure in the product in UTC is given.	-	-	
end	1	10	-	0	H5T_NATIVE_CHAR	End Date (データ終了日)	"YYYY-MM-DD" Date of the first exposure in the product in UTC is given.	-	-	

Table 3-2 Details of TANSO-FTS Product Format

Group Path/Dataset Name	Database		Attribute		Data Type	Dataset Name (Japanese Name)	Explanation (Format)	Unit	Invalid Value	Notes
	Dimension	Size	Name	Number						
geographicElement (地理要素)										
EX_GeographicBoundingBox										
extentTypeCode	1	1	-	0	H5T_NATIVE_CHAR	Extent Type Code (範囲型符号)	"1": All "geographicElement" data are within the bounding box. Fixed	-	-	
westBoundLongitude	1	20	-	0	H5T_NATIVE_CHAR	Western Boundary Longitude (西側境界経度)	Longitude of the westernmost point is given. "snnn.nnn" s: "-" is for west longitude n: digit	deg	-8192	Longitude of westernmost point among all geolocation information included in the product.
eastBoundLongitude	1	20	-	0	H5T_NATIVE_CHAR	Eastern Boundary Longitude (東側境界経度)	Longitude of the easternmost point is given. "snnn.nnn" s: "-" is for west longitude n: digit	deg	-8192	Longitude of easternmost point among all geolocation information included in the product.
southBoundLatitude	1	20	-	0	H5T_NATIVE_CHAR	Southern Boundary Latitude (南側境界緯度)	Latitude of the southernmost point is given. "snnn.nnn" s: "-" is for south latitude n: digit	deg	-8192	Latitude of southernmost point among all geolocation information included in the product.
northBoundLatitude	1	20	-	0	H5T_NATIVE_CHAR	Northern Boundary Latitude (北側境界緯度)	Latitude of the northernmost point is given. "snnn.nnn" s: "-" is for south latitude n: digit	deg	-8192	Latitude of northernmost point among all geolocation information included in the product.
extentReferenceSystem										
code	1	14	-	0	H5T_NATIVE_CHAR	Code (符号)	"GRS80 / ITRF97" Fixed	-	-	



Table 3-2 Details of TANSO-FTS Product Format

NEB-080031

Group Path/Dataset Name	Database		Attribute		Data Type	Dataset Name (Japanese Name)	Explanation (Format)	Unit	Invalid Value	Notes
	Dimension	Size	Name	Number						
dataQualityInfo (品質情報)										
DQ_DataQuality										
scope (適用範囲)										
level	1	3	-	0	H5T_NATIVE_CHAR	Data Quality Level (データ品質情報が指すレベル)	"005" : Dataset Fixed	-	-	
report (報告)										
DQ_Element_01										
							DQ_Element may appear couple of times in a product with different contents. Explanation below gives all possible contents for each DQ_Element. To tell which explanation is for which DQ_Element "typeOfQualityEvaluation" and "Explanation" column should be referred.			
typeOfQualityEvaluation	1	3	-	0	H5T_NATIVE_CHAR	Type of Quality Evaluation (データ品質要素型)	"004" : Consistency in logic and domain of definition Fixed	-	-	
result (結果)										
DQ_ConformanceResult (適合性の結果)										
Explanation	1	100	-	0	H5T_NATIVE_CHAR	Explanation (説明)	"Data Processing software automatically checks the sensor temperature with the pre-defined threshold." Fixed	-	-	Information on if temperature telemetry exceeds threshold value region.
pass	1	1	-	0	H5T_NATIVE_CHAR	Pass (合否)	0: Failure 1: Pass	-	-	In case for OK or FAIR, "1" (Pass) is given
specification (仕様)										
title	1	256	-	0	H5T_NATIVE_CHAR	Title (文書名)	"TBD" Fixed * JAXA document title describing GOSAT data quality is to be	-	-	
date										
date	1	10	-	0	H5T_NATIVE_CHAR	Date (日付)	"YYYY-MM-DD" The date in JST of creation, issue, or revision of the document specified above is given.	-	-	
dateType	1	3	-	0	H5T_NATIVE_CHAR	Date Type (日付型)	"NNN" "001", "002", or "003"	-	-	001: Date of creation 002: Date of issue 003: Date of revision
DQ_QuantitativeResult (定量的結果)										
valueUnit										
name	1	7	-	0	H5T_NATIVE_CHAR	Unit (単位の名称)	"percent" Fixed	-	-	
measurementType	1	10	-	0	H5T_NATIVE_CHAR	Type of Measurement (測定の種類)	"percentage" Fixed	-	-	
value										
otherValue	1	6	-	0	H5T_NATIVE_CHAR	Calculated Value (測定値)	"nnn.nn" Percentage of "FAIR" evaluation out of all temperature telemetry used for this product	-	-	Calculated from temperature telemetry evaluation result in data processing

Table 3-2 Details of TANSO-FTS Product Format

NEB-080031

Group Path/Dataset Name	Database		Attribute		Data Type	Dataset Name (Japanese Name)	Explanation (Format)	Unit	Invalid Value	Notes
	Dimension	Size	Name	Number						
DQ_Element_02										
typeOfQualityEvaluation	1	3	-	0	H5T_NATIVE_CHAR	Type of Quality Evaluation (データ品質要素型)	"005": Consistency in logic and domain of definition Fixed	-	-	
result(結果)										
DQ_ConformanceResult(適合性の結果)										
Explanation	1	111	-	0	H5T_NATIVE_CHAR	Explanation (説明)	"Data Processing software automatically checks the format consistency with the pre-defined format specification." Fixed	-	-	
pass	1	1	-	0	H5T_NATIVE_CHAR	Pass (合否)	"1": Pass "0": Failure	-	-	Fixed.
specification(仕様)										
title	1	256	-	0	H5T_NATIVE_CHAR	Title (文書名)	"TBD" Fixed *Document Title of L1 product format document will be given.	-	-	
date										
date	1	10	-	0	H5T_NATIVE_CHAR	Date (日付)	"YYYY-MM-DD" The date in JST of creation, issue, or revision of the document specified above is given.	-	-	
dateType	1	3	-	0	H5T_NATIVE_CHAR	Date Type (日付型)	"NNN" "001", "002", or "003"	-	-	001: Date of creation 002: Date of issue 003: Date of revision

Table 3-2 Details of TANSO-FTS Product Format

NEB-080031

Group Path/Dataset Name	Database		Attribute		Data Type	Dataset Name (Japanese Name)	Explanation (Format)	Unit	Invalid Value	Notes
	Dimension	Size	Name	Number						
DQ_Element_03										
typeOfQualityEvaluation	1	3	-	0	H5T_NATIVE_CHAR	Type of Quality Evaluation (データ品質要素型)	"007": Position Accuracy/Absolute Accuracy Fixed		-	Accuracy of geolocation will be given after evaluation.
result(結果)										
DQ_ConformanceResult(適合性の結果)										
Explanation	1	143	-	0	H5T_NATIVE_CHAR	Explanation (説明)	"Data Center confirmed the geometric accuracy (i.e.) error between the location of data pixel location and the location of ground control point." Fixed	-	-	Explanation will be given after geometrical evaluation.
pass	1	1	-	0	H5T_NATIVE_CHAR	Pass (合否)	"1": Pass "0": Failure	-	-	Fixed.
specification(仕様)										
title	1	256	-	0	H5T_NATIVE_CHAR	Title (文書名)	"TBD" Fixed * JAXA document title describing GOSAT data quality is to be	-	-	
date										
date	1	10	-	0	H5T_NATIVE_CHAR	Date (日付)	"YYYY-MM-DD" The date in JST of creation, issue, or revision of the document specified above is given.	-	-	
dateType	1	3	-	0	H5T_NATIVE_CHAR	Date Type (日付型)	"NNN" "001", "002", or "003"	-	-	001: Date of creation 002: Date of issue 003: Date of revision

Table 3-2 Details of TANSO-FTS Product Format

Group Path/Dataset Name	Database		Attribute		Data Type	Dataset Name (Japanese Name)	Explanation (Format)	Unit	Invalid Value	Notes
	Dimension	Size	Name	Number						
DQ_Element_04										
typeOfQualityEvaluation	1	3	-	0	H5T_NATIVE_CHAR	Type of Quality Evaluation (データ品質要素型)	"015": Accuracy of classification and quantitative attribute Fixed	-	-	Geolocation accuracy will be given later with evaluation results after launch
result (結果)										
DQ_ConformanceResult (適合性の結果)										
Explanation	1	76	-	0	H5T_NATIVE_CHAR	Explanation (説明)	"Data Processing software automatically checks the sensor exposure stability." Fixed	-	-	To provide status information for FOV stability during the exposure
pass	1	1	-	0	H5T_NATIVE_CHAR	Pass (合否)	"1": Pass "0": Failure	-	-	
specification (仕様)										
title	1	256	-	0	H5T_NATIVE_CHAR	Title (文書名)	"TBD" Fixed * JAXA document title describing GOSAT data quality is to be	-	-	
date										
date	1	10	-	0	H5T_NATIVE_CHAR	Date (日付)	"YYYY-MM-DD" The date in JST of creation, issue, or revision of the document specified above is given.	-	-	
dateType	1	3	-	0	H5T_NATIVE_CHAR	Date Type (日付型)	"NNN" "001", "002", or "003"	-	-	001: Date of creation 002: Date of issue 003: Date of revision
DQ_QuantitativeResult (定量的結果)										
valueUnit										
name	1	7	-	0	H5T_NATIVE_CHAR	Unit (単位の名称)	"percent" Fixed	-	-	Percentage of exposures whose FOV are stable out of all exposures included in this product
measurementType	1	10	-	0	H5T_NATIVE_CHAR	Type of Measurement (測定の種類)	"percentage" Fixed	-	-	
value										
otherValue	1	6	-	0	H5T_NATIVE_CHAR	Other Value (測定値)	"nnn.nn" Percentage of exposures whose FOV are stable during each exposure out of all exposures in this product	-	-	

Table 3-2 Details of TANSO-FTS Product Format

NEB-080031

Group Path/Dataset Name	Database		Attribute		Data Type	Dataset Name (Japanese Name)	Explanation (Format)	Unit	Invalid Value	Notes
	Dimension	Size	Name	Number						
DQ_Element_05										
typeOfQualityEvaluation	1	3	-	0	H5T_NATIVE_CHAR	Type of Quality Evaluation (データ品質要素型)	"012": Accuracy and adequacy of time Fixed	-	-	
result(結果)										
DQ_ConformanceResult(適合性の結果)										
Explanation	1	73	-	0	H5T_NATIVE_CHAR	Explanation (説明)	"Data Center confirmed the time calculation error below nominal threshold." Fixed	-	-	
pass	1	1	-	0	H5T_NATIVE_CHAR	Pass (合否)	"1": Pass "0": Failure	-	-	1 Fixed
specification(仕様)										
title	1	256	-	0	H5T_NATIVE_CHAR	Title (文書名)	"TBD" Fixed * JAXA document title describing GOSAT data quality is to be	-	-	
date										
date	1	10	-	0	H5T_NATIVE_CHAR	Date (日付)	"YYYY-MM-DD" The date in JST of creation, issue, or revision of the document specified above is given.	-	-	
dateType	1	3	-	0	H5T_NATIVE_CHAR	Date Type (日付型)	"NN" "001", "002", or "003"	-	-	001: Date of creation 002: Date of issue 003: Date of revision

Table 3-2 Details of TANSO-FTS Product Format

NEB-080031

Group Path/Dataset Name	Database		Attribute		Data Type	Dataset Name (Japanese Name)	Explanation (Format)	Unit	Invalid Value	Notes
	Dimension	Size	Name	Number						
DQ_Element_06										
typeOfQualityEvaluation	1	3	-	0	H5T_NATIVE_CHAR	Type of Quality Evaluation (データ品質要素型)	"014": Accuracy of classification and quantitative attribute Fixed	-	-	
result(結果)										
DQ_ConformanceResult(適合性の結果)										
Explanation	1	221	-	0	H5T_NATIVE_CHAR	Explanation (説明)	"The gain is switched by the analog signal processing Component. There are 3 types of gain, H, M, and L. Gain (band1P): GAIN_X Gain (band2P): GAIN_X Gain (band3P): GAIN_X Gain (band1S): GAIN_X Gain (band2S): GAIN_X Gain (band3S): GAIN_X Gain (band4): -" GAIN_X is given as one of 3 types above basically, but for band without available gain information "NA" is given.	-	-	
pass	1	1	-	0	H5T_NATIVE_CHAR	Pass (合否)	"1": Pass "0": Failure	-	-	"0" Failure is given if the gain telemetry is other than H, M.
specification(仕様)										
title	1	256	-	0	H5T_NATIVE_CHAR	Title (文書名)	"TBD" Fixed *Document title for S00H will be given.	-	-	
date										
date	1	10	-	0	H5T_NATIVE_CHAR	Date (日付)	"YYYY-MM-DD" The date in JST of creation, issue, or revision of the document specified above is given.	-	-	
dateType	1	3	-	0	H5T_NATIVE_CHAR	Date Type (日付型)	"NNN" "001", "002", or "003"	-	-	001: Date of creation 002: Date of issue 003: Date of revision

Table 3-2 Details of TANSO-FTS Product Format

Group Path/Dataset Name	Database		Attribute		Data Type	Dataset Name (Japanese Name)	Explanation (Format)	Unit	Invalid Value	Notes
	Dimension	Size	Name	Number						
DO_Element_07										
typeOfQualityEvaluation	1	3	-	0	H5T_NATIVE_CHAR	Type of Quality Evaluation (データ品質要素型)	"015": Accuracy of classification and quantitative attribute Fixed	-	-	
result(結果)										
DO_ConformanceResult(適合性の結果)										
Explanation	1	132	-	0	H5T_NATIVE_CHAR	Explanation (説明)	"TBD" Sentence like "Data Center confirmed the radiometric accuracy base below nominal threshold. Relative accuracy XXX% (1sigma) Absolute accuracy YYY%(1sigma)" will be stored. Fixed	-	-	
pass	1	1	-	0	H5T_NATIVE_CHAR	Pass (合否)	"1": Pass "0": Failure	-	-	1 Fixed (With rare exception case)
specification(仕様)										
title	1	256	-	0	H5T_NATIVE_CHAR	Title (文書名)	"TBD" Fixed * JAXA document title describing GOSAT data quality is to be	-	-	
date										
date	1	10	-	0	H5T_NATIVE_CHAR	Date (日付)	"YYYY-MM-DD" The date in JST of creation, issue, or revision of the document specified above is given.	-	-	
dateType	1	3	-	0	H5T_NATIVE_CHAR	Date Type (日付型)	"NNN" "001", "002", or "003"	-	-	001: Date of creation 002: Date of issue 003: Date of revision

Table 3-2 Details of TANSO-FTS Product Format

NEB-080031

Group Path/Dataset Name	Database		Attribute		Data Type	Dataset Name (Japanese Name)	Explanation (Format)	Unit	Invalid Value	Notes
	Dimension	Size	Name	Number						
DQ_Element_08										
typeOfQualityEvaluation	1	3	-	0	H5T_NATIVE_CHAR	Type of Quality Evaluation (データ品質要素型)	"004": Consistency in logic and domain of definition Fixed	-	-	
result(結果)										
DQ_ConformanceResult(適合性の結果)										
Explanation	1	162	-	0	H5T_NATIVE_CHAR	Explanation (説明)	"Data processing software automatically evaluates the orbit data quality. OK: PCD error ratio 0-AA % FAIR: PCD error ratio BB-100 % Not Used: PCD does not be used." Fixed Values calculated from processing parameters will be stored for AA and BB.	-	-	
pass	1	1	-	0	H5T_NATIVE_CHAR	Pass (合否)	"1": Pass "0": Failure	-	-	
specification(仕様)										
title	1	256	-	0	H5T_NATIVE_CHAR	Title (文書名)	"TBD" Fixed * JAXA document title describing GOSAT data quality is to be	-	-	
date										
date	1	10	-	0	H5T_NATIVE_CHAR	Date (日付)	"YYYY-MM-DD" The date in JST of creation, issue, or revision of the document specified above is given.	-	-	
dateType	1	3	-	0	H5T_NATIVE_CHAR	Date Type (日付型)	"NNN" "001", "002", or "003"	-	-	001: Date of creation 002: Date of issue 003: Date of revision
DQ_QuantitativeResult(定量的結果)										
valueUnit										
name	1	7	-	0	H5T_NATIVE_CHAR	Unit (単位の名称)	"percent" Fixed	-	-	
measurementType	1	10	-	0	H5T_NATIVE_CHAR	Type of Measurement (測定の種類)	"percentage" Fixed	-	-	
value										
otherValue	1	6	-	0	H5T_NATIVE_CHAR	Other Value (測定値)	"nnn.nn" Percentage of abnormal PCD (ephemeris) data out of all PCD data used in processing this product.	-	-1	



Table 3-2 Details of TANSO-FTS Product Format

Group Path/Dataset Name	Database		Attribute		Data Type	Dataset Name (Japanese Name)	Explanation (Format)	Unit	Invalid Value	Notes
	Dimension	Size	Name	Number						
DQ_Element_09										
typeOfQualityEvaluation	1	3	-	0	H5T_NATIVE_CHAR	Type of Quality Evaluation (データ品質要素型)	"004": Consistency in logic and domain of definition Fixed	-	-	
result(結果)										
DQ_ConformanceResult(適合性の結果)										
Explanation	1	165	-	0	H5T_NATIVE_CHAR	Explanation (説明)	"Data processing software automatically evaluates the attitude data quality. OK: PCD error ratio 0-AA % FAIR: PCD error ratio BB-100 % Not Used: PCD does not be used." Fixed Values calculated from processing parameters will be stored for AA and BB.	-	-	
pass	1	1	-	0	H5T_NATIVE_CHAR	Pass (合否)	"1": Pass "0": Failure	-	-	
specification(仕様)										
title	1	256	-	0	H5T_NATIVE_CHAR	Title (文書名)	"TBD" Fixed * JAXA document title describing GOSAT data quality is to be given.	-	-	
date										
date	1	10	-	0	H5T_NATIVE_CHAR	Date (日付)	"YYYY-MM-DD" The date in JST of creation, issue, or revision of the document specified above is given.	-	-	
dateType	1	3	-	0	H5T_NATIVE_CHAR	Date Type (日付型)	"NN" "001", "002", or "003"	-	-	001: Date of creation 002: Date of issue 003: Date of revision
DQ_QuantitativeResult(定量的結果)										
valueUnit										
name	1	7	-	0	H5T_NATIVE_CHAR	Unit (単位の名称)	"percent" Fixed	-	-	Percentage of PCD within expected range out of all PCD used in processing of this product
measurementType	1	10	-	0	H5T_NATIVE_CHAR	Type of Measurement (測定の種類)	"percentage" Fixed	-	-	
value										
otherValue	1	6	-	0	H5T_NATIVE_CHAR	Other Value (測定値)	"nn.nn" Percentage of abnormal PCD (ephemeris) data out of all PCD data used in processing this product.	-	-	

Table 3-2 Details of TANSO-FTS Product Format

Group Path/Dataset Name	Database		Attribute		Data Type	Dataset Name (Japanese Name)	Explanation (Format)	Unit	Invalid Value	Notes
	Dimension	Size	Name	Number						
DQ_Element_10										
typeOfQualityEvaluation	1	3	-	0	H5T_NATIVE_CHAR	Type of Quality Evaluation (データ品質要素型)	"015": Accuracy of classification and quantitative attribute Fixed	-	-	
result(結果)										
DQ_ConformanceResult(適合性の結果)										
Explanation	1	205	-	0	H5T_NATIVE_CHAR	Explanation (説明)	"Data processing software automatically evaluates the data quality. G00D: Exposure loss ratio AA - BB% FAIR: Exposure loss ratio CC - DD% POOR: Exposure loss ratio EE - FF% This product quality is ZZZZ." : Explanation Fixed Values or words registered as processing parameters are stored for AA, BB, CC, DD, EE, and FF.	-	-	
pass	1	1	-	0	H5T_NATIVE_CHAR	Pass (合否)	"1": Pass "0": Failure	-	-	1 Fixed (With rare exception)
specification(仕様)										
title	1	256	-	0	H5T_NATIVE_CHAR	Title (文書名)	"TBD" Fixed * JAXA document title describing GOSAT data quality is to be given.	-	-	
date										
date	1	10	-	0	H5T_NATIVE_CHAR	Date (日付)	"YYYY-MM-DD" The date in JST of creation, issue, or revision of the document specified above is given.	-	-	
dateType	1	3	-	0	H5T_NATIVE_CHAR	Date Type (日付型)	"NN" "001", "002", or "003"	-	-	001: Date of creation 002: Date of issue 003: Date of revision
DQ_QuantitativeResult(定量的結果)										
valueUnit										
name	1	7	-	0	H5T_NATIVE_CHAR	Unit (単位の名称)	"percent" Fixed	-	-	
measurementType	1	10	-	0	H5T_NATIVE_CHAR	Type of Measurement (測定の種類)	"percentage" Fixed	-	-	
value										
otherValue	1	6	-	0	H5T_NATIVE_CHAR	Other Value (測定値)	"nn.nn" Percentage of missing interferograms out of all exposures.	-	-	

Table 3-2 Details of TANSO-FTS Product Format

Group Path/Dataset Name	Database		Attribute		Data Type	Dataset Name (Japanese Name)	Explanation (Format)	Unit	Invalid Value	Notes
	Dimension	Size	Name	Number						
MD_Distribution										
distributionFormat (配布書式)										
MD_Format										
name	1	3	-	0	H5T_NATIVE_CHAR	Name of Format (書式名)	"HDF" Fixed	-	-	
version	1	1	-	0	H5T_NATIVE_CHAR	Version of Format (バージョン)	"5" Fixed	-	-	
transferOptions (交換任意選択)										
MD_DigitalTransferOptions										
offline (オフライン)										
name	1	3	-	0	H5T_NATIVE_CHAR	Name (媒体名)	"015" : オンライン Fixed	-	-	
online (オンライン)										
linkage	1	128	-	0	H5T_NATIVE_CHAR	Linkage (リンク)	"TBD" Fixed	-	-	
description	1	33	-	0	H5T_NATIVE_CHAR	Description (記述)	"Available to only Registered User" Fixed	-	-	
referenceSystemInfo (参照系情報)										
MD_ReferenceSystem										
referenceSystemIdentifier (参照系識別)										
code	1	14	-	0	H5T_NATIVE_CHAR	Code (符号)	"GRS0 / ITRF97" Fixed	-	-	
language										
isoCode	1	3	-	0	H5T_NATIVE_CHAR	ISO Code (言語コード)	"eng" : English Fixed	-	-	

Table 3-2 Details of TANSO-FTS Product Format

Group Path/Dataset Name	Database		Attribute		Data Type	Dataset Name (Japanese Name)	Explanation (Format)	Unit	Invalid Value	Notes
	Dimension	Size	Name	Number						
contact_01(問い合わせ先)										
organisationName	1	41	-	0	H5T_NATIVE_CHAR	Organization Name (組織名)	"Japan Aerospace Exploration Agency (JAXA)" Fixed	-	-	
role	1	3	-	0	H5T_NATIVE_CHAR	Role (役割)	"001": Information provider Fixed	-	-	
contactInfo										
hoursOfService	1	81	-	0	H5T_NATIVE_CHAR	Hours of Service (案内時間)	"For inquiries hours: 9:30 to 17:45 (Japan Standard Time) on Monday through Friday" Fixed	-	-	
contactInstructions	1	56	-	0	H5T_NATIVE_CHAR	Instruction for Contact (問い合わせのための手引き)	"If there are any questions, please contact us by e-mail." Fixed	-	-	
phone(電話番号)										
voice	1	14	-	0	H5T_NATIVE_CHAR	Voice Phone Number (電話番号)	"NNNN-NNNN-NNNN" Fixed (TBD)	-	-	
facsimile	1	14	-	0	H5T_NATIVE_CHAR	Fax Number ファクシミリ番号	"NNNN-NNNN-NNNN" Fixed (TBD)	-	-	
address(住所)										
deliveryPoint	1	34	-	0	H5T_NATIVE_CHAR	Street Address (住所詳細)	"Tsukuba space center, 2-1-1 Sengen" Fixed	-	-	
city	1	12	-	0	H5T_NATIVE_CHAR	City (市区町村)	"Tsukuba-city" Fixed	-	-	
administrativeArea	1	7	-	0	H5T_NATIVE_CHAR	Prefecture (都道府県名)	"Ibaraki" Fixed	-	-	
postalCode	1	8	-	0	H5T_NATIVE_CHAR	Zip Code (郵便番号)	"305-8505" Fixed	-	-	
country	1	3	-	0	H5T_NATIVE_CHAR	Country (国)	"jpn" Fixed	-	-	
electronicMailAddress	1	128	-	0	H5T_NATIVE_CHAR	e-mail address (電子メールアドレス)	"TBD" Fixed	-	-	
onlineResource(オンライン資源情報)										
linkage	1	25	-	0	H5T_NATIVE_CHAR	Linkage (リンク)	"http://www.eorc.jaxa.jp/" Fixed	-	-	
description	1	54	-	0	H5T_NATIVE_CHAR	Description (記述)	"JAXA Earth Observation Research Center (EORC) Web site" Fixed	-	-	

Table 3-2 Details of TANSO-FTS Product Format

Group Path/Dataset Name	Database		Attribute		Data Type	Dataset Name (Japanese Name)	Explanation (Format)	Unit	Invalid Value	Notes
	Dimension	Size	Name	Number						
contact_02(問い合わせ先)										
organisationName	1	51			H5T_NATIVE_CHAR	Organization Name (組織名)	"National Institute for Environmental Studies (NIES)" Fixed	-	-	
role	1	3			H5T_NATIVE_CHAR	Role (役割)	"001": Information provider Fixed	-	-	
contactInfo										
hoursOfService	1	109	-	0	H5T_NATIVE_CHAR	Hours of Service (案内時間)	"For inquiries hours : 9:00 to 17:00 (Japan Standard Time) on Monday through Friday without Japanese holidays." : Inquiries hours Fixed	-	-	
contactInstructions	1	56	-	0	H5T_NATIVE_CHAR	Instruction for Contact (問い合わせのための手引き)	"If there are any questions, please contact us by e-mail." : Instruction for contact Fixed	-	-	
phone(電話番号)										
voice	1	15	-	0	H5T_NATIVE_CHAR	Voice Phone Number (電話番号)	"+81-29-850-2035" : Phone number Fixed	-	-	
facsimile	1	15	-	0	H5T_NATIVE_CHAR	Fax Number ファクシミリ番号	"+81-29-850-2219" : Fax number Fixed	-	-	
address(住所)										
deliveryPoint	1	12	-	0	H5T_NATIVE_CHAR	Street Address (住所詳細)	"16-2 Onogawa" : Street address Fixed	-	-	
city	1	12	-	0	H5T_NATIVE_CHAR	City (市区町村)	"Tsukuba-city" : City address Fixed	-	-	
administrativeArea	1	7	-	0	H5T_NATIVE_CHAR	Prefecture (都道府県名)	"Ibaraki" : Prefecture address Fixed	-	-	
postalCode	1	8	-	0	H5T_NATIVE_CHAR	Zip Code (郵便番号)	"305-8506" : Zip code Fixed	-	-	
country	1	3	-	0	H5T_NATIVE_CHAR	Country (国)	"jpn" : Country Fixed	-	-	
electronicMailAddress	1	21	-	0	H5T_NATIVE_CHAR	e-mail address (電子メールアドレス)	"gosat-prj1@nies.go.jp" : e-mail address Fixed	-	-	
onlineResource(オンライン資源情報)										
linkage	1	128	-	0	H5T_NATIVE_CHAR	Linkage (リンク)	"TBD" : Linkage Fixed	-	-	
description	1	128	-	0	H5T_NATIVE_CHAR	Description (記述)	"TBD" : Description Fixed	-	-	

Table 3-2 Details of TANSO-FTS Product Format

Group Path/Dataset Name	Database		Attribute		Data Type	Dataset Name (Japanese Name)	Explanation (Format)	Unit	Invalid Value	Notes
	Dimension	Size	Name	Number						
☐ metadata (JMP2.0以外のメタ情報)										
satelliteName	1	5	-	0	H5T_NATIVE_CHAR	Satellite Name (衛星名)	"GOSAT": Greenhouse gases Observing SATellite Fixed	-	-	
sensorName	1	9	-	0	H5T_NATIVE_CHAR	Sensor Name (センサ名)	"TANSO-FTS": Greenhouse gases sensor Fixed	-	-	
observationMode	1	4	-	0	H5T_NATIVE_CHAR	Observation Mode (Product Name) (観測モード(プロダクト名))	"OB1D": Observation Mode I (day) "OB1N": Observation Mode I (night) "OB2D": Observation Mode II (day) "SP0D": Target Mode (day) "SP0N": Target Mode (night) "CALM": Calibration Mode (except for Lunar Calibration) "LUCA": Lunar Calibration Mode	-	-	This value is set using granule ID in processing control information
numBand	1	1	-	0	H5T_NATIVE_LONG	Number of Band (全バンド数)	"7" Fixed	-	-	
points	1	numBand	-	0	H5T_NATIVE_LONG	Number of Exposures in Product (***** (観測点数) (Numbers of exposures in product are stored in order of Band1P, Band1S.	Number of exposures (including missing exposures)	-	-	
missingPoints	1	numBand	-	0	H5T_NATIVE_LONG	Number of Missing Points (欠損観測回数)	Number of lost interferogram during data downlink from the satellite to ground stations out of all interferogram in this product	-	-	
operationLevel	1	3	-	0	H5T_NATIVE_CHAR	Processing Level (処理レベル)	"LIA" "LIB"	-	-	
algorithmName	1	7	-	0	H5T_NATIVE_CHAR	Name of Algorithm (アルゴリズム名)	Algorithm name indicated in processing control information	-	-	
algorithmVersion	1	3	-	0	H5T_NATIVE_CHAR	Version of Algorithm (アルゴリズムバージョン)	Algorithm version number indicated in processing control information	-	-	
parameterVersion	1	3	-	0	H5T_NATIVE_CHAR	Version of Processing Parameter (処理パラメータバージョン)	Processing parameter version indicated in processing control information	-	-	
controlInfo	1	10000	-	0	H5T_NATIVE_CHAR	Control Information (制御情報)	Processing control information used for create this product	-	-	

Table 3-2 Details of TANSO-FTS Product Format

Group Path/Dataset Name	Database		Attribute		Data Type	Dataset Name (Japanese Name)	Explanation (Format)	Unit	Invalid Value	Notes
	Dimension	Size	Name	Number						
apodization_SWIR	3	6, 2, 19	-	0	H5T_NATIVE_CHAR	SWIR Apodization Information (SWIRアポダイゼーション情報)	SWIR apodization information are set as character array in following order:  Apodization_SWIR[a][b][c] a=0 : Band1Polarization P a=1 : Band1Polarization S a=2 : Band2Polarization P a=3 : Band2Polarization S a=4 : Band3Polarization P a=5 : Band3Polarization S  b=0 : Full window function b=1 : Partial window function  Character array are set in order of "window function name", "applied range of window function", "parameter for window function" separated by comma.  List of window functions : "NOT" : not applied "GAU" : Gauss "HAN" : Hanning "HAM" : Hamming "BKM" : Blackman "TRI" : Triangle "BLH" : Bartlett-Hann "NTA" : Nuttall "BHR" : Blackman-Harris "BNT" : Blackman-Nuttall "FLT" : FlatTop "AKA" : Akaike "NBR" : Norton-Beer  ※Parameter is set only for Gauss function and Norton-Beer function	-	-	

6

Table 3-2 Details of TANSO-FTS Product Format

Group Path/Dataset Name	Database		Attribute		Data Type	Dataset Name (Japanese Name)	Explanation (Format)	Unit	Invalid Value	Notes
	Dimension	Size	Name	Number						
apodization_TIR	3	4, 2, 19	-	0	HST_NATIVE_CHAR	TIR Apodization Information (TIRアポダイゼーション情報)	<p>TIR apodization information are set as character array in following order:</p> <p>Apodization_TIR[a][b][c]                      a=0 : Observation Mode                      a=1 : Deep Space Calibration Mode                      a=2 : Blackbody Calibration Mode                      a=3 : The Other Mode</p> <p>b=0 : Full window function                      b=1 : Partial window function</p> <p>Character array are set in order of "window function name", "applied range of window function", "parameter for window function" separated by comma.</p> <p>List of window functions :                      "NOT" : not applied                      "GAU" : Gauss                      "HAN" : Hanning                      "HAM" : Hamming                      "BKM" : Blackman                      "TRI" : Triangle                      "BLH" : Bartlett-Hann                      "NTA" : Nuttall                      "BHR" : Blackman-Harris                      "BNT" : Blackman-Nuttall                      "FLT" : FlatTop                      "AKA" : Akaike                      "NBR" : Norton-Beer</p> <p>※Parameter is set only for Gauss function and Norton-Beer function</p>	-	-	

6



Table 3-2 Details of TANSO-FTS Product Format

NEB-080031

Group Path/Dataset Name	Database		Attribute		Data Type	Dataset Name (Japanese Name)	Explanation (Format)	Unit	Invalid Value	Notes
	Dimension	Size	Name	Number						
☐ exposureAttribute (露光に同期した情報)										
numPoints	1	1	-	0	H5T_NATIVE_LONG	Number of Observation Points (観測点数)	Number of exposures in a scene is stored.	-	-	
numPoints_SWIR	1	1	-	0	H5T_NATIVE_LONG	Number of Observation Points in SWIR (観測点数 (SWIR))	Number of SWIR exposures in a scene is stored.	-	-	
numPoints_TIR	1	1	-	0	H5T_NATIVE_LONG	Number of Observation Points in TIR (観測点数 (TIR))	Number of TIR exposures in a scene is stored.	-	-	
☐ pointAttribute (露光の情報)										
pointingMirrorStableFlag	1	numPoints	-	0	H5T_NATIVE_CHAR	Pointing Mirror Stable Flag (ポインティングミラー静定状態品質情報)	"0x00": invalid exposure data "0x01": valid exposure data "0x02": undeterminable exposure data	-	-	
missingFlag	2	numBand, numPoints	-	0	H5T_NATIVE_CHAR	Missing Data Flag (欠損有無)	"0x00": Normal "0x01": Partial loss (of interferogram) "0x02": Full loss (of interferogram) "0x09": Normal without data (No interferogram for the exposure) In the following pointAttributes, 0 for subscript of array	-	-	
Time	1	numPoints	-	0	USER_DATE_YMDHMS	Exposure Time (観測点撮像時刻)	Time of the exposure (UTC) (Exposure start time of interferogram)	datetime	-	

Table 3-2 Details of TANSO-FTS Product Format

NEB-080031

Group Path/Dataset Name	Database		Attribute		Data Type	Dataset Name (Japanese Name)	Explanation (Format)	Unit	Invalid Value	Notes
	Dimension	Size	Name	Number						
RadiometricCorrectionInfo (Radiometric correction information)										
ZPDPassTime_SWIR	2	numPoints_SWIR, 6	-	0	H5T_NATIVE_DOUBLE	ZPD Passing Time (SWIR) (ZPD通過時刻 (SWIR))	Time of ZPD passing is given as elapsed time from the exposure start.	sec	-	
ZPDPassTime_TIR	1	numPoints_TIR	-	0	H5T_NATIVE_DOUBLE	ZPD Passing Time (TIR) (ZPD通過時刻 (TIR))	Time of ZPD passing is given as elapsed time from the exposure start.	sec	-	
ZPD_Pos_SWIR	2	numPoints_SWIR, 6	-	0	H5T_NATIVE_INT	ZPD Position (SWIR) (ZPD位置 (SWIR))	Fringe count position for ZPD (SWIR) (before FCE correction) is stored. The stored value starts with 0. ZPD_Pos_SWIR[numPoints_SWIR][a] a=0:Band1P a=1:Band1S a=2:Band2P a=3:Band2S a=4:Band3P a=5:Band3S	-	-	
ZPD_Pos_TIR	1	numPoints_TIR	-	0	H5T_NATIVE_INT	ZPD Position (TIR) (ZPD位置 (TIR))	Fringe count position for ZPD (TIR) (before FCE correction) is stored. The stored value starts with 0.	-	-	
fringeCountError_SWIR	2	numPoints_SWIR, 6	-	0	H5T_NATIVE_DOUBLE	Fringe Count Error (SWIR) (フリッジカウンタエラー (SWIR))	Fringe count error (SWIR) is stored. fringeCountError_SWIR[numPoints_SWIR][a] a=0:Band1P a=1:Band1S a=2:Band2P a=3:Band2S a=4:Band3P a=5:Band3S	-	-	
fringeCountError_TIR	1	numPoints_TIR	-	0	H5T_NATIVE_DOUBLE	Fringe Count Error (フリッジカウンタエラー (TIR))	Fringe count error (TIR) is stored.	-	-	

6

Table 3-2 Details of TANSO-FTS Product Format

Group Path/Dataset Name	Database		Attribute		Data Type	Dataset Name (Japanese Name)	Explanation (Format)	Unit	Invalid Value	Notes
	Dimension	Size	Name	Number						
spikeNoiseFlag_SWIR	2	numPoints_SWIR, 6	-	0	H5T_NATIVE_CHAR	Spike Noise Flag (SWIR) (スパイクノイズ判定フラグ (SWIR))	Flag for spike noise (SWIR) is stored. spikeNoiseFlag_SWIR[numPoints_SWIR][a] a=0:Band1P a=1:Band1S a=2:Band2P a=3:Band2S a=4:Band3P a=5:Band3S  "0x00": Normal (no spike noise) "0x01": With spike noise	-	-	
spikeNoiseFlag_TIR	1	numPoints_TIR	-	0	H5T_NATIVE_CHAR	Spike Noise Flag (TIR) (スパイクノイズ判定フラグ (TIR))	Flag for spike noise (TIR) is stored.  "0x00": Normal (no spike noise) "0x01": With spike noise	-	-	
ZPD_missFlag_SWIR	2	numPoints_SWIR, 6	-	0	H5T_NATIVE_CHAR	ZPD Miss Flag (SWIR) (ZPD誤検出フラグ (SWIR))	Flag for the case that the detected ZPD value is out of the acceptable range from the center of interferogram (SWIR). ZPD_missFlag_SWIR[numPoints_SWIR][a] a=0:Band1P a=1:Band1S a=2:Band2P a=3:Band2S a=4:Band3P a=5:Band3S  "0x00": Within the acceptable range "0x01": Out of the acceptable range	-	-	
ZPD_missFlag_TIR	1	numPoints_TIR	-	0	H5T_NATIVE_CHAR	ZPD Miss Flag (TIR) (ZPD誤検出フラグ (TIR))	Flag for the case that the detected ZPD value is out of the acceptable range from the center of interferogram (TIR).  "0x00": Within the acceptable range "0x01": Out of the acceptable range	-	-	

6

Table 3-2 Details of TANSO-FTS Product Format

Group Path/Dataset Name	Database		Attribute		Data Type	Dataset Name (Japanese Name)	Explanation (Format)	Unit	Invalid Value	Notes
	Dimension	Size	Name	Number						
fringeSource	1	numPoints	-	0	H5T_NATIVE_CHAR	Fringe Source (フリッジソース)	"0x00": FTS-M "0x01": FTS-A	-	-	
fringeSignalLevel	2	numPoints, 4	-	0	H5T_NATIVE_FLOAT	Fringe Signal Level (フリッジ信号レベル)	Fringe signal levels are stored in the following order. fringeSignalLevel[numPoints][a] a=0: FRIGE_SIG_AC_LEVEL a=1: DEPHASE_SIG_AC_LEVEL a=2: FRIGE_SIG_DC_LEVEL a=3: DEPHASE_SIG_DC_LEVEL	-	-	
phaseCorrectionRange_SWIR	3	numPoints_SWIR, 6, 2	-	0	H5T_NATIVE_DOUBLE	Wave Number Range for Phase Correction (SWIR) (位相補正に使用した波数の範囲 (SWIR))	Range of wave number (minimum, maximum) used for phase correction is stored. phaseCorrectionRange_SWIR[numPoints_SWIR][a][b] a=0: Band1P a=1: Band1S a=2: Band2P a=3: Band2S a=4: Band3P a=5: Band3S  b=0: Minimum wave number used for phase correction b=1: Maximum wave number used for phase correction	cm-1	-	
phaseCorrectionRange_TIR	2	numPoints_TIR, 2	-	0	H5T_NATIVE_DOUBLE	Wave Number Range for Phase Correction (TIR) (位相補正に使用した波数の範囲 (TIR))	Range of wave number (minimum, maximum) used for phase correction is stored. phaseCorrectionRange_TIR[numPoints_TIR][a] b=0: Minimum wave number used for phase correction b=1: Maximum wave number used for phase correction	cm-1	-	
ZPD_SaturationFlag_SWIR	2	numPoints_SWIR, 6	-	0	H5T_NATIVE_CHAR	ZPD Saturation Flag (SWIR) (ZPD飽和の有無 (SWIR))	"0x00": Normal "0x01": Upper limit value saturated	-	-1	Only for upper limit. Lower limit saturation is not handled.
ZPD_SaturationFlag_TIR	1	numPoints_TIR	-	0	H5T_NATIVE_CHAR	ZPD Saturation Flag (TIR) (ZPD飽和の有無 (TIR))	"0x00": Normal "0x01": Upper limit value saturated "0x02": Lower limit value saturated "0x04": Both upper and lower limit values saturated	-	-1	
ZPD_Offset	1	numPoints	-	0	H5T_NATIVE_INT	ZPD Offset (ZPDオフセット値)	ZPD offset value is stored.	-	-	
lowFrequencyAmplitudeFlag_SWIR	2	numPoints_SWIR, 6	-	0	H5T_NATIVE_CHAR	Flag for Vibration Amplitude in Lower Frequencies (SWIR) (低周波成分の微小振動の影響フラグ (SWIR))	"0x00": Without microvibration influence evaluated from lower frequency data "0x01": Under microvibration influence evaluated from lower frequency data	-	-	
lowFrequencyAmplitudeFlag_TIR	1	numPoints_TIR	-	0	H5T_NATIVE_CHAR	Flag for Vibration Amplitude in Lower Frequencies (TIR) (低周波成分の微小振動の影響フラグ (TIR))	"0x00": Without microvibration influence evaluated from lower frequency data "0x01": Under microvibration influence evaluated from lower frequency data	-	-	
lowFrequencyAmplitudeRatio_SWIR	2	numPoints_SWIR, 6	-	0	H5T_NATIVE_FLOAT	Vibration Amplitude in Lower Frequencies (SWIR) (低周波成分の振幅の大きさ (SWIR))	Percentage of false signal level in lower frequencies relative to the peak level of observed spectrum is stored.	%	-	
lowFrequencyAmplitudeRatio_TIR	1	numPoints_TIR	-	0	H5T_NATIVE_FLOAT	Vibration Amplitude in Lower Frequencies (TIR) (低周波成分の振幅の大きさ (TIR))	Percentage of false signal level in lower frequencies relative to the peak level of observed spectrum is stored.	%	-	

6

Table 3-2 Details of TANSO-FTS Product Format

Group Path/Dataset Name	Database		Attribute		Data Type	Dataset Name (Japanese Name)	Explanation (Format)	Unit	Invalid Value	Notes
	Dimension	Size	Name	Number						
pointingStableFlag	1	numPoints	-	0	H5T_NATIVE_CHAR	Pointing Stability Flag (露光中視野保持フラグ)	"0x00": Unstable "0x01": Stable	-	-	
ELU_StableFlag	1	numPoints	-	0	H5T_NATIVE_CHAR	ELU Stable Flag (ELU静定フラグ)	"0x00": Unstable (Scan stop or PM in working) "0x01": Stable	-	-	
solarirradianceDiffuserPlateFlag	1	numPoints	-	0	H5T_NATIVE_CHAR	Solar Irradiance Diffuser Plate Flag (太陽照度校正拡散板(1,2)識別)	"0x00": UNSTDY "0x01": POS_1 "0x02": POS_2 "0x03": MOVING	-	-	
AT_Ang	1	numPoints	-	0	H5T_NATIVE_FLOAT	AT Angle (AT角)	"+X(roll)" is for satellite traveling direction. "-Y(-pitch)" always orients for deep space. "+Z(Yaw)" directs for Earth center.  AT angle is one between FTS line of sight and Y-Z plane. AT+ direction is right-hand screw direction of Y-axis. (Telemetry value multiplied with -1 is stored.)	deg	-	
CT_Ang	1	numPoints	-	0	H5T_NATIVE_FLOAT	CT Angle (CT角)	"+X(roll)" is for satellite traveling direction. "-Y(-pitch)" always orients for deep space. "+Z(Yaw)" directs for Earth center.  CT angle is one between the FTS line of sight and X-Z plane. CT+ direction is right-hand screw direction of X-axis. (Telemetry value multiplied with -1 is stored.)	deg	-	
AT_Ang_Error	1	numPoints	-	0	H5T_NATIVE_FLOAT	AT Error Angle (ATError角)	The difference between AT value derived by MMO and actual one is stored.	deg	-	
CT_Ang_Error	1	numPoints	-	0	H5T_NATIVE_FLOAT	CT Error Angle (CTError角)	The difference between CT value derived by MMO and actual one is stored.	deg	-	
gain_SWIR	3	numPoints, 2, 5	-	0	H5T_NATIVE_CHAR	Gain (SWIR) (SWIRのゲイン)	SWIR gain values are stored in order of Polarization P and Polarization S. numPoints, [0], 5: Polarization P numPoints, [1], 5: Polarization S  "L": SWIR gain is L "M": SWIR gain is M "H": SWIR gain is H "L_ERR": SWIR gain is L_ERR "M_ERR": SWIR gain is M_ERR. "H_ERR": SWIR gain is H_ERR. "UNDEF": SWIR gain is not defined.	-	-	
scanDuration	1	numPoints	-	0	H5T_NATIVE_FLOAT	Scan Duration (露光間隔)	Exposure duration is stored.	sec	-	
GT_obsPoints	1	numPoints	-	0	H5T_NATIVE_CHAR	Number of Observation Points along CT direction (クロストラック方向観測点数)	Number of observation points for cross track direction is stored. "0x01": 1 points "0x03": 3 points "0x05": 5 points "0x07": 7 points "0x09": 9 points	-	-	
turnAroundDuration	1	numPoints	-	0	H5T_NATIVE_FLOAT	Turn Around Time (ターンアラウンド時間)	Turn around time for the exposure is stored.	sec	-	
FTS_scanDirection	1	numPoints	-	0	H5T_NATIVE_CHAR	FTS Scan Direction (FTS スキャン方向)	"0x00": BW "0x01": FW	-	-	

Table 3-2 Details of TANSO-FTS Product Format

NEB-080031

Group Path/Dataset Name	Database		Attribute		Data Type	Dataset Name (Japanese Name)	Explanation (Format)	Unit	Invalid Value	Notes
	Dimension	Size	Name	Number						
scanSpeed	2	numPoints, 10	-	0	H5T_NATIVE_FLOAT	Scan Speed (スキャン速度)	Scan speed values are stored in the following order.  scanArmSpeed[numpoints][a] a=0 : ROTARY_ARM_SPEED_0 a=1 : ROTARY_ARM_SPEED_1 a=2 : ROTARY_ARM_SPEED_2 a=3 : ROTARY_ARM_SPEED_3 a=4 : ROTARY_ARM_SPEED_4 a=5 : ROTARY_ARM_SPEED_5 a=6 : ROTARY_ARM_SPEED_6 a=7 : ROTARY_ARM_SPEED_7 a=8 : ROTARY_ARM_SPEED_8 a=9 : ROTARY_ARM_SPEED_9	kHz	-	
detector_Temp_SWIR	2	numPoints, 6	-	0	H5T_NATIVE_DOUBLE	Detector Temperature (SWIR) (SWIR検出器温度)	SWIR detector temperatures are stored in the following order.  detector_Temp_SWIR[numpoints][a] a=0 : Band1P a=1 : Band1S a=2 : Band2P a=3 : Band2S a=4 : Band3P a=5 : Band3S	C	-	
detector_Temp_TIR	1	numPoints	-	0	H5T_NATIVE_DOUBLE	Detector Temperature (TIR) (TIR検出器温度)	TIR (Band4) detector temperature is stored.	C	-	
laserTemp	1	numPoints	-	0	H5T_NATIVE_DOUBLE	Laser Temperature (測距レーザー温度)	Temperature of micrometer laser is stored.	C	-	
beamsplitterTemp	1	numPoints	-	0	H5T_NATIVE_DOUBLE	Beam Splitter Temperature (ビームスプリッタ温度)	Temperature of beam splitter is stored.	C	-	

Table 3-2 Details of TANSO-FTS Product Format

Group Path/Dataset Name	Database		Attribute		Data Type	Dataset Name (Japanese Name)	Explanation (Format)	Unit	Invalid Value	Notes
	Dimension	Size	Name	Number						
FTS_mechanismTempFlag	1	numPoints	-	0	H5T_NATIVE_CHAR	FTS Mechanism Temperature Flag (FTS 機構部温度判定フラグ)	Flag whether the temperature of optic system for FTS-M is within the range of 20-26 degree Celsius is stored.  "0x00": Within normal range "0x01": Below normal range "0x02": Above normal range	-	-	
FTS_interfaceTemp	1	numPoints	-	0	H5T_NATIVE_DOUBLE	FTS Mechanical Interface Temperature (FTS インターフェース温度)	FTS interface temperature is stored.	C	-	
coldHeadTemp	1	numPoints	-	0	H5T_NATIVE_DOUBLE	Cold Head Temperature (冷凍機温度)	Temperature of refrigerator is stored.	C	-	
BB_Temp_TIR	2	numPoints, 3	-	0	H5T_NATIVE_DOUBLE	TIR Blackbody Temperature (CH1-CH3) (TIR校正黒体温度 CH1~CH3)	Blackbody temperatures for TIR calibration are stored in the order of ch1, ch2, and ch3. numPoints, 0: ch1 numPoints, 1: ch2 numPoints, 2: ch3	C	-	
BB_Temp_TIR_DN	2	numPoints, 3	-	0	H5T_NATIVE_LONG	TIR Blackbody Temperature (DN) (CH1-CH3) (TIR校正黒体温度 (DN) CH1~CH3)	Blackbody temperatures (DN) for TIR calibration are stored in the order of ch1, ch2, and ch3. numPoints, 0: ch1 numPoints, 1: ch2 numPoints, 2: ch3	-	-	
BB_TempFlag	1	numPoints	-	0	H5T_NATIVE_CHAR	Blackbody Temperature Flag (黒体温度判定フラグ)	Flags for the case that the DN value for onboard blackbody temperature for blackbody calibration exceeds the limit value of 1020 is stored.  "0x00": No saturation for all ch1-ch3 channels. "0x01": One or more of ch1-ch3 channel is saturated.	-	-	
BB_Temp_average	1	numPoints	-	0	H5T_NATIVE_DOUBLE	Blackbody Average Temperature (校正黒体平均温度)	Average of blackbody calibration temperature is stored.	C	-	

Table 3-2 Details of TANSO-FTS Product Format

NEB-080031

Group Path/Dataset Name	Database		Attribute		Data Type	Dataset Name (Japanese Name)	Explanation (Format)	Unit	Invalid Value	Notes
	Dimension	Size	Name	Number						
raspeedFlag	1	numPoints	-	0	H5T_NATIVE_CHAR	Scan Speed Flag ??? (走査速度判定フラグ)	"0x00": Scan mirror speed is stable. "0x01": Scan mirror speed is unstable.	-	-	
primarySecondaryFlag	1	numPoints	-	0	H5T_NATIVE_CHAR	Primary/Secondary Flag (主系、冗長系)	"0x00": Drive control unit for interferometer is primary one. "0x01": Drive control unit for interferometer is secondary one.	-	-	
spectrumObsWavelengthRange_SWIR	3	numPoints_SWIR, 6, 2	-	0	H5T_NATIVE_DOUBLE	Wave Number Range of Observed Spectrum (SWIR) (観測成分の輝度スペクトルの波数 (SWIR))	Coefficients a and b of liner expression to calculate wave numbers corresponding to the array number for observed radiance spectrum. The liner expression yields values in unit of cm <sup>-1</sup> .	-	-	
spectrumObsWavelengthRange_TIR	2	numPoints_TIR, 2	-	0	H5T_NATIVE_DOUBLE	Wave Number Range of Observed Spectrum (TIR) (観測成分の輝度スペクトルの波数 (TIR))	Coefficients a and b of liner expression to calculate wave numbers corresponding to the array number for observed radiance spectrum. The liner expression yields values in unit of cm <sup>-1</sup> .	-	-	
spectrumLowWavelengthRange_SWIR	3	numPoints_SWIR, 6, 2	-	0	H5T_NATIVE_DOUBLE	Wave Number Range of Lower Frequency Spectrum (SWIR) (低周波成分の輝度スペクトルの波数 (SWIR))	Coefficients a and b of liner expression to calculate wave numbers corresponding to the array number for radiance spectrum of lower frequencies. The liner expression yields values in unit of cm <sup>-1</sup> .	-	-	
spectrumLowWavelengthRange_TIR	2	numPoints_TIR, 2	-	0	H5T_NATIVE_DOUBLE	Wave Number Range of Lower Frequency Spectrum (TIR) (低周波成分の輝度スペクトルの波数 (TIR))	Coefficients a and b of liner expression to calculate wave numbers corresponding to the array number for radiance spectrum of lower frequencies. The liner expression yields values in unit of cm <sup>-1</sup> .	-	-	
spectrumFullWavelengthRange_SWIR	3	numPoints_SWIR, 6, 2	-	0	H5T_NATIVE_DOUBLE	Wave Number Range of All Observed Spectrum (SWIR) (全成分の輝度スペクトルの波数 (SWIR))	Coefficients a and b of liner expression to calculate wave numbers corresponding to the array number for full-range radiance spectrum. The liner expression yields values in unit of cm <sup>-1</sup> .	-	-	
spectrumFullWavelengthRange_TIR	2	numPoints_TIR, 2	-	0	H5T_NATIVE_DOUBLE	Wave Number Range of All Observed Spectrum (TIR) (全成分の輝度スペクトルの波数 (TIR))	Coefficients a and b of liner expression to calculate wave numbers corresponding to the array number for full-range radiance spectrum. The liner expression yields values in unit of cm <sup>-1</sup> .	-	-	
Index_SWIR	2	numPoints_SWIR, 2	-	0	H5T_NATIVE_SHORT	Radiometric Correction Information Data Index (TIR) (TIRラジオメトリック補正情報データインデックス)	Indices to indicate correspondence with TLM and TIR radiometric correction information data for the specified exposure are stored. Indices start with 1.	-	-	
Index_TIR	2	numPoints_TIR, 2	-	0	H5T_NATIVE_SHORT	Radiometric Correction Information Data Index (SWIR) (SWIRラジオメトリック補正情報データインデックス)	Indices to indicate correspondence with TLM and SWIR radiometric correction information data for the specified exposure are stored. Indices start with 1.	-	-	
sun										
sunPos	2	numPoints, 3	-	0	H5T_NATIVE_DOUBLE	Sun Position at Observed Point (ECR) (撮像点太陽位置 (ECR))	Apparent sun position relative to the satellite in ECR is stored. The first subscript gives the index of exposure, the second one is for X-Y-Z of the apparent sun position in ECR in this order. The values are always set except for the case that exposure time information for all band are missing or cannot be determined.	km	(0, 0, 0)	
AZ	1	numPoints	-	0	H5T_NATIVE_DOUBLE	Sun Azimuth at Observed Point (撮像点太陽位置 (方位角))	Sun azimuth angle at the observed point is stored. The first subscript gives the index of exposure. In case the observed point is not derived from data due to loss of ancillary data (for example) the value indicating invalid azimuth information is stored.	deg	-8192	
EL	1	numPoints	-	0	H5T_NATIVE_DOUBLE	Sun Elevation at Observed Point (撮像点太陽位置 (仰角))	Sun elevation angle at the observed point is stored. The first subscript gives the index of exposure. In case the observed point is not derived from data due to loss of ancillary data (for example) the value indicating invalid elevation information is stored.	deg	-8192	
moon										
moonPos	2	numPoints, 3	-	0	H5T_NATIVE_DOUBLE	Moon Position at Observed Point (ECR) (撮像点月位置 (ECR))	Apparent moon position relative to the observed point in ECR is stored. The first subscript gives the index of exposure, the second one is for X-Y-Z of the apparent moon position in ECR in this order. The values are always set except for the case that exposure time information for all band are missing	km	(0, 0, 0)	

6



Table 3-2 Details of TANSO-FTS Product Format

Group Path/Dataset Name	Database		Attribute		Data Type	Dataset Name (Japanese Name)	Explanation (Format)	Unit	Invalid Value	Notes
	Dimension	Size	Name	Number						
MoonPosFOVElongation	1	numPoints	-	0	H5T_NATIVE_DOUBLE	Angular Distance between FTS FOV and Moon (撮像点月視野離角)	The angular distance between FTS line of sight and moon direction from the satellite is stored. In case the exposure time is not determined from data due to loss of ancillary data (for example) the value indicating invalid angular distance information is stored.	deg	-8192	

Table 3-2 Details of TANSO-FTS Product Format

NEB-080031

Group Path/Dataset Name	Database		Attribute		Data Type	Dataset Name (Japanese Name)	Explanation (Format)	Unit	Invalid Value	Notes
	Dimension	Size	Name	Number						
satellite										
satPos	2	numPoints, 3	-	0	H5T_NATIVE_DOUBLE	Satellite Position (ECR) (衛星位置 (ECR))	Satellite position at the exposure start time in ECR is stored. The first subscript gives the index of exposure, the second one is for X-Y-Z of the apparent sun position in ECR in this order.	km	(0, 0, 0)	Satellite velocity at the exposure start time is calculated based on ephemeris data by using Hermite interpolation.
satVel	2	numPoints, 3	-	0	H5T_NATIVE_DOUBLE	Satellite Velocity (ECR) (衛星速度 (ECR))	Satellite velocity at the exposure start time in ECR is stored. The first subscript gives the index of exposure, the second one is for X-Y-Z of the apparent sun position in ECR in this order.	km/s	(0, 0, 0)	Satellite position at the exposure start time is calculated based on ephemeris data by using Hermite interpolation.
satAtt	2	numPoints, 4	-	0	H5T_NATIVE_DOUBLE	Quartanion for Satellite Attitude (Satellite Coordinate-ECR) (衛星姿勢(衛星座標-ECR))	Satellite attitude at the exposure start time is given as quartanion (Satellite coordinate-ECR). The first subscript gives the index of exposure, the second one corresponds to q0, q1, q2, and q3. q0 is scholar component and q1, q2, and q3 correspond i, j, and k, respectively.	-	(0, 0, 0, 0)	Satellite attitude at the exposure start time is calculated based on telemetry attitude data by using spherical linear interpolation.
satelliteAttitudeStabilityFlag	1	numPoints	-	0	H5T_NATIVE_CHAR	Satellite Attitude Control Mode (衛星姿勢制御フラグ)	"0x00": Mode except for ones below "0x01": CNM "0x02": FNM "0x03": MPM	-	-	
obsMode	2	numPoints, 4	-	0	H5T_NATIVE_CHAR	Observation Mode (観測モード)	"OB1D": Observation Mode I (day) "OB1N": Observation Mode I (night) "OB2D": Observation Mode II (day) "SPOD": Target Mode (day) "SPON": Target Mode (night) "SNCA": Solar Irradiance Calibration Mode "BKCA": Blackbody Calibration Mode "DSCA": Deep Space Calibration Mode "FTCA": Instrument Function Calibration Mode "ELCA": Electrical Calibration Mode "LUCA": Lunar Calibration Mode	-	-	Based on FTS_EL operation/calibration flag information stored in FTS status telemetry.
argumentOfLat	1	numPoints	-	0	H5T_NATIVE_DOUBLE	Argument of Latitude (衛星緯度指数)	Argument of latitude (argument of perigee + true perigee angle) of the satellite at the exposure start time $0 \leq \eta < 360$	deg	-8192	

Table 3-2 Details of TANSO-FTS Product Format

NEB-080031

Group Path/Dataset Name	Database		Attribute		Data Type	Dataset Name (Japanese Name)	Explanation (Format)	Unit	Invalid Value	Notes
	Dimension	Size	Name	Number						
<input checked="" type="checkbox"/> <b>geometricInfo</b>										
centerLat	2	numBand, numPoints	-	0	H5T_NATIVE_FLOAT	Latitude of Observed Point (Center) (撮像点緯度)	Latitude of observed point for each band and exposure	deg	-8192	
centerLon	2	numBand, numPoints	-	0	H5T_NATIVE_FLOAT	Longitude of Observed Point (Center) (撮像点経度)	Longitude of observed point for each band and exposure	deg	-8192	
atPLat	2	numBand, numPoints	-	0	H5T_NATIVE_FLOAT	Latitude of Observed Point (AT+ direction) (撮像点視野AT+方向緯度)	Latitude of observed point for each band and exposure	deg	-8192	
atPLon	2	numBand, numPoints	-	0	H5T_NATIVE_FLOAT	Longitude of Observed Point (AT+ direction) (撮像点視野AT+方向経度)	Longitude of observed point for each band and exposure	deg	-8192	
atNLat	2	numBand, numPoints	-	0	H5T_NATIVE_FLOAT	Latitude of Observed Point (AT- direction) (撮像点視野AT-方向緯度)	Latitude of observed point for each band and exposure	deg	-8192	
atNLon	2	numBand, numPoints	-	0	H5T_NATIVE_FLOAT	Longitude of Observed Point (AT- direction) (撮像点視野AT-方向経度)	Longitude of observed point for each band and exposure	deg	-8192	
ctPLat	2	numBand, numPoints	-	0	H5T_NATIVE_FLOAT	Latitude of Observed Point (CT+ direction) (撮像点視野CT+方向緯度)	Latitude of observed point for each band and exposure	deg	-8192	
ctPLon	2	numBand, numPoints	-	0	H5T_NATIVE_FLOAT	Longitude of Observed Point (CT+ direction) (撮像点視野CT+方向経度)	Longitude of observed point for each band and exposure	deg	-8192	
ctNLat	2	numBand, numPoints	-	0	H5T_NATIVE_FLOAT	Latitude of Observed Point (CT- direction) (撮像点視野CT-方向緯度)	Latitude of observed point for each band and exposure	deg	-8192	
ctNLon	2	numBand, numPoints	-	0	H5T_NATIVE_FLOAT	Longitude of Observed Point (CT- direction) (撮像点視野CT-方向経度)	Longitude of observed point for each band and exposure	deg	-8192	
A01	2	numBand, numPoints	-	0	H5T_NATIVE_FLOAT	Incident Angle at Observed Point (撮像点入射角)	Incident angle at the observed point for each band and exposure	deg	-8192	
AZ	2	numBand, numPoints	-	0	H5T_NATIVE_FLOAT	Azimuth at Observed Point (撮像点方位角)	Observation azimuth angle at the observed point for each band and exposure	deg	-8192	
incidentVec	3	numBand, numPoints, 3	-	0	H5T_NATIVE_FLOAT	Incident Vector at Observed Point (撮像点衛星入射ベクトル)	Incident vector at the observed point for each band and exposure in the order of X, Y, and Z. The vector starts at the satellite and ends at the observed point.	-	(0, 0, 0)	
landType	1	numPoints	-	0	H5T_NATIVE_CHAR	Land/Ocean Flag (陸海フラグ)	Land/Ocean identification for the observed point is stored. "0x00": Land "0x01": Ocean "0x02": Mixed	-	-1	
sunglintFlag	1	numPoints	-	0	H5T_NATIVE_CHAR	Sunglint Flag (サングリントフラグ)	Flag for sunglint is stored. "0x00": Not sunglint "0x01": Sunglint	-	-1	
<input checked="" type="checkbox"/> <b>RawAncillary (Raw ancillary data)</b>										
Ancillary	3	numBand+1, numPoints, 47 2	-	0	H5T_NATIVE_UCHAR	Raw Sensor Ancillary Data (生センサアンサンラリデータ)	Sensor ancillary data in level 0 data used in processing this product	-	0:255	L1 processing software reads raw level 0 data and extracts the necessary part. Details of invalid values 0: data loss 255: dummy (value inserted for correspondence with other bands data)

6

Table 3-2 Details of TANSO-FTS Product Format

Group Path/Dataset Name	Database		Attribute		Data Type	Dataset Name (Japanese Name)	Explanation (Format)	Unit	Invalid Value	Notes
	Dimension	Size	Name	Number						
Interferogram (インターフェログラム)										
SWIR	3	numPoints_SWIR, 6, 76336	-	0	H5T_NATIVE_USHORT	SWIR Interferogram (SWIRインターフェログラムデータ)	Interferogram for each SWIR band at the specified observed point is stored. This dataset is only for L1A product.	-	0	
TIR	2	numPoints_TIR, 38206	-	0	H5T_NATIVE_USHORT	SWIR Interferogram (SWIRインターフェログラムデータ)	Interferogram for TIR band at the specified observed point is stored. This dataset is only for L1A product. AC and DC components are stored as 16 bits and 12 bits data, respectively. Array size of AC and DC components are 38168 and 38, respectively and stored in this order. This dataset is only for L1A product.	-	0	
Index_SWIR	2	numPoints_SWIR, 2	-	0	H5T_NATIVE_SHORT	SWIR Interferogram Index (SWIRインターフェログラムデータインデックス)	Indices to indicate correspondence with TLM and TIR radiometric correction information data for the specified exposure are stored. Indices start with 1. This dataset is only for L1A product.	-	-	
Index_TIR	2	numPoints_TIR, 2	-	0	H5T_NATIVE_SHORT	TIR Interferogram Index (TIRインターフェログラムデータインデックス)	Indices to indicate correspondence with TLM and SWIR radiometric correction information data for the specified exposure are stored. Indices start with 1. If corresponding SWIR interferogram data does not exist, value indicating invalid data is stored. This dataset is only for L1A product.	-	-	

6

Table 3-2 Details of TANSO-FTS Product Format

Group Path/Dataset Name	Database		Attribute		Data Type	Dataset Name (Japanese Name)	Explanation (Format)	Unit	Invalid Value	Notes
	Dimension	Size	Name	Number						
Spectrum										
Index_SWIR	2	numPoints_SWIR, 2	-	0	H5T_NATIVE_SHORT	SWIR Spectrum Data Index (SWIRスペクトルデータインデックス)	Indices to indicate correspondence with TLM and TIR radiometric correction information data for the specified exposure are stored. Indices start with 1. This dataset is only for L1B product.	-	-	
Index_TIR	2	numPoints_TIR, 2	-	0	H5T_NATIVE_SHORT	TIR Spectrum Data Index (TIRスペクトルデータインデックス)	Indices to indicate correspondence with TLM and SWIR radiometric correction information data for the specified exposure are stored. If corresponding SWIR interferogram data does not exist, value indicating invalid data is stored. Indices start with 1. This dataset is only for L1B product.	-	-	

Table 3-2 Details of TANSO-FTS Product Format

NEB-080031

Group Path/Dataset Name	Database		Attribute		Data Type	Dataset Name (Japanese Name)	Explanation (Format)	Unit	Invalid Value	Notes
	Dimension	Size	Name	Number						
SWIR (SWIR spectrum)										
band1 (Band1 spectrum)										
lowWavelength	4	numPoints_SWIR, 2, 2020, 2	-	0	H5T_NATIVE_FLOAT	SWIR Spectral Data (Lower Frequencies) (SWIRスペクトルデータ (低周波成分))	Radiance spectrum data in lower frequencies before sensitivity correction transformed from band 1 interferogram for the specified exposure is stored in the order of exposures, polarization, wave number, complex values. The order of polarization and complex values are P followed by S and real part followed by imaginary part. This dataset is only for L1B product.	V/cm-1	-	
obsWavelength	4	numPoints_SWIR, 2, 6565, 2	-	0	H5T_NATIVE_FLOAT	SWIR Spectral Data (Observation) (SWIRスペクトルデータ (観測成分))	Radiance spectrum data in observation frequencies before sensitivity correction transformed from band 1 interferogram for the specified exposure is stored in the order of exposures, polarization, wave number, complex values. The order of polarization and complex values are P followed by S and real part followed by imaginary part. This dataset is only for L1B product.	V/cm-1	-	
band2 (Band2 spectrum)										
lowWavelength	4	numPoints_SWIR, 2, 2020, 2	-	0	H5T_NATIVE_FLOAT	SWIR Spectral Data (Lower Frequencies) (SWIRスペクトルデータ (低周波成分))	Radiance spectrum data in lower frequencies before sensitivity correction transformed from band 2 interferogram for the specified exposure is stored in the order of exposures, polarization, wave number, complex values. The order of polarization and complex values are P followed by S and real part followed by imaginary part. This dataset is only for L1B product.	V/cm-1	-	
obsWavelength	4	numPoints_SWIR, 2, 8080, 2	-	0	H5T_NATIVE_FLOAT	SWIR Spectral Data (Observation) (SWIRスペクトルデータ (観測成分))	Radiance spectrum data in observation frequencies before sensitivity correction transformed from band 2 interferogram for the specified exposure is stored in the order of exposures, polarization, wave number, complex values. The order of polarization and complex values are P followed by S and real part followed by imaginary part. This dataset is only for L1B product.	V/cm-1	-	
band3 (Band3 spectrum)										
lowWavelength	4	numPoints_SWIR, 2, 2020, 2	-	0	H5T_NATIVE_FLOAT	SWIR Spectral Data (Lower Frequencies) (SWIRスペクトルデータ (低周波成分))	Radiance spectrum data in lower frequencies before sensitivity correction transformed from band 3 interferogram for the specified exposure is stored in the order of exposures, polarization, wave number, complex values. The order of polarization and complex values are P followed by S and real part followed by imaginary part. This dataset is only for L1B product.	V/cm-1	-	
obsWavelength	4	numPoints_SWIR, 2, 6565, 2	-	0	H5T_NATIVE_FLOAT	SWIR Spectral Data (Observation) (SWIRスペクトルデータ (観測成分))	Radiance spectrum data in observation frequencies before sensitivity correction transformed from band 3 interferogram for the specified exposure is stored in the order of exposures, polarization, wave number, complex values. The order of polarization and complex values are P followed by S and real part followed by imaginary part. This dataset is only for L1B product.	V/cm-1	-	
TIR (TIR spectrum)										
band4 (Band4 spectrum)										
lowWavelength	3	numPoints_TIR, 2020, 2	-	0	H5T_NATIVE_FLOAT	TIR Spectral Data (Lower Frequencies) (TIRスペクトルデータ (低周波成分))	Radiance spectrum data in lower frequencies before sensitivity correction transformed from band 4 interferogram for the specified exposure is stored in the order of exposures, wave number, complex values. The order of complex values is real part followed by imaginary part. This dataset is only for L1B product.	W/cm2/cm-1/str	-	
obsWavelength	3	numPoints_TIR, 7575, 2	-	0	H5T_NATIVE_FLOAT	TIR Spectral Data (Observation) (TIRスペクトルデータ (観測成分))	Radiance spectrum data in observation frequencies before sensitivity correction transformed from band 4 interferogram for the specified exposure is stored in the order of exposures, wave number, complex values. The order of complex values are P followed by S and real part followed by imaginary part. This dataset is only for L1B product.	W/cm2/cm-1/str	-	

Table 3-2 Details of TANSO-FTS Product Format

NEB-080031

Group Path/Dataset Name	Database		Attribute		Data Type	Dataset Name (Japanese Name)	Explanation (Format)	Unit	Invalid Value	Notes
	Dimension	Size	Name	Number						
<input type="checkbox"/> ancillary (not completely corresponding to each)										
<input type="checkbox"/> FTSTimeEngConvCoef (Coefficients for FTS image engineering transformation)										
<input type="checkbox"/> SpacecraftTimeError (Spacecraft time error information)										
Time_System	1	4	-	0	H5T_NATIVE_CHAR	Time System (衛星時系)	"GPS": GPS based time "CDMS": CDMS internal clock time	-	-	
Num_TAI.UTC	1	1	-	0	H5T_NATIVE_INT	Number of TAI-UTC Records (TAI-UTCのレコード数)	Record number of TAI-UTC	-	-	
TAI.UTC_date	1	Num_TAI.UTC	-	0	USER_DATE_YMDHMS	TAI-UTC date (TAI-UTC日)	Transfer date and time of TAI-UTC (UTC)		-	
TAI.UTC	1	Num_TAI.UTC	-	0	H5T_NATIVE_INT	TAI-UTC (TAI-UTC)	Elapsed seconds from TAI.UTC_date	sec	-	
Num_Diff_Inf	1	1	-	0	H5T_NATIVE_INT	Number of Time Difference Records (時刻誤差情報レコード数)	(0 for GPS Time_System)  The following items are used for correlation between ground time and satellite time. The relation between these time system is expressed as below.  ground time = ground baseline time + satellite counter period * satellite center  satellite counter = (ground time - ground baseline time) in second + satellite time baseline counter	-	0	
Start_Time	1	Num_Diff_Inf	-	0	USER_DATE_YMDHMS	Start Time of Effective Period for Time Difference Record (TAI-UTC時刻誤差情報の有効開始期間)	(Not appear if number of time error information record is 0) Time of the first data used in calculation of the satellite counter period for the corresponding visible satellite path.	UTC	0	
End_Time	1	Num_Diff_Inf	-	0	USER_DATE_YMDHMS	Start Time of Effective Period for Time Difference Record (時刻誤差情報の有効終了期間)	(Not appear if number of time error information record is 0) Time of the last data used in calculation of the satellite counter period for the corresponding visible satellite path.	UTC	0	
Ground_Time	1	Num_Diff_Inf	-	0	USER_DATE_YMDHMS	Ground Reference Time (地上基準時刻)	(Not appear if number of time error information record is 0) Ground baseline time used in calculation of the satellite counter period for the corresponding visible satellite path.	UTC	0	
Ref_Count	1	Num_Diff_Inf	-	0	H5T_NATIVE_LONG	Satellite Time Reference Center (基準衛星時刻カウンタ)	(Not appear if number of time error information record is 0) Satellite baseline time used in calculation of the satellite counter period for the corresponding visible satellite path.	sec	0	
Period_Count	1	Num_Diff_Inf	-	0	H5T_NATIVE_DOUBLE	Satellite Counter Period (衛星カウンタ周期)	(Not appear if number of time error information record is 0) Time duration corresponding to 1 count during the effective	sec	0	

Table 3-2 Details of TANSO-FTS Product Format

Group Path/Dataset Name	Database		Attribute		Data Type	Dataset Name (Japanese Name)	Explanation (Format)	Unit	Invalid Value	Notes
	Dimension	Size	Name	Number						
TransformationInfo(座標変換情報)										
numData	1	1	-	0	H5T_NATIVE_LONG	Number of Sidereal Time Information (恒星時情報数)	Number of sidereal time information is stored.	-	-	プロダクト作成処理が、自前でファイルを読み、値を設定する。
SiderealTimeInfo(恒星時情報)										
t0	1	numData	-	0	USER_DATE_YMDHMS	t0 (t0)	Baseline time t <sub>0</sub> , θ <sub>g</sub> , and θ <sub>g_dot</sub> are elements of the matrix to convert coordinates from TOD to pseudo earth-fixed one. Using t <sub>0</sub> , θ <sub>g</sub> , and θ <sub>g_dot</sub> , Greenwich sidereal time θ is expressed as follows: $\theta = \theta_g + \theta_{g\_dot}(t - t_0)$ Using θ, transform matrix to convert TOD to pseudo earth-fixed coordinate is as follows: $U = \begin{pmatrix} \cos(-\theta) & -\sin(-\theta) & 0 \\ \sin(-\theta) & \cos(-\theta) & 0 \\ 0 & 0 & 1 \end{pmatrix}$ Thus, the relation between a position M <sub>TOD</sub> (in TOD) and the corresponding position M <sub>PECR</sub> (in pseudo earth-fixed coordinate) is as follows: $M_{PECR} = UM_{TOD}$	UTC	-	
thetaG	1	numData	-	0	H5T_NATIVE_DOUBLE	θ <sub>g</sub> (θ <sub>g</sub> )	Greenwich sidereal time at the baseline time	deg	-	
thetaGdot	1	numData	-	0	H5T_NATIVE_DOUBLE	θ <sub>g_dot</sub> (θ <sub>g_dot</sub> )	Deviation of Greenwich sidereal time	deg/sec	-	



Table 3-2 Details of TANSO-FTS Product Format

Group Path/Dataset Name	Database		Attribute		Data Type	Dataset Name (Japanese Name)	Explanation (Format)	Unit	Invalid Value	Notes
	Dimension	Size	Name	Number						
<input type="checkbox"/> MatrixInfo(行列情報)										
numMatrix	1	1	-	0	H5T_NATIVE_LONG	Coordinate Transformation Matrix (座標変換行列数)	Number of coordinate transformation matrix is stored.	-	-	
date	2	numData, numMatrix	-	0	USER_DATE_YMDHMS	Start Date and Time of Effective Period (UTC)	Start time of effective period (UTC) is stored.	UTC	-	
pnMatrix	3	numData, numMatrix, 9	-	0	H5T_NATIVE_DOUBLE	PN Matrix (PN行列)	The values are stored in the following order: (0, 1, 2) (3, 4, 5) (6, 7, 8).  PN matrix is one to convert ECI (J2000) to TOD correcting precession and nutation. Relation between a position $M_{ECI}$ in ECI (J2000) and the corresponding position $M_{TOD}$ in TOD is given as below: $M_{TOD} = PNM_{J2000}$	-	-	
xyMatrix	3	numData, numMatrix, 9	-	0	H5T_NATIVE_DOUBLE	XY Matrix (XY行列)	The values are stored in the following order: (0, 1, 2) (3, 4, 5) (6, 7, 8).  XY matrix is one to convert from TOD to ECR (ITRF97). Relation between a position $M_{ECR}$ in TOD and the corresponding position $M_{ECR}$ in ECR is given as below: $M_{ECR} = XYM_{PECR}$	-	-	

Table 3-2 Details of TANSO-FTS Product Format

Group Path/Dataset Name	Database		Attribute		Data Type	Dataset Name (Japanese Name)	Explanation (Format)	Unit	Invalid Value	Notes
	Dimension	Size	Name	Number						
OrbitData										
statusFlag	1	1	-	0	H5T_NATIVE_CHAR	Status Flag (ステータスフラグ)	"0x00": GPSR based orbit data "0x01": Onboard AOCs extrapolation orbit data "0x02": Ground based definitive orbit data "0x03": Ground based forecast orbit data	-	-	Orbit data timing is independent of that of FTS exposure, therefore orbit data are stored as a separate dataset.
startDate	1	1	-	0	USER_DATE_YMDHMS	Orbit Data Reference Time (軌道データ基準時刻)	Baseline start time for the elapsed time of orbit data (UTC)	datetime	-	Since the baseline time system of orbit data is TAI, the time is converted to UTC system.
numPoints	1	1	-	0	H5T_NATIVE_LONG	Number of Data (データ点数)	Number of orbit data	-	-	
time	1	numPoints	-	0	H5T_NATIVE_DOUBLE	Elapse Time from Reference Time (軌道データ時刻)	The elapsed seconds from the baseline time of orbit data	sec	-	
satPos	2	numPoints, 3	-	2	H5T_NATIVE_DOUBLE	Satellite Position Vector (衛星位置)	(x, y, z) ECR (WGS84)	Km	-	
satVel	2	numPoints, 3	-	2	H5T_NATIVE_DOUBLE	Satellite Velocity Vector (衛星速度)	(u, v, w) ECR (WGS84)	km/s	-	
anPassTime	1	numPoints	-	0	USER_DATE_YMDHMS	Ascending Node Passing Time (昇交点通過時刻)	The last ascending node time in UTC extracted from PCD. Due to the hardware/software specification, the second last or the following one may be stored instead.	datetime	0	In case using definitive orbit data or forecast orbit data, value indicating invalid value is stored.
useOrbitQuality	1	1	-	0	H5T_NATIVE_CHAR	Type of Orbit Data (軌道データ種別)	Type of orbit data "0x00": onboard data "0x01": definitive orbit data "0x02": forecast orbit data	-	-	

Table 3-2 Details of TANSO-FTS Product Format

Group Path/Dataset Name	Database		Attribute		Data Type	Dataset Name (Japanese Name)	Explanation (Format)	Unit	Invalid Value	Notes
	Dimension	Size	Name	Number						
AttitudeData										
precision	1	7	-	0	H5T_NATIVE_CHAR	Type of Attitude Data (姿勢データ種別)	"OnBoard": Type of attitude data Fixed	-	-	
startDate	1	1	-	0	USER_DATE_YMDHMS	Attitude Data Reference Time (姿勢データの基準時刻)	Baseline start time for the elapsed time of attitude data (UTC)	datetime	-	Since the baseline time system of attitude data is TAI, the time is converted to UTC system.
numPoints	1	1	-	0	H5T_NATIVE_LONG	Number of Data Points (データ点数)	Number of attitude data	-	-	
time	1	numPoints	-	0	H5T_NATIVE_DOUBLE	Elapse Time from Reference Time (姿勢データ時刻)	The elapsed seconds from the baseline time of attitude data	sec	-	
satAttQuaternion	2	numPoints.4	-	0	H5T_NATIVE_DOUBLE	Satellite Attitude Quaternion (ECR) (衛星姿勢)	(q0, q1, q2, q3) sat → ECR Coordinates conversion can be expressed by q·V·q*.	-	-	
satAttRPY	2	numPoints.3	-	0	H5T_NATIVE_DOUBLE	Satellite Attitude Role/Pitch/Yaw (衛星姿勢 (ロール・ピッチ・ヨー))	Stored as roll, pitch, and yaw angles in this order	deg	-	
satAttVel	2	numPoints.3	-	0	H5T_NATIVE_DOUBLE	Satellite Attitude Angular Velocity (衛星姿勢角速度)	(wx, wy, wz) (J2000)	deg/sec	-	
GeometricInformation(シーン幾何情報)										
Center_Latitude	1	1	-	0	H5T_NATIVE_FLOAT	Center Latitude in all Observed Points 全観測点における中央の緯度	The latitude of the center exposure of all exposures in time is stored.	deg	-8192	
Center_Longitude	1	1	-	0	H5T_NATIVE_FLOAT	Center Longitude in all Observed Points 全観測点における中央の経度	The longitude of the center exposure of all exposures in time is stored.	deg	-8192	
north_Latitude	1	1	-	0	H5T_NATIVE_FLOAT	Northernmost Latitude in all Observed Points 最北端の緯度	Latitude of the northern most observed point is stored.	deg	-8192	
north_Longitude	1	1	-	0	H5T_NATIVE_FLOAT	Northernmost Longitude in all Observed Points 最北端の経度	Longitude of the northern most observed point is stored.	deg	-8192	
south_Latitude	1	1	-	0	H5T_NATIVE_FLOAT	Southernmost Latitude in all Observed Points 最南端の緯度	Latitude of the southern most observed point is stored.	deg	-8192	
south_Longitude	1	1	-	0	H5T_NATIVE_FLOAT	Southernmost Longitude in all Observed Points 最南端の経度	Longitude of the southern most observed point is stored.	deg	-8192	
west_Latitude	1	1	-	0	H5T_NATIVE_FLOAT	Westernmost Latitude in all Observed Points 最西端の緯度	Latitude of the western most observed point is stored.	deg	-8192	
west_Longitude	1	1	-	0	H5T_NATIVE_FLOAT	Westernmost Longitude in all Observed Points 最西端の経度	Longitude of the western most observed point is stored.	deg	-8192	
east_Latitude	1	1	-	0	H5T_NATIVE_FLOAT	Easternmost Latitude in all Observed Points 最東端の緯度	Latitude of the eastern most observed point is stored.	deg	-8192	
east_Longitude	1	1	-	0	H5T_NATIVE_FLOAT	Easternmost Longitude in all Observed Points 最東端の経度	Longitude of the eastern most observed point is stored.	deg	-8192	

Table 3-2 Details of TANSO-FTS Product Format

NEB-080031

Group Path/Dataset Name	Database		Attribute		Data Type	Dataset Name (Japanese Name)	Explanation (Format)	Unit	Invalid Value	Notes
	Dimension	Size	Name	Number						
RadiometricCorrectionInfo										
fourierTransformationMethod	1	4096	-	0	H5T_NATIVE_CHAR	Fourier Transformation Method (フーリエ変換の方法)	"Fourier transformation method is FFTW which is free software developed at MIT." TBD: Additional information will be given specified in algorithm baseline document.	-	-	
SensorConstant										
opticalPathDifference_Nominal	1	2	-	0	H5T_NATIVE_FLOAT	Optical Path Difference (Nominal) (光路差(ノミナル))	Optical path difference (nominal value) is stored in the order of primary system and secondary system. "2.4995": (primary) "2.4994": (secondary) Fixed value	cm	-	
laserWavelength_Nominal	1	2	-	0	H5T_NATIVE_FLOAT	Laser Wave Length (Nominal) (レーザ波長(ノミナル))	Laser wave length (nominal value) is saved in the order of primary system and secondary system. "1309.742": (primary) "1309.688": (secondary) Fixed value	nm	-	
fringeCountNum_SWIR	1	1	-	0	H5T_NATIVE_LONG	Fringe Count Number (SWIR) (フリンジカウント数 (SWIR))	Number of fringe count (SWIR) is stored. fringeCountNum_SWIR "76336" Fixed value	-	-	
fringeCountNum_TIR	1	2	-	0	H5T_NATIVE_LONG	Fringe Count Number (TIR) (フリンジカウント数 (TIR))	Number of fringe count (TIR) is stored. fringeCountNum_TIR[a] "38206": a=0 (AC component) "38": a=1 (DC component) Fixed value	-	-	
EngValCoef (Engineering value conversion coefficients)										
a	2	3,8	-	0	H5T_NATIVE_DOUBLE	Standard Sensitivity (基準感度)	The baseline sensitivity for Band1P, 1S, 2P, 2S, 3P, 3S, 4AC, and 4DC are stored in this order following the order of gain H, M, and L.	1/V	-	
b	2	3,8	-	0	H5T_NATIVE_DOUBLE	Offset (オフセット)	The offset value for Band1P, 1S, 2P, 2S, 3P, 3S, 4AC, and 4DC are stored in this order following the order of gain H, M, and L.	-	-	
nonLinearCorrCoef(非線形補正係数)										
SWIR	1	4	-	0	H5T_NATIVE_DOUBLE	Non-Linear Correction Coefficients (SWIR) (非線形補正係数 (SWIR))	4 coefficients for non-linearity correction in SWIR are stored. Each element is for the cubic, quadratic, linear and constant components in this order. The same coefficients are used for all 6 devices.	-	-	
TIR	1	4	-	0	H5T_NATIVE_DOUBLE	Non-Linear Correction Coefficients (TIR) (非線形補正係数 (TIR))	4 coefficients for non-linearity correction in TIR are stored. Each element is for the cubic, quadratic, linear and constant components in this order.	-	-	

G

G

Table 3-2 Details of TANSO-FTS Product Format

Group Path/Dataset Name	Database		Attribute		Data Type	Dataset Name (Japanese Name)	Explanation (Format)	Unit	Invalid Value	Notes
	Dimension	Size	Name	Number						
CalibrationProductInformation										
FileName	2	3,256	-	0	H5T_NATIVE_CHAR	File Name of Calibration Product (校正プロダクトファイル名)	File name of calibration product used for sensitivity calibration is stored. Since 3 types of calibration data are used for calibration, 3 file names are stored for each exposure. If the calibration product is the same for 3 types of calibration data, the same file name are stored for the 3 types of calibration data.	-	-	
CALType	2	3,15	-	0	H5T_NATIVE_CHAR	Type of Calibration Product (校正プロダクトの種類)	"BLACKBODY": 黒体校正 "DEEPSPACE": 深宇宙校正 "SOLARIRRADIANCE": 太陽照度校正 校正プロダクトファイルの中で使用した校正プロダクトの種類が格納される。	-	-	
StartIndex	1	3	-	0	H5T_NATIVE_SHORT	Start Index of Calibration Product (校正プロダクトの開始番号)	StartIndex gives information which calibration data is used for the sensitivity calibration as the index of the data (index starts with 1). The following values corresponding to the first calibration spectrum used in sensitivity calibration.  SWIR: Index_TIR[SIdx] under the Spectrum dataset TIR: SIdx	-	-	
EndIndex	1	3	-	0	H5T_NATIVE_SHORT	End Index of Calibration Product (校正プロダクトの終了番号)	EndIndex gives information which calibration data is used for the sensitivity calibration as the index of the data (index starts with 1). The following values corresponding to the last calibration spectrum used in sensitivity calibration.  SWIR: Index_TIR[EIdx] under the Spectrum dataset TIR: EIdx	-	-	