

CONSTRUCTION OF URBAN
ROADS IN LAP-II,
GELEPHU *THROMDE*

STANDARD BIDDING DOCUMENT

Procurement of Works

(Above Nu. 4 Million)



**Royal Government of Bhutan
Ministry of Finance**

April 2011

(Revised June 2014)

Preface

Procurement under projects financed by the Royal Government of Bhutan is carried out in accordance with policies and procedures laid down in the *Procurement Rules and Regulations 2009*.

The Standard Bidding Documents in this publication have been prepared for use by Employers in the Procurement of Works for Works Contracts above Nu. 4 (four) Million.

To obtain further information on procurement you may contact:
Public Procurement Policy Division
Ministry of Finance



དཔལ་ལྷན་འབྲུག་གཞུང་།
 དགོ་ལོགས་ཕུག་ཁྲོམ་སྡེ།



ROYAL GOVERNMENT OF BHUTAN
 GELEPHU THROMDE

GT/ESD-14/2014-2015/ 160

Date: 30/7/2014

NOTICE INVITING TENDER

The Gelephu Thromde invites sealed bids from the bidders having valid trade license issued by Ministry of Economic Affairs for the below mentioned work.

| Name of work | Category | Cost of bid document | Bid security (Nu.) | Date of sale of bid document | Last date & time of submission | Date & time of bid opening | Contract period |
|--|-------------|----------------------|--------------------|------------------------------|--------------------------------|----------------------------|-----------------|
| (1) Re-surfacing of existing roads, maintenance of footpaths and parking at core town. | Medium (W1) | 1000 | 151,000 | 11/8/2014 to 11/9/2014 | 12/9/2014 till 10:00AM | 12/9/2014 10:30AM | 7 months |
| (2) Construction of urban roads in LAP-II | Large (W1) | 1000 | 354,000/- | 11/8/2014 to 11/9/2014 | 12/9/2014 till 10:00AM | 12/9/2014 10:30 AM | 7 months |
| (3) Construction/Installation of street lighting on LAP-I and Highway(Main traffic to Shetikharey) | Medium (W4) | 1000 | 200,000/- | 11/8/2014 to 11/9/2014 | 12/9/2014 till 10:00AM | 12/9/2014 10:30 AM | 6 months |

དཔལ་ལྷན་འབྲུག་གཞུང་།
 དགེ་ལེགས་ཕུག་ཁྲོམ་སྡེ།



ROYAL GOVERNMENT OF BHUTAN
 GELEPHU THROMDE

| | | | | | | | |
|--|------------|------|------------------------|------------------------------|------------------------------|--------------------------|----------|
| (4) Construction of Urban Roads in LAP-I | Large (W1) | 1000 | 533,000/- 420,000/- | 11/8/2014 to 11/9/2014 | 12/9/2014 till 10:00AM | 12/9/2014 10:30 AM | 7 months |
|--|------------|------|------------------------|------------------------------|------------------------------|--------------------------|----------|

Complete sets of bidding documents containing detail terms and conditions shall be available for sale from the office of the Thromde (Revenue Section), Gelephu on submission of a written application from the above mentioned date.

(Signature)
 (Harka Tamang)
 Executive Secretary.

Copy: Thromde Tender Committee/Notice Board

Table of Contents

| | |
|---|----|
| Introduction | iv |
| Section I. Instructions to Bidders (ITB)..... | 1 |
| Notes on the Instructions to Bidders | 1 |
| 18. Format and Signing of Bid | 14 |
| Section II. Bidding Data Sheet..... | 24 |
| Section III. Eligible Countries..... | 28 |
| Section IV. Forms of Bid, Qualification Information, Letter of Acceptance, Contract and Integrity Pact..... | 29 |
| 1. Contractor's Bid..... | 29 |
| Letter of Acceptance | 41 |
| Section V. General Conditions of Contract (GCC) | 48 |
| <i>Notes on General Conditions of Contract</i> | 48 |
| Table of Clauses..... | 49 |
| A. General..... | 51 |
| 13.1 <i>From the Start Date until the Defects Liability Certificate has been issued, the risks of personal injury, death, and loss of or damage to property (including, without limitation, the Works, Plant, Materials and Equipment) which are not Employer's risks are Contractor's risks.</i> | 55 |
| Section VI. Special Conditions of Contract..... | 73 |
| Section VII Specifications and Performance Requirements..... | 77 |
| <i>Notes on Specifications and Performance Requirements</i> | 77 |
| <i>Notes on Drawings</i> | 78 |
| Section VIII. Drawings | 78 |
| Section IX. Bill of Quantities | 79 |
| <i>Notes on the Bill of Quantities</i> | 79 |
| Section X. Security Forms | 81 |
| <i>Notes on Forms of Securities</i> | 81 |
| Form of Bid Security (Bank Guarantee) | 82 |
| Performance Demand Bank Guarantee | 83 |
| Bank Guarantee for Advance Payment | 84 |
| Invitation for Bids | 86 |
| <i>Notes on the Invitation for Bids (IFB)</i> | 86 |

Introduction

These Standard Bidding Documents are intended as a model for ad measurement (unit prices or unit rates in a Bill of Quantities) and lump sum types of Contract, which are the most common in Works contracting. Lump sum contracts are used in particular for buildings and other forms of construction where the Works are well defined and are unlikely to change in quantity or specifications, and where encountering difficult or unforeseen site conditions (for example, hidden foundation problems) is unlikely. The main text refers to ad measurement contracts. **Alternative clauses or texts are supplied for use with lump sum contracts.**¹

Care should be taken to check the relevance of the provisions of the standard documents against the requirements of the specific Works to be procured. The following directions should be observed when using the documents:

- (a) All the documents listed in the Table of Contents are normally required for the procurement of Works. However, they should be adapted as necessary to the circumstances of the particular Project.
- (b) Before issuing these Bidding Documents the Employer shall prepare the Bidding Data Sheet (Section II), Special Conditions of Contract (Section VI), and Sections VII, VIII and IX which deal with Specifications and Performance Requirements, Drawings, and Bill of Quantities respectively. The Employer should read and/or provide the information specified in the italicized notes inside brackets. In the few instances where the Bidder is requested to provide information, the note specifies it. **The footnotes and notes for the Employer are not part of the text; they should not be incorporated in the Bidding Documents issued to the Bidders.**
- (c) These Bidding Documents are intended to serve on a repetitive basis. Modifications for specific Project or Contract needs should be provided only in the Bidding Data Sheet and the Special Conditions of Contract, as amendments to the Instructions to Bidders and the General Conditions of Contract respectively.
- (d) The notes inside unshaded boxes, as well as others intended as guidance for the Employer, are not part of the text, but rather contain instructions for the user, as do the Preface and this Introduction section. **They should not be incorporated in the Bidding Documents.** The cover (first) page should be modified as required to identify the Bidding Documents as to the names of the Project, Contract and Employer, in addition to date of issue.
- (e) The notes inside boxes with a shaded background should be retained in the issued Bidding Documents, since these provide important guidance to Bidders.
- (f) The standard documents have been prepared for bidding where post qualification applies. However, with relatively minor modifications they also can be used where prequalification applies. The process of prequalification of Bidders is not covered in these standard documents.

¹ Lump sum contracts should be used for Works that can be defined in their full physical and qualitative characteristics before bids are called, or where the risks of substantial design variations are minimal—usually construction of buildings, pipe laying, power transmission towers and series of small structures, such as bus shelters or school ablution units. In lump sum contracts, the concept of priced activity schedules has been introduced, to enable payments to be made as activities are completed. Payments can also be made on the basis of percentage completion of each activity.

Section I. Instructions to Bidders (ITB)

Notes on the Instructions to Bidders

This section of the Bidding Documents should provide the information necessary for Bidders to prepare responsive Bids, in accordance with the requirements of the Employer. It should also give information on Bid submission, opening and evaluation, and on the award of Contract.

Matters governing the performance of the Contractor, payments under the Contract, or matters affecting the risks, rights and obligations of the parties under the Contract are not normally included in this Section, but rather under Section V, General Conditions of Contract and/or Section VI, Special Conditions of Contract. If duplication of a subject is inevitable in the different sections of the documents, care must be exercised to avoid contradictions between clauses dealing with the same matter.

These Instructions to Bidders shall not be part of the Contract and shall cease to have effect once the Contract is signed.

Table of Clauses

| | |
|--|----|
| A General | 3 |
| 1. Scope of Bid | 3 |
| 2. Fraud and Corruption | 3 |
| 3. Eligible Bidders | 5 |
| 4. Qualifications of the Bidder | 7 |
| 5. One Bid per Bidder | 9 |
| 6. Cost of Bidding | 9 |
| 7. Site Visit | 9 |
| B. Bidding Documents | 10 |
| 8. Content of Bidding Documents | 10 |
| 9. Clarification of Bidding Documents | 10 |
| 10. Amendment of Bidding Documents | 11 |
| C. Preparation of Bids | 11 |
| 11. Language of Bid | 11 |
| 12. Documents Comprising the Bid | 11 |
| 13. Bid Prices | 11 |
| 14. Currencies of Bid and Payment | 12 |
| 15. Bid Validity | 13 |
| 16. Bid Security | 13 |
| 17. Alternative Proposals by Bidders | 14 |
| 18. Format and Signing of Bid | 15 |
| D. Submission of Bids | 15 |
| 19. Sealing and Marking of Bids | 15 |
| 20. Deadline for Submission of Bids | 16 |
| 21. Late Bids | 16 |
| 22. Withdrawal, Substitution and Modification of Bids | 16 |
| E. Bid Opening and Evaluation | 16 |
| 23. Bid Opening | 16 |
| 24. Confidentiality | 18 |
| 25. Clarification of Bids | 18 |
| 26. Examination of Bids and Determination of Responsiveness | 18 |
| 27. Correction of Errors | 19 |
| 28. Currency for Bid Evaluation | 19 |
| 29. Evaluation and Comparison of Bids | 19 |
| 30. Preference for Domestic Bidders | 20 |
| F. Award of Contract | 21 |
| 31. Award Criteria | 21 |
| 32. Employer's Right to Accept any Bid and to Reject any or all Bids | 21 |
| 33. Notification of Award and Signing of Contract | 21 |
| 34. Performance Security | 22 |
| 35. Advance Payment and Security | 22 |
| 36. Adjudicator | 23 |

Instructions to Bidders (ITB)

A. General

1. Scope of Bid and Source of Funds

- 1.1 The Employer as defined² in Section II, Bidding Data Sheet (BDS), invites Bids for the construction of Works, as described in the BDS and Section VI, Special Conditions of Contract (SCC). The name and identification number of the Contract is provided in the BDS and the SCC.
- 1.2 The successful Bidder will be expected to complete the Works by the Intended Completion Date specified in the Special Conditions of Contract.
- 1.3 The Employer as defined in section II, Bidding Data Sheet (BDS) has received a budget from RGoB towards the cost of the Project defined in the BDS and intends to apply a part of the funds to cover eligible payments under the contract for this works.

2. Fraud and Corruption

- 2.1 It is RGoB's policy to require that Employers, Bidders, Suppliers, Contractors and their Subcontractors observe the highest standards of ethics during the procurement and execution of contracts.³ In pursuance of this policy, the RGoB:
- (a) defines, for the purposes of this provision, the terms set forth below as follows:
- (i) "corrupt practice"⁴ is the offering, giving, receiving or soliciting, directly or indirectly, of anything of value⁵ to influence improperly the actions of another party;
- (ii) "fraudulent practice"⁶ is any intentional act or omission, including a misrepresentation, that knowingly or recklessly misleads, or attempts to mislead, a party to obtain a financial or other benefit or to avoid an obligation;
- (iii) "collusive practice"⁷ is an arrangement between two or more parties designed to achieve an improper purpose, including to influence improperly the actions

² See also definitions in Section V, General Conditions of Contract (GCC).

³ In this context, any action taken by a Bidder, Supplier, Contractor or a Subcontractor to influence the procurement process or contract execution for undue advantage is improper.

⁴ "another party" refers to a public official acting in relation to the procurement process or contract execution. In this context, "public official" includes staff and employees of any organizations (including any institutions providing finance for the Works) taking or reviewing procurement decisions.

⁵ "anything of value" includes, but is not limited to, any gift, loan, fee, commission, valuable security or other asset or interest in an asset; any office, employment or contract; any payment, discharge or liquidation of any loan, obligation or other liability whatsoever, whether in whole or in part; any other services, favour or advantage, including protection from any penalty or disability incurred or apprehended or from any action or proceeding of a disciplinary or penal nature, whether or not already instituted and including the exercise or the forbearance from the exercise of any right or any official power or duty.

⁶ a "party" refers to a public official; the terms "benefit" and "obligation" relate to the procurement process or contract execution; and the "act or omission" is intended to influence the procurement process or contract execution.

⁷ "parties" refers to participants in the procurement process (including public officials) and an "improper purpose" includes attempting to establish bid prices at artificial, non competitive levels.

of another party;

- (iv) "coercive practice"⁸ is impairing or harming, or threatening to impair or harm, directly or indirectly, any party or the property of the party to influence improperly the actions of a party;
- (v) "obstructive practice" is
 - (aa) deliberately destroying, falsifying, altering or concealing of evidence material to the investigation or making false statements to investigators in order to materially impede any investigation into allegations of a corrupt, fraudulent, coercive or collusive practice; and/or threatening, harassing or intimidating any party to prevent it from disclosing its knowledge of matters relevant to the investigation or from pursuing the investigation; or
 - (bb) acts intended to materially impede the exercise of the inspection and audit rights of the Employer or any organization or person appointed by the Employer and/or any relevant RGoB agency provided for under ITB Sub-Clause 3.1 (d) below.
- (b) will reject a proposal for award if it determines that the Bidder recommended for award has, directly or through an agent, engaged in corrupt, fraudulent, collusive, coercive or obstructive practices in competing for the contract in question.
- (c) will sanction a firm or individual, including declaring them ineligible, either indefinitely or for a stated period of time, to be awarded a contract if it at any time determines that they have, directly or through an agent, engaged in corrupt, fraudulent, collusive, coercive or obstructive practices in competing for, or in executing contract;
- (d) will have the right to require that a provision be included in Bidding Documents and in contracts, requiring Bidders, Suppliers, Contractors and their Subcontractors to permit the Employer, any organization or person appointed by the Employer and/or any relevant RGoB agency to inspect their accounts and records and other documents relating to the Bid submission and contract performance and to have them audited by auditors appointed by the Employer;
- (e) requires that Bidders, as a condition of admission to eligibility, execute and attach to their bids an Integrity Pact Statement in the form provided in Section IV, Bidding Forms. Failure to provide a duly executed Integrity Pact Statement shall result in disqualification of the Bid; and

⁸ a "party" refers to a participant in the procurement process or contract execution.

- (f) will report any case of corrupt, fraudulent, collusive, coercive or obstructive practice to the relevant RGoB agencies, including but not limited to the Anti-Corruption Commission (ACC) of Bhutan, for necessary action in accordance with the statutes and provisions of the relevant agency.

2.2 Furthermore, Bidders shall be aware of the provision stated in GCC Sub-Clause 59.1

3. Eligible Bidders

3.1 A Bidder, and all parties constituting the Bidder, shall have the nationality as specified in the Section II Bid Data Sheet & subject to the provisions of Section III, Eligible Countries. A Bidder shall be deemed to have the nationality of a country if the Bidder is a citizen or is constituted, incorporated, or registered and operates in conformity with the provisions of the laws of that country. This criterion shall also apply to the determination of the nationality of proposed subcontractors or suppliers for any part of the Contract including related services.

3.2 A Bidder shall not have a conflict of interest. All Bidders found to have conflict of interest shall be disqualified. Bidders may be considered to have a conflict of interest with one or more parties in this bidding process, if:

- (a) they have at least one controlling partner in common; or
- (b) they receive or have received any direct or indirect subsidy from either party; or
- (c) they have the same authorized legal representative for purposes of this Bid; or
- (d) they have a relationship with each other, directly or through common third parties, that puts them in a position to have access to information about or influence on the Bid of another Bidder, or influence the decisions of the Employer regarding this bidding process; or
- (e) a Bidder participates in more than one Bid in this bidding process. Participation by a Bidder in more than one Bid shall result in the disqualification of all Bids in which such Bidder is involved. However, this does not limit the inclusion of the same subcontractor in more than one Bid; or
- (f) a Bidder or any of its affiliates participated as a consultant in the preparation of the design or technical specifications of the Works that are the subject of the Bid or in any other way provided consulting services in any aspect of the preparatory stages leading up to the issue of these Bidding Documents; or
- (g) a Bidder or any of its affiliates has been hired (or is proposed to be hired) by the Employer as Project Manager for the Contract implementation; or
- (h) a Bidder or any of its affiliates employs or otherwise engages a close relative of a civil servant who either is employed by

the Employer or has an authority over the bidder or its affiliates or over the bid. For the purposes of this Sub-Clause a close relative is defined as immediate family which includes father, mother, brother, sister, spouse and own children..

- 3.3 A Bidder that is determined to be ineligible pursuant to any of the provisions of this Bidding Document shall not be eligible to be awarded a Contract.
- 3.4 Government-owned enterprises in Bhutan shall be eligible only if they can establish that they (i) are legally and financially autonomous, (ii) operate under commercial law, and (iii) are not a dependent agency of the Employer.
- 3.5 Bidders shall provide such evidence of their continued eligibility satisfactory to the Employer as the Employer shall reasonably request.
- 3.6 A firm shall be excluded if:
 - (a) as a matter of law or official regulation, Bhutan prohibits commercial relations with the country in which the firm is constituted, incorporated or registered; or
 - (b) by an act of compliance with a decision of the United Nations Security Council taken under Chapter VII of the Charter of the United Nations, Bhutan prohibits any import of goods or contracting of Works or services from that country in which the firm is constituted, incorporated or registered or any payments to persons or entities in that country.
- 3.7 A Bidder shall also be excluded if:
 - (a) he is insolvent or is in receivership or is a bankrupt or is in the process of being wound up, or has entered into an arrangement with his creditors; or
 - (b) his affairs are being administered by a court, judicial officer or appointed liquidator; or
 - (c) he has suspended business or is in any analogous situation arising from similar procedures under the laws and regulations of his country of establishment; or
 - (d) he has been found guilty of professional misconduct by a recognized tribunal or professional body; or
 - (e) he has not fulfilled his obligations with regard to the payment of taxes, social security or other payments due in accordance with the laws of the country in which he is established or of the Kingdom of Bhutan; or
 - (f) he is or has been guilty of serious misrepresentation in supplying information required for any prior registration with the Employer or the Construction Development Board of Bhutan; or
 - (g) he has been convicted of fraud and/or corruption by a

competent authority; or

(h) he has not fulfilled his contractual obligations with the Employer in the past; or

(j) he has been debarred from participation in public procurement by any competent authority as per law.

4. Qualifications of the Bidder

4.1 All Bidders shall provide in Section IV, Forms of Bid, Qualification Information, Letter of Acceptance, Contract and Integrity Pact, a preliminary description of the proposed work method and schedule, including drawings and charts, as necessary.

4.2 In the event that pre-qualification of potential Bidders has been undertaken, only Bids from pre-qualified Bidders shall be considered for award of Contract. These qualified Bidders should submit with their Bids any information updating their original pre-qualification applications or, alternatively, confirm in their Bids that the originally submitted pre-qualification information remains essentially correct as at the date of Bid submission. The update or confirmation should be provided in Section IV.

4.3 If the Employer has not undertaken pre-qualification of potential Bidders, all Bidders shall include the following information and documents with their Bids in Section IV, unless otherwise stated in the BDS:

(a) **Legal status:** copies of original documents defining the constitution or legal status, place of registration, and principal place of business of the Bidder; written power of attorney of the signatory of the Bid to commit the Bidder;

(b) **General work experience:** annual turnover for each of the last three (3) calendar years for construction works;

(c) **Similar work experience:** experience in works of a similar nature and size for each of the last five (5) calendar years, and details of work under way or contractually committed; and clients who may be contacted for further information on those contracts;

(d) **Equipment:** list of construction equipment owned by the Contractor and those proposed to be hired to be used for implementation of the Contract;

(e) **Manpower:** qualifications and experience of key site management and technical personnel proposed for this Contract. A person having a valid contract license cannot be an employee of any bidder

(f) **Performance of previous work:** performance score card issued by the Procuring Agencies for works done in the last five (5) calendar years;

(g) **Financial capacity:** evidence of adequacy of working capital for this Contract (access to line(s) of credit);

(h) **References:** authority to seek references from the Bidder's

bankers;

- (i) **Litigation:** information regarding any litigation, current or during the last five (5) years, in which the Bidder was/is involved, the parties concerned, and the disputed amounts; and awards. A consistent history of litigation or arbitration awards against the Applicant or any partner of a JV/C/A may result in disqualification ;
- (j) **Subcontracting:** proposals for subcontracting components of the Works amounting to more than twenty percent (20%) of the Contract Price. The ceiling for subcontractors' participation is stated in the BDS.

4.4 Bids submitted by a Joint Venture, Consortium or Association (JV/C/A) of two or more firms as partners shall comply with the following requirements, unless otherwise stated in the BDS:

- (a) the Bid shall include all the information listed in ITB Sub-Clause 4.3 above for each JV/C/A partner;
- (b) the Bid shall be signed so as to be legally binding on all partners;
- (c) all partners shall be jointly and severally liable for the execution of the Contract in accordance with the Contract terms;
- (d) one of the partners shall be nominated as being in charge, authorized to incur liabilities, and receive instructions for and on behalf of any and all partners of the JV/C/A;
- (e) the execution of the entire Contract, including payment, shall be done exclusively with the partner in charge; and
- (f) a copy of the JV/C/A Agreement entered into by the partners shall be submitted with the Bid; or a Letter of Intent to execute a JV/C/A Agreement in the event of a successful Bid shall be signed by all partners and submitted with the Bid, together with a copy of the proposed Agreement.

4.5 To qualify for award of the Contract, Bidders shall be evaluated against the following technical qualifying criteria and scores awarded accordingly:

- (a) Similar works experience : aggregate size of similar works (maximum three) or size of the largest similar work in the last five (5) calendar years;⁹
- (b) Access to adequate equipments: list of construction equipment owned by the Contractor and those proposed to be hired to be used for implementation of the Contract against the prescribed list specified in the BDS;

⁹ This amount is usually not less than 1 to 1.5 times the estimated annual cash flow for the Contract.

- (c) Availability of skilled manpower: availability of skilled and experienced manpower required for the timely and quality execution of the work against the list of manpower with the desired qualification and experience specified in the BDS in the BDS;
- (d) Average performance score from the previous works carried out in the last five (5) calendar years;
- (e) Bid capacity of the contractor against the quoted bid calculated using the following formula:

$$\text{Bid Capacity} = 2 * A * N - B$$

Where A= Average turnover of the Contractor over the last 3 calendar years

N= Estimated duration of the Project to be tendered

B= Portion of other ongoing Works to be completed in the period that overlaps with the current project's duration (that is N and

- (f) Access to or Availability of Credit Facilities: The amount of line of Credit is specified in BDS

4.6 In the case of joint ventures, the individual credentials of the joint venture partners need to be averaged using their stake in the JV for the purpose of evaluation under the parameters of Similar work experience, performance score from previous work, Bid Capacity and Credit line available. For the parameters of equipment, manpower, Status, Employment of VTI/skilled local labourer and Internship to VTI, the resources or information committed / provided by the JV as a single entity will be considered for award of points.

4.7 Domestic bidders and joint ventures, consortia or associations of domestic bidders who may be eligible for a margin of preference in Bid evaluation shall supply all information to satisfy the criteria for eligibility as described in ITB Clause 3 of these Instructions to Bidders.

4.8 Financial bids of only those Bidders who meet the minimum technical score specified in the BDS will be considered for award of the work.

5. One Bid per Bidder

5.1 Each Bidder shall submit only one Bid, either individually or as a partner in a JV/C/A. A Bidder who submits or participates in more than one Bid (other than as a subcontractor or in cases of alternatives that have been permitted or requested) shall cause all the proposals with the Bidder's participation to be disqualified.

6. Cost of Bidding

6.1 The Bidder shall bear all costs associated with the preparation and submission of his Bid, and the Employer shall in no case be responsible or liable for those costs.

7. Site Visit

7.1 The Bidder, at the Bidder's own responsibility and risk, is encouraged to visit and examine the Site of Works and its surroundings and obtain all information that may be necessary for

preparing the Bid and entering into a contract for construction of the Works. The costs of visiting the Site shall be at the Bidder's own expense.

B. Bidding Documents

8. Content of Bidding Documents

8.1 The set of Bidding Documents comprises the documents listed in the table below and addenda issued in accordance with ITB Clause 10:

| | |
|---------------|--|
| Section I: | Instructions to Bidders |
| Section II: | Bidding Data Sheet Eligible Countries |
| Section IV: | Forms of Bid, Qualification Information and Evaluation Table , Letter of Acceptance, and Contract |
| Section V: | General Conditions of Contract |
| Section VI: | Special Conditions of Contract |
| Section VII: | Specifications and Performance Requirements |
| Section VIII: | Drawings |
| Section IX: | Bill of Quantities ¹⁰ - This (or the Activity Schedule in the case of lump sum Contracts) comprises a paper hard copy and an electronic copy on CD-ROM. |
| Section X: | Forms of Securities and Invitation for Bids |

9. Clarification of Bidding Documents

9.1 A prospective Bidder requiring any clarification of the Bidding Documents may notify the Employer in writing, including by cable, facsimile, telex or electronic mail, at the Employer's address indicated in the BDS. The Employer shall respond to any request for clarification received earlier than fifteen (15) days¹¹ prior to the deadline for submission of bids. Copies of the Employer's response shall be forwarded to all purchasers of the Bidding Documents, including a description of the inquiry, but without identifying its source. Should the clarification result in changes to the essential elements of the Bidding Documents, the Employer shall amend the Bidding Documents, following the procedure in ITB Clause 10 and ITB Sub-Clause 20.2.

9.2 The bidder or his official representative is invited to attend a pre-bid meeting, which will take place at the place and time stated in BDS.

9.3 The purpose of the meeting will be to clarify issues and to answer questions on any matter that may be raised at that stage.

9.4 The bidder is requested to submit any questions in writing or by facsimile or email to reach the Employer not later than one week before the meeting.

9.5 Minutes of the meeting, including the text of the questions raised (without identifying the source of inquiry) and the responses given will be transmitted without delay to all purchasers of the bidding documents. Any modification of the bidding

¹⁰ In lump sum contracts, delete "Bill of Quantities" and replace with "Activity Schedule".

¹¹ It may be necessary to extend the deadline for submission of bids if the Employer's response results in substantial changes to the Bidding Documents. See ITB Clause 10 below.

documents listed in Sub-Clause 9.1 which may become necessary as a result of the pre-bid meeting shall be made by the Employer exclusively through the issue of an Addendum pursuant to Clause 10 and not through the minutes of the pre-bid meeting.

9.6 Non-attendance of the pre-bid meeting will not be a cause for disqualification of a bidder.

10. Amendment of Bidding Documents

10.1 Before the deadline for submission of Bids, the Employer may modify the Bidding Documents by issuing addenda.

10.2 Any addendum thus issued shall be part of the Bidding Documents, shall be binding on all Bidders and shall be communicated in writing, including by cable, facsimile, telex or electronic mail, to all purchasers of the Bidding Documents.¹² Prospective Bidders shall acknowledge receipt of each addendum in writing, including by electronic mail, to the Employer.

10.3 To give prospective Bidders reasonable time in which to take an addendum into account in preparing their Bids, the Employer shall extend, as necessary, the deadline for submission of Bids, in accordance with ITB Sub-Clause 20.2 below.

C. Preparation of Bids

11. Language of Bid

11.1 All documents relating to the Bid shall be in the language specified in the BDS.

12. Documents Comprising the Bid¹³

12.1 The Bid submitted by the Bidder shall comprise the following:

- (a) The Bid form (in the format indicated in Section IV – Forms of Bid, Qualification Information, Letter of Acceptance, Contract and Integrity Pact);
- (b) Bid Security in accordance with Clause 16;
- (c) Priced Bill of Quantities¹⁴ - this must be submitted in paper form, signed by the duly authorized signatory of the Bidder, and also in electronic form on CD-ROM, if required by the Employer;
- (d) Qualification Information Form and Documents;
- (e) Alternative offers where invited;

and any other materials required to be completed and submitted by Bidders, as specified in the BDS.

13. Bid Prices

13.1 The Contract shall be for the whole Works, as described in ITB Sub-Clause 1.1, based on the priced Bill of Quantities¹⁵ submitted by the Bidder.

¹² It is therefore important that the Employer maintain a complete and accurate list of recipients of the Bidding Documents and their addresses.

¹⁴ In lump sum contracts, delete "priced Bill of Quantities" and replace with "priced Activity Schedule".

- 13.2 The Bidder shall fill in rates and prices for all items of the Works described in the Bill of Quantities.¹⁶ Items for which no rate or price is entered by the Bidder shall not be paid for by the Employer when executed and shall be deemed covered by the other rates and prices in the Bill of Quantities. Corrections, if any, shall be made by crossing out, initialing, dating and rewriting.
- 13.3 The Bidder shall quote its final all-inclusive net price, including all incidental costs, for carrying out the Contract. All duties, taxes and other levies payable by the Contractor under the Contract, or for any other cause, as of the date 30 days prior to the deadline for submission of Bids, shall be included in the rates, prices and total Bid price submitted by the Bidder.¹⁷
- 13.4 The rates and prices¹⁸ quoted by the Bidder shall be subject to adjustment during the performance of the Contract¹⁹ if provided for in the BDS and the SCC and the provisions of GCC Clause 47 of the General Conditions of Contract. The Bidder shall submit with the Bid all the information required under the SCC and GCC Clause 47 of the General Conditions of Contract.

14. Currencies of Bid and Payment

- 14.1 The unit rates and prices²⁰ shall be quoted by the Bidder entirely in Ngultrum (Nu). Foreign currency requirements shall be indicated as a percentage of the Bid price (excluding provisional sums²¹) and shall be payable at the option of the Bidder in up to three foreign currencies.
- 14.2 The rates of exchange to be used by the Bidder in arriving at the local currency equivalent and the percentage(s) mentioned in ITB Sub-Clause 14.1 above shall be the selling rates for similar transactions established by the authority specified in the BDS prevailing on the date 30 days prior to the latest deadline for submission of Bids. These exchange rates shall apply for all payments so that no exchange risk shall be borne by the Bidder. If the Bidder uses other rates of exchange, the provisions of ITB Clause 28.1 shall apply. In any case, payments shall be computed using the rates quoted in the Bid.
- 14.3 Bidders shall indicate details of their expected foreign currency requirements in the Bid.
- 14.4 Bidders may be required by the Employer to clarify their foreign currency requirements and to substantiate that the amounts included in the rates and prices²², if required in the BDS, are reasonable and responsive to ITB Sub-Clause 14.1.
- 14.5 In case of International Procurement from countries other than India, the procuring agency may invite bids in convertible currencies. The bids shall however, be evaluated in accordance with Sub-Clause 14.2

¹⁶ In lump sum contracts, delete “described in the Bill of Quantities” and replace with “described in the drawings and specifications and listed in the Activity Schedule”.

¹⁷ In lump sum contracts, delete “rates, prices, and”.

¹⁸ In lump sum contracts, delete “rates and prices” and replace with “lump sum price”.

¹⁹ For contracts with a duration of more than 18 months the price adjustment normally should be allowed

²⁰ In lump sum contracts, delete “unit rates and prices” and replace with “lump sum price”.

²¹ Provisional sums are monetary sums specified by the Employer in the Bill of Quantities, to be used at his discretion for nominated subcontractors and other specified purposes.

²² For lump sum contracts, delete “rates and prices” and replace with “Lump Sum”.

above, but the payment shall be made in the currency of bid.

15. Bid Validity

- 15.1 Bids shall remain valid for the period specified in the BDS.
- 15.2 In exceptional circumstances, the Employer may request that the Bidders extend the period of validity for a specified additional period. The request and the Bidders' responses shall be made in writing or by electronic mail. The Bid Security required pursuant to ITB Clause 16 shall be extended to 30 days after the deadline of the extended Bid validity period. A Bidder may refuse the request without forfeiting the Bid Security. The refusal to extend the bid by the bidder will make the bid invalid and shall not be further considered for evaluation and award, A Bidder agreeing to the request shall not be required or permitted to modify its Bid, except as provided for in ITB Clause 16.
- 15.3 In the case of contracts in which the Contract Price is fixed (not subject to price adjustment), if the period of Bid validity is extended beyond 60 days, the amounts payable in local and foreign currency to the Bidder selected for award shall be adjusted as specified in the request for extension. Bid evaluation shall be based on the Bid Price without taking the above correction into consideration.

16. Bid Security

- 16.1 The Bidder shall furnish, as part of the Bid, a Bid Security as specified in the BDS.
- 16.2 The Bid Security shall be in fixed amount as specified in BDS and denominated in Ngultrum (Nu) or the currency of the Bid or in another freely convertible currency, and shall:
- (a) at the Bidder's option, be in any of the following forms:
 - (i) a demand unconditional bank guarantee; or
 - (ii) a account payee demand draft; or
 - (iii) a account payee cash warrant.
 - (b) be issued by a financial institution in Bhutan acceptable to the Employer & selected by the Bidder.
 - (c) in the case of a bank guarantee, be substantially in accordance with the form of Bid Security included in Section X, Security Forms, or other form approved by the Employer prior to Bid submission;
 - (d) be payable promptly upon written demand by the Employer in case the conditions listed in ITB Sub-Clause 16.5 are invoked;
 - (e) be submitted in its original form; copies shall not be accepted;
 - (f) remain valid for a period of 30 days beyond the validity period of the Bids, as extended, if applicable, in accordance with ITB Sub-Clause 15.2.
- 16.3 Any Bid not accompanied by a responsive Bid Security shall be Rejected by the Employer as non-responsive.

- 16.4 The Bid Securities of unsuccessful Bidders shall be returned as promptly as possible upon the successful Bidder furnishing the Performance Security and in any event not later than 30 days after the expiration of the validity of the unsuccessful Bidder's Bid.
- 16.5 The Bid Security may be forfeited
- (a) if a Bidder withdraws its Bid during the period of Bid validity specified by the Bidder on the Bid Submission Sheet, except as provided for in ITB Sub-Clause 15.2; or
 - (b) if the Bidder that submitted the lowest evaluated Bid does not accept the correction of the Bid price pursuant to Clause 27; or
 - (c) if the successful Bidder fails within the specified time limit to
 - (i) sign the Contract; or
 - (ii) furnish the required Performance Security
- 16.6 The Bid Security of a JV/C/A must be in the name of the JV/C/A that submits the Bid. If the JV/C/A has not been legally constituted at the time of bidding, the Bid Security shall be in the names of all future partners as named in the letter of intent.

17. Alternative Proposals by Bidders

- 17.1 Alternatives shall not be considered, unless specifically allowed in the BDS. If so allowed, ITB Sub-Clauses 17.1 and 17.2 shall govern, and the BDS shall specify which of the following options shall be allowed:
- (a) Option One. A Bidder may submit alternative Bids with the base Bid and the Employer shall only consider the alternative Bids offered by the Bidder whose Bid for the base case was determined to be the lowest-evaluated Bid, or
 - (b) Option Two. A Bidder may submit an alternative Bid with or without a Bid for the base case. All Bids received for the base case, as well as alternative Bids meeting the Technical Specifications and Performance Requirements pursuant to Section VII, shall be evaluated on their own merits.
- 17.2 Alternative Bids shall provide all information necessary for a complete evaluation of the alternative by the Employer, including design calculations, technical specifications, breakdown of prices, proposed construction methods and other relevant details.

18. Format and Signing of Bid

- 18.1 The Bidder shall prepare one original of the documents comprising the Bid as described in **ITB Clause 12**, bound with the volume containing the Form of Bid, and clearly marked "ORIGINAL." In addition, the Bidder shall submit copies of the Bid, in the number specified in the BDS, and clearly marked as "COPIES." In the event of any discrepancy between the original and any copies, or between the original paper form of the Bill of Quantities (or Activity Schedule in the case of lump sum Contracts) and the electronic version on CD-ROM, the original shall prevail.
- 18.2 The original and all copies of the Bid shall be typed or written in indelible ink and shall be signed by a person or persons duly authorized to sign on behalf of the Bidder, pursuant to ITB Sub-Clause 4.3 (a). Unsigned Form of Bid & BOQ shall make the bid non-

responsive. All pages of the Bid where entries or amendments have been made shall be initialed by the person or persons signing the Bid.

18.3 The Bid shall contain no alterations or additions, except those to comply with instructions issued by the Employer, or as necessary to correct errors made by the Bidder, in which case such corrections shall be initialed by the person or persons signing the Bid.

18.4 The Bidder shall furnish information as described in the Form of Bid on commissions or gratuities, if any, paid or to be paid to agents relating to this Bid, and to contract execution if the Bidder is awarded the contract.

D. Submission of Bids

19. Sealing and Marking of Bids²³

19.1 Bidders may always submit their Bids by mail or by hand. When so specified in the BDS, Bidders shall have the option of submitting their Bids electronically. Bidders submitting Bids electronically shall follow the procedures specified in the BDS. The Bidder shall seal the original and all copies of the Bid, including alternative Bids if permitted in accordance with ITB Clause 17, in separate inner envelopes contained within one outer envelope. All envelopes shall be sealed with adhesive or other sealant to prevent reopening.

19.2 The inner envelopes shall

- (a) be signed across their seals by the person authorized to sign the Bid on behalf of the Bidder; and
- (b) be marked "ORIGINAL", "ALTERNATIVE" (if any) and "COPIES";

19.3 The outer envelope shall:

- (a) be sealed with adhesive or other sealant to prevent reopening,
- (b) be marked "Confidential";
- (c) be addressed to the Employer at the address²⁴ provided in the BDS;
- (d) bear the name and identification number of the Contract as defined in the BDS and SCC; and
- (e) provide a warning not to open before the specified time and date for Bid opening as defined in the BDS.

19.4 In addition to the identification required in ITB Sub-Clause 19.2, the inner envelopes shall indicate the name and address of the Bidder to enable the Bid to be returned unopened in case it is declared late pursuant to ITB Clause 21.

²³ Improper marking & sealing of the document cannot result in the rejection of bids

²⁴ The receiving address shall be an office that is staffed during normal working hours by personnel authorized to certify time and date of receipt and assure safe-keeping until Bid opening. A post office address is not to be used. The address must be the same as the receiving address described in the Invitation for Bids.

- 19.5 If the outer envelope is not sealed and marked as above, the Employer shall assume no responsibility for the misplacement or premature opening of the Bid.
- 20. Deadline for Submission of Bids**
- 20.1 Bids shall be delivered to the Employer at the address specified above no later than the time and date specified in the BDS.
- 20.2 The Employer may extend the deadline for submission of Bids by issuing an amendment in accordance with ITB Clause 10, in which case all rights and obligations of the Employer and the Bidders previously subject to the original deadline shall then be subject to the new deadline.
- 21. Late Bids**
- 21.1 Any Bid received by the Employer after the deadline prescribed in ITB Clause 20 shall be returned unopened to the Bidder.
- 22. Withdrawal, Substitution and Modification of Bids**
- 22.1 Bidders may withdraw, substitute or modify their Bids by giving notice in writing before the deadline prescribed in ITB Clause 20.
- 22.2 Each Bidder's withdrawal, substitution or modification notice shall be prepared, sealed, marked and delivered in accordance with ITB Clauses 18 and 19, with the outer and inner envelopes additionally marked "WITHDRAWAL", "SUBSTITUTION" or "MODIFICATION" as appropriate.
- 22.3 No Bid may be substituted or modified after the deadline for submission of Bids.
- 22.4 Withdrawal of a Bid between the deadline for submission of Bids and the expiration of the period of Bid validity specified in the BDS or as extended pursuant to ITB Sub-Clause 15.2 may result in the forfeiture of the Bid Security pursuant to ITB Clause 16. If the lowest or the lowest evaluated bidder withdraws his bid between the periods specified pursuant to clause 22.4, the bid security of the bidder shall be forfeited and in addition the bidder shall pay to the Employer the positive difference of sum, if any with the next lowest Bidder within 14 days of his withdrawal. If the bidder fails to pay the difference within the said date, the bidder shall be debarred by a Competent Authority as per law.
- 22.5 Bidders may only offer discounts to, or otherwise modify the prices of their Bids, by submitting Bid modifications in accordance with this clause or included in the initial Bid submission.

E. Bid Opening and Evaluation

- 23. Bid Opening**
- 23.1 The Employer shall open the Bids, including modifications made pursuant to ITB Clause 22, in the presence of the Bidders' representatives who choose to attend at the time and in the place specified in the BDS. Any specific opening procedures required if electronic bidding is permitted in accordance with ITB Sub-Clause 20.1 shall be as specified in the BDS.
- 23.2 Envelopes marked "WITHDRAWAL" shall be opened and read out

first. Bids for which an acceptable notice of withdrawal has been submitted pursuant to ITB Clause 22 shall not be opened.

- 23.3 The Original & Copies will be opened at the bid opening. The Bidders' names, the Bid prices, the total amount of each Bid and of any alternative Bid (if alternatives have been requested or permitted), any discounts, Bid withdrawals, substitutions or modifications, the presence or absence of Bid Security (and any other details the Employer may consider appropriate) responses to any Bidding Documents addenda; fulfillment of any such other specific formal requirements as are prescribed in the Bidding Documents; and such other details as the Employer may consider appropriate, shall be announced by the Employer at the opening. This information also shall be written on a notice board for the public to copy. Any Bid price, discount or alternative Bid price not announced and recorded shall not be taken into account in Bid evaluation.

The bid form including appendices to bid form, bill of quantities, price schedules, bid securities, any discounts offered, and any other important documents shall be initialed by all members of the Bid Opening Committee. All corrections/overwriting will be noted and recorded on each page of the Bill of Quantities. The bid evaluation will be done using the Copies while the Original will be kept in safe custody. If there are any discrepancies between the Original & Copies, the Original shall prevail.

No Bid shall be rejected at Bid opening except for late Bids pursuant to ITB Clause 21. Substitution Bids and modifications submitted pursuant to ITB Clause 22 that are not opened and read out at Bid opening shall not be considered for further evaluation regardless of the circumstances. Late, withdrawn and substituted Bids shall be returned unopened to Bidders.

- 23.4 The Employer shall prepare Minutes of the Bid opening, including the information disclosed to those present in accordance with ITB Sub-Clause 23.3. The Minutes shall include, as a minimum:
- (a) the Contract title and reference number;
 - (b) the Bid number;
 - (c) the Bid deadline date and time;
 - (d) the date, time and place of Bid opening;
 - (e) Bid prices, per lot if applicable, offered by the Bidders, including any discounts and alternative offers;
 - (f) the presence or absence of Bid security and, if present, its amount and validity;
 - (g) name and nationality of each Bidder, and whether there is a withdrawal, substitution or modification;
 - (h) the names of attendees at the Bid opening, and of the Bidders they represent (if any);
 - (i) details of any complaints or other comments made by

attendees/representatives attending the Bid opening, including the names and signatures of the attendees/representatives making the complaint(s) and/or comment(s); and

- (j) the names, designations and signatures of the members of the Bid Opening Committee.

The Bidders' representatives and attendees who are present shall be requested to sign the record. The omission of a Bidder's or other attendee's signature on the record shall not invalidate the contents and effect of the record. A copy of the record shall be distributed to all Bidders.

24. Confidentiality

- 24.1 Information relating to the examination, clarification, evaluation and comparison of Bids and recommendations for the award of a contract shall not be disclosed to Bidders or any other persons not officially concerned with such process until publication of the award to the successful Bidder has been announced pursuant to ITB Sub-Clause 33.4. Any effort by a Bidder to influence the Employer's processing of Bids or award decisions may result in the rejection of his Bid. Notwithstanding the above, from the time of Bid opening to the time of Contract award, if any Bidder wishes to contact the Employer on any matter related to the Bidding process, it should do so in writing, including by electronic mail.

25. Clarification of Bids

- 25.1 To assist in the examination, evaluation and comparison of Bids, the Employer may, at the Employer's discretion, ask any Bidder for clarification of the Bidder's Bid, including breakdowns of unit rates.²⁵ The request for clarification and the response shall be in writing, including by electronic mail, but no change in the price or substance of the Bid shall be sought, offered or permitted except as required to confirm the correction of arithmetic errors discovered by the Employer in the evaluation of the Bids in accordance with ITB Clause 27.

26. Examination of Bids and Determination of Responsiveness

- 26.1 Prior to the detailed evaluation of Bids, the Employer shall determine whether each Bid (a) meets the eligibility criteria defined in ITB Clause 3; (b) has been properly signed; (c) is accompanied by the Bid Security; and (d) is substantially responsive to the requirements of the Bidding Documents.
- 26.2 A substantially responsive Bid is one which conforms to all the terms, conditions and specifications of the Bidding Documents, without material deviation or reservation. A material deviation or reservation is one (a) which affects in any substantial way the scope, quality or performance of the Works; (b) which limits in any substantial way, inconsistent with the Bidding Documents, the Employer's rights or the Bidder's obligations under the Contract; or (c) whose rectification would affect unfairly the competitive position of other Bidders presenting substantially responsive Bids.
- 26.3 If a Bid is not substantially responsive, it will be rejected by the Employer, and may not subsequently be made responsive by correction or withdrawal of the nonconforming deviation or

²⁵ In lump sum contracts, delete "unit rates" and replace with "the prices in the Activity Schedule".

reservation.

27. Correction of Errors

27.1 Bids determined to be substantially responsive shall be checked by the Employer for any arithmetic errors. Errors shall be corrected by the Employer as follows:²⁶

- (a) where there is a discrepancy between the amounts in figures and in words, the amount in words shall govern; and
- (b) where there is a discrepancy between the unit rate and the line item total resulting from multiplying the unit rate by the quantity, the unit rate as quoted shall govern, unless in the opinion of the Employer there is an obviously gross misplacement of the decimal point in the unit rate, in which case the line item total as quoted shall govern, and the unit rate shall be corrected.

27.2 The corrections will be notified in writing to the individual bidder with a request for written acceptance of the corrections within the specified period as made in the notification. The amount stated in the Bid shall be adjusted by the Employer in accordance with the above procedure for the correction of errors and, with the concurrence of the Bidder, shall be considered as binding upon the Bidder. If the Bidder does not accept the corrected amount, the Bid shall be rejected, and the Bid Security may be forfeited in accordance with ITB Sub-Clause 16.5 (b).

28. Currency for Bid Evaluation

28.1 Bids shall be evaluated as quoted in Ngultrum (NU) in accordance with ITB Sub-Clause 14.1, unless a Bidder has used different exchange rates than those prescribed in ITB Sub-Clause 14.2, in which case the Bid shall be first converted into the amounts payable in different currencies using the rates quoted in the Bid and then reconverted to Ngultrum (NU) using the exchange rates prescribed in ITB Sub-Clause 14.2.

29. Evaluation and Comparison of Bids

29.1 The Employer shall evaluate and compare only the Bids determined to be substantially responsive in accordance with ITB Clause 26.

29.2 In evaluating the Bids, the Employer shall determine for each Bid the evaluated Bid price by adjusting the Bid price as follows:

- (a) making any correction for errors pursuant to ITB Clause 27;
- (b) excluding provisional sums and the provision (unless no rates have been asked from the bidders), if any, for contingencies in the Bill of Quantities,²⁷ but including Daywork,²⁸ where priced competitively;
- (c) making an appropriate adjustment for any other acceptable variations, deviations or alternative offers submitted in

²⁶ In lump sum contracts, delete from "as follows" to the end, and replace with the following: "as follows: where there is a discrepancy between the amounts in figures and in words, the amount in words shall govern."

²⁷ In lump sum contracts, delete "Bill of Quantities" and replace with "Activity Schedule".

²⁸ Daywork is work carried out following instructions of the Employer and paid for on the basis of time spent by workers, and the use of materials and the Contractor's equipment, at the rates quoted in the Bid. For Daywork to be priced competitively for Bid evaluation purposes, the Employer must list tentative quantities for individual items to be costed against Daywork (e.g., a specific number of tractor driver staff-days, or a specific tonnage of Portland cement), to be multiplied by the bidders' quoted rates and included in the total Bid price.

accordance with ITB Clause 17; and

- (d) making appropriate adjustments to reflect discounts or other price modifications offered in accordance with ITB Sub-Clause 22.5.

29.3 The bids shall be evaluated by applying the evaluation criteria, sub criteria and points system specified in the BDS. Each responsive bid will be given a technical score. Financial bids of only those bidders who score the minimum technical score specified in the BDS will be considered to for the 2nd stage of bid evaluation to obtain an overall price preference -financial score. Work will be awarded to the Bidder obtaining the highest overall price preference -financial score which will be obtained using the following formula:

$90 \% \times (\text{Lowest quoted bid among qualifying tenders} / \text{financial bid quoted by } x) + 10\% \times \text{Price preference score for } x.$

29.4 The Employer reserves the right to accept or reject any variation, deviation or alternative offer. Variations, deviations and alternative offers and other factors which are in excess of the requirements of the Bidding Documents or otherwise result in unsolicited benefits for the Employer shall not be taken into account in Bid evaluation.

29.5 The estimated effect of any price adjustment conditions under GCC Clause 47, during the period of implementation of the Contract, shall not be taken into account in Bid evaluation.

29.6 If the Bid which results in the lowest evaluated Bid price is abnormally low, seriously unbalanced and/or front loaded in the opinion of the Employer, the Employer shall require the Bidder to produce written explanations of, justifications and detailed price analyses for any or all items of the Bill of Quantities, to demonstrate the internal consistency of those prices with the construction methods and schedule proposed. Such explanations, justifications and analyses may also include, but are not limited to, details of the technical solutions chosen, exceptionally favorable conditions available to the Bidder for the execution of the Contract, and the originality of the Works proposed by the Bidder. After objective evaluation of the explanations, justifications and price analyses, taking into consideration the schedule of estimated Contract payments, if the Procuring Agency decides to accept the abnormally low, seriously unbalanced and/ or front loaded price, the bidder shall be required to provide additional differential security equivalent to the difference between the estimated amount and the quoted price in addition to the performance security.

30. Preference for Domestic Bidders

30.1 As indicated in the BDS, domestic contractors may receive a margin of preference in Bid evaluation, for which this clause shall apply.

30.2 A domestic Bidder shall provide all evidence necessary to prove that it meets the following criteria to be eligible for a margin of preference in the comparison of its Bid with those of Bidders who do not qualify for the preference. A domestic Bidder shall:

- (a) be registered within Bhutan, constituted under and governed by the civil, commercial or public law of Bhutan, and have its

- statutory office, central administration or principal place of business there;
- (b) have majority ownership by nationals of Bhutan;
 - (c) not subcontract more than twenty percent (20) percent of the Contract Price, excluding provisional sums, to foreign contractors, suppliers and/or consultants.
- 30.3 Joint Ventures, Consortia and Associations of domestic firms may be eligible for the margin of preference provided that:
- (a) the individual partners satisfy the criteria of eligibility of ITB Sub-Clauses 30.2 (a) and (b);
 - (b) the JV/C/A is registered in Bhutan;
 - (c) the JV/C/A does not subcontract more than ten percent (10%) of the Contract Price, excluding provisional sums, to foreign firms; and
 - (d) the JV/C/A satisfies any other criteria specified for the purpose of domestic preference eligibility, as specified in the BDS.
- 30.4 The procedure used to apply the margin of preference shall be as stipulated in the BDS.

F. Award of Contract

31. Award Criteria

- 31.1 Subject to ITB Clause 32, the Employer shall award the Contract to the Bidder whose Bid has been determined to be substantially responsive to the Bidding Documents and who has scored the highest in the price preference – financial score of 100, provided that such Bidder has been determined to be (a) eligible in accordance with the provisions of ITB Clause 3, and (b) qualified in accordance with the provisions of ITB Clause 4.

32. Employer's Right to Accept any Bid and to Reject any or all Bids

- 32.1 Notwithstanding ITB Clause 31, the Employer reserves the right to accept or reject any Bid, and to cancel the bidding process and reject all Bids, at any time prior to the award of Contract, without thereby incurring any liability to the affected Bidder or Bidders or any obligation to inform the affected Bidder or Bidders of the grounds for the Employer's action.²⁹

33. Notification of Award and Signing of Contract

- 33.1 The Bidder who's Bid has been accepted shall be notified in writing of the award by the Employer prior to expiration of the Bid validity period. This notification letter (hereinafter and in the General Conditions of Contract called the "Letter of Acceptance") shall state the sum that the Employer shall pay the Contractor in consideration of the execution, completion and maintenance of the Works by the Contractor as

²⁹ Employers should not reject bids or annul bidding processes, except as permitted in the Procurement Manual and these Bidding Documents.

prescribed by the Contract (hereinafter and in the Contract called the "Contract Price").

- 33.2 The Letter of Acceptance shall constitute the formation of the Contract, subject to the Bidder furnishing the Performance Security in accordance with ITB Clause 34 and signing the Contract in accordance with ITB Sub-Clause 33.3. It shall be accompanied by two originals of the Contract in the form provided for in Section IV – Forms of Bid, Qualification Information, Letter of Acceptance, and Contract.
- 33.3 The Contract shall incorporate all agreements between the Employer and the successful Bidder. It shall be signed by the Employer and sent to the successful Bidder with the Letter of Acceptance. Within 15 days of receipt, the successful Bidder shall sign the Contract and deliver it to the Employer.
- 33.4 Upon the furnishing by the successful Bidder of the Performance Security, the Employer shall notify all other Bidders of the results of the bidding and shall publish a notification of award on the Employer's website. The notifications to all other Bidders as well as the notification posted on the Employer's website shall include the following information:
- (i) the Bid and lot numbers
 - (ii) name of the winning Bidder, and the Price it offered, as well as the duration and summary scope of the contract awarded; and
 - (iii) the date of the award decision.

34. Performance Security

- 34.1 Within fifteen (15) working days after receipt of the Letter of Acceptance the successful Bidder shall deliver to the Employer a Performance Security in the amount stipulated in the GCC and in the form stipulated in the BDS, denominated in the type and proportions of currencies in the Letter of Acceptance and in accordance with the GCC.
- 34.2 If the Performance Security is provided by the successful Bidder in the form of a Bank Guarantee, it shall be issued, at the Bidder's option, by a financial institution located in Bhutan.
- 34.3 Failure of the successful Bidder to comply with the requirements of ITB Sub-Clauses 33.3 and 34.1 shall constitute sufficient grounds for cancellation of the award and forfeiture of the Bid Security. If the lowest evaluated bidder fails to produce the performance guarantee & sign the contract then apart from forfeiture of Bid Security, the bidder will also be required to bear the positive difference in contract amount between his bid and the bidder to whom the work has been awarded.
- 34.4 Upon the successful Bidder's signing of the Contract and furnishing of the Performance Security pursuant to ITB Sub-Clause 34.1, the Employer shall promptly notify the name of the winning Bidder to each unsuccessful Bidder in accordance with ITB Sub-Clause 33.4 and shall discharge the Bid Securities of the unsuccessful Bidders pursuant to ITB Sub-Clause 16.4.

35. Advance Payment and Security

- 35.1 The Employer shall provide an Advance Payment on the Contract Price as stipulated in the GCC, subject to a maximum amount, as stated in the BDS. The advance payment shall be guaranteed by a

Security in the form provided for in Section X, Security Forms.

- 36. Adjudicator**
- 36.1 The Employer may propose the person named in the BDS to be appointed as Adjudicator under the Contract. If the Bidder disagrees with this proposal, the Bidder should so state in the Bid. If, in the Letter of Acceptance, the Employer has not agreed on the bidder's nomination of the Adjudicator, the Adjudicator may be appointed by mutual consent.

Section II. Bidding Data Sheet³⁰

| A. General | | | | | | | | | | | | | | | | | | | | | | |
|-----------------------------|---|---------------|-----------------|---------------|-----------|---|-------------|------------------|---|--------------|---------|---|--------------|-----|---|---------------|----------------|---|--------------|--|--------------|------------|
| ITB 1.1 | <p>The Employer is Gelephu Thromde</p> <p>The name and identification of the contract are [Construction of Urban Roads in LAP-II(GT/ESD-14/2014-2015/160 dated 30/07/2014)]</p> <p>The Works are: Construction of road embankment by Bajri filling, construction of culverts, Hume pipes laying and drain construction.</p> | | | | | | | | | | | | | | | | | | | | | |
| ITB 1.2 | The Intended Completion Date is [30th May, 2015(Seven Months)] | | | | | | | | | | | | | | | | | | | | | |
| ITB 4.3³¹ | The information required from Bidders in ITB Sub-Clause 4.3 is modified as follows: [NA] | | | | | | | | | | | | | | | | | | | | | |
| ITB 4.3 (j) | The ceiling for sub contractor's participation and conditions are : [NA] | | | | | | | | | | | | | | | | | | | | | |
| ITB 4.4 | The qualification data required from Bidders in ITB Sub-Clause 4.4 is modified as follows: [None]. | | | | | | | | | | | | | | | | | | | | | |
| ITB 4.5 | The qualification criteria in ITB Sub-Clause 4.5 are modified as follows: [None]. | | | | | | | | | | | | | | | | | | | | | |
| ITB 4.5 (b) | <p>The essential equipment to be made available for the Contract by the successful Bidder shall be³²: [<i>insert as appropriate</i>]</p> <table border="1" style="width: 100%; border-collapse: collapse;"> <thead> <tr> <th style="text-align: left;">Equipment</th> <th style="text-align: left;">Number required</th> <th style="text-align: left;">Maximum Marks</th> </tr> </thead> <tbody> <tr> <td>Excavator</td> <td>1</td> <td>50 (Tier-I)</td> </tr> <tr> <td>Roller(Vibrator)</td> <td>1</td> <td>10 (Tier-II)</td> </tr> <tr> <td>Tripper</td> <td>4</td> <td>20 (Tier-II)</td> </tr> <tr> <td>JCB</td> <td>1</td> <td>15 (Tier-III)</td> </tr> <tr> <td>Concrete Mixer</td> <td>1</td> <td>5 (Tier-III)</td> </tr> <tr> <td></td> <td style="text-align: center;">TOTAL</td> <td style="text-align: center;">100</td> </tr> </tbody> </table> | Equipment | Number required | Maximum Marks | Excavator | 1 | 50 (Tier-I) | Roller(Vibrator) | 1 | 10 (Tier-II) | Tripper | 4 | 20 (Tier-II) | JCB | 1 | 15 (Tier-III) | Concrete Mixer | 1 | 5 (Tier-III) | | TOTAL | 100 |
| Equipment | Number required | Maximum Marks | | | | | | | | | | | | | | | | | | | | |
| Excavator | 1 | 50 (Tier-I) | | | | | | | | | | | | | | | | | | | | |
| Roller(Vibrator) | 1 | 10 (Tier-II) | | | | | | | | | | | | | | | | | | | | |
| Tripper | 4 | 20 (Tier-II) | | | | | | | | | | | | | | | | | | | | |
| JCB | 1 | 15 (Tier-III) | | | | | | | | | | | | | | | | | | | | |
| Concrete Mixer | 1 | 5 (Tier-III) | | | | | | | | | | | | | | | | | | | | |
| | TOTAL | 100 | | | | | | | | | | | | | | | | | | | | |
| ITB 4.5 (c) | The skilled and experienced manpower required for the timely and quality execution of the work to be made available for the Contract by the successful | | | | | | | | | | | | | | | | | | | | | |

³⁰ This section should be filled out by the Employer before issuance of the Bidding Documents.

³¹ Delete if prequalification has been conducted.

³² Refer to Evaluation Guidelines for Procurement of Works-April2011for guidance on how to prepare this table.

| | | | | |
|-------------------------------|--|-----------------------------|--------------------------------------|-------|
| | Bidder shall be ³³ : <i>[insert list as appropriate]</i> . | | | |
| | Tier | Position | Qualification | Score |
| | Tier I | Project Manager | General Graduate 10+yr of Experience | 50 |
| | | | General Graduate 5+ yr of experience | 30 |
| | | | Diploma with 10+ yr experience | 20 |
| | Tier II | Civil Engineer | B.Tect (Civil) 3+ yr Experience | 30 |
| | | | Diploma (Civil) 7+yr experience | 20 |
| | | | Diploma (Civil) 3+yr experience | 10 |
| | Tier III | Work supervisor/ technician | VTI (Civil) 5+yr experience | 20 |
| | | | VTI (Civil) 2+yr experience | 10 |
| ITB 4.5(f) | The Credit Line amount is Nu. [7.71 Million] | | | |
| ITB 4.6 | Subcontractors' experience and resources <i>[" shall "]</i> be taken into account | | | |
| B. Bidding Documents | | | | |
| ITB 9.1 | The Employer's address for clarification is: To, Chief Engineer, Engineering Service Division Gelephu Thomde Contact No: +975-06251417 | | | |
| ITB 9.2 | Pre-bid Meeting shall be held on [NA] | | | |
| C. Preparation of Bids | | | | |

³³ Refer to Evaluation Guidelines for Procurement of Works-April2011for guidance on how to prepare this table.

| | |
|--------------------------------------|--|
| ITB 11.1 | The language of the bid is: [English] |
| ITB 12.1 | Any additional materials required to be completed and submitted by the Bidders are [none] . |
| ITB 13.4 | The Contract [is not] subject to price adjustment in accordance with GCC Clause 47. |
| ITB 14.2 | The authority for establishing the rates of exchange shall be the Royal Monetary Authority of Bhutan. |
| ITB 14.4 | Bidders [are not] required to substantiate the rates and prices. |
| ITB 15.1 | The Bid shall be valid for [60 days] from the deadline for submission of Bids stipulated in ITB Clause 20.1 |
| ITB 16.1 & 16.2 | The Bid Security amount is [Nu.354,000.00] |
| ITB 17.1 | Alternative Bids [shall not be] considered. <i>[If alternatives shall be considered insert "the Employer shall only consider (insert "option one is 17.1a or option two is 17.1b methods")].</i> |
| ITB 18.1 | In addition to the original Bid, the number of copies is [One] |
| D. Submission of Bids | |
| ITB 19.1 | Bidders may submit their Bids electronically: [No] . |
| ITB 19.3 (c) | The Employer's address for the purpose of Bid submission is: Dasho Thrompon, Gelephu Thromde, Gelephu. |
| ITB 19.3 (d) | The name and Identification number of the contract as given in ITB 1.1 above in this sheet. |
| ITB 19.3 (e) | The warning shall read "DO NOT OPEN BEFORE "10:30 AM, 12/09/2014" |
| ITB 20.1 | The deadline for submission of Bids shall be "10:00 AM, 12/09/2014" |
| E. Bid Opening and Evaluation | |
| ITB 23.1 | The Bid opening shall take place on the same day as the closing day of the bid submission at: [Thromde Conference Hall] Date: [12th September, 2014] ; Time: [10:30 AM] |

| | |
|-----------------------------|---|
| | If electronic bidding is permitted, the specific opening procedures are: NA |
| ITB 30.1 | Margin of domestic preference of five percent (5%) [“shall not”] apply |
| ITB 30.3 (d) | Other criteria to be used for the purpose of assessing domestic preference eligibility are: None |
| ITB 30.4 | The procedure used to apply the margin of preference shall be: In the case of procurements in which any Bids are received from foreign (i.e. non-Bhutanese) Bidders: (i) if two or more Bids are evaluated as equivalent in accordance with the evaluation methods and factors laid down in the Bidding Documents, and (ii) one or more of the Bids is from a domestic Bidder, as defined in ITB Sub-Clause 30.2, and (iii) the total price of the domestic Bid does not exceed by more than five percent (5%) the total price of the lowest priced foreign Bid evaluated as equivalent, then the Contract shall be awarded to the domestic Bid. |
| F. Award of Contract | |
| ITB 34.1 | The Performance Security shall be provided in any one of the following forms: (a) Demand guarantee in the form provided for in Section X, Security Forms, or (b) Banker’s certified cheque/cash warrant, or (c) Demand draft. |
| ITB 35.1 | The Advance Payment shall be limited to ten percent (10%) of the Contract Price. |
| ITB 36.1 | The Adjudicator proposed by the Employer is [“shall not” apply]. The hourly fee for this proposed Adjudicator shall be [None]. The biographical data of the proposed Adjudicator is as follows: The Appointing Authority is [<i>insert complete legal name and address</i>] If the Bidder objects to the Adjudicator proposed by the Employer in the Bidding Documents, it should so state in its Bid, and present an alternative candidate, together with the candidate’s daily fees and biographical data, in accordance with ITB Clause 36. [Replace this clause with the following if the above cannot be applied otherwise delete it]: Disputes arising from the implementation of the provisions of the Contract shall be settled first by negotiations between the Contractor and the Employer in order to arrive at an amicable settlement. If negotiations fail between the parties, the dispute shall be referred to the CDB and finally resolved by Arbitration in accordance with rules and procedures of CDB enforced at the time of submission through its National Arbitration Committee. Either party can take the case to the court in Bhutan if the Arbitration award is not acceptable to them. If the case is taken to the court, all the decisions made by the Arbitration committee will be null & void. |

Section III. Eligible Countries

Eligibility for the Provision of Goods, Works and Services in RGoB-financed Procurement

1. The RGoB permits firms and individuals from all countries to offer goods, works and services for RGoB-financed projects. As an exception, firms of a Country, goods manufactured in a Country or services provided from or by a Country may be excluded if:
 - 1.1 As a matter of law or official regulation, the RGoB prohibits commercial relations with that Country, or
 - 1.2 By an Act of Compliance with a Decision of the United Nations Security Council taken under Chapter VII of the Charter of the United Nations, the RGoB prohibits any import of goods from that Country or any payments to persons or entities in that Country.
2. For the information of Bidders, at the present time firms, goods and services from the following countries are excluded from this bidding:
 - (a) With reference to Paragraph 1.1 above:
[insert list of countries prohibited under the law or official regulations of Bhutan]
 - (b) With reference to Paragraph 1.2 above:
[insert list of countries which are barred under UN Security Council Chapter VII]

Section IV. Forms of Bid, Qualification Information, Letter of Acceptance, Contract and Integrity Pact

1. Contractor’s Bid

Notes on Form of Contractor’s Bid

The Bidder shall fill in and submit this Bid form with the Bid.

[date]:

Identification No. and Title of Contract: ***[Construction of Urban Roads in LAP-II]***

To: ***[Dasho Thrompon, Gelephu Thromde]***

Having examined the all the Bidding Documents (with reference ITB 8), including addenda, we offer to execute the ***[Construction of Urban Roads in LAP-II]*** in accordance with the Conditions of Contract accompanying this Bid for the Contract Price of ***[.....]***, ***[insert amount in words.....]*** ***[Ngultrum]***.

This Bid and your written acceptance of it shall constitute a binding Contract between us. We understand that you are not bound to accept the lowest or any Bid you receive.

We hereby confirm that this Bid complies with the Bid validity and Bid Security required by the Bidding Documents and specified in the Bidding Data Sheet.

We, including any subcontractors or suppliers for any part of the Contract, have nationalities from eligible countries in accordance with ITB Sub-Clause 3.1;

We have no conflict of interest in accordance with ITB Sub-Clause 3.2;

Our firm, its affiliates or subsidiaries—including any subcontractors or suppliers for any part of the Contract—has not been declared ineligible under the laws or official regulations of Bhutan, in accordance with ITB Sub-Clause 3.3.

Commissions or gratuities, if any, paid or to be paid by us to agents relating to this Bid, and to contract execution if we are awarded the contract, are listed below:

| Name and address of agent | Amount and Currency | Purpose of Commission or gratuity |
|---------------------------|---------------------|-----------------------------------|
| _____ | _____ | _____ |
| _____ | _____ | _____ |
| _____ | _____ | _____ |
| (if none, state “none”).” | | |

In case if I withdraw my bid after opening for whatsoever reasons, *I agree to the* forfeiture of the EMD/Bid Security and also I shall be bound to pay the cost difference (positive) between my bid with that of the next lowest evaluated bidder and failure on my part to do so within a month, will authorize the client to debar my firm for a period of 2 years.

Our duly executed Integrity Pact Statement is attached herewith as Appendix A.

Authorized Signature: _____

(Affix Legal Stamp)

Name and Title of Signatory: _____

Name of Bidder: _____

Address: _____

2. Qualification Information and Evaluation Table

Notes on Form of Qualification Information

The information to be filled in by Bidders in the following pages will be used for purposes of post qualification/ evaluation or for verification of prequalification as provided for in Clause 4 of the Instructions to Bidders. Attach additional pages as necessary. Pertinent sections of attached documents should be translated into the Language of the Bid, as specified in BDS ITB 11.1. If used for prequalification verification, the Bidder should fill in updated information only.]

1. CAPABILITY (70 MARKS): list all information requested below.

1.1 Similar work Experience

Value of single largest work of similar size and nature:

| Sl. No | Name of Work | Start & Completion Dates | Value of Work | Name of Employer |
|--------|--------------|--------------------------|---------------|------------------|
| | | | | |
| | | | | |

OR

Value of 3 works of similar size and nature:

| Sl. No | Name of Work | Start & Completion Dates | Value of Work | Name of Employer |
|-----------|--------------|--------------------------|---------------|------------------|
| 1. | | | | |
| 2. | | | | |
| 3. | | | | |

The bidder shall submit the following supporting documents for the above:

- Copies of completion certificate of the single largest work of similar size and nature executed in the last 5 calendar years.

OR

- Copies of completion certificates of no more than 3 works of similar size and nature executed in the last 5 calendar years (works whose completion date is within the last 5 calendar years including the current one).
- Partial completion will not be considered.

1.2 Access to adequate equipment (owned or hired):

| Equipment | Owned(No) | Hired (No) | Total (No) |
|-----------|------------|------------|------------|
| | | | |
| | | | |
| | | | |
| | | | |

The bidder shall submit the following supporting documents for the above:

- Copy of the registration certificate of each equipment committed where applicable.
- In case of hiring, copy of the lease agreement with the leaser.
- In case of ownership, copy of the insurance policy for each equipment where applicable.

1.3 Availability of skilled manpower:

| Personnel | Name of the comitted personnel | Number | Qualification | Number of years of experience |
|-----------|--------------------------------|--------|---------------|-------------------------------|
| | | | | |
| | | | | |
| | | | | |
| | | | | |

The bidder shall submit the following supporting documents for the above:

- Original signed copies of the CVs of technical manpower committed.
- Copies of Citizenship ID Cards or Passport/ Election ID cards (for foreign workers) of all manpower committed.
- Copies of contract agreements with all personnel if they have been hired on contract by the contractor.
- Copies of Provident Fund Account Documents of all personnel if they have been recruited on permanent pay rolls by the Contractor.

1.4 Average Performance Score from previous work

The bidder shall submit Performance score card issued by the Procuring Agencies for previous works.

2. CAPACITY (30 MARKS): list all information requested below.

2.1 Bid Capacity

$$BC = 2 * A * N - B$$

Where A= Average turnover of the contractor over the last 3 calendar years

N = Estimated duration of the project to be tendered

B= Portion of other ongoing works to be completed in the period that overlaps with the current project's duration (N)

| Name of the Project completed (in the last 3 calendar years) | Start & Completion Dates | Value of Contract | Name of Employer |
|--|--------------------------|-------------------|------------------|
| | | | |
| | | | |
| | | | |

| Name of the ongoing Project | Start & Completion Dates | Value of Contract | Name of Employer |
|-----------------------------|--------------------------|-------------------|------------------|
| | | | |
| | | | |
| | | | |

The bidder shall submit the following supporting documents for the above:

- Completion certificates for all works having their completion dates in the last 3 calendar years (including the current year)
- Award letter certificates for all works having their start dates in the last 3 calendar years (including the current year)

2.2 Access to or Availability of Credit Line

The bidder shall submit the following supporting documents for the above:

- The Bidder shall submit in the following format from the bank or financial institutions in Bhutan showing evidence of access to or availability of credit line for the project.

*[The **Bank/Bidder** shall fill in this Bank Certificate form in accordance with the instructions indicated in brackets.]*

(Bank Letter Head)

BANK CERTIFICATE

This is to certify that Mr./Mrs.....Promoter of M/s.....is one of our valued Clients and Maintaining account with..... Branch Office,.....their dealing with bank has been satisfactory as on date.

This certificate is issued at the request of M/s..... for the purpose of participating in bidding for tender works(*insert name of works*).The Client can be considered good for line of credit to the extent of Nu.....to meet their working capital requirements for executing the work namely subject to fulfillment of lending norms.

[insert signature(s) of authorized representative(s) of bank]
Address of the Bank

*[The **Bank/Bidder** shall fill in this Bank Certificate form in accordance with the instructions indicated in brackets.]*

❖ *For joint venture change the text as follows*

(Bank Letter Head)

BANK CERTIFICATE

This is to certify that Mr./Mrs.....
Promoter of M/s..... who has formed a
Joint Venture with M/s.....
for participating in this bid is one of our valued Clients and Maintaining account with
.....
.....Branch Office,..... their dealing with bank has been
satisfactory as on date.

This certificate is issued at the request of M/s.....
for the purpose of participating in bidding for tender works(*insert name of works*).The
Client can be considered good for line of credit to the extent of Nu.....
.....to meet their working capital requirements for executing the
work namely.....subject to fulfillment of
lending norms

[insert signature(s) of authorized representative(s) of bank]
Address of the Bank

[This should be given by each JV members]

3. PRICE PREFERENCE PARAMETERS: list all information requested below.

3.1 Status (Incorporated, JV, proprietorship)
Constitution or legal status of Bidder:

Place of registration:

Principal place of business:

Power of attorney of signatory of Bid:

The bidder shall submit the following supporting documents for the above:

- Copy of the certificate of incorporation issued by the registrar of companies for the bidder in case an incorporated company is bidding alone.
- Joint-venture agreement between the contractor involved, and copy of the certificate of incorporation issued by the registrar of companies for the incorporated partner in case two or more contractors are bidding together in a joint venture.
- Letter of Power of Attorney.

3.2 Employment of VTI Graduates

Total Number of workforce committed for the project:

Number of VTI graduates committed for the project:

The bidder shall submit a letter of commitment to employ VTI Graduates for the execution of the project.

3.3 Commitment for internships to VTI graduates

The bidder shall submit a letter of commitment for internship to VTI graduates.

Notes on Evaluation Table

The following information is provided for the Bidder's information on the scores that shall be awarded to the bidders based on the qualification information submitted by the Bidders.

1st Stage

| Sl.No | Parameters | Level of Achievement | Score |
|------------|--|--|--|
| 1 | BIDDER QUALIFICATION | | |
| 1.1 | CAPACITY | | |
| a) | Similar Work Experience(0-10) Aggregate size of similar contracts (max 3) in the last 5 calendar yrs <p style="text-align: center;">OR</p> Size of the largest similar contract executed in the last 5 calendar yrs | <ul style="list-style-type: none"> ▪ ≥ 175% of current project size ▪ 125 – 175% of current project size ▪ 75 – 125% of current project size ▪ < 75% of current project size <ul style="list-style-type: none"> ▪ ≥ 100% of current project size ▪ 70 – 100% of current project size ▪ 50 – 70% of current project size ▪ < 50% of current project size | <ul style="list-style-type: none"> ▪ 10 ▪ 8 ▪ 4 ▪ 0 <ul style="list-style-type: none"> ▪ 10 ▪ 8 ▪ 4 ▪ 0 |
| b) | Access to equipment (0-25) | Total score for equipments out of a score of 100 to be scaled down to 25 | |
| c) | Availability of skilled manpower (0-25) | Total score for skilled manpower out of a score of 100 to be scaled down to 25 | |

| Sl.No | Parameters | Level of Achievement | Score |
|------------|--|---|--|
| d) | Average performance score from previous work (past 5 calendar years) | <ul style="list-style-type: none"> ▪ 100% ▪ 1 mark lesser for every 5% point decrease in score rounded off to lower 5% ▪ < 50% | <ul style="list-style-type: none"> ▪ 10 ▪ 0 |
| 1.2 | CAPABILITY | | |
| a) | Bid Capacity (0-10) $*BC = 2 * A * N - B$ | <ul style="list-style-type: none"> ▪ Bid Capacity \geq quoted bid ▪ Bid Capacity is between 80 – 100% quoted bid ▪ Bid Capacity is between 60 – 80% quoted bid ▪ Bid Capacity is between 40 – 60% quoted bid ▪ Bid Capacity < 40% quoted bid | <ul style="list-style-type: none"> ▪ 10 ▪ 8 ▪ 6 ▪ 4 ▪ 0 |
| b) | Credit line available (0-20) | <ul style="list-style-type: none"> ▪ \geq 100% of estimated 3 month project cash flow ▪ 80 – 100% of estimated 3 month project cash flow ▪ 60 – 80% of estimated 3 month project cash flow ▪ <60% of estimated 3 month project cash flow | <ul style="list-style-type: none"> ▪ 20 ▪ 16 ▪ 8 ▪ 0 |
| | | END OF STAGE 1 out of a score of 100 | |

* Where A = Average turnover of the contractor over the last 3 calendar years
 N = Estimated duration of the project to be tendered

B = Portion of other ongoing works to be completed in the period that overlaps with the current project's duration (that is, N)

A bidder needs to obtain a score of at least 65 points out of 100 on these parameters in order to qualify for the next stage.

2nd Stage

| Sl.No | Parameters | Level of Achievement | Score |
|----------|---|--|---|
| 2 | BID EVALUATION | | |
| a) | Status (incorporated, JV, proprietorship) | <ul style="list-style-type: none"> ▪ Incorporated company bidding alone ▪ Incorporated company as the lead partner (>50% stake) in a bid by a joint venture ▪ Incorporated company as a non-lead partner (<50% stake) in a bid by a joint venture ▪ Any other (proprietorship, partnership etc.) | <ul style="list-style-type: none"> ▪ 40 ▪ 20 ▪ 10 ▪ 0 |
| b) | Employment of VTI Graduates/local skilled labourers | <ul style="list-style-type: none"> ▪ ≥ 50% project skilled workforce to be VTI ▪ 30 – 50% project skilled workforce to be VTI ▪ 15 – 30% project skilled workforce to be VTI ▪ ≤ 15% project skilled workforce to be VTI | <ul style="list-style-type: none"> ▪ 40 ▪ 30 ▪ 15 ▪ 0 |
| c) | Commitment for internships to VTI Graduates | <ul style="list-style-type: none"> ▪ Internship opportunities for VTI graduates equivalent to ≥ 10% of project workforce ▪ Internship opportunities for VTI graduates equivalent to 5-10% of project workforce ▪ Internship opportunities for VTI graduates ≤ 5% project skilled workforce | <ul style="list-style-type: none"> ▪ 20 ▪ 10 ▪ 0 |

The overall price preference – financial score is obtained by using the following formula for any qualified contractor (x):-

$$90 X \frac{\text{(Lowest quoted bid among qualifying bids)}}{\text{Financial bid quoted by } x} + 10\% \text{ of the Preference Score of } x$$

The contractor getting the highest overall price preference-financial score is awarded the work.

Letter of Acceptance

[Letterhead paper of the Employer]

Notes on Standard Form of Letter of Acceptance

The Letter of Acceptance shall be the basis for formation of the Contract as described in ITB Clauses 33 and 34 of the Instructions to Bidders. This Standard Form of Letter of Acceptance shall be filled in and sent to the successful Bidder only after evaluation of Bids has been completed.

[Insert date]

To: *[name and address of the Contractor]*

This is to notify you that your Bid dated *[insert date]* for execution of the *[insert name of the Contract and identification number, as given in the SCC]* for the Contract Price of the equivalent³⁴ of *[insert amount in numbers and words] [insert name of currency]*, as corrected and modified³⁵ in accordance with the Instructions to Bidders is hereby accepted by our Agency.

[Insert one of the following (x) or (y) options if applicable]

- (x) We accept that *[insert name proposed by Bidder]* be appointed as the Adjudicator.³⁶
- (y) We do not accept that *[insert name proposed by Bidder]* be appointed as Adjudicator, and by sending a copy of this Letter of Acceptance to *[insert name of the Appointing Authority]* we are hereby requesting *[insert name]*, the Appointing Authority, to appoint the Adjudicator in accordance with ITB Clause 36.1.³⁷

The Contract in duplicate is attached hereto. You are hereby instructed to:

- (a) confirm your acceptance of this Letter of Acceptance by signing and dating both copies of it, and returning one copy to us no later than 15 days from the date hereof;
- (b) proceed with the execution of the said Works in accordance with the Contract;
- (c) sign and date both copies of the attached Contract and return one copy to us within 15 days of the date hereof; and

³⁴ Delete "of the equivalent" if the Contract Price is expressed wholly in one currency.

³⁵ Delete "corrected and", or "and modified" or "as corrected and modified" as applicable. See Notes on Standard Form of Contract, next page.

³⁶ To be used only if the Contractor disagrees in the Bid with the Adjudicator proposed by the Employer in the Instructions to Bidders, and has accordingly offered another candidate who is acceptable to the Employer.

³⁷ To be used only if the Contractor disagrees in the Bid with the Adjudicator proposed by the Employer in the ITB, has accordingly offered another candidate, and the Employer does not accept the counterproposal.

(d) forward the Performance Security pursuant to ITB Sub-Clause 34.1, i.e., within 15 days after receipt of this Letter of Acceptance, and pursuant to GCC Sub-Clause 51.1

Authorized Signature: _____

Name and Title of Signatory: _____

Name of Agency: _____

Attachment: Contract

Contract

Notes on Standard Form of Contract

The Contract should incorporate any corrections or modifications to the Bid resulting from corrections of errors (ITB Clause 27), price adjustment during the evaluation process (ITB Sub-Clause 15.3), selection of an alternative offer (ITB Clause 17), acceptable deviations (ITB Clause 26), or any other mutually-agreeable changes allowed for in the Special Conditions of Contract, such as changes in key personnel, subcontractors, scheduling, and the like.

This Contract is made the *[insert day]* day of *[insert month]*, *[insert year]* between *[insert name and address of Employer]* (hereinafter called "the Employer") and *[insert name and address of Contractor]* (hereinafter called "the Contractor") of the other part.

Whereas the Employer is desirous that the Contractor execute *[name and identification number of Contract]* (hereinafter called "the Works") and the Employer has accepted the Bid by the Contractor for the execution and completion of such Works and the remedying of any defects therein.

Now this Contract witnesseth as follows:

1. In this Contract, words and expressions shall have the same meanings as are respectively assigned to them in the General Conditions of Contract hereinafter referred to, and they shall be deemed to form and be read and construed as part of this Contract.
2. In consideration of the payments to be made by the Employer to the Contractor as hereinafter mentioned, the Contractor hereby covenants with the Employer to execute and complete the Works and remedy any defects therein in conformity in all respects with the provisions of the Contract.
3. The Employer hereby covenants to pay the Contractor in consideration of the execution and completion of the Works and the remedying of defects therein, the Contract Price or such other sum as may become payable under the provisions of the Contract at the times and in the manner prescribed by the Contract.

In Witness whereof the parties thereto have caused this Contract to be executed the day and year first before written.

The Common Seal of *[Witness entity]* _____
was hereunto affixed in the presence of: _____

Signed, Sealed, and Delivered by the said _____
in the presence of: _____

Binding Signature of Employer *[Executive Secretary]*.

Binding Signature of Contractor.....

INTEGRITY PACT

1 General:

Whereas *Executive Secretary* representing the *Gelephu Thromde*, Royal Government of Bhutan, hereinafter referred to as the “**Employer**” on one part, andrepresenting M/s....., hereinafter referred to as the “**Bidder**” on the other part hereby execute this agreement as follows:

This agreement shall be a part of the standard bidding document, which shall be signed by both the parties at the time of purchase of bidding documents and submitted along with the tender document. This IP is applicable only to “**Medium**” scale works, goods and services, the threshold of which will be announced by the government from time to time. The signing of the IP shall not apply to framework contracting such as annual office supplies etc.

2 Objectives:

Whereas, the Employer and the Bidder agree to enter into this agreement, hereinafter referred to as IP, to avoid all forms of corruption or deceptive practice by following a system that is fair, transparent and free from any influence/unprejudiced dealings in the **bidding process**³⁸ and **contract administration**³⁹, with a view to:

- 2.1 Enabling the Employer to obtain the desired contract at a reasonable and competitive price in conformity to the defined specifications of the works or goods or services; and
- 2.2 Enabling bidders to abstain from bribing or any corrupt practice in order to secure the contract by providing assurance to them that their competitors will also refrain from bribing and other corrupt practices.

3. Scope:

The validity of this IP shall cover the bidding process and contract administration period.

4. Commitments of the Employer:

The Employer Commits itself to the following:-

³⁸ Bidding process, for the purpose of this IP, shall mean the procedures covering tendering process starting from bid preparation, bid submission, bid processing, and bid evaluation.

³⁹ Contract administration, for the purpose of this IP, shall mean contract award, contract implementation, un-authorized sub-contracting and contract handing/taking over.

- 4.1 The Employer hereby undertakes that no officials of the Employer, connected directly or indirectly with the contract, will demand, take a promise for or accept, directly or through intermediaries, any bribe, consideration, gift, reward, favor or any material or immaterial benefit or any other advantage from the Bidder, either for themselves or for any person, organization or third party related to the contract in exchange for an advantage in the bidding process and contract administration.
- 4.2 The Employer further confirms that its officials shall not favor any prospective bidder in any form that could afford an undue advantage to that particular bidder in the bidding process and contract administration and will treat all Bidders alike.
- 4.3 Officials of the Employer, who may have observed or noticed or have reasonable suspicion shall report to the head of the employing agency or an appropriate government office any violation or attempted violation of clauses 4.1 and 4.2.
- 4.4 Following report on violation of clauses 4.1 and 4.2 by official (s), through any source, necessary disciplinary proceedings, or any other action as deemed fit, including criminal proceedings shall be initiated by the Employer and such a person shall be debarred from further dealings related to the bidding process and contract administration.

5. Commitments of Bidders

The Bidder commits himself/herself to take all measures necessary to prevent corrupt practices, unfair means and illegal activities during any stage of the bidding process and contract administration in order to secure the contract or in furtherance to secure it and in particular commits himself/herself to the following :-

- 5.1 The Bidder shall not offer, directly or through intermediaries, any bribe, gift, consideration, reward, favor, any material or immaterial benefit or other advantage, commission, fees, brokerage or inducement to any official of the Employer, connected directly or indirectly with the bidding process and contract administration, or to any person, organization or third party related to the contract in exchange for any advantage in the bidding process and contract administration.
- 5.2 The Bidder shall not collude with other parties interested in the contract to manipulate in whatsoever form or manner, the bidding process and contract administration.
- 5.3 If the bidder(s) have observed or noticed or have reasonable suspicion that the provisions of the IP have been violated by the procuring agency or other bidders, the bidder shall report such violations to the head of the procuring agency.

6. Sanctions for Violation:

The breach of any of the aforesaid provisions shall result in administrative charges or penal actions as per the relevant rules and laws.

- 6.1 The breach of the IP or commission of any offence (forgery, providing false information, mis-representation, providing false/fake documents, bid rigging, bid steering or coercion) by the Bidder, or any one employed by him, or acting on his/her behalf (whether with or without the knowledge of the Bidder), shall be dealt with as per the terms and conditions of the contract and other provisions of the relevant laws, including De-barment Rules.
- 6.2 The breach of the IP or commission of any offence by the officials of the procuring agency shall be dealt with as per the rules and laws of the land in vogue.

7. Monitoring and Administration:

- 7.1 The respective procuring agency shall be responsible for administration and monitoring of the IP as per the relevant laws.
- 7.2 The bidder shall have the right to appeal as per the arbitration mechanism contained in the relevant rules.

We, hereby declare that we have read and understood the clauses of this agreement and shall abide by it.

The parties hereby sign this Integrity Pact at (place) _____ on (date) _____



Affix
Legal
Stamp

EMPLOYER

BIDDER/REPRESENTATIVE

CID :

CID :

Section V. General Conditions of Contract (GCC)

Notes on General Conditions of Contract

The General Conditions of Contract (GCC), read in conjunction with the Special Conditions of Contract and other documents listed therein, should be a complete document expressing fairly the rights and obligations of both parties.

The form of General Conditions of Contract that follows has been developed on the basis of considerable international experience in the drafting and management of contracts, bearing in mind a trend in the construction industry towards simpler, more straightforward language.

The form can be used directly for smaller ad measurement (unit prices or unit rates in a Bill of Quantities) contracts and, with the modifications noted in the footnotes, it can be adapted for lump sum contracts.

The use of standard General Conditions of Contract for building and civil works will promote comprehensiveness of coverage, general acceptability of its provisions, savings in cost and time in Bid preparation and review, and the development of a solid background of legal case histories.

Table of Clauses

A. General

| | | |
|-----|--|----|
| 1. | Definitions | 51 |
| 2. | Interpretation | 53 |
| 3. | Language and Law | 53 |
| 4. | Project Manager's Decisions | 53 |
| 5. | Delegation | 53 |
| 6. | Communications..... | 53 |
| 7. | Subcontracting..... | 54 |
| 8. | Setting Out | 54 |
| 9. | Other Contractors..... | 54 |
| 10. | Personnel..... | 54 |
| 11. | Employer's and Contractor's Risks | 55 |
| 12. | Employer's Risks | 55 |
| 13. | Contractor's Risks | 55 |
| 14. | Insurance | 56 |
| 15. | Queries about the Special Conditions of Contract..... | 56 |
| 16. | Contractor to Construct the Works | 56 |
| 17. | The Works to Be Completed by the Intended Completion Date..... | 56 |
| 18. | Approval by the Project Manager | 56 |
| 19. | Safety | 57 |
| 20. | Discoveries..... | 57 |
| 21. | Possession of the Site | 57 |
| 22. | Access to the Site..... | 57 |
| 23. | Instructions, Inspections and Audits..... | 57 |
| 24. | Disputes | 58 |
| 25. | Procedure for Disputes..... | 58 |
| 26. | Replacement of Adjudicator | 58 |
| B. | Time Control..... | 58 |
| 27. | Program | 58 |
| 28. | Extension of the Intended Completion Date | 59 |
| 29. | Acceleration..... | 59 |
| 30. | Delays Ordered by the Project Manager | 60 |
| 31. | Management Meetings | 60 |
| 32. | Early Warning | 60 |
| C. | Quality Control | 60 |
| 33. | Identifying Defects..... | 60 |
| 34. | Tests..... | 61 |
| 35. | Correction of Defects | 61 |
| 36. | Uncorrected Defects | 61 |
| D. | Cost Control | 61 |
| 37. | Bill of Quantities..... | 61 |
| 38. | Changes in the Quantities | 61 |
| 39. | Variations..... | 62 |
| 40. | Payments for Variations | 63 |
| 41. | Cash Flow Forecasts | 63 |

| | | |
|-----|---|----|
| 42. | Payment Certificates..... | 63 |
| 43. | Payments..... | 64 |
| 44. | Compensation Events for allowing time extension | 64 |
| 45. | Tax..... | 66 |
| 46. | Currencies | 66 |
| 47. | Price Adjustment | 66 |
| 48. | Retention | 67 |
| 49. | Liquidated Damages..... | 67 |
| 50. | Advance Payment..... | 67 |
| 51. | Securities..... | 68 |
| 52. | Dayworks..... | 69 |
| 53. | Cost of Repairs..... | 69 |
| E. | Completion of the Contract..... | 69 |
| 54. | Completion | 69 |
| 55. | Taking Over..... | 69 |
| 56. | Final Account | 69 |
| 57. | Operating and Maintenance Manuals..... | 69 |
| 58. | Termination | 70 |
| 59. | Corrupt or Fraudulent Practices | 70 |
| 60. | Payment upon Termination | 71 |
| 61. | Property | 72 |
| 62. | Release from Performance..... | 72 |

General Conditions of Contract

A. General

1. Definitions

1.1 Boldface type is used to identify defined terms.

(a) The **Adjudicator** is the person appointed jointly by the Employer and the Contractor to resolve disputes in the first instance, as provided for in GCC Clauses 25 and 26 hereunder.

(b) **Bill of Quantities** summary of the units and unit prices of the items proposed under the contract.

(c) **Compensation Events** are those defined in GCC Clause 44 hereunder.

(d) The **Completion Date** is the date of completion of the Works as certified by the Employer, in accordance with GCC Sub-Clause 55.1.

(e) The **Contract** is a formal agreement in writing entered into between the Employer and the Contractor to execute, complete, and maintain the Works. It consists of the documents listed in GCC Sub-Clause 2.3 below.

(f) The **Contractor** is an individual or legal entity entering into a contract after its Bid to carry out the Works has been accepted by the Employer.

(g) The **Contractor's Bid** is the completed Bidding document submitted by the Contractor to the Employer.

(h) The **Contract Price** is the price stated in the Letter of Acceptance and thereafter as adjusted in accordance with the provisions of the Contract.

(i) **Days** are calendar days; months are calendar months.

(j) **Day works** are varied work inputs subject to payment on a time basis for the Contractor's employees and Equipment, in addition to payments for associated Materials and Plant.

(k) A **Defect** is any part of the Works not completed in accordance with the Contract.

(l) The **Defects Liability Certificate** is the certificate issued by the Employer upon correction of defects by the Contractor.

(m) The **Defects Liability Period** is the period named in SCC Sub-Clause 35.1 and calculated from the Completion Date.

(n) **Drawings** include calculations and other information provided or approved by the Employer for the execution of the Contract.

(o) The **Employer** is the Government Agency which enters into a Contract with a Contractor to carry out the Works, as specified in the SCC. The terms "Procuring Agency", "Purchaser", or "Employer" is

synonymous.

(p) **Equipment** is the Contractor's machinery and vehicles brought temporarily to the Site to construct the Works.

(q) The **Initial Contract Price** is the Contract Price listed in the Employer's Letter of Acceptance.

(r) The **Intended Completion Date** is the date on which it is intended that the Contractor shall complete the Works. The Intended Completion Date is specified in the SCC. The Intended Completion Date may be revised only by the Employer by issuing an extension of time or an acceleration order.

(s) **In writing** is in any written form, including electronic mail.

(t) **Materials** are all supplies, including consumables, used by the Contractor for incorporation in the Works.

(u) **Plant** is any integral part of the Works that shall have a mechanical, electrical, chemical or biological function.

(v) The **Project Manager** is the person named in the SCC (or any other competent person appointed by the Employer and notified to the Contractor, to act in replacement of the Employer) who is responsible for supervising the execution of the Works and administering the Contract.

(w) **SCC** is the Special Conditions of Contract.

(x) **Secured Advance:** Secured advance can be given for non-perishable materials only. Materials such as cement/bamboo cannot be eligible for the secured advance. No secured advance shall be given on account of plants & machineries.

(y) The **Site** is the area defined as such in the SCC.

(z) **Site Investigation Reports** are those that were included in the Bidding Documents and are factual and interpretative reports about the surface and subsurface conditions at the Site.

(aa) **Specifications** mean the Specifications of the Works included in the Contract and any modification or addition made or approved by the Project Manager.

(bb) The **Start Date** is given in the SCC. It is the latest date when the Contractor shall commence execution of the Works. It does not necessarily coincide with any of the Site Possession Dates.

(cc) A **Subcontractor** is a person or corporate body who has a Contract with the Contractor to carry out a part of the work in the Contract, which includes work on the Site.

(dd) **Temporary Works** are works designed, constructed, installed and removed by the Contractor that are needed for construction or installation of the Works.

(ee) A **Variation** is an instruction given by the Project Manager which

varies the Works.

(ff) The **Works** are what the Contract requires the Contractor to construct, install and turn over to the Employer, as defined in the SCC.

- 2. Interpretation**
- 2.1 In interpreting these GCC, singular also means plural, male also means female or neuter, and the other way around. Headings have no significance. Words have their normal meaning under the language of the Contract unless specifically defined. The Project Manager shall provide instructions clarifying queries about these GCC.
- 2.2 If sectional completion is specified in the SCC, references in the GCC to the Works, the Completion Date and the Intended Completion Date apply to any Section of the Works (other than references to the Completion Date and Intended Completion Date for the whole of the Works).
- 2.3 The documents forming the Contract shall be interpreted in the following order of priority:
- (1) Contract,
 - (2) Letter of Acceptance,
 - (3) Contractor's Bid,
 - (4) Special Conditions of Contract,
 - (5) General Conditions of Contract,
 - (6) Specifications,
 - (7) Drawings,
 - (8) Bill of Quantities,⁴⁰ and
 - (9) any other document listed in the SCC as forming part of the Contract.
- 3. Language and Law**
- 3.1 The language of the Contract and the law governing the Contract are stated in the SCC.
- 4. Project Manager's Decisions**
- 4.1 Except where otherwise specifically stated, the Project Manager shall decide contractual matters between the Employer and the Contractor in the role representing the Employer..
- 5. Delegation**
- 5.1 The Project Manager may delegate any of his duties and responsibilities to other people, except to the Adjudicator, after notifying the Contractor, and may cancel any delegation after notifying the Contractor.
- 6. Communications**
- 6.1 Communications between parties that are referred to in the Conditions shall be effective only when in writing and delivered by hand (against receipt), sent by mail or courier, or transmitted using any of the agreed systems of electronic transmission. A notice shall be effective only when it is delivered.

⁴⁰ In lump sum contracts, delete "Bill of Quantities" and replace with "Activity Schedule".

- 7. Subcontracting** 7.1 The Contractor may subcontract with the approval of the Employer provided such provisions exist in contract document, but shall not assign the Contract without the approval of the Employer in writing. Subcontracting shall not alter the Contractor's obligations.
- 8. Setting Out** 8.1 The Contractor shall be responsible for setting out the Works and for ensuring the correctness of the positions, levels, dimensions and alignment of the Works. At any time during the execution of the Works, he shall correct any error at his own expense when required to do so by the Employer. Boreholes, exploratory excavations or soil testing may be done if instructed by the Employer. In case, cost of boreholes or exploratory excavations or soil testing is not included in the Contract Price, the cost shall be borne by the Employer. The contractor shall provide all facilities like labour and instruments, and shall co-operate with the Engineer-in-Charge to check all alignments, grades, levels and dimensions. Such checking shall not relieve the contractor of his own responsibility of maintaining the accuracy of the work.
- 9. Other Contractors** 9.1 The Contractor shall cooperate and share the Site with other contractors, public authorities, utilities and the Employer between the dates given in the Schedule of Other Contractors, as referred to in the SCC. The Contractor shall also provide facilities and services for them as described in the Schedule. The Employer may modify the Schedule of Other Contractors, and shall notify the Contractor of any such modification.
- 10. Personnel** 10.1 The Contractor shall employ the key personnel named in the Schedule of Key Personnel, as referred to in the SCC, to carry out the functions stated in the Schedule or other personnel approved by the Project Manager. The Project Manager shall approve any proposed replacement of key personnel only if their relevant qualifications and abilities are substantially equal to or better than those of the personnel listed in the Schedule. If the Contractor fails to deploy the personnel as committed in the Bid document, the employer shall stop the work if the quality of work is going to suffer or otherwise deduct the salaries of such personnel at a rate stipulated in the Special Condition of Contract per month per personnel for every month of absence of such personnel from the site. Such deductions shall continue till such time that the Contractor deploys the key personnel acceptable to the employer. If the Contractor fails to deploy such key personnel within one to four months⁴¹, the deductions shall be discontinued and the contractor's failure to deploy such personnel shall be treated as a fundamental breach of contract.

This shall also apply to the commitment of employment to Vocational Training Institute Graduates (VTI)/skilled local labourers and commitment to provide internship to VTI graduates. However in this case Contract may not be terminated but wage rates as mentioned in the SCC shall be deducted for the duration of the contract.

Similarly, if the committed equipments are not available at site, the hiring charges of such equipments shall be deducted at a rate

⁴¹ The duration should be based on the Contract duration.

stipulated in the SCC per month for every month of absence for a period of one to four months after which the deductions shall be discontinued and the contractor's failure to produce such equipments at site shall be treated as a fundamental breach of contract..

10.2 The Contractor shall pay rates of wages and observe conditions of labour which are not lower than the general level of wages and conditions in Bhutan. The Contractor shall provide and maintain all necessary accommodation and welfare facilities for the Contractor's personnel. The Contractor shall comply with all relevant labour laws applicable to the Contractor's personnel, including their employment, health, safety, welfare, immigration and emigration, and shall allow them all their legal rights. The Contractor is required, to the extent practicable and reasonable, to employ national staff and labour with appropriate qualifications and experience.

10.3 The Contractor shall not engage child labour and shall conform to the labour laws/acts, rules and regulations of Bhutan in the execution of Contract work. A child who has not attained the age of 18 years shall not be employed in any work as a labourer. During the continuance of the Contract the Contractor and his Subcontractors shall abide at all times with the labour laws/acts, rules and regulations, including child labour, related enactment and rules made there under.

11. Employer's and Contractor's Risks

11.1 The Employer carries the risks which this Contract states are Employer's risks, and the Contractor carries the risks which this Contract states are Contractor's risks.

12. Employer's Risks

12.1 From the Start Date until the Defects Liability Certificate has been issued, the following are Employer's risks:

(a) The risk of personal injury, death, or loss of or damage to property (excluding the Works, Plant, Materials and Equipment), which are due to:

(i) use or occupation of the Site by the Works or for the purpose of the Works, which is the unavoidable result of the Works or

(ii) negligence, breach of statutory duty, or interference with any legal right by the Employer or by any person employed by or contracted to him except the Contractor.

(b) The risk of damage to the Works, Plant, Materials and Equipment to the extent that it is due to a fault of the Employer or in the Employer's design, or due to war or radioactive contamination directly affecting Bhutan.

13. Contractor's Risks

13.1 From the Start Date until the Defects Liability Certificate has been issued, the risks of personal injury, death, and loss of or damage to property (including, without limitation, the Works, Plant, Materials and

Equipment) which are not Employer's risks are Contractor's risks.

- 14. Insurance**
- 14.1 The Contractor shall provide, in the joint names of the Employer and the Contractor, insurance cover from the Start Date to the end of the Defects Liability Period, in the amounts and deductibles stated in the SCC for the following events which are due to the Contractor's risks:
- (a) loss of or damage to the Works, Plant and Materials to be built into the works.
- 14.2 Policies and certificates for insurance shall be delivered by the Contractor to the Project Manager for the Project Manager's approval before the Start Date. All such insurance shall provide for compensation to be payable in the types and proportions of currencies required to rectify the loss or damage incurred.
- 14.3 If the Contractor does not provide any of the policies and certificates required, the Employer may effect the insurance which the Contractor should have provided and recover the premiums the Employer has paid from payments otherwise due to the Contractor or, if no payment is due, the payment of the premiums shall be a debt due from the Contractor to the Employer.
- 14.4 Alterations to the terms of insurance shall not be made without the approval of the Project Manager.
- 14.5 Both parties shall comply with any conditions of the insurance policies.
- 15. Queries about the Special Conditions of Contract**
- 15.1 The Project Manager shall clarify queries on the SCC.
- 16. Contractor to Construct the Works**
- 16.1 The Contractor shall construct and install the Works in accordance with the Specifications and Drawings.
- 17. The Works to Be Completed by the Intended Completion Date**
- 17.1 The Contractor may commence execution of the Works on the Start Date and shall carry out the Works in accordance with the Program submitted by the Contractor, as updated with the approval of the Project Manager, and complete them by the Intended Completion Date.
- 18. Approval by the Project Manager**
- 18.1 The Contractor shall submit Specifications and Drawings showing the proposed Temporary Works to the Project Manager, who is to approve them if they comply with the Specifications and Drawings.
- 18.2 The Contractor shall be responsible for design of Temporary Works.
- 18.3 The Project Manager's approval shall not alter the Contractor's responsibility for design of the Temporary Works.
- 18.4 The Contractor shall obtain approval of third parties to design the Temporary Works, where required.
- 18.5 All Drawings prepared by the Contractor for the execution of the temporary or permanent Works are subject to prior approval by the

Project Manager before use.

- 19. Safety**
- 19.1 The Contractor shall be responsible for the safety of all activities on the Site.
- 19.2 The Contractor shall assume full responsibility and comply with all applicable safety regulations for the adequacy and safety of site operations and methods of construction and he shall adopt measures to prevent injuries to persons or damage to properties or utilities. He shall hold the Employer harmless from any liability for loss or damage resulting from his failures to take the necessary precautions. He shall avoid undue interference with private business, public travel, or with the work of other contractors. He shall take steps to protect the environment and to minimize noise, pollution or other undesirable effects resulting from his method of operation.
- 20. Discoveries**
- 20.1 Anything of historical or other interest or of significant value unexpectedly discovered on the Site shall be the property of the Employer. The Contractor shall notify the Project Manager of such discoveries and carry out the Employer's instructions for dealing with them.
- 20.2 All materials obtained during excavation from the site and that have not been accounted for in the bid shall be the property of the Employer and the contractor shall take care of useful materials obtained during the execution of the Works and stack at place designated by the Employer. An arrangement shall be made between the Contractor and the Employer for the use and disposal of such materials according to the laws of the kingdom of Bhutan.
- 21. Possession of the Site**
- 21.1 The Employer shall give possession of all parts of the Site to the Contractor. If possession of a part is not given by the date stated in the SCC, the Employer shall be deemed to have delayed the start of the relevant activities, and this shall be a Compensation Event.
- 22. Access to the Site**
- 22.1 The Contractor shall allow the Project Manager and any person authorized by the Employer access to the Site and to any place where work in connection with the Contract is being carried out or is intended to be carried out.
- 23. Instructions, Inspections and Audits**
- 23.1 The Contractor shall carry out all instructions of the Project Manager which comply with the applicable laws where the Site is located.
- 23.2 The Contractor shall give notice to the Project Manager whenever any work is ready and before it is covered up, put out of sight, or packaged for storage or transport. The Project Manager shall then either carry out the examination, inspection, measurement or testing without unreasonable delay, or promptly give notice to the Contractor that he does not require to do so. If the Contractor fails to give the notice, he shall, if and when required by the Project Manager, uncover the work and thereafter reinstate and make good, all at the Contractor's cost.

- 23.3 The Contractor shall permit the Employer and/or persons appointed by the Employer to inspect the Site and/or the accounts and records of the Contractor and its Subcontractors relating to the performance of the Contract, and to have such accounts and records audited by auditors appointed by the Employer if so required by the Employer. The Contractor's attention is drawn to GCC Sub-Clause 59.1 [Corrupt or Fraudulent Practices] which provides, inter alia, that acts intended materially to impede the exercise of the Employer's inspection and audit rights provided for under GCC Sub-Clause 23.3 constitute a prohibited practice subject to contract termination (as well as to a determination of ineligibility pursuant to ITB Sub-Clause 2.1 (c) of the Instructions to Bidders within the Bidding Documents that preceded the placement of the Contract of which these GCC form a part).
- 24. Disputes**
- 24.1 If the Contractor believes that a decision taken by the Project Manager was either outside the authority given to the Project Manager by the Contract or that the decision was wrongly taken, the decision shall be referred to the Adjudicator or Arbitrator within 14 days of the notification of the Project Manager's decision.
- 25. Procedure for Disputes**
- 25.1 The Adjudicator shall give a decision in writing within 30 days of receipt of a notification of a dispute.
- 25.2 The Adjudicator shall be paid by the hour at the rate specified in the BDS and the SCC, together with reimbursable expenses of the types specified in the SCC, and the cost shall be divided equally between the Employer and the Contractor, whatever decision is reached by the Adjudicator. Either party may refer a decision of the Adjudicator to an Arbitrator within 30 days of the Adjudicator's written decision. If neither party refers the dispute to arbitration within the above 30 days, the Adjudicator's decision shall be final and binding.
- 25.3 The arbitration shall be conducted in accordance with the arbitration procedure published by the institution named and in the place specified in the SCC.
- 26. Replacement of Adjudicator**
- 26.1 Should the Adjudicator resign or die, or should the Employer and the Contractor agree that the Adjudicator is not functioning in accordance with the provisions of the Contract, a new Adjudicator shall be jointly appointed by the Employer and the Contractor. In case of disagreement between the Employer and the Contractor, within 30 days, the Adjudicator shall be designated by the Appointing Authority designated in the SCC at the request of either party, within 14 days of receipt of such request.

B. Time Control

- 27. Program**
- 27.1 Within the time stated in the SCC, after the date of the Letter of Acceptance, the Contractor shall submit to the Project Manager for approval a Program showing the general methods, arrangements, order and timing for all the activities in the Works.
- 27.2 An update of the Program shall be a program showing the actual progress achieved on each activity and the effect of the progress achieved on the timing of the remaining work, including any changes to

the sequence of the activities.

27.3 The Contractor shall submit to the Project Manager for approval an updated Program at intervals no longer than the period stated in the SCC. If the Contractor does not submit an updated Program within this period, the Project Manager may withhold the amount stated in the SCC from the next payment certificate and continue to withhold this amount until the next payment after the date on which the overdue Program has been submitted.

27.4 The Project Manager's approval of the Program shall not alter the Contractor's obligations. The Contractor may revise the Program and submit it to the Employer again at any time. A revised Program shall show the effect of Variations.

27.5 An on-time completion out of a total of thirty (30) % scoring shall be done by the Program Manager. The contractor shall be penalized under this component if he fails to deliver the project as per the initial time-lines committed in the Program.

The site engineer shall penalize the contractor to an extent of 30%. The quantum of penalty could vary as following:

- (i) 10% for a minor default
(if the final completion of the project is delayed by 10 - 15% as compared to original project duration)
- (ii) 20% for a medium default
(if the final completion of the project is delayed by 15 - 25% as compared to original project duration)
- (iii) 30% for a major default
(if the final completion of the project is delayed by 25% or more as compared to original project duration).

28. Extension of the Intended Completion Date

28.1 The Project Manager shall extend the Intended Completion Date if a Variation is issued which makes it impossible for Completion to be achieved by the Intended Completion Date without the Contractor taking steps to accelerate the remaining work, which would cause the Contractor to incur additional cost.

28.2 The Project Manager shall decide whether and by how much to extend the Intended Completion Date within 21 days of the Contractor asking the Project Manager for a decision upon the effect of Variation and submitting full supporting information. If the Contractor has failed to give early warning of a delay or has failed to cooperate in dealing with a delay, the delay by this failure shall not be considered in assessing the new Intended Completion Date.

29. Acceleration

29.1 When the Employer wants the Contractor to finish before the Intended Completion Date, the Project Manager shall obtain priced proposals for achieving the necessary acceleration from the Contractor. If the Employer accepts these proposals, the Intended Completion Date shall be adjusted accordingly and confirmed by both the Employer and the Contractor.

29.2 If the Contractor's priced proposals for acceleration are accepted by

the Employer, they are incorporated in the Contract Price and treated as a Variation.

- 30. Delays Ordered by the Project Manager**
- 30.1 The Project Manager may instruct the Contractor to delay the start or progress of any activity within the Works.
- 31. Management Meetings**
- 31.1 Either the Project Manager or the Contractor may require the other to attend a management meeting. The business of a management meeting shall be to review the plans for remaining work and to deal with matters raised in accordance with the early warning procedure.
- 31.2 The Project Manager shall record the business of management meetings and provide copies of the record to those attending the meeting. The responsibility of the parties for actions to be taken shall be decided by the Project Manager either at the management meeting or after the management meeting and stated in writing to all who attended the meeting.
- 32. Early Warning**
- 32.1 The Contractor shall warn the Project Manager at the earliest opportunity of specific likely future events or circumstances that may adversely affect the quality of the work increase the Contract Price or delay the execution of the Works. The Project Manager may require the Contractor to provide an estimate of the expected effect of the future event or circumstance on the Contract Price and Completion Date. The estimate shall be provided by the Contractor as soon as reasonably possible.
- 32.2 The Contractor shall cooperate with the Project Manager in making and considering proposals for how the effect of such an event or circumstance can be avoided or reduced by anyone involved in the work and in carrying out any resulting instruction of the Project Manager.
- 32.3 If the Contractor considers himself to be entitled to any extension of Time for Completion and/or any additional payment, under any Clause of these Conditions or otherwise in connection with the Contract, the Contractor shall give notice to the Project Manager, describing the event or circumstance giving rise to the claim. The notice shall be given as soon as practicable, and not later than 30 days after the Contractor became aware, or should have become aware, of the event or circumstance.
- 32.4 If the Contractor fails to give notice of a claim within such period of 30 days, the Employer shall be discharged from all liability in connection with the claim.

C. Quality Control

- 33. Identifying Defects**
- 33.1 The Project Manager shall check the Contractor's work and notify the Contractor of any Defects that are found. Such checking shall not affect the Contractor's responsibilities to ensure the quality of works executed. The Project Manager may instruct the Contractor to search for a Defect and to uncover and test any work that the Project Manager considers may have a Defect. The Project Manager at the end of the

Contract shall issue a Performance score on Quality out of a total of 70 points based on the guidelines issued by the Standard and Quality Control Authority (SQCA).

- 34. Tests** 34.1 If the Project Manager instructs the Contractor to carry out a test not specified in the Specifications to check whether any work has a Defect and the test shows that it does, the Contractor shall pay for the test and any samples. If there is no Defect, the test shall be a Compensation Event.
- 35. Correction of Defects** 35.1 The Project Manager shall give notice to the Contractor of any Defects before the end of the Defects Liability Period, which begins at Completion, and is defined in the SCC. The Defects Liability Period shall be extended for as long as Defects remain to be corrected.
- 35.2 Every time notice of a Defect is given, the Contractor shall correct the notified Defect within the length of time specified by the Project Manager's notice.
- 36. Uncorrected Defects** 36.1 If the Contractor has not corrected a Defect within the time specified in the Project Manager's notice, the Project Manager shall assess the cost of having the Defect corrected, and the Contractor shall pay this amount to the Employer. At the option of the Employer, payment of such costs may be made in whole or in part by the Employer deducting and keeping for itself appropriate amounts from the Retention Money and/or claiming against any bank guarantee provided by the Contractor pursuant to GCC Sub-Clause 48.3.

D. Cost Control

- 37. Bill of Quantities**⁴² 37.1 The Bill of Quantities shall contain items for the construction, installation, testing and commissioning work to be done by the Contractor.
- 37.2 The Bill of Quantities is used to calculate the Contract Price. The Contractor is paid for the quantity of the work done at the rate in the Bill of Quantities for each item.
- 38. Changes in the Quantities**⁴³ 38.1 If the final quantity of the work done differs from the quantity in the Bill of Quantities for the particular item by more than twenty percent (20%), provided the cost of variation beyond twenty percent (20%) limit exceeds one percent (1%) of the Initial Contract Value the Employer

⁴² In lump sum contracts, delete "Bill of Quantities" and replace with "Activity Schedule," and replace Sub-Clauses 37.1 and 37.2, as follows:

37.1 The Contractor shall provide updated Activity Schedules within 14 days of being instructed to do so by the Employer. The activities on the Activity Schedule shall be coordinated with the activities on the Program.

37.2 The Contractor shall show delivery of Materials to the Site separately on the Activity Schedule if payment for Materials on Site shall be made separately.

⁴³ In lump sum contracts, delete "Bill of Quantities" and replace with "Activity Schedule," and replace entire Clause 37 with new Sub-Clause 38.1, as follows:

38.1 The Activity Schedule shall be amended by the Contractor to accommodate changes of Program or method of working made at the Contractor's own discretion. Prices in the Activity Schedule shall not be altered when the Contractor makes such changes to the Activity Schedule.

shall adjust the quoted rate up or down to allow for the change. Only when both conditions are met then the quoted rate shall be changed.

- (a) If the quantity of work executed exceeds the quantity of the item in BOQ beyond the higher specified limit the Employer shall fix the market rate (which may be lower or higher than the quoted rate) to be applied for the additional quantity of the work executed.
- (b) If the quantity of work executed is less than the quantity of the item in BOQ lesser than the lower specified limit, the Employer shall fix the market rate based on the submission of the contractor (which may be lower/higher than the quoted rate) to be applied for whole of the quantity of the work so executed.

38.2 The rates shall not be adjusted from changes in quantities if thereby the Initial Contract Price is exceeded by more than five percent (5%), except with the prior approval of the Employer in consultation with the Tender Committee.

38.3 If requested by the Project Manager, the Contractor shall provide the Project Manager with a detailed cost breakdown of any rate in the Bill of Quantities.

39. Variations

39.1 The Project Manager shall order any variation of the form, quality or quantity of the Works or any part thereof that may, in his opinion, be necessary. Each variation may include, but is not limited to, any of the following:

- (a) increase or decrease in the quantity of any work included in the Contract,
- (b) omission or insertion of any item of work,
- (c) change in the character or quality or kind of any such work,
- (d) change in the levels, lines, position and dimensions of any part of the works,
- (e) additional work of any kind, or
- (f) change in any specified sequence or timing of construction activities.

39.2 The Project Manager shall make any such variation by issuing written instructions to the Contractor and ensure that such variations are duly noted in the Site Order Register. A variation made shall not, in any way, vitiate or invalidate the Contract, but the effect, if any, of all such variations shall be valued in accordance with GCC Clause 40.

39.3 The Contractor shall execute and be bound by each Variation, unless the Contractor promptly gives notice to the Project Manager stating (with supporting particulars) that (i) the Contractor cannot readily obtain the Goods required for the Variation, or (ii) such Variation triggers a substantial change in the sequence of the progress of the Works. Upon receiving this notice, the Project Manager shall cancel,

confirm or vary the instruction.

39.4 All Variations shall be included in updated Programs⁴⁴ produced by the Contractor.

40. Payments for Variations

40.1 The Contractor shall provide the Project Manager analysed rate for carrying out the Variation when requested to do so by the Project Manager. The Project Manager shall assess the analysed rates, which shall be given within seven days of the request or within any longer period stated by the Project Manager and before the Variation is ordered.

40.2 If the work in the Variation corresponds with an item description in the Bill of Quantities and if, in the opinion of Project Manager, the quantity of work above the limit stated in GCC Sub-Clause 38.1 or the timing of its execution do not cause the cost per unit of quantity to change, the rate in the Bill of Quantities shall be used to calculate the value of the Variation. If the cost per unit of quantity changes, or if the nature or timing of the work in the Variation does not correspond with items in the Bill of Quantities, the quotation by the Contractor shall be in the form of new rates for the relevant items of work.⁴⁵

40.3 If the Contractor's quotation is unreasonable, the Project Manager may order the Variation and make a change to the Contract Price, which shall be based on the Project Manager's own forecast of the effects of the Variation on the Contractor's costs.

40.4 If the Project Manager decides that the urgency of varying the work would prevent a quotation being given and considered without delaying the work, no quotation shall be given and the Variation shall be treated as a Compensation Event.

40.5 The Contractor shall not be entitled to additional payment for costs that could have been avoided by giving early warning.

41. Cash Flow Forecasts

41.1 When the Program⁴⁶ is updated, the Contractor shall provide the Project Manager with an updated cash flow forecast. The cash flow forecast shall include different currencies, as defined in the Contract, converted as necessary using the Contract exchange rates.

42. Payment Certificates

42.1 The Contractor shall submit to the Project Manager monthly statements of the value of the work executed, based on the Contractor's records, less the cumulative amount certified previously.

42.2 The Project Manager shall check the Contractor's monthly statement and certify the amount to be paid to the Contractor.

42.3 The value of work executed shall be determined by the Project Manager.

⁴⁴ In lump sum contracts, add "and Activity Schedules" after "Programs".

⁴⁵ In lump sum contracts, delete this paragraph.

⁴⁶ In lump sum contracts, add "or Activity Schedule" after "Program".

42.4 The value of work executed shall comprise the value of the quantities of the items in the Bill of Quantities completed⁴⁷ and measurement thereof shall be carried out jointly by the Project Manager, or his Representative, and the Contractor. The Project Manager, or his Representative, shall record the value of the work executed in a measurement book for the purposes of verifying the Contractor's monthly statements. The measurement book shall be signed by the Project Manager or his Representative, and countersigned by the Contractor.

42.5 The value of work executed shall include the valuation of Variations and Compensation Events.

42.6 The Project Manager may exclude any item certified in a previous certificate or reduce the proportion of any item previously certified in any certificate in the light of later information.

43. Payments

43.1 Payments shall be adjusted for deductions for advance payments, taxes, retention money and any other dues.. The Employer shall pay the Contractor within 30 working days from the date of receipt of correct and verified bills/invoices in complete form by the Finance Section.

43.2 If the Employer makes a late payment, the Contractor shall be paid interest on the late payment in the next payment. Interest shall be calculated from the date by which the payment should have been made up to the date when the late payment is made at the rate of ten percent (10 %) per annum.

43.3 If an amount certified is increased in a later certificate or as a result of an award by the Adjudicator or an Arbitrator, the Contractor shall not be paid interest upon the delayed payment as set out in this clause.

43.4 Unless otherwise stated, all payments and deductions shall be paid or charged in the proportions of currencies comprising the Contract Price.

43.5 Items of the Works for which no rate or price has been entered in shall not be paid for by the Employer and shall be deemed covered by other rates and prices in the Contract.

44. Compensation Events for allowing time extension

44.1 The following shall be Compensation Events allowing for time extension:

- (a) The Employer does not give access to a part of the Site by the Site Possession Date pursuant to GCC Sub-Clause 21.1.
- (b) The Employer modifies the Schedule of Other Contractors in a way that affects the work of the Contractor under the Contract.
- (c) The Project Manager orders a delay or does not issue Drawings, Specifications or instructions required for execution of the Works on time.
- (d) The Project Manager instructs the Contractor to uncover or to

⁴⁷ In lump sum contracts, replace this paragraph with the following: "The value of work executed shall comprise the value of completed activities in the Activity Schedule."

carry out additional tests upon work, which is then found to have no Defects.

- (e) The Project Manager unreasonably does not approve a subcontract to be let if provided in SCC.
- (f) The Project Manager gives an instruction for dealing with an unforeseen condition, caused by the Employer, or additional work required for safety or other reasons.
- (g) Other contractors, public authorities, utilities or the Employer do not work within the dates and other constraints stated in the Contract, and they cause delay.
- (h) Other Compensation Events described in the SCC or determined by the Employer and force majeure. "Force Majeure" means an exceptional event or circumstance:
 - (i) which is beyond a Party's control,
 - (ii) which such Party could not reasonably have provided against before entering into the Contract,
 - (iii) which, having arisen, such Party could not reasonably have avoided or overcome, and
 - (iv) which is not substantially attributable to the other Party.

Force Majeure may include, but is not limited to, exceptional events or circumstances of the kind listed below, so long as conditions (i) to (iv) above are satisfied:

- (i) war, hostilities (whether war be declared or not), invasion, act of foreign enemies,
- (ii) rebellion, terrorism, sabotage by persons other than the Contractor's Personnel, revolution, insurrection, military or usurped power, or civil war,
- (iii) riot, commotion, disorder, strike or lockout by persons other than the Contractor's Personnel,
- (iv) munitions of war, explosive materials, ionizing radiation or contamination by radio-activity, except as may be attributable to the Contractor's use of such munitions, explosives, radiation or radio-activity, and
- (v) natural catastrophes such as earthquake, hurricane, typhoon or volcanic activity.

However, force majeure shall not include the following;

- i. rainfall
- ii. snowfall
- iii. strikes in other countries
- iv. non-availability of labourer and materials such as timbers, boulders, sand, and other materials
- v. difficulty and risky terrain and remoteness of site

44.2 If a Compensation Event would prevent the work being completed before the Intended Completion Date, the Intended Completion Date shall be extended. The Project Manager shall decide whether and by

how much the Intended Completion Date shall be extended.

44.3 The Contractor shall not be entitled to compensation to the extent that the Employer's interests are adversely affected by the Contractor not having given early warning.

45. Tax

45.1 The prices bid by the contractor shall include all duties, taxes and levies that may be levied in accordance with the laws and regulations in being as of the date 30 days prior to the closing date for submission of bids.

46. Currencies

46.1 Where payments are made in currencies other than Ngultrum (NU), the exchange rates used for calculating the amounts to be paid shall be the exchange rates stated in the Contractor's Bid.

47. Price Adjustment

47.1 If during the contract, there is an increase or decrease in the cost of materials as reflected by the Material Index Numbers published by the National Statistical Bureau⁴⁸(NSB), a corresponding increase or decrease in the payment to the contractor or recoverable from the Contractor shall be effected on the basis of the following formulae, such calculation being done for every successive period of 3 months after the 12th month of the Contract duration:

Adjustment for variation of material prices:

$$V = W \times 0.80 \times 0.75 \times (M - M_0) / M_0$$

where:

V = amount of variation for materials payable to/recoverable from the contractor for the period under review;

W = value of the work done during the period under review minus (amount of secured advance recovered in the same period + value of works executed under variations for which the variations are paid in the new rate);

M₀ = Material Index for the month in which the tender was submitted;

M = the average value of the above Index Number for the 3 months period under review;

47.2 For the applications of the above formulae, the appropriate Index Numbers published by the National Statistical Bureau shall be adopted.

47.3 To the extent that full compensation for any rise or fall in costs to the contractor is not covered by the provisions of this or other clauses in the contract, the unit rates and prices included in the contract shall be deemed to include amounts to cover the contingency of such other rise or fall in costs.

47.4 Price Adjustment shall apply only for work carried out within the

⁴⁸ Until NSB comes up with the Material Index for the Royal Government of Bhutan, the Wholesale Price- Index (all commodities) for Materials shall be used for the purpose of this clause. Visit www.eaindustry.nic.in for the Wholesale Price Index.

stipulated time or extensions granted by the Procuring Agency and shall not apply to work carried out beyond the stipulated time for reasons attributable to the Contractor.

48. Retention

- 48.1 The Employer shall retain⁴⁹ ten percent (10%) from each payment due to the Contractor the proportion stated in the SCC until Completion of the whole of the Works as retention money.
- 48.2 On completion of the whole of the works, half the total amount retained shall be repaid to the Contractor and half when defects liability period has passed and the Engineer has certified that all defects notified by the Engineer to the Contractor before the end of this period have been corrected.
- 48.3 On completion of the whole of the works, the contractor may substitute the balance half of retention money by an unconditional bank guarantee. In the case of contracts beyond duration of 12 months, substitution of retention money by such a bank guarantee may be allowed on completion of 50% of the value of contract and duly certified by the Project Manager. The bank guarantee shall be valid until the issue of No Defects Liability Certificates by the Project Manager that all defects notified by the Project Manager to the Contractor have been rectified to his satisfaction before the end of this period. If the Contractor fails to remedy any reported defect within the Defect Liability Period, the Employer shall withhold the payment or realize claims from the bank guarantee of an amount which in the opinion of the Employer represents the cost of the defect to be remedied.

49. Liquidated Damages

- 49.1 The Contractor shall pay liquidated damages to the Employer at the rate per day stated in the SCC for each day that the Completion Date is later than the Intended Completion Date. The total amount of liquidated damages shall not exceed the ten percent (10%) of the Initial Contract Price. The Employer may deduct liquidated damages from payments due to the Contractor. Payment of liquidated damages shall not affect the Contractor's liabilities.

50. Advance Payment

- 50.1 The Employer shall make advance payment to the Contractor of the amount stated in the SCC (mobilization and secured advances) by the date stated in the SCC, against provision by the Contractor of an Unconditional Bank Guarantee in a form and by a bank acceptable to the Employer in amounts and currencies equal to the advance payment. The Guarantee shall remain effective until the advance payment has been repaid, but the amount of the Guarantee shall be progressively reduced by the amounts repaid by the Contractor. Interest shall not be charged on the advance payment.
- 50.2 The secured advances shall be paid to the contractor as specified in SCC on the following conditions:
- a. The materials shall be in accordance with the specifications and shall not be in excess of the requirements;
 - b. The materials shall be delivered at the site of the works, properly stored and protected against loss, damage or deterioration;
 - c. A declaration shall be given by the contractor passing on the lien on

⁴⁹ The retention amount is usually ten percent (10%).

the rights of the materials to the Procuring Agency.

- d. The amount of the secured advance shall not be more than seventy five percent (75%) of the cost of materials delivered at the site of works which shall be supported by the original invoices/bills from the suppliers. All materials imported from other countries shall be supported by Bhutan Sales Tax Receipts or Customs Clearance. In case of fabrication works off site, secured advance may be paid to the Contractor after site inspection is carried out by the Procuring Agency at the cost of the contractor, submission of proof of payment (work order) and submission of supply order.

The secured advance shall be recovered from the interim progress payments in the months in which these materials are used in the works.

- 50.3 The Contractor is to use the advance payment only to pay for, Plant, Materials and mobilization expenses required specifically for execution of the Contract.
- 50.4 The advance payment shall be repaid by deducting proportionate amounts from payments otherwise due to the Contractor, following the schedule of completed percentages of the Works on a payment basis. All advances shall be recovered when eighty percent (80%) of the contract is executed. No account shall be taken of the advance payment or its repayment in assessing valuations of work done, Variations, price adjustments, Compensation Events, Bonuses or Liquidated Damages.

51. Securities

- 51.1 The Performance Security shall be provided to the Employer no later than the date specified in the Letter of Acceptance and shall be issued in an amount specified in the SCC by a bank or surety acceptable to the Employer, and denominated in the types and proportions of the currencies in which the Contract Price is payable. The Performance Security shall be valid until a date 30 days from the date of issue of the Certificate of Completion.
- 51.2 Following the successful completion of the Contract, the Employer shall return the Performance Security to the Contractor within 14 days of receipt of the Certificate of Completion.
- 51.3 The Employer shall not make a claim under the Performance Security, except for amounts to which the Employer is entitled under the Contract in the event of:
- (a) failure by the Contractor to extend the validity of the Performance Security as described in the preceding paragraph, in which event the Employer may claim the full amount of the Performance Security.
 - (b) failure by the Contractor to pay the Employer an amount due, as either agreed by the Contractor or determined under Clause 43 [payments] or Clause 62 [payment upon Termination], within 42 days after this agreement or determination,
 - (c) circumstances which entitle the Employer to terminate the contract under Clause 58 [Termination], irrespective of whether notice of termination has been given.

- 52. Dayworks**
- 52.1 If applicable, the Dayworks rates in the Contractor's Bid shall be used for small additional amounts of work only when the Project Manager has given written instructions in advance for additional work to be paid for in that way.
- 52.2 All work to be paid for as Dayworks shall be recorded by the Contractor on forms approved by the Project Manager. Each completed form shall be verified and signed by the Project Manager within 2 days of the work being done.
- 52.3 The Contractor shall be paid for Dayworks subject to obtaining signed Dayworks forms and at the rate quoted for Dayworks.
- 53. Cost of Repairs**
- 53.1 Loss or damage to the Works or Materials to be incorporated in the Works between the Start Date and the end of the Defects Correction periods shall be remedied by the Contractor at the Contractor's cost if the loss or damage arises from the Contractor's acts or omissions.

E. Completion of the Contract

- 54. Completion**
- 54.1 The Contractor shall request the Project Manager to issue a Certificate of Completion of the Works, and the Project Manager shall do so upon deciding that the work is completed.
- 55. Taking Over**
- 55.1 The Employer shall take over the Site and the Works and shall issue the completion Certificate within 7 days of taking over. The completion certificate shall include the following mandatory information:
- i. Name of Contract firm
 - ii. Name of Proprietor
 - iii. CDB Registration No.
 - iv. Trade License No.
 - v. Contract Amount
 - vi. Year of Completion
 - vii. Award order No. with Date.
- 56. Final Account**
- 56.1 The Contractor shall supply the Project Manager with a detailed account of the total amount that the Contractor considers payable under the Contract before the end of the Defects Liability Period. The Project Manager shall issue a Defects Liability Certificate and certify any final payment that is due to the Contractor within 30 days of receiving the Contractor's account if it is correct and complete. If it is not, the Project Manager shall issue within 30 days a schedule that states the scope of the corrections or additions that are necessary. If the Final Account is still unsatisfactory after it has been resubmitted, the Project Manager shall decide on the amount payable to the Contractor and issue a payment certificate.
- 57. Operating and Maintenance Manuals**
- 57.1 If "as built" Drawings and/or operating and maintenance manuals are required, the Contractor shall supply them by the dates stated in the SCC.
- 57.2 If the Contractor does not supply the Drawings and/or manuals by the dates stated in the SCC, or they do not receive the Project Manager's approval, the Project Manager shall withhold the amount stated in the SCC from payments due to the Contractor.

58. Termination

- 58.1 The Employer or the Contractor may terminate the Contract if the other party causes a fundamental breach of the Contract.
- 58.2 Fundamental breaches of Contract shall include, but shall not be limited to, the following:
- (a) the Contractor stops work for 30 days when no stoppage of work is shown on the current Program and the stoppage has not been authorized by the Project Manager;
 - (b) the Project Manager instructs the Contractor to delay the progress of the Works, and the instruction is not withdrawn within 30 days;
 - (c) the Employer or the Contractor is made bankrupt or goes into liquidation other than for a reconstruction or amalgamation;
 - (d) The Contractor fails to employ the personnel proposed in the Bid document pursuant to Qualification Information Paragraph 1.5,
 - (e) a payment certified by the Project Manager is not paid by the Employer to the Contractor within 84 days of the date of the Project Manager's certificate;
 - (f) the Project Manager gives notice that failure to correct a particular Defect is a fundamental breach of Contract and the Contractor fails to correct it within a reasonable period of time determined by the Project Manager;
 - (g) the Contractor does not maintain a security, which is required;
 - (h) the Contractor subcontracts any or whole of the Works without the approval of the Employer;
 - (i) the Contractor has delayed the completion of the Works by the number of days for which the maximum amount of liquidated damages can be paid, as defined in the SCC; and
 - (k) in case of joint venture any or all parties fail to fulfill the contractual obligations.
- 58.3 When either party to the Contract gives notice of a breach of Contract to the Project Manager for a cause other than those listed under GCC Sub-Clause 58.2 above, the Project Manager shall decide whether the breach is fundamental or not.
- 58.4 Notwithstanding the above, the Employer may terminate the Contract for convenience.
- 58.5 If the Contract is terminated, the Contractor shall stop work immediately, make the Site safe and secure, and leave the Site as soon as reasonably possible.

59. Corrupt or Fraudulent Practices

- 59.1 If the Employer determines that the Contractor has engaged in corrupt, fraudulent, collusive, coercive or obstructive practices in competing for or in executing the Contract then the Employer may, after giving 14 days notice to the Contractor, terminate the Contractor's employment under the Contract and expel him from the Site, and the provisions of GCC Sub-Clause 59.5 shall apply.

59.2 Should any employee of the Contractor be determined to have engaged in corrupt, fraudulent, collusive, coercive or obstructive practice during the execution of the Works, then that employee shall be removed in accordance with GCC Sub-Clause 10.2

59.3 For the purposes of this Sub-Clause:

- (a) “corrupt practice”⁵⁰ is the offering, giving, receiving or soliciting, directly or indirectly, of anything of value⁵¹ to influence improperly the actions of another party;
- (b) “fraudulent practice”⁵² is any act or omission, including a misrepresentation, that knowingly or recklessly misleads, or attempts to mislead, a party to obtain a financial or other benefit or to avoid an obligation;
- (c) “collusive practice”⁵³ is an arrangement between two or more parties designed to achieve an improper purpose, including to influence improperly the actions of another party;
- (d) “coercive practice”⁵⁴ is impairing or harming, or threatening to impair or harm, directly or indirectly, any party or the property of the party to influence improperly the actions of a party;
- (e) “obstructive practice” is
 - (i) deliberately destroying, falsifying, altering or concealing of evidence material to the investigation or making false statements to investigators in order materially to impede any investigation into allegations of a corrupt, fraudulent, coercive or collusive practice; and/or threatening, harassing or intimidating any party to prevent it from disclosing its knowledge of matters relevant to the investigation or from pursuing the investigation; or
 - (ii) acts intended materially to impede the exercise of the inspection and audit rights of the Employer and/or any other relevant RGoB agency provided for under GCC Clause 23.

60. Payment upon Termination 60.1 If the Contract is terminated because of a fundamental breach of Contract by the Contractor, the Project Manager shall issue a

⁵⁰ “another party” refers to a public official acting in relation to the procurement process or contract execution. In this context, “public official” includes staff and employees of other organizations (including any institutions providing finance for the Works) taking or reviewing procurement decisions.

⁵¹ “anything of value” includes, but is not limited to, any gift, loan, fee, commission, valuable security or other asset or interest in an asset; any office, employment or contract; any payment, discharge or liquidation of any loan, obligation or other liability whatsoever, whether in whole or in part; any other services, favour or advantage, including protection from any penalty or disability incurred or apprehended or from any action or proceeding of a disciplinary or penal nature, whether or not already instituted and including the exercise or the forbearance from the exercise of any right or any official power or duty.

⁵² a “party” refers to a public official; the terms “benefit” and “obligation” relate to the procurement process or contract execution; and the “act or omission” is intended to influence the procurement process or contract execution.

⁵³ “parties” refers to participants in the procurement process (including public officials) and an “improper purpose” includes attempting to establish bid prices at artificial, non competitive levels.

⁵⁴ a “party” refers to a participant in the procurement process or contract execution.

certificate for the value of the work done and Materials ordered less advance payments received up to the date of the issue of the certificate and less the percentage to apply to the value of work not completed, as indicated in the SCC. Additional Liquidated Damages shall not apply. If the total amount due to the Employer exceeds any payment due to the Contractor, the difference shall be a debt payable by the Contractor to the Employer.

60.2 If the Contract is terminated for the Employer's convenience or because of a fundamental breach of Contract by the Employer, the Project Manager shall issue a certificate for the value of the work done, Materials ordered, the reasonable cost of removal of Equipment, repatriation of the Contractor's personnel employed solely on the Works, and the Contractor's costs of protecting and securing the Works, and less advance payments received up to the date of the certificate.

61. Property

61.1 All materials on the Site, Plant, Equipment, Temporary Works and Works are deemed to be the property of the Employer if the contract is terminated because of a Contractors default.

62. Release from Performance

62.1 If the Contract is frustrated by the outbreak of war or by any other event entirely outside the control of either the Employer or the Contractor, the Project Manager shall certify that the Contract has been frustrated. The Contractor shall make the Site safe and stop work as quickly as possible after receiving this certificate and shall be paid for all work carried out before receiving it and for any work carried out afterwards to which a commitment was made.

Section VI. Special Conditions of Contract

Except where otherwise indicated, all SCC should be filled in by the Employer prior to issuance of the Bidding Documents. Schedules and reports to be provided by the Employer should be annexed.

| A. General | |
|---------------------|--|
| GCC 1.1 (o) | The Employer is Gelephu Thomde |
| GCC 1.1 (r) | The Intended Completion Date for the whole of the Works shall be [30th May, 2015] |
| GCC 1.1 (v) | The Project Manager is [Chief Engineer, ESD, Gelephu Thomde] . |
| GCC 1.1 (y) | The Site is located at [Tashiling Demkhong] and is defined in Drawings Nos. [attached] |
| GCC 1.1 (bb) | The Start Date shall be [1st November, 2014] . |
| GCC 1.1 (ff) | The Works consist of [Bajri filling works, drains construction, Hume pipe laying and Construction of culverts] . |
| GCC 2.2 | Sectional Completions are: [None] |
| GCC 2.3 (9) | The following documents also form part of the Contract: <i>[list documents; e.g. (delete or add to as appropriate)]</i> <i>Schedule of Other Contractors (GCC 9)</i> <i>Schedule of Key Personnel (GCC 10)</i> <i>Site Investigation Reports (GCC 11)</i> <i>Schedule of Operating and Maintenance Manuals (GCC 57)</i> |
| GCC 3.1 | The language of the contract is [English] . The law that applies to the Contract is the law of the Kingdom of Bhutan. |
| GCC 9.1 | Schedule of other contractors: [None] |
| GCC 10.1 | Key Personnel: [Project Manager, Engineer and site supervisor] The amount to be deducted for the key personnel not employed by the contractor for each personnel is Nu.15,000.00 per month. The amount to be deducted for the equipments not available at site is Nu.20,000.00 per month. The amount to be deducted for the VTI/local skilled laborers not employed by the |

| | |
|-----------------|---|
| | <p>contractor for each personnel is Nu. <i>[nil]</i></p> <p>The amount to be deducted for the VTI graduates not employed by the contractor as interns for the contract for each personnel is Nu. 10,000.00 per month</p> |
| GCC 14.1 | <p>The minimum insurance amounts and deductibles shall be:</p> <p>(a) loss of or damage to the Works, Plant and Materials to be built into the works: <i>[N/A]</i>.</p> |
| GCC 15.1 | Queries[if any] |
| GCC 21.1 | The Site Possession Date(s) shall be: <i>[10 days after award letter]</i> |
| GCC 25.2 | Fees and types of reimbursable expenses to be paid to the Adjudicator: <i>[Not applicable]</i> . |
| GCC 25.3 | <p><i>[For smaller contracts, the institution is usually from Bhutan. For contracts that are awarded to international contractors it is recommended that the arbitration procedure of an international institution be used]</i></p> <p>Institution whose arbitration procedures shall be used:</p> <p>For Contracts with Bhutanese Contractors</p> <p>Construction Development Board (CDB) or other Independent Agency:</p> <p>GCC Sub-Clause 24.3—All disputes arising in connection with the present Contract shall be for finally resolved by arbitration in accordance with the rules and procedures of the CDB or any other independent agency that has been appropriately mandated at the time of submission of the dispute through its National Arbitration Committee. The arbitration award shall be final on the parties who shall be deemed to have accepted to carry out the resulting award without delay and to have waived their right to any form of appeal insofar as such waiver can validly be made.</p> <p>For Contracts with International Contractors</p> <p><i>[one institution from among those listed below; insert the corresponding wording]</i></p> <p>“United Nations Commission on International Trade Law (UNCITRAL) Arbitration Rules:</p> <p>GCC Sub-Clause 25.3—Any dispute, controversy or claim arising out of or relating to this Contract, or breach, termination or invalidity thereof, shall be settled by arbitration in accordance with the UNCITRAL Arbitration Rules as at present in force.”</p> <p>or</p> <p>“Rules of Conciliation and Arbitration of the International Chamber of</p> |

| | |
|------------------------|---|
| | <p>Commerce (ICC):</p> <p>GCC Sub-Clause 25.3—All disputes arising in connection with the present Contract shall be finally settled under the Rules of Conciliation and Arbitration of the International Chamber of Commerce by one or more arbitrators appointed in accordance with the said Rules.”</p> <p>or</p> <p>“Rules of the Arbitration Institute of the Stockholm Chamber of Commerce:</p> <p>GCC Sub-Clause 25.3—Any dispute, controversy or claim arising out of or in connection with this Contract, or the breach, termination or invalidity thereof, shall be settled by arbitration in accordance with the Rules of the Arbitration Institute of the Stockholm Chamber of Commerce.”</p> <p>or</p> <p>“Rules of the London Court of International Arbitration:</p> <p>GCC Sub-Clause 25.3—Any dispute arising out of or in connection with this Contract, including any question regarding its existence, validity or termination shall be referred to and finally resolved by arbitration under the Rules of the London Court of International Arbitration, which rules are deemed to be incorporated by reference to this clause.”</p> <p>The place of arbitration shall be: <i>[Insert city and country]</i></p> |
| GCC 26.1 | Appointing Authority for the Adjudicator: <i>[insert name of Authority]</i> . |
| B. Time Control | |
| GCC 27.1 | <p>The Contractor shall submit for approval a Program for the Works within <i>[10]</i> days from the date of the Letter of Acceptance.</p> <p>The Program shall include, but not be limited to, the following elements under the conditions stipulated:</p> <p>(a) Quality Assurance Plan (QAP)</p> <p>The Quality Assurance Plan shall specify the work methodology, quality control tests and intervals for such tests in accordance with the work specifications for each item of the Works. If in the opinion of the Project Manager the QAP submitted by the Contractor does not fully represent the spirit of the General Conditions of Contract or the Specifications he may seek further clarification from the Contractor before his approval. The Contractor shall strictly follow the QAP in the execution of the Works. If the Contractor does not comply with the QAP, he shall not be allowed to proceed further with the Works. Details of all procedures and compliance documents shall be submitted to the Project Manager for information before each execution stage is commenced. Compliance with the quality assurance system shall not relieve the Contractor of any of his duties, obligations or responsibilities under the contract.</p> |
| GCC 27.3 | <p>The period between Program updates is <i>[15]</i> days.</p> <p>The amount to be withheld for late submission of an updated Program is</p> |

| | |
|----------------------------------|---|
| | Nu.10000.00. |
| C. Quality Control | |
| GCC 35.1 | The Defects Liability Period is: <i>[365]</i> days. |
| D. Cost Control | |
| GCC 44.1 (I) | Other Compensation Events are: <i>[N/A]</i> |
| GCC 45.1 | In case of certain Tax exemptions, such as in foreign assistance projects, this specific exemption(s) should be clearly specified in this clause. |
| GCC 47.1 | The Contract <i>is not</i> subject to price adjustment in accordance with GCC Clause 47. <i>[Price Adjustment is applicable only for Contracts of duration more than 18 months]</i> |
| GCC 48.1 | The proportion of payments retained is: <i>[10%]</i> |
| GCC 49.1 | The liquidated damages for the whole of the Works are <i>[0.10%]</i> per day. The maximum amount of liquidated damages for the whole of the Works is <i>[10%.]</i> of the final Contract Price. |
| GCC 50.1 | The Mobilization Advance Payment shall be ten percent (10%) of the Contract Price and shall be paid to the Contractor no later than 30 days after receipt by the Employer of an acceptable Advance Payment Guarantee. |
| GCC 50.2 | The secured advance is <i>[75%]</i> |
| GCC 51.1 | The Performance Security amount <i>shall be ten percent (10%) of the Contract Price, denominated in the types and proportions of the currencies in which the Contract Price is payable, or in a freely convertible currency acceptable to the Employer.</i> |
| E. Finishing the Contract | |
| GCC 57.1 | The date by which operating and maintenance manuals are required is <i>[N/A]</i> . |
| GCC 57.2 | The amount to be withheld for failing to produce “as built” drawings and/or operating and maintenance manuals by the date required in GCC Sub-Clause 57.1, or failing to obtain the Project Manager’s approval of them by the said date, is <i>[N/A]</i> . |
| GCC 58.2 (i) | The maximum number of days is: <i>[100]</i> . |
| GCC 60.1 | The percentage to apply to the value of the work not completed, representing the Employer’s additional cost for completing the Works, is <i>[20% of the initial contract price]</i> |

Section VII Specifications and Performance Requirements

Notes on Specifications and Performance Requirements

A set of precise and clear Specifications is a prerequisite for Bidders to respond realistically and competitively to the requirements of the Employer without qualifying or conditioning their Bids. In the context of international competitive bidding, the Specifications must be drafted to permit the widest possible competition and, at the same time, present a clear statement of the required standards of workmanship, materials and performance of the Works to be procured. Only if this is done will the objectives of economy, efficiency and fairness in procurement be realized, responsiveness of Bids be ensured, and the subsequent task of Bid evaluation facilitated. The Specifications should require that all goods and materials to be incorporated in the Works be new, unused, of the most recent or current models, and incorporate all recent improvements in design and materials unless provided otherwise in the Contract.

Samples of Specifications from previous similar projects are useful in this respect. Most specifications are normally written specially by the Employer or Project Manager to suit the Contract Works in hand. There is no standard set of Specifications for universal application in all sectors but there are established principles and practices, which are reflected in these documents.

There are considerable advantages in standardizing General Specifications for repetitive Works in recognized public sectors such as highways, ports, railways, urban housing, irrigation and water supply, especially in the same region where similar conditions prevail. The General Specifications should cover all classes of workmanship, materials and equipment commonly involved in construction, although not necessarily to be used in a particular Works Contract. Deletions or addenda should then adapt the General Specifications to the particular Works.

Care must be taken in drafting Specifications to ensure that they are not restrictive. In the specification of standards for goods, materials and workmanship recognized international standards should be used as much as possible. Where other particular standards are used, whether national standards or other standards, the Specifications should state that goods, materials and workmanship that meet other authoritative standards, and which ensure substantially equal or higher quality than the standards mentioned, will also be acceptable. To this effect, the following clause may be inserted in the Special Conditions or Specifications.

“Equivalency of Standards and Codes

Wherever reference is made in the Contract to specific standards and codes to be met by the goods and materials to be furnished, and work performed or tested, the provisions of the latest current edition or revision of the relevant standards and codes in effect shall apply, unless otherwise expressly stated in the Contract. Where such standards and codes are national or regional, other authoritative standards that ensure a substantially equal or higher quality than the standards and codes specified will be accepted subject to the Project Manager’s prior review and written consent. Differences between the standards specified and the proposed alternative standards shall be fully described in writing by the Contractor and submitted to the Project Manager at least 30 days prior to the date when the Contractor desires the Project Manager’s consent. In the event the Project Manager determines that such proposed deviations do not ensure substantially equal or higher quality, the Contractor shall comply with the standards specified in the documents.”

These Notes for Preparing Specifications are intended only as information for the Employer or the person drafting the Bidding Documents. They should not be included in the final documents.

Section VIII. Drawings

Notes on Drawings

Insert here a list of Drawings. The actual Drawings, including site plans, should be attached to this section or annexed in a separate folder.

Slab

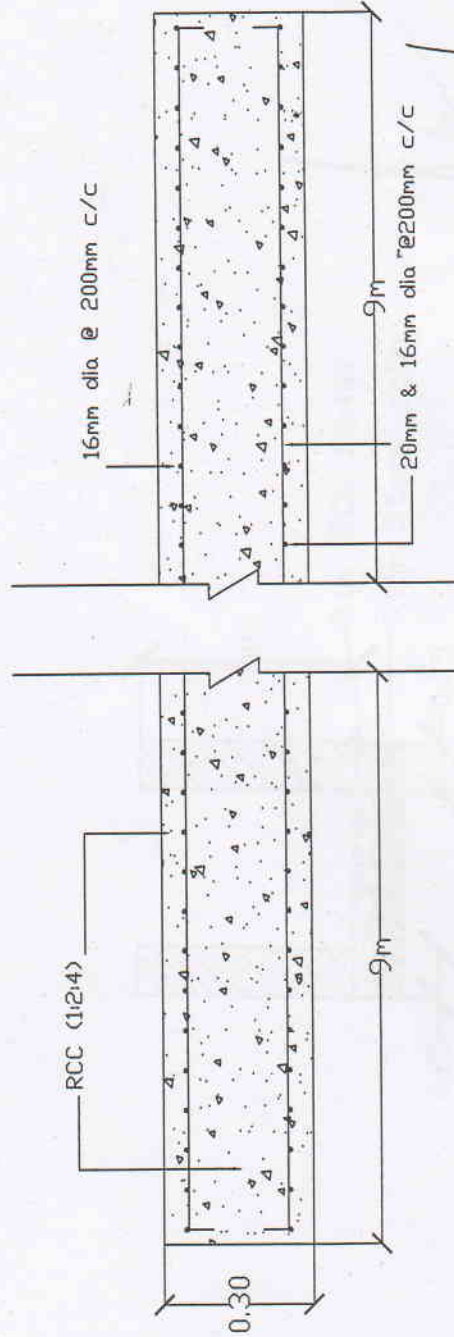
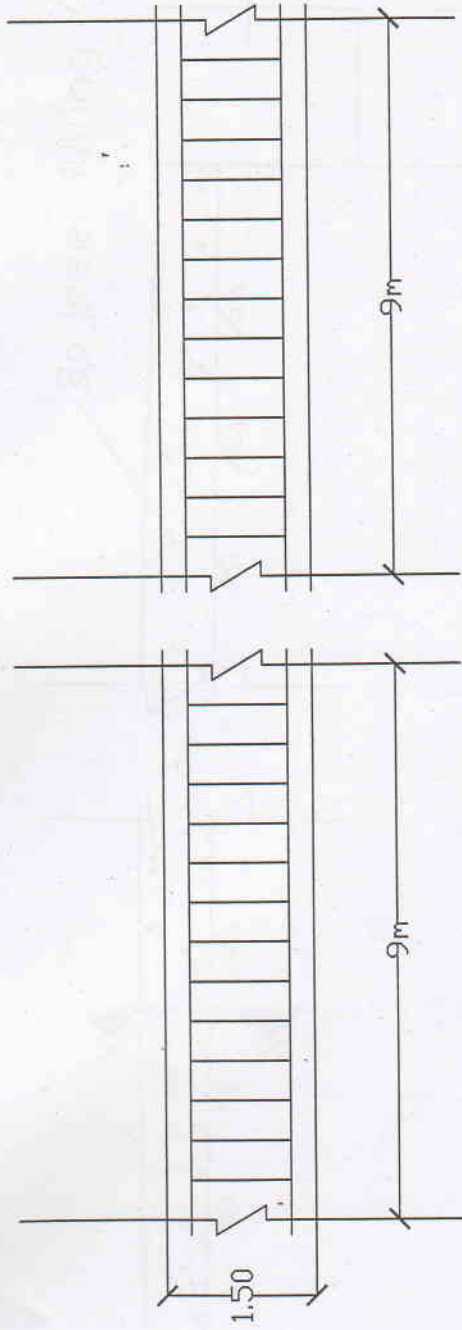

Handwritten signature

Handwritten signature

Cross section of Road (Bajri)

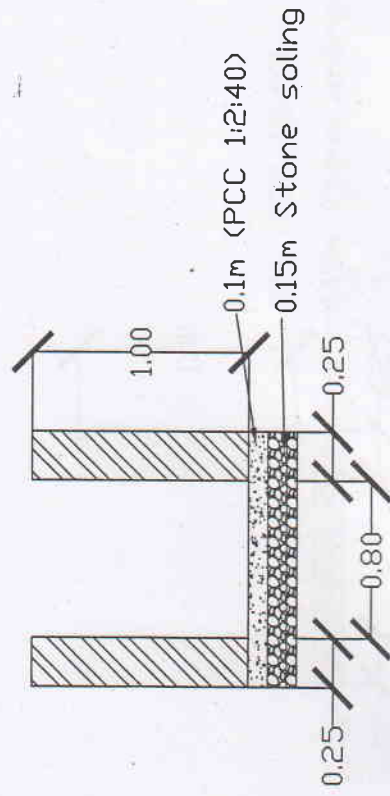
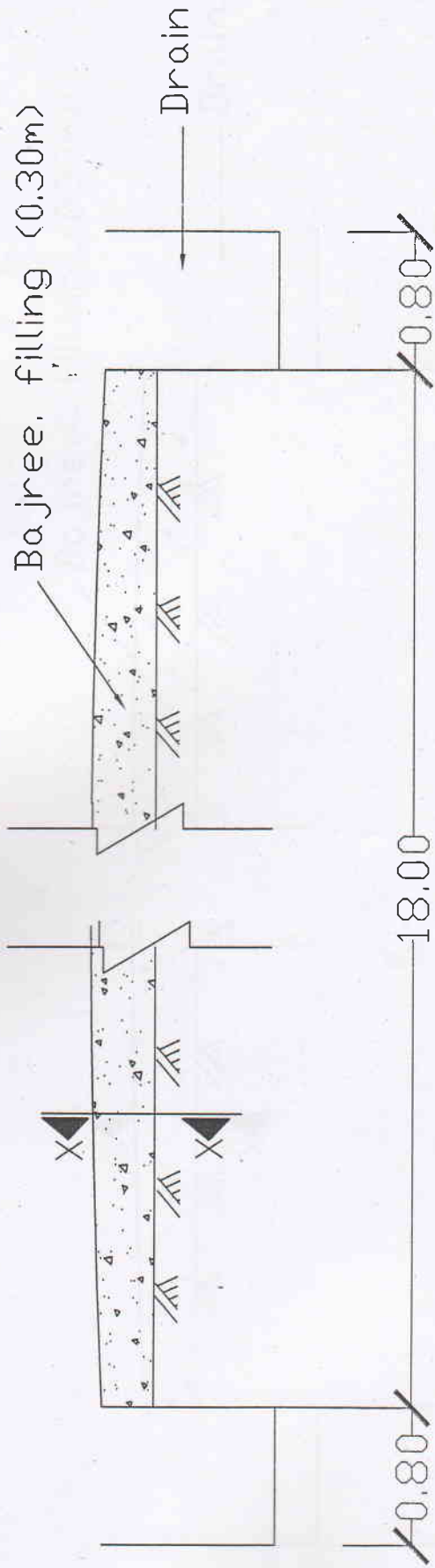

Section X-X

[Handwritten signature]

Cross section of Road (Bajri)

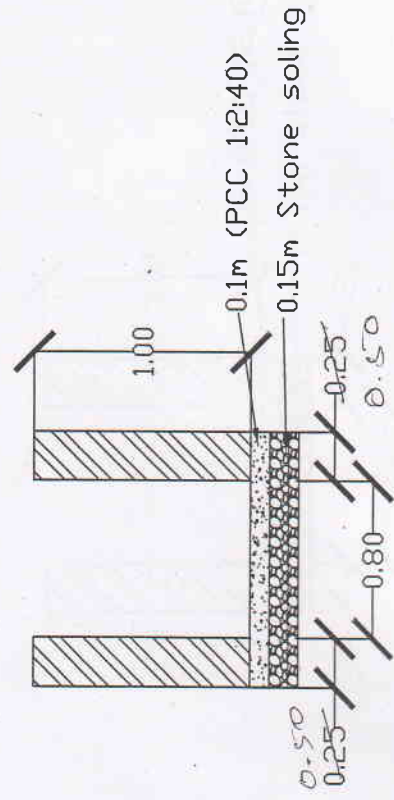
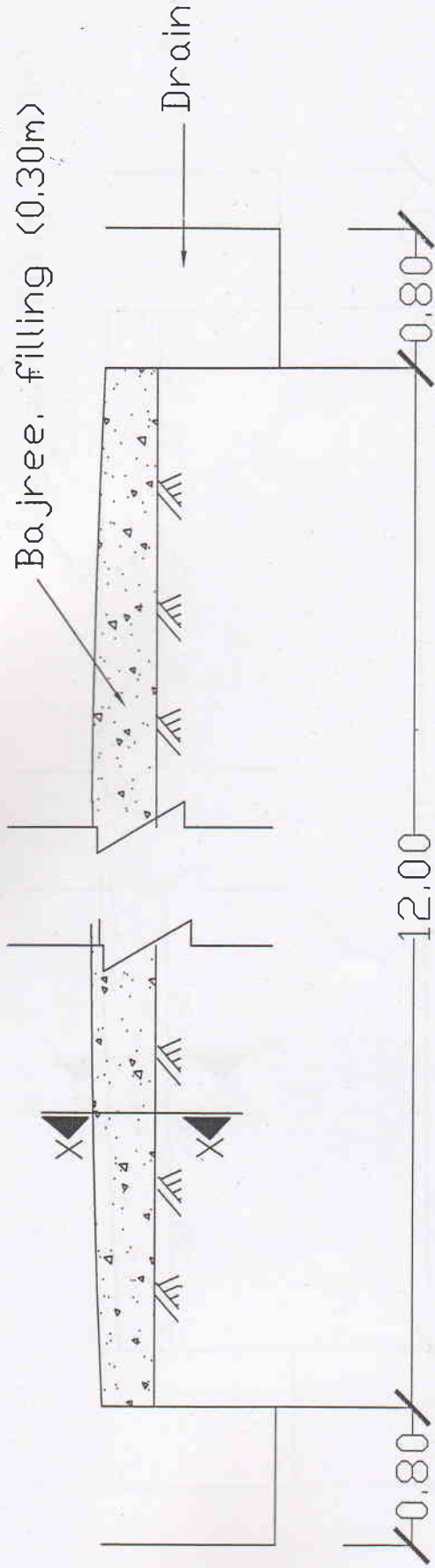

Section X-X

Cross section of Road (Bajri)

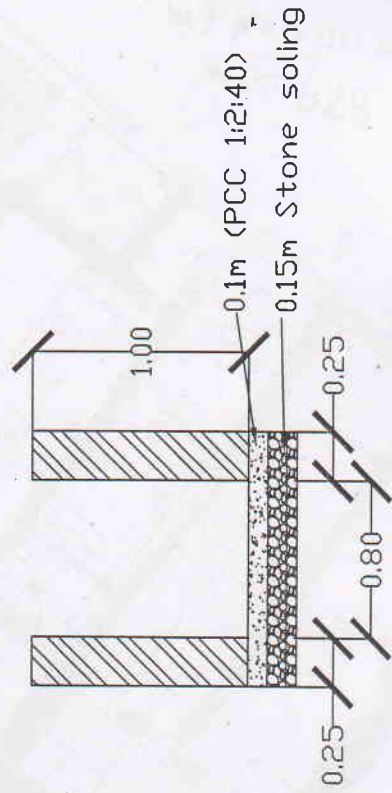
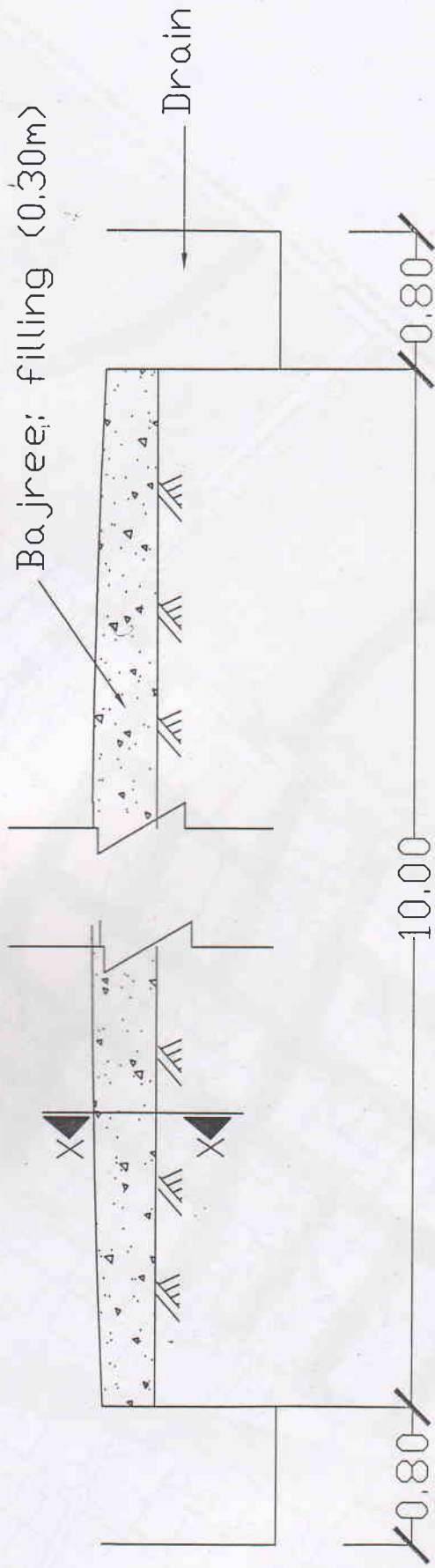

Section X-X

[Handwritten signature]

AREA I (LAP-II)

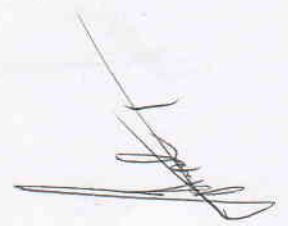

L = 879.00m
W = 10 and 6m.
Forest Area

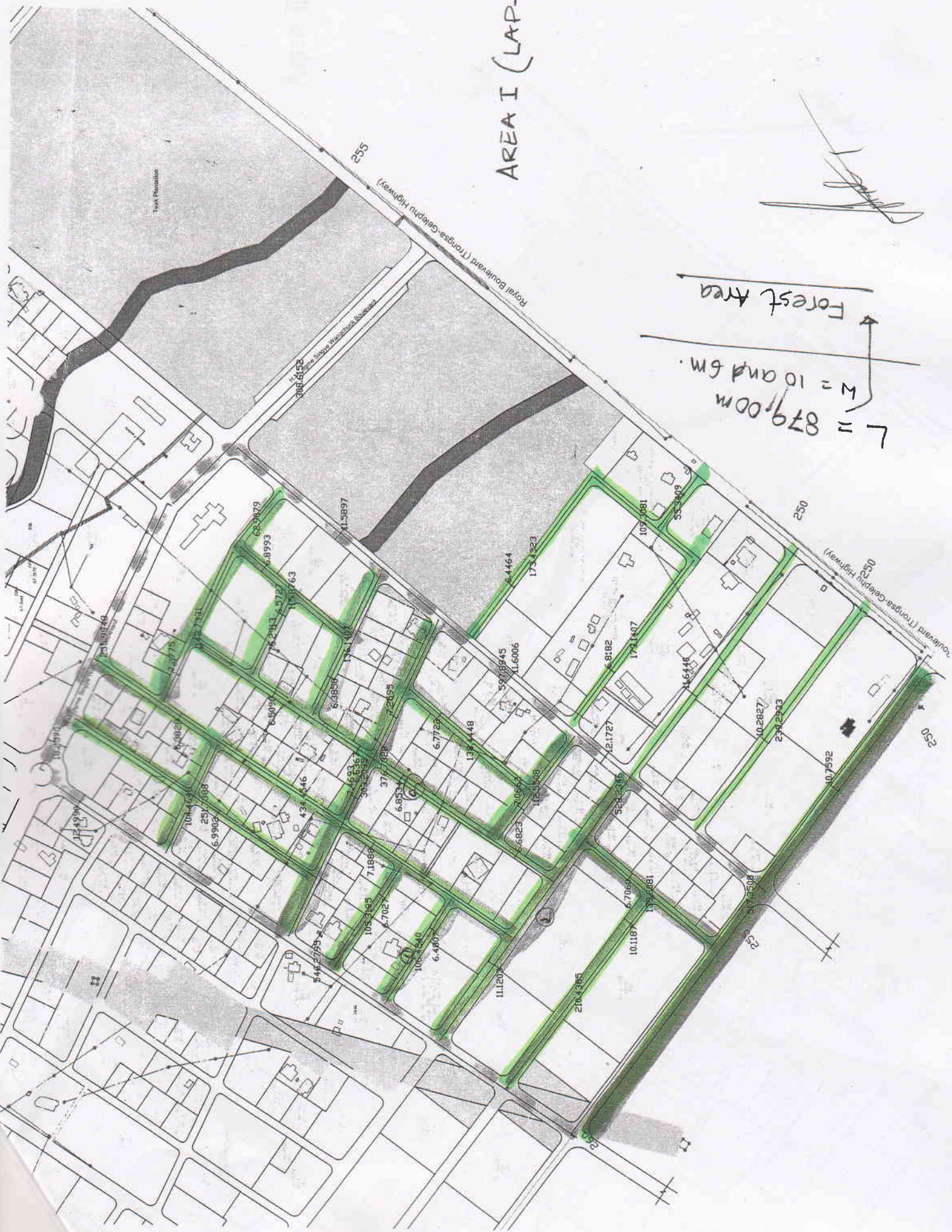

AREA II (LAP II)

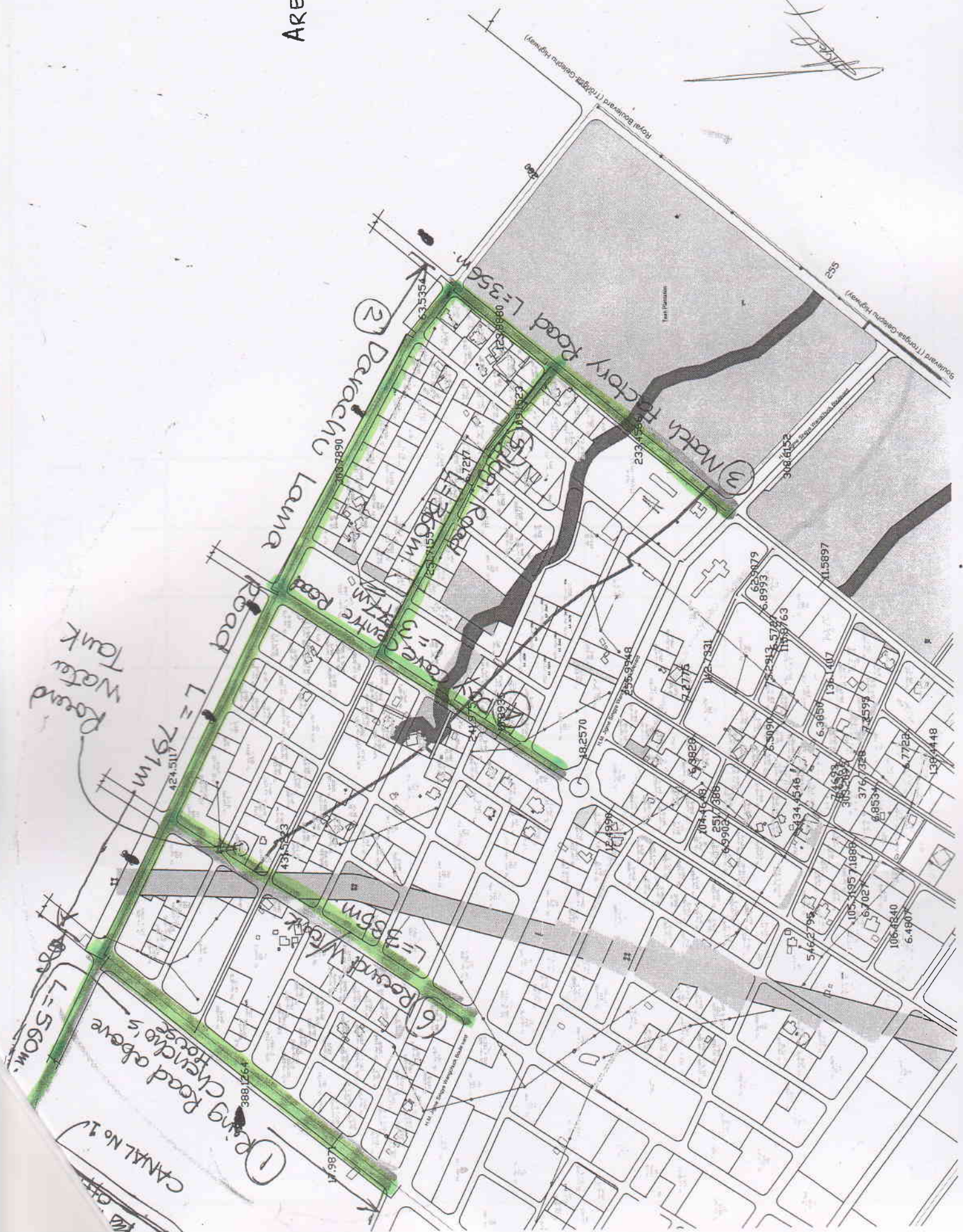

ROAD 1

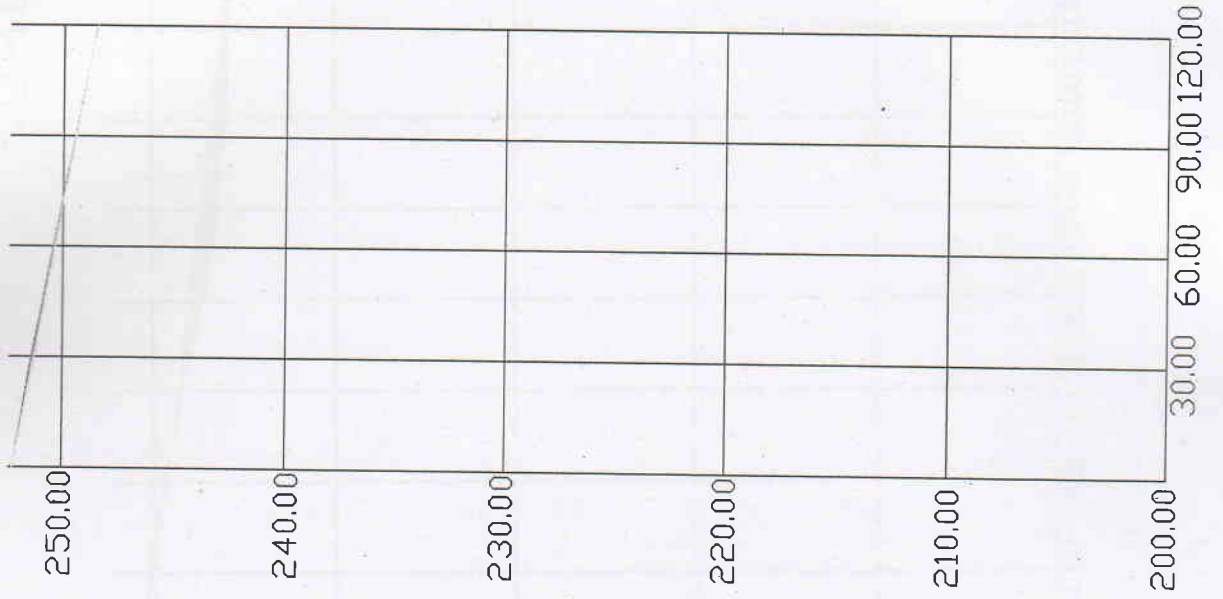

[Handwritten signature]

ROAD 2

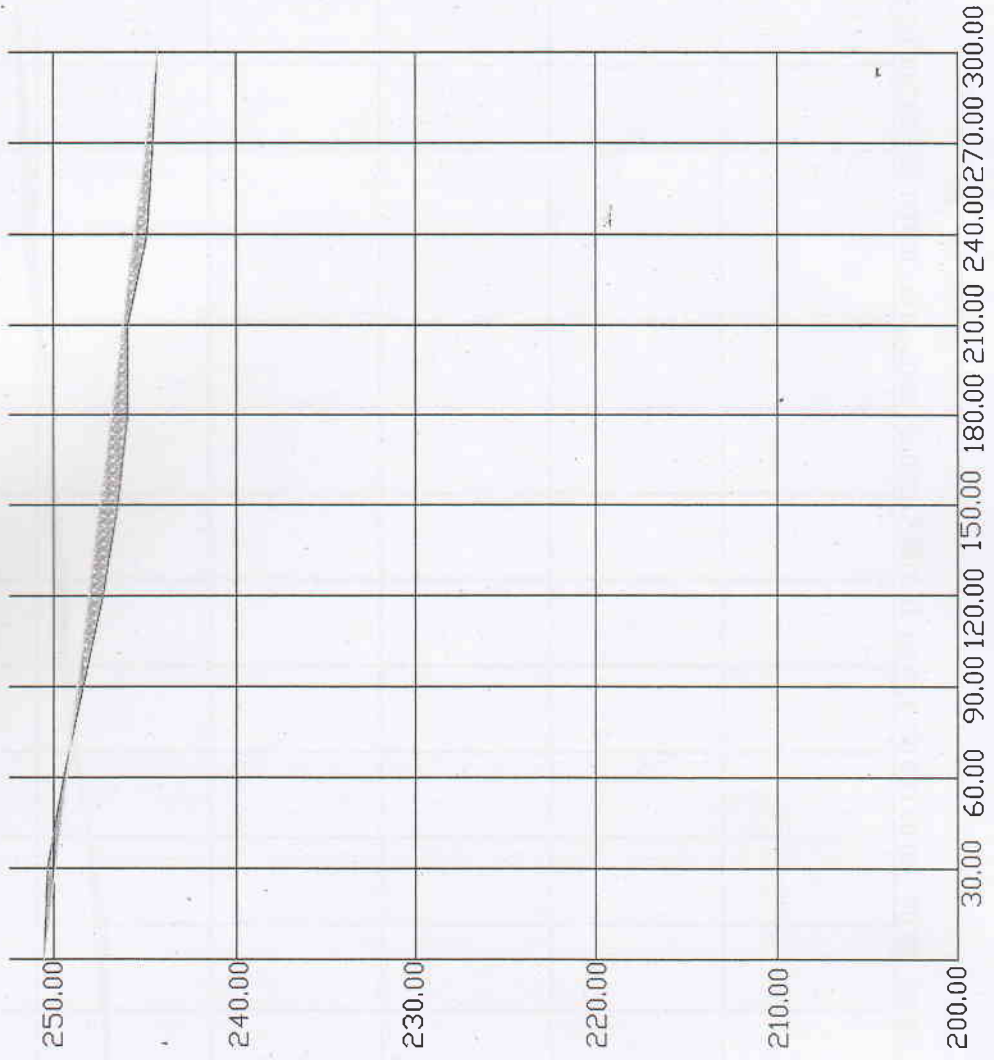

[Handwritten signature]

ROAD 3

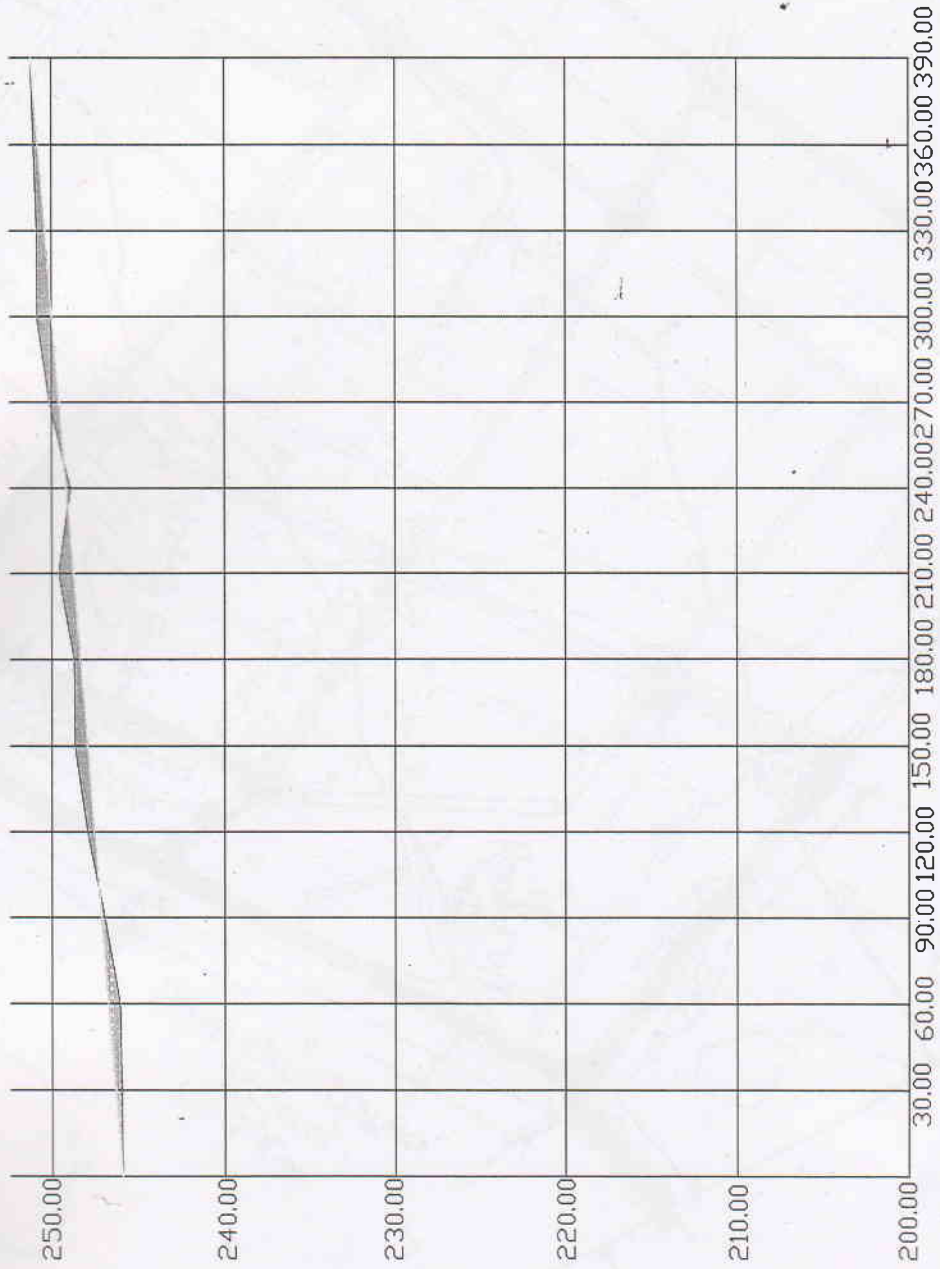

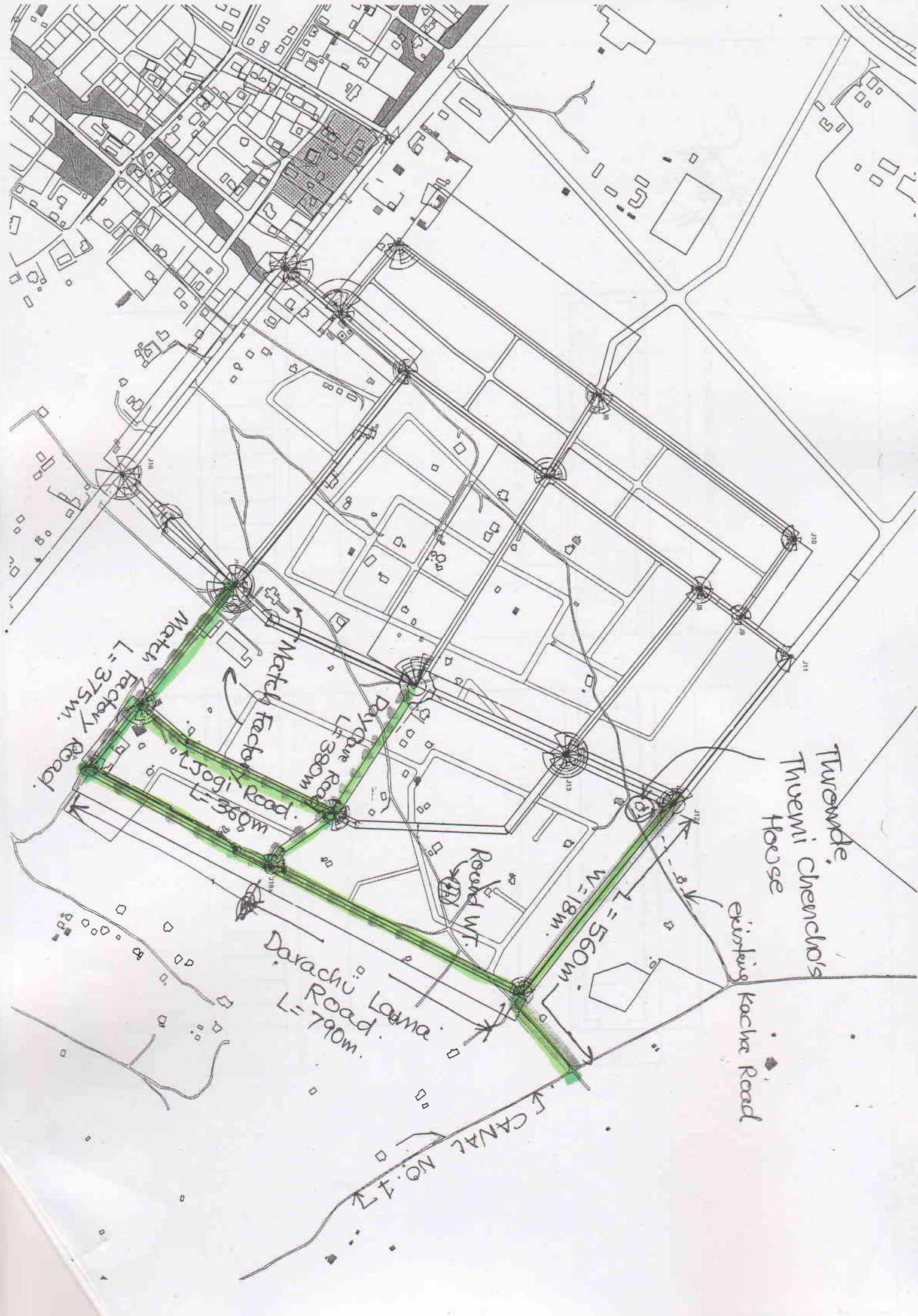

Turewde,
Turewmi Chenchlo's
House

epurteing
Kacha Road

L = 560m
W = 18m

Round W.T.

Darachü Lama
Road.
L = 790m.

Jogi Road.
L = 360m

Daryapur Road
L = 380m

Match Factory
Road.
L = 375m.

CANAL NO. 12

Section IX. Bill of Quantities⁵⁵

Notes on the Bill of Quantities

Objectives

The objectives of the Bill of Quantities are:

- (a) to provide sufficient information on the quantities of Works to be performed to enable Bids to be prepared efficiently and accurately; and*
- (b) when a Contract has been entered into, to provide a priced Bill of Quantities for use in the periodic valuation of Works executed.*

In order to attain these objectives, Works should be itemized in the Bill of Quantities in sufficient detail to distinguish between the different classes of Works, or between Works of the same nature carried out in different locations or in other circumstances which may give rise to different considerations of cost. Consistent with these requirements, the layout and content of the Bill of Quantities should be as simple and brief as possible.

Daywork Schedule

A Daywork Schedule should be included only if the probability of unforeseen work, outside the items included in the Bill of Quantities, is high. To facilitate checking by the Employer of the realism of rates quoted by the Bidders, the Daywork Schedule should normally comprise the following:

- (a) A list of the various classes of labour, materials and Constructional Plant for which basic Daywork rates or prices are to be inserted by the Bidder, together with a statement of the conditions under which the Contractor will be paid for work executed on a Daywork basis.*
- (b) Nominal quantities for each item of Daywork, to be priced by each Bidder at Daywork rates as Bid. The rate to be entered by the Bidder against each basic Daywork item should include the Contractor's profit, overheads, supervision and other charges.*

Provisional Sums

A general provision for physical contingencies (quantity overruns) may be made by including a provisional sum in the Summary Bill of Quantities. Similarly, a contingency allowance for possible price increases should be provided as a provisional sum in the Summary priced Bill of Quantities. The inclusion of such provisional sums often facilitates budgetary approval by avoiding the need to request periodic supplementary approvals as the future need arises. Where such provisional sums or contingency allowances are used, the Special Conditions of Contract should state the manner in which they will be used, and

⁵⁵ In lump sum contracts the Bill of Quantities is prepared for information; it is not contractual. The contractual document prepared by the Bidder shall be a Schedule of Activities.

under whose authority (usually the Project Manager's).

The estimated cost of specialized work to be carried out, or of special goods to be supplied, by other contractors (refer to Clause 8 of the General Conditions of Contract) should be indicated in the relevant part of the Bill of Quantities as a particular provisional sum with an appropriate brief description. A separate procurement procedure is normally carried out by the Employer to select such specialized contractors. To provide an element of competition among the Bidders in respect of any facilities, amenities, attendance, etc., to be provided by the successful Bidder as prime Contractor for the use and convenience of the specialist contractors, each related provisional sum should be followed by an item in the Bill of Quantities inviting the Bidder to quote a sum for such amenities, facilities, attendance, etc.

These Notes for Preparing a Bill of Quantities are intended only as information for the Employer or the person drafting the Bidding Documents. They should not be included in the final documents.

Name of Work: Construction of Urban Roads in LAP-II

(Fiscal Year 2014-2015)

Bill of Quantity

| SI No. | Description | Qty | Unit | Rate | | Amount |
|--------|--|----------|------|--------|-------|--------|
| | | | | Figure | Words | |
| 1 | Excavation of road formation/trace/box cutting, with excavator including separate deposition of soil,removal of trees, rock/roots of trees and stones within 50m for refuse.The road should be neatly dressed including rolling and filling of drepression from the earth received from excavation/formation cutting. | 6844.40 | m3 | | | |
| 2 | Providing and laying sand bedding(Bajri filling) including watering, ramming and dressing.(0.15m course bajri & 0.15m fine bajri i.e seived) The rolling to be carried out twice i.e each layers using road roller/vibrating as specified.The thickness of 0.30m is after final compaction of both layers & is uniform in all sections as depressions are covered in sl.no.1 | 18076.20 | cu.m | | | |
| 3 | Construction of R.C.C. Slab | | | | | |
| 3.1 | Excavation in foundation trenches or drains not exceeding 1.5m in width or area 10 sq.m on plan, including dressing & ramming, disposal of surplus soil within 50m lead & 1.5m lift. | 576.00 | cu.m | | | |
| 3.2 | P/L hand packed stone filling or soling with stones | 72.00 | cu.m | | | |
| 3.3 | P/L in position in plain cement concrete excluding the cost of centering and shuttering - all work up to plinth level. 1:2:4,20mm aggregates | 72.00 | cu.m | | | |
| 3.4 | Providing and laying Random Rubble Masonry with hard stone in foundation and plinth, in CM 1:4 | 384.00 | cu.m | | | |

| | | | | | | |
|-----|--|----------|------|--|--|--|
| 3.5 | Filling of trenches, sides of foundations etc. in layers<200mm using selected excavated earth, ramming etc. within lead 50 m & lift 1.5m | 256.00 | cu.m | | | |
| 3.6 | P/L cement plaster, 12mm plaster in cm 1:4. | 800.00 | Sqm | | | |
| 3.7 | P/l in position reinforced cement concrete excl. the cost of centering & shuttering and reinforcement, all work up to plinth level, 1:2:4, | 144.00 | m3 | | | |
| 3.8 | P/f reinforcement bars, TMT 500 mpa for rcc work including cutting, bending, binding and placing in position complete. dia x dia/162. | 10089.60 | kg | | | |
| 4 | Drain Construction | | | | | |
| 4.1 | Excavation in foundation trenches or drains not exceeding 1.5m in width or area 10 sq.m on plan, including dressing & ramming, disposal of surplus soil within 50m lead & 1.5m lift. | 6084.00 | Cu.m | | | |
| 4.2 | P/L hand packed stone filling or soling with stones, 150mm thick. | 722.25 | Cu.m | | | |
| 4.3 | P/L in position in plain cement concrete excluding the cost of centering and shuttering - all work up to plinth level. 1:2:4, 20mm aggregates | 598.00 | cu.m | | | |
| 4.4 | Providing and laying Random Rubble Masonry with hard stone in foundation and plinth, in CM 1:4 | 795.50 | Cu.m | | | |
| 4.5 | Filling of trenches, sides of foundations etc. in layers<200mm using selected excavated earth, ramming etc. within lead 50 m & lift 1.5m | 2600.00 | Cu.m | | | |
| 4.6 | P/L cement plaster, 12mm plaster in cm 1:4. | 9880.00 | Sqm | | | |
| 5 | Providing & Laying H.D.P.E pipe, pressure class 10kg/sq.m including fittings. 225mm dia. | 240.00 | m | | | |

| | | | | | | |
|---|--|----|---|--|----------------------------|--|
| 6 | P/L NP2 class R.C.C. Hume pipe 450mm dia. including collars, jointing in CM 1:2 incl. testing of joints complete with support walls,as included in given drawings. | 60 | m | | | |
| | | | | | Total Quoted Amount in Nu. | |

Say in Words.....

Seal & Sign of Bidder

Section X. Security Forms

Notes on Forms of Securities

Samples of acceptable forms of Bid, Performance, and Advance Payment Securities are provided in this section. Bidders should not complete the Performance and Advance Payment Security forms at this stage of the procurement process. Only the successful Bidder will be required to provide these two securities.

Form of Bid Security (Bank Guarantee)

*[The **Bank/Bidder** shall fill in this Bank Guarantee form in accordance with the instructions indicated in brackets .]*

[Bank's Name, and Address of Issuing Branch or Office]

Beneficiary: _____ *[Name and Address of Employer]*

Date: _____

BID GUARANTEE No.: _____

We have been informed that *[name of the Bidder]* (hereinafter called "the Bidder") has submitted to you its Bid dated (hereinafter called "the Bid") for the execution of *[name of contract]* under Invitation for Bids No. *[IFB number]* ("the IFB").

Furthermore, we understand that, according to your conditions, Bids must be supported by a Bid Guarantee.

At the request of the Bidder, we *[name of Bank]* hereby irrevocably undertake to pay you any sum or sums not exceeding in total an amount of *[amount in figures]* (*[amount in words]*) upon receipt by us of your first demand in writing accompanied by a written statement stating that the Bidder is in breach of its obligation(s) under the bid conditions, because the Bidder:

- (a) has withdrawn its Bid during the period of Bid validity specified by the Bidder in the Form of Bid; or
- (b) having been notified of the acceptance of its Bid by the Employer during the period of Bid validity, (i) fails or refuses to execute the Contract Form, if required, or (ii) fails or refuses to furnish the Performance Security, in accordance with the Instructions to Bidders.

This guarantee will expire: (a) if the Bidder is the successful Bidder, upon our receipt of copies of the Contract signed by the Bidder and the Performance Security issued to you upon the instruction of the Bidder; or (b) if the Bidder is not the successful Bidder, upon the earlier of (i) our receipt of a copy of your notification to the Bidder of the name of the successful Bidder; or (ii) 30 days after the expiration of the Bidder's Bid.

Consequently, any demand for payment under this guarantee must be received by us at this office on or before that date.

[signature(s)]

Performance Demand Bank Guarantee
(Unconditional)

[The **bank/successful Bidder** providing the Guarantee shall fill in this form in accordance with the instructions indicated in brackets.]

[bank's name, and address of issuing branch or office]

Beneficiary: *[name and address of Employer]*

Date: *[date]*

PERFORMANCE GUARANTEE No.: *[Performance Guarantee number]*

We have been informed that *[name of Contractor]* (hereinafter called "the Contractor") has entered into Contract No. *[reference number of the Contract]* dated *[date of Contract]* with you, for the execution of *[name of Contract and brief description of Works]* (hereinafter called "the Contract").

Furthermore, we understand that, according to the conditions of the Contract, a performance guarantee is required.

At the request of the Contractor, we *[name of Bank]* hereby irrevocably undertake to pay you any sum or sums not exceeding in total an amount of *[amount in figures] ([amount in words])*,⁵⁶ such sum being payable in the types and proportions of currencies in which the Contract Price is payable, upon receipt by us of your first demand in writing accompanied by a written statement stating that the Contractor is in breach of its obligation(s) under the Contract, without you needing to prove or to show grounds for your demand or the sum specified therein.

This guarantee shall expire no later than 30 days from the date of issuance of the Certificate of Completion, calculated based on a copy of such Certificate which shall be provided to us, or on the *[number]* day of *[month]*, *[year]*,⁵⁷ whichever occurs first. Consequently, any demand for payment under this guarantee must be received by us at this office on or before that date. The Guarantor agrees to a one-time extension of this Guarantee for a period not to exceed *[6 months][1 year]*, in response to the Employer's written request for such extension, such request to be presented to the Guarantor before the expiry of the Guarantee.

[signature(s) of an authorized representative(s) of the bank]

⁵⁶ The Guarantor (bank) shall insert an amount representing the percentage of the Contract Price specified in the Contract and denominated either in the currency(ies) of the Contract or a freely convertible currency acceptable to the Employer.

⁵⁷ Insert the date 30 days after the expected Completion date. The Employer should note that in the event of an extension of the time for completion of the Contract, the Employer would need to request an extension of this Guarantee from the Guarantor. Such request must be in writing and must be made prior to the expiration date established in the Guarantee.

Bank Guarantee for Advance Payment

*The **bank/successful Bidder** providing the Guarantee shall fill in this form in accordance with the instructions indicated in brackets.*

[bank's name, and address of issuing branch or office]

Beneficiary: *[name and address of Employer]*

Date: *[date]*

ADVANCE PAYMENT GUARANTEE No.: *[number]*

We have been informed that *[name of Contractor]* (hereinafter called "the Contractor") has entered into Contract No. *[reference number of the contract]* dated *[date of Contract]* with you, for the execution of *[name of contract and brief description of Works]* (hereinafter called "the Contract").

Furthermore, we understand that, according to the conditions of the Contract, an advance payment is to be made against an advance payment guarantee in the sum or sums indicated below.

At the request of the Contractor, we *[name of Bank]* hereby irrevocably undertake to pay you any sum or sums not exceeding in total an amount of *[amount in figures]* (*[amount in words]*⁵⁸) upon receipt by us of your first demand in writing accompanied by a written statement stating that the Contractor is in breach of its obligation under the Contract because the Contractor used the Advance Payment for purposes other than the costs of mobilization in respect of the Works.

It is a condition for any claim and payment under this guarantee to be made that the Advance Payment referred to above must have been received by the Contractor in its account number *[account number]* at *[name and address of Bank]*.

The maximum amount of this guarantee shall be progressively reduced by the amount of the Advance Payment repaid by the Contractor as indicated in copies of interim statements or payment certificates which shall be presented to us. This guarantee shall expire, at the latest, upon our receipt of a copy of the Interim Payment Certificate indicating that eighty percent (80%) of the Contract Price has been certified for payment, or on the *[number]* day of *[month]*, *[year]*,⁵⁹ whichever is earlier. Consequently, any demand for payment under this guarantee must be received by us at this office on or before that date. We agree to a one-time extension of this guarantee for a period not to exceed *[6 months]**[1 year]*, in response to

⁵⁸ The Guarantor shall insert an amount representing the amount of the Advance Payment and denominated either in the currency(ies) of the Advance Payment as specified in the Contract, or in a freely convertible currency acceptable to the Employer.

⁵⁹ Insert the expected expiration date of the Time For Completion. The Employer should note that in the event of an extension of the Time For Completion of the Contract, the Employer would need to request an extension of this guarantee from the Guarantor. Such request must be in writing and must be made prior to the expiration date established in the guarantee.

Invitation for Bids

Notes on the Invitation for Bids (IFB)

The Invitation for Bids shall be issued as an advertisement in at least one newspaper of national circulation in Bhutan, and on the websites of the Construction Development Board (CDB) and the Employer. Where applicable/feasible, it may also be announced on national radio, national television, and in other mass media.

Its purpose is to supply information to enable potential Bidders to decide whether to participate in the procurement process. The Invitation for Bids shall specify any important Bid evaluation criteria (for example, the application of a margin of preference in Bid evaluation) and qualification requirements (for example, a requirement for a minimum level of experience in carrying out works of a similar type and size to those for which the IFB is issued).

The Invitation for Bids shall not be incorporated into the Bidding Documents. However, the information contained in the Invitation for Bids should conform to the Bidding Documents and in particular to the relevant information in the Bidding Data Sheet.

SAMPLE FORMAT FOR INVITATION FOR BIDS

Invitation for Bids (IFB)

Bhutan

[insert name of Project]

[insert IFB title and Number]

1. This Invitation for Bids follows the General Procurement Notice for this Project that appeared in *[insert name of publication]* of *[insert date]*.⁶⁰

2. The *[insert complete name of Employer]* now invites sealed Bids from eligible and qualified Bidders for *[insert brief description of the Works to be procured, including quantities, location of Project, etc.]*.⁶¹ The period for execution of the assignment is *[insert number of days/months/years or dates]*.

2. Bidding will be conducted through the International/National *[insert whichever is appropriate]* Competitive Bidding procedures specified in the RGoB Procurement Manual, and is open to all Bidders from Countries as defined in Section III of the Bidding Documents⁶².

3. Interested eligible Bidders may obtain further information from *[insert complete legal name of Employer and name and e-mail address of officer in charge]* and inspect the Bidding Documents at the address given below *[state address at end of this IFB]* from *[insert office hours]*⁶³.

4. Qualifications requirements include: *[insert key technical, financial, legal and other requirements]*. A margin of preference for eligible national contractors/joint ventures/consortia/associations may be applied.

5. A complete set of Bidding Documents in *[insert name of language(s)]* may be purchased by interested Bidders on the submission of a written Application to the address below and upon payment of a non refundable fee⁶⁴ *[insert amount in local currency]* or in *[insert amount in specified convertible currency]*. The method of payment will be *[insert method of payment]*⁶⁵. The Bidding Documents will be sent by *[insert delivery procedure]*⁶⁶.

7. Bids must be delivered to the address below at or before *[insert time and date]*. Electronic bidding *[insert "shall" or "shall not"]* be permitted. Late Bids will be rejected. Bids will be opened physically *[insert "and electronically" if electronic bidding is permitted]* in the

⁶⁰ This sentence should be deleted if no General Procurement Notice was published.

⁶¹ A brief description of the type(s) of Works should be provided, including quantities, location of Project, and other information necessary to enable potential Bidders to decide whether or not to respond to the Invitation

⁶² Occasionally, contracts may be financed out of special funds that would further restrict eligibility to a particular group of countries. When this is the case, it should be mentioned in this paragraph

⁶³ For example, 9.00 AM to 5.00 PM.

⁶⁴ The fee should defray the printing and delivery; it should not be so high as to deter competition.

⁶⁵ For example, cashier's check, direct deposit to specified account number, etc.

⁶⁶ The delivery procedure should be by courier for overseas delivery and surface mail or courier for local delivery.

presence of the Bidders' representatives who choose to attend in person or on-line at the address below at *[insert time and date]*.

8. All Bids shall be accompanied by a Bid Security of *[insert amount in local currency or an equivalent amount in a freely convertible currency, or a minimum percentage of Bid price]*.⁶⁷

9. The address(es) referred to above is(are): *[insert detailed address(es) including complete legal name of the Employer, Office designation (room number) , name of Officer, Street address, City (code), Country; insert electronic address if electronic bidding is permitted; insert different addresses if addresses for purchase of Bidding Documents, Bid submission and Bid opening are different]*

⁶⁷ The amount of Bid Security should be stated as a fixed amount.

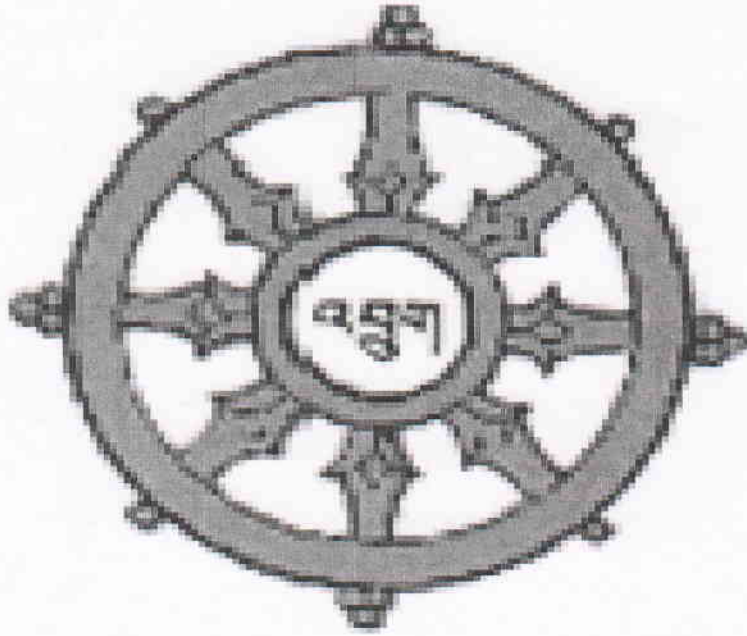

THANKS