

# SAT Subject Tests™

Preparation Booklet  
2007-08

## Get Ready for the SAT Subject Tests

- Learn about the 20 SAT Subject Tests
- Try Sample Questions



For more information, visit [collegeboard.com/subjecttests](http://collegeboard.com/subjecttests)

# Prepare for the **SAT** **Subject Tests**<sup>™</sup> with Help from the **Test Maker**

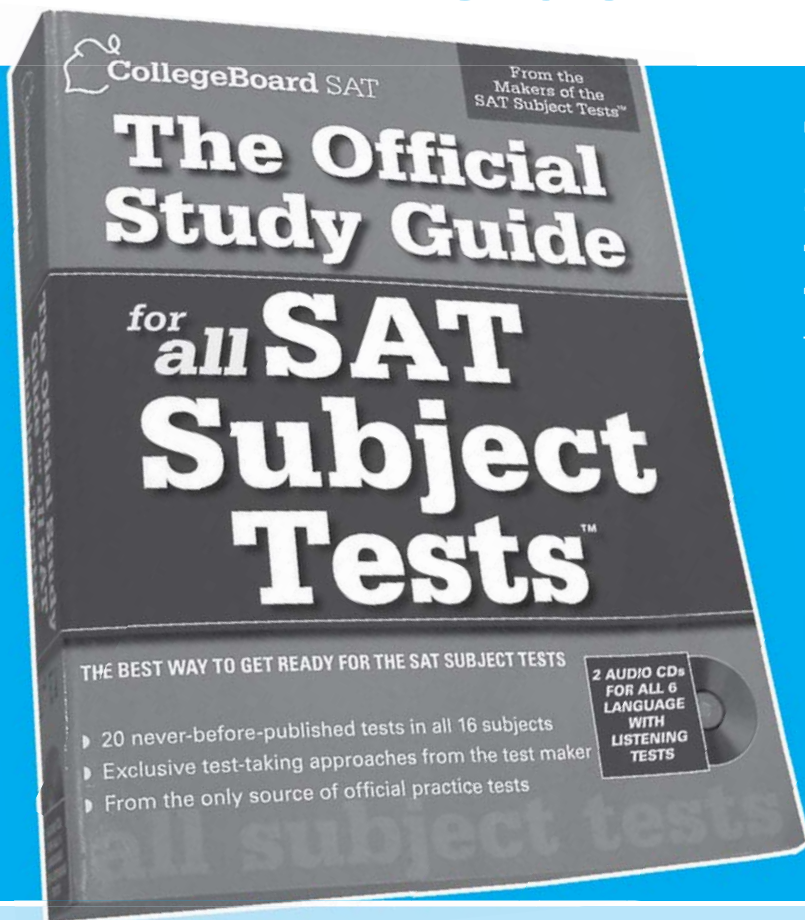

## The Official Study Guide for all SAT Subject Tests<sup>™</sup>

The College Board—maker of the SAT Subject Tests—is the only source of official practice tests.

- 20 previously administered SAT Subject Tests in all 16 subjects
- Sample questions with detailed answer explanations
- Two audio CDs for all 6 Language with Listening Tests
- Detailed descriptions of every Subject Test
- Test-taking approaches from the test maker

**Order today!** [store.collegeboard.com](http://store.collegeboard.com)

## The College Board:

### Connecting Students to College Success

The College Board is a not-for-profit membership association whose mission is to connect students to college success and opportunity. Founded in 1900, the association is composed of more than 5,200 schools, colleges, universities, and other educational organizations. Each year, the College Board serves seven million students and their parents, 23,000 high schools, and 3,500 colleges through major programs and services in college admissions, guidance, assessment, financial aid, enrollment, and teaching and learning. Among its best-known programs are the SAT®, the PSAT/NMSQT®, and the Advanced Placement Program® (AP®). The College Board is committed to the principles of excellence and equity, and that commitment is embodied in all of its programs, services, activities, and concerns.

For further information, visit [www.collegeboard.com](http://www.collegeboard.com).

## Contents

About the SAT Subject Tests™	4
Literature	6
United States History	10
World History	14
Mathematics Level 1 and Level 2	17
Biology-E/M	23
Chemistry	28
Physics	33
Chinese with Listening	39
French and French with Listening	44
German and German with Listening	51
Modern Hebrew	56
Italian	59
Japanese with Listening	62
Korean with Listening	66
Latin	70
Spanish and Spanish with Listening	73

### Additional Information

SAT Subject Tests Development Committees	78
Test Dates	Back Cover

# About the SAT Subject Tests™

## General Information

Many colleges require or recommend one or more SAT Subject Tests™ for admission or placement.

SAT Subject Tests are one-hour multiple-choice tests that measure how much you know about a particular academic subject and how well you can apply that knowledge.

Subject Tests fall into five subject areas: English, history, mathematics, sciences, and languages. They help colleges compare the academic achievement of students from different schools where course preparation and academic backgrounds may vary widely.

Subject Test results can be added to your portfolio to support your competency in academic areas, even if the tests are not required by colleges to which you're applying.

This booklet provides the following information for each Subject Test:

- Purpose
- Format
- Recommended preparation
- Test directions
- Score reporting
- Sample questions and answers

## How Colleges Use Subject Test Scores

Colleges use Subject Test scores, in combination with other information (your high school record, scores from other tests, teacher recommendations, etc.), as a dependable measure of your academic background and achievement and as a good predictor of your future performance.

The scores help colleges

- determine how well prepared you are for different programs.
- place you in freshman and higher-level courses.
- advise you on course selection.

## How to Register

All the information you need to register and report scores to colleges is available online at [www.collegeboard.com/sat](http://www.collegeboard.com/sat) and in the *SAT Registration Booklet* available in your school counselor's office.

## How to Prepare

- **Know what to expect on test day.** See [www.collegeboard.com/sat](http://www.collegeboard.com/sat) or the *SAT Registration Booklet* for details.
- **Know what to expect on your tests.** Study the descriptions of the tests, directions, and sample questions in this book. For Listening Tests, ask your counselor for a copy of the practice audio CD that was sent to your school.
- **Become familiar with the test directions.** Some tests, such as the Chemistry Subject Test, may have directions you will need to know before you take the test, so you're not surprised or confused on test day.
- **Know how the tests are scored.** You get one point for each correct answer and lose a fraction of a point for each incorrect answer. Omitted answers are not counted either way.
- **Take official practice tests and review test-taking approaches with *The Official Study Guide for all SAT Subject Tests™*.**

## Which Subject Tests to Take

You can find out if the colleges you are interested in require or recommend Subject Tests by

- contacting colleges directly.
- reviewing college catalogs.
- checking the College Board's *College Handbook*.
- using the online college search at [www.collegeboard.com](http://www.collegeboard.com).

## When to Take Subject Tests

- Read the test descriptions in this book. See how much preparation is recommended and when the tests are offered.
- Ask your teacher or counselor for advice.

- Take tests such as United States History, Biology E/M, Chemistry, or Physics as soon as possible after you complete the course, while the material is still fresh in your mind.
- You'll do better on other tests like languages after at least two years of study.

## The Day Before the Tests

- Make sure your calculator is in good working order if you are taking a Mathematics Test.
- Make sure your CD player with earphones is in good working order if you are taking a listening test.

## Test Day

### Test-Taking Approaches

- **Answer the easy questions first.** Mark only one answer for each question.
- **Pace yourself.** Answer the questions you know first and come back later to those you didn't know.
- **Guess smart.** If you can rule out one or more answers as wrong, your chances of guessing correctly among the remaining choices improve.
- **Omit questions only when you have no idea how to answer them.**
- **Use your test book for scratch work.** Transfer your answers to your answer sheet. You will receive credit **ONLY** for what is written on your answer sheet.
- **Mark your answer in the correct column.** The answer sheet has five circles for each question. Some questions, though, have only three or four possible answers.

### Erasing Answers

If you need to erase an answer, erase it as completely as possible. **IMPORTANT NOTE: If you start a test and decide that you are not ready for it, you should cancel your scores. Do not erase all your answers. You must complete a cancellation form.**

### Canceling Scores

If you want to cancel your scores, you must cancel scores for ALL Subject Tests you take at an administration unless your equipment malfunctions. (See column on the right for CD player malfunctions and page 18 for calculator malfunctions.)

## Language Tests with Listening

- **Bring an acceptable CD player to the test center.** Your CD player **MUST** be
  1. equipped with earphones
  2. portable (handheld)
  3. battery operated
- **You are not allowed to use a CD player with recording or duplicating capabilities.**
- **Make sure your CD player is in good working order.** Insert new batteries the day before the test. You may bring additional batteries and a backup player to the test center. Test center staff will not have batteries, CD players, or earphones for your use.
- **You may not share a CD player with another test-taker.**
- **If the volume on your CD player disturbs other test-takers,** the test center supervisor may ask you to move to another seat.
- **If your CD player malfunctions:**
  1. Raise your hand and tell the test supervisor.
  2. Switch to backup equipment, if you have it, and continue to test.
  3. You may cancel your score on the listening test if you do not have backup equipment. Scores for other Subject Tests you take that day will not be canceled.
- **If you encounter problems with your CD, such as occasional skipping, try to work through the problem and keep testing if possible. If necessary, raise your hand and ask the supervisor for a replacement CD. If a replacement is not available, a makeup test will be arranged.**

## After the Tests

Most, but not all, scores will be reported online several weeks after the test date. Your score report will also be mailed to you and to the high school, colleges, universities, and scholarship programs you indicated when you registered or when you sent additional scores.



# Literature

One-hour subject test

## Purpose

- Measure interpretive skills necessary to read poetry and prose from different periods and cultures

## Format

- About 60 multiple-choice questions
- 6 to 8 reading selections followed by sets of 4 to 12 questions
- Selections from works originally written in English from the Renaissance to the present

Questions may cover:

- Overall meaning, including effect and theme
- Form, including structure, genre, and organization
- Use of language, including word choice, imagery, and metaphor
- Meanings and connotations of specific words in context
- Narrative voice, including tone and attitude
- Characterization in narrative and dramatic selections

## Recommended Preparation

- Close, critical reading in English and American literature from a variety of historical periods and genres
- Reading of complete novels and plays, not just excerpts
- Working knowledge of basic literary terminology, such as *speaker*, *tone*, *image*, *irony*, *alliteration*, *stanza*
- Three or four years of literary study at the college-preparatory level
- Independent, critical reading of poetry, prose, and drama
- No suggested reading list

## Score

- Total score: 200–to–800 scale

## CONTENT

Approximate  
% of Test\*

### Source of Questions

English literature	40–50
American literature	40–50
Other literature written in English	0–10

### Chronology

Renaissance and 17th century	30
18th and 19th centuries	30
20th century	40

### Genre

Poetry	40–50
Prose	40–50
Drama and other	0–10

*\*The distribution of passages may vary in different versions of the test. The chart above indicates typical or average content.*

## Sample Questions

Questions on the Literature Subject Test are presented as sets of questions about reading selections. The directions that follow are identical to those in the test. All questions on the test are multiple-choice questions in which you must choose the **BEST** response from the five choices offered. For these sample materials and for the actual test, the date printed at the end of each passage or poem is the original publication date or, in some cases, the estimated date of composition.

**Directions:** This test consists of selections from literary works and questions on their content, form, and style. After reading each passage or poem, choose the best answer to each question and fill in the corresponding circle on the answer sheet.

**Note:** Pay particular attention to the requirement of questions that contain the words NOT, LEAST, or EXCEPT.

**Questions 1–4.** Read the following passage carefully before you choose your answers.

By the time the man with the camera had cut across our neighbor's yard, the twins were out of the trees swingin low and Granny was onto the steps, the screen door bammin soft and scratchy against her palms.

Line (5) “We thought we’d get a shot or two of the house and everything and then . . .”

“Good mornin,” Granny cut him off. And smiled that smile.

“Good mornin,” he said, head all down the way

(10) Bingo does when you yell at him about the bones on the kitchen floor. “Nice place you got here, aunty. We thought we’d take a . . .”

“Did you?” said Granny with her eyebrows. Cathy pulled up her socks and giggled.

(15) “Nice things here,” said the man buzzin his camera over the yard. The pecan barrels, the sled, me and Cathy, the flowers, the painted stones along the driveway, the trees, the twins, the toolshed.

“I don’t know about the thing, the it, and the stuff,”

(20) said Granny still talkin with her eyebrows. “Just people here is what I tend to consider.”

Camera man stopped buzzin. Cathy giggled into her collar.

“Mornin, ladies,” a new man said. He had come up

(25) behind us when we weren’t lookin. “And gents,” discoverin the twins givin him a nasty look. “We’re filmin for the county,” he said with a smile. “Mind if we shoot a bit around here?”

“I do indeed,” said Granny with no smile.

(30) Smilin man was smiling up a storm. So was Cathy. But he didn’t seem to have another word to say, so he and the camera man backed on out the yard, but you could hear the camera buzzin still.

“Suppose you just shut that machine off,” said

(35) Granny real low through her teeth and took a step down off the porch and then another.

“Now, aunty,” Camera said pointin the thing straight at her.

“Your mama and I are not related.”

(1971)

- After Granny’s “Good mornin” (line 7), the camera man probably behaves as he does because he
  - is made to realize that he is intruding
  - suspects that he is in physical danger
  - hopes to win Granny’s affection by appearing at ease
  - is relieved that an adult is present
  - realizes that he is disturbing the tidiness of the yard
- The tone of “Now, aunty” (line 37) is most accurately described as
  - expectant
  - patronizing
  - accusatory
  - obedient
  - respectful
- Granny’s final comment can best be understood as a
  - reluctant confession
  - tentative assertion
  - witty joke
  - surprising revelation
  - strong rebuke

- The episode reveals a conflict between
  - propriety and impertinence
  - virtue and corruption
  - kindness and cruelty
  - passiveness and aggression
  - refinement and grossness

**Questions 5-9.** Read the following excerpt from a poem carefully before you choose your answers.

One summer evening (led by her)<sup>1</sup> I found  
 A little boat tied to a willow tree  
 Within a rocky cave, its usual home.  
*Line* Straight I unloosed her chain, and stepping in  
 (5) Pushed from the shore. It was an act of stealth  
 And troubled pleasure, nor without the voice  
 Of mountain-echoes did my boat move on;  
 Leaving behind her still, on either side,  
 Small circles glittering idly in the moon,  
 (10) Until they melted all into one track  
 Of sparkling light. But now, like one who rows,  
 Proud of his skill, to reach a chosen point  
 With an unswerving line, I fixed my view  
 Upon the summit of a craggy ridge,  
 (15) The horizon’s utmost boundary; for above  
 Was nothing but the stars and the grey sky.  
 She was an elfin pinnacle;<sup>2</sup> lustily  
 I dipped my oars into the silent lake,  
 And, as I rose upon the stroke, my boat  
 (20) Went heaving through the water like a swan;  
 When, from behind that craggy steep till then  
 The horizon’s bound, a huge peak, black and huge,  
 As if with voluntary power instinct  
 Upreared its head. I struck and struck again,  
 (25) And growing still in stature the grim shape  
 Towered up between me and the stars, and still,  
 For so it seemed, with purpose of its own  
 And measured motion like a living thing,  
 Strode after me. With trembling oars I turned,  
 (30) And through the silent water stole my way  
 Back to the covert of the willow tree;  
 There in her mooring-place I left my bark, —  
 And through the meadows homeward went, in grave  
 And serious mood; but after I had seen  
 (35) That spectacle, for many days, my brain  
 Worked with a dim and undetermined sense  
 Of unknown modes of being; o’er my thoughts  
 There hung a darkness, call it solitude  
 Or blank desertion. No familiar shapes  
 (40) Remained, no pleasant images of trees,  
 Of sea or sky, no colours of green fields;  
 But huge and mighty forms, that do not live  
 Like living men, moved slowly through the mind  
 By day, and were a trouble to my dreams.

<sup>1</sup>nature

(1850)

<sup>2</sup>a boat

5. The excerpt is best described as
- (A) an enthusiastic celebration of youthful optimism
  - (B) an ironic self-portrait colored by satiric observations
  - (C) an imaginative evocation without didactic intention
  - (D) a symbolic representation of intellectual creativity
  - (E) a narrative episode with philosophical implications
6. In lines 1-7, which of the following devices is used to present nature, the boat, and the mountain echoes?
- (A) Personification
  - (B) Apostrophe
  - (C) Rhyme
  - (D) Paradox
  - (E) Simile
7. In lines 6-7, “the voice/Of mountain-echoes” serves to reinforce the speaker’s sense of
- (A) freedom
  - (B) omnipotence
  - (C) furtiveness
  - (D) enthusiasm
  - (E) despondency
8. At the conclusion of the excerpt, the “huge peak” (line 22) seems to represent which of the following for the speaker?
- (A) An emblem of the beauty of the natural world
  - (B) A figure of undefined and unsettling significance
  - (C) An allegorical representation of sin itself
  - (D) A curious natural phenomenon
  - (E) A trivial figment of the speaker’s imagination
9. Which of the following best describes the change in the outlook of the speaker during the course of this excerpt?
- (A) Naïveté to cynicism
  - (B) Bravery to cowardice
  - (C) Hope to despair
  - (D) Daring to uncertainty
  - (E) Eagerness to sloth

**Questions 10-14.** Read the following poem carefully before you choose your answers.

Poor soul, the centre of my sinful earth,  
 Fenc'd by these rebel pow'rs that thee array,  
 Why dost thou pine within and suffer dearth,  
 Painting thy outward walls so costly gay?  
 Why so large cost, having so short a lease,  
 Dost thou upon thy fading mansion spend?  
 Shall worms, inheritors of this excess,  
 Eat up thy charge? Is this thy body's end?  
 Then, soul, live thou upon thy servant's loss,  
 And let that pine to aggravate thy store;  
 Buy terms divine in selling hours of dross;  
 Within be fed, without be rich no more:  
 So shalt thou feed on Death, that feeds on men,  
 And Death once dead, there's no more dying then.  
 (1609)

10. The dramatic situation in the poem is that of
- (A) a youth speaking to a lover
  - (B) a priest speaking to a sinner
  - (C) a reformer addressing an impoverished person
  - (D) God addressing any human soul
  - (E) an individual addressing his or her own soul
11. In the context of the poem, “Painting thy outward walls so costly gay” (line 4) refers to
- (A) camouflage
  - (B) writing poetry
  - (C) attending to physical appearances
  - (D) pretending to be happy
  - (E) preparations for a celebration
12. The poet signals a major shift at line 9 by changing from
- (A) entirely negative to entirely positive imagery
  - (B) imagery of permanence to imagery of change
  - (C) direct address to impersonal statement
  - (D) material to spiritual imagery
  - (E) questions to commands



13. Which of the following best describes the theme of the concluding couplet (lines 13-14)?
- (A) A confession of sin before an almighty judge
  - (B) An affirmation of the immortality of the soul
  - (C) A declaration of rebellion against the powers of fate
  - (D) An accusation that death is a faithless servant
  - (E) A surrender to the inexplicable nature of life
14. The central contrast in the poem is expressed in all of the following pairs EXCEPT
- (A) “Poor soul” . . . “sinful earth” (line 1)
  - (B) “worms” . . . “inheritors” (line 7)
  - (C) “soul” . . . “thy servant’s” (line 9)
  - (D) “terms divine” . . . “hours of dross” (line 11)
  - (E) “Within” . . . “without” (line 12)

## ANSWERS

The difficulty of sample Literature questions is reported by the set only. (The complexity of a literary text often influences the difficulty of the questions asked about it.) Questions 1–4 overall are an easy set, questions 5–9 overall are a set of average difficulty, and questions 10–14 overall are a hard set.

<b>1. A</b>	<b>4. A</b>	<b>7. C</b>	<b>10. E</b>	<b>13. B</b>
<b>2. B</b>	<b>5. E</b>	<b>8. B</b>	<b>11. C</b>	<b>14. B</b>
<b>3. E</b>	<b>6. A</b>	<b>9. D</b>	<b>12. E</b>	

# United States History

One-hour subject test

## Purpose

- Measure comprehension of United States history from pre-Columbian times to the present as well as basic social science concepts, methods, and generalizations as found in the study of history

## Format

- 90–95 multiple-choice questions
- Questions covering political, economic, social, intellectual, and cultural history and foreign policy

Questions may require you to

- understand terms, concepts, and generalizations.
- recall basic information.
- understand significant aspects of U.S. history.
- analyze and interpret materials.
- relate ideas to given data.
- evaluate data for a given purpose.

## Recommended Preparation

- One-year comprehensive course in United States history at the college-preparatory level
- Social studies courses and outside reading

## Score

- Total score: 200–to–800 scale

CONTENT	Approximate % of Test
<b>Material Covered*</b>	
Political history	32–36
Economic history	18–20
Social history	18–22
Intellectual and cultural history	10–12
Foreign policy	13–17
<b>Periods Covered</b>	
Pre-Columbian history to 1789	20
1790–1898	40
1899 to the present	40
<i>*Social science concepts, methods, and generalizations are incorporated in this material.</i>	

## Sample Questions

All questions in the U.S. History Subject Test are multiple-choice questions in which you are asked to choose the **BEST** response from the five choices offered. The directions that follow are identical to those in the test.

**Directions:** Each of the questions or incomplete statements below is followed by five suggested answers or completions. Select the one that is **BEST** in each case and then fill in the corresponding circle on the answer sheet.

1. Which of the following best describes the pattern of immigration into Britain's North American colonies during the years 1620 to 1770?
  - (A) Largely English in the seventeenth century, non-English in the eighteenth century
  - (B) Chiefly of English origin during the whole period
  - (C) Largely non-English in the seventeenth century, English in the eighteenth century
  - (D) Predominantly from southern and eastern Europe, especially after 1700
  - (E) Predominantly from Asia, Africa, and Spanish America, especially after 1650

2. George Grenville viewed the Stamp Act primarily as a means to
- (A) make the customs service more efficient
  - (B) punish rebellious colonists
  - (C) test the colonists' will to resist England
  - (D) create more patronage positions for the king's courtiers
  - (E) raise revenue for the crown
3. Which of the following statements is generally true of the framers of the Constitution?
- (A) They believed in the supremacy of the executive branch of the federal government.
  - (B) They had great faith in the goodness and rationality of people.
  - (C) They were opposed to the development of political parties.
  - (D) They incorporated into the Constitution the most democratic ideals of the Declaration of Independence.
  - (E) They believed the new American republic would be stable because of the unanimity of public opinion in the country on major policy issues.

4. "What is man born for but to be a reformer, a remaker of what man has made; a renouncer of lies; a restorer of truth and good, imitating that great Nature which embosoms us all, and which sleeps no moment on an old past, but every hour repairs herself, yielding every morning a new day, and with every pulsation a new life?"

These sentiments are most characteristic of

- (A) fundamentalism
  - (B) Social Darwinism
  - (C) pragmatism
  - (D) neoorthodoxy
  - (E) transcendentalism
5. From 1870 to 1930, the trend in industry was for hours to be generally reduced, while both money wages and real wages rose. What factor was primarily responsible for this trend?
- (A) A reduction in profit margins
  - (B) Minimum-wage laws
  - (C) Restriction of the labor supply
  - (D) Increased output per hour of work
  - (E) Right-to-work legislation

6. I. "I believe it is the duty of the Negro—as the greater part of the race is already doing—to deport himself modestly in regard to political claims, depending upon the slow but sure influences that proceed from the possession of property, intelligence, and high character for the full recognition of his political rights."
- II. "The truth is that 'integration' is an *image*, it's a foxy Northern liberal's smoke-screen that confuses the true wants of the American black man."
- III. "The talented tenth of the Negro race must be made leaders of thought and missionaries of culture among their people . . . The Negro race, like all other races, is going to be saved by its exceptional men."

The most probable authors of statements I, II, and III, respectively, are

- (A) Malcolm X, Nat Turner, and Martin Luther King, Jr.
  - (B) Booker T. Washington, Malcolm X, and W.E.B. Du Bois
  - (C) Martin Luther King, Jr., Booker T. Washington, and W.E.B. Du Bois
  - (D) Nat Turner, Martin Luther King, Jr., and Booker T. Washington
  - (E) W.E.B. Du Bois, Malcolm X, and Martin Luther King, Jr.
7. All of the following are true of the movement to prohibit alcoholic beverages in the United States EXCEPT:
- (A) It arose quite suddenly amid the hysteria surrounding the First World War.
  - (B) It won the support of many progressive reformers.
  - (C) It was often favored by people who disliked immigrants and their cultural practices.
  - (D) It was a movement in which women played leading roles.
  - (E) It gained strength from new scientific evidence that alcohol was harmful to health.

8. Which of the following was symbolic of the rise of American influence in the fine arts after the Second World War?
- (A) Mary Cassatt's work in Impressionism
  - (B) Thomas Eakin's work in Realism
  - (C) Grant Wood's work in Regionalism
  - (D) Jackson Pollock's work in Abstract Expressionism
  - (E) John S. Copley's work of realistic portraiture
9. Major population shifts between 1915 and 1980 included all of the following EXCEPT a movement from
- (A) the rural South to Northern cities
  - (B) New England to the Midwest
  - (C) the North to the Sun Belt
  - (D) the inner cities to the suburbs
  - (E) the Caribbean region to the American mainland
10. Which of the following Presidents is correctly paired with an event that took place during his administration?
- (A) Lyndon B. Johnson . . . the establishment of diplomatic relations between the United States and the People's Republic of China
  - (B) John F. Kennedy . . . resolution of the Suez Crisis
  - (C) Richard M. Nixon . . . the reduction of United States forces in Vietnam
  - (D) Gerald R. Ford . . . the signing of the Camp David Accords
  - (E) Jimmy Carter . . . resolution of the Cuban Missile Crisis
11. The Emancipation Proclamation declared slaves in which of the following areas "forever free"?
- (A) All areas of the United States
  - (B) All areas of the Confederacy
  - (C) Areas in border states loyal to the Union
  - (D) Confederate areas still in rebellion
  - (E) Areas in states controlled by Union forces

12. "The point I wish plainly to bring before you on this occasion is the individuality of each human soul; our Protestant idea, the right of individual conscience and judgment; our republican idea, individual citizenship. . . . If we consider [a woman] as a citizen, as a member of a great nation, she must have the same rights as all other members, according to the fundamental principles of our government."

The statement above was made by

- (A) Thomas Jefferson
- (B) Elizabeth Blackwell
- (C) Henry David Thoreau
- (D) Margaret Sanger
- (E) Elizabeth Cady Stanton

**Questions 13-14.** These questions refer to the following map:



13. The controversy with Great Britain over the northern boundary of the shaded section was settled during the presidency of
- (A) John Quincy Adams
  - (B) James K. Polk
  - (C) Franklin Pierce
  - (D) James Buchanan
  - (E) Andrew Johnson

14. To the north of the area shown on the map is a continental territory purchased by Secretary of State William H. Seward from
- (A) Great Britain
  - (B) Canada
  - (C) Russia
  - (D) France
  - (E) Spain

- 
15. A major change brought about by Franklin D. Roosevelt's New Deal, 1933–1939, was the
- (A) creation of machinery for maintaining full employment
  - (B) transformation of a business-dominated society into a labor-dominated one
  - (C) redistribution of population from urban centers to rural areas
  - (D) development of new attitudes about the role and function of government
  - (E) destruction of machine politics at the state and city levels



National Archives

16. The 1940s poster above referred to the
- (A) contribution of women to the defense industry
  - (B) growing popularity of women movie stars
  - (C) large number of women in the armed forces
  - (D) large number of immigrants who supported the war effort
  - (E) affection of Americans for their wartime President

## ANSWERS

The estimated difficulty level, on a scale of 1 to 5, with 1 the easiest and 5 the most difficult, is in parentheses.

- |          |          |           |           |
|----------|----------|-----------|-----------|
| 1. A (2) | 5. D (4) | 9. B (3)  | 13. B (2) |
| 2. E (2) | 6. B (5) | 10. C (3) | 14. C (2) |
| 3. C (3) | 7. A (4) | 11. D (3) | 15. D (3) |
| 4. E (5) | 8. D (3) | 12. E (3) | 16. A (2) |



# World History

One-hour subject test

## Purpose

- Measure understanding of key developments in global history
- Assess ability to use basic historical techniques including application and weighing of evidence and the ability to interpret and generalize

## Format

- 95 multiple-choice questions
- Questions covering political and diplomatic, social and economic, and intellectual and cultural fields

Questions may require you to

- show knowledge of facts and terms.
- understand cause-and-effect relationships.
- use your knowledge of events and geography to demonstrate understanding of major historical developments.
- understand concepts essential to historical analysis.
- interpret artistic materials and assess quotations from published materials.

## Recommended Preparation

- One-year comprehensive course in world history at the college-preparatory level
- Independent reading of materials on historical topics

## Score

- Total score: 200–to–800 scale

## CONTENT

Approximate  
% of Test

### Material Covered

Global or comparative	25
Europe	25
Africa	10
Southwest Asia	10
South and Southeast Asia	10
East Asia	10
Americas	10

### Periods Covered

Prehistory and civilizations to 500 C.E.*	25
500 to 1500 C.E.	20
1500 to 1900 C.E.	25
Post-1900 C.E.	20
Cross-chronological	10

*\*The World History Subject Test uses the chronological designations B.C.E. (before common era) and C.E. (common era). These labels correspond to B.C. (before Christ) and A.D. (anno Domini), which are used in some world history textbooks.*

## Sample Questions

All questions in the World History Subject Test are multiple-choice questions in which you are asked to choose the **BEST** response from the five choices offered. The directions that follow are identical to those that are in the test.

**Directions:** Each of the questions or incomplete statements below is followed by five suggested answers or completions. Select the one that is **BEST** in each case and then fill in the corresponding circle on the answer sheet.

1. Based on archaeological evidence, experts on the prehistoric period believe that the first hominids probably lived in
  - (A) North America
  - (B) South America
  - (C) Australia and New Zealand
  - (D) East Africa
  - (E) Northern Europe
2. Which of the following was an important virtue in Confucianism?
  - (A) Warlike prowess
  - (B) Filial piety
  - (C) Public charity
  - (D) Poverty
  - (E) Manual labor

3. Early Christians developed the monastic ideal as a means of counteracting
  - (A) government interference
  - (B) heresy
  - (C) competition from Eastern religions
  - (D) worldliness
  - (E) persecution
4. The Silk Routes were important in ancient times because they
  - (A) facilitated the exchange of goods and ideas between China and the Roman Empire
  - (B) allowed gold and silver mined in China to be traded for European furs and wool cloth
  - (C) provided trade links between the people of Siberia and the people living on islands in the Bering Sea
  - (D) provided a conduit for trade in silk, porcelain, and costly gems between China and Japan
  - (E) allowed carts and carriages to travel on paved roads across northern Asia as far west as the Caspian Sea



5. The bronze plaque shown above was created in
  - (A) Italy
  - (B) Central Asia
  - (C) Arabia
  - (D) West Africa
  - (E) China

6. Which of the following was characteristic of the physical environments of early river-valley civilizations in the Near East?
  - (A) Cool summer temperatures encouraged the production of grain crops.
  - (B) Tropical forests along the riverbanks provided the population with most of its food.
  - (C) The rivers maintained a steady flow year-round, fed by melting mountain glaciers.
  - (D) The rivers flowed through deep mountain valleys, which sheltered early civilizations.
  - (E) Rainfall was low, requiring irrigation of crops with river water.

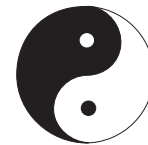

7. The ancient Chinese symbol of the universe shown above represented
  - (A) the theory that everything consists of opposite but complementary elements
  - (B) the Zen concept of unity in artistic expression
  - (C) Buddha's vision of the perfect shape
  - (D) a dualism in which everything is in conflict, and nothing can be resolved
  - (E) the moral principles of Confucius

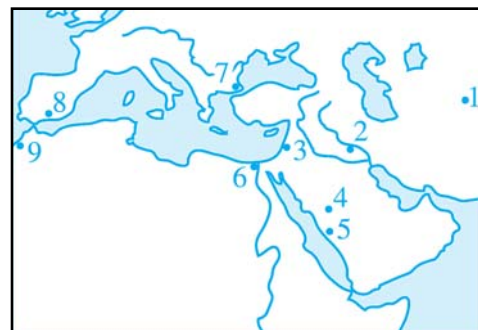

8. In the map above, the numbered dots correspond to cities. In the eighth century, which cities were near the east-west limits of the Islamic world?
  - (A) 1 and 7
  - (B) 1 and 9
  - (C) 2 and 6
  - (D) 2 and 8
  - (E) 5 and 7

9. The *encomienda* system of colonial Spanish America most closely resembled the European practice of
- (A) absolutism
  - (B) primogeniture
  - (C) patronage
  - (D) manorialism
  - (E) nepotism
10. In early modern Europe, governments sought to increase national wealth and maintain a favorable balance of trade through government intervention by advocating
- (A) Liberalism
  - (B) Capitalism
  - (C) Socialism
  - (D) Utilitarianism
  - (E) Mercantilism
11. “Where it is an absolute question of the welfare of our country, we must admit of no considerations of justice or injustice, or mercy or cruelty, or praise or ignominy, but putting all else aside must adopt whatever course will save its existence and preserve its liberty.”
- The statement above expresses the viewpoint of which of the following?
- (A) Niccolò Machiavelli
  - (B) Sir Thomas More
  - (C) Desiderius Erasmus
  - (D) Dante Alighieri
  - (E) John Calvin
12. Social Darwinists such as Herbert Spencer argued that
- (A) competition allows individuals to develop their talents and meet their needs
  - (B) competition and cooperation are equally important in building a productive and compassionate society
  - (C) human societies progress through competition, since the strong survive and the weak perish
  - (D) human societies progress through cooperation, a natural instinct that should be encouraged
  - (E) God predetermines that some members of society are fated to succeed and some members are fated to fail
13. Shah Mohammad Reza Pahlavi fell from power in the Iranian revolution of 1978-1979 partly because he
- (A) was moving toward a military alliance with the Soviet Union
  - (B) was aggressive in modernizing the country along Western lines
  - (C) insisted on strict enforcement of Islamic religious laws
  - (D) tried unsuccessfully to annex Afghanistan
  - (E) opposed increased educational and employment opportunities for women
14. Differences between which two religions contributed to violent conflicts in India during and after the struggle for independence in 1947?
- (A) Hinduism and Buddhism
  - (B) Islam and Christianity
  - (C) Hinduism and Islam
  - (D) Islam and Buddhism
  - (E) Hinduism and Jainism
15. Most of the noncitizens currently residing in Western European countries originally came to Western Europe to
- (A) consolidate the European Economic Community agreements
  - (B) find employment
  - (C) do graduate work in the universities
  - (D) participate in the democratic political process
  - (E) avoid forced military conscription in their native land

## ANSWERS

The estimated difficulty level, on a scale of 1 to 5, with 1 the easiest and 5 the most difficult, is in parentheses.

- |          |          |           |           |
|----------|----------|-----------|-----------|
| 1. D (2) | 5. D (4) | 9. D (3)  | 13. B (4) |
| 2. B (4) | 6. E (4) | 10. E (3) | 14. C (1) |
| 3. D (5) | 7. A (2) | 11. A (4) | 15. B (4) |
| 4. A (3) | 8. B (4) | 12. C (2) |           |

# Mathematics

## Level 1 and Level 2

One-hour subject tests

### Purpose

- Measure knowledge of mathematics through the first three years of college-preparatory mathematics for Level 1 and through precalculus for Level 2

### Format

- 50 multiple-choice questions
- Questions covering content typically taught in the first three years (for Level 1) or four years (for Level 2) of college-preparatory mathematics (Students are not expected to have studied every topic on either test.)

### Recommended Preparation

#### Mathematics Level 1

- Three years of college-preparatory mathematics, including two years of algebra and one year of geometry

#### Mathematics Level 2

- More than three years of college-preparatory mathematics, including two years of algebra, one year of geometry, and elementary functions (precalculus) and/or trigonometry.
- If you have had preparation in trigonometry and elementary functions and have attained grades of B or better in these courses, select Level 2. If you are sufficiently prepared to take Level 2 but take Level 1 in hopes of receiving a higher score, you may not do as well as you expect.

### Score

- Total score: 200–to–800 scale.
- Because the content measured by the two tests differs considerably, you cannot use your score on one test to predict your score on the other or to compare scores.

CONTENT	Approximate % of Test	
	Level 1	Level 2
<b>Topics Covered*</b>		
<b>Number and Operations</b> operations, ratio & proportion, complex numbers, counting, elementary number theory, matrices, sequences, <i>series</i> , <i>vectors</i>	10–14	10–14
<b>Algebra and Functions</b> expressions, equations, inequalities, representation and modeling, properties of functions (linear, polynomial, rational, exponential, <i>logarithmic</i> , <i>trigonometric</i> , <i>inverse trigonometric</i> , <i>periodic</i> , <i>piecewise</i> , <i>recursive</i> , <i>parametric</i> )	38–42	48–52
<b>Geometry and Measurement</b>	38–42	28–32
<b>Plane Euclidean/Measurement</b>	18–22	-----
<b>Coordinate</b> lines, parabolas, circles, <i>ellipses</i> , <i>hyperbolas</i> , symmetry, transformations, <i>polar coordinates</i>	8–12	10–14
<b>Three-dimensional</b> solids, surface area & volume (cylinders, cones, pyramids, spheres, prisms), <i>coordinates in three dimensions</i>	4–6	4–6
<b>Trigonometry</b> right triangles, identities, <i>radian measure</i> , <i>law of cosines</i> , <i>law of sines</i> , <i>equations</i> , <i>double angle formulas</i>	6–8	12–16
<b>Data Analysis, Statistics, and Probability</b> mean, median, mode, range, interquartile range, <i>standard deviation</i> , graphs and plots, least-squares regression (linear, <i>quadratic</i> , <i>exponential</i> ), probability	6–10	6–10

\* *Topics in italics are tested on the Level 2 Test only. The content of Level 1 overlaps somewhat with that on Level 2, but the emphasis on Level 2 is on more advanced content. Plane Euclidean geometry is not tested directly on Level 2.*

### Geometric Figures

Figures that accompany problems are intended to provide information useful in solving the problems. They are drawn as accurately as possible EXCEPT when it is stated in a particular problem that the figure is not drawn to scale. Even when figures are not drawn to scale, the relative positions of points and angles may be assumed to be in the order shown. Also, line segments that extend through points and appear to lie on the same line may be assumed to be on the same line. The text “**Note:** Figure not drawn to scale.” is included on the figure when degree measures may not be accurately shown and specific lengths may not be drawn proportionally.

## Calculators

Some questions on these tests cannot be solved without a scientific or a graphing calculator. You do not need to use a calculator to solve every question, but it is important to know when and how to use one. If you take these tests without a calculator, you will be at a disadvantage.

- **We recommend the use of a graphing calculator over a scientific calculator because a graphing calculator may provide an advantage on some questions.**
- You may not use a calculator for other Subject Tests and must put it away when not taking a mathematics test.

For 50–60 percent of the questions on Level 1 and 35–45 percent of the questions on Level 2, there is no advantage, perhaps even a disadvantage, to using a calculator. For 40–50 percent of the questions on Level 1 and 55–65 percent of the questions on Level 2, a calculator may be useful or necessary.

### What Type of Calculator Should I Bring?

- Bring a calculator that you are used to using. It may be a scientific or a graphing calculator. If you're comfortable with both a scientific and a graphing calculator, bring a graphing calculator.
- Verify that your calculator is in good working condition before you take the test. You may bring batteries and a backup calculator to the test center.
- No substitute calculators or batteries will be available at the test center. Students may not share calculators.
- If your calculator malfunctions during the Level 1 or Level 2 Tests and you do not have a backup calculator, you must tell your test supervisor when the malfunction occurs in order to cancel scores on these tests only.

### The following are not permitted:

- Laptops and portable/handheld computers
- Electronic writing pads or pen-input/stylus-driven devices (e.g., Palm, PDAs, Casio ClassPad 300)
- Pocket organizers
- Models with QWERTY (i.e., typewriter) keypads (e.g., TI-92 Plus, Voyage 200)
- Models with paper tapes
- Models that make noise or “talk”
- Models that require an electrical outlet
- Cell phone calculators

## Using the Calculator

- Remember, only some questions on these tests require the use of a calculator. First decide how you will solve a problem; then determine whether the calculator is needed.
- Do not round any intermediate calculations. If you get a result from the calculator for the first step of a solution, keep the result in the calculator and use it for the second step. If you round the result from the first step, your answer may not be one of the choices.

## Sample Questions

All questions in the Mathematics Level 1 and Mathematics Level 2 Subject Tests are multiple-choice questions in which you are asked to choose the best response from the five choices offered. The directions for the tests are below:

**Directions:** For each of the following problems, decide which is the **BEST** of the choices given. If the exact numerical value is not one of the choices, select the choice that best approximates this value. Then fill in the corresponding circle on the answer sheet.

**Notes:** (1) A scientific or graphing calculator will be necessary for answering some (but not all) of the questions in this test. For each question you will have to decide whether or not you should use a calculator.

(2) Level 1: The only angle measure used on this test is degree measure. Make sure your calculator is in the degree mode.

Level 2: For some questions in this test you may have to decide whether your calculator should be in the radian mode or the degree mode.

(3) Figures that accompany problems in this test are intended to provide information useful in solving the problems. They are drawn as accurately as possible EXCEPT when it is stated in a specific problem that its figure is not drawn to scale. All figures lie in a plane unless otherwise indicated.

(4) Unless otherwise specified, the domain of any function  $f$  is assumed to be the set of all real numbers  $x$  for which  $f(x)$  is a real number. The range of  $f$  is assumed to be the set of all real numbers  $f(x)$ , where  $x$  is in the domain of  $f$ .

(5) Reference information that may be useful in answering the questions in this test can be found on the page preceding Question 1.



**Reference Information.** The following information is for your reference in answering some of the questions in this test.

Volume of a right circular cone with radius  $r$  and

$$\text{height } h: V = \frac{1}{3}\pi r^2 h$$

Lateral Area of a right circular cone with circumference

$$\text{of the base } c \text{ and slant height } \ell: S = \frac{1}{2}c\ell$$

$$\text{Volume of a sphere with radius } r: V = \frac{4}{3}\pi r^3$$

$$\text{Surface Area of a sphere with radius } r: S = 4\pi r^2$$

Volume of a pyramid with base area  $B$  and height  $h$ :

$$V = \frac{1}{3}Bh$$

## Mathematics Level 1

1. A band wants to distribute its music on compact discs (CDs). The equipment to produce the CDs costs \$250, and blank CDs cost \$5.90 for a package of 10. Which of the following represents the total cost, in dollars, to produce  $n$  CDs, where  $n$  is a multiple of 10?
- (A)  $(250 + 0.59)n$       (B)  $250 + 0.59n$   
 (C)  $(250 + 5.90)n$       (D)  $250 + 5.90n$   
 (E)  $250n + 5.90$

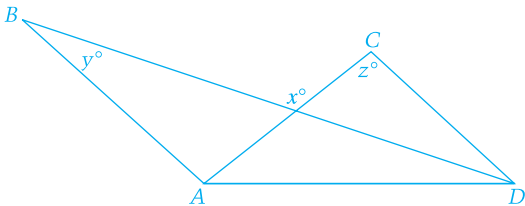

2. In the figure above,  $\overline{AB}$  and  $\overline{CD}$  are parallel. What is  $x$  in terms of  $y$  and  $z$ ?
- (A)  $y + z$   
 (B)  $2y + z$   
 (C)  $2y - z$   
 (D)  $180 - y - z$   
 (E)  $180 + y - z$

3. A number  $n$  is increased by 8. If the cube root of that result equals  $-0.5$ , what is the value of  $n$ ?
- (A)  $-15.625$   
 (B)  $-8.794$   
 (C)  $-8.125$   
 (D)  $-7.875$   
 (E)  $421.875$
4. If  $a$  and  $b$  are real numbers,  $i^2 = -1$ , and  $(a + b) + 5i = 9 + ai$ , what is the value of  $b$ ?
- (A) 4                      (B) 5                      (C) 9  
 (D)  $4 + 5i$               (E)  $5 + 4i$
5. What are all values of  $x$  for which  $4 - x^2 \geq x - 2$ ?
- (A)  $x \geq -3$       (B)  $-5 \leq x \leq 0$   
 (C)  $-3 \leq x \leq 2$       (D)  $x \leq -3$  or  $x \geq 2$   
 (E)  $-2 \leq x \leq 3$

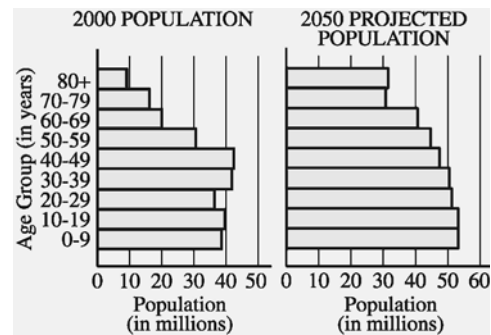

6. The graphs above show United States Census Bureau population figures for the year 2000 for various age groups, together with projections for the year 2050. Of the following age groups, for which is the projected percent increase in population from 2000 to 2050 greatest?
- (A) 30–39      (B) 40–49      (C) 50–59  
 (D) 60–69      (E) 70–79
7. If  $\log_c a = x$ , which of the following must be true?
- (A)  $a^c = x$       (B)  $a^x = c$       (C)  $c^a = x$   
 (D)  $c^x = a$       (E)  $x^c = a$

8. If  $f(x) = x + 3$  and  $g(x) = \frac{x^2 - 9}{x - 3}$ , which of the following statements are true about the graphs of  $f$  and  $g$  in the  $xy$ -plane?

- I. The graphs are exactly the same.
- II. The graphs are the same except when  $x = 3$ .
- III. The graphs have an infinite number of points in common.

- (A) I only      (B) II only      (C) III only  
(D) I and III      (E) II and III

9. If line  $\ell$  is the perpendicular bisector of the line segment with endpoints  $(2, 0)$  and  $(0, -2)$ , what is the slope of line  $\ell$ ?

- (A) 2      (B) 1      (C) 0  
(D) -1      (E) -2

10. Twenty students have each sampled one or more of three kinds of candy bars that a school store sells. If 3 students have sampled all three kinds, and 5 have sampled exactly two kinds, how many of these students have sampled only one kind?

- (A) 8      (B) 12      (C) 15  
(D) 17      (E) 18

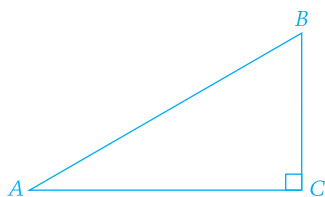

Note: Figure not drawn to scale.

11. In the figure above,  $\triangle ABC$  has a right angle at  $C$ . If the length of side  $\overline{AC}$  is 10 and the measure of  $\angle BAC$  is  $22^\circ$ , what is the length of side  $\overline{BC}$ ?

- (A) 3.7      (B) 4.0      (C) 5.8  
(D) 6.8      (E) 9.3

12. The function  $h$  given by  $h(t) = -16t^2 + 46t + 5$  represents the height of a ball, in feet,  $t$  seconds after it is thrown. To the nearest foot, what is the maximum height the ball reaches?

- (A) 5      (B) 23      (C) 35  
(D) 38      (E) 46

13. The front, side, and bottom faces of a rectangular solid have areas of 24 square centimeters, 8 square centimeters, and 3 square centimeters, respectively. What is the volume of the solid, in cubic centimeters?

- (A) 24      (B) 96      (C) 192  
(D) 288      (E) 576

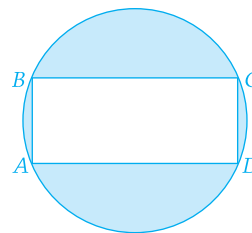

14. Rectangle  $ABCD$  is inscribed in the circle shown above. If the length of side  $\overline{AB}$  is 5 and the length of side  $\overline{BC}$  is 12, what is the area of the shaded region?

- (A) 40.8      (B) 53.1      (C) 72.7  
(D) 78.5      (E) 81.7

15. If  $f(x) = x^4 - 3x^3 - 9x^2 + 4$ , for how many real numbers  $k$  does  $f(k) = 2$ ?

- (A) None      (B) One      (C) Two  
(D) Three      (E) Four

16. If the measure of one angle of a rhombus is  $60^\circ$ , then the ratio of the length of its longer diagonal to the length of its shorter diagonal is

- (A) 2      (B)  $\sqrt{3}$       (C)  $\sqrt{2}$   
(D)  $\frac{\sqrt{3}}{2}$       (E)  $\frac{\sqrt{2}}{2}$

Time $t$ (years)	0	1	2	5
Value $v(t)$ (dollars)	15,000	13,000	10,900	3,000

17. When purchased, an automobile is valued at \$15,000. Its value depreciates at the rate shown in the table above. Based on a least-squares linear regression, what is the value, to the nearest hundred dollars, of the automobile when  $t = 4$ ?

- (A) \$5,400      (B) \$5,500      (C) \$5,600  
(D) \$6,400      (E) \$7,000

## Mathematics Level 2

18. What is the distance in space between the points with coordinates  $(-3, 6, 7)$  and  $(2, -1, 4)$ ?
- (A) 4.36      (B) 5.92      (C) 7.91  
(D) 9.11      (E) 22.25
19. If  $f(x) = \frac{3x+12}{2x-12}$ , what value does  $f(x)$  approach as  $x$  gets infinitely larger?
- (A)  $-6$       (B)  $-\frac{3}{2}$       (C)  $-1$   
(D)  $\frac{2}{3}$       (E)  $\frac{3}{2}$
20. In January 1990 the world's population was 5.3 billion. Assuming a growth rate of 2 percent per year, the world's population, in billions, for  $t$  years after 1990 can be modeled by the equation  $P = 5.3(1.02)^t$ . According to the model, the population growth from January 1995 to January 1996 was
- (A) 106,000,000  
(B) 114,700,000  
(C) 117,000,000  
(D) 445,600,000  
(E) 562,700,000
21. What is the measure of one of the larger angles of a parallelogram in the  $xy$ -plane that has vertices with coordinates  $(2, 1)$ ,  $(5, 1)$ ,  $(3, 5)$ , and  $(6, 5)$ ?
- (A)  $93.4^\circ$       (B)  $96.8^\circ$       (C)  $104.0^\circ$   
(D)  $108.3^\circ$       (E)  $119.0^\circ$
22. For some real number  $t$ , the first three terms of an arithmetic sequence are  $2t$ ,  $5t - 1$ , and  $6t + 2$ . What is the numerical value of the fourth term?
- (A) 4      (B) 8      (C) 10  
(D) 16      (E) 19
23. The diameter and height of a right circular cylinder are equal. If the volume of the cylinder is 2, what is the height of the cylinder?
- (A) 1.37      (B) 1.08      (C) 0.86  
(D) 0.80      (E) 0.68
24. If  $\sin \theta = 0.57$ , then  $\sin(\pi - \theta) =$
- (A)  $-0.57$       (B)  $-0.43$       (C) 0  
(D) 0.43      (E) 0.57
25. In a group of 10 people, 60 percent have brown eyes. Two people are to be selected at random from the group. What is the probability that neither person selected will have brown eyes?
- (A) 0.13      (B) 0.16      (C) 0.25  
(D) 0.36      (E) 0.64

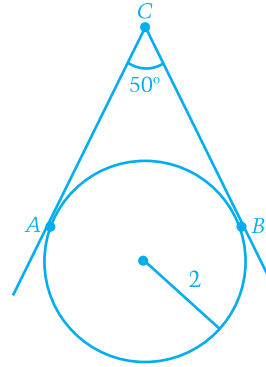

26. In the figure above, two lines are tangent to a circle of radius 2 at points A and B. What is the length of segment AB (not shown)?
- (A) 1.37      (B) 1.69      (C) 3.06  
(D) 3.63      (E) 4
27. If  $x - 2$  is a factor of  $x^3 + kx^2 + 12x - 8$ , then  $k =$
- (A)  $-6$       (B)  $-3$       (C) 2  
(D) 3      (E) 6
28. If  $f(x) = \sqrt[3]{x^3 + 1}$ , what is  $f^{-1}(1.5)$ ?
- (A) 3.4      (B) 2.4      (C) 1.6  
(D) 1.5      (E) 1.3

$x$	-9.8	-0.9	5.2	8.8
$y$	0.12	2.43	18.46	68.4

29. Which of the following equations best models the data in the table above?
- (A)  $y = -3.3(1.4)^x$   
(B)  $y = -1.4(3.3)^x$   
(C)  $y = 1.4(3.3)^x$   
(D)  $y = 3.3(1.4)^x$   
(E)  $y = 1.4x^{3.3}$

$$C = -1.02F + 93.63$$

30. The linear regression model above is based on an analysis of nutritional data from 14 varieties of cereal bars to relate the percent of calories from fat ( $F$ ) to the percent of calories from carbohydrates ( $C$ ). Based on this model, which of the following statements must be true?

- I. There is a positive correlation between  $C$  and  $F$ .
- II. When 20 percent of calories are from fat, the predicted percent of calories from carbohydrates is approximately 73.
- III. The slope indicates that as  $F$  increases by 1,  $C$  decreases by 1.02.

- (A) II only                      (B) I and II only
- (C) I and III only            (D) II and III only
- (E) I, II, and III

31. A line has parametric equations  $x = 5 + t$  and  $y = 7 + t$ , where  $t$  is the parameter. The slope of the line is

- (A)  $\frac{5}{7}$                       (B) 1                      (C)  $\frac{7+t}{5+t}$
- (D)  $\frac{7}{5}$                       (E) 7

32. What is the range of the function defined by

$$f(x) = \frac{1}{x} + 2?$$

- (A) All real numbers
- (B) All real numbers except  $-\frac{1}{2}$
- (C) All real numbers except 0
- (D) All real numbers except 2
- (E) All real numbers between 2 and 3

33. The number of hours of daylight,  $d$ , in Hartsville can be modeled by  $d = \frac{35}{3} + \frac{7}{3} \sin\left(\frac{2\pi}{365}t\right)$ , where  $t$  is the number of days after March 21. The day with the greatest number of hours of daylight has how many more daylight hours than May 1? (March and May have 31 days each. April and June have 30 days each.)

- (A) 0.8 hr            (B) 1.5 hr            (C) 2.3 hr
- (D) 3.0 hr            (E) 4.7 hr

	Day 1	Day 2	Day 3
Model X	20	18	3
Model Y	16	5	8
Model Z	19	11	10

34. The table above shows the number of digital cameras that were sold during a three-day sale. The prices of models X, Y, and Z were \$99, \$199, and \$299, respectively. Which of the following matrix representations gives the total income, in dollars, received from the sale of the cameras for each of the three days?

(A)  $\begin{bmatrix} 20 & 18 & 3 \\ 16 & 5 & 8 \\ 19 & 11 & 10 \end{bmatrix} \begin{bmatrix} 99 & 199 & 299 \end{bmatrix}$

(B)  $\begin{bmatrix} 20 & 18 & 3 \\ 16 & 5 & 8 \\ 19 & 11 & 10 \end{bmatrix} \begin{bmatrix} 99 \\ 199 \\ 299 \end{bmatrix}$

(C)  $\begin{bmatrix} 99 & 199 & 299 \end{bmatrix} \begin{bmatrix} 20 & 18 & 3 \\ 16 & 5 & 8 \\ 19 & 11 & 10 \end{bmatrix}$

(D)  $\begin{bmatrix} 99 \\ 199 \\ 299 \end{bmatrix} \begin{bmatrix} 20 & 18 & 3 \\ 16 & 5 & 8 \\ 19 & 11 & 10 \end{bmatrix}$

(E)  $99 \begin{bmatrix} 20 & 18 & 3 \\ 16 & 5 & 8 \\ 19 & 11 & 10 \end{bmatrix} + 199 \begin{bmatrix} 20 & 18 & 3 \\ 16 & 5 & 8 \\ 19 & 11 & 10 \end{bmatrix} + 299 \begin{bmatrix} 20 & 18 & 3 \\ 16 & 5 & 8 \\ 19 & 11 & 10 \end{bmatrix}$

## ANSWERS

The estimated difficulty level, on a scale of 1 to 5, with 1 the easiest and 5 the most difficult, is in parentheses.

### Mathematics Level 1

- 1. B (2)    5. C (3)    9. D (4)    13. A (4)    17. C (5)
- 2. A (2)    6. D (4)    10. B (3)    14. C (4)
- 3. C (2)    7. D (3)    11. B (3)    15. E (3)
- 4. A (3)    8. E (3)    12. D (4)    16. B (5)

### Mathematics Level 2

- 18. D (2)    22. E (4)    26. D (4)    30. D (4)    34. C (3)
- 19. E (2)    23. A (3)    27. A (2)    31. B (3)
- 20. C (4)    24. E (3)    28. E (4)    32. D (3)
- 21. C (4)    25. A (4)    29. D (4)    33. A (4)

# Biology-E/M

One-hour subject tests

## Purpose

- Measure knowledge of biology at a college-preparatory level with either an ecological emphasis (Biology-E) or a molecular emphasis (Biology-M)

## How to Choose Biology-E or Biology-M

- Take Biology-E if you feel more comfortable answering questions pertaining to biological communities, populations, and energy flow.
- Take Biology-M if you feel more comfortable answering questions pertaining to biochemistry, cellular structure and processes, such as respiration and photosynthesis.

You can decide whether you want to take Biology-E or Biology-M on test day by gridding the appropriate code for the test you have chosen on your answer sheet. **Only questions pertaining to the test code that is gridded on your answer sheet will be scored.**

NOTE: Because there is a common core of questions you are not allowed to take Biology-E and Biology-M on the same test date. You can take them on two different test dates.

## Format

- 60 multiple-choice questions that are common to both Biology-E and Biology-M
- 20 specialized multiple-choice questions for either Biology-E or Biology-M
- Total of 80 questions answered by each test-taker

Questions may require you to

- recall and understand the major concepts of biology and to apply the principles.
- organize and interpret results obtained by observation and experimentation.
- draw conclusions or make inferences from experimental data, including data presented in graphic or tabular form.
- solve problems with simple numerical calculations using the metric system.

NOTE: Calculator use is not permitted.

## Recommended Preparation

- One-year course in biology
- One-year course in algebra and familiarity with simple algebraic concepts such as ratios and direct and inverse proportions
- Laboratory experience

## Score

- Total score: 200–to–800 scale

CONTENT	Approximate % Test E	Approximate % Test M
Cellular and Molecular Biology <i>cell structure and organization, mitosis, photosynthesis, cellular respiration, enzymes, biosynthesis, biological chemistry</i>	15	27
Ecology <i>energy flow, nutrient cycles, populations, communities, ecosystems, biomes, conservation biology, biodiversity, effects of human intervention</i>	23	13
Genetics <i>meiosis, Mendelian genetics, inheritance patterns, molecular genetics, population genetics</i>	15	20
Organismal Biology <i>structure, function, and development of organisms (with emphasis on plants and animals), animal behavior</i>	25	25
Evolution and Diversity <i>origin of life, evidence of evolution, patterns of evolution, natural selection, speciation, classification and diversity of organisms</i>	22	15

BIOLOGY-E AND BIOLOGY-M	Approximate % of Test
<b>Skills Specifications</b>	
Knowledge of Fundamental Concepts <i>remembering specific facts; demonstrating straightforward knowledge of information and familiarity with terminology</i>	30
Application <i>understanding concepts and reformulating information into other equivalent forms; applying knowledge to unfamiliar and/or practical situations; solving problems using mathematical relationships</i>	35
Interpretation <i>inferring and deducing from qualitative and quantitative data and integrating information to form conclusions; recognizing unstated assumptions</i>	35



## Sample Questions

All of the questions in the test are multiple-choice questions for which you must choose the best response from the five choices offered. Some questions are grouped in sets that refer to a common figure, table, or laboratory experiment.

### Biology-E/M Core Section

**Directions:** Each set of lettered choices below refers to the numbered statements immediately following it. Select the one lettered choice that best fits each statement and then fill in the corresponding circle on the answer sheet. A choice may be used once, more than once, or not at all in each set.

#### Questions 1-2

- (A) Decomposers (e.g., bacteria)
- (B) Producers (e.g., grasses)
- (C) Primary consumers (e.g., mice)
- (D) Secondary consumers (e.g., snakes)
- (E) Tertiary consumers (e.g., hawks)

1. Organisms that comprise the greatest mass of living substance (biomass) in a terrestrial food chain
2. Organisms that convert nitrogen-containing organic molecules into nitrates

**Directions:** Each of the questions or incomplete statements below is followed by five suggested answers or completions. Select the one that is best in each case and then fill in the corresponding circle on the answer sheet.

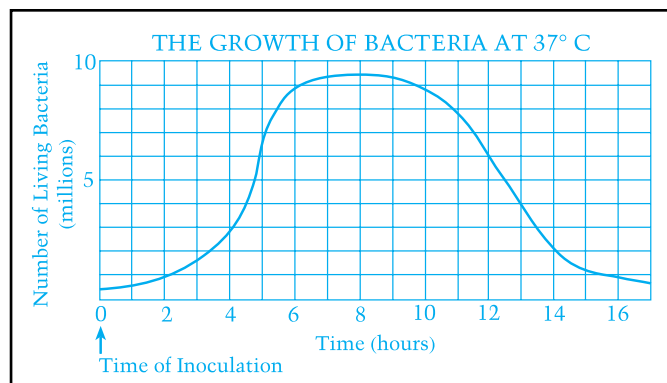

3. In the graph above, the time when the number of living bacteria is increasing at the greatest rate occurs
  - (A) during the first 2 hours
  - (B) between the 2nd and the 4th hour
  - (C) between the 4th and the 6th hour
  - (D) between the 6th and the 10th hour
  - (E) between the 11th and the 13th hour
4. ATP is produced during which of the following processes?
  - I. Photosynthesis
  - II. Aerobic respiration
  - III. Fermentation

(A) I only    (B) II only    (C) I and III only  
(D) II and III only    (E) I, II, and III
5. All of the following are population characteristics EXCEPT
  - (A) number of individuals
  - (B) phenotype
  - (C) sex ratio
  - (D) age distribution
  - (E) death rate
6. True statements about the development of the frog and mouse embryos include which of the following?
  - I. Both the frog and the mouse embryos develop in an aqueous environment.
  - II. Both the frog and the mouse embryos depend on a large supply of yolk to sustain the developing embryo.
  - III. Both the frog and the mouse embryos develop a 4-chambered heart.

(A) I only    (B) III only    (C) I and II only  
(D) II and III only    (E) I, II, and III

Questions 7-8 refer to the following diagram:

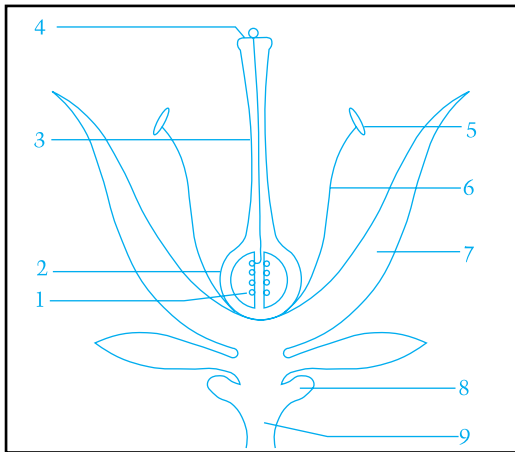

7. Commonly, the fruit is derived from  
 (A) 2 (B) 4 (C) 7  
 (D) 8 (E) 9
8. Pollination involves a transfer of pollen from  
 (A) 4 to 1 (B) 4 to 2 (C) 4 to 5  
 (D) 5 to 4 (E) 5 to 9

**Directions:** Each group of questions below concerns a laboratory or experimental situation. In each case, first study the description of the situation. Then choose the one best answer to each question following it and fill in the corresponding circle on the answer sheet.

**Questions 9-10**

In a breeding experiment using gray and white mice of unknown genotypes, the following results were obtained.

Cross	Parents		Offspring	
	Female	Male	Gray	White
I	Gray	x White	82	78
II	Gray	x Gray	118	39
III	White	x White	0	50
IV	Gray	x White	74	0

9. If the gray female from cross IV were mated with the gray male from cross II, then which of the following would most likely be true?  
 (A) All of the offspring would be gray.  
 (B) All of the offspring would be white.  
 (C) Half of the offspring would be gray.  
 (D) One-quarter of the offspring would be gray.  
 (E) One-quarter of the offspring would be white.

10. If two gray progeny of cross IV mate with each other, what is the probability that any one individual offspring will be gray?  
 (A) 100% (B) 75% (C) 50%  
 (D) 25% (E) 0

**Questions 11-12**

Three students added equal volumes of pond water to each of four beakers (I–IV) and placed each in a different constant temperature bath, maintained at 5°C, 15°C, 25°C, and 35°C, respectively. The students then added 6 water fleas, *Daphnia pulex*, to each of the four beakers and recorded the time in each case. After 1 hour, the students removed 3 *Daphnia pulex* from each beaker and each student immediately observed one *Daphnia pulex* under low-power magnification of a light microscope. (The transparent body of the *Daphnia pulex* can be seen easily under a light microscope.) Heart rates were recorded as beats per minute. The results of the experiment are summarized in the chart below.

BEAKER	TEMPERATURE	TIME DAPHNIA ADDED	TIME DAPHNIA REMOVED	HEARTBEATS PER MINUTE (average of 3 <i>Daphnia</i> )
I	5°C	2:00 p.m.	3:00 p.m.	41
II	15°C	2:10 p.m.	3:10 p.m.	119
III	25°C	2:20 p.m.	3:20 p.m.	202
IV	35°C	2:30 p.m.	3:30 p.m.	281

11. The independent variable in this experiment is the  
 (A) amount of light  
 (B) number of water fleas  
 (C) pH of the water  
 (D) temperature of the water  
 (E) average heart rate

12. If a graph is constructed using the data given in the table, it will most closely resemble which of the following?

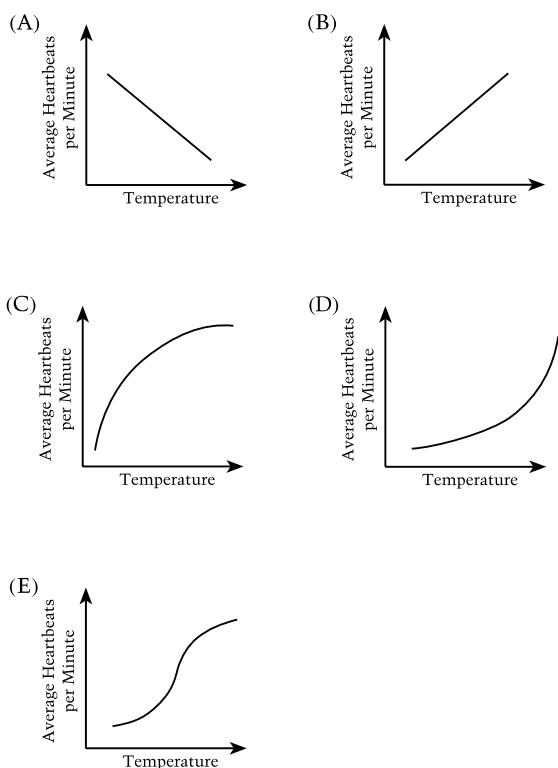

### Biology-E Section

13. Which of the following individuals is most fit in evolutionary terms?
- (A) A child who does not become infected with any of the usual childhood diseases, such as measles or chicken pox
  - (B) A woman of 40 with seven adult offspring
  - (C) A woman of 80 who has one adult offspring
  - (D) A 100-year old man with no offspring
  - (E) A childless man who can run a mile in less than five minutes

### Questions 14-15

Known numbers of seeds from two species ( $X$  and  $Y$ ) of annual plants are mixed together in different proportions and planted in five small plots of soil in the spring. The plants grow, flower, and produce seeds. It is found that the percentage of seeds of species  $X$  and species  $Y$  in the harvest is usually different from the proportion that was planted, although the total number of seeds produced is the same as the number of seeds planted. The data are plotted on the graph below.

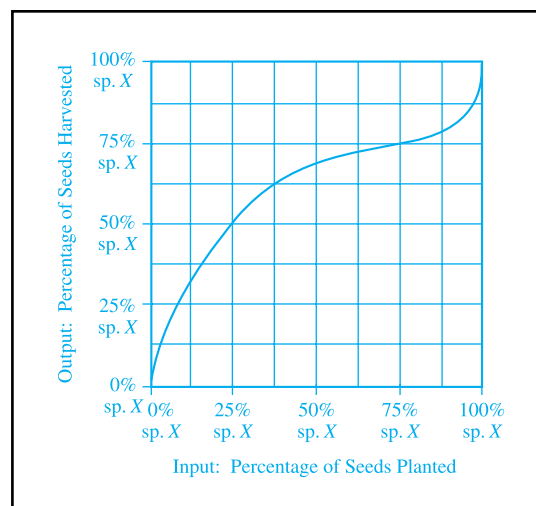

14. What mixture of seeds was harvested in the plot that was planted with 25 percent species  $X$  and 75 percent species  $Y$ ?

$X$	$Y$
(A) 25%	75%
(B) 40%	60%
(C) 50%	50%
(D) 60%	40%
(E) 75%	25%

15. What do the data indicate about the ecological relationship between species  $X$  and species  $Y$ ?

- (A)  $X$  and  $Y$  are mutualistic for low percentages of  $X$  seeds.
- (B)  $X$  and  $Y$  are mutualistic for high percentages of  $X$  seeds.
- (C)  $X$  and  $Y$  compete when both  $X$  and  $Y$  seeds are present.
- (D)  $Y$  competes successfully against  $X$  at all percentages of  $X$  and  $Y$  seeds.
- (E)  $X$  is parasite of  $Y$  when  $Y$  is rare.

## Biology-M Section

16. Which of the following most accurately reveals common ancestry among many different species of organisms?
- (A) The amino acid sequence of their cytochrome C
  - (B) Their ability to synthesize hemoglobin
  - (C) The percentage of their body weight that is fat
  - (D) The percentage of their body surface that is used in gas exchange
  - (E) The mechanism of their mode of locomotion
18. An appropriate control to show that this experiment measures DNA synthesis and not RNA synthesis would be to perform the same procedures but
- (A) not fertilize the eggs
  - (B) sample the embryos at longer time intervals
  - (C) add radioactive uracil instead of radioactive thymine
  - (D) fertilize the eggs in sea water that does not contain radioactive thymine
  - (E) count the number of cells in the embryos at the beginning and at the end of the experiment

### Questions 17-18

Thymine is used by animal cells primarily for the synthesis of DNA. A group of sea urchin eggs was fertilized in sea water containing radioactive thymine. Following fertilization, samples of embryos were removed at regular intervals and the radioactivity in the nucleic acid was measured in counts per minute. The results obtained are shown in the figure below.

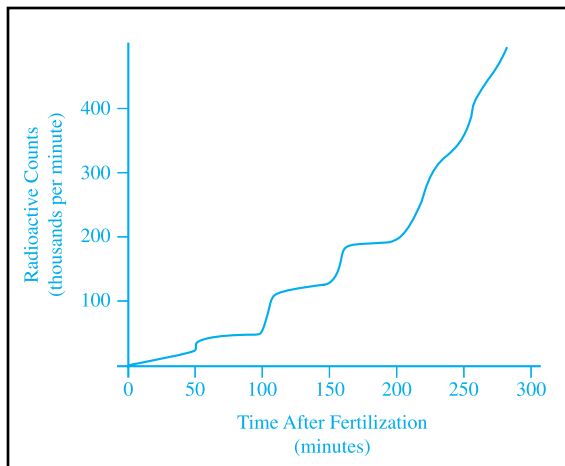

17. The increase in radioactivity of the embryos with time probably results from
- (A) synthesis of new proteins by the developing embryos
  - (B) synthesis of radioactive thymine by the developing embryos
  - (C) oxidation of radioactive thymine
  - (D) incorporation of radioactive thymine in new cell membranes
  - (E) incorporation of radioactive thymine in new DNA during replication

## ANSWERS

The estimated difficulty level, on a scale of 1 to 5, with 1 the easiest and 5 the most difficult, is in parentheses.

- |          |           |           |           |
|----------|-----------|-----------|-----------|
| 1. B (1) | 6. A (4)  | 11. D (3) | 16. A (2) |
| 2. A (3) | 7. A (1)  | 12. B (4) | 17. E (4) |
| 3. C (3) | 8. D (3)  | 13. B (3) | 18. C (3) |
| 4. E (2) | 9. A (4)  | 14. C (3) |           |
| 5. B (2) | 10. B (4) | 15. C (5) |           |

# Chemistry

One-hour subject test

## Purpose

- Measure understanding of chemistry at a level suitable for college preparation, independent of the particular textbook used or instructional approach

## Format

- 85 multiple-choice questions
- Approximately five questions on equation balancing and/or predicting products of chemical reactions, which are distributed among the various content categories

Questions cover topics emphasized in most high school courses. Because of course differences, most students will find that there are some questions on topics with which they are not familiar.

Questions may require you to

- recall and understand the major concepts of chemistry and to apply the principles to solve specific problems in chemistry.
- organize and interpret results obtained by observation and experimentation and to draw conclusions or make inferences from experimental data, including data presented in graphic and/or tabular form.

On this Subject Test,

- a periodic table indicating the atomic numbers and masses of elements is provided for all test administrations.
- problem solving requires simple numerical calculations.
- the metric system of units is used.

NOTE: Calculator use is not permitted.

## Recommended Preparation

- One-year introductory chemistry course at the college-preparatory level
- Laboratory experience, which is a significant factor in developing reasoning and problem-solving skills and should help in test preparation even though laboratory skills can be tested only in a limited way in a multiple-choice test

- Mathematics preparation that enables handling simple algebraic relationships and applying these to solving word problems
- Familiarity with the concepts of ratio and direct and inverse proportions, exponents, and scientific notation

## Score

- Total score: 200–to–800 scale

CONTENT	Approximate % of Test
<b>Topics Covered</b>	
<b>Structure of Matter</b> <b>Atomic Structure</b> , including experimental evidence of atomic structure, quantum numbers and energy levels (orbitals), electron configurations, periodic trends <b>Molecular Structure</b> , including Lewis structures, three-dimensional molecular shapes, polarity <b>Bonding</b> , including ionic, covalent, and metallic bonds, relationships of bonding to properties and structures; intermolecular forces such as hydrogen bonding, dipole-dipole forces, dispersion (London) forces	25
<b>States of Matter</b> <b>Gases</b> , including the kinetic molecular theory, gas law relationships, molar volumes, density, and stoichiometry <b>Liquids and Solids</b> , including intermolecular forces in liquids and solids, types of solids, phase changes, and phase diagrams <b>Solutions</b> , including molarity and percent by mass concentrations, solution preparation and stoichiometry, factors affecting solubility of solids, liquids, and gases, qualitative aspects of colligative properties	16
<b>Reaction Types</b> <b>Acids and Bases</b> , including Brønsted-Lowry theory, strong and weak acids and bases, pH, titrations, indicators <b>Oxidation-Reduction</b> , including recognition of oxidation-reduction reactions, combustion, oxidation numbers, use of activity series <b>Precipitation</b> , including basic solubility rules	14
<b>Stoichiometry</b> <b>Mole Concept</b> , including molar mass, Avogadro's number, empirical and molecular formulas <b>Chemical Equations</b> , including the balancing of equations, stoichiometric calculations, percent yield, and limiting reactants	14
<b>Equilibrium and Reaction Rates</b> <b>Equilibrium Systems</b> , including factors affecting position of equilibrium (LeChâtelier's principle) in gaseous and aqueous systems, equilibrium constants, and equilibrium expressions <b>Rates of Reactions</b> , including factors affecting reaction rates, potential energy diagrams, activation energies	5



CONTENT		Approximate % of Test
<b>Topics Covered</b>		
<b>Thermochemistry</b>		6
<i>Including conservation of energy, calorimetry and specific heats, enthalpy (heat) changes associated with phase changes and chemical reactions, heating and cooling curves, entropy</i>		
<b>Descriptive Chemistry</b>		12
<i>Including common elements, nomenclature of ions and compounds, periodic trends in chemical and physical properties of the elements, reactivity of elements and prediction of products of chemical reactions, examples of simple organic compounds and compounds of environmental concern</i>		
<b>Laboratory</b>		8
<i>Including knowledge of laboratory equipment, measurements, procedures, observations, safety, calculations, data analysis, interpretation of graphical data, drawing conclusions from observations and data</i>		

Skills Specifications		
<b>Recall of Knowledge</b>		20
<i>Remembering fundamental concepts and specific information; demonstrating familiarity with terminology</i>		
<b>Application of Knowledge</b>		45
<i>Applying a single principle to unfamiliar and/or practical situations to obtain a qualitative result or solve a quantitative problem</i>		
<b>Synthesis of Knowledge</b>		35
<i>Inferring and deducing from qualitative and/or quantitative data; integrating two or more relationships to draw conclusions or solve problems</i>		

## Sample Questions

Three types of questions are used in the Chemistry Subject Test: classification questions, relationship analysis questions, and five-choice completion questions. The directions that follow are identical to those that are in the test.

**Note:** For all questions involving solutions, assume that the solvent is water unless otherwise stated.

**Directions:** Each set of lettered choices below refers to the numbered statements or questions immediately following it. Select the one lettered choice that best fits each statement or answers each question and then fill in the corresponding circle on the answer sheet. A choice may be used once, more than once, or not at all in each set.

**Questions 1-3** refer to the following aqueous solutions.

- (A) 0.1 M HCl
- (B) 0.1 M NaCl
- (C) 0.1 M  $\text{HC}_2\text{H}_3\text{O}_2$
- (D) 0.1 M  $\text{CH}_3\text{OH}$
- (E) 0.1 M KOH

1. Is weakly acidic
2. Has the highest pH
3. Reacts with an equal volume of 0.05 M  $\text{Ba}(\text{OH})_2$  to form a solution with pH = 7

**Questions 4-6** refer to the following ionic species.

- (A)  $\text{X}^+$
- (B)  $\text{X}^{2+}$
- (C)  $\text{X}^{3+}$
- (D)  $\text{XO}_3^{2-}$
- (E)  $\text{XO}_4^{2-}$

4. A type of ion found in sodium acetate
5. A type of ion found in aluminum oxide
6. A type of ion found in potassium phosphate

**Questions 7-10** refer to the following atoms in the ground state.

- (A) Ar
- (B) O
- (C) S
- (D) Ti
- (E) U

7. Has the electron configuration  $1s^2 2s^2 2p^6 3s^2 3p^4$
8. Has the same number of electrons as  $\text{Ca}^{2+}$
9. Has electrons in *f* orbitals
10. Is the LEAST chemically reactive

On the actual Chemistry Test, the following type of question must be answered on a special section (labeled “Chemistry”) at the lower left-hand corner of your answer sheet. These questions will be numbered beginning with 101 and must be answered according to the following directions.

### Sample Answer Grid

\*Fill in circle CE (correct explanation) only if statement II is a correct explanation of the true statement I.

	I	II	CE*
101	<input type="radio"/> T <input type="radio"/> F	<input type="radio"/> T <input type="radio"/> F	<input type="radio"/> CE

**Directions:** Each question below consists of two statements, I in the left-hand column and II in the right-hand column. For each question, determine whether statement I is true or false and whether statement II is true or false and fill in the corresponding T or F circles on your answer sheet. \*Fill in circle CE only if statement II is a correct explanation of the true statement I.

I	BECAUSE	II
101. The rate at which sugar dissolves in water increases with stirring		stirring exposes the surface of a solute crystal to a less concentrated layer of solution.
102. Diamond has a high melting point		in a diamond crystal, the carbon atoms are held in place by ionic bonds.
103. Potassium has a lower first ionization energy than lithium has		potassium has more protons in its nucleus than lithium has.
104. Zinc metal will reduce $\text{Cu}^{2+}$ in solution		zinc is a more active metal than copper is.
$\text{HC}_2\text{H}_3\text{O}_2 + \text{H}_2\text{O} \rightleftharpoons \text{C}_2\text{H}_3\text{O}_2^- + \text{H}_3\text{O}^+$		
105. If some acetic acid, $\text{HC}_2\text{H}_3\text{O}_2$ , is added to the equilibrium mixture represented by the equation above, the concentration of $\text{H}_3\text{O}^+$ decreases		the equilibrium constant of a reaction changes as the concentration of the reactants changes.

On the actual Chemistry Test, the remaining questions must be answered by returning to the section of your answer sheet you started for the Chemistry Test.

**Directions:** Each of the questions or incomplete statements below is followed by five suggested answers or completions. Select the one that is best in each case and then fill in the corresponding circle on the answer sheet.

11. The hydrogen ion concentration of a solution prepared by diluting 50. mL of 0.10 M  $\text{HNO}_3(aq)$  with water to 500. mL of solution is
- (A) 0.0010 M (B) 0.0050 M (C) 0.010 M  
(D) 0.050 M (E) 1.0 M

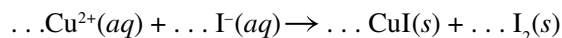

12. When the equation above is balanced and all coefficients are reduced to lowest whole-number terms, the coefficient for  $\text{I}^{-}(aq)$  is
- (A) 1 (B) 2 (C) 3  
(D) 4 (E) 5

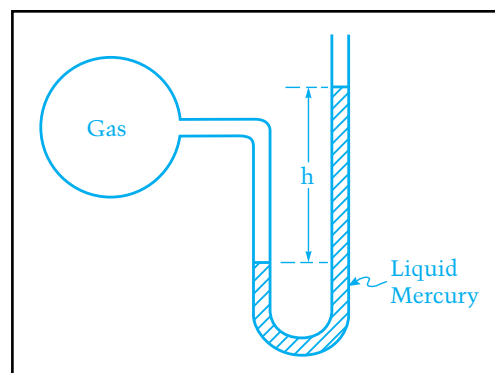

13. The bulb of the open-end manometer shown above contains a gas. True statements about this system include which of the following?
- I. Only atmospheric pressure is exerted on the exposed mercury surface in the right side of the tube.
- II. The gas pressure is greater than atmospheric pressure.
- III. The difference in the height,  $h$ , of mercury levels is equal to the pressure of the gas.
- (A) II only  
(B) III only  
(C) I and II only  
(D) I and III only  
(E) I, II, and III

14. A thermometer is placed in a test tube containing a melted pure substance. As slow cooling occurs, the thermometer is read at regular intervals until well after the sample has solidified. Which of the following types of graphs is obtained by plotting temperature *versus* time for this experiment?

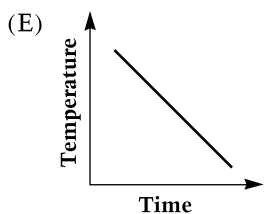
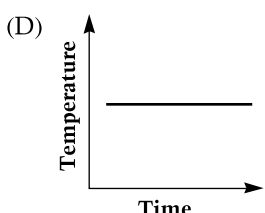
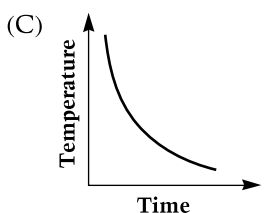
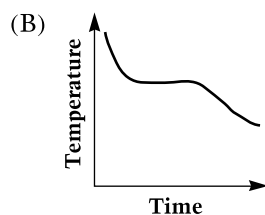
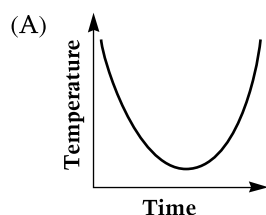

15. From their electron configurations, one can predict that the geometric configuration for which of the following molecules is NOT correct?

- (A)  $\text{PF}_3$  trigonal planar  
 (B)  $\text{CF}_4$  tetrahedral  
 (C)  $\text{CHCl}_3$  irregular tetrahedron  
 (D)  $\text{OF}_2$  bent (v-shaped)  
 (E)  $\text{HF}$  linear

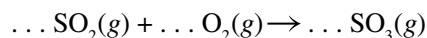

16. According to the reaction represented by the unbalanced equation above, how many moles of  $\text{SO}_2(g)$  are required to react completely with 1 mole of  $\text{O}_2(g)$ ?

- (A) 0.5 mol    (B) 1 mol    (C) 2 mol  
 (D) 3 mol    (E) 4 mol

17. Analysis by mass of a certain compound shows that it contains 14 percent hydrogen and 86 percent carbon. Which of the following is the most informative statement that can properly be made about the compound on the basis of these data?

- (A) It is a hydrocarbon.  
 (B) Its empirical formula is  $\text{CH}_2$ .  
 (C) Its molecular formula is  $\text{C}_2\text{H}_4$ .  
 (D) Its molar mass is 28 g/mol.  
 (E) It contains a triple bond.

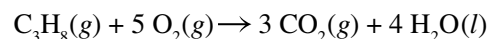

18. The combustion of propane,  $\text{C}_3\text{H}_8(g)$ , proceeds according to the equation above. How many grams of water will be formed in the complete combustion of 44.0 grams of propane?

- (A) 4.50 g    (B) 18.0 g    (C) 44.0 g  
 (D) 72.0 g    (E) 176 g

19. The number of oxygen atoms in 0.50 mole of  $\text{KHSO}_4$  is

- (A)  $1.2 \times 10^{23}$   
 (B)  $2.4 \times 10^{23}$   
 (C)  $3.0 \times 10^{23}$   
 (D)  $1.2 \times 10^{24}$   
 (E)  $2.4 \times 10^{24}$

20. All of the following statements about carbon dioxide are true EXCEPT:

- (A) It can be prepared by the action of acid on limestone.  
 (B) It is used to extinguish fires.  
 (C) It dissolves in water at room temperature.  
 (D) It sublimates rather than melts at  $20^\circ\text{C}$  and 1 atmosphere pressure.  
 (E) It is less dense than air at a given temperature and pressure.

21. For elements in the left-most column of the periodic table, properties that have increasing values as the atomic number increases include which of the following?
- Ionization energy (potential)
  - Atomic radius
  - Atomic mass
- (A) I only  
 (B) III only  
 (C) I and II only  
 (D) II and III only  
 (E) I, II, and III
22. All of the following can act as Brønsted-Lowry acids (proton donors) in aqueous solution EXCEPT
- (A) HI            (B)  $\text{NH}_4^+$         (C)  $\text{HCO}_3^-$   
 (D)  $\text{H}_2\text{S}$             (E)  $\text{NH}_3$
23. What is the minimum number of moles of  $\text{PbSO}_4$  that must be used to prepare 1 liter of saturated  $\text{PbSO}_4$  solution at  $25^\circ\text{C}$ ? ( $K_{sp}$  at  $25^\circ\text{C}$  for  $\text{PbSO}_4 = 1 \times 10^{-8}$ )
- (A)  $1 \times 10^{-16}$  mol  
 (B)  $1 \times 10^{-8}$  mol  
 (C)  $1 \times 10^{-4}$  mol  
 (D)  $1 \times 10^{-2}$  mol  
 (E)  $1 \times 10^{-1}$  mol

## ANSWERS

The estimated difficulty level, on a scale of 1 to 5, with 1 the easiest and 5 the most difficult, is in parentheses.

1. C (2)            5. C (1)            9. E (2)  
 2. E (3)            6. A (2)            10. A (2)  
 3. A (4)            7. C (3)  
 4. A (3)            8. A (3)

Questions 101–105: See box for difficulty level.

	I	II	CE <sup>+</sup>	Diff. Level
101	● (F)	● (F)	●	3
102	● (F)	⊕ (T)	○	3
103	● (F)	● (F)	○	3
104	● (F)	● (F)	●	4
105	⊕ (T)	⊕ (T)	○	5

11. C (3)            16. C (2)            21. D (3)  
 12. D (2)            17. B (3)            22. E (4)  
 13. C (4)            18. D (2)            23. C (5)  
 14. B (3)            19. D (1)  
 15. A (3)            20. E (3)

# Physics

One-hour subject test

## Purpose

- Measure understanding of physics at the college-preparatory level

## Format

- 75 multiple-choice questions
- Questions covering topics emphasized in most high school courses (Because of course differences, most students will find that there are some questions on topics with which they are not familiar.)

Questions may require you to

- recall and understand the major concepts of physics and to apply these physical principles to solve specific problems.
- understand simple algebraic, trigonometric, and graphical relationships and the concepts of ratio and proportion, and apply these to physics problems.

On this Subject Test,

- numerical calculations are not emphasized and are limited to simple arithmetic.
- questions predominantly use the metric system.
- you should assume that the direction of any current is the direction of flow of positive charge (conventional current).

NOTE: Calculator use is not permitted.

## Recommended Preparation

- One-year introductory physics course on the college-preparatory level
- Laboratory experience—a significant factor in developing reasoning and problem-solving skills—even though this test can only measure lab skills in a limited way, such as data analysis

## Score

- Total score: 200–to–800 scale

CONTENT	Approximate % of Test
<b>Skills Specification</b>	
Recall <i>generally involves remembering and understanding concepts or information</i>	20–33
Single-Concept Problem <i>recall and use of a single physical relationship</i>	40–53
Multiple-Concept Problem <i>recall and integration of two or more physical relationships</i>	20–33
<b>Laboratory Skills</b> <i>In each of the six major topics below, some questions may deal with laboratory skills in context.</i>	
<b>Topics Covered</b>	
<b>Mechanics</b> <b>Kinematics</b> , such as velocity, acceleration, motion in one dimension, and motion of projectiles <b>Dynamics</b> , such as force, Newton's laws, and statics <b>Energy and Momentum</b> , such as potential and kinetic energy, work, power, impulse, and conservation laws <b>Circular Motion</b> , such as uniform circular motion and centripetal force <b>Simple Harmonic Motion</b> , such as mass on a spring and the pendulum <b>Gravity</b> , such as the law of gravitation, orbits, and Kepler's laws	36–42
<b>Electricity and Magnetism</b> <b>Electric Fields, Forces, and Potentials</b> , such as Coulomb's law, induced charge, field and potential of groups of point charges, and charged particles in electric fields <b>Capacitance</b> , such as parallel-plate capacitors and transients <b>Circuit Elements and DC Circuits</b> , such as resistors, light bulbs, series and parallel networks, Ohm's law, and Joule's law <b>Magnetism</b> , such as permanent magnets, fields caused by currents, particles in magnetic fields, Faraday's law, and Lenz's law	18–24
<b>Waves and Optics</b> <b>General Wave Properties</b> , such as wave speed, frequency, wavelength, superposition, standing waves, and Doppler effect <b>Reflection and Refraction</b> , such as Snell's law and changes in wavelength and speed <b>Ray Optics</b> , such as image formation using pinholes, mirrors, and lenses <b>Physical Optics</b> , such as single-slit diffraction, double-slit interference, polarization, and color	15–19

Topics Covered (continued)	
Heat and Thermodynamics <b>Thermal Properties</b> , such as temperature, heat transfer, specific and latent heats, and thermal expansion <b>Laws of Thermodynamics</b> , such as first and second laws, internal energy, entropy, and heat engine efficiency	6–11
Modern Physics <b>Quantum Phenomena</b> , such as photons and photoelectric effect <b>Atomic</b> , such as the Rutherford and Bohr models, atomic energy levels, and atomic spectra <b>Nuclear and Particle Physics</b> , such as radioactivity, nuclear reactions, and fundamental particles <b>Relativity</b> , such as time dilation, length contraction, and mass-energy equivalence	6–11
Miscellaneous <b>General</b> , such as history of physics and general questions that overlap several major topics <b>Analytical Skills</b> , such as graphical analysis, measurement, and math skills <b>Contemporary Physics</b> , such as astrophysics, superconductivity, and chaos theory	4–9

## Sample Questions

Two types of questions are used in the Physics Subject Test and are shown in the following samples. The directions that follow are identical to those that are in the test. All questions in the test are multiple-choice questions in which you must choose the **BEST** response from the five choices offered.

## Part A

**Directions:** Each set of lettered choices below refers to the numbered questions immediately following it. Select the one lettered choice that best answers each question and then fill in the corresponding circle on the answer sheet. A choice may be used once, more than once, or not at all in each set.

### Questions 1-2

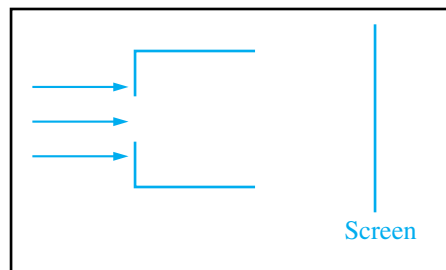

A beam of light is incident on a rectangular opening in the front of a box, as shown in the side view above. The back of the box is open. After passing through the box, the light is incident on a screen. The following devices may be in the box, positioned as shown below.

- (A) A convex lens      (B) A concave lens      (C) A thick sheet of glass

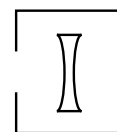
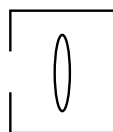

- (D) An opaque card with a very narrow slit      (E) A prism with vertex pointing downward

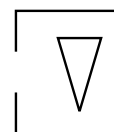
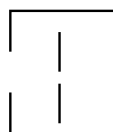

- Which device could produce a tiny spot of light on the screen?
- Which device could produce a diffraction pattern consisting of a central bright fringe with parallel secondary fringes that decrease in intensity with increasing distance from the center of the screen?



Questions 3-4 relate to a point charge  $+Q$  fixed in position, as shown below. Five points near the charge and in the plane of the page are shown.

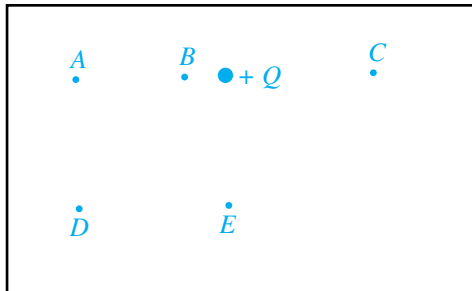

- At which point will the magnitude of the electric field be least?
- At which point will an electron experience a force directed toward the top of the page?

### Part B

**Directions:** Each of the questions or incomplete statements below is followed by five suggested answers or completions. Select the one that is best in each case and then fill in the corresponding circle on the answer sheet.

- When a vector of magnitude 6 units is added to a vector of magnitude 8 units, the magnitude of the resultant vector will be
  - exactly 2 units
  - exactly 10 units
  - exactly 14 units
  - 0 units, 10 units, or some value between them
  - 2 units, 14 units, or some value between them

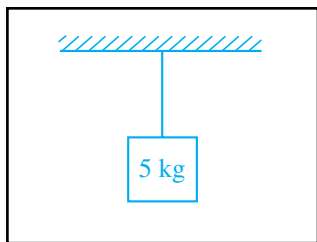

- A 5-kilogram block is suspended by a cord from the ceiling, as shown above. The force exerted on the block by the cord is most nearly
  - zero
  - 25 N
  - 50 N
  - 100 N
  - 200 N

### Questions 7-8

Ocean waves moving toward a beach have a speed of 10 meters per second and a frequency of 2 per second.

- The wavelength of the waves is most nearly
    - 0.2 m
    - 0.5 m
    - 5 m
    - 10 m
    - 20 m
  - The waves are observed by a child sitting in a rowboat offshore. Which of the following properties of the waves seen by the child would be greater when the boat is moving away from the beach than when the boat is stationary with respect to the beach?
    - Speed of the waves with respect to the boat
    - Frequency at which the boat encounters successive wave crests
    - Distance between adjacent wave crests
    - I only
    - III only
    - I and II only
    - II and III only
    - I, II, and III
- 
- An experiment is performed to measure the specific heat of copper. A lump of copper is heated in an oven, then dropped into a beaker of water. To calculate the specific heat of copper, the experimenter must know or measure the value of all of the quantities below EXCEPT the
    - mass of the water
    - original temperatures of the copper and the water
    - final (equilibrium) temperature of the copper and the water
    - time taken to achieve equilibrium after the copper is dropped into the water
    - specific heat of the water

10. Which of the following graphs best represents the kinetic energy  $K$  of an elementary particle as a function of its speed  $v$ , where  $c$  is the speed of light?

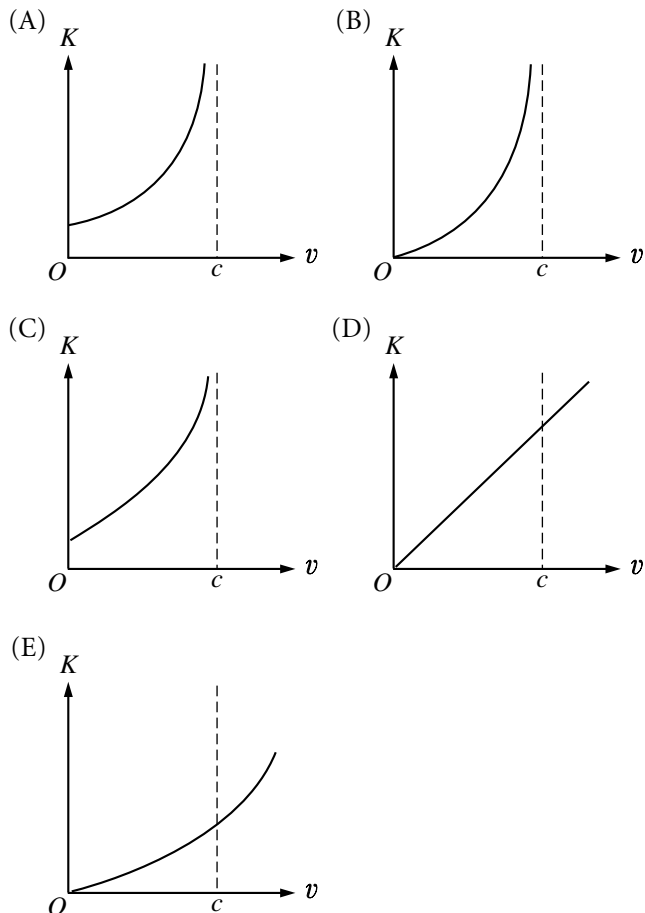

11. In a given process, 12 joules of heat is added to an ideal gas and the gas does 8 joules of work. Which of the following is true about the internal energy of the gas during this process?

- (A) It has increased by 20 joules.  
 (B) It has increased by 4 joules.  
 (C) It has not changed.  
 (D) It has decreased by 4 joules.  
 (E) It has decreased by 20 joules.

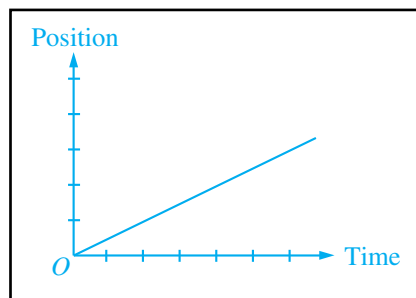

12. The graph of position *versus* time for an object moving along a straight line is given above. During the time shown on the graph, the speed and acceleration of the object will have which of the following characteristics?

- | <u>SPEED</u>              | <u>ACCELERATION</u>   |
|---------------------------|-----------------------|
| (A) Increasing            | Increasing            |
| (B) Increasing            | Constant but not zero |
| (C) Constant but not zero | Increasing            |
| (D) Constant but not zero | Zero                  |
| (E) Zero                  | Constant but not zero |

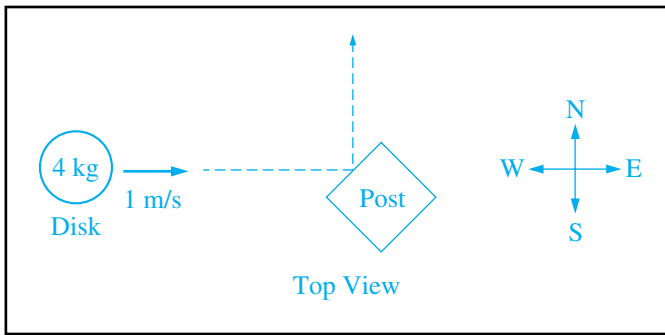

13. A 4-kilogram disk slides over level ice toward the east at a velocity of 1 meter per second, as shown above. The disk strikes a post and rebounds toward the north at the same speed. The change in the magnitude of the eastward component of the momentum of the disk is
- (A)  $-4 \text{ kg} \cdot \text{m/s}$   
 (B)  $-1 \text{ kg} \cdot \text{m/s}$   
 (C)  $0 \text{ kg} \cdot \text{m/s}$   
 (D)  $1 \text{ kg} \cdot \text{m/s}$   
 (E)  $4 \text{ kg} \cdot \text{m/s}$

$n$	Energy Above Ground State
3	7 eV
2	4 eV
1	0 eV

14. Three energy levels of an atom are shown above. Atoms in the  $n = 2$  state can spontaneously emit photons having which of the following energies?
- (A) 4 eV only  
 (B) 7 eV only  
 (C) 3 eV and 4 eV only  
 (D) 3 eV and 7 eV only  
 (E) 3 eV, 4 eV, and 7 eV

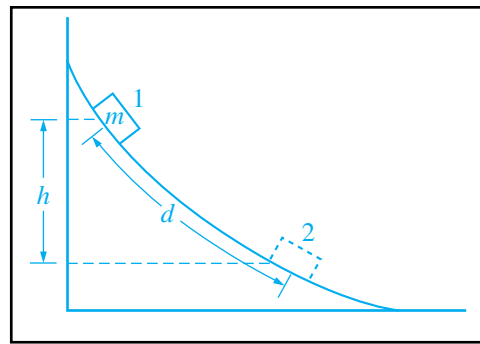

15. A box of mass  $m$  is released from rest at position 1 on the frictionless curved track shown above. It slides a distance  $d$  along the track in time  $t$  to reach position 2, dropping a vertical distance  $h$ . Let  $v$  and  $a$  be the instantaneous speed and instantaneous acceleration, respectively, of the box at position 2. Which of the following equations is valid for this situation?
- (A)  $h = vt$       (B)  $h = \frac{1}{2}gt^2$       (C)  $d = \frac{1}{2}at^2$   
 (D)  $v^2 = 2ad$       (E)  $mgh = \frac{1}{2}mv^2$

Questions 16-17 relate to the following circuit.

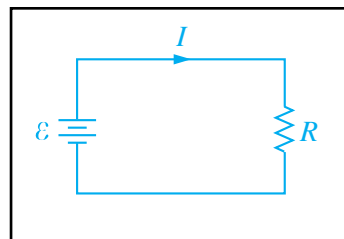

A single resistor  $R$  is connected to a battery as shown above. The current is  $I$  and the power dissipated as heat is  $P$ . The circuit is changed by doubling the emf  $\mathcal{E}$  of the battery while  $R$  is kept constant.

16. After the change, the current is
- (A)  $\frac{I}{4}$       (B)  $\frac{I}{2}$       (C)  $I$   
 (D)  $2I$       (E)  $4I$
17. After the change, the power dissipated in  $R$  is
- (A)  $\frac{P}{4}$       (B)  $\frac{P}{2}$       (C)  $P$   
 (D)  $2P$       (E)  $4P$

18. Which of the following is true of the magnetic field produced by a current in a long, straight wire?
- (A) The field is uniform.
  - (B) The field increases in strength as the distance from the wire increases.
  - (C) The field lines are directed parallel to the wire, but opposite to the direction of the current.
  - (D) The field lines are directed radially outward from the wire.
  - (E) The field lines form circles about the wire.
19. Which of the following may transmit energy from one point to another?
- I. Electromagnetic radiation
  - II. Sound waves
  - III. Convection currents
- (A) I only
  - (B) III only
  - (C) I and II only
  - (D) II and III only
  - (E) I, II, and III
20. The Earth has a radius of 6,400 kilometers. A satellite orbits the Earth at a distance of 12,800 kilometers from the center of the Earth. If the weight of the satellite on Earth is 100 kilonewtons, the gravitational force on the satellite in orbit is
- (A) 11 kilonewtons
  - (B) 25 kilonewtons
  - (C) 50 kilonewtons
  - (D) 100 kilonewtons
  - (E) 200 kilonewtons
21. A pendulum of length  $\ell$  with a bob of mass  $m$  is oscillating with small amplitude. Which of the following changes in the pendulum would double its period?
- (A) Doubling the mass  $m$  of the bob
  - (B) Doubling the initial force used to set the pendulum in motion
  - (C) Doubling the amplitude of the pendulum's swing
  - (D) Quadrupling the mass  $m$  of the bob
  - (E) Quadrupling the length  $\ell$  of the pendulum

### Questions 22-23

A piece of chalk is thrown vertically upward and caught during its descent at the same height from which it was thrown. Position is measured from the location of the chalk when it left the hand. The positive direction for position, velocity, and acceleration is upward.

22. What are the signs of the position, velocity, and acceleration during the ascending part of the trajectory?

	<u>POSITION</u>	<u>VELOCITY</u>	<u>ACCELERATION</u>
(A)	Positive	Positive	Positive
(B)	Positive	Positive	Negative
(C)	Positive	Negative	Negative
(D)	Negative	Positive	Negative
(E)	Negative	Negative	Negative

23. What are the signs of the position, velocity, and acceleration during the descending part of the trajectory?

	<u>POSITION</u>	<u>VELOCITY</u>	<u>ACCELERATION</u>
(A)	Positive	Positive	Positive
(B)	Positive	Positive	Negative
(C)	Positive	Negative	Negative
(D)	Negative	Positive	Negative
(E)	Negative	Negative	Negative

### ANSWERS

The estimated difficulty level, on a scale of 1 to 5, with 1 the easiest and 5 the most difficult, is in parentheses.

1. A (3)	7. C (1)	13. A (4)	19. E (4)
2. D (3)	8. C (3)	14. A (4)	20. B (5)
3. D (1)	9. D (3)	15. E (4)	21. E (4)
4. E (2)	10. B (2)	16. D (3)	22. B (4)
5. E (2)	11. B (3)	17. E (5)	23. C (5)
6. C (1)	12. D (2)	18. E (3)	

# Chinese with Listening

One-hour subject test

## Purpose

- Measure understanding of Mandarin Chinese in the context of contemporary Chinese culture

## Format

- 20 minutes of listening and 40 minutes of usage and reading
- 85 multiple-choice questions in three sections
- Only offered in November at designated test centers

You must bring an acceptable CD player with earphones. See page 5.

## Content

The test evaluates ability in three areas:

**Listening Comprehension:** These questions test the ability to understand the spoken language and are based on short, spoken dialogues and narratives primarily about everyday topics. There are two different kinds of listening comprehension questions: (A) a spoken statement, question, or exchange, followed by a choice of three possible responses (also spoken); (B) a spoken dialogue or monologue with a printed question or questions (in English) about what was said.

**Usage:** These questions ask you to select the answer that best completes a Chinese sentence in a way that is structurally and logically correct. Questions are written to reflect instructional practices of the curriculum. This section of the test is therefore presented in four columns across two pages of the test book to allow each question and its answer choices to be shown in four different ways of representing Chinese: traditional and simplified Chinese characters on the left page, and phonetic transcriptions in Pinyin romanization and the Chinese phonetic alphabet (Bopomofo) on the right page. You should choose the writing form with which you are most familiar and read only from that column.

**Reading Comprehension:** Reading comprehension questions test your understanding of such points as main and supporting ideas, themes, and the setting of passages. Some of the passages are based on real-life materials such as timetables, forms, advertisements, notes, letters, diaries, and newspaper articles.

All passages are written in both traditional and simplified Chinese characters. Most questions deal with understanding of literal meaning although some inference questions may be included. All reading comprehension questions are in English.

## Recommended Preparation

- Study of Chinese as a second language for two to four years in high school, or the equivalent
- Gradual development of competence in Chinese over a period of years
- Review of sample listening questions using the practice CD available from your school counselor

## Score

- Total score: 200–to–800 scale
- Listening, usage, and reading subscores: 20–to–80 scale

CONTENT	Approximate % of Test
<b>Skills Measured</b>	
Listening comprehension	33
Usage	33
Reading comprehension	33

## Sample Listening Questions

All questions in the test are multiple choice. You must choose the **BEST** response from the three or four choices offered for each question.

When the test is administered, all spoken Chinese will be presented by CD playback. All text appearing here in square brackets [ ] is spoken.

### Part A

**(Narrator): [Directions:** In this part of the test you will hear short questions, statements, or commands in Mandarin Chinese, followed by three responses in Mandarin Chinese, designated (A), (B), and (C). You will hear the questions or statements, as well as the responses, just one time, and they are not printed in your test booklet. Therefore you must listen very carefully. Select the best response and fill in the corresponding circle on your answer sheet.]

#### Question 1

**(Narrator)** [ Number 1.

**(Man)** 今天天氣怎麼樣？

- (Woman)** (A) 我很好，謝謝。  
(B) 星期天不行。  
(C) 可能會很冷。 ] (5 seconds)

#### Question 2

**(Narrator)** [ Number 2.

**(Man)** 我馬上就要畢業了。

- (Woman)** (A) 恭喜你。  
(B) 太客氣。  
(C) 也好看。 ] (5 seconds)

#### Question 3

**(Narrator)** [ Number 3.

**(Man)** 這本書貴不貴？

**(Woman)** 不貴，也不便宜。

- (Man)** (A) 多久了？  
(B) 多少錢？  
(C) 多不多？ ] (5 seconds)

#### Question 4

**(Narrator)** [ Number 4.

**(Woman)** 我們今天應該用鉛筆還是用鋼筆？

**(Man)** 用鉛筆。你帶來了嗎？

- (Woman)** (A) 鋼筆比鉛筆貴。  
(B) 這枝毛筆很好用。  
(C) 兩種筆我都帶了。 ] (5 seconds)

### Part B

**(Narrator): [Directions:** You will now hear a series of short selections. You will hear them only once and they are not printed in your test booklet. After each selection, you will be asked to answer one or more questions about what you have just heard. These questions, each with four possible answers, are printed in your test booklet. Select the best answer to each question from among the four choices given and fill in the corresponding circle on your answer sheet. You will have 15 seconds to answer each question.]

#### Questions 5-6

**(Narrator)** [ Questions 5 and 6. Listen to find out what the woman will do next summer.

**(Woman)** 你去過香港嗎？

**(Man)** 沒去過，可是我明年夏天從日本到中國去的時候會經過香港。

**(Woman)** 明年夏天，我得留在美國上暑期班，哪兒都不能去。

**(Narrator)** Now answer questions 5 and 6. ] (30 seconds)

5. Where will the woman spend the summer next year?
- (A) In China  
(B) In Japan  
(C) In Hong Kong  
(D) In the United States
6. What will the woman do?
- (A) Visit friends  
(B) Go to school  
(C) Look for a job  
(D) Travel abroad



## Question 7

(Narrator) [ Question 7. Listen to find out what the tour guide is telling the group of tourists.

(Woman) 請大家注意: 友誼商店到了, 現在是十點鐘, 不要忘了我們十一點鐘在這兒上車, 去美術館。

(Narrator) Now answer question 7. ] (15 seconds)

7. What will the tourists most likely do after the announcement?
- (A) Claim their luggage
  - (B) Go shopping
  - (C) Call a taxi
  - (D) Leave the art museum

## Sample Reading Questions

### Questions 8-9

老王:

李平剛才打電話來說他病了, 今天不能來上課。請你幫他代課。

小陳

老王:

李平剛才打電話來說他病了, 今天不能來上課。請你幫他代課。

小陳

8. This note tells us that
- (A) Wang is a teacher and Li is a student
  - (B) Wang is a teacher and Chen is a student
  - (C) Wang and Li are both teachers
  - (D) Li and Chen are both students
9. Who called in sick?
- (A) Wang
  - (B) Chen
  - (C) Lin
  - (D) Li

### Questions 10-11

亞洲航空公司四月五日宣佈, 因暑期旅客增多, 所以計劃增加飛往美國各大城市的班機。將於今年六月十五日至八月二十日之間, 每逢星期一、二、四、五、六增加班機往返紐約、香港。每週五次。

亞洲航空公司四月五日宣布, 因暑期旅客增多, 所以计划增加飞往美国各大城市的班机。將於今年六月十五日至八月二十日之间, 每逢星期一、二、四、五、六增加班机往返纽约、香港。每周五次。

10. This advertisement is announcing a temporary offer of
- (A) additional destinations
  - (B) lower fares
  - (C) special discounts
  - (D) additional flights
11. When does this offer become effective?
- (A) August 20
  - (B) June 15
  - (C) April 5
  - (D) February 1

## Sample Usage Questions

**Directions:** This section consists of a number of incomplete statements, each of which has four possible completions. Select the word or phrase that best completes the sentence structurally and logically and fill in the corresponding circle on your answer sheet.

This section of the test is presented in four columns across two pages to allow each item to be shown in four different ways of representing Chinese: traditional characters, simplified characters, pinyin romanization, and the Chinese phonetic alphabet (Bopomofo). TO SAVE TIME, IT IS RECOMMENDED THAT YOU CHOOSE THE WRITING FORM WITH WHICH YOU ARE MOST FAMILIAR AND READ ONLY FROM THAT COLUMN AS YOU WORK THROUGH THIS SECTION OF THE TEST.

12. 我很喜歡這部電影。

你 \_\_\_\_\_?

- (A) 啊
- (B) 嗎
- (C) 吧
- (D) 呢

12. 我很喜欢这部电影。

你 \_\_\_\_\_?

- (A) 啊
- (B) 吗
- (C) 吧
- (D) 呢

13. 我從來沒吃 \_\_\_\_\_

這麼好吃的菜。

- (A) 得
- (B) 過
- (C) 給
- (D) 成

13. 我从来没吃 \_\_\_\_\_

这么好吃的菜。

- (A) 得
- (B) 过
- (C) 给
- (D) 成

14. \_\_\_\_\_ 我哥哥比我大五歲，

\_\_\_\_\_ 我比哥哥高得多。

- (A) 雖然 ..... 可是
- (B) 因為 ..... 所以
- (C) 既然 ..... 就
- (D) 就是 ..... 也

14. \_\_\_\_\_ 我哥哥比我大五岁，

\_\_\_\_\_ 我比哥哥高得多。

- (A) 虽然 ..... 可是
- (B) 因为 ..... 所以
- (C) 既然 ..... 就
- (D) 就是 ..... 也

15. 星期天我要在家休息，

\_\_\_\_\_。

- (A) 不去都哪兒
- (B) 都哪兒不去
- (C) 不去哪兒都
- (D) 哪兒都不去

15. 星期天我要在家休息，

\_\_\_\_\_。

- (A) 不去都哪儿
- (B) 都哪儿不去
- (C) 不去哪儿都
- (D) 哪儿都不去

12. Wǒ hěn xǐhuan zhèi bù diànyǐng.

Nǐ \_\_\_\_\_ ?

- (A) a
- (B) ma
- (C) ba
- (D) ne

12. 我很喜欢这部电影。  
你 \_\_\_\_\_

- (A) 呀
- (B) 哪
- (C) 呢
- (D) 吧

13. Wǒ cónglái méi chī \_\_\_\_\_

zhème hǎochī de cài.

- (A) de
- (B) guo
- (C) gěi
- (D) chéng

13. 我从来都没吃  
过这么好的菜。

- (A) 过
- (B) 给
- (C) 成
- (D) 呢

14. \_\_\_\_\_ wǒ gēge bǐ wǒ dà wǔ suì,

\_\_\_\_\_ wǒ bǐ gēge gāo de duō.

- (A) Suǐrán ..... kěshì
- (B) Yīnwei ..... suǒyǐ
- (C) Jīrán ..... jiù
- (D) Jiùshì ..... yě

14. \_\_\_\_\_ 我哥哥比我大五岁，  
\_\_\_\_\_ 我比哥哥高得多。

- (A) 虽然 ..... 可是
- (B) 因为 ..... 所以
- (C) 既然 ..... 就
- (D) 即使 ..... 也

15. Xīngqītiān wǒ yào zài jiā xiūxi,

\_\_\_\_\_ .

- (A) bú qù dōu nǎr
- (B) dōu nǎr bú qù
- (C) bú qù nǎr dōu
- (D) nǎr dōu bú qù

15. 星期天我要在家休息，  
\_\_\_\_\_ 。

- (A) 哪儿都不去
- (B) 哪儿都不去
- (C) 哪儿都不去
- (D) 哪儿都不去

## ANSWERS

The estimated difficulty level, on a scale of 1 to 5, with 1 the easiest and 5 the most difficult, is in parentheses.

- |          |          |           |           |
|----------|----------|-----------|-----------|
| 1. C (2) | 5. D (3) | 9. D (3)  | 13. B (2) |
| 2. A (2) | 6. B (4) | 10. D (5) | 14. A (3) |
| 3. B (1) | 7. B (3) | 11. B (4) | 15. D (4) |
| 4. C (3) | 8. C (4) | 12. D (1) |           |

# French and French with Listening

One-hour subject tests

## Purpose

### French Test

- Evaluate reading skills through precision of vocabulary structure use and comprehension of a variety of texts

### French Test with Listening

- Evaluate reading skills and measure the ability to understand spoken French

## Format

### French Test

- 85 multiple-choice questions
- Offered at all administrations except November

### French Test with Listening

- 20 minutes of listening and 40 minutes of reading
- 85–90 multiple-choice listening and reading questions
- Only offered in November at designated test centers

You must bring an acceptable CD player with headphones. See page 5.

## Content

The tests evaluate reading ability in three areas:

**Precision of Vocabulary:** These questions test knowledge of words representing different parts of speech and some basic idioms within culturally authentic contexts.

**Structure:** These questions measure the ability to select an appropriate word or expression that is grammatically correct within a sentence. One part of the test contains vocabulary and structure questions embedded in longer paragraphs.

**Reading Comprehension:** These questions test understanding of such points as main and supporting ideas, themes, and setting of a passage. Selections are drawn from fiction, essays, historical works, and newspaper articles or everyday materials such as advertisements, timetables, forms, and tickets.

The listening test also measures the ability to understand spoken language with three types of *listening* questions:

**Type One:** Identify the sentence that most accurately describes what is presented in a picture or photograph.

**Type Two:** Answer general content questions based on short dialogues or monologues.

**Type Three:** Answer more specific questions based on longer dialogues or monologues.

## Recommended Preparation

Both tests reflect general trends in high school curricula and are independent of particular textbooks or methods of instruction. Recommended preparation includes:

- 3–4 years study in high school or the equivalent, or
- 2 years of strong preparation
- Gradual development of competence in French over a period of years

### French Test with Listening

- Review of sample listening questions using the practice CD available from your school counselor

## Score

- Total score: 200–to–800 scale
- Listening test: reading and listening subscores 20–to–80 scale

FRENCH	Approximate % of Test
<b>Skills Measured</b>	
Vocabulary in context	30
Structure	30–40
Reading comprehension	30–40

FRENCH with LISTENING	Approximate % of Test
<b>Listening Section (20 minutes)</b>	35
Pictures	8–12 questions
Short dialogues	6–12 questions
Long dialogues	10–15 questions
<b>Reading Section (40 minutes)</b>	65
Vocabulary	16–20 questions
Structure	16–20 questions
Reading comprehension	20–25 questions

## Sample Reading Questions

Four types of reading questions are used in the French Subject Tests. All questions in the tests are multiple-choice questions in which you must choose the **BEST** response from the four choices offered.

### Part A

**Directions:** This part consists of a number of incomplete statements, each having four suggested completions. Select the most appropriate completion and fill in the corresponding circle on the answer sheet.

1. Pourquoi es-tu debout si...puisque tu dois te lever de bonne heure?  
(A) tard (B) loin (C) peu (D) haut
2. Je ne pleure pas! J'ai quelque chose dans...  
(A) l'oeuvre (B) l'outil (C) l'oreiller (D) l'oeil
3. Les diplomates ont négocié un...entre les deux pays.  
(A) traitement (B) accord  
(C) agrément (D) concombre

### Part B

**Directions:** Each of the following sentences contains a blank. From the four choices given, select the one that can be inserted in the blank to form a grammatically correct sentence and fill in the corresponding circle on the answer sheet. Choice (A) may consist of dashes that indicate that no insertion is required to form a grammatically correct sentence.

4. À cette occasion Jean-Louis a mis ----- plus belle chemise et une jolie cravate neuve.  
(A) sa (B) son (C) ses (D) sienne
5. Si tu faisais du jogging tous les jours, est-ce que tu te ----- mieux?  
(A) sentiras (B) sentirais (C) sentais (D) sens
6. Je ne me rappelle plus ce que je ----- quand on m'a interrompu.  
(A) ferais (B) fasse (C) faisais (D) fais

7. — ----- est sur la table?  
— C'est le vin que ta mère a commandé.  
(A) Quoi (B) Qu'est-ce qu'  
(C) Quel (D) Qu'est-ce qui

### Part C

**Directions:** The paragraphs below contain blank spaces indicating omissions in the text. For some blanks it is necessary to choose the completion that is most appropriate to the meaning of the passage; for other blanks, to choose the one completion that forms a grammatically correct sentence. In some instances, choice (A) may consist of dashes that indicate that no insertion is required to form a grammatically correct sentence. In each case, indicate your answer by filling in the corresponding circle on the answer sheet. Be sure to read the paragraph completely before answering the questions related to it.

Selon (8), les Français célèbrent les fêtes de fin d'année en (9) un bon nombre d'huîtres et d'autres (10) de mer. Ils offrent de petits cadeaux à (11) envers qui ils sont (12). Et ils envoient des (13) de voeux à (14) amis et collègues.

8. (A) la coutume  
(B) l'utilisation  
(C) l'habit  
(D) le temps
9. (A) consommant  
(B) consommé  
(C) avoir consommé  
(D) consommer
10. (A) légumes  
(B) fleurs  
(C) poisons  
(D) fruits
11. (A) ceux  
(B) lesquels  
(C) quels  
(D) leurs

12. (A) indifférents  
(B) repentants  
(C) prudents  
(D) reconnaissants
13. (A) cartons  
(B) photos  
(C) cartes  
(D) feuilles
14. (A) ses  
(B) tous  
(C) leurs  
(D) mes

## Part D

**Directions:** Read the following selections carefully for comprehension. Each selection is followed by a number of questions or incomplete statements. Select the completion or answer that is **BEST** according to the selection and fill in the corresponding circle on the answer sheet.

- Alors, que dire des contes qu'invente aujourd'hui la publicité? On dénonce l'artifice et les conventions des messages publicitaires. Mais quand on demande à des enfants de choisir entre divers scénarios ou types d'illustration, il faut bien constater que ce sont justement ces conventions, cet artifice qu'ils préfèrent. Les parents s'inquiètent des images de violence physique ou de complaisance sexuelle qu'on peut voir à la télévision, alors que les enfants, au moins jusqu'à la puberté, y sont en général indifférents. En revanche, ils détestent le journal télévisé. Avec son cortège de guerres, de chômage et de grèves, de drames et de catastrophes, il les met mal à l'aise. La publicité, avec son imagerie du bonheur, les rassure.
- (5) Et quand les moralistes reprochent aux publicitaires de lier cette idée de bonheur à la possession de biens matériels, ils oublient que les contes de fées non plus n'étaient pas désintéressés. Ce n'est pas le problème des enfants. Cela peut être celui des parents, quand ils s'efforcent de leur apprendre à faire le départ entre le réel et l'imaginaire, entre le désir et sa réalisation.
- (10) Et quand les moralistes reprochent aux publicitaires de lier cette idée de bonheur à la possession de biens matériels, ils oublient que les contes de fées non plus n'étaient pas désintéressés. Ce n'est pas le problème des enfants. Cela peut être celui des parents, quand ils s'efforcent de leur apprendre à faire le départ entre le réel et l'imaginaire, entre le désir et sa réalisation.
- (15) Selon l'article, les effets des scènes de violence et de complaisance sexuelle à la télévision sur les jeunes enfants sont en général
- (A) nuisibles (B) graves  
(C) favorables (D) insignifiants

16. D'après le texte, quelle est la réaction que le journal télévisé provoque chez les enfants?  
(A) Il les trouble. (B) Il les intéresse.  
(C) Il les laisse indifférents. (D) Il les rassure.
17. Quelle est la conclusion de l'article vis-à-vis de la publicité?  
(A) La réaction des enfants devant la publicité dépend des parents.  
(B) Tous les enfants réagissent différemment à la publicité.  
(C) La publicité est salubre dans le développement de l'enfant.  
(D) On a raison de dénoncer les messages publicitaires.



**LE BON MOMENT**  
— PAR LES RESTAURATEURS —  
DU VOYAGE

*La SNCF et ses restaurateurs, s'engagent par un service de qualité, à vous faire passer un bon moment pendant le temps de votre voyage. Pour être sûr de pouvoir en profiter, la SNCF vous recommande de réserver votre repas en même temps que votre place.*

18. Quand on voyage en train, on devrait réserver une table au moment où l'on
- (A) achète son billet  
(B) commence le voyage  
(C) annonce le repas  
(D) arrive à destination



## Sample Listening Questions

The following three types of questions appear on the French Test with Listening. All questions in this section of the test are multiple-choice questions in which you must choose the **BEST** response from three or four choices offered. Text in brackets [ ] is recorded on the CD.

### Part A

**Directions:** For each item in this part, you will hear four sentences designated (A), (B), (C), and (D). They will not be printed in your test book. As you listen, look at the picture in your test book and select the choice that **best** reflects what you see in the picture or what someone in the picture might say. Then fill in the corresponding circle on the answer sheet. You will hear the choices only once. Now look at the following example.

You see:



You hear:

- (A) Quelle joie d'être seul!
- (B) Que c'est agréable de faire du vélo!
- (C) Le moteur fait trop de bruit!
- (D) Nous adorons la course à pied.]

Statement (B), "Que c'est agréable de faire du vélo!" best reflects what you see in the picture or what someone in the picture might say. Therefore, you should choose answer (B).

1. You see:



You hear:

[Numéro 1

- (**Woman**) (A) Il y a beaucoup de vagues cet après-midi.  
(B) Quel plaisir d'être en forêt!  
(C) Faire de la voile est bien agréable.  
(D) Les bateaux à rames sont lents et silencieux.]

(7 seconds)

2. You see:



You hear:

[Numéro 2

- (**Man**) (A) C'est bien, la musique en plein air!  
(B) Ces gens écoutent un discours passionnant.  
(C) Ces gens se plaignent du bruit.  
(D) Cette salle de concert a une bonne acoustique.]

(7 seconds)

## Part B

**Directions:** In this part of the test you will hear several short selections. A tone will announce each new selection. The selections will not be printed in your test booklet, and will be heard only once. At the end of each selection, you will be asked one or two questions about what was said, each followed by three possible answers, (A), (B), and (C). The answers are not printed in your test booklet. You will hear them only once. Select the **BEST** answer and fill in the corresponding circle on the answer sheet. Now listen to the following example, but do not mark the answer on your answer sheet.

You hear:

[(Tone)]

**(Man B)** Papa, ta voiture est chez le garagiste.

**(Man A)** Mais pourquoi? Elle a toujours bien marché.

**(Man B)** Euh, en réalité, j'ai eu un accident.

**(Man A)** Quoi? Tu plaisantes, n'est-ce pas?

**(Woman A)** Qu'est-ce qu'on peut dire de la voiture en question?

(A) Elle est en réparation.

(B) Elle est sur la route.

(C) Elle est chez un ami.]

The best answer to the question, "Qu'est-ce qu'on peut dire de la voiture en question?" is (A), "Elle est en réparation." Therefore, you should choose answer (A).

### Questions 3-4

[(Tone)]

**(Woman)** Agence Beausoleil, bonjour.

**(Man)** Bonjour, madame. Pourriez-vous m'aider à trouver un vol pour Toronto dans la semaine du 15 avril?

**(Woman)** Bien sûr, monsieur. Selon l'ordinateur, il y a des vols à 11 heures et à 15 heures tous les jours.

**(Man)** D'accord. Réservez-moi une place sur le vol de 11 heures, pour le mardi 16.

**(Woman)** Entendu, monsieur.]

(5 seconds)

3. [Numéro 3]

**(Woman)** Qu'est-ce que le monsieur veut faire?

(A) Réserver une chambre

(B) Acheter un ordinateur

(C) Prendre un avion]

(7 seconds)

4. [Numéro 4]

**(Woman)** Quand le monsieur va-t-il partir?

(A) Immédiatement

(B) En semaine

(C) Pendant le week-end]

(7 seconds)

### Questions 5-6

[(Tone)]

**(Man)** Pour la quatrième année consécutive, des échanges auront lieu entre des étudiants de Paris et de New York. Environ vingt-cinq étudiants âgés de 15 à 17 ans viendront passer trois semaines dans des familles aux Etats-Unis. L'été suivant, ce sera le tour des étudiants américains d'être hébergés dans des familles françaises.]

(5 seconds)

5. [Numéro 5]

**(Man B)** Quel est le but de cette annonce à la radio?

(A) D'encourager le tourisme en été

(B) De présenter des renseignements sur Paris

(C) De présenter un programme d'échange]

(7 seconds)

6. [Numéro 6]

**(Man B)** Combien de temps doit durer ce séjour?

(A) Trois semaines

(B) Six mois

(C) Un an]

(7 seconds)

### Questions 7-8

[(Tone)

**(Man A)** Bon, c'est d'accord. Nous allons d'abord voir un film, puis retrouver Anne et Sophie au café de la gare. On se rencontre à dix-neuf heures devant le cinéma, entendu?

**(Man B)** C'est ça. À ce soir.]

(5 seconds)

7. [Numéro 7

**(Woman)** Qu'est-ce que les deux amis vont faire ensemble?

- (A) Prendre le train
- (B) Aller au cinéma
- (C) Écouter des disques]

(7 seconds)

8. [Numéro 8

**(Woman)** Où les amis vont-ils rencontrer Anne et Sophie?

- (A) Chez elles
- (B) Dans un café
- (C) Au théâtre]

(7 seconds)

### Part C

**Directions:** You will now hear some extended dialogues or monologues. You will hear each only once. After each dialogue or monologue, you will be asked several questions about what you have just heard. These questions are also printed in your test book. Select the best answer to each question from among the four choices printed in your test book and fill in the corresponding circle on the answer sheet. There is no sample question for this part.

### Questions 9-11

You will hear:

[(**Man A**) Dialogue numéro 1. Éric, jeune étudiant demeurant à Paris, parle de ses activités.

**(Woman)** Alors, dis-moi ce que tu fais.

**(Man B)** Je suis chanteur dans deux groupes, un de Rythme & Blues, et un autre groupe, un groupe de rock.

**(Woman)** Et vous répétez souvent?

**(Man B)** Pour le groupe de Rythme & Blues, nous ne répétons pas souvent; nous avons répété pendant huit mois et donc nous connaissons assez bien le répertoire et je ne fais pas tous les concerts avec eux, donc ce n'est pas la peine.

**(Woman)** Et comment s'appelle ce groupe?

**(Man B)** Ce groupe s'appelle *Les Steady Holy Men*.

**(Woman)** Et l'autre groupe?

**(Man B)** C'est un groupe de rock qui s'appelle *Riffraff* et là, on vient de commencer il y a deux mois, un peu plus peut-être, et nous répétons, une fois par semaine au moins, quelquefois deux fois par semaine, pendant trois ou quatre heures.

**(Woman)** Et vous répétez où?

**(Man B)** Nous répétons dans un local de répétitions. Il y en a plusieurs sur Paris où on peut payer à l'heure pour répéter dans un studio. Tout est équipé.

**(Woman)** Bien, et vous jouez où, en général?

**(Man B)** Nous jouons dans des bars, dans des clubs, dans des bistros, dans des caves.]

9. [Numéro 9

**(Woman B)** Au cours de cette conversation, qu'est-ce que nous apprenons sur le jeune Éric?]

Au cours de cette conversation, qu'est-ce que nous apprenons sur le jeune Éric?

- (A) Il est chanteur
- (B) Il a terminé ses études
- (C) Il est acteur
- (D) Il veut apprendre le français

(12 seconds)

10. [Numéro 10  
(Woman B) Pourquoi les membres du groupe Rythme & Blues ne répètent-ils pas souvent?]

Pourquoi les membres du groupe Rythme & Blues ne répètent-ils pas souvent?

- (A) Parce qu'ils connaissent bien les chansons
  - (B) Parce qu'ils aiment improviser
  - (C) Parce qu'ils s'intéressent à d'autres concerts
  - (D) Parce qu'ils jouent rarement en public
- (12 seconds)

11. [Numéro 11  
(Woman B) Où Éric donne-t-il des concerts?]

Où Éric donne-t-il des concerts?

- (A) Dans des restaurants
- (B) Dans des jardins
- (C) Dans des clubs
- (D) Dans des théâtres

(12 seconds)

## ANSWERS

The estimated difficulty level, on a scale of 1 to 5, with 1 the easiest and 5 the most difficult, is in parentheses.

### Reading Questions

- |          |           |           |           |
|----------|-----------|-----------|-----------|
| 1. A (1) | 6. C (3)  | 11. A (5) | 16. A (4) |
| 2. D (2) | 7. D (4)  | 12. D (3) | 17. A (3) |
| 3. B (3) | 8. A (2)  | 13. C (3) | 18. A (3) |
| 4. A (2) | 9. A (2)  | 14. C (2) |           |
| 5. B (3) | 10. D (2) | 15. D (3) |           |

### Listening Questions

- |          |          |          |           |
|----------|----------|----------|-----------|
| 1. D (4) | 4. B (2) | 7. B (2) | 10. A (4) |
| 2. A (3) | 5. C (2) | 8. B (3) | 11. C (3) |
| 3. C (2) | 6. A (3) | 9. A (2) |           |

# German and German with Listening

One-hour subject tests

## Purpose

### German Test

- Measure the ability to understand written German

### German Test with Listening

- Measure the ability to understand written and spoken German

## Format

### German Test

- 80–85 multiple-choice questions
- Only offered in June

### German Test with Listening

- 20 minutes listening and 40 minutes of usage and reading
- 85–90 multiple-choice listening and reading questions
- Listening questions that require answers to questions based on shorter and longer listening selections
- Only offered in November at designated test centers

You must bring an acceptable CD player with earphones. See page 5.

## Content

Both tests comply with the German spelling reform (Rechtschreibreform) as much as possible. The tests evaluate reading ability in these areas:

### **Sentence Completion and Paragraph Completion:**

These questions test vocabulary and grammar requiring you to know the meaning of words and idiomatic expressions in context and to identify usage that is structurally correct and appropriate. For each omission, you must select the choice that BEST fits each sentence.

**Reading Comprehension:** These questions test understanding of the content of various materials taken from sources such as advertisements, timetables, street signs, forms, and tickets. They also examine your ability to read passages representative of various styles and levels of difficulty. There are several prose passages followed by questions that test your understanding of the passages. The passages, mostly adapted from literary sources and newspapers or magazines, are generally one or two paragraphs in length and test whether you can identify the main idea or comprehend facts or details in the text.

The listening test also measures the ability to understand spoken language with two types of listening questions:

**Type One:** Contains short dialogues/monologues with one or two multiple-choice questions. Dialogues/monologues, questions, and answer choices are recorded. Questions are also printed in the test book.

**Type Two:** Contains longer dialogues and monologues with several multiple-choice questions. Dialogues/monologues and questions are only recorded and not printed in the test book. Answer choices are not recorded; they appear only in the test book.

## Recommended Preparation

Both tests reflect general trends in high school curricula and are independent of particular textbooks or methods of instruction. Recommended preparation includes:

- 2–4 years of study in high school or the equivalent
- Gradual development of competence in German over a period of years

### German Test with Listening

- Review of sample listening questions using the practice CD available from your school counselor

## Score

- Total score: 200–to–800 scale
- Listening test: reading and listening subscores 20–to–80 scale

GERMAN		Approximate % of Test
<b>Skills Measured</b>		
Vocabulary in context and Structure in context (grammar)		50
Reading comprehension Authentic stimulus materials and passages		50

GERMAN with LISTENING		Approximate % of Test
<b>Listening Section</b> (20 minutes)		35
Short dialogues/monologues Long dialogues/monologues		
<b>Reading Section</b> (40 minutes)		65
Vocabulary in context Structure in context (grammar) Reading comprehension using authentic stimulus materials and passages		

## Sample Reading Questions

Several types of questions are used in the German Subject Test. All questions in the test are multiple-choice questions in which you must choose the **BEST** response from the four choices offered.

### Part A

**Directions:** This part consists of a number of incomplete statements, each having four suggested completions. Select the most appropriate completion and fill in the corresponding circle on the answer sheet.

- Der Präsident hat gestern Abend eine . . . gehalten.  
(A) Rede (B) Sprache (C) Nachricht  
(D) Erklärung
- Sie tut nur, was ihr Spaß . . .  
(A) gibt (B) schenkt (C) macht  
(D) bringt
- Der nächste Bus . . . um zehn Uhr ab.  
(A) fährt (B) fahr (C) fahre  
(D) fährt

- Wissen Sie, . . . dieser Hund gehört?  
(A) wer (B) wo (C) wessen  
(D) wem

### Part B

**Directions:** In the following paragraph, there are numbered blanks indicating that words or phrases have been omitted. For each numbered blank, four completions are provided. First read through the entire paragraph. Then, for each numbered blank, choose the completion that is most appropriate and fill in the corresponding circle on the answer sheet.

#### Verspätung

Solange ich ihn -----, ist er immer pünktlich -----; ich

- (A) weiß (B) kenne (C) verstehe (D) kann
- (A) gewesen (B) worden (C) geworden (D) gewusst

verstehe ----- nicht, warum er uns

- (A) damit (B) dadurch (C) darin (D) deshalb

diesmal im ----- gelassen hat.

- (A) Loch (B) Vergessen (C) Stich (D) Mangel

### Part C

**Directions:** Read the following texts carefully for comprehension. Each is followed by a number of questions or incomplete statements. Select the answer or completion that is best according to the text and fill in the corresponding circle on the answer sheet.



### Question 9

## Weltstadt-Wochenende zu zweit zu gewinnen!

- An einem Freitag anreisen und bis Sonntag bleiben
- Im erstklassigen Hotel verwöhnt werden
- Weltstadt-Programm erleben
- Das alles auf unsere Kosten

---

---

---

Name:  
Straße:  
Ort:

**Viel Glück!**

9. Was könnte man mit diesem Schein gewinnen?
- (A) Ein bezahltes Wochenende
  - (B) Einen Urlaub am Meer
  - (C) Ein tolles Auto
  - (D) Ein super Hotel

### Questions 10-11



**MAGAZIN**  
Im Magazinteil lesen Sie: Ist Paul McCartney tot? Außerdem über: Musikrends aus Rock, Pop und Klassik. Musik-Neuerscheinungen, Konzerte und Tourneen, Künstler, Medien. Und vieles mehr. Das ist beste Unterhaltung auf über 80 farbigen Seiten.  
**UND KATALOG**  
Aus dem Katalogteil bestellen Sie leicht und bequem von zu Hause: Top-Hits von gestern, heute und morgen. Klassik, Pop, Rock, Jazz. CDs, LPs, MCs, Film- und Musik-Videos. Exklusivangebote. Riesenauswahl.  
**IN EINEM**

10. Wofür macht man hier Reklame?
- (A) Moderne Rockstars
  - (B) Neue Stereoanlagen
  - (C) Preiswerte CD-Spieler
  - (D) Eine Musikzeitschrift
11. Worüber gibt das Magazin wohl Auskunft?
- (A) Neues über Computer
  - (B) Kunstausstellungen
  - (C) Neues aus Rock und Pop
  - (D) Modische Kleidung

### Questions 12-14

Die Frage, ob Bewegung wirklich der Gesundheit dient, beschäftigt nach wie vor sowohl die Mediziner als auch alle diejenigen, die mit Joggen, Schwimmen und Schwitzen ihr Herzinfarkttrisiko zu verkleinern hoffen.

Bevölkerungsstudien geben viele Beweise dafür, dass Herztraining—bestimmte körperliche Übungen mindestens dreimal in der Woche, die für mindestens 30 Minuten den Puls beschleunigen—tatsächlich die Gefahr von Herzkrankheiten reduzieren kann. Laboruntersuchungen hingegen waren bisher nicht ganz klar. Großes Interesse fand jedoch eine Studie der Universitätsklinik Boston. Nach regelmäßigem Training in einem Laufrad überstand eine Versuchsgruppe von Affen die Folgen einer schlechten Ernährung besser als eine Vergleichsgruppe. Diese Gruppe hatte bei gleicher Ernährung keine Bewegung. Natürlich muss das Experiment wiederholt und verbessert werden. Immerhin ist dies das erste Versuchsergebnis mit höheren Primaten, z.B. Affen, das zeigt, dass man durch körperliche Bewegung Herzerkrankungen verhindern kann.

12. Es gibt viele Beweise dafür, dass Herzinfarkte bei Menschen nicht so häufig auftreten, wenn sie
- (A) zu viel essen
  - (B) fit bleiben
  - (C) Bewegung vermeiden
  - (D) Tierversuche machen
13. Der Verfasser des Berichtes macht es klar, dass
- (A) die Vergleichsgruppe kein Verhältnis zur Versuchsgruppe hat
  - (B) Bewegung der menschlichen Gesundheit nur schaden kann
  - (C) das Experiment wiederholt werden muss
  - (D) der Puls nie beschleunigt werden kann
14. In diesem Artikel geht es in erster Linie um eine Frage
- (A) des Sporttrainings
  - (B) der Ernährung
  - (C) der Labormethoden
  - (D) der Gesundheit

## Sample Listening Questions

In the German Test with Listening, the following two types of listening questions will appear in addition to the reading questions discussed previously. In the actual test, the listening section will come first. All questions in this part of the test are multiple-choice questions in which you must choose the **BEST** response from the four choices offered.

Text in brackets [ ] is only recorded and not printed in your test book.

### Part A

**Directions:** In this part of the test you will hear several selections. They will not be printed in your test book. You will hear them only once. Therefore, you must listen very carefully. In your test book you will read one or two short questions about what was said. Another speaker will read the questions for you. Each question will be followed by four choices marked (A), (B), (C), and (D). The choices are not printed in your test book. You will hear them once. Select the best answer and fill in the corresponding circle on your answer sheet.

(Narrator) [Question 15 refers to the following exchange.]

(Man B) [Hmmm, das riecht gut. Was gibt's denn heute Abend zu essen?]

(Man A) Für dich nichts, Klaus, weil du immer so spät nach Hause kommst.

(Man B) Entschuldige, Rainer. Aber das war nicht meine Schuld—heute. Die Chefin gab mir in der letzten Minute noch viel zu tun.]

15. (Woman) [Was gefällt Rainer nicht?] Was gefällt Rainer nicht?

(Man) [(A) Klaus kommt spät.  
(B) Die Chefin arbeitet viel.  
(C) Klaus hat gegessen.  
(D) Es riecht so gut.]

(5 seconds)

(Narrator) [Questions 16 and 17 refer to the following exchange.]

(Man A) [Herr Lenz, es ist schon 6.00 Uhr, und Sie sitzen immer noch am Schreibtisch!]

(Man B) Ich fahre doch morgen in Urlaub und wollte keine Arbeit liegen lassen.

(Man A) Lassen Sie mal. Am Montag bekomme ich eine Hilfskraft. Gehen Sie nach Hause und packen Sie.]

16. (Woman) [Warum sitzt Herr Lenz noch am Schreibtisch?] Warum sitzt Herr Lenz noch am Schreibtisch?

(Man) [(A) Er telefoniert.  
(B) Er packt ein.  
(C) Er arbeitet.  
(D) Er fährt heim.]

(5 seconds)

17. (Woman) [Wo unterhalten sich die Männer?] Wo unterhalten sich die Männer?

(Man) [(A) Im Urlaub.  
(B) Im Zug.  
(C) Zu Hause.  
(D) Im Büro.]

(5 seconds)

### Part B

**Directions:** You will now listen to some extended dialogues or monologues. You will hear each only once. After each dialogue or monologue, you will be asked several questions about what you have just heard. These questions are not printed in your test book. From the four printed choices, select the best answer to each question and fill in the corresponding circle on the answer sheet. There is no sample question for this part.

#### Questions 18-21

(Narrator) [You will hear a telephone conversation about a car deal.]

(Telephone rings)

(Woman) [Hallo—Müller hier.]

(Man) Ich habe in der „Morgenpost“ gelesen, dass Sie ein Auto zu

verkaufen haben. Können Sie mir etwas über den Wagen sagen?

**(Woman)** Ja, der Wagen ist drei Jahre alt, hat ungefähr 45 000 km und ein Schiebedach. Er ist in gutem Zustand. Er steht immer nachts in der Garage, und ich hatte noch nie einen Unfall damit.

**(Man)** Wann war der Wagen das letzte Mal zur Inspektion beim TÜV?

**(Woman)** Ende letzten Jahres.

**(Man)** Gibt es irgendwelche Probleme mit dem Wagen?

**(Woman)** Vor einigen Monaten ließ sich die Tür auf der Fahrerseite nicht schließen. Wir haben sie aber reparieren lassen.

**(Man)** Ich habe gegen 17.00 Uhr Feierabend, kann ich dann vorbeikommen?

**(Woman)** Ja, ich wohne Holunderweg 7.

**(Man)** Ach, da sind wir ja beinahe Nachbarn. Ich werde kurz nach 18.00 Uhr bei Ihnen sein.

**(Woman)** Gut dann: Auf Wiedersehen.]

18. **(Man)** [Woher weiß der Mann, dass die Frau ein Auto zu verkaufen hat?]  
(12 seconds)

- (A) Er hat es in der Zeitung gelesen.
- (B) Sie hat einen Brief an ihn geschrieben.
- (C) Seine Autowerkstatt hat es ihm gesagt.
- (D) Die Nachbarn haben es ihm erzählt.

19. **(Man)** [Warum war das Auto in der Werkstatt?]  
(12 seconds)

- (A) Weil es in einen Unfall verwickelt war.
- (B) Weil die Karosserie verkratzt war.
- (C) Weil die Tür auf der Fahrerseite nicht zuing.
- (D) Weil man die Fenster nicht schließen konnte.

20. **(Man)** [Wann wird sich der Mann den Wagen ansehen?]  
(12 seconds)

- (A) Kurz vor Feierabend.
- (B) Nach der Arbeit.
- (C) Am Morgen.
- (D) Am Wochenende.

21. **(Man)** [Warum ist das Auto so gut wie neu?]  
(12 seconds)

- (A) Weil es gerade aus der Werkstatt kam.
- (B) Weil es zur Inspektion muss.
- (C) Weil es nachts nicht auf der Straße steht.
- (D) Weil es über 45 000 km drauf hat.

## ANSWERS

The estimated difficulty level, on a scale of 1 to 5, with 1 the easiest and 5 the most difficult, is in parentheses.

### Reading Questions

- |          |          |           |           |
|----------|----------|-----------|-----------|
| 1. A (4) | 5. B (2) | 9. A (1)  | 13. C (3) |
| 2. C (2) | 6. A (2) | 10. D (2) | 14. D (3) |
| 3. D (2) | 7. D (3) | 11. C (2) |           |
| 4. D (4) | 8. C (5) | 12. B (1) |           |

### Listening Questions

- |           |           |           |           |
|-----------|-----------|-----------|-----------|
| 15. A (2) | 17. D (1) | 19. C (3) | 21. C (3) |
| 16. C (1) | 18. A (3) | 20. B (4) |           |

# Modern Hebrew

One-hour subject test

## Purpose

- Measure competence in modern Hebrew

## Format

- 85 multiple-choice questions
- Only offered in June

## Content

The test evaluates reading ability in three areas:

**Vocabulary:** These types of questions test knowledge of words representing different parts of speech and some basic idioms within culturally authentic contexts.

**Structure:** This kind of question tests grammar, including parts of speech as well as your ability to recognize appropriate language patterns.

**Reading Comprehension:** Reading comprehension questions test your understanding of passages of varying levels of difficulty. These passages, most of which are vocalized, are generally adapted from literary sources and newspaper or magazine articles. Authentic material such as advertisements has been added to the test. While some passages have biblical references, no material in the test is written in biblical Hebrew.

## Recommended Preparation

The Modern Hebrew Test allows for variation in language preparation. It is independent of particular textbooks or methods of instruction. Recommended preparation includes:

- 2–4 years of Hebrew language study in high school or the equivalent
- Gradual development of competence in Hebrew over a period of years

## Score

- Total score: 200–to–800 scale

CONTENT	Approximate % of Test
<b>Skills Measured</b>	
Vocabulary in context	30
Structure in context (grammar)	30
Reading comprehension	40

## Sample Questions

Three types of questions are used in the Modern Hebrew Subject Test. All questions in the test are multiple-choice and require you to choose the **BEST** response from the four choices offered.

### Part A

**Directions:** This part consists of a number of incomplete statements, each having four suggested completions. Select the most appropriate completion and fill in the corresponding circle on the answer sheet.

1. אָנִי \_\_\_\_\_, אָבֵל אֵינְנִי יְכוּל לְלַכֵּת

אֶתְּךָ לְקוֹנְצֵרְט הָעֶרֶב.

(A) מְשִׁתְּלֵם (B) מְתַפְאֵר

(C) מְצַטֵּעַר (D) מְתַקְרַר

2. בְּגִלְל הַגִּשְׁמִים לֹא הִיְתָה \_\_\_\_\_

לְטִיֵּל בְּרֵגֶל.

(A) מְטַרְיָה (B) סְעָרָה

(C) זְהִירוֹת (D) אֶפְשָׁרוֹת

3. אֶתְמוֹל שׁוֹחַחְתִּי בְּטֵלְפוֹן עִם חֲבֵרְתִּי

מִיִּשְׂרָאֵל וְשָׂמַעְתִּי \_\_\_\_\_ מְצוּיָן.

(A) אוֹתָהּ (B) אֶתָּה

(C) אֵלַיָּהּ (D) אוֹתָהּ

4. בְּקִשְׁנוּ מִבְּעַל-הַבַּיִת \_\_\_\_\_ אֶת

הַמְּנַעוֹל שֶׁהִתְקַלְקַל.

(A) לְתַקֵּן (B) לְכַלּוֹת

(C) לְהַסְגִּיר (D) לְכַנּוֹת

5. הָרִוּחַ הִתְזַקָּה גְרָמָה \_\_\_\_\_ רַב

לְרִכּוּשׁ הַתּוֹשָׁבִים.

(A) מְזִיק (B) נָזַק

(C) בְּרָק (D) רָעַם

11. (A) מאוחרות (B) אחרות  
(C) אחריות (D) אחרות

12. (A) רואים (B) אוהבים  
(C) מקוים (D) גאים

6. כל ארבע שנים מתקיימות \_\_\_\_\_  
לנשיאות ארצות-הברית.  
(A) הבטחות (B) התקריות  
(C) ממשלות (D) בחירות

## Part B

**Directions:** In each of the following paragraphs there are numbered blanks indicating that words or phrases have been omitted. For each numbered blank, four completions are provided. First read through the entire paragraph. Then, for each numbered blank, choose the completion that is most appropriate and fill in the corresponding circle on the answer sheet.

- חנה למדה רפואה. היא למדה הרבה שנים  
(7) \_\_\_\_\_ להיות רופאה בחדר ניתוח והיא  
מקנה שבשנה הבאה היא תקבל תעודת רפואה.  
הוריה עזרו (8) \_\_\_\_\_ להגשים את (9) \_\_\_\_\_  
עכשו היא רוצה לעבוד בבית-חולים בעיר בה  
גדלה ולהחזיר להוריה לפחות (10) \_\_\_\_\_  
מן הכסף ששלמו עבור למודיה. משפחתה  
של חנה עלתה מאיראן לפני שנים (11) \_\_\_\_\_  
והיא הראשונה במשפחה שתהיה רופאה.  
בלם (12) \_\_\_\_\_ בה מאד.

7. (A) כרי (B) אכל  
(C) אם (D) כדאי

8. (A) אותה (B) לה  
(C) אתה (D) אצלה

9. (A) רפואה (B) תקנה  
(C) חלומה (D) בקשתה

10. (A) חלק (B) חלקה  
(C) חלוקה (D) חלוק

## Part C

**Directions:** Read the following passages carefully for comprehension. Each is followed by a number of questions or incomplete statements. Select the answer or completion that is best according to the passage and fill in the corresponding circle on the answer sheet.



דרושים מורים למתמטיקה ולמדע לכיתות ה-ו,  
לחצי משרה או למשרה מלאה.  
דרישות: תואר ראשון בתחום מתאים,  
ותעודת הוראה.  
בית ספר תומר, רח' בן יהודה.  
טלפון: 556677.

13. הפרסומת מודיעה על  
(A) מורים שמחפשים עבודה  
(B) מקומות עבודה למורים  
(C) ספרי למוד למתמטיקה ומדע  
(D) תעודות למורים

14. לפי הפרסומת דרושים

- (A) מורים בארצות-הברית  
(B) כתות גדולות  
(C) ספרי למוד  
(D) בעלי תואר ראשון

15. 556677 הוא מספר הטלפון של

- (A) המורה  
(B) בית ספר תומר  
(C) בן יהודה  
(D) הכתה

נשים סופרות בישראל

17. מה היתה הטענה נגד כלי התקשורת?

- (A) שאין די הערכה לנשים סופרות
- (B) שהם שבחו רק גברים סופרים
- (C) שהם מעסיקים רק גברים
- (D) שלא שדרו כתבות על נשים סופרות

18. למה הסופרת התרגזה?

- (A) כי רצו להראות אותה מכינה אכל
- (B) כי היא עבדה קשה במטבח
- (C) כי בקשו ממנה לעבד בטלויזיה
- (D) כי היא אינה אוהבת להצטלם

19. בין המשתתפים בדיון

- (A) לא היו צלמי טלויזיה
- (B) היו דעות מנוגדות
- (C) היו אנשים חשוכים
- (D) לא היו סופרות

20. רב הסופרות חשבו

- (A) שבדיונים צריף להפריד בין סופרות לסופרים
- (B) שלא חשוב מי הכותב - גבר או אשה
- (C) שהטלויזיה צריכה להקדיש זמן ליצירות של נשים
- (D) שחשוב להדגיש שאשה כתבה את היצירה

בישראל התקיים דיון על הנושא: כיצד

מתחכסים בעתונות, ברדיו ובטלויזיה

לנשים סופרות. היו שטענו שהם אינם

נותנים לאשה הסופרת אותו כבוד

שנותנים לסופר. בין המשתתפים בדיון

היו גם כמה מן הסופרות עצמן. אחת מהן

ספרה שכאשר ראינו אותה עבור הטלויזיה

בקשו לצלם אותה במטבח כשהיא מבשלת.

היא כעסה ואמרה שמה שהיא עושה במטבח

אינו אומר דבר על עבודתה כסופרת.

שאלה נוספת היתה אם יש הבדל בין ספרות

הנכתבת על ידי נשים לבין זאת הנכתבת על ידי

גברים. בנושא זה היו חלוקי דעות קשים בין

המשתתפים. כמעט כל הסופרות טענו שהן אינן

רוצות שידגישו את העובדה שהן נשים.

הן חושבות שצריף לדון ביצירה ספרותית

לעצמה. לבדק אותה באותם כלים שבהם

בודקים כל יצירה ספרותית מבלי להתחשב

אם היצירה נכתבה על ידי סופר או סופרת.

16. כמה דן הקטע?

- (A) בקשר בין סופרים ועתונאים
- (B) במעמד של נשים סופרות בתקשורת
- (C) בבציות צלום לטלויזיה
- (D) במטבח הישראלי

ANSWERS

The estimated difficulty level, on a scale of 1 to 5, with 1 the easiest and 5 the most difficult, is in parentheses.

- |          |           |           |           |
|----------|-----------|-----------|-----------|
| 1. C (1) | 6. D (5)  | 11. D (5) | 16. B (2) |
| 2. D (2) | 7. A (1)  | 12. D (4) | 17. A (5) |
| 3. A (3) | 8. B (2)  | 13. B (4) | 18. A (4) |
| 4. A (4) | 9. C (3)  | 14. D (3) | 19. B (4) |
| 5. B (5) | 10. A (2) | 15. B (1) | 20. B (3) |



# Italian

One-hour subject test

## Purpose

- Measure the ability to understand written Italian

## Format

- 80–85 multiple-choice questions
- Only offered in December

## Content

The test questions range in difficulty from elementary through advanced, although most questions are at the intermediate level. The test evaluates reading ability in three areas:

**Sentence Completion:** These questions test your knowledge of high-frequency vocabulary and appropriate idiomatic expressions in the context of paragraphs.

**Structure:** These questions test your familiarity with the language structure.

**Reading Comprehension:** Reading comprehension questions test your understanding of the content of various selections taken from sources such as newspaper and magazine articles, fiction, historical works, advertisements, tickets, brochures, forms, and schedules. Commonly taught grammatical constructions are tested, and all questions reflect current standard Italian.

## Recommended Preparation

The Italian Subject Test allows for variation in language preparation. It is independent of particular textbooks or methods of instruction. Recommended preparation includes:

- 2–4 years of Italian language study in high school or the equivalent
- Gradual development of competence in Italian over a period of years

## Score

- Total score: 200–to–800 scale

CONTENT	Approximate % of Test
<b>Skills Measured</b>	
Vocabulary in context	30
Structure in blank	30
Reading comprehension	40

## Sample Questions

Three types of questions are used in the Italian Subject Test. All questions in the test are multiple-choice questions in which you must choose the **BEST** response from the four choices offered.

### Part A

**Directions:** In each of the following passages there are numbered blanks indicating that words or phrases have been omitted. For each numbered blank, four completions are provided. First read through the entire passage. Then, for each numbered blank, choose the completion that is most appropriate given the context of the entire passage and fill in the corresponding circle on the answer sheet.

#### Un paio di blue-jeans

Ho portato blue-jeans sin da quando se ne portavano pochissimi e comunque solo in vacanza. Li trovavo e li trovo molto (1) specie in viaggio perchè non ci sono problemi di piega. Oggi si portano anche per bellezza, ma sono prima di tutto molto (2). Solo che da parecchi anni avevo dovuto (3) a questo piacere, perchè ero ingrassato.

Recentemente, ho perso quel numero di (4) sufficiente per riprovare un blue-jeans quasi normale. Ho provato una dozzina di blue-jeans ed ogni (5) la commessa del negozio mi diceva: “Stringa, vedrà che poi si (6).” Finalmente ne ho trovato uno e sono partito, senza dover tirare indietro la pancia.

1. (A) colorati (B) costosi  
(C) comodi (D) stretti
2. (A) utili (B) difficili  
(C) vecchi (D) strani
3. (A) rinunciare (B) rassegnarmi  
(C) consentire (D) attenermi

4. (A) metri (B) litri  
(C) chili (D) chilometri
5. (A) cosa (B) volta  
(C) modo (D) giorno
6. (A) ritirano (B) lavano  
(C) formano (D) adattano

## Part B

**Directions:** In each sentence or dialogue below you will find a blank space indicating that a word or phrase has been omitted. Following each sentence are four completions. Of the four choices, select the one that best completes the sentence structurally and logically and fill in the corresponding circle on the answer sheet. In some instances, choice (A) may consist of dashes; by choosing this option, you are indicating that no insertion is required to form a grammatically correct sentence.

7. Che ----- sconti!  
(A) belli (B) begli  
(C) belle (D) bei
8. Ti piacciono queste camicie? ----- ho comprate per Gianna.  
(A) Le (B) La  
(C) Gli (D) Li
9. Se ----- più denaro, comprerei anche quella gonna di lana.  
(A) avrei (B) avevo  
(C) avrò (D) avessi

## Part C

**Directions:** Read the following texts carefully for comprehension. Each text is followed by a number of questions or incomplete statements. Select the answer or completion that is best according to the text and fill in the corresponding circle on the answer sheet.

### Questions 10-11



10. Cebion è  
(A) un codice (B) una medicina  
(C) un'avvertenza (D) un cibo
11. Questo prodotto si deve usare  
(A) ogni giorno (B) con la vitamina C  
(C) prima dei pasti (D) con cura

### Questions 12-15

Cari lettori,

Gli scioperi dei treni hanno causato in questi giorni non pochi problemi. Ogni mattina mi sono alzato tendendo l'orecchio ai giornali radio, pronto ad adeguarmi ad ogni nuova circostanza, a muovermi in macchina (nebbia permettendo) o in aereo (scioperi, anche qui, permettendo). Ma non voglio lamentarmi degli scioperi. Anch'io sono un lavoratore dipendente e so che è giusto farli, quando occorrono, salvo tutelare i diritti degli utenti. Quanto ai treni (ahimè!) lo sciopero non mi ha sconvolto più di tanto. So di non poter contare sulle nostre ferrovie al cento per cento, so che i ritardi, soprattutto su certe linee, sono piuttosto frequenti. Parlo per esperienza. Io ho molti parenti in Emilia e spesso ricevo le loro visite. Una volta andavo alla Stazione Centrale ad aspettarli. Ora, da almeno dieci anni, non lo faccio più, per non passare ore a vuoto in attesa di treni che non sono mai puntuali. Pazienza! Bisogna accettare ciò che passa il convento e rassegnarsi. Riuscirà la nuova linea che accorcerà le distanze tra Milano e Roma a risolvere la situazione? Me lo auguro.

E.F.

12. Chi scrive questa lettera?  
 (A) Il padrone di una ditta  
 (B) Un controllore  
 (C) Un impiegato  
 (D) Un disoccupato
13. Cosa pensa degli scioperi l'autore della lettera?  
 (A) Che sono illegali  
 (B) Che sono qualche volta giustificati  
 (C) Che dovrebbero essere aboliti  
 (D) Che sono sempre utili
14. L'autore considera lo sciopero dei treni con  
 (A) allegria (B) incomprendione  
 (C) rabbia (D) rassegnazione
15. Dieci anni fa, E.F. ha deciso di  
 (A) non aspettare più alla stazione  
 (B) lamentarsi degli scioperi  
 (C) non dare appoggio ai lavoratori  
 (D) non ascoltare la radio la mattina

## ANSWERS

The estimated difficulty level, on a scale of 1 to 5, with 1 the easiest and 5 the most difficult, is in parentheses.

- |                 |                 |                  |                  |
|-----------------|-----------------|------------------|------------------|
| <b>1. C (2)</b> | <b>5. B (3)</b> | <b>9. D (3)</b>  | <b>13. B (4)</b> |
| <b>2. A (3)</b> | <b>6. D (4)</b> | <b>10. B (1)</b> | <b>14. D (2)</b> |
| <b>3. A (4)</b> | <b>7. B (2)</b> | <b>11. D (2)</b> | <b>15. A (1)</b> |
| <b>4. C (5)</b> | <b>8. A (2)</b> | <b>12. C (2)</b> |                  |

# Japanese with Listening

One-hour subject test

## Purpose

- Measure the ability to communicate in Japanese in a culturally appropriate way

## Format

- 20 minutes listening and 40 minutes of usage and reading
- 80–85 multiple-choice questions
- Only offered in November at designated test centers

You must bring an acceptable CD player with earphones. See page 5.

## Content

The test evaluates ability in three areas:

**Listening comprehension:** These questions are based on short, spoken dialogues and narratives primarily about everyday topics. A brief explanation about each selection and the questions are given in English. Explanations are also printed in the test book.

**Usage:** These questions require you to complete Japanese sentences in a way that is appropriate in terms of structure (grammar), vocabulary, and context. Usage questions are printed in three different ways of representing Japanese. In the center column, the Japanese is represented in standard Japanese script and all *kanji* are supplied with *furigana*. In the other two columns, the Japanese is written in the two most common types of romanization (*romaji*). To the left, a modified Hepburn system is used. In that system, the Japanese word for “bicycle” is written as *jitensha*. In the right-hand column, a modified *kunrei-shiki* is used. In that system, the same Japanese word for “bicycle” is written as *zitensya*. You should choose the writing system you are familiar with and read only from that column on the test.

**Reading comprehension:** The reading comprehension questions are in English and test your understanding of such points as main and supporting ideas. The selections in this section are taken from materials you might encounter in everyday situations, such as notes, menus, newspaper articles, advertisements, and letters. The text is written in *hiragana*, *katakana*, and *kanji* without *furigana*.

## Recommended Preparation

- Study of Japanese for two to four years in high school, or the equivalent
- Gradual development of competence in Japanese over a period of years
- Review of sample listening questions using the practice CD available from your school counselor

## Score

- Total score: 200–to–800 scale
- Listening, usage, and reading subscores: 20–to–80 scale

CONTENT	Approximate % of Test
<b>Skills Measured</b>	
Listening comprehension	35
Usage	30
Reading comprehension	35

## Sample Listening Questions

All questions in the test are multiple-choice. You must choose the **BEST** response from the four choices offered.

(Narrator) [ This is a sample CD for the Japanese Test with Listening.

**Directions:** In this section of the test you will hear short dialogues and monologues. You will hear them only once and they are not printed in your test booklet. At the end of each selection, you will be asked questions about what was said. Now listen to the following example, but do not mark the answer on your answer sheet. ]

### Question 1

(Narrator) [ Listen to this short exchange in a stationery store. ]

(Woman) 「これ3冊下さい。」

(Man) 「3冊ですね? はい、1200円です。」

(Narrator) Question 1. What did the woman buy? (16 seconds)

- (A) Pens
- (B) Notebooks
- (C) Erasers
- (D) Colored paper

### Question 2

(Narrator) [ Listen to this short conversation between two acquaintances. ]

(Man) 「今日も車で来ましたか。」

(Woman) 「いいえ、いつも車で来るんですけど、今日はバスできました。」

(Narrator) Question 2. How did the woman get there today? (16 seconds)

- (A) By bus
- (B) By car
- (C) By train
- (D) On foot

### Question 3

(Narrator) [ Now listen to the message on Mr. Nakamura's answering machine in his office. ]

(Man) 「あ、もしもし中村さん。こちらはABCテレビの川上です。今晩会社の方にお電話下さいませんか。では、よろしくお願ひいたします。」

(Narrator) Question 3. When is Mr. Nakamura expected to call? (16 seconds)

- (A) This morning
- (B) Tonight
- (C) Tomorrow morning
- (D) Tomorrow night

### Question 4

(Narrator) [ Listen to this conversation at the woman's home. Then answer question 4. ]

(Woman) 「もう一杯いかがですか。」

(Man) 「いえ、結構です。」

(Woman) 「まあ、そうおっしゃらないで、

(Man) 小さいコップですから。」

「そうですか。じゃあ、少し頂きます。」

(Narrator) Question 4. What most likely is the man's relationship to the woman? (16 seconds)

- (A) He is her guest
- (B) He is her husband
- (C) He is her son
- (D) He is her close friend

## Sample Usage Questions

**Directions:** This section consists of a number of incomplete statements, each of which has four suggested completions. In some instances, choice (A) may consist of dashes that indicate that no insertion is required to form a correct sentence. Select the word or phrase that best completes the sentence structurally and logically and fill in the corresponding circle on the answer sheet.

This section of the test is presented in three columns that provide identical information. Look at the example below and choose the one column of writing with which you are most familiar in order to answer the question. Do not waste time by switching from column to column in this section.

- |   |  |   |
|---|--|---|
| <p>5. Kono hon wa omoshiroku<br/>-----.</p> <p>(A) ja nai desu<br/>(B) ni narimasu<br/>(C) ni shimashita<br/>(D) arimasen</p> | <p>5. この本はおもしろく<br/>-----。</p> <p>(A) じゃないです<br/>(B) になります<br/>(C) にしました<br/>(D) ありません</p> | <p>5. Kono hon wa omosiroku<br/>-----.</p> <p>(A) zya nai desu<br/>(B) ni narimasu<br/>(C) ni simasita<br/>(D) arimaseñ</p> |
|---|--|---|

- |  |  |   |
|--|--|---|
| <p>6. ----- narimashita.</p> <p>(A) kirei<br/>(B) osoku<br/>(C) genki na<br/>(D) benri</p> | <p>6. ----- になりました。</p> <p>(A) きれい<br/>(B) 遅く<br/>(C) 元気な<br/>(D) 便利</p> | <p>6. ----- narimasita.</p> <p>(A) kiree<br/>(B) osoku<br/>(C) geñki na<br/>(D) beñri</p> |
|--|--|---|

- |   |   |   |
|---|---|---|
| <p>7. Hima ----- toki,<br/>jogingu o shimasu.</p> <p>(A) -----<br/>(B) na<br/>(C) no<br/>(D) ni</p> | <p>7. ひま ----- 時、<br/>ジョギングをします。</p> <p>(A) -----<br/>(B) な<br/>(C) の<br/>(D) に</p> | <p>7. Hima ----- toki,<br/>zyogiñgu o simasu.</p> <p>(A) -----<br/>(B) na<br/>(C) no<br/>(D) ni</p> |
|---|---|---|



## Sample Reading Questions

**Directions:** Read the following texts carefully for comprehension. Each text is followed by one or more questions or incomplete statements based on its content. Select the answer or completion that is best according to the text and fill in the corresponding circle on the answer sheet. There is no example for this section.

### Questions 8-9

This is a notice on a telephone pole.

ネコを探しています。

毛の長い白ネコ  
体長約四十センチ  
首に茶色のリボン

こんなネコを見た方は、  
木村（電話三八五―三九九四）  
までご連絡ください。

8. The writer wants to
  - (A) find a lost cat
  - (B) give away a cat
  - (C) find the owner of a cat
  - (D) sell a cat
9. The description says the cat is
  - (A) brown
  - (B) green-eyed
  - (C) long-haired
  - (D) young

### Question 10

Ryan's host mother left a note for him.

ライアンくん、  
明日、朝早いから先に寝ます。晩ごはんは電子レンジで温めてください。明日のハイキングですが、7時半までに起きてください。ジーンズは洗っておきました。

10. What is Ryan to do by seven thirty?
  - (A) Get up
  - (B) Eat
  - (C) Go out
  - (D) Go to bed

### ANSWERS

The estimated difficulty level, on a scale of 1 to 5, with 1 the easiest and 5 the most difficult, is in parentheses.

1. B (1)    3. B (1)    5. D (1)    7. B (2)    9. C (3)  
2. A (2)    4. A (3)    6. B (3)    8. A (4)    10. A (3)

# Korean with Listening

One-hour subject test

## Purpose

- Measure understanding of Korean and ability to engage in purposeful communication in the context of contemporary Korean culture

## Format

- 20 minutes listening and 40 minutes of usage and reading
- 80–85 multiple-choice questions
- Only offered in November at designated test centers

You must bring an acceptable CD player with earphones. See page 5.

## Content

The test evaluates ability in three areas:

**Listening comprehension:** These questions test your ability to understand the spoken language. They are based on short, spoken Korean dialogues and narratives primarily about everyday topics. All listening questions and possible answers are in English. The questions will be spoken on a CD. They will also be printed in the test book.

**Usage:** These questions are written entirely in *Hangul* and require students to complete Korean sentences or phrases so that they are structurally and logically correct. Areas covered include vocabulary, honorifics, and various aspects of structure.

**Reading comprehension:** The reading comprehension questions test your understanding of such points as main and supporting ideas. All passages in this section are written in *Hangul* and all questions are in English. Most questions deal with understanding literal meaning, although some inference questions may be included. The Korean selections are drawn from authentic materials, such as notes, diaries, newspaper articles, advertisements, letters, and literary texts.

## Recommended Preparation

- Study of Korean for two to four years in high school, or the equivalent
- Gradual development of competence in Korean over a period of years
- Review of sample listening questions using the practice CD available from your school counselor

## Score

- Total score: 200–to–800 scale
- Listening, usage, and reading subscores: 20–to–80 scale

CONTENT	Approximate % of Test
<b>Skills Measured</b>	
Listening comprehension	35
Usage	30
Reading comprehension	35

## Sample Listening Questions

**Directions:** In this part of the test you will hear several spoken selections. They will not be printed in your test book. You will hear them only once. After each selection you will be asked one or more questions about what you have just heard. These questions, with four possible answers, are printed in your test booklet. Select the best answer to each question from among the four choices printed and fill in the corresponding circle on your answer sheet. Now listen to the first selection.

(Narrator) [ Listen to the following conversation. Then answer questions 1 and 2. ]

(Woman) [한수야, 어제 전화했는데, 너 어디 갔었니?]

(Man) 어제 우리형이 동부에서 와서 공항에 마중 나갔었어.

(Woman) 너, 형이 동부에 살아?

(Man) 응, 대학교도 거기서 다녔는데, 지금은 졸업하고 회사에 다녀.

(Woman) 좋겠다. 형이 와서.

여기 얼마나 있을 건데?

(Man) 오래 있으면 좋을 텐데, 휴가가 사흘밖에 없대.]

(Narrator) [ Question 1. Where did Hansu go yesterday? ] (16 seconds)

- (A) To his brother's office.  
(B) To his brother's house.  
(C) To the airport.  
(D) To a graduation ceremony.

(Narrator) [ Question 2. Choose the correct statement based on the conversation you have just heard. ] (16 seconds)

- (A) Hansu's brother is moving in with Hansu.  
(B) Hansu's brother has a four-day vacation.  
(C) Hansu's brother works on the West Coast.  
(D) Hansu's brother went to college on the East Coast.

(Narrator) [ Listen to the following announcement. Then answer question 3. ]

(Man) [안내 말씀을 드리겠습니다.  
오늘 새로 개통된 지하철 5호선이  
기계 고장으로 오후 2시부터  
운행이 일시 중단되었습니다. 현재  
고치고 있사오니 3시간 후면 다시  
운행될 예정입니다. 5호선을  
이용하실 분은 4호선을 이용해  
주시기 바랍니다.  
거듭 사과 말씀을 드립니다.]

(Narrator) [ Question 3. What is being announced? ] (16 seconds)

- (A) That service is not affected.  
(B) That service will be restored.  
(C) That a new line will open on the following day.  
(D) That there will be no service at 3 o'clock.

## Sample Usage Questions

### Part A

**Directions:** This section consists of a number of incomplete statements, each of which has four suggested completions. Select the word or words that best complete the sentence structurally and logically and fill in the corresponding circle on the answer sheet.

4. 철수: 할아버지 진지 드셨어요?  
할아버지: 그래, \_\_\_\_\_.

- (A) 잡셨다  
(B) 먹었다  
(C) 드셨다  
(D) 하셨다

5. 현주: 어렸을 때 꿈이 뭐였어요?  
민우: 저는 어렸을 때 경찰이  
\_\_\_\_\_.

- (A) 되어 있었어요  
(B) 되어 버렸어요  
(C) 되고 싶었어요  
(D) 되고 말았어요

6. 우리 언니는 오늘  
숙제를 \_\_\_\_\_ 가는 바람에  
학교에 \_\_\_\_\_ 다시 집에  
돌아왔어요.

- (A) 잊어버리고.....가다가  
(B) 잊어버리고.....가면서  
(C) 잃어버리고.....가는데  
(D) 잃어버리고.....가지만

7. 이 차는 너무 낡아서  
\_\_\_\_\_ 소용이 없을 거예요.

- (A) 고쳐 보면
- (B) 고쳐 봐야
- (C) 고치므로
- (D) 고치고야

**Part B**

**Directions:** In each of the following paragraphs there are numbered blanks indicating that words or phrases have been omitted. For each numbered blank, four completions are provided. First read through the entire paragraph. Then, for each numbered blank, choose the completion that is most appropriate and fill in the corresponding circle on the answer sheet.

나는 어려서부터 성격이 급해 서두른다는 말을 많이 들었다. 이런 성격 때문에 어른들께 꾸중도 \_\_\_\_\_ 들었고, 늘 학교에 가지고 가야 할 것을 덤병대고 집에 두고 가거나, 어디 놀러 갈 때는 이삼일 전부터 준비해 놓으라고 야단법석을 \_\_\_\_\_ 어머니 속을 무척 \_\_\_\_\_ 드렸다. 그러나 이 급한 성격 덕분에 숙제만은 학교에서 오자마자 먼저 해 놓고 놀기 때문에 숙제로 걱정\_\_\_\_\_.

- |           |           |
|-----------|-----------|
| 8. (A) 자주 | 9. (A) 덜어 |
| (B) 마침    | (B) 들어    |
| (C) 드디어   | (C) 떨어    |
| (D) 좀처럼   | (D) 틀어    |
- 
- |            |                   |
|------------|-------------------|
| 10. (A) 섞여 | 11. (A) 해 본 적이 있다 |
| (B) 섞어     | (B) 해 본 적이 없다     |
| (C) 씹여     | (C) 하는 수가 있다      |
| (D) 씹게     | (D) 하는 수가 없다      |

**Sample Reading Questions**

**Directions:** Read the following selections carefully for comprehension. Each selection is followed by one or more questions or incomplete statements based on its content. Choose the answer or completion that is best according to the selection and fill in the corresponding circle on the answer sheet.

**Questions 12-13**

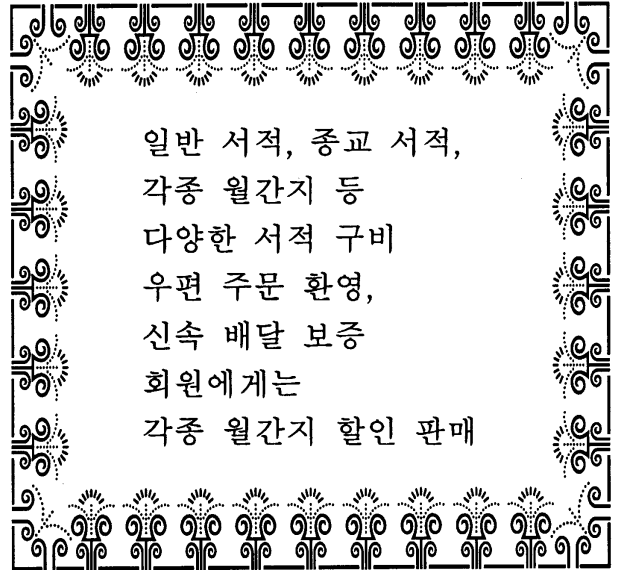

12. What kind of business is being advertised?  
 (A) A bookstore  
 (B) A gift shop  
 (C) A delivery service  
 (D) A drugstore
13. How can one receive a special discount?  
 (A) By mail order  
 (B) By using a credit card  
 (C) By membership  
 (D) By buying a large quantity

Questions 14-16

미국에 온 지 벌써 사 개월이 되었다. 여기 생활에 익숙해질 때까지 적어도 일 년쯤은 걸리지 않겠나 생각을 했는데, 미국 사람들이 몹시 친절하고 또 우리 학교 유학생 클럽에서 매주 한 번씩 미국 문화에 대한 세미나가 있기 때문에, 지금은 여기 생활에 조금도 불편을 느끼지 않을 정도가 되었다. 미국에는 여러 민족이 함께 살기 때문에, 다양한 문화를 이해하고 받아들이는 것도 대단히 중요하다. 미국에 오기 전에 사람들에게 영어를 꽤 편찮게 한다는 칭찬도 받아서 이 정도면 미국에 가서 큰 어려움은 없지 않을까 생각했는데, 잘못된 생각이었다. 역시 외국어는 그 나라 사람들하고 직접 같이 생활하면서 늘 써 보기 전에는 자신을 가질 수가 없다는 것을 알게 되었다. 외국어를 배운다는 것은 그 나라 말만 배우는 것이 아니라 사고방식, 문화까지 다 포함한다는 것을 재삼 깨달았다.

14. How long did the writer think it would take to get used to American life?
  - (A) About four months
  - (B) About four years
  - (C) At least a year
  - (D) A lifetime
15. What did the writer learn is important in American society?
  - (A) To accept cultural diversity
  - (B) To speak many languages
  - (C) To help international students
  - (D) To befriend many people
16. What does the writer think is the best way to become proficient in English?
  - (A) Memorizing a lot of vocabulary
  - (B) Attending various seminars
  - (C) Participating in student clubs
  - (D) Learning and thinking in English

**ANSWERS**

The estimated difficulty level, on a scale of 1 to 5, with 1 the easiest and 5 the most difficult, is in parentheses.

- |          |          |           |           |
|----------|----------|-----------|-----------|
| 1. C (2) | 5. C (3) | 9. C (3)  | 13. C (3) |
| 2. D (3) | 6. A (4) | 10. C (4) | 14. C (3) |
| 3. B (4) | 7. B (3) | 11. B (3) | 15. A (4) |
| 4. B (2) | 8. A (3) | 12. A (2) | 16. D (4) |

# Latin

One-hour subject test

## Purpose

- Measure wide-ranging knowledge of Latin

## Format

- 70–75 multiple-choice questions
- Only offered in December and June

## Content

Questions may require you to

- select appropriate grammatical forms of Latin words.
- choose Latin words from which English words are derived.
- translate from Latin to English.
- complete Latin sentences.
- choose alternate ways of expressing the same thought in Latin.
- answer a variety of questions based on short passages of prose or poetry.

The reading comprehension part has 30 to 37 questions based on three to five reading passages and one or two poetry passages. A set of questions following a poetry passage always includes one question requiring you to scan the first four feet of a line of dactylic hexameter verse or to determine the number of elisions in a line.

## Recommended Preparation

- 2–4 years of Latin study in high school (the equivalent of two to four semesters in college)
- Gradual development of competence in sight-reading Latin over a period of years

## Score

- Total score: 200–to–800 scale

## CONTENT

Approximate  
% of Test

### Skills Measured

Grammar and syntax	30
Derivatives	5
Translation and reading comprehension	65

## Sample Questions

Six types of questions are used in the Latin Subject Test. All questions in the test are multiple-choice questions in which you must choose the **BEST** response from the four choices offered.

**Note:** In some questions, variations of Latin terms will appear in parentheses.

**Directions:** In each statement below, you are asked to give a specific form of the underlined word. Select the correct form from the choices given. Then fill in the corresponding circle on the answer sheet.

1. The dative singular of senātus is  
(A) senātū (B) senātum  
(C) senātūs (D) senātuī
2. The nominative plural neuter of fortior is  
(A) fortiōrēs (B) fortiōrī  
(C) fortiōrum (D) fortiōra
3. The present subjunctive passive of capitis is  
(A) capiāminī (B) capiēminī  
(C) caperēminī (D) capiminī

**Directions:** Each of the following English sentences contains a word that is underlined. From among the choices, select the Latin word to which the underlined word is related by derivation. Then fill in the corresponding circle on the answer sheet.

4. The transition from adolescence to adulthood was easy.  
(A) sedere (B) ire  
(C) ferre (D) esse
5. All things are possible.  
(A) pōnō (B) possum  
(C) possideō (D) poscō

**Directions:** In each of the sentences below, part or all of the sentence is underlined. From among the choices, select the best translation for the underlined word or words. Then fill in the corresponding circle on the answer sheet.

6. Sī vocāvissēs, laetī fuissēmus.  
 (A) If you were calling  
 (B) If you had called  
 (C) If you are calling  
 (D) If you should call
7. Agricola dixit sē puellam vīsūrum esse.  
 (A) that he would see the girl  
 (B) that he had seen the girl  
 (C) that the girl would see him  
 (D) that they will see the girl
8. Iter mīlitibus faciendum est.  
 (A) The journey was made by the soldiers.  
 (B) The journey is being made by the soldiers.  
 (C) The soldiers must make a journey.  
 (D) The soldiers have made a journey.

**Directions:** Each of the sentences below contains a blank space indicating that a word or phrase has been omitted. For each blank, four completions are provided. Choose the word or phrase that best completes the sentence and fill in the corresponding circle on the answer sheet.

9. Servus . . . vulnerātur.  
 (A) ā saxō (B) saxum  
 (C) cum saxō (D) saxō
10. Vīdistī . . . patriam incolunt.  
 (A) quōs (B) quī  
 (C) quem (D) cui

**Directions:** In each of the sentences below, part or all of the sentence is underlined. Select from the choices the expression that, when substituted for the underlined portion of the sentence, changes the meaning of the sentence LEAST. Then fill in the corresponding circle on the answer sheet.

11. Fortēs ā consule semper laudantur.  
 (A) Consul ā fortibus semper laudātur.  
 (B) Consul fortēs semper laudat.  
 (C) Fortēs consulem semper laudant.  
 (D) Consulēs fortēs semper laudantur.
12. Cīvēs vērunt ut pācem peterent.  
 (A) ad pācem petendam  
 (B) pāce petītā  
 (C) sī pax peterētur  
 (D) postquam pax petēbātur

**Directions:** Read the following texts carefully for comprehension. Each is followed by a number of questions or incomplete statements. Select the answer or completion that is best according to the text and fill in the corresponding circle on the answer sheet.

#### Honors for an emperor

Cum igitur in amōre omnium Marcus Antonīnus bene rēgnāvisset, octāvō decimō annō imperīi suī mortuus est. Priusquam fūnus celebrātum est, senātus populusque eum deum esse dixit. Mox

Line (5) nēmō erat quī eius (ejus) imāginem in suā domō non habēret, hodiēque in multīs domibus Marcī Antonīnī statuae consistunt inter Penātēs. Neque dēfuerunt homines qui crēderent in somnīs eum multa quae vērā essent praedixisse.

13. In line 2, octāvō decimō annō is translated  
 (A) for eighteen years  
 (B) after eighteen years  
 (C) in the eighteenth year  
 (D) throughout the eighteenth year



14. The first two sentences (Cum . . . dixit) tell us that
- (A) Antoninus arranged his own funeral before he died
  - (B) everyone celebrated Antoninus' funeral for eighteen days
  - (C) a god told the senate and people to celebrate Antoninus' funeral
  - (D) Antoninus was proclaimed a god by the senate and people
15. In line 5, suā refers to
- (A) deum (line 4)
  - (B) nēmō (line 5)
  - (C) eius (ejus) (line 5)
  - (D) imāginem (line 5)
16. The third sentence (Mox . . . Penātēs) tells us that
- (A) Antoninus placed statues of the household gods in every home
  - (B) no one had a statue of Antoninus
  - (C) many statues of Antoninus replaced the household gods
  - (D) many houses had statues of Antoninus among the household gods

17. In line 9, praedixisse is translated
- (A) would predict
  - (B) had predicted
  - (C) predicts
  - (D) will have predicted
18. The last sentence (Neque . . . praedixisse) tells us that
- (A) people do not always believe their dreams
  - (B) Marcus Antoninus was believed to prophesy in dreams
  - (C) Marcus Antoninus believed in the truth of many dreams
  - (D) people predicted that many would believe their dreams

## ANSWERS

The estimated difficulty level, on a scale of 1 to 5, with 1 the easiest and 5 the most difficult, is in parentheses.

- |          |           |           |           |
|----------|-----------|-----------|-----------|
| 1. D (3) | 6. B (3)  | 11. B (4) | 16. D (3) |
| 2. D (3) | 7. A (4)  | 12. A (3) | 17. B (3) |
| 3. A (4) | 8. C (4)  | 13. C (3) | 18. B (4) |
| 4. B (3) | 9. D (3)  | 14. D (3) |           |
| 5. B (1) | 10. B (4) | 15. B (4) |           |

# Spanish and Spanish with Listening

One-hour subject tests

## Purpose

### Spanish Test

- Evaluate reading skills through precision of vocabulary structure use and comprehension of a variety of texts

### Spanish Test with Listening

- Measure the ability to understand written and spoken Spanish

## Format

### Spanish Test

- 85 multiple-choice questions
- Offered at all administrations except November

### Spanish Test with Listening

- 20 minutes listening and 40 minutes reading
- 85 multiple-choice listening and reading questions
- Only offered in November at designated test centers.

You must bring an acceptable CD player with earphones. See page 5.

## Content

Reading questions implicitly test vocabulary throughout the test, but some questions specifically test word meaning in the context of a sentence that reflects spoken or written language. Understanding of various parts of speech (nouns, verbs, adjectives, adverbs, etc.) and idiomatic expressions is tested. The reading section also asks:

**Structure Questions:** These questions ask you to identify usage that is both structurally correct and contextually appropriate. Other reading questions test vocabulary and grammatical usage in longer paragraphs.

**Reading Questions:** These questions are based on selections from prose fiction, historical works, newspaper and magazine articles, as well as

advertisements, flyers, and letters. They test points such as main and supporting ideas, themes, style, tone, and the spatial and temporal settings of a passage.

The listening section has three parts:

**Part A** questions ask you to identify the sentence that most accurately describes what is presented in a photograph or what someone in the photograph might say.

**Part B** questions test your ability to identify a plausible continuation of a short conversation.

**Part C** requires that you answer comprehension questions based on more extensive listening selections.

## Recommended Preparation

Both tests reflect general trends in high school curricula and are independent of particular textbooks or methods of instruction. Recommended preparation includes:

- 3–4 years of study in high school or the equivalent (2 years for advanced students)
- Gradual development of competence in Spanish over a period of years

### Spanish Test with Listening

- Review of sample listening questions using the practice CD available from your school counselor

## Score

- Total score: 200–to–800 scale
- Listening test: reading and listening subscores 20–to–80 scale

SPANISH		Approximate % of Test
<b>Skills Measured</b>		
Vocabulary and structure		33
Paragraph completion		33
Reading comprehension		33

SPANISH with LISTENING		Approximate % of Test
<b>Listening Section</b>	<b>(20 minutes/ approximately 30 questions)</b>	40
Pictures		
Rejoinders		
Selections		
<b>Reading Section</b>	<b>(40 minutes/ approximately 55 questions)</b>	60
Vocabulary and structure		
Paragraph completion		
Reading comprehension		

## Sample Reading Questions

There are three types of reading questions, grouped into separate parts. Each part accounts for approximately one-third of the total score. All questions in the test are multiple-choice questions in which you must choose the **BEST** response from the four choices offered.

### Part A

**Directions:** This part consists of a number of incomplete statements, each having four suggested completions. Select the most appropriate completion and fill in the corresponding circle on the answer sheet.

- En Córdoba, uno de los grandes centros culturales de España, se ----- libros del hebreo y del árabe al latín.  
(A) mudaban (B) trasladaban  
(C) impresionaban (D) traducían
- Los cubanos están muy orgullosos de ----- larga tradición folclórica.  
(A) suyos (B) sus  
(C) suya (D) su
- Se sabe que la playa de Luquillo es muy popular porque la gente de San Juan la visita ----- .  
(A) en resumidas cuentas (B) en punto  
(C) a medias (D) a menudo

- Si ----- en el Brasil, hablaríamos portugués y no español.  
(A) vivamos (B) vivimos  
(C) vivíamos (D) viviéramos

### Part B

**Directions:** In each of the following paragraphs, there are numbered blanks indicating that words or phrases have been omitted. For each numbered blank, four completions are provided. First, read through the entire passage. Then, for each numbered blank, choose the completion that is most appropriate given the context of the entire paragraph and fill in the corresponding circle on the answer sheet.

La máquina más infernal de hacer dinero se llama “Pedroso,” un osito electrónico que (5) ha derramado sobre sus fabricantes beneficios superiores a los 100 millones de dólares en el (6) año. La (7) de Pedroso es que habla. Claro, no hay ningún misterio en la cinta sin fin y el grabador (8) en el interior del osito. Pero lo (9) novedoso es que (10) hablar su boca se mueve en sincronía con las palabras y sus ojos pestañean. El juguete (11) vende a precios que oscilan entre 60 y 80 dólares.

- (A) todavía (B) nunca  
(C) ya (D) tampoco
- (A) primero (B) primer  
(C) primo (D) primario
- (A) oportunidad (B) mayoría  
(C) desventaja (D) particularidad
- (A) ocultos (B) lejanos  
(C) cobrados (D) llenos
- (A) verdaderamente (B) antiguamente  
(C) ansiosamente (D) perezosamente
- (A) del (B) en  
(C) al (D) de
- (A) se (B) le  
(C) lo (D) los

## Part C

**Directions:** Read the following texts carefully for comprehension. Each text is followed by a number of questions or incomplete statements. Select the answer or completion that is **BEST** according to the passage and fill in the corresponding circle on the answer sheet.

Alcanzó la carretera central y pisó el acelerador. Se cruzó con varios camiones del ejército y con una ambulancia de la Cruz Roja. Sara hablaba incoherentemente a su lado.

—Pararemos en algún lugar. Un café nos hará bien.

En Santa Fe cayeron las primeras gotas. Álvaro las vio caer en los cristales como frutas maduras y, a los pocos segundos, el espacio se convirtió en una cortina de agua. Era la lluvia violenta del trópico acompañada de un viento colérico y del fuego brutal de los relámpagos. Los limpiacristales oscilaban inútilmente en abanico con un ruido sordo.

12. ¿Dónde se desarrolla esta narración?  
(A) En una casa (B) En un automóvil  
(C) En un café (D) En un cuartel
13. ¿Qué desea Álvaro?  
(A) Abrir la cortina (B) Comer una fruta  
(C) Tomar un café (D) Encender la luz

**La tranquilidad de sentirse bien atendido**



Quando viaje por negocios, por ocio o por estudios, disfrute plenamente de la tranquilidad de viajar bien atendido con EUROPEA DE SEGUROS y despreocúpese de accidentes, asistencia médica, equipajes, anulaciones, demoras, etc. Viaje tranquilo. EUROPEA pone a su disposición el seguro más amplio y más completo para cada tipo de viaje.



COMPAÑÍA EUROPEA DE SEGUROS, S.A.

14. ¿Cuál de los siguientes beneficios ofrece esta compañía de seguros?  
(A) Reparación de autos  
(B) Ayuda financiera  
(C) Protección al viajar  
(D) Servicios de día y noche

15. ¿Qué característica se destaca más de la compañía anunciada?  
(A) Su precio  
(B) Su cortesía  
(C) Su rapidez  
(D) Su amplitud

## Sample Listening Questions

In addition to the types of reading questions discussed above, the Spanish Test with Listening has three types of *listening* questions that test your ability to understand spoken Spanish. Please note that in the actual test, the listening section comes first.

### Part A

**Directions:** For each question in this part, you will hear four sentences designated (A), (B), (C), and (D). They will not be printed in your test book. As you listen, look at the picture in your test book and select the choice that best reflects what you see in the picture or what someone in the picture might say. Then fill in the corresponding circle on your answer sheet. You will hear the choices only once.

You see:

1.



You hear:

[Número 1

- (Woman) (A) Siempre quise ser florista.  
(B) Sólo hay una persona haciendo cola.  
(C) Las cebollas están baratas hoy.  
(D) Creo que está por aquí.]

(7 seconds)

## Part B

**Directions:** In this part of the test you will hear several short conversations or parts of conversations, followed by four choices designated (A), (B), (C), and (D). After you hear the four choices, choose the one that most logically continues or completes the conversation and mark your answer on your answer sheet. Neither the conversations nor the choices will be printed in your test book.

You hear:

[Número 2

- (Woman)** Ana es una ciclista excelente.  
(A) Yo tengo una camiseta nueva.  
(B) La mía es mucho mejor.  
**(Man)** (C) Y además, es muy simpática.  
(D) La motocicleta también es buena.]

(7 seconds)

You hear:

[Número 3

- (Woman)** ¿Algo más, señor? Tenemos unas ofertas especiales hoy.  
**(Man)** No, gracias. ¿Puedo pagar con tarjeta de crédito?  
**(Woman)** (A) Claro que sí.  
(B) Salga usted ahora mismo.  
(C) No aceptamos monedas.  
(D) No, no tengo cambio.]

(7 seconds)

## Part C

**Directions:** You will now hear a series of selections. For each selection, you will see printed in your test book one or more questions with four possible answers. They will not be spoken. Select the best answer to each question from among the four choices printed and fill in the corresponding circle on your answer sheet. You will have twelve seconds to answer each question.

You hear:

[Selección número 1

- (Narrator)** Escuchen esta conversación en la taquilla del Teatro Colón.  
**(Man)** Buenas tardes, señorita. ¿Todavía hay entradas para el programa del sábado? Necesito dos.  
**(Woman)** No, ya no quedan.  
**(Man)** Entonces, ¿para el domingo?  
**(Woman)** Ah, sí, para el domingo sí hay.  
**(Man)** ¿Es el mismo programa?  
**(Woman)** No, es diferente; es un concierto de música clásica.  
**(Man)** Entonces, deme dos entradas, por favor.  
**(Narrator)** Ahora contesten las preguntas 4 y 5.]

(24 seconds)

You read:

Selección número 1

4. ¿Para cuándo quedan entradas?  
(A) Para la tarde.  
(B) Para el sábado.  
(C) Para el domingo.  
(D) Para la próxima semana.
5. ¿Qué programa presentan el domingo?  
(A) Una comedia.  
(B) Una ópera.  
(C) Un concierto.  
(D) Un ballet.

You hear:

[Selección número 2

**(Narrator)** Y ahora, el pronóstico del tiempo.

**(Man)** Para mañana se anuncian fuertes aguaceros en la zona de la costa. Posibilidad de inundaciones en algunas áreas. Temperatura máxima de 25 grados centígrados. Leve mejora a partir del sábado.

**(Narrator)** Ahora contesten la pregunta 6.]  
(12 seconds)

You read:

Selección número 2

6. ¿Qué se anuncia para el día siguiente?
- (A) Sol.
  - (B) Lluvia.
  - (C) Viento.
  - (D) Frío.

## ANSWERS

The estimated difficulty level, on a scale of 1 to 5, with 1 the easiest and 5 the most difficult, is in parentheses.

### Reading Questions

- |          |          |           |           |
|----------|----------|-----------|-----------|
| 1. D (2) | 5. C (3) | 9. A (3)  | 13. C (2) |
| 2. D (1) | 6. B (2) | 10. C (3) | 14. C (3) |
| 3. D (3) | 7. D (3) | 11. A (3) | 15. D (5) |
| 4. D (5) | 8. A (3) | 12. B (2) |           |

### Listening Questions

- |          |          |          |
|----------|----------|----------|
| 1. D (2) | 3. A (3) | 5. C (2) |
| 2. C (3) | 4. C (2) | 6. B (4) |

# The College Board SAT Subject Tests Development Committees, 2006-07

## Biology

Prue Talbot, University of California, Riverside, California, *Chair*  
Brenda Alston-Mills, North Carolina State University, North Carolina  
Susan Offner, Lexington High School, Lexington, Massachusetts  
Nancy E. Ramos, Northside Health Careers High School, San Antonio, Texas  
John Zarnetske, Hoosick Falls Central High School, Hoosick Falls, New York

## Chemistry

Alexander Grushow, Rider University, Lawrenceville, New Jersey, *Chair*  
Lenore Hoyt, University of Louisville, Louisville, Kentucky  
Melissa Mischke, Phillips Exeter Academy, Exeter, New Hampshire  
Pete Peterson, Francis Marion University, Florence, South Carolina  
Debra J. Reynolds, Northfield High School, Northfield, Minnesota

## Chinese

Tianwei Xie, California State University, Long Beach, California, *Chair*  
Cornelius Neil Kubler, Williams College, Williamstown, Massachusetts  
Joyce Fan Hwa Ranieri, Collegiate School, New York City, New York  
Meng Yeh, Rice University, Houston, Texas  
Min Zhang, The Indiana Academy and Ball State University, Muncie, Indiana

## French

Geneviève Delfosse, Thomas Jefferson High School, Alexandria, Virginia, *Chair*  
Nathan Bracher, Texas A&M University, College Station, Texas  
Thérèse O'Connell, Jacksonville University, Jacksonville, Florida  
Robert Peloquin, Boston College High School, Boston, Massachusetts  
Marjorie Salvodon, Suffolk University, Boston, Massachusetts

## German

Glenn Levine, University of California-Irvine, Irvine, California, *Chair*  
Marita Cleaver, McKinney High School, McKinney, Texas  
Craig Decker, Bates College, Lewiston, Maine  
John Lalande, State University of New York, Oswego, New York  
Deborah Lund, Ladue Horton Watkins High School, St. Louis, Missouri

## Modern Hebrew

Vardit Ringvald, Brandeis University, Waltham, Massachusetts, *Chair*  
Linda Alexander, Great Neck North High School, Great Neck, New York  
Orit Marmel, Ida Crown Jewish Academy, Chicago, Illinois

## (Modern Hebrew continued)

Rachel Moskowitz, Hillel Community Day School, North Miami Beach, Florida  
Yaron Peleg, George Washington University, Washington, D.C.

## Italian

Alessandro Vettori, Rutgers University, New Brunswick, New Jersey, *Chair*  
Tracy Barrett, Vanderbilt University, Nashville, Tennessee  
Judy Musante Branzburg, Lowell High School, San Francisco, California  
Mariastella Cocchiara, Melrose High School, Melrose, Massachusetts  
Marisa Trubiano, Montclair State University, Upper Montclair, New Jersey

## Japanese

Suwako Watanabe, Portland State University, Portland, Oregon, *Chair*  
Mr. Atsushi Fukuda, Purdue University, West Lafayette, Indiana  
Ms. Michiko Homann, Boston Latin Academy, Boston, Massachusetts  
Virginia Marcus, Washington University, St. Louis, Missouri  
Kazuo Tsuda, United Nations International School, New York City, New York

## Korean

Sungdai Cho, SUNY at Binghamton, Binghamton, New York, *Chair*  
Ah-Mi Cho, Lowell High School, San Francisco, California  
Wonsook Lee, Newtown High School, Elmhurst, New York  
Sang-suk Oh, Harvard University, Cambridge, Massachusetts  
Mee-Jeong Park, University of Hawaii at Manoa, Honolulu, Hawaii

## Latin

Margaret Brucia, Temple University Rome, Philadelphia, Pennsylvania, *Chair*  
Jane Crawford, University of Virginia, Charlottesville, Virginia  
David Demaine, Northfield Mount Hermon School, Northfield, Massachusetts  
Peter Howard, Troy University, Troy, Alabama  
Sherwin Little, Indian Hill High School, Cincinnati, Ohio

## Literature

Idris Anderson, Crystal Springs Uplands School, Hillsborough, California, *Chair*  
Cheng Lok Chua, California State University, Fresno, California  
Robin Inboden, Wittenberg University, Springfield, Ohio  
Edward Schmieder, Sayville High School, West Sayville, New York  
Jerry W. Ward, Dillard University, New Orleans, Louisiana

## Mathematics

Marie M. Vanisko, California State University-Stanislaus, Turlock, California, *Chair*  
Ann M. Davidian, General Douglas MacArthur High School, Levittown, New York  
Laurette Foster, Prairie View A&M University, Prairie View, Texas  
Phyllis Hillis, Oak Ridge High School, Oak Ridge, Tennessee  
Michael Ponisciak, LaSalle College High School, Wyndmoor, Pennsylvania

## Physics

Robert Jacobson, University of California, Berkeley, California, *Chair*  
Margaret Brinker, Chapparral High School, Parker, Colorado  
Jeff Funkhouser, Northwest High School, Justin, Texas  
Daniel Smith, South Carolina State University, Orangeburg, South Carolina  
Mary R. Yeomans, Hopewell Valley Central High School, Pennington, New Jersey

## Spanish

Carmen Silva-Corvalán, University of Southern California, Los Angeles, California, *Chair*  
María Asunción Gómez, Florida International University, Miami, Florida  
Mark A. Grudzien, Hall High School, West Hartford, Connecticut  
Lisa María Martínez, Dublin Coffman High School, Dublin, Ohio  
Edwin Padilla, University of Houston-Downtown, Houston, Texas

## U.S. History

Daniel Littlefield, University of South Carolina, Columbia, South Carolina, *Chair*  
Rosemary Kolks Ennis, Sycamore High School, Cincinnati, Ohio  
Joyce Goldberg, University of Texas-Arlington, Arlington, Texas  
Rich Mayorga, Sunnyside High School, Tucson, Arizona  
David Quigley, Boston College, Boston, Massachusetts

## World History

David Northrup, Boston College, Boston, Massachusetts, *Chair*  
Patricia L. Don, San Jose State University, San Jose, California  
Alan LeBaron, Kennesaw State University, Kennesaw, Georgia  
Ane Lintvedt, McDonogh School, Owings Mills, Maryland  
Angela Sperotto, Bellaire High School, Bellaire, Texas



# Prepare for the **SAT** **Subject Tests**<sup>™</sup> with Help from the **Test Maker**

The College Board provides the only books with  
official, full-length SAT Subject Tests.

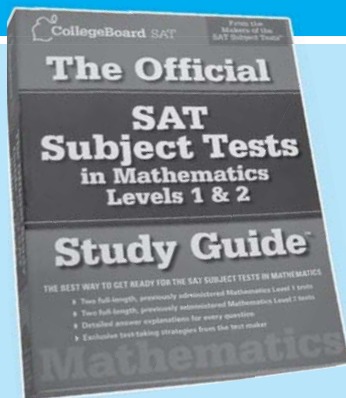

## The Official SAT Subject Tests in Mathematics Levels 1 & 2 Study Guide<sup>™</sup>

- Two previously administered **Mathematics Level 1** tests
- Two previously administered **Mathematics Level 2** tests
- Detailed answer explanations for every test question

## The Official SAT Subject Tests in U.S. and World History Study Guide<sup>™</sup>

- Two previously administered **U.S. History** tests
- Two previously administered **World History** tests
- Detailed answer explanations for every test question

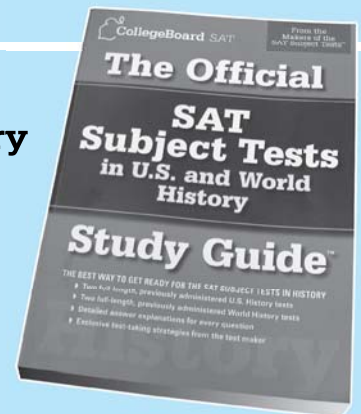

Order today! [store.collegeboard.com](http://store.collegeboard.com)

# 2007-08 SAT Program Test Calendar

Test Dates	OCT 6	NOV 3	DEC 1	JAN 26	MAR 1	MAY 3	JUN 7
<b>Registration Deadlines</b>							
Early (International)	N/A	Sep 12	Oct 10	Dec 5	N/A	Mar 12	Apr 16
Regular	Sep 10	Oct 2	Oct 30	Dec 26	Jan 29	Apr 1	May 6
Late	Sep 14	Oct 11	Nov 8	Jan 4	Feb 7	Apr 10	May 15
<b>SAT Reasoning Test</b>	■	■	■	■	■	■	■
<b>SAT Subject Tests</b>							
Literature							
Biology E/M, Chemistry, Physics	■	■	■	■		■	■
Mathematics Levels 1 & 2							
U.S. History							
World History			■				■
<b>Languages: Reading Only</b>							
French, Spanish	■		■	■		■	■
German, Modern Hebrew							■
Latin			■				■
Italian			■				
<b>Languages with Listening</b>							
Chinese, French, German, Japanese, Korean, and Spanish		■					

Register early, and no later than the regular registration deadline, if you want to take a Language Test with Listening. You may take only one listening test at that time (listening tests administered in November only).

Notes: If you miss a test, call Customer Service to reschedule (you will need to pay the test change fee).  
 Sunday test dates immediately follow the Saturday test dates.  
 Use the early international deadline when registering through an SAT International Representative or requesting the opening of an international test center closer to home. International registrations must be **received** by the deadlines; all others must be **postmarked** by the deadlines.

Admission Ticket Mailings	OCT 6	NOV 3	DEC 1	JAN 26	MAR 1	MAY 3	JUN 7
Begin Mail Date	Aug 13	Sep 10	Oct 8	Dec 3	Jan 7	Mar 10	Apr 14
End Mail Date	Sep 26	Oct 24	Nov 21	Jan 16	Feb 20	Apr 23	May 28

## Score Reports

Scores are available online and by phone several weeks after the test date. Official score reports are mailed about five weeks after the test. Some scores may take longer to report. Visit [www.collegeboard.com](http://www.collegeboard.com) for a list of approximate score availability dates.

### Take advantage of your full score report! Remember:

- Every time you send scores to a college or university, you and your counselor will see information about that institution matched up to your personal preferences on your score report.
- Your online score report provides important information to help you improve your scores. You'll also have access to majors lists and career planning ideas that fit your personal profile as well as suggested college matches based on your interests.

## Fees for 2007-08

### Test Fees

SAT Reasoning Test .....	\$43
Subject Tests	
Basic Subject Test Fee (per registration) .....	\$20
Language Test with Listening .....	add \$20
All Other Subject Tests .....	add \$8 each

### Additional Processing Fees (Add to Test Fees)

Register by phone.....	\$12
(available only if you have registered before)	
Change Fee (test type, center, or date change)....	\$21
Late Fee .....	\$22
Standby Fee (see note below) .....	\$37
International processing fee.....	\$25
Additional surcharge (India & Pakistan).....	\$22

Note: Standby testing is not allowed in Benin, Cameroon, Ghana, Kenya, Nigeria, or Togo.

### Fees for Receiving Your Scores

Scores by Web .....	FREE
Official Score Report (automatically mailed) .....	FREE
Scores by phone (per call) .....	\$12

### Fees for Sending Your Scores

Score report requests at registration.....	4 included
Additional score report requests* .....	\$9.50 each
Additional processing fees:	
Request by Web or mail.....	FREE
Request by phone (per call) .....	\$10
RUSH order (per order) .....	\$26.50
Scores retrieved from archive.....	\$20
(Additional fees may apply)	

### Student Answer Service Fees

SAT Question-and-Answer Service * .....	\$18
SAT Student Answer Service* .....	\$10

\*Fees are nonrefundable except as noted with an asterisk. You must have missed your test date to receive a refund for these services. Orders cannot be refunded, returned, or canceled after shipment.

### Additional Service Fees

Hand-Scoring/Score Verification Request:	
Multiple-choice score verification .....	\$50
Essay score verification .....	\$50
Refund processing fee .....	\$7
(for overpayments and duplicate payments)	

### Payment Notes

**Do not send cash.** We will return unprocessed all registrations and orders received with cash or checks drawn on non-U.S. banks or other forms of payment not listed as acceptable on [www.collegeboard.com](http://www.collegeboard.com). We reserve the right to electronically collect payments by check.

Checks returned to the College Board for insufficient funds will be re-presented electronically and your account will be debited for the amount of the check plus the state-allowed fee.

00272-00940 • WEBPDF77

737650

