

Dear valued customer,

To discover a De Dietrich product is to experience the range of unique emotions which only high-value items can produce.

The attraction is immediate, from the moment you set eyes on the product. The sheer quality of the design shines through thanks to the timeless style and outstanding finishes which make each appliance an elegant and refined little masterpiece in its own right, each in perfect harmony with the others.

Next, comes the irresistible urge to touch it. De Dietrich's design makes extensive use of robust and prestigious materials. The accent is placed firmly upon authenticity.

By combining state-of-the-art technology with top quality materials, De Dietrich produces beautifully crafted products to help you get the most from the culinary arts, a passion shared by all lovers of cooking and fine food.

We hope that you enjoy using this new appliance and we would love to receive your suggestions and to answer any questions you may have. Please feel free to contact our customer service department via our website.

To benefit from the many advantages offered by the brand, we recommend that you register your product at: www.de-dietrich.com.

Thank you for choosing a De Dietrich product.

De Dietrich

You can find a full range of information about the brand at www.de-dietrich.com

Visit the De Dietrich Gallery, 6 rue de la Pépinière (Paris eighth district)

Open from Tuesday to Saturday from 10 am to 7 pm

Customer service department: 0892 02 88 04

1 / INSTALLING YOUR APPLIANCE	
• Choice of location _____	03
• Build-in _____	03
• Connection _____	04
2 / USING YOUR APPLIANCE	
• Cookware for vitroceramics _____	05
• Description of your top _____	06
• Switching on _____	07
• Cooking zone with extension _____	07
• Safety features when operating _____	08
3 / MAINTAINING YOUR APPLIANCE	
• Caring for your appliance _____	09
• Maintaining your appliance _____	09
4 / COOKING CHART	
• Cooking chart per dish _____	10
5 / SPECIAL MESSAGES, INCIDENTS	
• When using for the first time _____	11
6 / AFTER SALES SERVICE _____	11

We are constantly improving our products; for this reason we reserve the right to make all modifications to their technical, functional or aesthetic characteristics, originating from technical developments.



Warning

This product is not foreseen for sale in the USA

Before installing and using your appliance please read this installation and use the guide carefully - it will help you familiarise yourself very rapidly with its operation.



As shown in this logo, the materials used to package this appliance are recyclable. Recycle them and play a role in protecting the environment by depositing them in local authority containers provided for this purpose.

Appliance recycling organised by your manufacturer will thus be undertaken in optimum conditions, in accordance with European directive 2002/96/CE relating to electrical and electronic equipment waste. Contact your local authority or retailer for how to have used appliances collected or collection points.

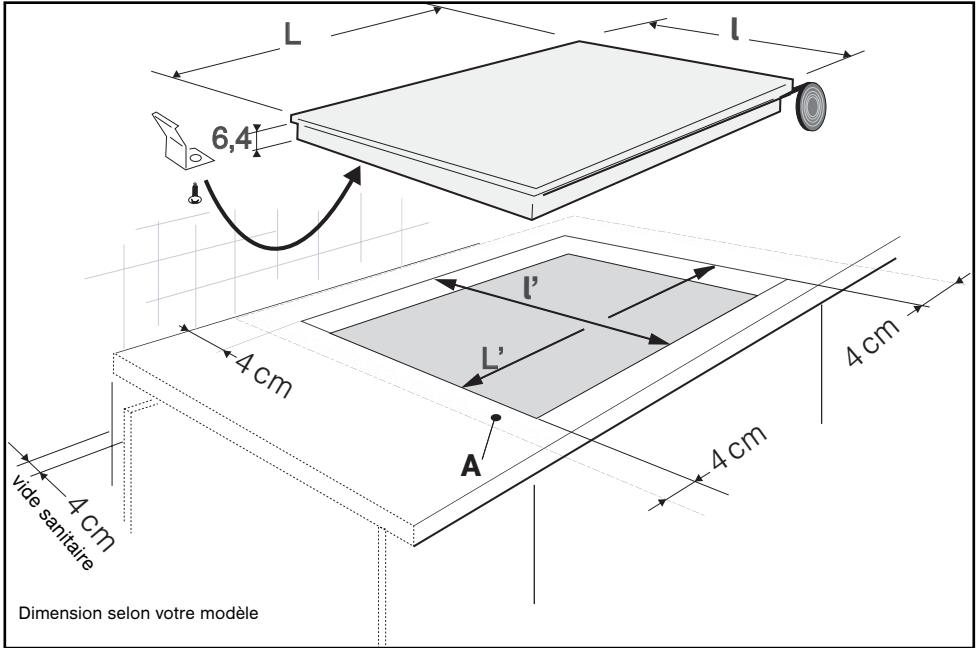

Installation

Your appliance should be positioned so that the mains switch is accessible.

The distance between the edge of your appliance and the wall or partition must be at least 4 cm.

The table can be directly embedded into the work surface :

- Above the oven in high position (min. distance 10mm)
- Above a drawer or a cupboard (fit a board under the table)

Stick the foam gasket to the bottom of your appliance. This will allow you to achieve an airtight seal with the worktop.

Attach the clips to the hob. (Depending on the model.)

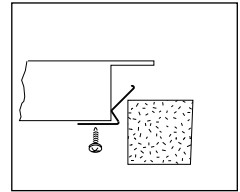
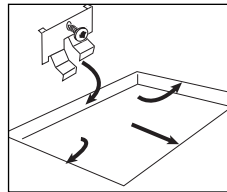

Connection

These hobs must be connected to the mains using a socket in compliance with publication CEI 60083 or an all-pole circuit-breaker device in compliance with the installation rules in force.

When power is first supplied to your hob, or after an extended power cut, an indicator light will appear on the control panel. This information will disappear after 30 seconds.

• Hook-up of 220-240V ~

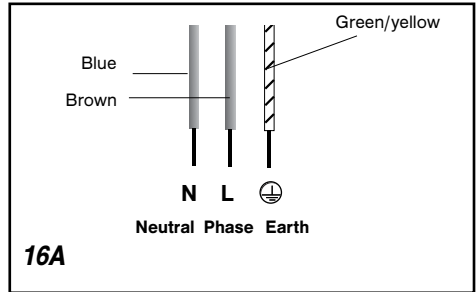
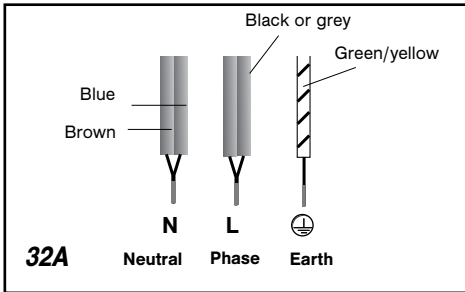

• Hook-up of 400V 2N ~ - 16A

Separate the 2 phase wires (L1 and L2) before connection.

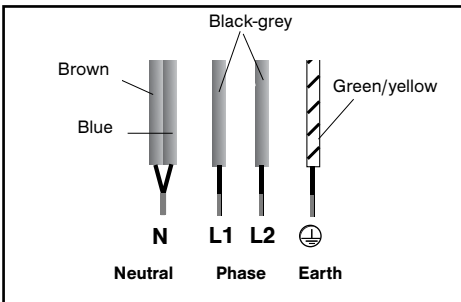

With hook-up of 400 V 2N three phase, verify that the neutral wire is properly connected.



Warning

If the cable is damaged it must be replaced by the manufacturer, its after-sales service or a person with a similar qualification to prevent danger.

We have designed this cooking hob for use by private individuals in their homes. These cooking hobs are intended exclusively for cooking beverages and foodstuffs and do not contain any asbestos-based materials.

This appliance is not intended to be used by persons (including children) with reduced physical, sensory or mental abilities, or persons lacking experience or awareness, unless using it with the help of a person responsible for their safety, or under supervision and with prior instruction in its use. Children should be supervised to ensure that they do not play with the appliance.

COOKWARE FOR VITROCERAMICS

• Cookware

It must be designed for electric cooking.

It must have a flat bottom.

Preferably use cookware made of:

- Stainless steel with a thick or "sandwich" three-metal bottom.
- Aluminium with a thick smooth bottom.
- Enamelled steel

• Use

A higher setting is required if:

- there are large quantities
- the cookware has no lid
- a glass or ceramic pan is used.

A lower setting is required if:

- cooking food which has a tendency to burn easily (start with a lower setting - the setting can be increased if necessary).
- a spill occurs (remove the lid or remove the pan, then reduce the setting).

• Energy saving:

To finish the cooking, set at position 0, leaving the cookware in position to use the accumulated heat (this will save energy).

Use a lid as often as possible to reduce heat loss by evaporation.

• Automatic regulation of rings

The rings are regulated automatically; they switch on and off to maintain the selected power level. The temperature thus remains uniform and appropriate for cooking your food.

The regulation frequency varies according to the selected power level.



Tip

Use cookware of an appropriate size. The diameter of the bottom of the cookware must be the same as or greater than the printed zone.

Do not leave empty cookware on a cooking zone.

Do not leave cookware containing hot oil or fat unsupervised on a cooking zone.

- **Description of your top**

DTV1101

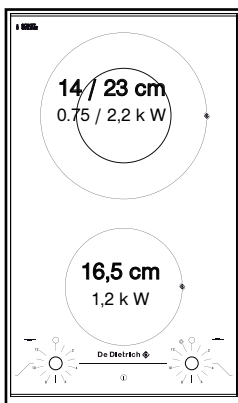

Total dimensions (L x l) -

DTV1101 X : 30 x 50.7

Recess cut-out (L' x l')

DTV1101 X : 26.5 x 49

DTV1103

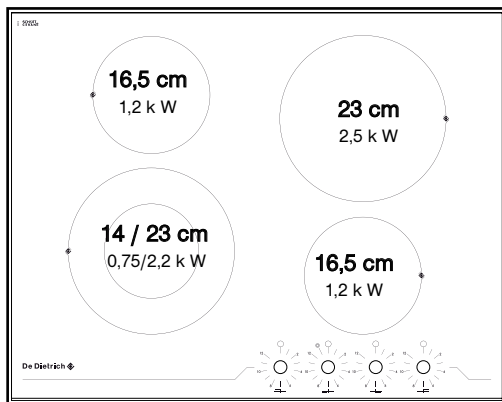

Total dimensions (L x l) -

DTV1103 X : 65 x 51.4

Recess cut-out (L' x l')

DTV1103 X : 56 x 49

- **TURNING IT ON**

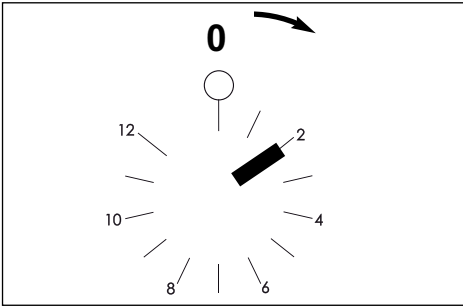

- **COOKING ZONE WITH EXTENSION**

1 Turn the lever in a clockwise direction until it clicks into position 12.

2 Now set the power level for your heating zone.

To remove the additional zones:

Set the lever to 0, and set the power level for your heating zone.

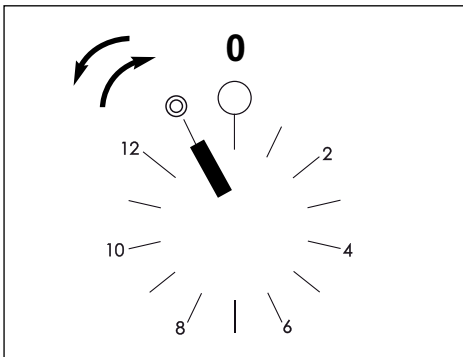

Safety while using

• Residual heat

As long as a cooking zone being used is hot, the indicator light corresponding to that zone is on.

Do not put your hand on this zone.

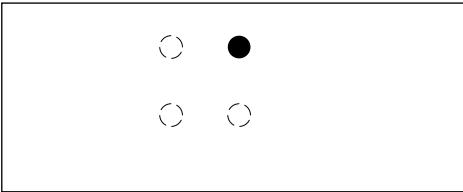

Warning

Do not touch the cooking zones, you will risk getting burned.



Electrical danger

Ensure that the power cable of a connected electrical appliance near the hob is not in contact with the cooking zones.

If a crack appears in the surface of the glass disconnect your appliance immediately to prevent a risk of electric shock.

To do this, remove the fuses or use the circuit breaker.

Do not use your hob until you have replaced the glass worktop.



Warning

Do not stare at the halogen lamps in the cooking zones.

Preserve your appliance

The vitroceramic glass surface is highly resistant, but not unbreakable. Here are some recommendations for increasing its lifetime:

- Avoid banging or clattering the cookware.
- Avoid putting heating covers on the hob. A suction effect may damage the vitroceramic surface.
- Do not use cookware with bottoms that are rough or dented.
- Do not use your cooking hob as a work surface.
- Never use aluminium foil or paper or aluminium scrubber to clean it. The aluminium melts and damages the top.
- Never use a steam cleaner to clean your hob.

- Never directly reheat a tin can. It will have a risk of exploding.

Aesthetic faults, as a result of mistreatment of your hob and which do not entail a lack of function, are not covered by our guarantee.

And for the safety of your kitchen, do not place cleaning items or inflammable objects or products in the kitchen furniture underneath your cooking hob.

Maintaining your appliance

TYPES OF STAINS/SPOTS	USE	WHAT TO DO?
Light.	Cleaning sponges	Thoroughly moisten the zone to be cleaned with hot water, then wipe off.
Accumulation of baked-on stains/dirt. Sugar spills, melted plastics.	Cleaning sponges Scraper for glass.	Thoroughly moisten the zone to be cleaned with hot water. Use a scraper for glass to remove the large bits, follow with the rough side of a disinfectant sponge, and then wipe off.
Rings and hard water residue.	White vinegar.	Apply warm white vinegar to the stain, let stand, then wipe with a soft cloth.
Shiny metal colourings. Weekly maintenance.	Special vitroceramic glass product.	Apply a cleaning agent for vitroceramic glass (preferable one with silicon for its protective properties) to the surface.



cream



cleaning sponge
special for delicate crockery



powder



abrasive sponge

• COOKING CHART

		FRY BRING TO A BOIL		COOK/BROWN RETURN TO BOILING BOILING LIGHT BROTHS		COOK/SIMMER			KEEP WARM	
		12	11	10	7	6	4	3	2	1
SOUPS	BROTHS						●			
	THICK SOUPS								●	
FISH	COURT BOUILLON				●					
	FROZEN FOODS					●				
SAUCE	THICK, FLOUR-BASED								●	
	BUTTER-BASED WITH EGGS (BEARNAISE, HOLLANDAISE)									●
	PREPARED SAUCES									●
		12	11	10	7	6	4	3	2	1
VEGETABLES	ENDIVES, SPINACH						●			
	DRIED BEANS						●			
	BOILED POTATOES						●			
	GOLDEN BROWN POTATOES					●				
	SAUTEED POTATOES					●				
	DEFROSTING VEGETABLES						●			
MEAT	MEAT, NOT TOO THICK	●								
	STEAKS, IN SKILLET				●					
	GRILLED MEATS (CAST IRON GRILL)	●								
FRYING	FROZEN FRENCH FRIES	●								
	FRESH FRENCH FRIES	●								
		12	11	10	7	6	4	3	2	1
MISCELLANEOUS	PRESSURE COOKER (ONCE IT STARTS WHISTLING)						●			
	COMPOTES								●	
	CRÊPES			●						
	CRÈME ANGLAISE									●
	MELTED CHOCOLATE									●
	JAMS				●					
	MILK						●			
	EGGS, FRIED				●					
	PASTA					●				
	JARS OF BABY FOOD (DOUBLE BOILER)									●
	MEAT STEW						●			
	SPANISH RICE					●				
	RICE PUDDING								●	

• ***On first use***

	<i>POSSIBLE CAUSES:</i>	<i>WHAT SHOULD YOU DO?</i>
A special lamp appears.	Working normally.	Nothing, the light disappears after 30 seconds.
Your installation blows a fuse.	The electrical connection of your hob is incorrect.	Check that it is set up properly. See the “Electrical Connection” section.
Only one side works.		



In case of breakage, cracks or even light fissures in the vitroc ceramic glass, take out the fuses or turn off the circuit breaker for your hob to avoid the risk of electrical shock.

Contact the After-Sales Service Department.

In the unlikely event of there being a problem with your appliances please call the number below quoting the model number of your appliance - this can be found on the rating plate. Our trained staff are available to advise or book a service call with one of our authorized service agents.

PRODUCT WARRANTY

1. Subject to the "Statement of Standard Warranty Conditions" this product is covered by the following Warranty.

TWO (2) YEARS WARRANTY from date of purchase, covering all parts and labour.

2. The appliance is warranted under normal single family domestic installation and use, as set out in the user manual, against manufacturing defects for the Warranty periods shown above.

3. Should service be required under this Warranty, the purchaser should contact an approved DE DIETRICH Service Provider during their normal business hours.

4. At no time does DE DIETRICH have liability for any freight or transportation costs or for any damage during transit or for any consequence of failure of this appliance outside of the normal service area, unless such limitation of liability is prohibited by statute.

5. This Warranty excludes replacement of parts required due to normal wear and tear including light globes.

6. This Warranty only applies, provided the appliance has been used in accordance with the manufacturer's instructions and provided an accident, misuse, neglect or abuse has not damaged the appliance.

7. None of the above Warranties purport to exclude, restrict or modify either the application or the exercise of a right conferred by any applicable Statute.

8. Please complete the details below, which should be retained for future reference along with your proof of purchase:

Date of Purchase:

Model No:

Serial No:

Notice to Victorian Customers from the Victorian Plumbing Industry Commission.

This product must be installed by a licensed person as required by the Victorian Building Act 1993.

Only a licensed person will give you a Compliance Certificate, showing that the work complies with all the relevant standards. Only a licensed person will have insurance protecting their workmanship for 6 years. Make sure you use a licensed person to install this product and ask for your Compliance Certificate.

STATEMENT OF STANDARD WARRANTY CONDITIONS

1. The Warranty only applies provided that the appliance has been used in accordance with the manufacturer's instructions and provided that the appliance has not been damaged by an accident, misuse, neglect or abuse of any person other than the manufacturer or **MEA** or from faulty installation, mis-adjustment or tampering by unauthorised persons.

2. When a service inspection reveals the alleged fault or faults are caused by incorrect operation, contrary to the instruction manual, and otherwise the appliance is in good order and working condition, the purchaser shall be liable for a service fee charged by **MEA** or one of its' Service Providers.

3. If the appliance is used in Commercial Applications or for Rental purposes, a separate warranty of Twelve (12) months covering all parts with Three (3) months on the labour will apply.

4. Subject to the provisions of any applicable statute this Warranty applies to the original retail purchaser only and is not transferable.

5. Subject to the provisions of any applicable statute, at no time does **MEA** have liability for freight, transport or travel costs outside normal service areas.

6. None of the above Warranties purport to exclude, restrict or modify either the application or the exercise of a right conferred by any applicable statute.

7. Subject to any Warranties implied by statute, at no time will MEA or its' Service Providers be liable for any economic loss consequent upon the failure of the appliance.

8. This Warranty is only valid for **De Dietrich** major appliances imported and distributed by **MEA**, purchased and used in Australia.