

DEPARTMENT OF THE ARMY
30TH MILITARY POLICE DETACHMENT (DSE) (CID) (DEPLOYED)
3RD MILITARY POLICE GROUP, USACIDC
FORT STEWART, GA 31314

CIRC-BAS

31 May 03

MEMORANDUM FOR SEE DISTRIBUTION

SUBJECT: CID REPORT OF INVESTIGATION – FINAL (C) - 0055-03-CID349-59657-5Y2P4/7J9C2/5Y2N3/5Y2C/5Y2G4/5X2/7X2

DATES/TIMES/LOCATIONS OF OCCURRENCES:

1. 22 APR 03/0001 – 18 MAY 03/1800. VARIOUS LOCATIONS WITHIN NORTHEAST SECTOR OF BAGHDAD, IRAQ

DATE/TIME REPORTED: 20 MAY 2003. 1100

INVESTIGATED BY: SA *b7c-1, b6-1, b2* SA *b7c-1, b6-1, b2* SA

SUBJECTS: 1. *b7c-5, b6-5* CPT: *b7c-5, b6-5*
[MALE; OTHER; HHC, 3/69th ARMOR (DEPLOYED), FORT STEWART, GA 31314; [AIDING THE ENEMY] [DEALING/SELLING/TRADING CAPTURED PROPERTY] [MISBEHAVIOR BEFORE THE ENEMY] [FAILURE TO OBEY ORDER OR REGULATION] [CONDUCT UNBECOMING AN OFFICER] [LARCENY]

b7c-5, b6-5 2. *b7c-5, b6-5* SGT: *b7c-5, b6-5*
[HHC, 3/69th ARMOR (DEPLOYED), FORT STEWART, GA 31314; [AIDING THE ENEMY] [DEALING/SELLING/TRADING CAPTURED PROPERTY] [FAILURE TO OBEY ORDER OR REGULATION] [LARCENY] [WILLFUL DISCHARGE OF A WEAPON]

3. *b7c-5, b6-5* SFC: *b7c-5, b6-5*
[HHC, 3/69th ARMOR (DEPLOYED), FORT STEWART, GA 31314; [AIDING THE ENEMY] [DEALING/SELLING/TRADING CAPTURED PROPERTY] [MISBEHAVIOR BEFORE THE ENEMY] [FAILURE TO OBEY ORDER OR REGULATION] [LARCENY] [WILLFUL DISCHARGE OF A WEAPON]

b7c-5, b6-5 4. *b7c-5, b6-5* PFC: *b7c-5, b6-5*
[HHC, 3/69th ARMOR (DEPLOYED), FORT STEWART, GA 31314; [AIDING THE ENEMY] [FAILURE TO OBEY ORDER OR REGULATION]

FOR OFFICIAL USE ONLY

5. [REDACTED] SGT; [REDACTED] HHC, 3/69TH ARMOR (DEPLOYED), FORT STEWART, GA 31314; [AIDING THE ENEMY] [DEALING/SELLING/TRADING CAPTURED PROPERTY] [FALSE OFFICIAL STATEMENT]

6. [REDACTED] PFC; [REDACTED] HHC, 3/69TH ARMOR (DEPLOYED), FORT STEWART, GA 31314; [AIDING THE ENEMY] [DEALING/SELLING/TRADING CAPTURED PROPERTY] [FAILURE TO OBEY ORDER OR REGULATION]

VICTIM: 1. U.S. GOVERNMENT; [AIDING THE ENEMY] [DEALING/SELLING/TRADING CAPTURED PROPERTY] [MISBEHAVIOR BEFORE THE ENEMY] [FAILURE TO OBEY ORDER OR REGULATION] [WILLFUL DISCHARGE OF A WEAPON] [FALSE OFFICIAL STATEMENT] [CONDUCT UNBECOMING AN OFFICER]

2. UNKNOWN IRAQI CITIZENS [NFI]; [LARCENY]

INVESTIGATIVE SUMMARY:

"This is an Operation Iraqi Freedom investigation"

This office was notified by the 3rd Infantry Division Tactical Operations Center of an unlawful weapons transfer to an Iraqi civilian.

Investigation established probable cause to believe [REDACTED] and [REDACTED] committed the above listed offenses when they provided or traded seized weapons to Mr. [REDACTED], a suspected member of the Fedaheen, allowed Mr. [REDACTED] unescorted access to their platoons secure area, consumed and/or accepted alcoholic beverages from Iraqi citizens, stole money and weapons from Iraqi citizens. Further, [REDACTED] acts also established probable cause to believe he committed the offense of Conduct Unbecoming an Officer and [REDACTED] and [REDACTED] committed the offense of Willful Discharge of a Weapon when they fired an undetermined number of seized weapons. . .

Investigation also established probable cause to believe [REDACTED] committed the above listed offenses when he warned Mr. [REDACTED] to stay away from the platoon area due to an impending investigation and consumed alcoholic beverages, [REDACTED] committed the above listed offenses when he provided a seized weapon to Mr. [REDACTED], and [REDACTED] committed the above listed offenses when he traded a seized weapon to Mr. [REDACTED] and consumed alcoholic beverages.

- STATUTES: Article 92. UCMJ: Failure to Obey Order or Regulation
Article 99. UCMJ: Misbehavior before the Enemy
Article 103. UCMJ: Dealing/Selling/Trading Captured Property
Article 104. UCMJ: Aiding the Enemy

FOR OFFICIAL USE ONLY

Article 107, UCMJ: False Official Statement
 Article 121, UCMJ: Larceny
 Article 133, UCMJ: Conduct Unbecoming an Officer
 Article 134, UCMJ: Willful Discharge of a Firearm

EXHIBITS/SUBSTANTIATION:

Attached:

1. Agent's Investigation Report (AIR) of SA [REDACTED] 29 May 03, detailing the initial notification, coordination with the Office of the Staff Judge Advocate (SJA), obtaining the Commander's Inquiry Packet, interviews of SGT [REDACTED] CPT [REDACTED], and SFC [REDACTED] [REDACTED], collection of evidence, interviews of SGT [REDACTED] PV2 [REDACTED] SPC [REDACTED] PFC [REDACTED] Mr [REDACTED] PFC [REDACTED] SPC [REDACTED] SGT [REDACTED] PV2 [REDACTED] SPC [REDACTED] PFC [REDACTED] PFC [REDACTED] L, results of law enforcement name checks, interviews of PFC [REDACTED] PFC [REDACTED] PFC [REDACTED] CPT [REDACTED] CPT [REDACTED] CPL [REDACTED] PFC [REDACTED] command coordination, and the interviews of Mr [REDACTED] and Mr [REDACTED]
2. Commander's Inquiry Packet, 19 May 03, containing the documentation of the actions taken by the commander.
3. Non-Waiver Certificate, 20 May 03, concerning SGT [REDACTED]
4. Non-Waiver Certificate, 20 May 03, concerning CPT [REDACTED]
5. Waiver Certificate and Sworn Statement of SFC [REDACTED] 20 May 03, in which he confessed to numerous criminal offenses.
6. Waiver Certificate and Sworn Statement of SGT [REDACTED] 20 May 03, detailing his knowledge of the incident.
7. Sworn Statement of PV2 [REDACTED] 20 May 03, detailing his knowledge of the incident.
8. Sworn Statement of PFC [REDACTED] 21 May 03, detailing his knowledge of the incident.
9. Waiver Certificate and Sworn Statement of Mr [REDACTED] 21 May 03, in which he confessed to receiving weapons from soldiers.
10. Waiver Certificate and Sworn Statement of PFC [REDACTED] 21 May 03, in which he confessed to warning Mr [REDACTED] of an impending investigation and consuming alcohol.
11. Sworn Statement of SPC [REDACTED] 21 May 03, detailing his knowledge of the incident

12. Sworn Statement of SGT [REDACTED] 21 May 03, detailing his knowledge of the incident.
13. Sworn Statement of PV2 [REDACTED] 21 May 03, detailing his knowledge of the incident.
14. Sworn Statement of SPC [REDACTED] 21 May 03, detailing his knowledge of the incident.
15. Sworn Statement of PFC [REDACTED] 21 May 03, detailing his knowledge of the incident.
16. Sworn Statement of PFC [REDACTED] 21 May 03, detailing his knowledge of the incident.
17. Waiver Certificate and Sworn Statement of SGT [REDACTED] 21 May 03, in which he confessed to giving Mr [REDACTED] a weapon.
18. Waiver Certificate and Sworn Statement of PFC [REDACTED] 24 May 03, in which he confessed to trading a weapon with Mr [REDACTED].
19. Sworn Statement of CPT [REDACTED] 24 May 03, detailing his knowledge of the incident.
20. Sworn Statement of CPT [REDACTED] 24 May 03, detailing his knowledge of the incident.
21. Sworn Statement of PFC [REDACTED] 24 May 03, detailing his knowledge of the incident.
22. AIR of SA [REDACTED] 20 May 03, detailing the crime scene examination.
23. Crime Scene Sketch, 20 May 03, prepared by SA [REDACTED].
24. Contact sheet containing crime scene photographs.
25. Compact Disk, 030055.349, containing the originals of Exhibit 24 (USACRC copy only).
26. (1-4) Evidence/Property Custody Document, 20 May 03, Document Number (DN) 0019-03, 0020-03, 0021-03, and 0022-03.

Not Attached: Retained in the 3rd MP Group Consolidated Evidence Depository.

27. Box containing numerous items of jewelry, 256,600 Iraqi Dinars, and weapons (Item 1, DN, 0019-03).
28. Box containing cigars (Item 1, DN 0020-03).
29. Box containing cigars and assorted knives (Item 2, DN 0020-03).
30. Box containing cigars (Item 1, DN 0021-03).
31. Sight telescope (Item 2, DN 0021-03).

- 32. Rifle. AK47 (Item 3, DN 0021-03).
- 33. Rifle, brand Enfield (Item 4, DN 0021-03).
- 34. Lighter, cigarette (Item 5, DN 0021-03).
- 35. (2) Pistol, unknown type (Item 6, DN 0021-03).
- 36. Pistol, brand Beretta (Item 7, DN 0021-03).
- 37. Pistol, brand Sig Sauer (Item 8, DN 0021-03).
- 38. Box containing liquor and magazines.

The originals of Exhibits I through 25 are forwarded with the USACRC copy of this report. The originals of Exhibit 26 are maintained in the 3rd MP Group Consolidated Evidence Room, Camp Arifjan, Kuwait APA AE 09336.

STATUS: This is a Final (C) Report. This investigation was terminated IAW CIDR 195-1 paragraph 4-17a (4) in that the supported SJA is of the opinion that sufficient admissible evidence is available to prosecute the subjects. that additional investigation would produce only cumulative and unneeded evidence, and that the identification of additional subjects or offenses is unlikely. Commander's Report of Disciplinary Action Taken (DA Form 4833) is pending

LEADS REMAINING: Locate, fully identify and interview PFC [redacted] (NFI), Dr [redacted], Dr [redacted] and the Italian Military Officer (NFI).

Report Prepared By:

Report Approved By:

[redacted]
Special Agent,

[redacted]
Special Agent in Charge

DISTRIBUTION:

- 1 - DIR, USACRC (Originals)
- 1 - CDR. 3/69th Armor
- 1 - PMO. 3ID
- 1 - SJA. 3ID
- 1 - File

AGENT'S INVESTIGATIVE REPORT CID Regulation 195-1		ROI NUMBER 0055-03-CID349-59657	
		PAGE 1 OF 5 PAGES	
DETAILS			
About 1100, 20 May 03, this office was notified by the 3 rd Infantry Division Tactical Operations Center (TOC) of numerous unlawful weapon transfers to an Iraqi civilian.			
About 1300, 20 May 03, SA [redacted] ^{b7c-1, b6-1} and SA [redacted] ^{b7c-1, b6-1} coordinated with CPT [redacted] ^{b7c-1, b6-1} Trial Counsel, 1 st Brigade, Fort Stewart, GA (FSGA), who provided a brief concerning the incidents.			
About 1400, 20 May 03, SA [redacted] ^{b7c-1, b6-1} obtained the Commander's Inquiry Packet which contained all statements and other related documents to this investigation (see Commander's Inquiry Packet for details).			
AGENT'S COMMENT: [redacted] ^{b7c-1, b6-1} who is frequently mentioned throughout statements is the nickname of Mr [redacted] ^{b7c-1, b6-1} Iraqi Citizen.			
About 1500, 20 May 03, SA [redacted] ^{b7c-1, b6-1} , advised SGT [redacted] ^{b7c-5, b6-5} of his rights, which he invoked and requested an attorney.			
About 1503, 20 May 03, SA [redacted] ^{b7c-1, b6-1} advised CPT [redacted] ^{b7c-5, b6-5} of his rights, which he invoked and requested an attorney.			
About 1515, 20 May 03, SA [redacted] ^{b7c-1, b6-1 b2} advised SFC [redacted] ^{b7c-5, b6-5} of his rights, which he waived a provided a sworn statement confessing to numerous criminal offenses (see statement for details).			
AGENT'S COMMENT: SFC [redacted] ^{b7c-5, b6-5} denied that he knowing allowed [redacted] ^{b7c-4, b6-4} access to any privileged information, although he admitted that by allowing him into the unit area, [redacted] ^{b7c-4, b6-4} may have overheard some briefings. SFC [redacted] ^{b7c-5, b6-5} admitted he compromised unit safety by allowing [redacted] ^{b7c-4, b6-4} into the building when briefings were taking place. Also, SFC [redacted] ^{b7c-5, b6-5} admitted that the days after he gave [redacted] ^{b7c-5, b6-5} the two weapons, he (SFC [redacted] ^{b7c-5, b6-5} received gifts from him, knowing the gifts were repayment for the weapons.			
Between 1520 and 1745, 20 May 03, SA [redacted] ^{b7c-1, b6-1} collected as evidence various items seized from the living areas of CPT [redacted] ^{b7c-5, b6-5} , SFC [redacted] ^{b7c-5, b6-5} and SGT [redacted] ^{b7c-5, b6-5} (see Evidence/Property Custody Document for details).			
TYPED AGENT'S NAME AND SEQUENCE NUMBER SA [redacted] ^{b7c-1, b6-1, b2}		ORGANIZATION 30 th MF Det (DSE) (CID), 3rd MF GRP (CID), Fort Stewart, GA, 31314	
SIGNATURE [redacted]		DATE 29 May 03	EXHIBIT 1

CID FORM 94
1 FEB 77

FOR OFFICIAL USE ONLY

AGENT'S INVESTIGATIVE REPORT <small>CID Regulation 195-1</small>		ROI NUMBER 0055-03-CID349-59657
		PAGE 2 OF 5 PAGES
DETAILS About 1600, 20 May 03, SA [redacted] ^{b7c-1, b6-1} advised SGT [redacted] ^{b7c-1, b6-4} of his rights, which he waived and provided a sworn statement denying he ever saw anyone provide weapons to Iraqi citizens (see sworn statement for details). About 1810, 21 May 03, SA [redacted] ^{b7c-1, b6-1} interviewed PV2 [redacted] ^{b7c-1, b6-4} , HHC, 3/69 th Armor, FSGA, who provided a sworn statement detailing his knowledge of the incident (see sworn statement for details). About 1200, 21 May 03, SA [redacted] ^{b7c-1, b6-1} interviewed SPC [redacted] ^{b7c-4, b6-4} 4251, HHC, 3/69 th Armor, FSGA, who stated he did smell the odor of alcoholic beverages in SFC [redacted] ^{b7c-1, b6-1} living area and did hear SFC [redacted] ^{b7c-1, b6-1} say he wanted alcohol on one occasion. About 1232, 21 May 03, SA [redacted] ^{b7c-1, b6-1} interviewed PFC [redacted] ^{b7c-4, b6-4} , HHC, 3/69 th Armor, FSGA, who provided a sworn statement detailing his knowledge of the incident (see sworn statement for details). About 1245, 21 May 03, SA [redacted] ^{b7c-1, b6-1} advised Mr [redacted] ^{b7c-4, b6-4} , Iraqi Citizen, of his rights, which he waived and provided a sworn statement confessing to receiving numerous weapons from U.S. soldiers (see sworn statement for details). About 1300, 21 May 03, SA [redacted] ^{b7c-1, b6-1} advised PFC [redacted] ^{b7c-1, b6-4} of his rights, which he waived and provided a sworn statement confessing to consuming alcohol and telling Mr [redacted] ^{b7c-4, b6-4} to stay away from the unit area (see sworn statement for details). About 1321, 21 May 03, SA [redacted] ^{b7c-1, b6-1} interviewed SPC [redacted] ^{b7c-4, b6-4} , HHC, 3/69 th Armor, FSGA, who provided a sworn statement detailing his knowledge of the incident (see sworn statement for details). About 1541, 21 May 03, SA [redacted] ^{b7c-1, b6-1} interviewed SGT [redacted] ^{b7c-4, b6-4} , HHC, 3/69 th Armor, FSGA, who provided a sworn statement detailing his knowledge of the incident (see sworn statement for details). About 1616, 21 May 03, SA [redacted] ^{b7c-1, b6-1} interviewed PV2 [redacted] ^{b7c-4, b6-4} , HHC, 3/69 th Armor, FSGA, who provided a sworn statement detailing his knowledge of the incident (see sworn statement for details).		
TYPED AGENT'S NAME AND SEQUENCE NUMBER SA [redacted] ^{b7c-1, b6-1, b2}		ORGANIZATION 30 th MP Det (DSE) (CID), 3rd MP GRP (CID), Fort Stewart, GA, 31314
SIGNATURE [redacted]	DATE 29 May 03	EXHIBIT 1

CID FORM 94
1 FEB 77

FOR OFFICIAL USE ONLY

AGENT'S INVESTIGATIVE REPORT

CID Regulation 195-1

ROI NUMBER

0055-03-CID349-59657

PAGE 3 OF 5 PAGES

DETAILS

About 1638, 21 May 03, SA [redacted] interviewed SPC [redacted], HHC, 3/69th Armor, FSGA, who provided a sworn statement detailing his knowledge of the incident (see sworn statement for details).

About 1654, 21 May 03, SA [redacted] interviewed PFC [redacted], HHC, 3/69th Armor, FSGA, who provided a sworn statement detailing his knowledge of the incident (see sworn statement for details).

About 1705, 21 May 03, SA [redacted] interviewed PFC [redacted], HHC, 3/69th Armor, FSGA, who provided a sworn statement detailing his knowledge of the incident (see sworn statement for details).

AGENT'S COMMENT: PFC [redacted] admitted to consuming alcoholic beverages, which was referred to the command for action.

About 1745, 21 May 03, SA [redacted] advised SGT [redacted] of his rights, which he waived and provided a sworn statement confessing to giving Mr [redacted] a pistol (see sworn statement for details).

b7c-5, b6-5

About 1010, 24 May 03, SA [redacted] interviewed PFC [redacted], HHC, 3/69th Armor, FSGA, who stated he had heard various rumors concerning [redacted]; however, only observed him enter their area to sell jewelry.

TYPE: AGENT'S NAME AND SEQUENCE NUMBER SA [redacted] b7c-1, b6-1, b2		ORGANIZATION 30 th MP Det (DSE) (CID), 3rd MP GRP (CID), Fort Stewart, GA, 31314	
SIGNATURE [redacted]		DATE 29 May 03	EXHIBIT 1

CID FORM 94
1 FEB 77

FOR OFFICIAL USE ONLY

AGENT'S INVESTIGATIVE REPORT CID Regulation 195-1		ROI NUMBER 0055-03-CID349-59657
		PAGE 4 OF 5 PAGES
<p>DETAILS: b7c-4, b6-4 PFC b7c-4, b6-4 further stated b7c-4, b6-4 was never searched prior to entering their platoon area.</p> <p>About 1025, 24 May 03, SA b7c-1, b6-1 advised PFC b7c-5, b6-5 b7c-5, b6-5 HHC, 3/69th Armor, FSGA, of his rights, which he waived and provided a sworn statement confessing to trading weapons with b7c-5, b6-5 and consuming alcoholic beverages (see sworn statement for details).</p> <p>About 1030, 24 May 03, SA b7c-1, b6-1 interviewed PFC b7c-4, b6-4 b7c-4, b6-4 HHC, 3/69th Armor, FSGA, who stated he escorted CPT b7c-4, b6-4 to b7c-4, b6-4 residence on one occasion, around 28 Apr 03, at which time CPT b7c-4, b6-4 took boxes into b7c-4, b6-4 residence which contained various dishes. PFC b7c-4, b6-4 stated he had heard the rumor that the leadership of his platoon was trading weapons for jewelry.</p> <p>About 1100, 24 May 03, SA b7c-1, b6-1 interviewed CPT b7c-4, b6-4 b7c-4, b6-4, A Co, 3/69th Armor, FSGA, who provided a sworn statement detailing his knowledge of the incident (see sworn statement for details).</p> <p>About 1115, 24 May 03, SA b7c-1, b6-1 interviewed CPT b7c-4, b6-4 b7c-4, b6-4, HHC, 3/69th Armor, FSGA, who provided a sworn statement detailing his knowledge of the incident (see sworn statement for details).</p> <p>About 1340, 24 May 03, SA b7c-1, b6-1 interviewed CPL b7c-4, b6-4 b7c-4, b6-4 HHC, 3/69th Armor, FSGA, who stated he once saw (NFI) b7c-4, b6-4 with three pistols (NFI); however, did not know if the pistols had been previously confiscated by U.S. Forces.</p> <p>About 1407, 24 May 03, SA b7c-1, b6-1 interviewed PFC b7c-4, b6-4 b7c-4, b6-4, HHC, 3/69th Armor, FBGA, who provided a sworn statement detailing his knowledge of the incident (see sworn statement for details).</p> <p>About 1500, 24 May 03, SA b7c-1, b6-1 briefed LTC b7c-3, b6-3 b7c-3, b6-3 Battalion Commander, 3/69th Armor, FSGA, concerning this investigation. LTC b7c-3, b6-3 b7c-3, b6-3 stated intended to pursue Courts-Martial proceedings concerning CPT b7c-5, b6-5, SFC b7c-5, b6-5, and SGT b7c-5, b6-5. LTC b7c-3, b6-3 further stated he intended to administer Non-Judicial Punishment (Field Grade Article 15) to PFC b7c-5, b6-5, SGT b7c-5, b6-5 and PFC b7c-5, b6-5.</p>		
SPECIAL AGENT'S NAME AND SEQUENCE NUMBER SA b7c-1, b6-1, b6-2		ORGANIZATION 30 th MP Det (DSE) (CID), 3rd MP GRP (CID), Fort Stewart, GA, 31314
SIGNATURE 		DATE 29 May 03
		EXHIBIT /

CID FORM 94
1 FEB 77

FOR OFFICIAL USE ONLY

AGENT'S INVESTIGATIVE REPORT

CID Regulation 195-1

ROI NUMBER

0055-03-CID349-59657

PAGE 5 OF 5 PAGES

DETAILS

About 1100, 28 May 03, this office received the results of the DCII checks. [REDACTED]

About 1230, 28 May 03, SA [REDACTED] interviewed Mr [REDACTED], Iraqi Citizen, who stated he had no information concerning any weapons being sold or traded.

AGENT'S COMMENT: Mr [REDACTED] was identified by [REDACTED] as having information concerning the selling and trading of weapons.

About 1330, 28 May 03, SA [REDACTED] interviewed Mr [REDACTED], Iraqi Citizen, who stated on 24 May 03, he went to ask SGT [REDACTED] for assistance concerning thieves in his neighborhood. Mr [REDACTED] stated when he asked for SGT [REDACTED] he was arrested by U.S. Forces. Mr [REDACTED] stated he had no information concerning the trading or selling of weapons.

AGENT'S COMMENT: Mr [REDACTED] identified Mr [REDACTED] as knowing possibly SGT [REDACTED]

About 1500, 29 May 03, CPT [REDACTED] opined there was probable cause to believe [REDACTED] committed the offenses of Failure to Obey an Order or Regulation, Misbehavior before the Enemy, Dealing/Selling/Trading Captured Property, Aiding the Enemy, and Conduct Unbecoming an Officer; [REDACTED] committed the offenses of Failure to Obey an Order or Regulation, Misbehavior before the Enemy, Dealing/Selling/Trading Captured Property, Aiding the Enemy, Larceny, and Willful Discharge of a Weapon; [REDACTED] committed the offenses of Failure to Obey an Order or Regulation, Dealing/Selling/Trading Captured Property, Larceny, and Willful Discharge of a Weapon; [REDACTED] committed the offenses of Failure to Obey an Order or Regulation and Dealing/Selling/Trading Captured Property; [REDACTED] committed the offenses of Dealing/Selling/Trading Captured Property and Aiding the Enemy; and [REDACTED] committed the offenses of Dealing/Selling/Trading Captured Property, False Official Statement, and Aiding the Enemy. CPT [REDACTED] further stated he had sufficient evidence to prosecute the subjects and required no further investigative assistance from this office.///LAST ENTRY///

TYPED AGENT'S NAME AND SEQUENCE NUMBER SA [REDACTED] 67C-1,66-1,62		ORGANIZATION 30 th MP Det (DSE) (CID), 3rd MP GRP (CID), Fort Stewart, GA, 31314	
SIGNATURE [REDACTED]		DATE 29 May 03	EXHIBIT 1

Page(s)

11-61

Referred to:

U.S. ARMY OFFICE OF
THE JUDGE ADVOCATE GENERAL
ATTENTION: DAJA-AL, ROOM 1E739
2200 ARMY PENTAGON
WASHINGTON, DC 20310-2200

MAJOR NELSON VAN ECK
Nelson.VanEck@hqda.army.mil
(703) 588-6787

NOTICE WARNING PROCEDURE/WAIVER CERTIFICATE

For use of this form, see AR 190-30; the proponent agency is DDCSOPS

DATA REQUIRED BY THE PRIVACY ACT

AUTHORITY: Title 10, United States Code, Section 3012(g)
PRINCIPAL PURPOSE: To provide commanders and law enforcement officials with means by which information may be accurately identified.
ROUTINE USES: Your Social Security Number is used as an additional/alternate means of identification to facilitate filing and retrieval.
DISCLOSURE: Disclosure of your Social Security Number is voluntary.

1. LOCATION: AO Power, Baghdad, Iraq
2. DATE: 20 May 03
3. TIME: 1500
4. FILE NO.: 0055-03-C27349
5. NAME: [Redacted]
6. [Redacted]
7. GRADE/STATUS: E-5
8. ORGANIZATION OR ADDRESS: HHC, 3169 AR BN, Fort Stewart, GA 31314

PART I - RIGHTS WAIVER/NON-WAIVER CERTIFICATE

Section A. Rights

The investigator whose name appears below told me that he/she is with the United States Army Division Criminal Investigation and wanted to question me about the following offense(s) of which I am suspected: Aiding the Enemy, Dealing/Selling/Trading Captured Property, Endangering Safety of Command. Before he/she asked me any questions about the offense(s), however, he/she made it clear to me that I have the following rights: I do not have to answer any question or say anything. Anything I say or do can be used as evidence against me in a criminal trial. I am now willing to discuss the offense(s) under investigation, with or without a lawyer present, I have a right to stop answering questions at any time, or speak privately with a lawyer before answering further, even if I sign the waiver below.

5. COMMENTS (Continue on reverse side)

Have you been advised of your rights within the past 30 days? YES, I have requested a lawyer.

Section B. Waiver

I understand my rights as stated above. I am now willing to discuss the offense(s) under investigation and make a statement without talking to a lawyer first and without having a lawyer present with me.

WITNESSES (If available)
1a. NAME (Type or Print)
b. ORGANIZATION OR ADDRESS AND PHONE
3. SIGNATURE OF INTERVIEWEE
4. SIGNATURE OF INVESTIGATOR
5. TYPED NAME OF INVESTIGATOR
6. ORGANIZATION OF INVESTIGATOR

Section C. Non-waiver

1. I do not want to give up my rights
I want a lawyer
I do not want to be questioned or say anything
2. SIGNATURE OF INTERVIEWEE

ATTACH THIS WAIVER CERTIFICATE TO ANY SWORN STATEMENT (DA FORM 2923) SUBSEQUENTLY EXECUTED BY THE SUSPECT/ACCUSED

TOWO

100 82

ITS WARNING PROCEDURE/WAIVER CERTIFICATE

For use of this form, see AR 190-30; the proponent agency is ODCSOPS

0055-03-CTD349

DATA REQUIRED BY THE PRIVACY ACT

59657

AUTHORITY: Title 10, United States Code, Section 3012(g)
PRINCIPAL PURPOSE: To provide commanders and law enforcement officials with means by which information may be accurately identified.
ROUTINE USES: Your Social Security Number is used as an additional/alternate means of identification to facilitate filing and retrieval.
DISCLOSURE: Disclosure of your Social Security Number is voluntary.

1. LOCATION: Bn HQ, AO Power, Baghdad, Iraq
2. DATE: 20 May 03
3. TIME: 1703
4. FILE NO.: 0055-03-CTD349
5. NAME (Last, First, MI): [Redacted]
6. SSN: [Redacted]
7. GRADE/STATUS: CPT 103
8. ORGANIZATION OR ADDRESS: HHC, 369 Armor, 1st BCT, 3ID, Ft. Stewart, GA 31314

PART I - RIGHTS WAIVER/NON-WAIVER CERTIFICATE

Section A. Rights

The investigator whose name appears below told me that he/she is with the United States Army Division as a Special Agent and wanted to question me about the following offense(s) of which I am suspected/accused: Aiding the Enemy, Dealing/Selling/Trading Captured Property, Endangering Safety of Command, Violation of General Order #1, Conduct Unbecoming an Officer and Solicitation to Commit an Offense. Before he/she asked me any questions about the offense(s), however, he/she made it clear to me that I have the following rights: I do not have to answer any question or say anything. Anything I say or do can be used as evidence against me in a criminal trial. I am not a personnel subject of the UCMJ. I have the right to talk privately to a lawyer before, during, and after questioning and to have a lawyer present with me during questioning. This lawyer can be a civilian lawyer I arrange for at no expense to the Government or a military lawyer detailed for me at no expense to me, or both. (For civilians not subject to the UCMJ) I have the right to talk privately to a lawyer before, during, and after questioning and to have a lawyer present with me during questioning. I understand that this lawyer can be one that I arrange for at my own expense, or if I cannot afford a lawyer and want one, a lawyer will be appointed for me before any questioning begins. If I am now willing to discuss the offense(s) under investigation, with or without a lawyer present, I have a right to stop answering questions at any time, or speak privately with a lawyer before answering further, even if I sign the waiver below.

5. COMMENTS (Continue on reverse side)
Have you requested a lawyer after being read your rights within the last 30 days? Yes

Section B. Waiver

I understand my rights as stated above. I am now willing to discuss the offense(s) under investigation and make a statement without talking to a lawyer first and without having a lawyer present with me.

WITNESSES (If available)
1a. NAME (Type or Print)
b. ORGANIZATION OR ADDRESS AND PHONE
3. SIGNATURE OF INTERVIEWEE
4. SIGNATURE OF INVESTIGATOR
5. TYPED NAME OF INVESTIGATOR
6. ORGANIZATION OF INVESTIGATOR

Section C. Non-waiver

DODDOACID-005271

1. I do not want to give up my rights
I want a lawyer
I do not want to be questioned or say anything

ATTACH THIS WAIVER CERTIFICATE TO ANY SWORN STATEMENT (DA FORM 2873) SUBSEQUENTLY EXECUTED BY THE SUSPECT/ACCUSED

ITS WARNING PROCEDURE/WAIVER CERTIFICATE

For use of this form, see AR 190-30; the proponent agency is ODCSOPS

0055 03-CID349

DATA REQUIRED BY THE PRIVACY ACT

59657

AUTHORITY: Title 10, United States Code, Section 3012(g)
PRINCIPAL PURPOSE: To provide commanders and law enforcement officials with means by which information may be accurately identified.
ROUTINE USES: Your Social Security Number is used as an additional/alternate means of identification to facilitate filing and retrieval.
DISCLOSURE: Disclosure of your Social Security Number is voluntary.

1. LOCATION <i>AO Power, Baghdad, Iraq</i>	2. DATE <i>20 May 03</i>	3. TIME <i>1600</i>	4. FILE NO. <i>0055-03-CID349</i>
5. NAME (Last, First, MI) [REDACTED] <i>DAFC-5166-5</i>	8. ORGANIZATION OR ADDRESS <i>HHC 316A AR Fort Stewart, GA (deployed)</i>		
6. SSN [REDACTED]	7. GRADE/STATUS <i>E-9</i>		

PART I - RIGHTS WAIVER/NON-WAIVER CERTIFICATE

Section A. Rights

The investigator whose name appears below told me that he/she is with the United States Army

Command

and wanted to question me about the following offense(s) of which I am

Criminal Investigation 64C-5,66-5

suspected/accused: *Escapes/Looting or Tampering of Captured or Abandoned Equipment*

Before he/she asked me any questions about the offense(s), however, he/she made it clear to me that I have the following rights:

- I do not have to answer any question or say anything.
- Anything I say or do can be used as evidence against me in a criminal trial.
- For personnel subject to the UCMJ* I have the right to talk privately to a lawyer before, during, and after questioning and to have a lawyer present with me during questioning. This lawyer can be a civilian lawyer I arrange for at no expense to the Government or a military lawyer detailed for me at no expense to me, or both.

See Comment Block

(For civilians not subject to the UCMJ) I have the right to talk privately to a lawyer before, during, and after questioning and to have a lawyer present with me during questioning. I understand that this lawyer can be one that I arrange for at my own expense, or if I cannot afford a lawyer and want one, a lawyer will be appointed for me before any questioning begins.

If I am now willing to discuss the offense(s) under investigation, with or without a lawyer present, I have a right to stop answering questions at any time, or speak privately with a lawyer before answering further, even if I sign the waiver below.

64C-5,66-5

5. COMMENTS (Continue on reverse side)

I have not requested a attorney on the past 30 days.

Section B. Waiver

I understand my rights as stated above. I am now willing to discuss the offense(s) under investigation and make a statement without talking to a lawyer first and without having a lawyer present with me.

WITNESSES (If available)		3. SIGNATURE OF INTERVIEWEE [REDACTED] <i>64C-5,66-5</i>
1a. NAME (Type or Print)		4. SIGNATURE OF INVESTIGATOR [REDACTED] <i>64C-1,66-1</i>
b. ORGANIZATION OR ADDRESS AND PHONE		5. TYPED NAME OF INTERVIEWEE <i>SA</i> [REDACTED] <i>64C-1,66-1</i>
2a. NAME (Type or Print)		6. ORGANIZATION OF INVESTIGATOR <i>30th MP Det (CID), FS&A</i>
b. ORGANIZATION OR ADDRESS AND PHONE		

Section C. Non-waiver

- I do not want to give up my rights
 I want a lawyer
 I do not want to be questioned or say anything

DODDOACID-005272

SIGNATURE OF INTERVIEWEE

ATTACH THIS WAIVER CERTIFICATE TO ANY SWORN STATEMENT (DA FORM 2823) SUBSEQUENTLY EXECUTED BY THE SUSPECT/ACCUSED

K-2 8/4

SWORN STATEMENT

For use of this form, see AR 190-45; the proponent agency is DDCSOPS

PRIVACY ACT STATEMENT

AUTHORITY: Title 10 USC Section 301; Title 5 USC Section 2951; E.O. 9397 dated November 22, 1943 (SSN).
PRINCIPAL PURPOSE: To provide commanders and law enforcement officials with means by which information may be accurately identified.
ROUTINE USES: Your social security number is used as an additional/alternate means of identification to facilitate filing and retrieval.
DISCLOSURE: Disclosure of your social security number is voluntary.

1. LOCATION AO Power Baghdad	2. DATE (YYYYMMDD) 20030520	3. TIME 1940	4. FILE NUMBER 0055-03-CID349
5. LAST NAME, FIRST NAME, MIDDLE NAME [REDACTED] 67C-5,66-5	6. SSN [REDACTED] 67C-5,66-5	7. GRADE/STATUS E-7	

8. ORGANIZATION OR ADDRESS
HHC 3-69AR, Unit #93109, APO AF 09303-3109

9. [REDACTED] . WANT TO MAKE THE FOLLOWING STATEMENT UNDER OATH: *On or about 3 weeks to a month ago, HHC 3-69AR Mortar Platoon was assigned to a hard site in Baghdad, in the vicinity of the hospital district, our hard site was connected with the Al-Werda/Al-Wesity Othepeidic + Plastic Surgery hospital. We was tasked to patrol section 1 of 14 West, In our time in executing our missions we dealt with security in the neighborhoods, people being looted, houses without power, looters targeting the hospital grounds, informants with possible locations of people on the deck of cards or areas that had Bathe party old operations places and people shot or killed that came to the hospital that was attached to our hard site, a lot of the times we was over whelmed with the problems that we were brought with, in our day to day dealings we had developed a relation with a man called [REDACTED] he was not a immediate friend to me, because he dealt with CPT [REDACTED] my platoon leader, a lot in the beginning, he came to talk to him at night and CPT [REDACTED] had told me that a building behind the Al-Wesity hospital (Maternity + Paternity) the tall building was a former Bathe house operation center of some sort, he was refered to AO Power to talk to the people here that deals with this information, after he talked to them, they told us to check out the building and we did, we found nothing to significant, there was a sign that we found that referenced, "Never trust Americans and hurt them any chance you get." the exact words to this poster like message is not exact, the building was abandoned and the unit prior to us, taking over made references to the building that they also searched it and found nothing. After I came back to the hard site, I told the platoon leader, I don't believe*

10. EXHIBIT 5	11. INITIALS OF PERSON MAKING STATEMENT [REDACTED] 67C-5,66-5	PAGE 1 OF 6 PAGES
-------------------------	---	--------------------------

ADDITIONAL PAGES MUST CONTAIN THE HEADING "STATEMENT OF _____ TAKEN AT _____ DATED _____"
 THE BOTTOM OF EACH ADDITIONAL PAGE MUST BEAR THE INITIALS OF THE PERSON MAKING THE STATEMENT, AND PAGE NUMBER MUST BE INDICATED. **65**

USE THIS PAGE IF NEEDED. IF THIS PAGE IS NOT NEEDED, PLEASE PROCEED TO FINAL PAGE OF THIS FORM.

STATEMENT OF [redacted] TAKEN AT AO Power DATED 20 May 03
b7c-5, b6-5

9. STATEMENT (Continued) [redacted] him and he told was nothing, the following few days Mr. [redacted] came and talked with [redacted] in low tones and and after they were finished and mr. [redacted] left, I inquired with the P.L. about what they talked about and he said nothing significant and that he would bring some jewelry to see if we wanted to buy his stuff. Next day I came back from AO Power and they were talking and he (Mr. [redacted]) showed us some rings and other jewelry, praying beads, and I picked some items and payed him for them, after [redacted] left I asked if PL told me anything about this guy, he told me he was with the Fadaheen, but not no more, during the gulf war he was a sniper of some type and he got kicked out, when I don't know, [redacted] said he didn't want to be with him (Fadaheen Party) [redacted] said he wanted to help us, by pointing out Baath Party people or other dealers against the forces in Baghdad. A few days later Mr. [redacted] came and brought his ware and we sat down and just talked about regular stuff, and he told us he had a girl and a wife and that he was trying to get enough money to get out of Iraq or the US, and he said he needed protection to protect his family from looters and bad guys that came into the neighborhood at night, I had a pistol that he wanted and a few days later I gave him [redacted] a former statement told to Major [redacted] I said I gave Mr. [redacted] AKA-47, I did not give him a AKA-47, I gave him a 9mm Sig Sauer pistol, a few days he came again we did not buy anything, he came to talk about the Hospital directors at Al Wasity and Al weada and told us that they were bad people and were assoisiated with the Baath Party before the war, this was brought on by when he saw a Dr. [redacted] from across the street. [redacted] came and talked with us about the present director, Mr. [redacted] may have over head us say something about the old director, cause he started to curse the old director about taking money for the Baath party and cheating the people and saying he should be removed and he also said the director from the Orthopedics is the same type, I did not pay [redacted] any mind, about the orthopedics Director, until [redacted]

INITIALS OF PERSON MAKING STATEMENT [redacted] b7c-5, b6-5 PAGE 2 OF 6 PAGES 66

FOUO

USE THIS PAGE IF NEEDED. IF THIS PAGE IS NOT NEEDED, PLEASE PROCEED TO FINAL PAGE OF THIS FORM.

b7c-5, b6-5

STATEMENT OF

[Redacted Name]

TAKEN AT

AD Power

DATED

20 May 03

b7c-5, b6-5

9. STATEMENT (Continued)

one day the staff at this hospital was outside protesting that they had not gotten paid, and one of the protesters said they wanted the Orthopedics hospital Director fired, Mr. [Redacted] was there when the protester said that and acted as a interpreter. ~~Some of~~ Some of [Redacted] of the things I did not understand Mr. [Redacted] bad mouthed the director not to his face but said he was former Parthe member and he was bad.

That day someone stole a dive knife and camera from SGT [Redacted], the dive knife was given to SGT [Redacted] by Mr. [Redacted] and [Redacted] not the same day. SGT [Redacted] asked if I could conduct a search of the soldiers property to find this missing equipment, I (SFC [Redacted]) said, yes. he moved all the soldiers into one room and one by one searched their equipment and did not [Redacted] the equipment, while conducting the search SFC [Redacted] PFC [Redacted] came for me and said why is he doing this and I told him why, he seemed stressed and said he wanted to talk to the chaplain, I said okay as soon as we get the opportunity to do so I would get him there. Two days later I asked Mr. [Redacted] if he could get me some Alcohol beverage and he did, I drank some before we were caught with these items, I had in my duffle bag a pistol and 2 bottles of alcohol, In my area were I slept I was given 2 pistols from SGT [Redacted] + CPL [Redacted] that they had confiscated from a Traffic Control point and they were using the only Mission Capable vehicles to take these pistols to [Redacted]. Also I was trying to make home brews of alcohol that did not come about, but were [Redacted] also in the room when caught. I gave to Mr. [Redacted] a bolt action rifle we had taken from the palace Area of operation it was signed by Saddam Hussein and dated the day given on his birth day, I gave this to him as a gift for nothing in return and before

INITIALS OF PERSON MAKING STATEMENT

[Redacted Initials] b7c-5, b6-5

PAGE 3 OF 6 PAGES

USE THIS PAGE IF NEEDED. IF THIS PAGE IS NOT NEEDED, PLEASE PROCEED TO FINAL PAGE OF THIS FORM.

STATEMENT OF [redacted] TAKEN AT AV Power DATED 20 May 03

9. STATEMENT (Continued) [redacted] gave the order to turn in all weapons. I don't know if [redacted] was giving weapons to Mr [redacted] or if Sgt [redacted] had given him any weapons nor did I see these 2 soldiers give him any weapons. Mr. [redacted] did not sit in any operations briefings conducted by my platoon, he was present when some one came and told us 'OP1 needs to be replaced now, he was present on 2 occasions when the Italian officer came to talk to CPT [redacted] about stuff they requested from us, like food (MREs) or Constatmo wine, but on one of these occasions when the Italian officer knew of the Iraqi civilians present (Mr [redacted]) the Italian officer would talk low or pull the PL aside [redacted]

- Q: Were you instructed to turn in all weapons to your battalion?
- A: Instructed to turn in all weapon to our Battalion, yes.
- Q: Did you violate that order?
- A: Yes, I did, by not turning in a 9mm pistol in my duffle bag.
- Q: Did you keep that weapon on purpose?
- A: Yes, until we wer told we are to leave Iraq, I was going to turn it in then.
- Q: Are you aware of General Order # 1?
- A: Yes, no alcohol to soldiers.
- Q: Did you violate that order?
- A: Yes, by receiving it from a local, and consumed it, and attempting to make my own.
- Q: Did you give a pistol and rifle to an Iraqi national that you knew to be formerly involved in the Iraqi Army and Terrorist organizations?
- A: Yes.

Q Why did you do that?

INITIALS OF PERSON MAKING STATEMENT [redacted] PAGE 4 OF 6 PAGES

FOUO

b7c-5, b6-5
[Redacted]

STATEMENT OF

TAKEN AT

AO Power

DATED

20 May 03

9. STATEMENT (Continued)

A: As a gift and for protection [Redacted] b7c-5, b6-5

Q: What was his name and what terrorist organization did he belong to?

A: [Redacted] and he told us he was former Fedahcen and he wanted to help US forces and I believed him. b7c-5, b6-5

Q: Do you think it was wrong to give a "former" Anti-American terrorist weapons? b7c-5, b6-5

A: Yes it was wrong. If I thought he was still active, I felt he is not associated with them and is thier for the greater good of Iraq. b7c-5, b6-5

Q: Did you allow soldiers in your platoon to carry confiscated weapons that should have been turned into the unit?

A: Yes, I did, but not after the Battalion commander said to turn in all weapons confiscated. b7c-5, b6-5

Q: Who were those soldiers?

A: A majority of the platoon, the exact names I wish not to include. b7c-5, b6-5

Q: Were you derelict in your duties for allowing this to happen?

A: Yes I am derelict in this duty. b7c-5, b6-5

Q: Do you have anything else to add to this statement?

A: Yes, the soldier would have and did turn in the weapons when told.

AFFIDAVIT

I, _____, HAVE READ OR HAVE HAD READ TO ME THIS STATEMENT WHICH BEGINS ON PAGE 1, AND ENDS ON PAGE _____. I FULLY UNDERSTAND THE CONTENTS OF THE ENTIRE STATEMENT MADE BY ME. THE STATEMENT IS TRUE. I HAVE INITIALED ALL CORRECTIONS AND HAVE INITIALED THE BOTTOM OF EACH PAGE CONTAINING THE STATEMENT. I HAVE MADE THIS STATEMENT FREELY WITHOUT HOPE OF BENEFIT OR REWARD, WITHOUT THREAT OF PUNISHMENT, AND WITHOUT COERCION, UNLAWFUL INFLUENCE, OR UNLAWFUL INDUCEMENT.

(Signature of Person Making Statement)

WITNESSES:

Subscribed and sworn to before me, a person authorized by law to administer oaths, this _____ day of _____ at _____

(Signature of Person Administering Oath)

(Typed Name of Person Administering Oath)

(Authority To Administer Oaths)

ORGANIZATION OR ADDRESS

ORGANIZATION OR ADDRESS

INITIALS OF PERSON MAKING STATEMENT
[Redacted] b7c-5, b6-5

PAGE 5 OF 6 PAGES

STATEMENT OF

TAKEN AT

AU Tower

DATED

20 May 03

9. STATEMENT (Continued)

to do so, I was not told to do so before this, so I did not know it was forbidden, to not hold as backup weapons, after Confiscated. b7c-5, b6-5

Q: You didn't know soldiers are only authorized to use U.S. Weapons/assigned weapons?

A: Yes, I know only use authorized weapons, but if we got in to a situation where we got disarmed, make every attempt to evade capture and get to the other side. b7c-5, b6-5

Q: What kind of Alcohol did you drink?

A: I drank gin, called Bridge gin. b7c-5, b6-5

Q: Did you write this statement freely of your own will?

A: Yes under nervous ncss, but I want to get it over and I know what I did was wrong. b7c-5, b6-5

Q: Do you have anything else to add to this statement?

A: I apologize for my actions, I apologize to my platoon the unit and the US Army. b7c-5, b6-5

Q: Would you like to add anything else to this statement?

A: NO. // End of Statement // b7c-5, b6-5

AFFIDAVIT

I, [redacted] HAVE READ OR HAVE HAD READ TO ME THIS STATEMENT WHICH BEGINS ON PAGE 1, AND ENDS ON PAGE 6. I FULLY UNDERSTAND THE CONTENTS OF THE ENTIRE STATEMENT MADE BY ME. THE STATEMENT IS TRUE. I HAVE INITIALED ALL CORRECTIONS AND HAVE INITIALED THE BOTTOM OF EACH PAGE CONTAINING THE STATEMENT. I HAVE MADE THIS STATEMENT FREELY WITHOUT HOPE OF BENEFIT OR REWARD, WITHOUT THREAT OF PUNISHMENT, AND WITHOUT COERCION, UNLAWFUL INFLUENCE, OR UNLAWFUL INDUCEMENT.

[redacted signature] b7c-5, b6-5
(Signature of Person Making Statement)

WITNESSES:

SA [redacted] b7c-1, b6-1

ORGANIZATION OR ADDRESS

ORGANIZATION OR ADDRESS

Subscribed and sworn to before me, a person authorized by law to administer oaths, this 20th day of May, 2003 at Baghdad, Iraq

[redacted signature] b7c-1, b6-1
(Signature of Person Administering Oath)

SA [redacted] b7c-1, b6-1
(Typed Name of Person Administering Oath)

Art 131(b)4 UCMJ
(Authority To Administer Oaths)

INITIALS OF PERSON MAKING STATEMENT

PAGE 6 OF 6 PAGES

RIGHT - WARNING PROCEDURE/WAIVER CERTIFICATE
 For use of this form, see AR 190-30; the proponent agency is ODCSOPS

DATA REQUIRED BY THE PRIVACY ACT

AUTHORITY: Title 10, United States Code, Section 3012(g)
PRINCIPAL PURPOSE: To provide commanders and law enforcement officials with means by which information may be accurately identified.
ROUTINE USES: Your Social Security Number is used as an additional/alternate means of identification to facilitate filing and retrieval.
DISCLOSURE: Disclosure of your Social Security Number is voluntary.

1. LOCATION <u>Baghdad, Iraq</u>	2. DATE <u>20 May 03</u>	3. TIME <u>1600</u>	4. FILE NO <u>0055 03-CZD25</u>
5. NAME (Last, First, MI) <u>[REDACTED] b7c-5, b6-5</u>	8. ORGANIZATION OR ADDRESS <u>HHC, 3169 AR BN</u>		
6. SSN <u>[REDACTED] b7c-5, b6-5</u>	7. GRADE/STATUS <u>E-5</u>	Ft. Stewart, GA 31314	

PART I - RIGHTS WAIVER/NON-WAIVER CERTIFICATE

Section A. Rights

The investigator whose name appears below told me that he/she is with the United States Army Criminal Investigation and wanted to question me about the following offense(s) of which I am suspected/accused: Dealing/Selling/Trading Captured Property // [REDACTED] b7c-5, b6-5

Before he/she asked me any questions about the offense(s), however, he/she made it clear to me that I have the following rights:

- I do not have to answer any question or say anything.
- Anything I say or do can be used as evidence against me in a criminal trial.
- (For personnel subject to the UCMJ) I have the right to talk privately to a lawyer before, during, and after questioning and to have a lawyer present with me during questioning. This lawyer can be a civilian lawyer I arrange for at no expense to the Government or a military lawyer detailed for me at no expense to me, or both.
- (For civilians not subject to the UCMJ) I have the right to talk privately to a lawyer before, during, and after questioning and to have a lawyer present with me during questioning. I understand that this lawyer can be one that I arrange for at my own expense, or if I cannot afford a lawyer and want one, a lawyer will be appointed for me before any questioning begins.
- If I am now willing to discuss the offense(s) under investigation, with or without a lawyer present, I have a right to stop answering questions at any time, or speak privately with a lawyer before answering further, even if I sign the waiver below.

5. COMMENTS (Continue on reverse side)

Section B. Waiver

I understand my rights as stated above. I am now willing to discuss the offense(s) under investigation and make a statement without talking to a lawyer first and without having a lawyer present with me.

WITNESSES (If available)		3. SIGNATURE OF INTERVIEWEE <u>[REDACTED] b7c-5, b6-5</u>
1a. NAME (Type or Print)		4. SIGNATURE OF INVESTIGATOR <u>[REDACTED] b7c-1, b6-1</u>
b. ORGANIZATION OR ADDRESS AND PHONE		5. TYPED NAME OF INVESTIGATOR <u>SA [REDACTED] b7c-1, b6-1</u>
2a. NAME (Type or Print)		6. ORGANIZATION OF INVESTIGATOR <u>301st MP Det (CID)</u>
b. ORGANIZATION OR ADDRESS AND PHONE		<u>Ft Stewart, GA 31314</u>

Section C. Non-waiver

1. I do not want to give up my rights
 I want a lawyer I do not want to be questioned or say anything

2. SIGNATURE OF INTERVIEWEE

ATTACH THIS WAIVER CERTIFICATE TO ANY SWORN STATEMENT (DA FORM 2823) SUBSEQUENTLY EXECUTED BY THE SUSPECT/ACCUSED

FOUO

0571
E-1111

SWORN STATEMENT

For use of this form, see AR 190-45; the proponent agency is ODCSOPS

PRIVACY ACT STATEMENT

AUTHORITY: Title 10 USC Section 301; Title 5 USC Section 2951; E.O. 9397 dated November 22, 1943 (SSA).
PRINCIPAL PURPOSE: To provide commanders and law enforcement officials with means by which information may be accurately identified.
ROUTINE USES: Your social security number is used as an additional alternate means of identification to facilitate filing and retrieval.
DISCLOSURE: Disclosure of your social security number is voluntary.

1. LOCATION: Baghdad, Iraq
2. DATE (YYYYMMDD): 2003 05 20
3. TIME: 1700
4. FILE NUMBER: 0055-03-CID349
5. LAST NAME, FIRST NAME, MIDDLE NAME: [redacted]
6. SSN: [redacted]
7. GRADE/STATUS: E-5
8. ORGANIZATION OR ADDRESS: HHC 3-69 AR Ft. Stewart, GA 31314

WANT TO MAKE THE FOLLOWING STATEMENT UNDER OATH:

How It all began was [redacted] showed up with information. Him and CPT [redacted] would spend hours together talking. CPT [redacted] would have tea at his house. Then [redacted] would come by the alwasity hospital (hard site) more and more often. I thought that he just sold jewelry and trinkets. Most of the platoon bought some including me. He would come with bags and leave with none. Sometimes he would come with none and then leave with bags. He was pretty much allowed to come and go as he pleased. To my knowledge he was never searched [redacted] when entering or leaving. Sometimes he would come and leave multiple times in a day, but he came at least once everyday. I saw him give gifts to CPT [redacted] but I assumed he was buying them. But looking back I never saw CPT [redacted] give [redacted] any money for anything he received. I have seen [redacted] with a pistol, but it was in front of CPT [redacted] and I assumed it was his. I have not witnessed that I am aware of any exchange of weapons for money or goods in my [redacted]

10. EXHIBIT:
11. INITIALS OF PERSON MAKING STATEMENT: [redacted]
PAGE 1 OF 2 PAGES

ADDITIONAL PAGES MUST CONTAIN THE HEADING "STATEMENT OF" TAKEN AT DATED
THE BOTTOM OF EACH ADDITIONAL PAGE MUST BEAR THE INITIALS OF THE PERSON MAKING THE STATEMENT, AND PAGE NUMBER MUST BE INDICATED.

STATEMENT OF [REDACTED] TAKEN AT Baghdad, Iraq DATED 20 May 03

9. STATEMENT (Continued)

[REDACTED] PRESENCE.

Q. SA [REDACTED] b7c-1, b6-1

A. SGT [REDACTED] b7c-5, b6-5

Q. Have you ever seen anyone trade any weapons or captured property with [REDACTED] b7c-4, b6-4

A. Not to my knowledge.

Q. When [REDACTED] would leave your compound with these bags, would they seem larger than they did when he brought them in?

A. Sometimes, other times the bags were smaller.

Q. Is there anything else you would like to add to this statement?

A. NO. /// END OF STATEMENT /// [REDACTED] b7c-5, b6-5

NOT USED

DODDOACID-005281

b7c-5, b6-5

AFFIDAVIT

[REDACTED] HAVE READ OR HAVE HAD READ TO ME THIS STATEMENT WHICH BEGINS ON PAGE 1, AND ENDS ON PAGE 2. I FULLY UNDERSTAND THE CONTENTS OF THE ENTIRE STATEMENT MADE BY ME. THE STATEMENT IS TRUE. I HAVE INITIALED ALL CORRECTIONS AND HAVE INITIALED THE BOTTOM OF EACH PAGE CONTAINING THE STATEMENT. I HAVE MADE THIS STATEMENT FREELY WITHOUT HOPE OF BENEFIT OR REWARD, WITHOUT THREAT OF PUNISHMENT, AND WITHOUT COERCION, UNLAWFUL INFLUENCE, OR UNLAWFUL INDUCEMENT.

[REDACTED] b7c-5, b6-5
(Signature of Person Making Statement)

WITNESSES:

Subscribed and sworn to before me, a person authorized by law to administer oaths, this 20th day of May, 2003 at Baghdad, Iraq b7c-1, b6-1

[REDACTED]
(Signature of Person Administering Oath)
b7c-1, b6-1

SA [REDACTED]
(Typed Name of Person Administering Oath)

Article 136
(Authority To Administer Oaths)

ORGANIZATION OR ADDRESS

ORGANIZATION OR ADDRESS

INITIALS OF PERSON MAKING STATEMENT

[REDACTED] b7c-5, b6-5

PAGE 3 OF 3 PAGES

SWORN STATEMENT

For use of this form, see AR 190.45; the proponent agency is ODCSOPS

PRIVACY ACT STATEMENT

DODDOACID-005282

AUTHORITY: Title 10 USC Section 301; Title 5 USC Section 2951; E.O. 9397 dated November 22, 1943 (SSN).
PRINCIPAL PURPOSE: To provide commanders and law enforcement officials with means by which information may be accurately identified.
ROUTINE USES: Your social security number is used as an additional/alternate means of identification to facilitate filing and retrieval.
DISCLOSURE: Disclosure of your social security number is voluntary.

1. LOCATION Baghdad, Iraq	2. DATE (YYYYMMDD) 20030520	3. TIME 18:10	4. FILE NUMBER 0055-03-CID349
5. LAST NAME, FIRST NAME, MIDDLE NAME [REDACTED]	6. SSN [REDACTED]	7. GRADE/STATUS E-2	
8. ORGANIZATION OR ADDRESS HHC, 3169 ARBN, Fort Stewart, GA 31313			

_____ WANT TO MAKE THE FOLLOWING STATEMENT UNDER OATH: ABOUT 1 month ago we arrived at our hard site. I was living with Sgt. _____, and captain _____ up until the day before they were taken away. The first couple of days this guy _____ was coming over everyday & he would bring Jewwelry Jewellery & a lot of people would purchase it. I Bought 2 rings for 15\$. Then I started noticing captain _____, Sgt. _____, SFC _____ all had hand guns. This was around 2 weeks ago. I've seen the _____ walk in the room & he was never searched for weapons or anything. Numerous times I saw he brought food for them & the guns cpt. _____, sgt. _____, sfc _____ had that day were in the bag of the _____ before he left at night. Everyday for those 2 weeks he would always leave with at least 1 hand gun. He gave Cpt. _____ a Diamond watch for a woman's watch. Most of the guns he got were 9MM's & AK 47's. One day I woke up, about a week & half ago & there was a big single shot rifle with saddams picture on it & his signature. The _____ was looking at it & then 2 days later he came over & I left the room & then I had guard & came back off of guard at 2200 hrs and the rifle was gone & so was the _____. The next day sgt. _____ was playing with a "22" handgun it was missing a piece to the handgrip so you could see the ammo clips. hr later at 1600hrs the _____ came over. He had a Bag of Rings & Necklesses as usual to sell or trade. Sgt. _____

10. EXHIBIT 7	11. INITIALS OF PERSON MAKING STATEMENT [REDACTED]	PAGE 1 OF 3 PAGES
------------------	---	-------------------

ADDITIONAL PAGES MUST CONTAIN THE HEADING "STATEMENT OF _____ TAKEN AT _____ DATED _____
 THE BOTTOM OF EACH ADDITIONAL PAGE MUST BEAR THE INITIALS OF THE PERSON MAKING THE STATEMENT, AND PAGE NUMBER MUST BE INDICATED. 100.74

SWORN STATEMENT

For use of this form, see AR 190-45; the proponent agency is ODCSOPS

PRIVACY ACT STATEMENT

AUTHORITY: Title 10 USC Section 301; Title 5 USC Section 2951; E.O. 9397 dated November 22, 1943 (SSN).
PRINCIPAL PURPOSE: To provide commanders and law enforcement officials with means by which information may be accurately identified.
ROUTINE USES: Your social security number is used as an additional/alternate means of identification to facilitate filing and retrieval.
DISCLOSURE: Disclosure of your social security number is voluntary.

DODDOACID-005283

1. LOCATION: Baghdad, Iraq
2. DATE (YYYYMMDD): 20030520
3. TIME: 18:10
4. FILE NUMBER: 0055-03-CID347
5. LAST NAME, FIRST NAME, MIDDLE NAME: [REDACTED]
6. SSN: [REDACTED]
7. GRADE/STATUS: E-2

8. ORGANIZATION OR ADDRESS: HHC, 3/69 AR BN, Fort Stewart, GA 31313

I WANT TO MAKE THE FOLLOWING STATEMENT UNDER OATH: About 1 month ago we arrived at our hard site. I was living with Sgt. [REDACTED] and captain [REDACTED] up until the day before they were taken away. The first couple of days this guy [REDACTED] was coming over everyday & he would bring Jewelery & a lot of people would purchase it. I bought 2 ring for 15\$. Then I started noticing captain [REDACTED], Sgt. [REDACTED], SFC [REDACTED] all had hand guns. This was around 2 weeks ago. I've seen the [REDACTED] walk in the room & he was never searched for weapons or anything. Numerous times I saw he brought food for them & the guns cpt. [REDACTED], Sgt. [REDACTED] SFC [REDACTED] had that day were in the bag of the [REDACTED] before he left at night. Everyday for those 2 weeks he would always leave with at least 1 hand gun. He gave Cpt. [REDACTED] a Diamond watch for a woman's watch. Most of the guns he got were 9MM's & AK 47's. One day I woke up, about a week & half ago & there was a big single shot rifle with saddams picture on it & his signature. The [REDACTED] was looking at it & then 2 days later he came over & I left the room & then I had guard & came back off of guard at 2200 hrs and the rifle was gone & so was the [REDACTED]. The next day Sgt. [REDACTED] was playing with a "22" handgun it was missing a piece to the handgrip so you could see the ammo clips. 1hr later at 1600hrs the [REDACTED] came over. We had a bag of rings & necklesses as usual to sell or trade. Sgt. [REDACTED]

10. EXHIBIT: 7
11. INITIALS OF PERSON MAKING STATEMENT: [REDACTED]
PAGE 1 OF 3 PAGES

ADDITIONAL PAGES MUST CONTAIN THE HEADING "STATEMENT OF" TAKEN AT _____ DATED _____
THE BOTTOM OF EACH ADDITIONAL PAGE MUST BEAR THE INITIALS OF THE PERSON MAKING THE STATEMENT, AND PAGE NUMBER MUST BE INDICATED.

USE THIS PAGE IF NEEDED. IF THIS PAGE IS NOT NEEDED, PLEASE PROCEED TO FINAL PAGE OF THIS FORM.

STATEMENT OF [redacted] TAKEN AT Baghdad, Iraq DATED 20 May 83

9. STATEMENT (Continued)

Took out the "22" handgun and handed it to the [redacted] 67C-4, 66-4
 I had guard from [redacted] 2AM-6AM so I was sleeping after
 that until 1600. But I was awake a little before 1600 & he might
 have been over before that. But after he took the "22" the
 [redacted] 67C-4, 66-4 He then pulled out a 9MM that I saw Sgt. [redacted] 67C-5, 66-5 with the
 day before & he left later on that night with those 2
 guns. About 3 days later, ME [redacted] 67C-5, 66-5, Sgt. [redacted] 67C-5, 66-5, PFC [redacted] 67C-4, 66-4
 PFC [redacted] 67C-4, 66-4 went out on a patrol in the humvee's. The patrol was
 not a normal patrol it's the gun squad that go out on patrol.
 Me, PFC [redacted] 67C-4, 66-4 were driving the HQ 57 & Sgt. [redacted] 67C-5, 66-5, Cpt. [redacted] 67C-5, 66-5
 PFC [redacted] 67C-5, 66-5 were in HQ 56. We pulled over 3 cars past
 curfew two of them had AK 47's so we took them
 in back of HQ 57 & at like 0100 hrs we dropped off the
 [redacted] 67C-4, 66-4 and he came to the back of our Humvee & grabbed
 1 AK47 & we said hold on. We looked at Cpt. [redacted] 67C-5, 66-5 and
 said it's OK that he takes it he said yes he could have
 it. So he then walked up to the door of this garage type house
 knocked & put the AK47 down & a guy came to the door &
 picked it up. He then came out & said thank you to us
 & Cpt. [redacted] 67C-5, 66-5 mainly for giving it to him. So we then drove
 away & went back to our hardsite. That house was only
 about 2-3 blocks away from our hardsite. After that he
 would still come over everyday & leave with 9MM's &
 AK47 clips of ammo. Up until the day I was put out
 of the room & then the day they raided the room, before
 during the day the guys in our platoon all turned in the handguns
 they got on their patrols. And the [redacted] 67C-4, 66-4 came in my new room &
 pulled out a 9MM. The guy I sleep next to PFC [redacted] 67C-4, 66-4 said
 we turned that gun into captain [redacted] 67C-5, 66-5 today. That is as much
 information I can recall to this day. [redacted] 67C-4, 66-4

INITIALS OF PERSON MAKING STATEMENT

[redacted] 67C-4, 66-4

DODDOACID-005284

PAGE 2 OF 3 PAGES

FOUO

USA 6 V 100 6
Exhibit 7

STATEMENT OF

TAKEN AT Baghdad, Iraq DATED 20 May 03

9. STATEMENT (Continued)

- Q. SA [redacted] b7c-1, b6-1
- A. PVT [redacted] b7c-4, b6-4
- Q. Did you physically see the [redacted] b7c-4, b6-4 take any weapons out of your compound?
- A. Yes, about 50 handguns at different times and days. He also took 2 AK-47s with loaded magazines out of the compound.
- Q. Do you know who gave the [redacted] b7c-4, b6-4 the weapons or how he got them?
- A. I saw SGT [redacted] b7c-4, b6-4 give the [redacted] b7c-4, b6-4 a handgun on one occasion. I also saw CPT [redacted] b7c-4, b6-4 give the [redacted] b7c-4, b6-4 an AK-47 with a loaded clip. That's what I personally witnessed.
- Q. Did either SGT [redacted] b7c-4, b6-4 or CPT [redacted] b7c-4, b6-4 receive anything in return for the weapons?
- A. I know CPT [redacted] b7c-4, b6-4 got a diamond watch from the [redacted] b7c-4, b6-4 for the AK-47 and other handguns, but I never had "eyes on" the exchange. I know SGT [redacted] b7c-4, b6-4 got a gold lighter a nice divers knife for his exchanges. I never saw either of them pay the [redacted] b7c-4, b6-4 for any of that stuff.
- Q. Did you ever see SFC [redacted] b7c-4, b6-4 give, trade, or sell any weapons to anyone to include the [redacted] b7c-4, b6-4?
- A. NO.
- Q. Is there anything else you would like to add to this statement?
- A. NO. // END OF STATEMENT // [redacted] b7c-4, b6-4

DODDOACID-005285

AFFIDAVIT

I, [redacted] b7c-4, b6-4, HAVE READ OR HAVE HAD READ TO ME THIS STATEMENT WHICH BEGINS ON PAGE 1, AND ENDS ON PAGE 3. I FULLY UNDERSTAND THE CONTENTS OF THE ENTIRE STATEMENT MADE BY ME. THE STATEMENT IS TRUE. I HAVE INITIALED ALL CORRECTIONS AND HAVE INITIALED THE BOTTOM OF EACH PAGE CONTAINING THE STATEMENT. I HAVE MADE THIS STATEMENT FREELY WITHOUT HOPE OF BENEFIT OR REWARD, WITHOUT THREAT OF PUNISHMENT, AND WITHOUT COERCION, UNLAWFUL INFLUENCE, OR UNLAWFUL INDUCEMENT.

[redacted] b7c-4, b6-4
(Signature of Person Making Statement)

WITNESSES:

SA [redacted] b7c-4, b6-1

ORGANIZATION OR ADDRESS

ORGANIZATION OR ADDRESS

Subscribed and sworn to before me, a person authorized by law to administer oaths, this 20th day of May, 2003 at Baghdad, Iraq

[redacted] b7c-1, b6-1
(Signature of Person Administering Oath)

SA [redacted] b7c-1, b6-1
(Typed Name of Person Administering Oath)

Article 136
(Authority To Administer Oaths)

INITIALS OF PERSON MAKING STATEMENT

PAGE 3 OF 3 PAGES

USE THIS PAGE IF NEEDED. IF THIS PAGE IS NOT NEEDED, PLEASE PROCEED TO FINAL PAGE OF THIS FORM.

STATEMENT OF [redacted] ^{b7c-4, b6-4} TAKEN AT AV Power DATED 21 May 03
[redacted] ^{b7c-4, b6-4} [redacted] ^{b7c-4, b6-4}

9. STATEMENT (Continued)

Although I never saw a transaction ~~for~~ for weapons, I did see several with things like Cuban Cigars, Expensive lighters, alcohol, and jewelry. I also know that on the day before CPT [redacted] ^{b7c-5, b6-5} arrest, Major [redacted] ^{b7c-5, b6-3} and another higher ranking officer (I don't remember who) came by. The [redacted] ^{b7c-4, b6-4} guy was ushered out into one of our sleeping rooms. While Major [redacted] ^{b7c-5, b6-3} was in our building, they kept the [redacted] ^{b7c-4, b6-4} guy in there. The [redacted] ^{b7c-4, b6-4} guy pulled out a handgun and began showing it off (he had 3). One of the privates (PFC [redacted] ^{b7c-4, b6-4}) recognized it as one of the guns he had confiscated the night before.

On several occasions SFC [redacted] ^{b7c-5, b6-5} and Sgt [redacted] ^{b7c-5, b6-5} took the guns ~~off~~ onto the roof and find them. I do not remember with ones except the Mouser and several handguns.

DODDOACID-005287

A couple of days before they got arrested, I know that there were many weapons that got transported in HQ 57 SFC [redacted] ^{b7c-5, b6-5} hummer, to an unknown location. I do not know how many there were, but I know there were several (more than 6) AK 47s, and some handguns.

Q: [redacted] ^{b7c-1, b6-1}

A: [redacted] ^{b7c-4, b6-4}

Q: Did you actually see weapons in [redacted] ^{b7c-5, b6-5} + [redacted] ^{b7c-5, b6-5} room?

INITIALS OF PERSON MAKING STATEMENT [redacted] ^{b7c-4, b6-4}

PAGE 2 OF 3 PAGES [redacted] ^{b7c-4, b6-4}

STATEMENT OF [redacted] TAKEN AT AD Power DATED 21 May 03

9. STATEMENT (Continued)

A: I physically saw them.

Q: What were the procedures for confiscated ~~pl~~ weapons?

A: We just turn them in to our chain of command. There was no specific arms room.

Q: Did you ever witness [redacted] or [redacted] make any type of transaction with the [redacted] using confiscated weapons?

A: No, I never did. I did see the [redacted] with weapons on his person that we had confiscated the night before from someone else.

Q: How do you know it was the same weapon?

A: A friend told me he recognized it from the night before.

Q: Did you ever witness [redacted] or [redacted] consume alcohol?

A: No, I never witnessed it. It was no secret. They wouldn't outright say they were drinking but platoon members have seen them drunk.

Q: Do you have anything else you wish to add to your statement?

A: No // End of Statement!!!

DODDOACID-005288

AFFIDAVIT

I, [redacted], HAVE READ OR HAVE HAD READ TO ME THIS STATEMENT WHICH BEGINS ON PAGE 1, AND ENDS ON PAGE 3. I FULLY UNDERSTAND THE CONTENTS OF THE ENTIRE STATEMENT MADE BY ME. THE STATEMENT IS TRUE. I HAVE INITIALED ALL CORRECTIONS AND HAVE INITIALED THE BOTTOM OF EACH PAGE CONTAINING THE STATEMENT. I HAVE MADE THIS STATEMENT FREELY WITHOUT HOPE OF BENEFIT OR REWARD, WITHOUT THREAT OF PUNISHMENT, AND WITHOUT COERCION, UNLAWFUL INFLUENCE, OR UNLAWFUL INDUCEMENT.

[redacted] (Signature of Person Making Statement)

WITNESSES:

Subscribed and sworn to before me, a person authorized by law to administer oaths, this 21st day of May, 2003

at AD Power, Baghdad, Iraq

[redacted] (Signature of Person Administering Oath)

[redacted] (Typed Name of Person Administering Oath)

30th MP Det (CID) Ft. Stewart, GA

(Authority To Administer Oaths)

PAGE 3 OF 3 PAGES

Fouo

Exhibit C

ITS WARNING PROCEDURE/WAIVER CERTIFICATE

For use of this form, see AR 190-30; the proponent agency is ODCSOPS

DATA REQUIRED BY THE PRIVACY ACT

AUTHORITY: Title 10, United States Code, Section 3012(g)
PRINCIPAL PURPOSE: To provide commanders and law enforcement officials with means by which information may be accurately identified.
ROUTINE USES: Your Social Security Number is used as an additional/alternate means of identification to facilitate filing and retrieval.
DISCLOSURE: Disclosure of your Social Security Number is voluntary.

1. LOCATION Baghdad, Iraq	2. DATE 21 May 03	3. TIME 12.45	4. FILE NO. 0055-03-CZD349
5. NAME (Last, First, MI) [REDACTED] b7c-4, b6-4	8. ORGANIZATION OR ADDRESS N/A		
6. SSN [REDACTED]	7. GRADE/STATUS CSW		

PART I - RIGHTS WAIVER/NON-WAIVER CERTIFICATE

Section A. Rights

The investigator whose name appears below told me that he/she is with the United States Army **CID** and wanted to question me about the following offense(s) of which I am suspected/accused: **Criminal/Terroristic Activities III**

Before he/she asked me any questions about the offense(s), however, he/she made it clear to me that I have the following rights:

- I do not have to answer any question or say anything.
 - Anything I say or do can be used as evidence against me in a criminal trial.
 - (For personnel subject to the UCMJ) I have the right to talk privately to a lawyer before, during, and after questioning and to have a lawyer present with me during questioning. This lawyer can be a civilian lawyer I arrange for at no expense to the Government or a military lawyer detailed for me at no expense to me, or both.
- or -
- (For civilians not subject to the UCMJ) I have the right to talk privately to a lawyer before, during, and after questioning and to have a lawyer present with me during questioning. I understand that this lawyer can be one that I arrange for at my own expense, or if I cannot afford a lawyer and want one, a lawyer will be appointed for me before any questioning begins.
- If I am now willing to discuss the offense(s) under investigation, with or without a lawyer present, I have a right to stop answering questions at any time, or speak privately with a lawyer before answering further, even if I sign the waiver below.

5. COMMENTS (Continue on reverse side)

Section B. Waiver

I understand my rights as stated above. I am now willing to discuss the offense(s) under investigation and make a statement without talking to a lawyer first and without having a lawyer present with me.

WITNESSES (If available)		3. SIGNATURE OF INTERVIEWEE [REDACTED] b7c-4, b6-4
1a. NAME (Type or Print)		4. SIGNATURE OF INVESTIGATOR [REDACTED] b7c-1, b6-1
b. ORGANIZATION OR ADDRESS AND PHONE		5. TYPED NAME OF INVESTIGATOR [REDACTED] b7c-1, b6-1
2a. NAME (Type or Print)		6. ORGANIZATION OF INVESTIGATOR SA [REDACTED] 50th MP Det Fort Stewart, GA 31314.
b. ORGANIZATION OR ADDRESS AND PHONE		

Section C. Non-waiver

- 1 I do not want to give up my rights
 I want a lawyer I do not want to be questioned or say anything

DODDOACID-005289

2 SIGNATURE OF INTERVIEWEE

ATTACH THIS WAIVER CERTIFICATE TO ANY SWORN STATEMENT (DA FORM 2823) SUBSEQUENTLY EXECUTED BY THE SUSPECT/ACCUSED

SWORN STATEMENT

For use of this form, see AR 190-45; the proponent agency is ODCSOPS

PRIVACY ACT STATEMENT

AUTHORITY: Title 10 USC Section 301; Title 5 USC Section 2951; E.O. 9397 dated November 22, 1943 /SSA/
PRINCIPAL PURPOSE: To provide commanders and law enforcement officials with means by which information may be accurately identified.
ROUTINE USES: Your social security number is used as an additional/alternate means of identification to facilitate filing and retrieval.
DISCLOSURE: Disclosure of your social security number is voluntary.

1. LOCATION Baghdad, Iraq
2. DATE (YYYYMMDD) 21 May 03
3. TIME
4. FILE NUMBER 0055-03-CID349
5. LAST NAME, FIRST NAME, MIDDLE NAME [REDACTED] 67C-4,66-4
6. SSN N/A
7. GRADE/STATUS CIV
8. ORGANIZATION OR ADDRESS N/A

9. [REDACTED] 67C-4,66-4
I, [REDACTED] 67C-4,66-4, WANT TO MAKE THE FOLLOWING STATEMENT UNDER OATH:
Q: How many weapons did CPT [REDACTED] 67C-5,66-5 give you?
A: One AK-47. He authorized me to take one.
Q: Where did this happen?
A: Near my house. I took one out of the Humvee. The CPT only authorized one.
Q: How many weapons did SFC [REDACTED] 67C-5,66-5 give you?
A: One rifle and one sig sawer.
Q: Where did this occur.
A: The rifle to near my house along with the china and he gave me the sig at their building.
Q: How many weapons did SGT [REDACTED] 67C-5,66-5 give you?
A: One broken Russian pistol.
Q: Where did he give you this?
A: At their building
Q: How many weapons did SGT [REDACTED] 67C-5,66-5 give you?
A: One beretta.
Q: At their building
Q: When did this occur?
A: 18th May 03. Nobody else was present.
Q: Did you pay for these weapons?
A: I did give them gifts prior to them giving me weapons. Things such as silvers which they paid me for in dollars. [REDACTED] 67C-4,66-4 [REDACTED] 67C-4,66-4

DODDOACID-005290

10 EXHIBIT 9 11 INITIALS OF PERSON MAKING STATEMENT [REDACTED] PAGE 1 OF 3 PAGES

ADDITIONAL PAGES MUST CONTAIN THE HEADING "STATEMENT OF [REDACTED] TAKEN AT [REDACTED] DATED [REDACTED]
THE BOTTOM OF EACH ADDITIONAL PAGE MUST BEAR THE INITIALS OF THE PERSON MAKING THE STATEMENT, AND PAGE NUMBER MUST BE INDICATED.

USE THIS PAGE IF NEEDED. IF THIS PAGE IS NOT NEEDED, PLEASE PROCEED TO FINAL PAGE OF THIS FORM.

STATEMENT OF Mr [redacted] b7c-4, b6-4 TAKEN AT Baghdad, Iraq DATED 21 May 03

9. STATEMENT (Continued)

Q: How many times did you provide alcoholic beverages to them?

A: Once 18 May 03, [redacted] b7c-5, b6-5 an [redacted] b7c-5, b6-5 and [redacted] b7c-5, b6-5 were the ones who wanted me to bring three bottles of Gin.

Q: Who have you seen drink alcohol?

A: Not actually seen anyone.

Q: Have you seen any soldiers with large amounts of dinar?

A: [redacted] b7c-5, b6-5 had about 200,000 - 250,000 dinar. He told me "Who gives a fuck I am taking the money I find". I refused to take dinar from any of the soldiers because I believed they stole it because they should not have that much dinar. One time [redacted] b7c-5, b6-5 told [redacted] b7c-5, b6-5 to give me 10,000 dinar for a Swiss Army knife. I refused to take the money. I wanted to get paid with dollars because I was [redacted] knew they weren't stolen.

Q: Do you think they stole the money?

A: Yes because I have heard soldiers were doing that.

Q: What did [redacted] b7c-5, b6-5 tell you about going downtown?

A: About 2 weeks ago he told me he went downtown to an Iraqi house and "got drunk and had fun"?

Q: Who told you about the Army coming to talk to you?

A: [redacted] b7c-5, b6-5. He told me SA [redacted] b7c-3, b6-3 told that [redacted] b7c-5, b6-5 gave me weapons and I sold them.

Q: Did anyone else have large amounts of dinar?

A: I think it was [redacted] b7c-5, b6-5 who had about 50,000 - 75,000 dinar he showed me.

DODDOACID-005291

INITIALS OF PERSON MAKING STATEMENT [redacted] b7c-4, b6-4 PAGE 2 OF 3 PAGES

STATEMENT OF Mr [REDACTED] TAKEN AT Baghdad Iraq DATED 21 May 03

9. STATEMENT (Continued)

~~b7c-4, b6-4
[REDACTED]~~

NOT USED

DODDOACID-005292

~~b7c-4, b6-4
[REDACTED]~~

AFFIDAVIT

I, [REDACTED], HAVE READ OR HAVE HAD READ TO ME THIS STATEMENT WHICH BEGINS ON PAGE 1, AND ENDS ON PAGE 3. I FULLY UNDERSTAND THE CONTENTS OF THE ENTIRE STATEMENT MADE BY ME. THE STATEMENT IS TRUE. I HAVE INITIALED ALL CORRECTIONS AND HAVE INITIALED THE BOTTOM OF EACH PAGE CONTAINING THE STATEMENT. I HAVE MADE THIS STATEMENT FREELY WITHOUT HOPE OF BENEFIT OR REWARD, WITHOUT THREAT OF PUNISHMENT, AND WITHOUT COERCION, UNLAWFUL INFLUENCE, OR UNLAWFUL INDUCEMENT.

[REDACTED] b7c-4, b6-4
(Signature of Person Making Statement)

WITNESSES:

Subscribed and sworn to before me, a person authorized by law to administer oaths, this 21st day of May, 2003 at Baghdad, Iraq

[REDACTED] b7c-1, b6-1
(Signature of Person Administering Oath)

ORGANIZATION OR ADDRESS

[REDACTED]
(Typed Name of Person Administering Oath)

ORGANIZATION OR ADDRESS

3 USC 303
(Authority To Administer Oaths)

INITIALS OF PERSON MAKING STATEMENT

~~b7c-4, b6-4
[REDACTED]~~

PAGE 3 OF 3 PAGES

RIGHT WARNING PROCEDURE/WAIVER CERTIFICATE

For use of this form, see AR 190-30: the proponent agency is ODCSOPS

DATA REQUIRED BY THE PRIVACY ACT

AUTHORITY: Title 10, United States Code, Section 3012(g)
PRINCIPAL PURPOSE: To provide commanders and law enforcement officials with means by which information may be accurately identified.
ROUTINE USES: Your Social Security Number is used as an additional/alternate means of identification to facilitate filing and retrieval.
DISCLOSURE: Disclosure of your Social Security Number is voluntary.

1. LOCATION: AO Power, Baghdad, Iraq
2. DATE: 21 May 03
3. TIME: 1300
4. FILE NO: 0055-03-CTD248
5. NAME (Last, First, MI): [Redacted]
6. SSN: [Redacted]
7. GRADE: [Redacted]
8. ORGANIZATION OR ADDRESS: HHC, 3/69 Armor, 1st BCT, 3ID Ft. Stewart, GA

PART I - RIGHTS WAIVER/NON-WAIVER CERTIFICATE

Section A. Rights

The investigator whose name appears below told me that he/she is with the United States Army Criminal Investigation Command and wanted to question me about the following offense(s) of which I am suspected: Aiding the Enemy, Obstruction of Justice. Before he/she asked me any questions about the offense(s), however, he/she made it clear to me that I have the following rights:

I do not have to answer any question or say anything.
Anything I say or do can be used as evidence against me in a criminal trial.
If I am a personnel subject of the UCMJ, I have the right to talk privately to a lawyer before, during, and after questioning and to have a lawyer present with me during questioning. This lawyer can be a civilian lawyer I arrange for at no expense to the Government or a military lawyer detailed for me at no expense to me, or both.

(For civilians not subject to the UCMJ) I have the right to talk privately to a lawyer before, during, and after questioning and to have a lawyer present with me during questioning. I understand that this lawyer can be one that I arrange for at my own expense, or if I cannot afford a lawyer and want one, a lawyer will be appointed for me before any questioning begins.

If I am now willing to discuss the offense(s) under investigation, with or without a lawyer present, I have a right to stop answering questions at any time, or to speak privately with a lawyer before answering further, even if I sign the waiver below.

5. COMMENTS (Continue on reverse side)
Have you requested a lawyer after being read your rights within the last 30 days?
b7c-5, b6-5

Section B. Waiver

I understand my rights as stated above. I am now willing to discuss the offense(s) under investigation and make a statement without talking to a lawyer first and without having a lawyer present with me.

WITNESSES (If available)
1a. NAME (Type or Print)
b. ORGANIZATION OR ADDRESS AND PHONE
2a. NAME (Type or Print)
b. ORGANIZATION OR ADDRESS AND PHONE
3. SIGNATURE OF SUSPECT/ACCUSED
4. SIGNATURE OF INVESTIGATOR
5. TYPED NAME OF INVESTIGATOR
6. ORGANIZATION OF INVESTIGATOR

Section C. Non-waiver

1 I do not want to give up my rights
I want a lawyer
I do not want to be questioned or say anything
2 SIGNATURE OF INTERVIEWEE

ATTACH THIS WAIVER CERTIFICATE TO ANY SWORN STATEMENT (DA FORM 2823) SUBSEQUENTLY EXECUTED BY THE SUSPECT/ACCUSED

SWORN STATEMENT

For use of this form, see AR 190-45; the proponent agency is ODCSOPS

PRIVACY ACT STATEMENT

AUTHORITY: Title 10 USC Section 301; Title 5 USC Section 2951; E.O. 9397 dated November 22, 1943 (SSA).
PRINCIPAL PURPOSE: To provide commanders and law enforcement officials with means by which information may be accurately identified.
ROUTINE USES: Your social security number is used as an additional/alternate means of identification to facilitate filing and retrieval.
DISCLOSURE: Disclosure of your social security number is voluntary.

1. LOCATION: Ad Power, Baghdad, Iraq
2. DATE (YYYYMMDD): 20030521
3. TIME: 1310 1408
4. FILE NUMBER: 0055-03-CZD347
5. LAST NAME, FIRST NAME, MIDDLE NAME: [REDACTED] b7c-5, b6-5
6. SSN: b7c-5, b6-5
7. GRADE/STATUS: E-3
8. ORGANIZATION OR ADDRESS: HHK 3/69 AR (MTR)
9. [REDACTED] b7c-5, b6-5

WANT TO MAKE THE FOLLOWING STATEMENT UNDER OATH:

BETWEEN THE DATES OF 26 APR 03 AND 18 MAY 03 I WITNESSED AN IRAQI CIVILIAN NAMED [REDACTED] b7c-4, b6-4 VISIT OUR LOCATION NEXT TO AL-WASITH HOSPITAL IN BAGHDAD. HE SPENT MOST OF HIS TIME INTERACTING WITH CPT. [REDACTED] b7c-5, b6-5 AND SGT. [REDACTED] b7c-5, b6-5 BEHIND CLOSED DOORS IN THE ROOM NEXT TO MINE ON THE SECOND FLOOR. [REDACTED] b7c-4, b6-4 WAS SUPPOSEDLY AN EX-SNIPEER IN THE IRAQI ARMY WHO HAD BECOME [REDACTED] b7c-4, b6-4 FOR CPT. [REDACTED] b7c-5, b6-5 HE WOULD BRING JEWELRY, WATCHES, AND LIGHTERS WITH HIM OCCASIONALLY TO SELL TO THE GUYS IN OUR PLATOON; AND ALTHOUGH I NEVER WITNESSED [REDACTED] b7c-4, b6-4 ENTERING OR LEAVING THE BUILDING WITH WEAPONS, I DID SEE HIM HANDLING HANDGUNS UPSTAIRS THAT HE CLAIMED WERE HIS AND TRADING HIS PISTOLS FOR OTHER PISTOLS THAT CERTAIN SOLDIERS HAD CONFISCATED. NOBODY WAS CONCERNED THAT HE WAS ARMED BECAUSE HE WAS ALWAYS AROUND AND WAS A VERY NICE GUY, HE CLAIMED THAT ALL HE WANTED IN RETURN FOR HELPING THE U.S. ARMY WAS A CHANCE TO GO TO AMERICA WITH HIS WIFE AND CHILDREN, AND EVEN ARRANGED FOR US TO USE HIS FRIEND'S PHONES TO CALL OUR LOVED ONES IN THE STATES. AFTER THE POWER STRUGGLE AND PLATOON INTERNAL PROBLEMS STARTED TO GAIN MOMENTUM AND A "SHAKE-DOWN" SEEMED IMMINEENT I TOLD [REDACTED] b7c-4, b6-4 IT WAS PROBABLY A GOOD IDEA TO STAY AWAY FROM CPT. [REDACTED] b7c-5, b6-5 AND NOT GET CAUGHT IN THE MIDDLE OF THIS POWER STRUGGLE. HE SAID THAT HE HAD NOTHING TO HIDE AND HE WOULD BE FINE EVEN IF HIS HOUSE WAS SEARCHED. I SAW [REDACTED] b7c-5, b6-5

10. EXHIBIT:
11. INITIALS OF PERSON MAKING STATEMENT: [REDACTED] b7c-5, b6-5
PAGE 1 OF 3 PAGES
ADDITIONAL PAGES MUST CONTAIN THE HEADING "STATEMENT OF [REDACTED] b7c-5, b6-5 TAKEN AT Ad Power DATED 21 May 03
THE BOTTOM OF EACH ADDITIONAL PAGE MUST BEAR THE INITIALS OF THE PERSON MAKING THE STATEMENT, AND PAGE NUMBER MUST BE INDICATED. 86

USE THIS PAGE IF NEEDED. IF THIS PAGE IS NOT NEEDED, PLEASE PROCEED TO FINAL PAGE OF THIS FORM.

b7c-5, b6-5

b7c-5, b6-5

b7c-5, b6-5

STATEMENT OF

[REDACTED]

TAKEN AT

A. Power

DATED

21 May 03

9. STATEMENT (Continued)

[REDACTED] A COUPLE OF TIMES AFTER THAT BUT DIDN'T HAVE AN OPPORTUNITY TO TALK WITH HIM BEFORE I HAD A CHANCE TO SPEAK WITH HIM AGAIN I HAD HEARD THAT HIS HOUSE HAD BEEN RAIDED, AND SOME OF OUR LEADERSHIP HAD BEEN ARRESTED.

Q: [REDACTED] b7c-4, b6-1

A: [REDACTED] b7c-5, b6-5

Q: Did you actually witness [REDACTED] trade pistols?

A: One time.

Q: Explain?

A: He traded what looked like a .38 for a 9mm. He traded the pistol with PV7 [REDACTED] PFC [REDACTED] was there.

Q: What do you mean by power struggle?

A: SGT [REDACTED] and CPT [REDACTED] were not well liked. This entire situation is about revenge. Well not all but a big part.

Q: Did you tell [REDACTED] to leave town before he got in trouble?

A: I caught him as he was leaving our hardsite. I told him SGT [REDACTED] went to talk to the Chaplain. So did PFC [REDACTED] I told him there was probably going to be an investigation into [REDACTED] and [REDACTED], and that he should stay away from the hardsite.

Q: Did you ever witness [REDACTED] or [REDACTED] consuming alcohol?

A: Yes, but not at the hardsite.

DODDOACID-005295

Q: Did you ever consume any alcohol?

A: Yes b7c-4, b6-4

Q: Was [REDACTED] allowed to go on patrols and sit in on meetings?

A: He sat in on the meetings. I don't think he went on patrols.

Q: Did you ever escort [REDACTED] home?

A: I went over there a couple of times with [REDACTED] and [REDACTED]

Q: Did you or [REDACTED] or [REDACTED] enter the house?

A: When I was there, only [REDACTED] went inside. [REDACTED] and I stayed in the HMM WV.

Q: During the escorts, were any weapons transported to his house?

INITIALS OF PERSON MAKING STATEMENT

[REDACTED] b7c-5, b6-5

PAGE 2 OF 3 PAGES

STATEMENT OF

[Redacted]

TAKEN AT

AD Power

DATED

21 May 03

9. STATEMENT (Continued)

A: I only went a couple of times and I didn't see any weapons being carried into [Redacted] house.

Q: Do you have anything else you wish to add to your statement?

A: NO. !!! End of Statement !!!

DODDOACID-005296

AFFIDAVIT

I, [Redacted], HAVE READ OR HAVE HAD READ TO ME THIS STATEMENT WHICH BEGINS ON PAGE 1, AND ENDS ON PAGE 3. I FULLY UNDERSTAND THE CONTENTS OF THE ENTIRE STATEMENT MADE BY ME. THE STATEMENT IS TRUE. I HAVE INITIALED ALL CORRECTIONS AND HAVE INITIALED THE BOTTOM OF EACH PAGE CONTAINING THE STATEMENT. I HAVE MADE THIS STATEMENT FREELY WITHOUT HOPE OF BENEFIT OR REWARD, WITHOUT THREAT OF PUNISHMENT, AND WITHOUT COERCION, UNLAWFUL INFLUENCE, OR UNLAWFUL INDUCEMENT.

b7c-5, b6-5

[Redacted Signature]

WITNESSES:

Subscribed and sworn to before me, a person authorized by law to administer oaths, this 21st day of May, 2003 at AD Power, Baghdad, Iraq

ORGANIZATION OR ADDRESS

[Redacted]

ORGANIZATION OR ADDRESS

SA [Redacted] 30th MP Det (CID), Ft. Stewart, GA

INITIALS OF PERSON MAKING STATEMENT

[Redacted]

PAGE 3 OF 3 PAGES

SWORN STATEMENT

For use of this form, see AR 190-45; the proponent agency is DDCSOPS

PRIVACY ACT STATEMENT

AUTHORITY: Title 10 USC Section 301; Title 5 USC Section 2951; E.O. 9397 dated November 22, 1943 (SSN).
PRINCIPAL PURPOSE: To provide commanders and law enforcement officials with means by which information may be accurately identified.
ROUTINE USES: Your social security number is used as an additional/alternate means of identification to facilitate filing and retrieval.
DISCLOSURE: Disclosure of your social security number is voluntary.

1. LOCATION: AO Bawer Baghdad Iraq
2. DATE (YYYYMMDD): 2003 May 21
3. TIME: 1321
4. FILE NUMBER: 005503-CID349
5. LAST NAME, FIRST NAME, MIDDLE NAME: [redacted]
6. SSN: [redacted]
7. GRADE/STATUS: E4 - SPC
8. ORGANIZATION OR ADDRESS: HHC, 3/69th Armor, 1st BCT, 3ID, Ft. Stewart, GA

9. I, SPC [redacted], WANT TO MAKE THE FOLLOWING STATEMENT UNDER OATH:
That I have witnessed the person known as [redacted] to be going in and out of our hard site. Some times he would come in empty handed and leave with pistols some of them that I have gotten a close look at and reconized the serial number. Then he would return with white plastic bags unclear on what was in them. Some of which he would gladly empty the contents in front of us. Most of what I saw was jewelry and lighters. Some times Cpt. [redacted] and SSgt. [redacted] would take him home. I have never gone so I am not to sure of what [redacted] was going on. The times that Cpt. [redacted] and SSgt. [redacted] wouldn't be there and [redacted] would come over and wait untill they would show up. When they got there they would kick everyone out of the room so they can talk none of [redacted]

10. EXHIBIT: [redacted]
11. INITIALS OF PERSON MAKING STATEMENT: [redacted]
PAGE 1 OF 3 PAGES

ADDITIONAL PAGES MUST CONTAIN THE HEADING "STATEMENT OF [redacted] TAKEN AT [redacted] DATED 21 May 03
THE BOTTOM OF EACH ADDITIONAL PAGE MUST BEAR THE INITIALS OF THE PERSON MAKING THE STATEMENT, AND PAGE NUMBER MUST BE BE INDICATED.

USE THIS PAGE IF NEEDED. IF THIS PAGE IS NOT NEEDED, PLEASE PROCEED TO FINAL PAGE OF THIS FORM.

STATEMENT OF [redacted] TAKEN AT AO Power DATED 21 May 03

9. STATEMENT (Continued)

It I could hear because it was muffled by the walls. When they kicked people out the only people in the room would be [redacted], Cpt [redacted], SSgt [redacted], Sgt [redacted] and Sgt. [redacted]. On May 18th [redacted] had come into the soldiers sleeping area and showed off a 9mm we had turned in earlier that day and I recognized it by the serial number and the model of the weapon. Also we discussed about a Lamma 9mm that we also had turned in or so we thought was turned in.

DODDOACID-005298

- Q: [redacted]?
- A: [redacted]
- Q: Did you ever witness [redacted] make any deals with [redacted] or [redacted]?
- A: No, every time they talked to him, we were kicked out.
- Q: Did you ever witness [redacted] or [redacted] drink alcohol?
- A: I can't say I witnessed but one night I saw [redacted] throw a bottle off the roof. I don't know what was in the bottle.
- Q: What are the procedures for turning in confiscated weapons?
- A: He would give them to [redacted]. At one point it was put out that we were not to return from a patrol with less than 5 pistols.
- Q: Do you have anything else you wish to add to your statement?

INITIALS OF PERSON MAKING STATEMENT [redacted] PAGE 2 OF 3 PAGES

b7c-4, b6-4

b7c-4, b6-4 0055-03 CED347-576

STATEMENT OF

TAKEN AT

AO Power

DATED

21 May 03

9. STATEMENT (Continued)

A: NO III End of Statement III

b7c-4, b6-4

DODDOACID-005299

AFFIDAVIT

I, [REDACTED], HAVE READ OR HAVE HAD READ TO ME THIS STATEMENT WHICH BEGINS ON PAGE 1, AND ENDS ON PAGE 3. I FULLY UNDERSTAND THE CONTENTS OF THE ENTIRE STATEMENT MADE BY ME. THE STATEMENT IS TRUE. I HAVE INITIALED ALL CORRECTIONS AND HAVE INITIALED THE BOTTOM OF EACH PAGE CONTAINING THE STATEMENT. I HAVE MADE THIS STATEMENT FREELY WITHOUT HOPE OF BENEFIT OR REWARD, WITHOUT THREAT OF PUNISHMENT, AND WITHOUT COERCION, UNLAWFUL INFLUENCE, OR UNLAWFUL INDUCEMENT.

b7c-4, b6-4

(Signature of Person Making Statement)

WITNESSES:

Subscribed and sworn to before me, a person authorized by law to administer oaths, this 21st day of May 03

at AO Power, Baghdad, Iraq

b7c-1, b6-1

(Person Administering Oath)

SA [REDACTED]

30 MP Det (CID), Ft. Stewart, GA

(Authority To Administer Oaths)

ORGANIZATION OR ADDRESS

ORGANIZATION OR ADDRESS

INITIALS OF PERSON MAKING STATEMENT

b7c-4, b6-4

PAGE 3 OF 3 PAGES

SWORN STATEMENT

For use of this form, see AR 190-45; the proponent agency is ODCSOPS

PRIVACY ACT STATEMENT

AUTHORITY: Title 10 USC Section 301; Title 5 USC Section 2951; E.O. 9397 dated November 22, 1943 (SSN).
PRINCIPAL PURPOSE: To provide commanders and law enforcement officials with means by which information may be accurately identified.
ROUTINE USES: Your social security number is used as an additional alternate means of identification to facilitate filing and retrieval.
DISCLOSURE: Disclosure of your social security number is voluntary.

1. LOCATION: FO Power, Baghdad, Iraq; 2. DATE: 2003/04/24; 3. TIME: 1541; 4. FILE NUMBER: 0055-03-CID349; 5. LAST NAME, FIRST NAME, MIDDLE NAME: [redacted]; 6. SSN: [redacted]; 7. GRADE/STATUS: E5 SGT

8. ORGANIZATION OR ADDRESS: HHC 3-69 Ar

9. I, [redacted], WANT TO MAKE THE FOLLOWING STATEMENT UNDER OATH:

[redacted] was a very bad man who was all ways around. He told captain [redacted] where to do raids, even come along. Went on patrols with us heard our meetings and could come over every day. we were told not to worrie about this guy. because he was a friend of Captain [redacted]

I would see him curic a small caliber magazine fed hand gun. He pulled it out one time in front of Sgt [redacted] and jokingly threatened to kill him. He said, "I'm going to give you the hard time. I'm going to fucken Rob you, then kill you." Then they shake hands and he went home. That's how they Joked.

The [redacted] I time also talked about killing Doctor [redacted]. The hospital director, to Cpt [redacted] and I. Said he would use hand Grenades.

I asked if he had guns to protect him self, He said yes. One time I walked into SGT [redacted] room and they all had hand guns out, playing Dominos and I saw the [redacted] and Sgt [redacted] trade guns they were about 38's. - Little magazine fed 380 autos. They both looked similar. I just figured they were trusting friends. And I never heard of a policey doing that, so I didn't think much of it.

10. EXHIBIT: [redacted]; 11. INITIALS OF PERSON MAKING STATEMENT: [redacted]; PAGE 1 OF 3 PAGES

ADDITIONAL PAGES MUST CONTAIN THE HEADING "STATEMENT OF [redacted] TAKEN AT FO Power DATED 21 May 03 [redacted]

THE BOTTOM OF EACH ADDITIONAL PAGE MUST BEAR THE INITIALS OF THE PERSON MAKING THE STATEMENT, AND PAGE NUMBER MUST BE INDICATED.

USE THIS PAGE IF NEEDED. IF THIS PAGE IS NOT NEEDED, PLEASE PROCEED TO FINAL PAGE OF THIS FORM.

STATEMENT OF SGT [redacted] b7c-4, b6-4 TAKEN AT AO Power DATED 21 May 03 [redacted] b7c-4, b6-4

9. STATEMENT (Continued)

On the 18th May 03 the [redacted] b7c-4, b6-4 guy came into our compound with nothing, and walked out with a bag, and a big sledge in his wrist. We, ~~at~~ that day had gathered up all the guns and hand guns to Sgt [redacted] b7c-5, b6-5 and Sgt [redacted] b7c-4, b6-4 took the box into their Room.

We probably had collected a total of 60 AK47's, but only 12 broken ones were turned in. We had found lots of new ones but no where to be seen. Also a Beretta ~~azouzzie~~ was missing. We kept a pile of mortar rounds and RPG's. If any guns were ever going to be turned in the RPG's would of went too. Since they stayed there until the 18th ^{of May} (RPG's) I know the other guns never got turned in. And would it they have taken all the guns not just 1 or 2 here and there to get turned in.

1 time we went to a house to find a gun that we knew he had. He took the gun and split. I found a large stack of money. I told the guys family, we would trade the money for a gun. I gave the money to SGT [redacted] b7c-5, b6-5. They lite up and they looked at it. Six hours later when the man came for his money, the pile didn't seem so big.

Also 1 time we went on the roof because we heard gun shots. I was told SGT [redacted] b7c-5, b6-5 did it. I did see a c.v. lim gun in his hand, but didn't think much of it. I have nothing else to add to this statement.

Nothing Else Follows 21 May 02

DODDOACID-005301

Nothing else follows. Follows 21 May 02

b7c-4, b6-4

INITIALS OF PERSON MAKING STATEMENT: [redacted] PAGE 2 OF 3 PAGES

STATEMENT OF

SGT [redacted]

TAKEN AT

AO Power

DATED

21 May 03

9. STATEMENT (Continued)

21 May 03
Nothing Else Follows
Nothing else Follows

DODDOACID-005302

b7c-4, b6-4

AFFIDAVIT

I, [redacted], HAVE READ OR HAVE HAD READ TO ME THIS STATEMENT WHICH BEGINS ON PAGE 1, AND ENDS ON PAGE 3. I FULLY UNDERSTAND THE CONTENTS OF THE ENTIRE STATEMENT MADE BY ME. THE STATEMENT IS TRUE. I HAVE INITIALED ALL CORRECTIONS AND HAVE INITIALED THE BOTTOM OF EACH PAGE CONTAINING THE STATEMENT. I HAVE MADE THIS STATEMENT FREELY WITHOUT HOPE OF BENEFIT OR REWARD, WITHOUT THREAT OF PUNISHMENT, AND WITHOUT COERCION, UNLAWFUL INFLUENCE, OR UNLAWFUL INDUCEMENT.

[redacted] b7c-4, b6-4
(Signature of Person Making Statement)

WITNESSES:

Subscribed and sworn to before me, a person authorized by law to administer oaths, this 21st day of May, 2003 at AO Power, Baghdad, Iraq

[redacted] b7c-1, b6-1
(Signature of Person Administering Oath)

ORGANIZATION OR ADDRESS

SA [redacted]
(Typed Name of Person Administering Oath)

ORGANIZATION OR ADDRESS

30th MP Det (CID), Ft Stewart, GA
(Authority To Administer Oaths)

INITIALS OF PERSON MAKING STATEMENT

b7c-4, b6-4

b7c-4, b6-4

PAGE 3 OF 3 PAGES

SWORN STATEMENT

For use of this form, see AR 190-45; the proponent agency is ODCSOPS

PRIVACY ACT STATEMENT

AUTHORITY: Title 10 USC Section 301; Title 5 USC Section 2951; E.O. 9397 dated November 22, 1943 (SSN).
PRINCIPAL PURPOSE: To provide commanders and law enforcement officials with means by which information may be accurately identified.
ROUTINE USES: Your social security number is used as an additional/alternate means of identification to facilitate filing and retrieval.
DISCLOSURE: Disclosure of your social security number is voluntary.

1. LOCATION Baghdad
2. DATE (YYYYMMDD) 2003-05-21
3. TIME 1610
4. FILE NUMBER b7c-4, b6-4
5. LAST NAME, FIRST NAME, MIDDLE NAME [redacted] b7c-4, b6-4
6. SSN [redacted] b7c-4, b6-4
7. GRADE/STATUS E-2
8. ORGANIZATION OR ADDRESS HHC 3/69 Ar
DODDOACID-005303

9. [redacted] b7c-4, b6-4 WANT TO MAKE THE FOLLOWING STATEMENT UNDER OATH:

On 18 May 2003, I witnessed the Iraqi Civilian enter our hard sight located at Alwasati hospital. he let himself into our room, and engaged in conversation with some fello soldiers. he lifted his shirt and exposed multiple pistols, he drew one, and proceeded to show all the soldiers in the room. after a few minutes SFC [redacted] b7c-4, b6-4 came into the room and informed us that our security had been compromised, and we had to update our security. he continued on with specifics such as the track positions, the updated guard positions, and rotation. while the Iraqi civilian was in attendance. On 17 May 2003 the same Iraqi civilian entered our hard sight with a yellow bag while I was on radio watch. a short while later some of Red platoon (the Aco 3/69 Ar tank platoon co-located with us) members with a wooden box with a glass top that was filled with silver rings when I asked about them, one soldier told me they were for sale from the [redacted] b7c-4, b6-4 - [redacted] b7c-4, b6-4 that's how most people referred to the Iraqi civilian. On multiple other dates previous to the 17th of May 2003 I witnessed the same Iraqi civilian

10. EXHIBIT 13
11. INITIALS OF PERSON MAKING STATEMENT [redacted] b7c-4, b6-4
PAGE 1 OF 5 PAGES

ADDITIONAL PAGES MUST CONTAIN THE HEADING "STATEMENT OF [redacted] b7c-4, b6-4 TAKEN AT AD [redacted] b7c-4, b6-4 DATED 21 May 03 [redacted] b7c-4, b6-4
THE BOTTOM OF EACH ADDITIONAL PAGE MUST BEAR THE INITIALS OF THE PERSON MAKING THE STATEMENT, AND PAGE NUMBER MUST BE INDICATED. 06. 95

FOUO

EX: 1

USE THIS PAGE IF NEEDED. IF THIS PAGE IS NOT NEEDED, PLEASE PROCEED TO FINAL PAGE OF THIS FORM.

STATEMENT OF [REDACTED] TAKEN AT AO-Power DATED 21-May-03
[REDACTED] [REDACTED]

9. STATEMENT (Continued)

~~I~~ [REDACTED] Enter our handsight, usually with one or more Bags. he was never searched when I witnessed [REDACTED] enter our compound, and would spend most of his time Colocated with Cpt [REDACTED] and Sgt [REDACTED] in their sleeping quarters. A few weeks before the 18th of May 2003, I'm not sure of the exact date [REDACTED] Most of my section were in our room when we heard gun shots from outside our location. We all grabbed our rifles and Ran to the roof to clear the area. after a few minutes we saw SFC [REDACTED] [REDACTED] standing on one of the adjoining roofs to the hospital, he was asking why we were all on the roof, we told him we heard gunfire and were clearing the roof. he told us to forget it and go inside. on another date I entered CPT, [REDACTED] and Sgt [REDACTED] room on the desk was about 20 or so lighters ranging from gold, to silver, I look at a few, and Sgt [REDACTED] asked me. If I wanted any, I said sure. he then said 20 dollars, a piece, I told him never mind. Sgt [REDACTED] informed me the [REDACTED] was selling them not him. I left the room. On or about the 16th of May 03 I was talking to Sgt [REDACTED] in his room while Cpt [REDACTED] was present, [REDACTED] SFC [REDACTED] entered and told us, If we did not bring him at least 5 Pistols by the end of our

INITIALS OF PERSON MAKING STATEMENT [REDACTED] PAGE 2 OF 3 PAGES

STATEMENT OF [REDACTED] TAKEN AT AO-Power DATED 21-May-03
b7c4, b6-4 b7c4, b6-4

9. STATEMENT (Continued)

next Patrol he was going to make Sgt [REDACTED] go out with us on every single patrol. b7c5, b6-5

Q: [REDACTED] b7c-1, b6-1

A: [REDACTED] b7c4, b6-4

Q: Did you ever witness the Iraqi civilian trading, buying or selling weapons?

A: No.

Q: Did you ever witness the Iraqi civilian with weapons that appeared to have been confiscated previously?

A: Yes, PFC [REDACTED] told that on the occasion when the Iraqi civilian had the three pistols, that one of the pistols he recognized because he had confiscated it from another Iraqi national some time before.

Q: Did you ever witness [REDACTED] or [REDACTED] drinking alcohol? b7c-5, b6-5

A: Yes, one time while out patrolling he stopped at a church and the civilians brought out what looked like a shot of whiskey. Sgt [REDACTED] drank it. b7c-5, b6-5

Q: Do you have anything else you wish to add to your statement?

A: No. END OF STATEMENT!!!

b7c4, b6-4

AFFIDAVIT

I, [REDACTED], HAVE READ OR HAVE HAD READ TO ME THIS STATEMENT WHICH BEGINS ON PAGE 1, AND ENDS ON PAGE 3. I FULLY UNDERSTAND THE CONTENTS OF THE ENTIRE STATEMENT MADE BY ME. THE STATEMENT IS TRUE. I HAVE INITIALED ALL CORRECTIONS AND HAVE INITIALED THE BOTTOM OF EACH PAGE CONTAINING THE STATEMENT. I HAVE MADE THIS STATEMENT FREELY WITHOUT HOPE OF BENEFIT OR REWARD, WITHOUT THREAT OF PUNISHMENT, AND WITHOUT COERCION, UNLAWFUL INFLUENCE, OR UNLAWFUL INDUCEMENT.

b7c4, b6-4

(Signature of Person Making Statement)

WITNESSES:

Subscribed and sworn to before me, a person authorized by law to administer oaths, this 21st day of May, 2003 at AO Power, Baghdad, Iraq

[REDACTED] b7c-1, b6-1

(Signature of Person Administering Oath) b7c-1, b6-1

SA [REDACTED]

(Typed Name of Person Administering Oath)

30th MP Det (CID), Ft. Stewart, GA

(Authority To Administer Oaths)

ORGANIZATION OR ADDRESS

ORGANIZATION OR ADDRESS

b7c-4, b6-4

INITIALS OF PERSON MAKING STATEMENT

PAGE 3 OF 3 PAGES

SWORN STATEMENT

For use of this form, see AR 190-45; the proponent agency is ODCSOPS

PRIVACY ACT STATEMENT

AUTHORITY: Title 10 USC Section 301; Title 5 USC Section 2951; E.O. 9397 dated November 22, 1943 (SSN).
PRINCIPAL PURPOSE: To provide commanders and law enforcement officials with means by which information may be accurately identified.
ROUTINE USES: Your social security number is used as an additional/alternate means of identification to facilitate filing and retrieval.
DISCLOSURE: Disclosure of your social security number is voluntary.

1. LOCATION: POWER AD; 2. DATE (YYYYMMDD): 20030521; 3. TIME: 1638; 4. FILE NUMBER: 0055-03-CID349; 5. LAST NAME, FIRST NAME, MIDDLE NAME: [REDACTED]; 6. SSN: [REDACTED]; 7. GRADE/STATUS: E-4

8. ORGANIZATION OR ADDRESS: HHC 3-69AR BN (MORTARS)

9. I, [REDACTED], WANT TO MAKE THE FOLLOWING STATEMENT UNDER OATH:

AN IRAQI NATIONAL THAT WE REFER TO AS [REDACTED] COMES TO OUR HARDSITE NEARLY EVERYDAY AND BRINGS BAGS OF VARIOUS GOODS TO SELL TO US TO INCLUDE STERLING SILVER JEWELRY, IRAQI BAYONETS, AND HANDLUFFS. ONE INCIDENT, ON OR AROUND THE 25 APR 2003 AT APPROXIMATELY 2200 HOURS I WAS TOLD TO GO ON A SHORT CONVOY INVOLVING TWO M998 (NUMBERS) HQ56 AND HQ57. I RODE IN THE BACK OF HQ57 AND SGT. [REDACTED] "TCJ" HQ56 AND THE [REDACTED] RODE IN HQ56 AS WELL AND SAT BEHIND SGT. [REDACTED] ONCE WE ARRIVED AT [REDACTED] HOUSE, WHILE LOOKING FROM THE BACK OF HQ57, I WITNESSED [REDACTED] EXIT THE VEHICLE (HQ56) WITH A BAG IN HIS HAND, WALK UP TO HQ56 TC DOOR, SPEAK TO SGT. [REDACTED] FOR A MOMENT, THEN [REDACTED] WALKS TO THE BACK OF HQ56, OPENS UP THE BACK AND REACHES INSIDE. THE [REDACTED] PRODVED FROM THE BACK OF HQ56 A LARGE RIFLE THAT RESEMBLED A "MAUSER" WITH WHICH I HAD SEEN SFC [REDACTED] EXAMINING THAT SOME RIFLE THE DAY BEFORE IN SGT [REDACTED] AND CAPTAIN [REDACTED] ROOM, AND ON THE DAY OF [REDACTED]

10. EXHIBIT: [REDACTED]; 11. INITIALS OF PERSON MAKING STATEMENT: [REDACTED]; PAGE 1 OF 3 PAGES

ADDITIONAL PAGES MUST CONTAIN THE HEADING "STATEMENT OF [REDACTED] TAKEN AT POWER DATED 21 Mar 03 [REDACTED] [REDACTED] [REDACTED] THE BOTTOM OF EACH ADDITIONAL PAGE MUST BEAR THE INITIALS OF THE PERSON MAKING THE STATEMENT, AND PAGE NUMBER MUST BE INDICATED.

USE THIS PAGE IF NEEDED. IF THIS PAGE IS NOT NEEDED, PLEASE PROCEED TO FINAL PAGE OF THIS FORM.

STATEMENT OF [REDACTED] TAKEN AT AD Tower DATED 21 Mar 03

[REDACTED] b7c-4, b6-4

[REDACTED] b7c-4, b6-4

9. STATEMENT (Continued)

THIS EVENT AT AROUND 1800 HOURS, I SEEN PFC [REDACTED] CARRY THIS SAME RIFLE FROM UPSTAIRS TO HQ56. AT THIS POINT, THE [REDACTED] TAKES THE RIFLE OUT OF HQ56 AND HOLDS IT ALONG HIS OUTER LEG. IN WHAT APPEARED TO BE AN EFFORT TO CONCEAL IT FROM PLAIN VIEW. HE [REDACTED] THEN WALKS WITH RIFLE ALONG HIS LEG INTO HIS HOUSE AND GOES INSIDE, SHUTTING THE DOOR BEHIND HIM. AT THIS POINT, WE (HQ56 AND HQ57) TURN AROUND AND RETURN TO OUR NAROSIT.

ALSO TODAY, 18 MAY 2003 AT AROUND 1800 HOURS, SFC [REDACTED] SGT. [REDACTED], AND CAPTAIN [REDACTED] TELL EVERYONE IN OUR PLATOON TO TURN IN ALL CONFISCATED PISTOLS INTO ONE "MRE" BOX AND PUT ALL AK47S, RPGs, MAGAZINES, AND BAYONETS INTO THE BACK OF HQ57 WHICH WE DID AND I WITNESSED APPROXIMATELY 15-20 HANDGUNS PUT INTO BOX. SFC [REDACTED] WAS LAYING THE HANDGUNS IN ROWS WHEN I WENT UPSTAIRS TO MY ROOM FOR A WHILE AND EVENTUALLY WENT ON PATROL WITH NINE OTHER PEOPLE. WHEN WE WERE WALKING BACK, SFC [REDACTED] TELLS ME AND PFC [REDACTED] TO GET IN THE BACK OF HQ57 TO GUARD TWO IRAQI NATIONALS AND TO KEEP TURN IN ALL WEAPONS. AS WE ARE RIDING TO THE WEAPON AND AMMUNITION DROP OFF POINT, ME AND PFC [REDACTED] BOTH LOOKED INSIDE THE MRE BOX WITH ALL THE HANDGUNS AND NOTICED MANY WERE MISSING. IT APPEARED THERE WERE ONLY MAYBE 7 OR 8 HANDGUNS IN THE BIN AND I ALSO NOTICED A HANDGUN THAT

INITIALS OF PERSON MAKING STATEMENT

[REDACTED] b7c-4, b6-4

PAGE 2 OF 3 PAGES

Fouo

DODDOACID-005307

b7c-4, b6-4

EXHIBIT

STATEMENT OF

TAKEN AT AD Power

DATED 21 May 03

9. STATEMENT (Continued)

I HAD TALKED IN EARLIER THAT DAY AND
 PUT IN THAT SOME MORE BOX WAS NOW
 NOT IN THERE. WE TURN IN ALL WEAPONS ON
 HQ57 (WHICH ONLY APPEARED TO BE VERY "CHEAP
 AND "BROKEN" WEAPONS) INTO WEAPON AND AMMUNITION
 DUMP AND RETURN TO MAVERICK HARDWARE AS
 AROUND 1400 HOURS THAT SAME DAY, [REDACTED] GUY
 COMES TO OUR NAROSITE AND GOES TO CAPTAIN
 [REDACTED] SGT. [REDACTED] AND SFC. [REDACTED] ROOM.
 SHORTLY AFTER, LTC. [REDACTED] CAPT. [REDACTED] AND
 THEIR ESCORTS SHOW UP AT OUR NAROSITE.
 [REDACTED] TRACKS INTO OUR ROOM AND SITS ON
 SPC [REDACTED] COT. HE THEN PULLS
 OUT ONE OF THREE HANDGUNS FROM HIS WAIST
 BAND AND SHOWS SPC [REDACTED] AND PVT [REDACTED]
 IT, APPARENTLY GLOATING ON HOW NICE IT WAS.
 I WAS ON MY COT MAYBE 4 METERS AWAY
 AND THE HANDGUN WHICH [REDACTED] HAD APPEARED
 TO BE A HANDGUN WHICH WE HAD TURNED
 INTO THE MORE BOX AND WHICH WAS MISSING
 WHEN I CHECKED THE BOX BEFORE TURN IN
 WILL HAVE NOTHING ELSE TO ADD TO THIS STATEMENT!!!

AFFIDAVIT

I, [REDACTED], HAVE READ OR HAVE HAD READ TO ME THIS STATEMENT
 WHICH BEGINS ON PAGE 1, AND ENDS ON PAGE 3. I FULLY UNDERSTAND THE CONTENTS OF THE ENTIRE STATEMENT MADE
 BY ME. THE STATEMENT IS TRUE. I HAVE INITIALED ALL CORRECTIONS AND HAVE INITIALED THE BOTTOM OF EACH PAGE CONTAINING THE STATEMENT. I HAVE MADE THIS
 STATEMENT FREELY WITHOUT HOPE OF BENEFIT OR REWARD, WITHOUT THREAT OF PUNISHMENT, AND WITHOUT COERCION, UNLAWFUL INFLUENCE, OR UNLAWFUL INDUCEMENT.

[REDACTED] b7c-4, 66-4
 (Signature of Person Making Statement)

WITNESSES:

Subscribed and sworn to before me, a person authorized by law to
 administer oaths, this 21st day of May, 2003
 at AD Power, Breddach, Iraq

ORGANIZATION OR ADDRESS

SA [REDACTED] b7c-1, 66-1

ORGANIZATION OR ADDRESS

3rd MP Det (CTD), FSGA
 (Authority To Administer Oaths)

INITIALS OF PERSON MAKING STATEMENT: [REDACTED]

DODDOACID-005308

PAGE 3 OF 3 PAGES

F200

b7c-4, 66-4

SWORN STATEMENT

For use of this form, see AR 190-45, the proponent agency is ODCSOPS

PRIVACY ACT STATEMENT

AUTHORITY: Title 10 USC Section 301; Title 5 USC Section 2951; E.O. 9397 dated November 22, 1943 /SSN/
PRINCIPAL PURPOSE: To provide commanders and law enforcement officials with means by which information may be accurately identified.
ROUTINE USES: Your social security number is used as an additional/alternate means of identification to facilitate filing and retrieval.
DISCLOSURE: Disclosure of your social security number is voluntary.

1. LOCATION: AO Power, Baghdad, Iraq
2. DATE (YYYYMMDD): 20030521
3. TIME: 1654
4. FILE NUMBER: 0055-03-CID349
5. LAST NAME, FIRST NAME, MIDDLE NAME: [REDACTED]
6. SSN: [REDACTED]
7. GRADE/STATUS: E-3/PFC
8. ORGANIZATION OR ADDRESS: HHC 3-69 AR BN
DODDOACID-005309

WANT TO MAKE THE FOLLOWING STATEMENT UNDER OATH:

I WAS IN THE BACK OF HQ 57 WHEN I WAS TOLD BY CPT. [REDACTED] THAT IT WAS OK TO GIVE THE IRAQI NATIONAL WHO WE CALL [REDACTED] CPT. [REDACTED] TOLD ME IT WAS OK TO GIVE [REDACTED] AN AUTOMATIC WEAPON (AK4) AND A MUSER, TO HIM ON OR AROUND 10 APR 2003, 2130. ON OR AROUND 13 MAY 2003 I HAD OBSERVED THE IRAQI NATIONAL "[REDACTED]" ENTER OUR COMPOUND WITHOUT BEING SEARCHED, AND ENTERING WITHOUT A BAG, LATER ON THAT DAY AROUND 1700-1900 HE LEFT WITH A WHITE PLASTIC BAG IN HIS HAND. THERE HAVE ALSO BEEN TIMES WHERE [REDACTED] ENTERS WITH A BAG(S) AND LEAVES WITHOUT ANY BAGS. I NOTICED CPT. [REDACTED] HAVING 3 HANDGUNS WALKING OUTSIDE WITH THEM AND GIVING THEM TO [REDACTED]. FROM WHERE I WAS AT THE PISTOLS LOOKED LIKE THEY WERE 9MM HANDGUNS. AS CPT. [REDACTED] HANDED [REDACTED] THE 3 HANDGUNS, [REDACTED] PROCEEDED TO PUT THEM UNDER HIS SHORT TO KEEP THEM HIDDEN. [REDACTED] ALSO HAD A WHITE BAG WITH SOMETHING IN IT. [REDACTED] WAS ALWAYS INSIDE OUR COMPOUND LATE AT NIGHT BETWEEN 2300-0000 HRS. HE ALSO KNEW WHERE EVERYONE SLEPT

10. EXHIBIT: 15
11. NAME OF PERSON MAKING STATEMENT: [REDACTED]
PAGE 1 OF 3 PAGES
TAKEN AT: AO Power DATED: 21 May 03

b7c-4, b6-4

0055-03 27349

5%

STATEMENT OF

TAKEN AT

AD Tower

DATED

21 May 03

9. STATEMENT (Continued)

WHAT TIME THE GUARD SHIFTS CHANGED. HE ALSO KNEW ALL OUR INFORMATION, MEANING HE WAS IN THE SAME ROOM WHEN WE GOT OUR BRIEFINGS, ALSO KNEW OUR SET UP AS WELL. I ALSO HEARD THAT [REDACTED] WANTED WEAPONS IN TRADE FOR THE ITEMS HE SOLD TO CPT. [REDACTED] INSTEAD OF THE PAYMENT OF MONEY. [REDACTED] WAS ALSO SELLING GOLD WATCHES, CHAINS, RINGS, AND KNIVES. I ALSO HEAR THAT [REDACTED] WAS SEEN ON THE STREETS SELLING THE WEAPONS TO GET THE JEWELRY TO SELL TO CPT. [REDACTED]. CPT. [REDACTED] ALSO TOOK HIM ON PATROLS WITH US WHEN WE WENT OUT ON OUR PATROLS. I ALSO HEARD THAT CPT. [REDACTED], SGT [REDACTED], AND SSG [REDACTED] TOOK THE HUMV OUT LATE AT NIGHT TO DO PATROLS BY THEMSELVES, BECAUSE THEY DIDNT WANT US THE EM'S TO KNOW WHAT THEY WERE DOING.

Q: [REDACTED]?

A: [REDACTED] b7c-4, b6-4

Q: Did you ever witness [REDACTED] asking anyone if they wanted to trade weapons?

A: Not any of the enlisted members (EM's).

Q: How do you know the weapons that [REDACTED] was given by [REDACTED] or [REDACTED] had been previously confiscated by other members of your unit days prior?

A We knew something was going, so we started writing down serial numbers to the weapons we seized. Later, we found [REDACTED] to be in possession of weapons we had seized.

INITIALS OF PERSON MAKING STATEMENT

[REDACTED] b7c-4, b6-4

PAGE 2 OF 2 PAGES

STATEMENT OF [REDACTED] TAKEN AT AO Power DATED 21 May 2003

B- STATEMENT (Continued)

Q: Did you ever witness [REDACTED] or [REDACTED] consume alcohol?
 A: No.
 Q: Do you have anything else you wish to add to your statement?
 A: I haven't seen them using alcohol but I heard alcohol was found in their room.
 Q: Anything else?
 A: No. /// END OF STATEMENT ///

DODDOACID-005311

b7c-4,66-4

AFFIDAVIT

I, [REDACTED], HAVE READ OR HAVE HAD READ TO ME THIS STATEMENT WHICH BEGINS ON PAGE 1, AND ENDS ON PAGE [REDACTED]. I FULLY UNDERSTAND THE CONTENTS OF THE ENTIRE STATEMENT MADE BY ME. THE STATEMENT IS TRUE. I HAVE INITIALED ALL CORRECTIONS AND HAVE INITIALED THE BOTTOM OF EACH PAGE CONTAINING THE STATEMENT. I HAVE MADE THIS STATEMENT FREELY WITHOUT HOPE OF BENEFIT OR REWARD, WITHOUT THREAT OF PUNISHMENT, AND WITHOUT COERCION, UNLAWFUL INFLUENCE, OR UNLAWFUL INDUCEMENT.

[REDACTED] b7c-4,66-4
(Signature of Person Making Statement)

WITNESSES:

Subscribed and sworn to before me, a person authorized by law to administer oaths, this 21st day of May, 2003 at AO Power, Barksdale, Troy

ORGANIZATION OR ADDRESS

[REDACTED] b7c-4,66-1
(Signature of Person Administering Oath)

ORGANIZATION OR ADDRESS

Sgt [REDACTED] b7c-1,66-1
(Typed Name of Person Administering Oath)
30th MP Det (CID), Ft Stewart, GA
(Authority To Administer Oaths) b7c-4,66-4

INITIALS OF PERSON MAKING STATEMENT

PAGE 3 OF 7 PAGES

FJUW

Exhibit 15

SWORN STATEMENT

For use of this form, see AR 190-45, the proponent agency is ODCSOPS

PRIVACY ACT STATEMENT

AUTHORITY: Title 10 USC Section 301, Title 5 USC Section 2951, E.O. 9397 dated November 22, 1943 (SSN)
PRINCIPAL PURPOSE: To provide commanders and law enforcement officials with means by which information may be accurately identified.
ROUTINE USES: Your social security number is used as an additional/alternate means of identification to facilitate filing and retrieval.
DISCLOSURE: Disclosure of your social security number is voluntary.

1. LOCATION: AO Power, Baghdad, Iraq
2. DATE (YYYYMMDD): 20030518
3. TIME: 1705
4. FILE NUMBER: 055-03-CID349
5. LAST NAME, FIRST NAME, MIDDLE NAME: [Redacted]
6. SSN: [Redacted]
7. GRADE/STATUS: PFC
8. ORGANIZATION OR ADDRESS: HHC 3-69 AR MTRS
9. [Redacted]

... WANT TO MAKE THE FOLLOWING STATEMENT UNDER OATH:
on three different occasions, on or around the 25 April 2003. I witnessed the "Iraqi National" take 2 AK-47's out of HA 56 and take them inside his home. I do not know where the AK's came from. I did not see anyone put the AK's in the Humvee. The only person to enter the home was the "Iraqi National." Cpt. [Redacted] was to 2 of the three times. Sgt. [Redacted] was to the last time.
ON the 18 of May 2003 I witnessed the "Iraqi National" leave our compound with three handguns stuffed in his pants. Two of the handguns he showed to me and fellow soldiers. I usually identified them as being handguns my section seized. One being a sig 2 the other a CZ 75.
Every other day the "Iraqi National" enters our compound without being searched. He always has at least one bag of various merchandise to trade. When he comes to the gate we were told to just let him through.

DODDOACID-005312

Q: [Redacted] b7c-1,66-1

A: [Redacted] b7c-4,66-4

Q: Did you ever witness the "Iraqi National" trade weapons with anyone in your unit?

A: No.

Q: Did you ever witness anyone in your unit cons... b7c-4,66-4

10 EXHIBIT: 16
INITIALS OF PERSON MAKING STATEMENT: [Redacted]
PAGE 1 OF 2
ADDITIONAL PAGES MUST CONTAIN THE HEADING 'STATEMENT OF ... TAKEN AT: AO Power DATED: 21 May 03
THE BOTTOM OF EACH ADDITIONAL PAGE MUST BEAR THE INITIALS OF THE PERSON MAKING THE STATEMENT, AND PAGE NUMBER MUST BE INDICATED.

67C-4,66-4

055-03 CID349-59657

STATEMENT OF [REDACTED] TAKEN AT AD Power DATED 21 May 03

B: STATEMENT (Continued)

alcohol?

A: Yes, I did. I don't know about others.

Q: Do you have anything else you wish to add to your statement?

A: No.!!! End of Statement!!!

[REDACTED] 67C-4,66-4

[REDACTED] 67C-4,66-4

67C-4,66-4

DODDOACID-005313

AFFIDAVIT

I, [REDACTED], HAVE READ OR HAVE HAD READ TO ME THIS STATEMENT WHICH BEGINS ON PAGE 1, AND ENDS ON PAGE 21. I FULLY UNDERSTAND THE CONTENTS OF THE ENTIRE STATEMENT MADE BY ME. THE STATEMENT IS TRUE. I HAVE INITIALED ALL CORRECTIONS AND HAVE INITIALED THE BOTTOM OF EACH PAGE CONTAINING THE STATEMENT. I HAVE MADE THIS STATEMENT FREELY WITHOUT HOPE OF BENEFIT OR REWARD, WITHOUT THREAT OF PUNISHMENT, AND WITHOUT COERCION, UNLAWFUL INFLUENCE, OR UNLAWFUL INDUCEMENT.

[REDACTED] 67C-4,66-4
Signature of Person Making Statement

WITNESSES:

Subscribed and sworn to before me, a person authorized by law to administer oaths, this 21st day of May, 2003 at AD Power Addition (72)

ORGANIZATION OR ADDRESS

[REDACTED] 67C-1,66-1
Signature of Person Administering Oath

ORGANIZATION OR ADDRESS

[REDACTED] 67C-1,66-4
30th MP Det (CID), FSGA
(Authority To Administer Oaths)

INITIALS OF PERSON MAKING STATEMENT

67C-4,66-4

PAGE 2 OF 2 PAGES

RIGHTS WARNING PROCEDURE/WAIVER CERTIFICATE

For use of this form, see AR 190-30; the proponent agency is ODCSOPS

DATA REQUIRED BY THE PRIVACY ACT

AUTHORITY: Title 10, United States Code, Section 3012(g)
PRINCIPAL PURPOSE: To provide commanders and law enforcement officials with means by which information may be accurately identified.
ROUTINE USES: Your Social Security Number is used as an additional/alternate means of identification to facilitate filing and retrieval.
DISCLOSURE: Disclosure of your Social Security Number is voluntary.

1. LOCATION: Baghdad, Iraq
2. DATE: 21 MAY 03
3. TIME: 1745
4. FILE NO:
5. NAME (Last, First, MI): [Redacted]
6. SSN: [Redacted]
7. GRADE/STATUS: E-5
8. ORGANIZATION OR ADDRESS: HHC, 3169th Armor, Ft Stewart, GA 31314

PART I - RIGHTS WAIVER/NON-WAIVER CERTIFICATE

Section A. Rights

The investigator whose name appears below told me that he/she is with the United States Army Criminal Investigation Division and wanted to question me about the following offense(s) of which I am suspected/accused: Dealing/selling/trading captured property; False Statement

- 1. I do not have to answer any question or say anything.
2. Anything I say or do can be used as evidence against me in a criminal trial.
3. (For personnel subject to the UCMJ) I have the right to talk privately to a lawyer before, during, and after questioning...
4. If I am now willing to discuss the offense(s) under investigation, with or without a lawyer present, I have a right to stop answering questions at any time...

5. COMMENTS (Continue on reverse side) HAVE YOU BEEN ADVISED OF YOUR RIGHTS WITHIN THE PAST 30 DAYS AND REQUESTED A LAWYER? Y/N [Redacted]

Section B. Waiver

I understand my rights as stated above. I am now willing to discuss the offense(s) under investigation and make a statement without talking to a lawyer first and without having a lawyer present with me [Redacted]

WITNESSES (If available)
1a. NAME (Type or Print)
b. ORGANIZATION OR ADDRESS AND PHONE
2a. NAME (Type or Print)
b. ORGANIZATION OR ADDRESS AND PHONE
3. SIGNATURE OF INTERVIEWEE
4. SIGNATURE OF SUPERVISOR
5. TYPED NAME OF INVESTIGATOR
6. ORGANIZATION OF INVESTIGATOR

Section C. Non-waiver

- 1. I do not want to give up my rights
I want a lawyer
I do not want to be questioned or say anything

2. SIGNATURE OF INTERVIEWEE DODDOACID-005314

ATTACH THIS WAIVER CERTIFICATE TO ANY SWORN STATEMENT (DA FORM 2823) SUBSEQUENTLY EXECUTED BY THE SUSPECT/ACCUSED

SWORN STATEMENT

For use of this form, see AR 190-45, the proponent agency is DDCSOPS

PRIVACY ACT STATEMENT

AUTHORITY: Title 10 USC Section 301, Title 5 USC Section 2951; E.O. 9397 dated November 22, 1943 (SSN).
PRINCIPAL PURPOSE: To provide commanders and law enforcement officials with means by which information may be accurately identified.
ROUTINE USES: Your social security number is used as an additional/alternate means of identification to facilitate filing and retrieval.
DISCLOSURE: Disclosure of your social security number is voluntary.

1. LOCATION Baghdad Iraq	2. DATE (YYYYMMDD) 2003 05 21	3. TIME 1850	4. FILE NUMBER
5. LAST NAME, FIRST NAME, MIDDLE NAME [REDACTED]	6. SSN [REDACTED]	7. GRADE/STATUS SGT	
8. ORGANIZATION OR ADDRESS HHC 3-69 AR Ft. Stewart, GA 31314			

9. [REDACTED] WANT TO MAKE THE FOLLOWING STATEMENT UNDER OATH:

I would like to elaborate on my previous statement. Although I was never asked IF I had personally given [REDACTED] any weapons I would like to confess that on or about 18 MAY 03 [REDACTED] had commented on how much he liked the Beretta 9mm that I confiscated and used for patrols. He had helped the platoon so much with raids and weapon cashes that I told him to take it. I did not give it for any money, goods, or services. I gave it to him because we were told to get rid of all pistols and guns. Later I regretted my decision and never got the opportunity to get it back.

Q: Did you think [REDACTED] was part of any terrorist group?

A: No.

Q: What did you think he was going to do with the pistol?

A: I thought it would be used for self protection.

10. EXHIBIT 17	11. INITIALS OF PERSON MAKING STATEMENT [REDACTED]	PAGE 1 OF 3 PAGES
-------------------	---	-------------------

ADDITIONAL PAGES MUST CONTAIN THE HEADING "STATEMENT OF [REDACTED] TAKEN AT [REDACTED] DATED [REDACTED]"
 THE BOTTOM OF EACH ADDITIONAL PAGE MUST BEAR THE INITIALS OF THE PERSON MAKING THE STATEMENT, AND PAGE NUMBER MUST BE INDICATED

USE THIS PAGE IF NEEDED. IF THIS PAGE IS NOT NEEDED, PLEASE PROCEED TO FINAL PAGE OF THIS FORM.

STATEMENT OF b7c.5, b6.5 [REDACTED] TAKEN AT Baghdad, Iraq DATED 21 May 03

9. STATEMENT (Continued)

Q: Did you know that giving b7c.5, b6.5 that weapon was a violation of the law (UCMJ)?

A: Yes.

Q: Do you have anything else to add to this statement?

A: No // End of Statement //

DODDOACID-005316

INITIALS OF PERSON MAKING STATEMENT b7c.5, b6.5 [REDACTED] PAGE 2 OF 3 PAGES

b7c-5, b6-5

STATEMENT OF [REDACTED] TAKEN AT Baghdad DATED 21 May 03

8- STATEMENT (Continued)

NOT USED

DODDOACID-005317

b7c-5, b6-5

AFFIDAVIT

I, [REDACTED], HAVE READ OR HAVE HAD READ TO ME THIS STATEMENT WHICH BEGINS ON PAGE 1, AND ENDS ON PAGE 3. I FULLY UNDERSTAND THE CONTENTS OF THE ENTIRE STATEMENT MADE BY ME. THE STATEMENT IS TRUE. I HAVE INITIALED ALL CORRECTIONS AND HAVE INITIALED THE BOTTOM OF EACH PAGE CONTAINING THE STATEMENT. I HAVE MADE THIS STATEMENT FREELY WITHOUT HOPE OF BENEFIT OR REWARD, WITHOUT THREAT OF PUNISHMENT, AND WITHOUT COERCION, UNLAWFUL INFLUENCE, OR UNLAWFUL INDUCEMENT.

[REDACTED] b7c-5, b6-5
(Signature of Person Making Statement)

WITNESSES:

Subscribed and sworn to before me, a person authorized by law to administer oaths, this 21st day of May, 2003 at Baghdad, Iraq

[REDACTED] b7c-1, b6-1
(Signature of Person Administering Oath)

ORGANIZATION OR ADDRESS

SA [REDACTED]
(Typed Name of Person Administering Oath)
Article 136 UCMJ
(Authority To Administer Oaths)

ORGANIZATION OR ADDRESS

INITIALS OF PERSON MAKING STATEMENT

b7c-5, b6-5
[REDACTED]

PAGE 3 OF 3 PAGES

RIGHTS WARNING PROCEDURE/WAIVER CERTIFICATE

For use of this form, see AR 190-30; the proponent agency is ODCSOPS

DATA REQUIRED BY THE PRIVACY ACT

AUTHORITY: Title 10, United States Code, Section 3012(g)
PRINCIPAL PURPOSE: To provide commanders and law enforcement officials with means by which information may be accurately identified.
ROUTINE USES: Your Social Security Number is used as an additional/alternate means of identification to facilitate filing and retrieval.
DISCLOSURE: Disclosure of your Social Security Number is voluntary.

1. LOCATION AO POWERS	2. DATE 24 May 03	3. TIME 10:25	4. FILE NO. 0055-03-CIV-AM
5. NAME (Last, First, MI) [REDACTED]	8. ORGANIZATION OR ADDRESS HHC, 3/69 Armor, 1st BCT, 3ID		
6. SSN [REDACTED]	7. GRADE/STATUS E-3/AD	FSGA	

PART I - RIGHTS WAIVER/NON-WAIVER CERTIFICATE

Section A. Rights

The investigator whose name appears below told me that he/she is with the United States Army Criminal Investigation Division and wanted to question me about the following offense(s) of which I am suspected/accused: Aiding the Enemy, Dealing, Selling, Trading Captured Property, Endangering Self
 Before he/she asked me any questions about the offense(s), however, he/she made it clear to me that I have the following rights: of Command, violation of GO #1
 I do not have to answer any question or say anything.
 Anything I say or do can be used as evidence against me in a criminal trial.
 For personnel subject of the UCMJ I have the right to talk privately to a lawyer before, during, and after questioning and to have a lawyer present with me during questioning. This lawyer can be a civilian lawyer I arrange for at no expense to the Government or a military lawyer detailed for me at no expense to me, or both.
 For civilians not subject to the UCMJ I have the right to talk privately to a lawyer before, during, and after questioning and to have a lawyer present with me during questioning. I understand that this lawyer can be one that I arrange for at my own expense, or if I cannot afford a lawyer and want one, a lawyer will be appointed for me before any questioning begins.
 If I am now willing to discuss the offense(s) under investigation, with or without a lawyer present, I have a right to stop answering questions at any time, or speak privately with a lawyer before answering further, even if I sign the waiver below.

5. COMMENTS (Continue on reverse side)
Have you requested a lawyer after being read your rights within the last 30 days? NO

Section B. Waiver

I understand my rights as stated above. I am now willing to discuss the offense(s) under investigation and make a statement without talking to a lawyer first and without having a lawyer present with me.

WITNESSES (If available)		3. SIGNATURE OF INTERVIEWEE [REDACTED]
1a. NAME (Type or Print)		4. SIGNATURE OF INTERVIEWER [REDACTED]
b. ORGANIZATION OR ADDRESS AND PHONE		67C-1, 66-1
2a. NAME (Type or Print)		5. TYPED NAME OF INVESTIGATOR SA [REDACTED]
b. ORGANIZATION OR ADDRESS AND PHONE		6. ORGANIZATION OF INVESTIGATOR 30th MP Det (CID), FSGA

Section C. Non-waiver

1. I do not want to give up my rights
 I want a lawyer I do not want to be questioned or say anything

2. SIGNATURE OF INTERVIEWEE _____

DODDOACID-005318

ATTACH THIS WAIVER CERTIFICATE TO ANY SWORN STATEMENT (DA FORM 2823) SUBSEQUENTLY EXECUTED BY THE SUSPECT/ACCUSED

FOW

e-mail

SWORN STATEMENT

For use of this form, see AR 190-45; the proponent agency is DDCSOPS

PRIVACY ACT STATEMENT

AUTHORITY: Title 10 USC Section 301; Title 5 USC Section 2951; E.O. 9397 dated November 22, 1943 /SSM/
PRINCIPAL PURPOSE: To provide commanders and law enforcement officials with means by which information may be accurately identified.
ROUTINE USES: Your social security number is used as an additional/alternate means of identification to facilitate filing and retrieval.
DISCLOSURE: Disclosure of your social security number is voluntary.

1. LOCATION: HQ Power Banded Iraq
2. DATE (YYYYMMDD): 030524
3. TIME: 11:50
4. FILE NUMBER: 0055-03-CID749
5. LAST NAME, FIRST NAME, MIDDLE NAME: [redacted]
6. SSN: [redacted]
7. GRADE/STATUS: E-3

8. ORGANIZATION OR ADDRESS: HHC 3/69 AR DODDOACID-005319

9. [redacted] WANT TO MAKE THE FOLLOWING STATEMENT UNDER OATH:

I have witnessed a mouser being given to "The [redacted]"; while ordered Pfc [redacted] pulled the rifle out of the back of the Humvee and gave it to him.

Another time I was in my room with CPL [redacted], Sgt [redacted] and a few others when we heard gun shots right outside our window. We all ran to the roof and saw Sfc [redacted] there. It was obvious to us that he had been shooting rounds off of the roof.

Pfc [redacted] confiscated a Sig Sauer P220 from an Iraqi. After he turned it in and we all turned in pistols "The [redacted] came in my room with 3 pistols in his belt."

10. EXHIBIT: [redacted] 11. INITIALS OF PERSON MAKING STATEMENT: [redacted] PAGE 1 OF 5 PAGES

ADDITIONAL PAGES MUST CONTAIN THE HEADING 'STATEMENT OF [redacted] TAKEN AT HQ Power DATED 24 May 03
THE BOTTOM OF EACH ADDITIONAL PAGE MUST BEAR THE INITIALS OF THE PERSON MAKING THE STATEMENT, AND PAGE NUMBER MUST BE INDICATED

USE THIS PAGE IF NEEDED. IF THIS PAGE IS NOT NEEDED, PLEASE PROCEED TO FINAL PAGE OF THIS FORM.

STATEMENT OF [REDACTED] TAKEN AT AO Power DATED 24 May 03

9. STATEMENT (Continued)

one of them being the sig saw, he actually handed it to me and definitely was the same pistol.

Towards the beginning of our stay at the hospital compound, "The [REDACTED] came into my room with a pistol. At this time he offered a trade for a Browning that I had confiscated the night before. I thought that he was our new interpreter and had been checked out so I traded. The pistol that he gave me was turned in shortly after.

Q: [REDACTED]

A: [REDACTED]

Q: Who is [REDACTED]?

A: I think his name is [REDACTED]. We were told that he was an Iraqi [REDACTED] during the first war [REDACTED] with Iraq. That's why we called him that.

Q: Where were you when the Mauser was given to the [REDACTED]?

A: I was in HQ 57 (the back of it). When [REDACTED] got out of it because we were at his house, I got out of HQ 57 and got in HQ 56 where he had previously been sitting.

INITIALS OF PERSON MAKING STATEMENT

[REDACTED]

PAGE 2 OF 5 PAGES

USE THIS PAGE IF NEEDED. IF THIS PAGE IS NOT NEEDED, PLEASE PROCEED TO FINAL PAGE OF THIS FORM.

STATEMENT OF [redacted] b7c-5, b6-5 TAKEN AT AO Power DATED 24 May 03

9. STATEMENT (Continued)

Q: How many times have you been to [redacted] residence?

A: Two, once on the night he [redacted] was given the Mauser and on another occasion when we picked him up in the morning.

Q: On the morning you picked him up did he have any weapons or other bags with him that you can remember?

A: He had no bags and I'm not sure if he had weapons. We were told that [redacted] was okay and that we didn't need to search him.

Q: On the trips to [redacted] residence, who was in charge of the escorts?

A: Dropping him off with the Mauser was SET [redacted] b7c-5, b6-5 but when we picked him up, I'm not sure. We might have been told to go pick him up when we were out on patrol.

Q: Who ordered PFC [redacted] b7c-4, b6-4 to give [redacted] b7c-4, b6-4 the Mauser?

A: I don't know, PFC [redacted] b7c-4, b6-4 told me he was ordered to do so.

DODDOACID-005321

Q: Was the Mauser a confiscated weapon?

A: I don't know where it came from. The first time I saw it was when we were back at base. I saw it on the roof while I was on guard at OP1.

Q: When you observed [redacted] b7c-5, b6-5 coming down from the roof, did you see him with a weapon?

A: Not in his hands. He asked us what we were doing. We told him we heard gunshots and he started making fun of us. He said, "ewiw", "did you catch them," and "did you find anybody."

Q: Was this the only time that happened?

A: That I witnessed. Yes.

Q: Concerning the pistol [redacted] b7c-4, b6-4 confiscated, how do you know the [redacted] had the pistol [redacted] had previously confiscated?

INITIALS OF PERSON MAKING STATEMENT

PAGE 3 OF 5 PAGES

USE THIS PAGE IF NEEDED. IF THIS PAGE IS NOT NEEDED, PLEASE PROCEED TO FINAL PAGE OF THIS FORM.

STATEMENT OF [REDACTED] b7c-5,665 TAKEN AT AO Power DATED 24 May 08

9. STATEMENT (Continued)

A: Because he had three pistols that looked the same that we turned in.

Q: Did the [REDACTED] b7c-4,664 say where or from whom he got the pistols from?

A: No, because he was only there for a minute. Then SFC [REDACTED] b7c-5,665 came in and gave us a security briefing with [REDACTED] b7c-4,664 present.

Q: In regards to the weapon you traded with the [REDACTED] b7c-4,664, was this the only time you traded with him?

A: Yes

Q: Why did you trade with him?

A: Because I thought he was a good guy. I thought he was going to be our interpreter. I know interpreters are able to carry weapons for their safety. He seemed to like the pistol I had better.

Q: Were you ever told not to trade weapons?

A: No.

Q: Did you ever see anyone ever trade weapons to the [REDACTED] b7c-4,664 for any other items?

A: I never saw. But I know it was happening behind closed doors in CP7 [REDACTED] b7c-5,665, SFC [REDACTED] b7c-5,665 and SGT [REDACTED] b7c-5,665 room.

Q: Morally speaking, did you know what you did was wrong?
A: Yes, I didn't feel as bad because at least I wasn't trading for money.

Q: Who was trading the money?

A: I heard SFC [REDACTED] b7c-5,665, SGT [REDACTED] b7c-5,665 and CP7 [REDACTED] b7c-5,665 were.

Q: Did you ever drink any alcohol?

A: Yes, a couple shots, while on the streets

INITIALS OF PERSON MAKING STATEMENT

[REDACTED] b7c-5,665

PAGE 4 OF 5 PAGES

STATEMENT OF

TAKEN AT

AO Power

DATED

24 May 03 5363

B- STATEMENT (Continued)

Q: Did you ever see anyone else drinking alcohol?

A: No.

Q: Did you ever trade weapons for ^{b7c-5,66-5} money?

A: No.

Q: Do you have any information concerning the theft or robbery of money?

A: I never saw anything, others have and they told me about it. SET ^{b7c-5,66-5} made some comments. While ~~at~~ we raided a house, we took a big wad of cash that the gunman had left there before he fled the area. We took his money (actually SET ^{b7c-5,66-5} did) in order for him to exchange his weapon for the money, I saw it was a large stack of money. When the man returned hours later for his money, SFC ^{b7c-5,66-5} gave it back to him, it appeared as if half of it was taken.

Q: Do you have anything else you wish to add to your statement?
A: No. (// End of Statement //)

DODDOACID-005323

AFFIDAVIT

I, ^{b7c-5,66-5} [redacted], HAVE READ OR HAVE HAD READ TO ME THIS STATEMENT WHICH BEGINS ON PAGE 1, AND ENDS ON PAGE 5. I FULLY UNDERSTAND THE CONTENTS OF THE ENTIRE STATEMENT MADE BY ME. THE STATEMENT IS TRUE. I HAVE INITIALED ALL CORRECTIONS AND HAVE INITIALED THE BOTTOM OF EACH PAGE CONTAINING THE STATEMENT. I HAVE MADE THIS STATEMENT FREELY WITHOUT HOPE OF BENEFIT OR REWARD, WITHOUT THREAT OF PUNISHMENT, AND WITHOUT COERCION, UNLAWFUL INFLUENCE, OR UNLAWFUL INDUCEMENT.

^{b7c-5,66-5} [redacted signature]
(Signature of Person Making Statement)

WITNESSES:

Subscribed and sworn to before me, a person authorized by law to administer oaths, this 24th day of May 2003 at AO Power, Tashdad, Iraq

^{b7c-1,66-1} [redacted signature]
(Signature of Person Administering Oath)

^{b7c-1,66-1} [redacted name]
(Typed Name of Person Administering Oath)
30th MP Det (CZD), FSEA
(Authority To Administer Oaths)

ORGANIZATION OR ADDRESS

ORGANIZATION OR ADDRESS

INITIALS OF PERSON MAKING STATEMENT

^{b7c-5,66-5} [redacted initials]

PAGE 5 OF 5 PAGES

SWORN STATEMENT

For use of this form, see AR 190-45, the proponent agency is ODCSOPS

PRIVACY ACT STATEMENT

AUTHORITY: Title 10 USC Section 301 Title 5 USC Section 2951; E.O. 9397 dated November 22, 1943 (SSN).
PRINCIPAL PURPOSE: To provide commanders and law enforcement officials with means by which information may be accurately identified.
ROUTINE USES: Your social security number is used as an additional/alternate means of identification to facilitate filing and retrieval.
DISCLOSURE: Disclosure of your social security number is voluntary.

1. LOCATION AO Power, Baghdad Iraq	2. DATE (YYYYMMDD) 20030524	3. TIME 1100	4. FILE NUMBER 0355-03-CID349
5. LAST NAME, FIRST NAME, MIDDLE NAME [REDACTED]	6. SSN [REDACTED]	7. GRADE/STATUS O3	

8. ORGANIZATION OR ADDRESS
A Co/3-69 AR BN
DODDOACID-005324

9. [REDACTED] WANT TO MAKE THE FOLLOWING STATEMENT UNDER OATH:

On or about 18 2330 MAY 03, LTC [REDACTED], the battalion commander for Task Force 3-69 AR, ordered me, as the Alpha company commander, to conduct an inventory of the two rooms belonging to CPT [REDACTED] the mortar platoon platoon leader, SFC [REDACTED] the mortar platoon platoon sergeant, and SGT [REDACTED], a soldier of the mortar platoon. These weapons in return for trading/selling confiscated gold watches/jewelry/trinkets. I was ordered to conduct a search of the rooms and inventory anything that may be contraband or evidence. I ordered SGT [REDACTED] to assist me in the search, and told him to bring along one other soldier and three flashlights, since the power in the building was out. I do not remember the name or rank of the soldier SGT [REDACTED] chose. I conducted the inventory in the following manner: SGT [REDACTED] and the soldier would dump, layout, and search through all items/bags/drawers and lockers in the two rooms, working in a counter-clockwise rotation around the room, while I watched them. A.S. [REDACTED]

10. EXHIBIT	11. INITIALS OF PERSON MAKING STATEMENT [REDACTED]	PAGE 1 OF 3 PAGES
-------------	---	-------------------

ADDITIONAL PAGES MUST CONTAIN THE HEADING: STATEMENT OF [REDACTED] TAKEN AT [REDACTED] DATED [REDACTED]

THE BOTTOM OF EACH ADDITIONAL PAGE MUST BEAR THE INITIALS OF THE PERSON MAKING THE STATEMENT, AND PAGE NUMBER MUST BE INDICATED

USE THIS PAGE IF NEEDED. IF THIS PAGE IS NOT NEEDED, PLEASE PROCEED TO FINAL PAGE OF THIS FORM.

STATEMENT OF ^{b7c-4, b6-4} [REDACTED] TAKEN AT ^{11005 b7c-4, b6-4} [REDACTED] DATED 20030524

9. STATEMENT (Continued)

contraband or possible evidence was found, I would inventory and log it. I personally searched the desk in the room. In the course of the search, one wooden locker had to be broken into, and two duffle bags that were locked, cut open. We looked behind and under all furniture. During the course of the search, we did not tear open any furniture or punch holes in the floor, roof, or walls to look for contraband, feeling that the slim chance of any being hidden in these locations, did not warrant the destruction of the building. Numerous items of possible contraband/evidence were discovered, primarily in the locker, ranging from pistols, to excessive dinars, to Alcohol. The complete list of seized items, as well as the items were turned into the battalion executive officer, MAJ ^{b7c-3, b6-3} [REDACTED], early in the morning of 19 MAY 03, at the completion of the search.

Q: ^{b7c-4, b6-4} [REDACTED]?

A: ^{b7c-4, b6-4} [REDACTED]

Q: Do you have anything else you wish to add to your statement?

A: No, /// END OF STATEMENT ///

^{b7c-4, b6-4} [REDACTED]

^{b7c-4, b6-4} [REDACTED]

INITIALS ON MAKING STATEMENT

PAGE 2 OF 23 PAGES

FOUO

EXHIBIT D

67C-4,166-4

0055-03-CID349-5

STATEMENT OF

[Redacted]

TAKEN AT

AD Power

DATED

24 May 03

B- STATEMENT (Continued)

[Large Xed-out area]

DODDOACID-005326

67C-4,166-4

[Redacted]

AFFIDAVIT

I, [Redacted], HAVE READ OR HAVE HAD READ TO ME THIS STATEMENT WHICH BEGINS ON PAGE 1, AND ENDS ON PAGE 3. I FULLY UNDERSTAND THE CONTENTS OF THE ENTIRE STATEMENT MADE BY ME. THE STATEMENT IS TRUE. I HAVE INITIALED ALL CORRECTIONS AND HAVE INITIALED THE BOTTOM OF EACH PAGE CONTAINING THE STATEMENT. I HAVE MADE THIS STATEMENT FREELY WITHOUT HOPE OF BENEFIT OR REWARD, WITHOUT THREAT OF PUNISHMENT, AND WITHOUT COERCION, UNLAWFUL INFLUENCE OR UNLAWFUL INDUCEMENT.

[Signature of Person Making Statement]

WITNESSES:

Subscribed and sworn to before me, a person authorized by law to administer oaths, this 24th day of May, 2003 at AD Power, Baghdad, Iraq

ORGANIZATION OR ADDRESS

[Redacted Signature of Person Administering Oath]

ORGANIZATION OR ADDRESS

SA [Redacted] 30th MP Det (CID), FJGA

INITIALS OF PERSON MAKING STATEMENT

PAGE 3 OF 3 PAGES

SWORN STATEMENT

For use of this form, see AR 190-45; the proponent agency is ODCSOPS

PRIVACY ACT STATEMENT

AUTHORITY: Title 10 USC Section 301; Title 5 USC Section 2951; E.O. 9397 dated November 22, 1943 (SSN).
PRINCIPAL PURPOSE: To provide commanders and law enforcement officials with means by which information may be accurately identified.
ROUTINE USES: Your social security number is used as an additional/alternate means of identification to facilitate filing and retrieval.
DISCLOSURE: Disclosure of your social security number is voluntary.

1. LOCATION Baghdad, Iraq	2. DATE (YYYYMMDD) 2003 05 24	3. TIME 1115 1110	4. FILE NUMBER 0055-03-CID349
5. LAST NAME, FIRST NAME, MIDDLE NAME [REDACTED]	6. SSN [REDACTED]	7. GRADE/STATUS CPT - AD	
8. ORGANIZATION OR ADDRESS HHC 3-69 AR [REDACTED]			DODDOACID-005327
9. I, CPT [REDACTED], WANT TO MAKE THE FOLLOWING STATEMENT UNDER OATH:			

This statement contains the my knowledge concerning the actions of the 3-69 AR Mortar Platoon. On 09 May, I took command of HHC. I completed initial interviews with all my platoon sergeants and platoon leaders within several days. During these interviews I didn't receive any information from CPT [REDACTED] or SFC [REDACTED] about their alleged actions. On 18 May, LTC [REDACTED] briefed all commanders on the US Army policy on captured weapons and money. The company commanders were then instructed to brief their companies on this policy. At 1300 on 18 May, I held my HHC leaders meeting at the Ministry of Oil. At this meeting, I briefed all Platoon leaders / Platoon Sergeants - to include CPT [REDACTED] and SFC [REDACTED] on this policy. The next day - 19 May - I was briefed by LTC [REDACTED] on CPT [REDACTED] and SFC [REDACTED] suspension, and preliminary details of the case. Nothing follows [REDACTED].

10. EXHIBIT [REDACTED]	11. INITIALS OF PERSON MAKING STATEMENT [REDACTED]	PAGE 1 OF 2 PAGES
ADDITIONAL PAGES MUST CONTAIN THE HEADING 'STATEMENT OF [REDACTED] TAKEN AT [REDACTED] DATED 24 May 03		
THE BOTTOM OF EACH ADDITIONAL PAGE MUST BEAR THE INITIALS OF THE PERSON MAKING THE STATEMENT, AND PAGE NUMBER MUST BE INDICATED: -1-		

b7c-4, b6-4

0055-03-C2D347-596

STATEMENT OF [REDACTED] TAKEN AT AO Power DATED 24 May 03

B. STATEMENT (Continued)

[The main body of the statement is crossed out with a large 'X' and contains several redaction codes and blacked-out areas.]

b7c-4, b6-4 [REDACTED]

b7c-4, b6-4 [REDACTED]

b7c-4, b6-4 [REDACTED]

b7c-4, b6-4 [REDACTED]

b7c-4, b6-4 [REDACTED]

b7c-4, b6-4 [REDACTED]

DODDOACID-005328

CPT [REDACTED]

AFFIDAVIT

WHICH BEGINS ON PAGE 1, AND ENDS ON PAGE [REDACTED], HAVE READ OR HAVE HAD READ TO ME THIS STATEMENT FULLY UNDERSTAND THE CONTENTS OF THE ENTIRE STATEMENT MADE BY ME. THE STATEMENT IS TRUE. I HAVE INITIALED ALL CORRECTIONS AND HAVE INITIALED THE BOTTOM OF EACH PAGE CONTAINING THE STATEMENT. I HAVE MADE THIS STATEMENT FREELY WITHOUT HOPE OF BENEFIT OR REWARD, WITHOUT THREAT OF PUNISHMENT, AND WITHOUT COERCION, UNLAWFUL INFLUENCE, OR UNLAWFUL INDUCEMENT.

[REDACTED] b7c-4, b6-4
(Signature of Person Making Statement)

WITNESSES:

Subscribed and sworn to before me, a person authorized by law to administer oaths, this 24th day of May, 2003 at AO Power, Bay Liberty, Iraq

ORGANIZATION OR ADDRESS

[REDACTED] b7c-1, b6-1
(Administering Oath)

ORGANIZATION OR ADDRESS

SA [REDACTED] b7c-1, b6-1
30th MP Det (CID), FSEA
(Authority To Administer Oaths)

INITIALS OF PERSON MAKING STATEMENT

PAGE 7 OF 2 PAGES

SWORN STATEMENT

For use of this form, see AR 190-45; the proponent agency is ODCSOPS

PRIVACY ACT STATEMENT

AUTHORITY: Title 10 USC Section 301 Title 5 USC Section 2951, E.O. 9397 dated November 22, 1943 /SSA/
PRINCIPAL PURPOSE: To provide commanders and law enforcement officials with means by which information may be accurately identified.
ROUTINE USES: Your social security number is used as an additional/alternate means of identification to facilitate filing and retrieval.
DISCLOSURE: Disclosure of your social security number is voluntary.

1. LOCATION: AO Power Baghdad Iraq
2. DATE: 2003 05 24
3. TIME: 1407
4. FILE NUMBER: 0055-03-CTD349
5. LAST NAME, FIRST NAME, MIDDLE NAME: [redacted]
6. SSN: [redacted]
7. GRADE/STATUS: E-3
8. ORGANIZATION OR ADDRESS: HHC 3/69 AR
DODDOACID-005329

I, [redacted], WANT TO MAKE THE FOLLOWING STATEMENT UNDER OATH:

On or around the 18 of May, 2003, I turned in a confiscated Sig Sauer P220 pistol. I placed it in an MRE Box with about 15-20 more pistols. That same morning I was with the patrol that went to turn in our cache of confiscated weapons. Enroute I was in the back of the humvee with the weapons and looked into the box of pistols. About half were missing including the pistol I placed in the box. When I cleared the pistol to place it in the box Cpt. [redacted] was watching what I was doing. The last I saw he had the box in his possession. At one time I walked into Cpt [redacted] Sgts [redacted] room and saw SFC [redacted] and their friend sitting around there table. SFC [redacted] had their hands and hid it when I walked it. One day SFC [redacted] and Sgt [redacted] were walking up to the roof with there weapons and passed me by. SFC [redacted] said that if we heard shots firing to not worry about it. I went inside and did not hear any firing. At one time Sgt [redacted] returned from a patrol and appeared to be drunk.

Q: [redacted]
A: [redacted]
Q: Did you ever witness anyone trade, buy or sell weapons to the "Guy"?
A: No.
Q: Did you ever witness anyone consume any alcohol?

J. EXHIBIT: 2
11. INITIALS OF PERSON MAKING STATEMENT: [redacted]
PAGE 1 OF 2 PAGES
TAKEN AT AO Power DATED 24 May 03

STATEMENT OF

TAKEN AT

AO Power

DATED

24 May 2003

B: STATEMENT (Continued)

A: No.

Q: Did you ever witness the [redacted] having weapons that appeared to have previously been confiscated?

A: No.

Q: Have you ever been to the [redacted] house?

A: I think so. Me and a couple of the other guys walked the [redacted] home. It was after curfew.

Q: Did you ever witness anyone steal money from Iraqi citizens?

A: No.

Q: Do you have anything else you wish to add to this statement?

A: No. /// END OF STATEMENT ///

DODDOACID-005330

AFFIDAVIT

I, [redacted], HAVE READ OR HAVE HAD READ TO ME THIS STATEMENT WHICH BEGINS ON PAGE 1, AND ENDS ON PAGE 2. I FULLY UNDERSTAND THE CONTENTS OF THE ENTIRE STATEMENT MADE BY ME. THE STATEMENT IS TRUE. I HAVE INITIALED ALL CORRECTIONS AND HAVE INITIALED THE BOTTOM OF EACH PAGE CONTAINING THE STATEMENT. I HAVE MADE THIS STATEMENT FREELY WITHOUT HOPE OF BENEFIT OR REWARD, WITHOUT THREAT OF PUNISHMENT, AND WITHOUT COERCION, UNLAWFUL INFLUENCE, OR UNLAWFUL INDUCEMENT.

[redacted] (Signature of Person Making Statement)

WITNESSES:

Subscribed and sworn to before me, a person authorized by law to administer oaths, this 24th day of May, 2003 at AO Power, Baghdad, Iraq

ORGANIZATION OR ADDRESS

[redacted] (Signature of Person Administering Oath)

ORGANIZATION OR ADDRESS

SA [redacted] 30th MP Det. (CID), FSGA (Authority To Administer Oaths)

INITIALS OF PERSON MAKING STATEMENT

[redacted] b7c-4, b6-4

PAGE 2 OF 2 PAGES

F O U O

12
EXHIBIT A1

AGENT'S INVESTIGATIVE REPORT

CID Regulation 195-1

ROI NUMBER

0055-03-CID349-59657

PAGE 1 OF 3 PAGES

DETAILS

CRIME SCENE EXAMINATION: Between 1650 - 1800, 20 May 03, SA ~~67C-1, 166-1~~ conducted an examination of the crime scene, which was verified to be the most northeastern rooms of the second floor located at the Al Wassti Hospital, Baghdad, Iraq.

Characteristics of the Scene: There were three adjoining rooms, two that were being utilized as sleeping quarters for three soldiers and the other adjoining room was a small room used for storage. The rooms were located in an abandoned two-story building formerly known as the Al Wassti Hospital. The main room was the sleeping area for two soldiers. The room's main entrance/exit (E/E) was in the west wall situated in the southwest corner of the room. There was a small window in the east wall. The window was several meters from the southeast corner of the room and had a pink curtain. The northern wall of the room contained numerous windows. The windows extended the entire length of the wall and also had pink curtains. There was another E/E in the west wall that was situated in the northwest corner of the room. The door provided access to the smaller room, which was being utilized as a sleeping area for one soldier. There was a window located in the north wall of the smaller room. The window was positioned in the northwest corner of the room and had a pink curtain. There was an E/E located in the west wall that was situated in the northwest corner of the room. The door provided access to the closet, which was being utilized as storage. The room was rectangular shaped and very small.

Condition of the Scene: The overall appearances of the rooms were dirty and appeared to be disorganized.

The main room was very large and appeared to have been some type of office prior to its abandonment. There was a wooden cabinet in the southwest corner of the room. The cabinet's back was flush against the south wall and was facing north. Its double doors swung outwards and appeared to have been forced open. There was miscellaneous personal items located in the cabinet. A few meters east of the cabinet, there was a military rucksack. The rucksack contained personal items and military equipment. East of the rucksack was a chair. The chair was positioned with its back to the wall facing north. East of the chair was a cot. The cot was positioned in the southeast corner of the room. The cot was situated

TYPE AGENT'S NAME AND SEQUENCE NUMBER SA 67C-1, 166-1, 62		ORGANIZATION 30 th MP Det (CID), 3rd MP GRP (CID), Fort Stewart, GA, 31314	
SIGNATURE [Redacted]		DATE 20 May 03	EXHIBIT

CID FORM

FEB 77

FOR OFFICIAL USE ONLY

108

AGENT'S INVESTIGATIVE REPORT

CID Regulation 195-1

ROI NUMBER

0055-03-CID349-59657

PAGE 2 OF 3 PAGES

DETAILS

lengthwise and flush against the south wall. The side of the cot was also flush against the east wall. Several meters north, there was a cot situated lengthwise and flush against the east wall. The cot was in the approximate center of the east wall. There was a small makeshift type table parallel to the cot. Like the cot, the table was situated lengthwise from north to south. South of the cot and table was a couch. The couch was positioned a few meters west of the east wall. The couch was situated lengthwise from east to west. There was a chair south of the couch. The chair was directly behind the couch and facing south. There was another chair several meters southwest of the chair located directly behind the couch. This chair was facing south. There was a large couch positioned flush against the west wall of the room. The couch was facing east in located in the approximate center of the west wall. There was a large, plastic, circular table situated about one meter northeast of the couch. There was a rucksack positioned in the northwest corner of the room. East of the rucksack was two duffel bags. All three were flush against the north wall and contained some personal items and military equipment. East of the duffel bags was a large desk. The desk was several meters south of the north wall and positioned parallel to the north wall. There was a black office type chair behind the desk between the north wall and the desk. The chair was facing to the north, away from the desk. There was a large sofa type chair, which matches the aforementioned couches, situated with its back against the east wall. The chair was facing west and was a few meters south of the northeast corner of the room. Several meters south of the sofa chair was three more chairs. One of the chairs was about one meter from the east wall and was facing south toward the makeshift table. Another chair was positioned a few meters west of the chair facing the makeshift table and was facing west. The last chair in the room was a few meters south of the last chair mentioned and positioned to face the northwest corner of the room.

The smaller adjoining room to the main room was being utilized as a sleeping area for one soldier. The E/E of the small room was placed in the west wall of the main room, located several meters south of the northwest corner of the main room. There was a cot situated in the northeast corner of the room and flush against the east wall. There were three water boxes located in the southeast corner of the room. They were placed side by side, extending in a western direction from the southeast

TYPED AGENT'S NAME AND SEQUENCE NUMBER SA [REDACTED] 67C-1, 66-1, 62		ORGANIZATION 30 th MP Det (CID), 3rd MP GRP (CID), Fort Stewart, GA, 31314	
SIGNATURE [REDACTED]		DATE 20 May 03.	EXHIBIT

CID 94

FOR OFFICIAL USE ONLY

-174

AGENT'S INVESTIGATIVE REPORT

CID Regulation 195-1

ROI NUMBER

0055-03-CID349-59657

PAGE 3 OF 3 PAGES

DETAILS

corner. The contents of the boxes were trash and some personal items. There was a small fan sitting on the floor slightly northwest of the most western water box. There was a black backpack type bag sitting on the floor, flush against the south wall of the room. The front of the black bag was facing north and positioned in the approximate center of the south wall. There was a water box sitting on the floor in the approximate center of the north wall of the room. The water box contained personal items. There was a clear, plastic trash bag sitting on the floor to the east of the water box. A few feet southeast of the water box was a waterproof bag. The waterproof bag contained clothing. A few feet northeast of the waterproof bag was a small wooden shelf. The shelf was positioned perpendicular to the cot.

The storage closet adjoining the smaller room was being utilized as a storage space. The E/E of the storage closet was placed in the west wall of the smaller room, located several feet south of the northwest corner of the smaller room. There were numerous bags, boxes, rucksacks and other miscellaneous gear located in the storage closet. All the gear located in the storage closet was laying on the ground and covered the entire floor extending from the northwest corner of the room to the northeast corner of the room. The items laying on the floor divided the room approximately in half. There were no other items located within the room. There was an E/E located in the west wall of the storage closet. This E/E provided access to the bathroom was no utilized as it was not operational.

Factors Pertinent to Entry/Exit: Entry/Exit to the rooms could be gained by way of the door located in the southwest corner of the main room.

Scene Documentation: About 1700, 20 May 03, SA ^{67C-1,66-1} prepared a crime scene sketch of the rooms. Photographs were exposed utilizing a Kodak EasyShare DX 4900 digital camera.

Search for Latent Impressions: A search for latent impressions was not conducted, as all parties involved in this incident are soldiers who reside in the rooms.

Collection of Crime Scene Evidence: No items of evidentiary value were observed.///LAST ENTRY///

TYPE AGENT'S NAME AND SEQUENCE NUMBER

SA

67C-1,66-1,62

ORGANIZATION

30th MP Det (CID), 3rd MP GRP (CID),
Fort Stewart, GA, 31314

SIGNATURE

DATE

20 May 03

EXHIBIT

CID FORM 9
1 FEB 77

FOR OFFICIAL USE ONLY

-126

ROUGH SKETCH OF CRIME SCENE

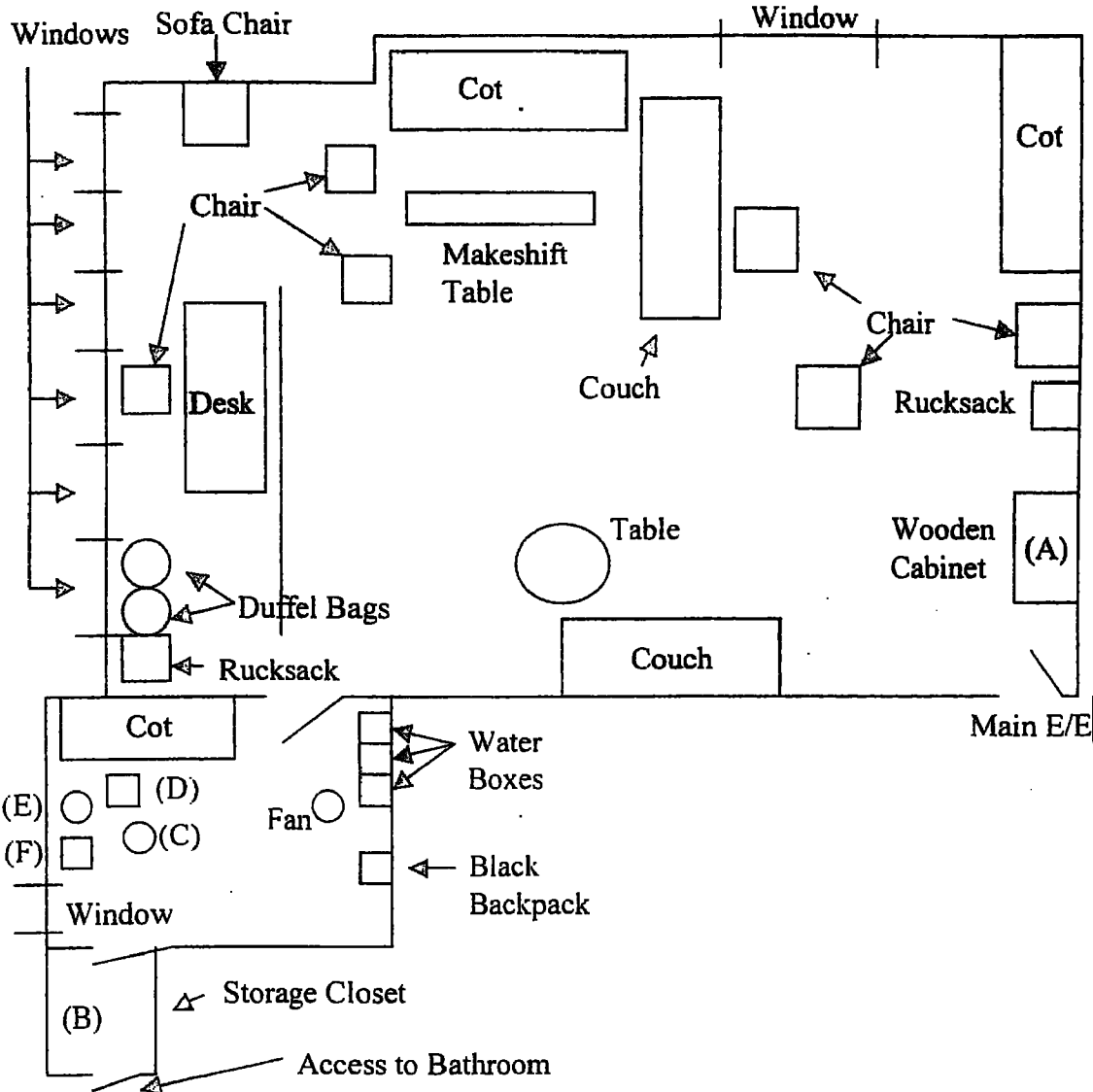

LEGEND

- A - Location of where most contraband was found
- B - Location of personal and military items
- C - Waterproof bag
- D - Shelf
- E - Trash bag full of clothes
- F - Water box

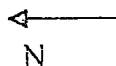

NOT TO SCALE

TITLE BLOCK

0055-03-CID349-59657

OFFENSE: Trading of Illegal Weapons

DEPICTING: Second floor northeastern most rooms

LOCATION: Al Wassti Hospital, Baghdad, Iraq

VICTIM: US Government

SUBJECT: CPT [REDACTED] SFC [REDACTED] and SGT [REDACTED]

SKETCH BEGAN: 1337 / 20 May 03

SKETCHED BY: SA [REDACTED]

VERIFIED BY: SA [REDACTED]

For Official Use Only

Exhibit

33

100

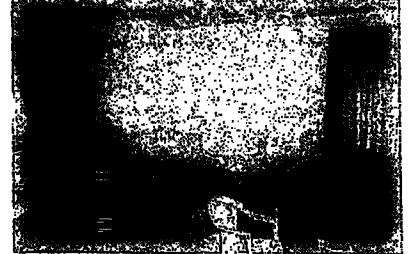
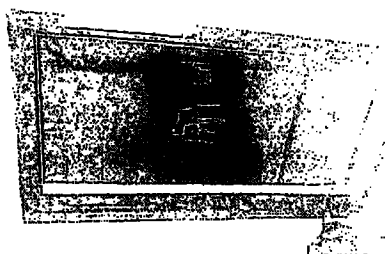
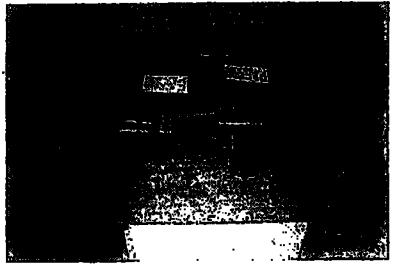
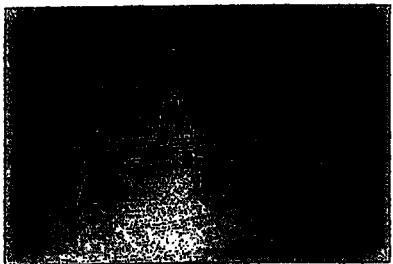

005-000000000000
-9657

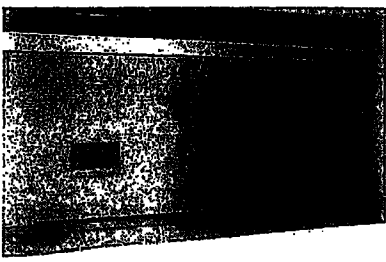
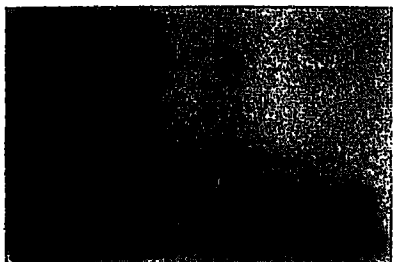
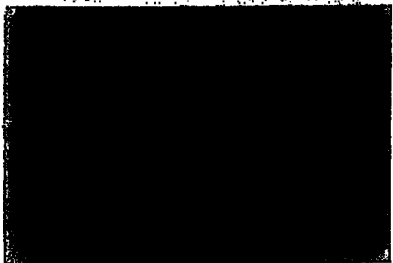
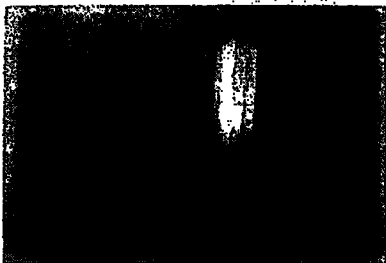
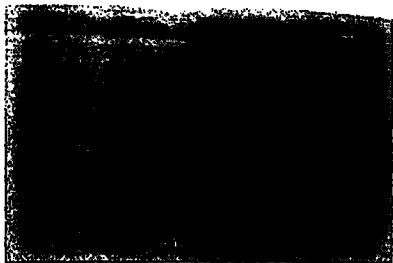
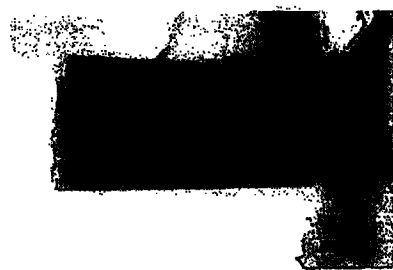
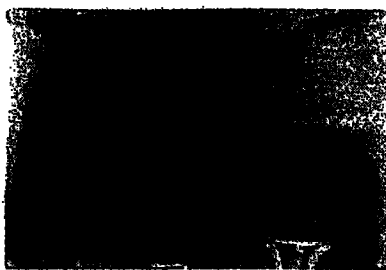

DODDOACID-005336

100

Exhibit 27

0055-03-CID3
596

0055-03-CID349
59657

CS Photos

~~FOUO~~

EX-107 25

DODDOACID-005337

FOUO

EX-107 25

EVIDENCE/PROPERTY CUSTODY DOCUMENT

For use of this form see AR 190-45 and AR 195-5; the proponent agency is US Army Criminal Investigation Command

MPR/CID SEQUENCE NUMBER
0255-03-C10349
CRD REPORT/CID ROI NUMBER
59657

RECEIVING ACTIVITY 30 th MP Det (CID) (FWD)	Baghdad, Iraq
NAME, GRADE AND TITLE OF PERSON FROM WHOM RECEIVED OWNER <input checked="" type="checkbox"/> MAJ [REDACTED]	ADDRESS (Include Zip Code) HHC, 3/69 th Armor Bn (FWD) Baghdad, Iraq
LOCATION FROM WHERE OBTAINED Taken from the hands of the above listed person while at Saddam Hussien's Museum, Baghdad, Iraq	REASON OBTAINED Evidence
	TIME/DATE OBTAINED 1520-1655, 20 May 03

ITEM NO.	QUANTITY	DESCRIPTION OF ARTICLES <i>(Include model, serial number, condition and unusual marks or scratches)</i>
1	1	Box containing approximately 256,600 dinars, three wooden boxes labeled Cohiba La Habana Cigars containing numerous cigars, two silver in color pocket watches, one united tactical knife, one dagger, one jewelry box containing turquoise in color diamond like necklace, one ring, one set of earrings and one gold in color watch; one silver in color watch, one silver in color box containing a cigarette lighter, four silver in color rings, one gold in color pocket knife, one box labeled "Dunhill" containing a gold color cigarette lighter, three gold in color cigarette lighter, two silver in color bowls, two gold in color bowls, one silver in color teapot, one silver in color humidior containing a cigar, one silver in color shot glass, one expresso cup, two porcelain tea cups, one strip of plastic containing various coins in different denominations, two blue in color table cloths, two plastic Ziploc bags containing what appears to be jewelry, one Ziploc bag containing 10 silver in color rings, one Ziploc bag containing three necklaces and heart shape pendant necklace, one silver and blue in color watch, one gold in color knob, one gold in color pine, one purple and gold in color lamp shade, one blue and gr in color gox containing cigarette lighter with red and gold medallion, one pistol serial numberd 31323252, and one pistol, brand name Sig Sauer, P220 serial number G116144. Box sealed and marked for ID with 1520-1655, 20 May 03, [REDACTED] b7c-1,061

CHAIN OF CUSTODY				
ITEM NO.	DATE	RELEASED BY	RECEIVED BY	PURPOSE OF CHANGE OF CUSTODY
1	20 May 03	SIGNATURE [REDACTED]	SIGNATURE [REDACTED]	
		NAME, GRADE OR TITLE [REDACTED] MAJ	NAME, GRADE OR TITLE [REDACTED] SA	
		SIGNATURE	SIGNATURE	
		NAME, GRADE OR TITLE	NAME, GRADE OR TITLE	
		SIGNATURE	SIGNATURE	
		NAME, GRADE OR TITLE	NAME, GRADE OR TITLE	
		SIGNATURE	SIGNATURE	
		NAME, GRADE OR TITLE	NAME, GRADE OR TITLE	
		SIGNATURE	SIGNATURE	
		NAME, GRADE OR TITLE	NAME, GRADE OR TITLE	

DA FORM 4137 1 Jul 76

Replaces DA FORM 4137, 1 Aug 74 and DA FORM 4137-R Privacy Act Statement

LOCATION

DOCUMENT NUMBER 0011-0313

EVIDENCE/PROPERTY CUSTODY DOCUMENT

For use of this form see AR 190-45 and AR 195-5; the proponent agency is US Army Criminal Investigation Command

MPR/CID SEQUENCE NUMBER
0055.03.C10349

CRD REPORT/CID ROI NUMBER
59657

RECEIVING ACTIVITY 30 th MP Det (CID) (FWD)		Baghdad, Iraq	
NAME, GRADE AND TITLE OF PERSON FROM WHOM RECEIVED OWNER <input checked="" type="checkbox"/> MAJ ██████████ 19C-3/66-3		ADDRESS (Include Zip Code) HHC, 3/69 th Armor Bn (FWD) Baghdad, Iraq	
LOCATION FROM WHERE OBTAINED Taken from the hands of the above listed person while at Saddam Hussien's Museum, Baghdad, Iraq		REASON OBTAINED Evidence	TIME/DATE OBTAINED 1700-1725, 20 May 03

ITEM NO.	QUANTITY	DESCRIPTION OF ARTICLES <i>(Include model, serial number, condition and unusual marks or scratches)</i>
1	1	Box containing one brown in color box labeled "Thompson" containing various numerous cigars, one box labeled Romeo & Julieta Churchill containing various numerous cigars, two tin boxes containing various numerous cigars, one wooden box containing miscellaneous cigages, one box labeled Partagasy C 1845 containing numerous cigars, one wooden box labeled Excalibur 1066 containing numerous cigars. Box sealed and marked for ID with 1700, 20 May 03, ██████████ 69C-1,66-1
2	1	Box containing one wooden box labeled "Ambresia" containing various cigars, two wooden boxes labeled "Natural" containing various cigars, one box labeled "Onyx Number 750" containing various cigars, one box labeled Partagasy containing various cigars, one wooden box labeled "Acid" containing various cigars, two black in color daggers, one pocket knife, two black in color ammo magazines containing 9mm ammo rounds, and one gold in color bottle opener. Box sealed and marked for ID with 1712-1725, 20 May 03, ██████████ ////////////////////LAST ITEM////////////////////////////////////██████████ 69C-1,66-1

CHAIN OF CUSTODY				
ITEM NO.	DATE	RELEASED BY	RECEIVED BY	PURPOSE OF CHANGE OF CUSTODY
1 and 2	20 May 03	██████████ 69C-3/66-3	██████████ 69C-1,66-1	
		██████████ MAJ	██████████ SA 69C-1,66-1	
		SIGNATURE	SIGNATURE	
		NAME, GRADE OR TITLE		
		SIGNATURE	SIGNATURE	
		NAME, GRADE OR TITLE	NAME, GRADE OR TITLE	
		SIGNATURE	SIGNATURE	
		NAME, GRADE OR TITLE	NAME, GRADE OR TITLE	
		SIGNATURE	SIGNATURE	DODDOACID-005339
		NAME, GRADE OR TITLE	NAME, GRADE OR TITLE	

-131
5/20/03

EVIDENCE/PROPERTY CUSTODY DOCUMENT

For use of this form see AR 190-45 and AR 195-5; the proponent agency is US Army Criminal Investigation Command

MPR/CID SEQUENCE NUMBER

0055-03-CID349

CRD REPORT/CID ROI NUMBER

59657

RECEIVING ACTIVITY 30 th MP Det (CID) (FWD)	Baghdad, Iraq	
NAME, GRADE AND TITLE OF PERSON FROM WHOM RECEIVED OWNER <input checked="" type="checkbox"/> MAJ ██████████	ADDRESS (Include Zip Code) HHC, 3/69 th Armor Bn (FWD) Baghdad, Iraq	
LOCATION FROM WHERE OBTAINED Taken from the hands of the above listed person while at Saddam Hussien's Museum, Baghdad, Iraq	REASON OBTAINED Evidence	TIME/DATE OBTAINED 1730-1745, 20 May 03

ITEM NO.	QUANTITY	DESCRIPTION OF ARTICLES <i>(Include model, serial number, condition and unusual marks or scratches)</i>
1	1	Box containing one wooden box labeled "Onyx" containing various cigars labeled Corajo" containing various cigars, and one box labeled "Romeo & Julieta" containing varius cigars. Marked for ID with 1730, 20 May 03, ██████████ b7c-1, b6-1
2	1	Telescope sight, MFID with 1732, 20 May 03, ██████████ b7c-1, b6-1
3	1	Rifle, AK-47, metal and wooden type constructed containing serial number AS 2105, 1988. MFID with 1735, 20 May 03, ██████████ b7c-1, b6-1
4	1	Rifle, Enfield, metal and wooden type constructed, MFID with 1736, 20 May 03, ██████████ b7c-1, b6-1
5	1	Cigarette lighter, brand name "Baretta", MFID with 1740, 20 May 03, ██████████ b7c-1, b6-1
6	2	Pistols, black in color, metal type constructed, MFID with 1741, 20 May 03, ██████████ b7c-1, b6-1
7	1	Pistol, Beretta, Model 925, metal type constructed, serial number B44421Z. MFID 1742, 20 May 03, ██████████ b7c-1, b6-1
8	1	Pistol, Sig Sauer, Model P220, metal type constructed, serial number G116190, MFID 1745, 20 May 03, ██████████ b7c-1, b6-1
//////////////////////LAST ITEM//////////////////////////////////////		

CHAIN OF CUSTODY

ITEM NO.	DATE	RELEASED BY	RECEIVED BY	PURPOSE OF CHANGE OF CUSTODY
1 thru 8	20 May 03	SIGNATURE ██████████ b7c-3, b6-3	SIGNATURE ██████████ b7c-1, b6-1	
		NAME, GRADE OR TITLE ██████████ MAJ	NAME, GRADE OR TITLE ██████████ SA	
	SIGNATURE	SIGNATURE		
	NAME, GRADE OR TITLE	NAME, GRADE OR TITLE		
	SIGNATURE	SIGNATURE		
	NAME, GRADE OR TITLE	NAME, GRADE OR TITLE		
	SIGNATURE	SIGNATURE		
	NAME, GRADE OR TITLE	NAME, GRADE OR TITLE		

DODDOACID-005340

1-2-26

EVIDENCE/PROPERTY CUSTODY DOCUMENT For use of this form see AR 190-45 and AR 195-5; the proponent agency is US Army Criminal Investigation Command	MPR/CID SEQUENCE NUMBER 0055-02-010349
	CRD REPORT/CID ROI NUMBER 59657

RECEIVING ACTIVITY 30th MP Det (CID) (FWD)	LOCATION BAGHDAD, IRAQ
NAME, GRADE AND TITLE OF PERSON FROM WHOM RECEIVED <input type="checkbox"/> OWNER MAJ [REDACTED] <input checked="" type="checkbox"/> OTHER	ADDRESS (Includes Zip Code) HHC, 316th Armor Bn (FWD) BAGHDAD, IRAQ
LOCATION FROM WHERE OBTAINED Taken from the hands of the ABOVE LISTED PERSON WHILE AT HUSSEIN'S MUSEUM, BAGHDAD, IRAQ	REASON OBTAINED Evidence
	TIME/DATE OBTAINED 1745, 20 MAY 03

ITEM NO.	QUANTITY	DESCRIPTION OF ARTICLES <i>(Include model, serial number, condition and unusual marks or scratches)</i>
1	1	Box containing 2 bottles of Rawlings London Dry Gin, 1 bottle ARAK Al wtm Special, 2 bottles fermenting with fruit, and 1 playboy magazine. MARKED FOR ID with 1745, 20 may 03, [REDACTED]

CHAIN OF CUSTODY			
ITEM NO.	DATE	RELEASED BY SIGNATURE NAME, GRADE OR TITLE	RECEIVED BY SIGNATURE NAME, GRADE OR TITLE
1	20 MAY 03	SIGNATURE [REDACTED] NAME, GRADE OR TITLE [REDACTED] MAJ	SIGNATURE [REDACTED] NAME, GRADE OR TITLE [REDACTED] SA
		SIGNATURE [REDACTED] NAME, GRADE OR TITLE	SIGNATURE [REDACTED] NAME, GRADE OR TITLE
		SIGNATURE NAME, GRADE OR TITLE	SIGNATURE NAME, GRADE OR TITLE
		SIGNATURE NAME, GRADE OR TITLE	SIGNATURE NAME, GRADE OR TITLE
		SIGNATURE NAME, GRADE OR TITLE	SIGNATURE NAME, GRADE OR TITLE
		SIGNATURE NAME, GRADE OR TITLE	SIGNATURE NAME, GRADE OR TITLE

PURPOSE OF CHANGE OF CUSTODY
Released to evidence custodian

DODDOACID-005341

198
 [Handwritten notes]

25 MAY 2003

FROM: SAC, 30TH MILITARY POLICE DET (CID) (FWD)
TO: DIRECTOR, USACRC, USACIDC, FORT BELVOIR, VA
CDR USACIDC //CIOP-ZA//
CDR, 10TH MP BN (CID) (ABN) (FWD) //OPS//
CDR, 3D MP GROUP (CID) (REAR) //OPS//
CDR, 3D MP GROUP (CID) (FWD) //OPS//
PROVOST MARSHAL //PM//

SUBJECT: CID REPORT - 2D STATUS/SSI - 0055-03-CID349-59657-5Y2P4/7J9C2/5Y2N3/5Y2C/5Y2G4/5X2/7X2

DRAFTER: **b7c-1, b6-1**
RELEASER: [REDACTED]

UNCLASSIFIED-FOR OFFICIAL USE ONLY

1. DATES/TIMES/LOCATIONS OF OCCURRENCES:

1. 22 APR 03/0001 - 18 MAY 03/1800, VARIOUS LOCATIONS WITHIN NORTHEAST SECTOR OF BAGHDAD, IRAQ

2. DATE/TIME REPORTED: 20 MAY 2003, 1100

3. INVESTIGATED BY: SA **b7c-1, b6-1, b2** SA **b7c-1, b6-1**
b7c-1, b6-1, b2

4. SUBJECT: 1. **b7c-5, b6-5** CPT; **b7c-5, b6-1**
[REDACTED] MALE; OTHER; HHC, 3/69th ARMOR (DEPLOYED), FORT STEWART, GA 31314; FC; [AIDING THE ENEMY] [DEALING/SELLING/TRADING CAPTURED PROPERTY] [ENDANDERING SAFETY OF COMMAND] [FAILURE TO OBEY ORDER OR REGULATION] [CONSPIRACY]

b7c-5, b6-5 2. **b7c-5, b6-5** SGT; **b7c-5, b6-5**
[REDACTED] MALE; OTHER; HHC, 3/69th ARMOR (DEPLOYED), FORT STEWART, GA 31314; FC; [AIDING THE ENEMY] [DEALING/SELLING/TRADING CAPTURED PROPERTY] [ENDANDERING SAFETY OF COMMAND] [FAILURE TO OBEY ORDER OR REGULATION] [CONSPIRACY]

b7c-5, b6-5 3. **b7c-5, b6-5** SFC; **b7c-5, b6-5**
[REDACTED] HHC, 3/69th ARMOR (DEPLOYED), FORT STEWART, GA 31314; FC; [AIDING THE ENEMY] [DEALING/SELLING/TRADING CAPTURED PROPERTY] [ENDANDERING SAFETY OF COMMAND] [FAILURE TO OBEY ORDER OR REGULATION] [CONSPIRACY]

[ADD] 4. **b7c-5, b6-5** PFC; **b7c-5, b6-5**
[REDACTED]

67c-5, 665
[REDACTED] HHC, 3/69TH ARMOR (DEPLOYED), FORT STEWART, GA 31314; FC; [AIDING THE ENEMY] [FAILURE TO OBEY ORDER OR REGULATION]

67c-5, 665 [ADD] 5. [REDACTED] SGT; [REDACTED] 67c-5, 665
[REDACTED] HHC, 3/69TH ARMOR (DEPLOYED), FORT STEWART, GA 31314; FC; [AIDING THE ENEMY] [DEALING/SELLING/TRADING CAPTURED PROPERTY]

67c-5, 665 [ADD] 6. [REDACTED] PFC; [REDACTED] 67c-5, 665
[REDACTED] HHC, 3/69TH ARMOR (DEPLOYED), FORT STEWART, GA 31314; FC; [AIDING THE ENEMY] [DEALING/SELLING/TRADING CAPTURED PROPERTY] [FAILURE TO OBEY ORDER OR REGULATION]

5. VICTIM: 1. U.S. GOVERNMENT; [AIDING THE ENEMY] [DEALING/SELLING/TRADING CAPTURED PROPERTY] [ENDANGERING SAFETY OF COMMAND] [FAILURE TO OBEY ORDER OR REGULATION] [CONSPIRACY]

[ADD] 2. UNKNOWN; [NFI]; [LARCENY]

6. INVESTIGATION SUMMARY: THE INFORMATION IN THIS REPORT IS BASED UPON AN ALLEGATION OR PRELIMINARY INVESTIGATION AND MAY CHANGE PRIOR TO THE COMPLETION OF THE INVESTIGATION.

2D STATUS:

67c-5, 665 THE PURPOSE OF THIS REPORT IS TO ADD [REDACTED] 67c-5, 665 AND [REDACTED] AS SUBJECTS OF THIS INVESTIGATION FOR THE ABOVE CITED OFFENSES. FURTHER, TO LIST [REDACTED] AND [REDACTED] 67c-5, 665 FOR THE OFFENSES OF CONSPIRACY AND LARCENY. ALSO, TO LIST AN UNKNOWN FOR THE OFFENSE OF LARCENY.

DURING CANVASS INTERVIEWS OF UNIT PERSONNEL, CREDIBLE INFORMATION WAS DEVELOPED THAT [REDACTED] 67c-5, 665 AND [REDACTED] 67c-5, 665 CONSPIRED TO CONDUCT UNAUTHORIZED CHECKPOINTS OUTSIDE OF THEIR PATROL AREA, WHERE THEY CONDUCTED SEARCHES AND SEIZED BETWEEN 250,000-300,000 DINAR FROM IRAQI CITIZENS. THE STOLEN MONEY WAS MAINTAINED BY [REDACTED] 67c-5, 665 TO MAKE PERSONAL PURCHASES. ALSO, INFORMATION WAS DEVELOPED THAT [REDACTED] 67c-5, 665 AND [REDACTED] 67c-5, 665 WERE ALSO INVOLVED IN AIDING THE ENEMY, DEALING/SELLING/TRADING CAPTURED PROPERTY, ENDANGERING THE SAFETY OF COMMAND, AND FAILURE TO OBEY ORDER OR REGULATION.

ON 21 MAY 03, [REDACTED] 67c-5, 665 WAS ADVISED OF HIS RIGHTS, WHICH HE WAIVED AND CONFESSED TO WARNING MR. [REDACTED] 67c-5, 665 TO STAY AWAY FROM [REDACTED] 67c-5, 665 AND [REDACTED] 67c-5, 665 BECAUSE OF THE UPCOMING INVESTIGATION CONCERNING THEIR DEALINGS WITH THE CONFISCATED WEAPONS. PFC [REDACTED] 67c-5, 665 ALSO CONFESSED TO CONSUMING ALCOHOL

WHILE CONDUCTING SECURITY PATROLS.

ON 21 MAY 03, ^{b7c-5, b6-5} [REDACTED] WAS ADVISED OF HIS RIGHTS, WHICH HE WAIVED, AND CONFESSED THAT ON OR AROUND 18 MAY 03, HE GAVE MR. ^{b7c-4, b6-4} [REDACTED] 9MM PISTOL.

ON 23 MAY 03, ^{b7c-5, b6-5} [REDACTED] WAS ADVISED OF HIS RIGHTS, WHICH HE ^{b7c-4, b6-4} WAIVED, AND CONFESSED TO TRADING PISTOLS WITH MR. [REDACTED] AND CONSUMING ALCOHOL WHILE CONDUCTING SECURITY PATROLS.

REQUEST NAME CHECKS OF ^{b7c-5, b6-5} [REDACTED] AND ^{b7c-5, b6-5} [REDACTED]

INVESTIGATION CONTINUES BY CID.

INITIAL:

"THIS IS AN OPERATION IRAQI FREEDOM INVESTIGATION"

THIS OFFICE WAS NOTIFIED BY THE 3RD INFANTRY DIVISION TACTICAL OPERATIONS CENTER OF AN UNLAWFUL WEAPONS TRANSFER TO AN IRAQI CIVILIAN.

PRELIMINARY INVESTIGATION DISCLOSED ^{b7c-5, b6-5} [REDACTED], AND ^{b7c-5, b6-5} [REDACTED] COMMITTED THE OFFENSES OF DEALING/SELLING/TRADING CAPTURED PROPERTY, ENDANGERING SAFETY OF COMMAND, AND FAILURE TO OBEY AN ORDER OR REGULATION WHEN THEY TRADED CAPTURED WEAPONS IN EXCHANGE FOR JEWELRY, ALCOHOL, AND WEAPONS WITH MR. ^{b7c-5, b6-5} [REDACTED] (NFI), A SUSPECTED MEMBER OF FEDAIYEN. FURTHER, MR. [REDACTED] WAS ALLOWED TO CONDUCT PATROLS WITH THE UNIT, AND HAVE ACCESS TO U.S. FORCES POSITIONS, ^{b7c-5, b6-5} [REDACTED] AND ^{b7c-5, b6-5} [REDACTED] ALSO VISITED MR. ^{b7c-4, b6-4} [REDACTED] BAGHDAD RESIDENCE APPROXIMATELY 30 TIMES WHERE A MAJORITY OF THE WEAPONS TRANSACTIONS TOOK PLACE. IT IS UNKNOWN AT THIS TIME HOW MANY WEAPONS WERE TRADED DURING A COMMAND AUTHORIZED SEARCH OF ^{b7c-5, b6-5} [REDACTED] AND ^{b7c-5, b6-5} [REDACTED] LIVING AREA, FOUR CAPTURED PISTOLS, VARIOUS TYPES OF JEWELRY, NUMEROUS BOXES OF CIGARS, AND BOTTLES OF LIQUOR WERE SEIZED.

ON 18 MAY 03, MR. ^{b7c-4, b6-4} [REDACTED] WAS DETAINED AND A SUBSEQUENT SEARCH REVEALED HE WAS IN POSSESSION OF A MAP WHICH LISTED ALL THE FEDAIYEN "SAFE HOUSES" IN THE BAGHDAD AREA. A SEARCH OF ^{b7c-4, b6-4} [REDACTED] RESIDENCE REVEALED ONE AK-47 AND A SIG SAUER PISTOL, SERIAL NUMBER G116190, WHICH WAS DETERMINED TO BE A WEAPON THAT WAS SEIZED BY ^{b7c-5, b6-5} [REDACTED] PLATOON AND CATALOGED IN THE UNIT'S WEAPONS REGISTER.

AN INITIAL INTERVIEW OF MR. ^{b7c-4, b6-4} [REDACTED] WAS CONDUCTED BY COUNTER INTELLIGENCE AGENTS AT WHICH TIME MR. ^{b7c-4, b6-4} [REDACTED] ADMITTED TO RECEIVING WEAPONS FROM ^{b7c-5, b6-5} [REDACTED] AND ^{b7c-5, b6-5} [REDACTED]

ON 20 MAY 03, ^{b7c-5, b6-5} [REDACTED] AND ^{b7c-5, b6-5} [REDACTED] WERE ADVISED OF THEIR RIGHTS, WHICH THEY INVOKED AND REQUESTED AN ATTORNEY.

ON 20 MAY 03, ^{b7c-5, b6-5} [REDACTED] WAS ADVISED OF HIS RIGHTS, WHICH HE WAIVED AND CONFESSED TO PROVIDING WEAPONS TO MR. ^{b7c-5, b6-5} [REDACTED] ^{b7c-4, b6-4} [REDACTED] CONSUMING ALCOHOLIC BEVERAGES, ALLOWING MR. ^{b7c-5, b6-5} [REDACTED] ACCESS TO OPERATIONAL INFORMATION, AND TO KNOWING MR. ^{b7c-5, b6-5} [REDACTED] WAS A MEMBER OF FEDAIYEN.

REQUEST NAME CHECKS OF ^{b7c-5, b6-5} [REDACTED] AND ^{b7c-5, b6-5} [REDACTED]

INVESTIGATION CONTINUES BY CID.

7. COMMANDERS ARE REMINDED OF THE PROVISIONS OF AR 600-8-2 PERTAINING TO SUSPENSION OF FAVORABLE PERSONNEL ACTIONS AND AR 380-67 FOR THE SUSPENSION OF SECURITY CLEARANCES OF PERSONS UNDER INVESTIGATION.

8. CID REPORTS ARE EXEMPT FROM AUTOMATIC TERMINATION OF PROTECTIVE MARKINGS IN ACCORDANCE WITH CHAPTER 3, AR 25-55.

21 MAY 2003

FROM: SAC, 30TH MILITARY POLICE DET (CID) (FWD)
TO: DIRECTOR, USACRC, USACIDC, FORT BELVOIR, VA
CDR USACIDC //CIOP-ZA//
CDR, 10TH MP BN (CID) (ABN) (FWD) //OPS//
CDR, 3D MP GROUP (CID) (REAR) //OPS//
CDR, 3D MP GROUP (CID) (FWD) //OPS//
PROVOST MARSHAL //PM//

SUBJECT: CID REPORT - INITIAL/SSI - 0055-03-CID349-59657-
5Y2P4/7J9C2/5Y2N3/5Y2C/5Y2G4/5X2

DRAFTER: [REDACTED]
RELEASER: [REDACTED]

UNCLASSIFIED-FOR OFFICIAL USE ONLY

1. DATES/TIMES/LOCATIONS OF OCCURRENCES:

1. 22 APR 03/0001 - 18 MAY 03/1800, VARIOUS LOCATIONS
WITHIN NORTHEAST SECTOR OF BAGHDAD, IRAQ

2. DATE/TIME REPORTED: 20 MAY 2003, 1100

3. INVESTIGATED BY: SA [REDACTED]

4. SUBJECT: 1. [REDACTED]

[REDACTED] CPT; [REDACTED]
MALE; OTHER; HHC,
3/69th ARMOR (DEPLOYED), FORT STEWART, GA 31314; FC; [AIDING
THE ENEMY] [DEALING/SELLING/TRADING CAPTURED PROPERTY]
[ENDANDERING SAFETY OF COMMAND] [FAILURE TO OBEY ORDER OR
REGULATION]

2. [REDACTED]

[REDACTED] SGT; [REDACTED]
MALE; OTHER; HHC, 3/69th ARMOR
(DEPLOYED), FORT STEWART, GA 31314; FC; [AIDING THE ENEMY]
[DEALING/SELLING/TRADING CAPTURED PROPERTY] [ENDANDERING
SAFETY OF COMMAND] [FAILURE TO OBEY ORDER OR REGULATION]

3. [REDACTED]

[REDACTED] SFC; [REDACTED]
HHC, 3/69th ARMOR (DEPLOYED), FORT
STEWART, GA 31314; FC; [AIDING THE ENEMY]
[DEALING/SELLING/TRADING CAPTURED PROPERTY] [ENDANDERING
SAFETY OF COMMAND] [FAILURE TO OBEY ORDER OR REGULATION]

5. VICTIM: 1. U.S. GOVERNMENT; [AIDING THE ENEMY]
[DEALING/SELLING/TRADING CAPTURED PROPERTY] [ENDANDERING
SAFETY OF COMMAND] [FAILURE TO OBEY ORDER OR REGULATION]

6. INVESTIGATION SUMMARY: THE INFORMATION IN THIS REPORT IS BASED UPON AN ALLEGATION OR PRELIMINARY INVESTIGATION AND MAY CHANGE PRIOR TO THE COMPLETION OF THE INVESTIGATION.

"THIS IS AN OPERATION IRAQI FREEDOM INVESTIGATION"

THIS OFFICE WAS NOTIFIED BY THE 3RD INFANTRY DIVISION TACTICAL OPERATIONS CENTER OF AN UNLAWFUL WEAPONS TRANSFER TO AN IRAQI CIVILIAN.

PRELIMINARY INVESTIGATION DISCLOSED [REDACTED] 67C-5, 66-5, AND [REDACTED] COMMITTED THE OFFENSES OF DEALING/SELLING/TRADING CAPTURED PROPERTY, ENDANGERING SAFETY OF COMMAND, AND FAILURE TO OBEY AN ORDER OR REGULATION WHEN THEY TRADED CAPTURED WEAPONS IN EXCHANGE FOR JEWELRY, ALCOHOL, AND WEAPONS WITH MR [REDACTED] (NFI), A SUSPECTED MEMBER OF FEDAIYEN. FURTHER, MR [REDACTED] WAS ALLOWED TO CONDUCT PATROLS WITH THE UNIT, AND HAVE ACCESS TO U.S. FORCES POSITIONS [REDACTED], AND [REDACTED] ALSO VISITED MR. [REDACTED] BAGHDAD RESIDENCE APPROXIMATELY 30 TIMES WHERE A MAJORITY OF THE WEAPONS TRANSACTIONS TOOK PLACE. IT IS UNKNOWN AT THIS TIME HOW MANY WEAPONS WERE TRADED DURING A COMMAND AUTHORIZED SEARCH OF [REDACTED] 67C-5, 66-5 AND [REDACTED] LIVING AREA, FOUR CAPTURED PISTOLS, VARIOUS TYPES OF JEWELRY, NUMEROUS BOXES OF CIGARS, AND BOTTLES OF LIQUOR WERE SEIZED.

ON 18 MAY 03, MR. [REDACTED] 67C-4, 66-4 WAS DETAINED AND A SUBSEQUENT SEARCH REVEALED HE WAS IN POSSESSION OF A MAP WHICH LISTED ALL THE FEDAIYEN "SAFE HOUSES" IN THE BAGHDAD AREA. A SEARCH OF [REDACTED] 67C-4, 66-4 RESIDENCE REVEALED ONE AK-47 AND A SIG SAUER PISTOL, SERIAL NUMBER G116190, WHICH WAS DETERMINED TO BE A WEAPON THAT WAS SEIZED BY [REDACTED] 67C-5, 66-5 PLATOON AND CATALOGED IN THE UNIT'S WEAPONS REGISTER.

AN INITIAL INTERVIEW OF MR [REDACTED] 67C-4, 66-4 WAS CONDUCTED BY COUNTER INTELLIGENCE AGENTS AT WHICH TIME MR. [REDACTED] 67C-4, 66-4 ADMITTED TO RECEIVING WEAPONS FROM [REDACTED] AND [REDACTED] 67C-5, 66-5

ON 20 MAY 03, [REDACTED] 67C-5, 66-5 AND [REDACTED] 67C-5, 66-5 WERE ADVISED OF THEIR RIGHTS, WHICH THEY INVOKED AND REQUESTED AN ATTORNEY.

ON 20 MAY 03, [REDACTED] 67C-5, 66-5 WAS ADVISED OF HIS RIGHTS, WHICH HE WAIVED AND CONFESSED TO PROVIDING WEAPONS TO MR [REDACTED] 67C-4, 66-4 CONSUMING ALCOHOLIC BEVERAGES, ALLOWING MR [REDACTED] ACCESS TO OPERATIONAL INFORMATION, AND TO KNOWING MR [REDACTED] 67C-4, 66-4 WAS A MEMBER OF FEDAIYEN.

REQUEST NAME CHECKS OF [REDACTED] 67C-5, 66-5 AND [REDACTED] 67C-5, 66-5

INVESTIGATION CONTINUES BY CID.

7. COMMANDERS ARE REMINDED OF THE PROVISIONS OF AR 600-8-2 PERTAINING TO SUSPENSION OF FAVORABLE PERSONNEL ACTIONS AND AR 380-67 FOR THE SUSPENSION OF SECURITY CLEARANCES OF PERSONS UNDER INVESTIGATION.

8. CID REPORTS ARE EXEMPT FROM AUTOMATIC TERMINATION OF PROTECTIVE MARKINGS IN ACCORDANCE WITH CHAPTER 3, AR 25-55.

Dickerson, Robert D

b7c-1 b6-1

b7c-1 b6-1

From: [REDACTED] Mr CID/CIRC-BAS [REDACTED]@us.army.mil]
Sent: Tuesday, November 09, 2004 11:59 AM
To: Dickerson, Robert D
Subject: Disposition on cases 0050 and 0055-349

Sir,

This is a follow up for your earlier request for dispositions on subjects of several investigations conducted in Iraq. I previously replied with information known at the time.

This is an update.

b7c-5 b6-5

Case 0055-03-CID349: PFC [REDACTED] received a FG Article 15 on 5 Jun 03 with 45 days extra duty. b7c-5 b6-5

PFC [REDACTED] and SGT [REDACTED] were discharged from active duty. No known date, type of chapter not held locally. If you need more data, please inform this office so we can submit a formal request.

b7c-1 b6-1
[REDACTED]
CW2, MP
ASAC

Dickerson, Robert D

b7c-1 b6-1

b7c-1 b6-1

From: [redacted] Mr CID/CIRC-BAS [redacted]@us.army.mil]
Sent: Tuesday, October 12, 2004 5:11 PM
To: Dickerson, Robert D
Cc: [redacted] CW4
Subject: RE: Needed Dispositions

Regarding the 30th MP Det cases

0055-03-CID349-59657-5Y - SUBJECTS:

[redacted]
[redacted]
[redacted]
[redacted]
[redacted]

Partial DISPOSITION

b7c-5 b6-5

[redacted] Reprimand, 16mos confinement GCM, dismissed from service 27 Jan 04
[redacted] Art 15, Reduced to E4, forfeiture of 2/3 pay for one month;
- restricted for 60 days, 15 Dec 03.
[redacted] 1 year confinement GCM, 21 Nov 03.

b7c-5 b6-5

Still waiting on data on the other three. Neither the unit records nor SJA have any record of their punishments.

b7c-5 b6-5

0050-03-CID349-59654-5N - SUBJECTS:

[redacted]

Both were discharged under Ch 10 in lieu of Courts Martial, Other Than Honorable, 19 Sep 04.

I plan to have the information regarding the other 3 tomorrow.

[redacted]
CW2, MP

b7c-1 b6-1