



Payment Services

SIC⁴ Documentation Interbank Messages

Implementation Guideline
Customer Payments

FIToFI Customer Credit Transfer (pacs.008)



General notes

SIX Interbank Clearing reserves the right to modify this document, as the need arises, at any time without prior notice.

SIX Interbank Clearing reserves all rights for this document including the rights of photomechanical reproduction, storage on electronic media and the translation into foreign languages.

Although great care has been taken in the compilation and preparation of this work to ensure accuracy, errors and omissions cannot be entirely ruled out. SIX Interbank Clearing cannot be held liable for any decision made or action taken in reliance on the information in this document or for any consequential, special or similar damages.

If you detect any errors in this document or have any ideas or suggestions for improvements we would be extremely grateful if you would notify these by E-mail to **operations@six-group.com**.

About this document

Target audience

The "SIC⁴ Documentation Interbank Messages – Implementation Guidelines ISO 20022 Interbank messages for participants of the RTGS systems SIC and euroSIC", hereinafter called Implementation Guidelines, is addressed to all participants of the Swiss RTGS systems SIC and euroSIC on the SIC⁴ platform, using the ISO 20022 message standard.

Purpose

The Implementation Guidelines consist of a base document with general information concerning all message types and various module documents – one each per ISO 20022 message type, e.g. this document for the message "pacs.008" – with message-specific information, including information on the application-specific handling of individual elements. They specify the messages to be submitted to and delivered from the RTGS systems SIC and euroSIC in the ISO 20022 message standard.

Amendment control

All the amendments carried out on this document are listed in an amendment record table showing the version, the date of the amendment, a brief amendment description and a statement of the sections concerned.

Associated documents

Supplementary information to the Implementation Guidelines can be found in the reference documents listed in the Base Document.

Amendment control

All the amendments carried out on this document are listed below, with the version, the date of the amendment, a brief amendment description and a statement of the sections concerned.

Version	Date	Amendment description	Section
1.0	01.01.2014	First edition	All
1.1	30.04.2014	Default Routing SCT no longer available in the ISO 20022 standard (code value NODR inapplicable in processing instruction).	3.6.4
		Code value NODR removed from the following element:	4.2
		<ul style="list-style-type: none"> • CdtTrfTxInf/InstrForNxtAgt/InstrInf 	
1.2	30.06.2014	Following elements changed:	4.2
		<ul style="list-style-type: none"> • CdtTrfTxInf/DbtrAgtAcct • CdtTrfTxInf/UlmtCdtr/... • CdtTrfTxInf/InstrForNxtAgt/InstrInf 	

Table of contents

1	Overview of documentation structure	6
2	ISO definitions	7
3	Business specifications for the RTGS systems	8
3.1	Use cases	8
3.2	Payment types	9
3.3	Naming of the parties in a customer transfer	10
3.4	Addressing "Institutions"	12
3.5	Use of references	13
3.5.1	Message reference	13
3.5.2	Transaction references	14
3.5.3	Customer references	14
3.6	Specific Swiss code values	17
3.6.1	Identifying direct debit information	17
3.6.2	Code list for defining creditor account numbers	18
3.6.3	Reference types	19
3.6.4	Sending processing instructions to the RTGS systems	20
3.7	New functions in the RTGS systems	21
3.7.1	Entering an earliest possible settlement time	21
3.7.2	Reservation request	22
3.8	Further business specifications	22
4	Technical specifications for the RTGS systems	23
4.1	Group Header (GrpHdr, A-Level)	23
4.2	Credit Transfer Transaction Information (CdtTrfTxInf, B-Level)	30
5	Example	73
5.1	Use case: customer payment to a bank account (STP customer payment)	73
Appendix A: XML schema and example		77
Appendix B: Table of figures		78
Appendix C: Table of tables		78

1 Overview of documentation structure

These Implementation Guidelines are modular in structure:

- The base document contains general information applying to all messages.
- The module documents – one for each ISO 20022 message type – contain message-specific information, including information on the application-specific handling of certain elements.
- For each Implementation Guideline, an XML schema (XSD) and generic XML sample messages will be published.

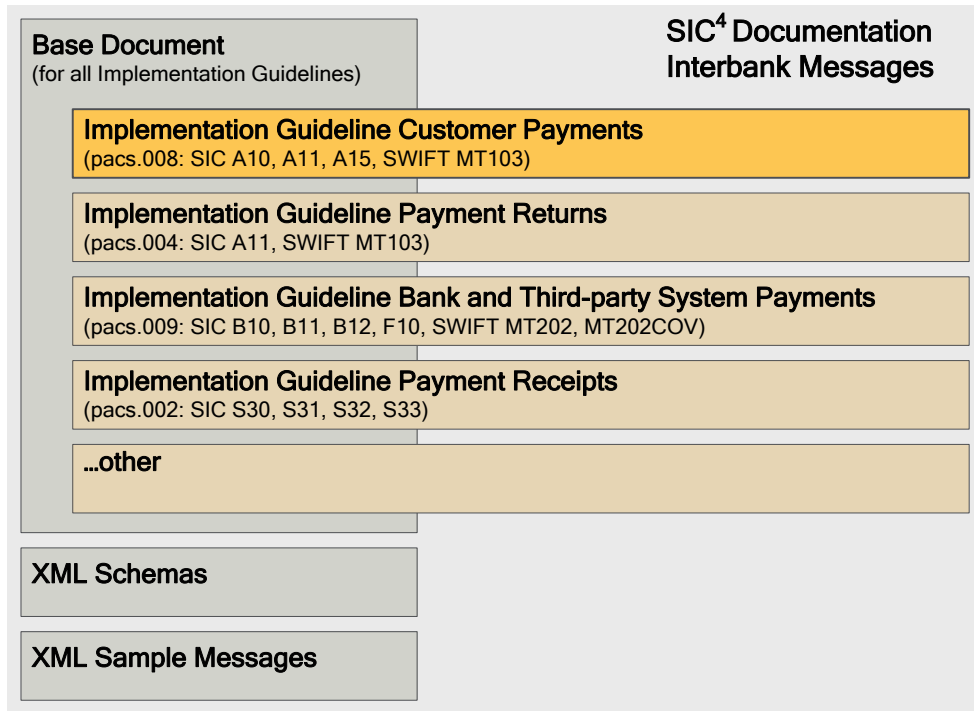
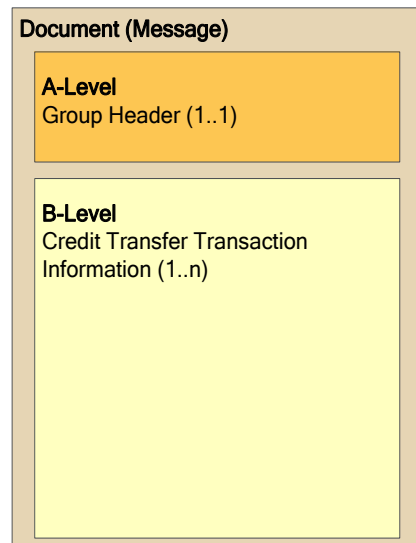

Figure 1: Documentation structure

2 ISO definitions

The XML message "Financial Institution To Financial Institution Customer Credit Transfer" (pacs.008) is sent from the debtor's financial institution (the instructing participant) to the RTGS systems and from the RTGS systems to the creditor's financial institution (the instructed participant) in order to process a customer payment. It is used on the basis of the ISO 20022 XML schema "pacs.008.001.02".



The XML message "pacs.008" is essentially structured as follows:

- **A-Level:** Message level, element "Group Header". This block must occur exactly once.
- **B-Level:** Payment or transaction level, element "Credit Transfer Transaction Information". This block must occur at least once and can occur n times in the ISO definition. In the RTGS systems, this block is only permitted once.

Figure 2: Basic message structure for XML message "pacs.008"

3 Business specifications for the RTGS systems

3.1 Use cases

The XML message "Financial Institution To Financial Institution Customer Credit Transfer Initiation" is used in the following situations in the RTGS systems:

Use case	Input/Output	SIC	FIN	ISO 20022
Customer payment	I/O	A10 A11 A15	MT103	pacs.008
Direct debit payment	I/O	A10 A15	MT103	pacs.008
SEPA credit transfer (FC-RTGS ¹ only)	I/O	A11	MT103	pacs.008

Table 1: Situations where the ISO 20022 message type "pacs.008" is used

¹ FC-RTGS = Real Time Gross Settlement System for foreign currencies

3.2 Payment types

Various different payment types can be handled using a "pacs.008" XML message. The following are provided for:

Payment type	Code value
ISR payment	ESRPMT
ISR payment resulting from a direct debit	ESRDEB
IPI payment resulting from a direct debit	IPIDEB
Outpayment order	OUTPMT
SEPA payment	SEPPMT
Salary payment	SLRPMT
Customer payment, general	CSTPMT

Table 2: List of payment types and their code values in the XML message

To ensure that specific payment types can be defined and validated correctly, the corresponding code values are provided in the *CatTrfTxInf/PmtTplnf/LclInstrm/Prtry* element for identification purposes.

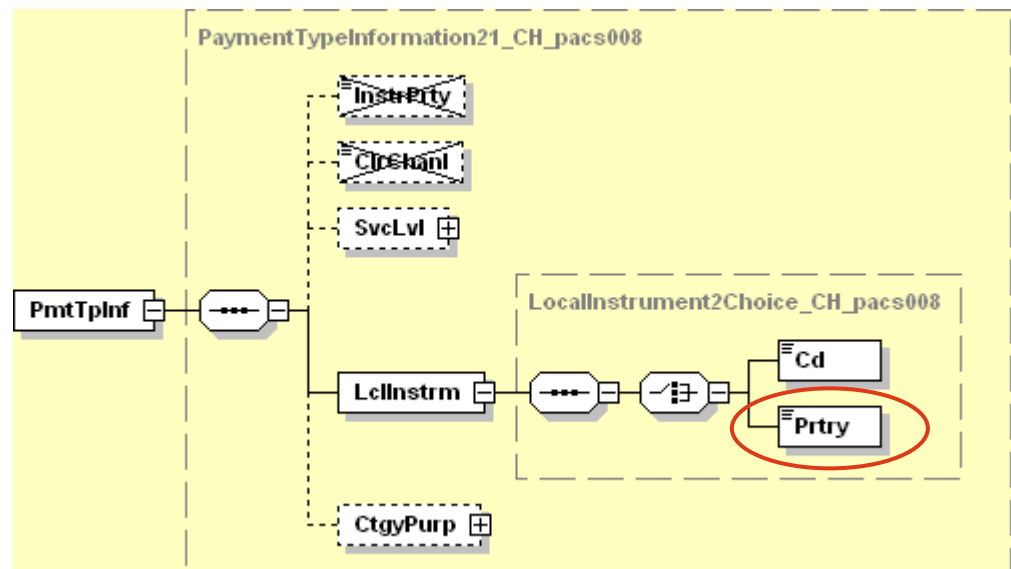

Figure 3: Indication of the payment type in the XML message

3.3 Naming of the parties in a customer transfer

In customer transfers, the parties involved are named as follows:

Name	Comment	ISO 20022
Ultimate Debtor		Ultimate Debtor
Debtor	Is a customer of the debtor's financial institution	Debtor
Debtor Agent	Handles the debtor's account	Debtor Agent
Instructing Participant	The instructing participant has a settlement account in the RTGS system which is debited	Instructing Agent [Member ID]
Optional ID	Is filled in by the RTGS system when a delivery is made by system managers for a participant: ID of the system manager	Is not shown in the message
Optional ID	Is filled in by the RTGS system in the case of a concatenated BC number or when a PC/ISR is forwarded directly to an institution: the participant whose settlement account in the RTGS system is being credited and to whom the transfer is being made	Instructed Agent [Other ID]
Instructed Participant	The instructed participant has a settlement account in the RTGS system which is credited	Instructed Agent [Member ID]
Intermediary Agent	When present, the agent who manages the account at the creditor's financial institution	Intermediary Agent
Creditor Agent	Manages the creditor's account	Creditor Agent
Creditor	Is a customer of the creditor's financial institution	Creditor
Ultimate Creditor		Ultimate Creditor

Table 3: Names of the parties involved in transfers

Notes on the individual parties:

Debtor Agent/Creditor Agent

- The "*Debtor Agent*"/"*Creditor Agent*" elements correspond to the account-holding institutions of the "*Debtor*"/"*Creditor*" and must always be sent.
- If the system participant is the same as the creditor's financial institution, then the same information is sent in the "*Creditor Agent*" element as under "*Instructed Agent*".

Intermediary Agent

- Only one occurrence of the "*Intermediary Agent*" is supported.

Debtor/Creditor

- The "*Instructing Agent*" is a compulsory field (mandatory, Input/Output) and performs a dual role as system participant and sender. The "*Instructing Agent*" is also used together with the "*Transaction Identification*" element and the "*Message Identification*" for duplicate checking (like the SIC field 02). If the "*Debtor Agent*" is the same as the system participant/sender, then that identification is sent in the "*Instructing Agent*" element and also as the "*Debtor Agent*" (however, in the case of conversion to other message standards, the identification is only forwarded once).
- The "*Instructed Agent*" element must be filled in by the sender with the name of the system participant on the creditor side.
- On the basis of the "SWIFT Translation Rules", the two elements "*Instructing Agent*"/"*Instructed Agent*" are used at <GrpHdr> level; entering them at <CdtTrfTxInf> level is not supported.
- The information that is delivered in the input under "*Instructed Agent*"/"*Creditor Agent*" is forwarded in the output by the RTGS systems unchanged.
- In the case of concatenation or direct forwarding, the details of the destination for the concatenation/direct forwarding are given in the output under the following sub-element of "*Instructed Agent*": *InstdAgt/FinInstnId/OthrId*.
- Details of the destination for the concatenation/direct forwarding are only given in the "*Instructed Agent*", even if in the input the elements "*Instructed Agent*"/"*Creditor Agent*" were sent with the same information about the system participant (in the case of conversion to other message standards, the identification is only forwarded once).

3.4 Addressing "Institutions"

Instructing Agent/Instructed Agent (sender/recipient of the message)

- Addressing using the BC number or BIC
- The following elements can be used:
 BIC: `.../FinInstnId/BIC`
 BC number: `.../FinInstnId/ClrSysMmbld/Mmbld`
 and "Cd = CHSIC" is mandatory under `.../ClrSysMmbld/ClrSysId/Cd`
 (Format: 6 digits numerical i.e. only digits 0 – 9)
- The sub-elements `.../FinInstnId/BIC` and `.../FinInstnId/ClrSysMmbld` must not be used at the same time.
- The identification used by the sender is forwarded to the recipient unchanged.
- The use of "Name" and/or "Postal Address" is not permitted.
 Reason: these "Agents" have to be participants in the RTGS systems and are therefore only addressed using their unique identifications.

Debtor Agent/Creditor Agent

- These can generally be addressed using any kind of identification, because the system participant is identified using the "Instructing Agent".
- The sub-elements `.../FinInstnId/BIC` and `.../FinInstnId/ClrSysMmbld` must not be used at the same time.
- A full address including the "Name" and "Postal Address" elements can also be entered.
 The following rules must be taken into account:
 - a) Where the BIC is used, the "Name"/"Postal Address" must not be entered.
 - b) "Postal Address" is only permitted in combination with "Name".
 - c) "Name" can be used without "Postal Address".

Intermediary Agent

- This can generally be addressed using any kind of identification.
- The sub-elements `.../FinInstnId/BIC` and `.../FinInstnId/ClrSysMmbld` must not be used at the same time.
- A full address including the "Name" and "Postal Address" elements can also be entered.
 The following rules must be taken into account:
 - d) Where the BIC is used, the "Name"/"Postal Address" must not be entered.
 - e) "Postal Address" is only permitted in combination with "Name".
 - f) "Name" can be used without "Postal Address".

3.5 Use of references

Along the processing chain, various references are sent in the "pacs.008" message.

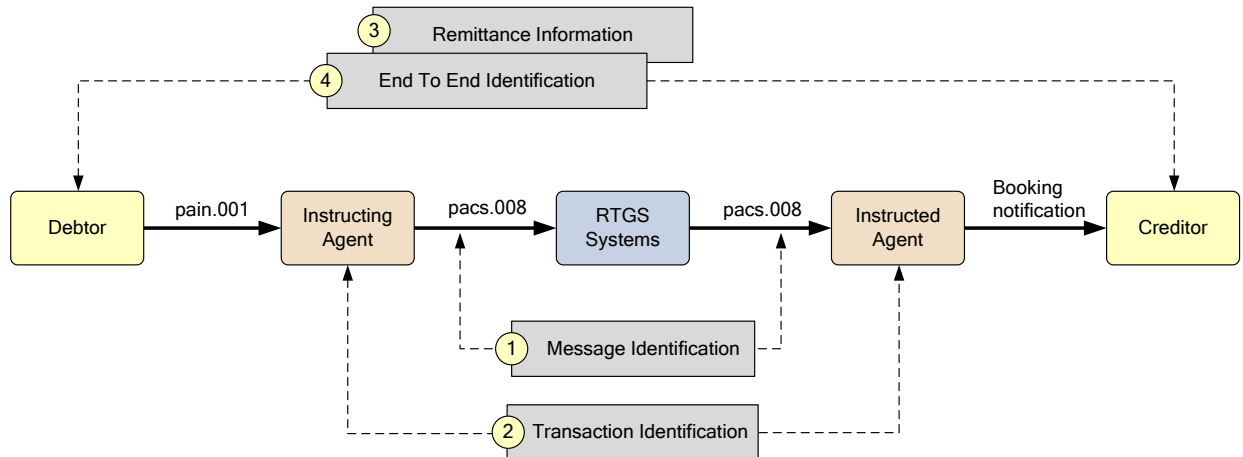

Figure 4: Use of references

3.5.1 Message reference

Message Identification (A-Level) ^①

The message identification is a "technical" reference which is generated by the producer of the message. In a message from the instructing participant to the RTGS systems, this is generated by the instructing participant (Instructing Agent). In a message from the RTGS systems to the instructed participant, a new message is produced and so a new <MsgId> is generated by the RTGS systems. The <MsgId> is used in the RTGS systems for duplicate checking at message level ("technical" duplicate checking).

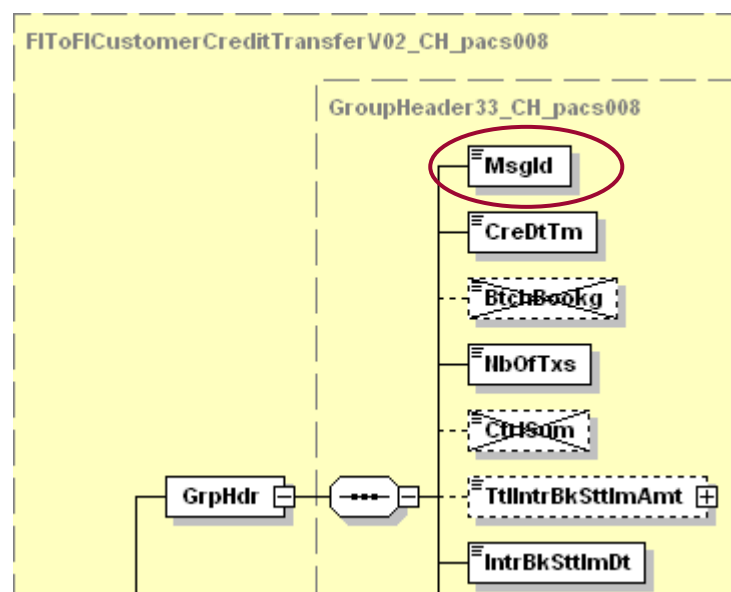

Figure 5: Message Identification

3.5.2 Transaction references

Transaction Identification (B-Level) ²

The transaction identification is the unique reference for a transaction. This reference is assigned by the instructing participant when the transaction is being set up and is forwarded unchanged by the RTGS systems to the instructed participant. The transaction identification is also sent in the receipt to the instructing participant as the transaction reference. The transaction identification is used for "technical" duplicate checking at transaction level.

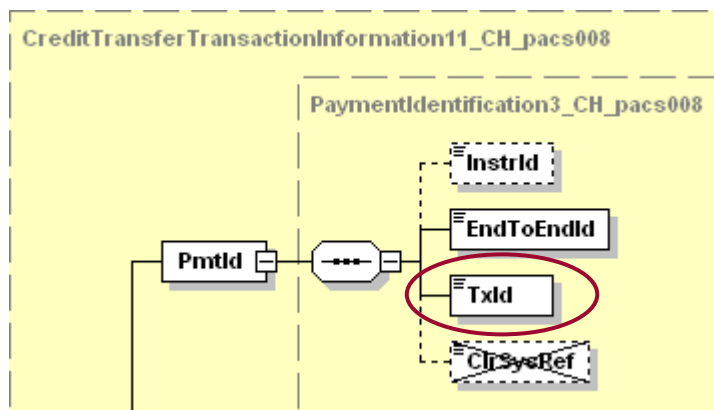

Figure 6: Transaction Identification

3.5.3 Customer references

3.5.3.1 Debtor references

End To End Identification ⁴

The debtor can provide the payment with a unique reference which is forwarded unchanged throughout the whole processing chain in the "End To End Identification" element (except in the case of ISR payments). The element contains the entry "NOTPROVIDED", if there is no known identifier.

3.5.3.2 Creditor references

In addition to the references in the processing chain that are listed above, a creditor reference can also be sent in structured or unstructured form in the "Remittance Information" element.

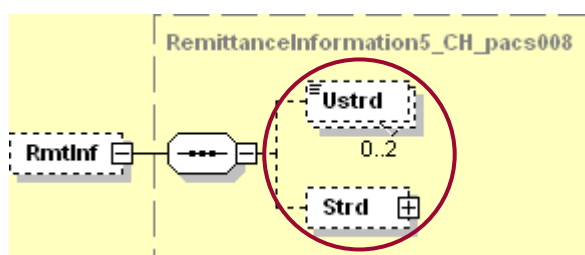

Figure 7: Creditor reference (Remittance Information)

Using the *"Unstructured"/"Structured"* sub-elements at the same time within the *"Remittance Information"* element is not permitted (in line with SEPA and the Swiss Recommendations for Bank-to-Customer Messages).

Structured Customer Reference as Remittance Information ³

The following three types of structured reference can be sent in the *CdtrRefInf/Ref* element:

1. Using the Swiss ISR reference

In Switzerland the ISR reference enables the creditor to make automatic comparisons between his invoices and the incoming payments.

2. Using the ISO Creditor Reference

The ISO Creditor Reference (ISO 11649) enables the creditor to make automatic comparisons between his invoices and the incoming payments.

Use of the ISO Creditor Reference is described in the document "EPC Guidance on the use of the future ISO standard for the Structured Creditor Reference" (EPC142-08) [6].

3. Use of the structured details of payment from the IPI

For the structured details of payment from the IPI, the same procedure applies as for the ISR reference.

The following specifications should be noted when using structured references:

- In the case of payment types "SEPA payment" and "Customer payment, general", the length of the *"Structured"* sub-element is limited to max. 140 positions (incl. tags in the sub-elements, in line with SEPA and the Swiss Recommendations for Bank-to-Customer Messages). This restriction means that data losses during conversion to SIC/FIN messages can be avoided.
- The *CdtTrfTxInf/RmtInf/Strd/CdtrRefInf/Ref* element is used for all structured reference numbers.

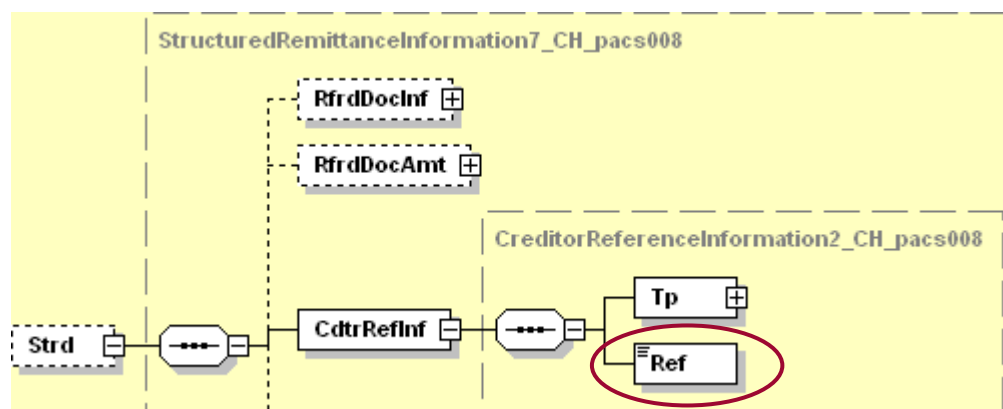

Figure 8: Creditor Reference Information

- In addition to the reference number, a code value must always be sent which uniquely identifies the type of reference number. The elements *CdtTrfTxInf/RmtInf/Strd/CdtrRefInf/Tp/CdOrPrtry/Cd* or *.../Prtry* (see also section 3.6 "Specific Swiss code values") can be used for this purpose.

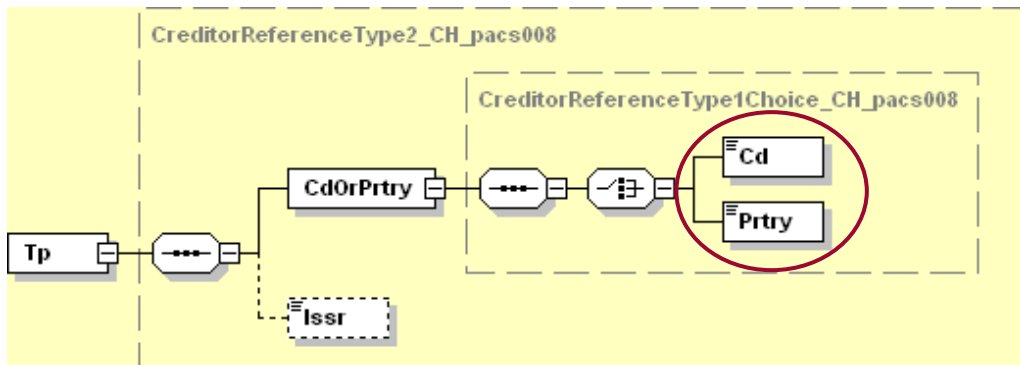

Figure 9: Creditor Reference Type

Unstructured Customer Reference as Remittance Information 3

Instead of the structured reference, this can also be sent in unstructured form, maximum length 140 characters.

Limiting rules regarding "Structured"/"Unstructured"

For certain circumstances/payment types, there are rules limiting the use of "Structured"/"Unstructured":

- IPI payment: either *<Strd>* with a 20-position structured details of payment entry or *<Ustrd>* with a maximum 35-position unstructured details of payment entry
- ISR payment: always *<Strd>* with the ISR reference; *<Ustrd>* not permitted
- SEPA payment: either *<Ustrd>* or *<Strd>*; with *<Strd>* the RF Creditor Reference under ISO 11649 can be used
- Direct debit payment: always *<Strd>* with ISR reference or structured details of payment entry taken from the IPI and details of the LSV-Id/requested processing date; *<Ustrd>* not permitted

3.6 Specific Swiss code values

At various points in the "pacs.008" message, specific Swiss code values are used. These are all defined for "Proprietary" versions and are used for the unique identification of specific values in the Swiss Interbank Standard.

These code values are used whenever it is not possible uniquely to identify a transaction using values from the "ISO External Code Lists".

3.6.1 Identifying direct debit information

Relevant information from LSV⁺/BDD transactions is identified using the code value "LSVBDD".

Code value	Meaning
LSVBDD	Information from the LSV ⁺ /BDD transaction (LSV ⁺ /BDD identification, requested processing date)

Table 4: Code value for LSV⁺/BDD transactions

The code value is sent in the *FIToFICstmrCdtTrf/CdtTrfTxInf/RmtInf/Strd/RfrdDocInf/Tp/CdOrPrtry/Prtry* element.

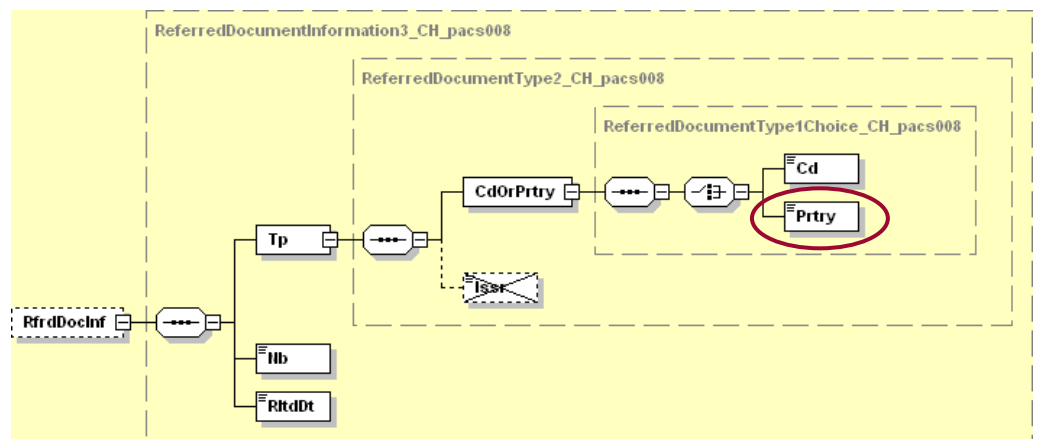

Figure 10: Identifier for direct debits

3.6.2 Code list for defining creditor account numbers

The following codes are available for identifying the account number type for the creditor account:

Code value	Meaning
PRTRY	Conventional format
PCACC	Postal account number
ESRPT	ISR participant number
PSREF	IS reference number

Table 5: Defining creditor account numbers

The code value is sent in the *FIToFICstmrCdtTrf/CdtTrfTxInf/CdtrAcct/Id/Othr/SchmeNm/Prtry* element.

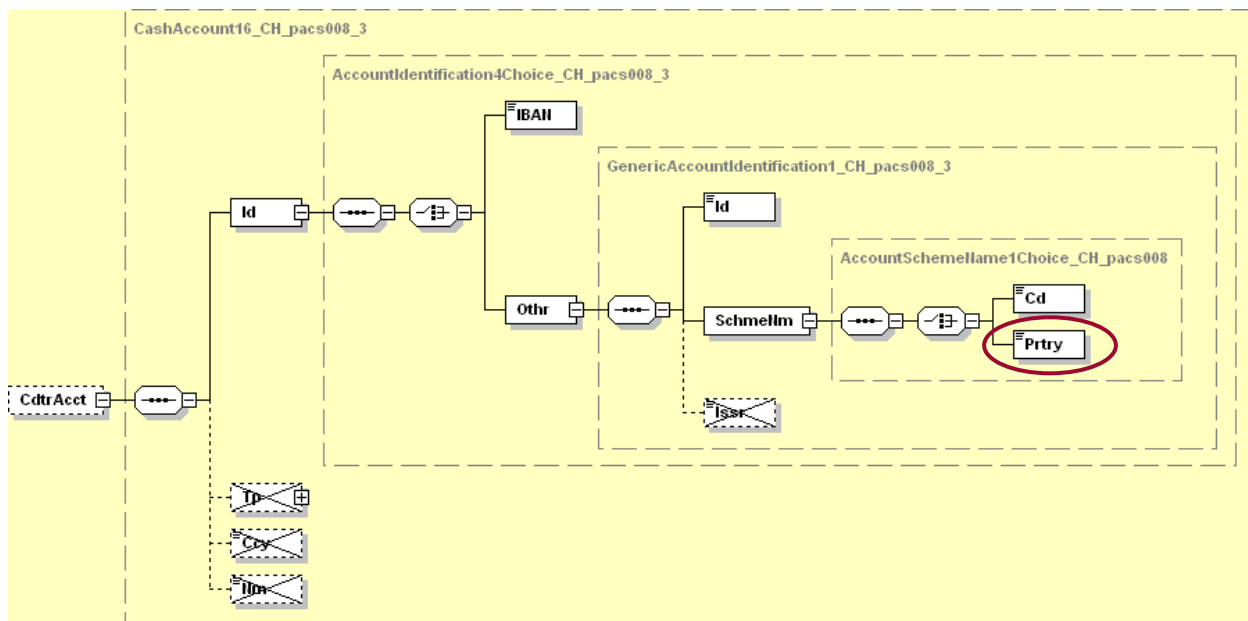

Figure 11: Account number definition

3.6.3 Reference types

References of the ISR or IPI type are identified using the following code values:

Code value	Meaning
ESR	ISR reference
IPI	Structured details of payment from the IPI

Table 6: Code values for reference types

The code value is sent in the *FiToFiCstmrCdtTrf/CdtTrfTxInf/RmtInf/Strd/CdtrRefInf/Tp/CdOrPrtry/Prtry* element.

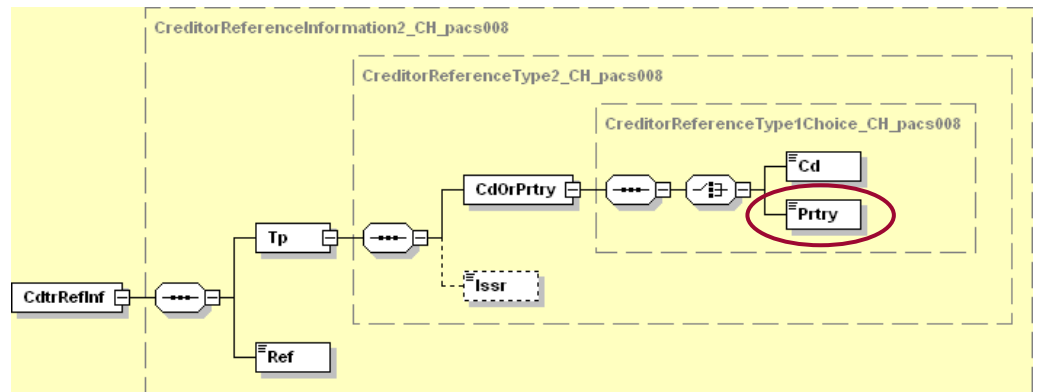

Figure 12: Entering a code for the reference type

3.6.4 Sending processing instructions to the RTGS systems

Processing instructions can be sent to the RTGS systems for the following tasks using a code value:

- For the new function "reservation request" (LIQU) (see also section 3.7.2 "Reservation request").
- For the existing option of requesting a confirmation of settlement (CONF).

Code value	Meaning
LIQU	Reservation request
CONF	Request confirmation of settlement

Table 7: Code values for sending processing instructions to the RTGS systems

The code value is sent in the *FIToFICstmrCdtTrf/CdtTrfTxInf/InstrForNxtAgt/InstrInf* element.

In order to reflect any combination of these processing instructions and any future processing instructions, the element *FIToFICstmrCdtTrf/CdtTrfTxInf/InstrForNxtAgt/InstrInf* can be sent more than once. Only one processing instruction can be sent on each occasion. The same processing instructions may not be sent more than once.

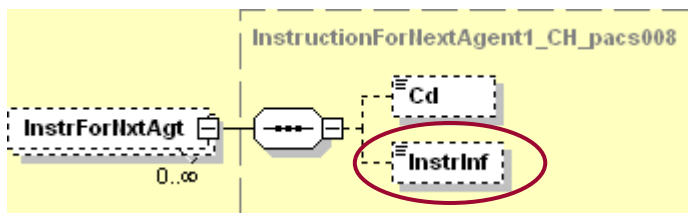

Figure 13: Entering a code for sending processing instructions to the RTGS systems

3.7 New functions in the RTGS systems

The functions described below are only available in the RTGS systems for payment messages in the ISO 20022 message standard.

3.7.1 Entering an earliest possible settlement time

By entering an earliest settlement time, the sender has the option of adding payments to the waiting list at a specific time. To do this, the calendar date and time of the earliest requested settlement time must be given. Entering a calendar date is required because in RTGS systems one clearing day extends across more than one calendar days.

To ensure that the payment is correctly processed when the earliest settlement time is reached, various consistency checks are carried out when the payment is received. The following conditions should be taken into account:

- A valid calendar date and a valid time must be sent.
- If the indicated earliest settlement time is before the time of delivery it will be replaced by the time of delivery. The change will be advised in the receipt "pacs.002" with status "ACWC".
- The earliest settlement time is entered in addition to the requested settlement date. To avoid inconsistencies, a check is carried out to find out whether the time specified is within the clearing day given for the requested settlement date. If this is not the case, the payment will be rejected.
- The checks on the validity of the time are based on the clearing stop times according to the standard daily schedule for the clearing day in question. For operational reasons, the system manager may alter the actual clearing stop times. To avoid processing problems due to subsequent alterations, the requested time must not be between clearing stops 1 and 3 on the clearing day in question.
- Where an earliest settlement time is used, the sender must ensure that the requested settlement date can be adhered to. If this is not the case (e.g. not a banking business day, date is in the past), the payment will be rejected.

A requested earliest settlement time can be entered in the *FIToFICstrmr CdtTrf/CdtTrfTxInf/StlmTmIndctn/DbtDtTm* element.

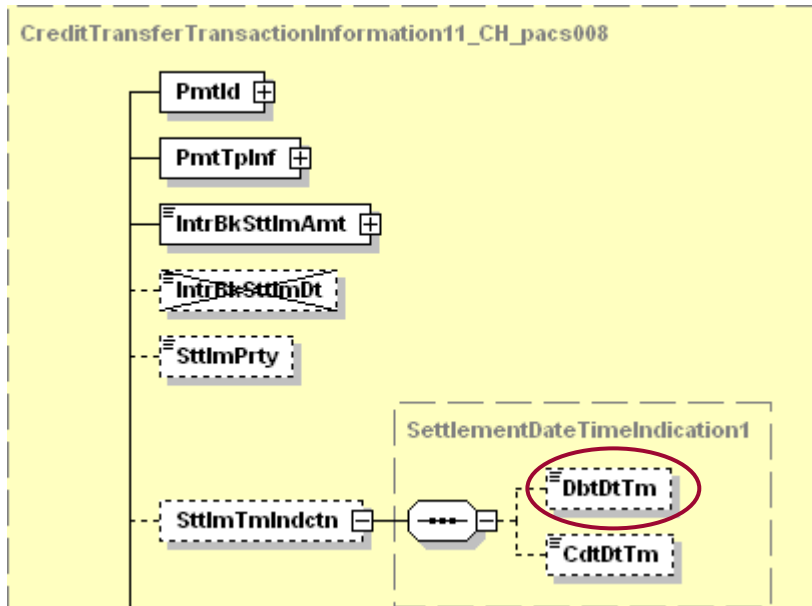

Figure 14: Entering an earliest settlement time

3.7.2 Reservation request

Liquidity reservations are used to ensure that there is sufficient liquidity for certain payments. The participant reserves liquidity on the settlement account. This reserved amount can then only be used to execute transfers with a reservation identifier.

A processing instruction to make use of reserved liquidity can be entered using the code "LIQU" in the `FIToFICstmrCdtTrf/CdtTrfTxInf/InstrForNxtAgt/InstrInf` element (see also section 3.6.4 "Sending processing instructions to the RTGS systems").

3.8 Further business specifications

Further business specifications can be found in the Base Document.

4 Technical specifications for the RTGS systems

4.1 Group Header (GrpHdr, A-Level)

The "Group Header" (A-Level of the message) occurs exactly once in the message and contains the following elements:

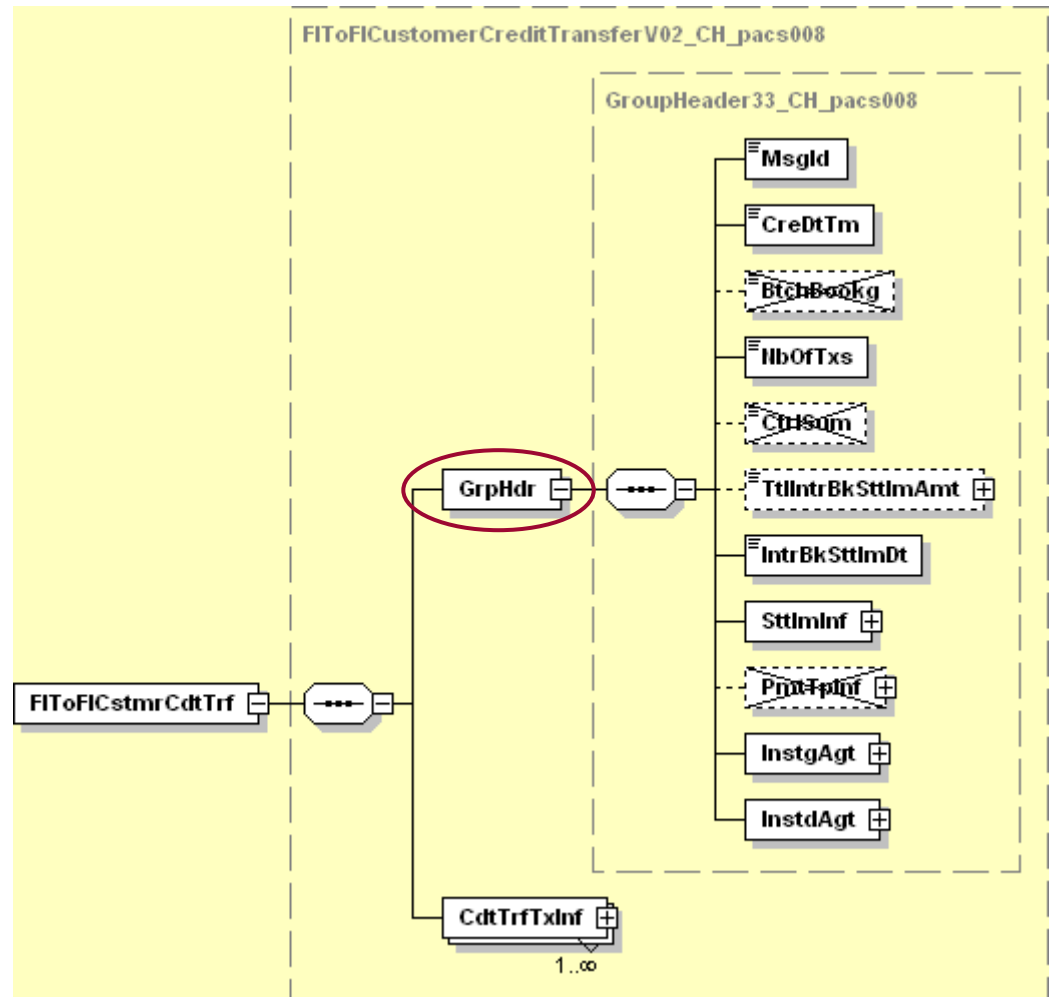

Figure 15: Group Header (GrpHdr) pacs.008

The following table specifies all the elements of the "Group Header" of the XML message "pacs.008" that are relevant to the RTGS systems.



ISO 20022 Standard			Swiss ISO 20022 Payments Standard				
Message Item	XML Tag	Mult.	Mult.	Definition	Payment Type-specific Definition	SIC A10/A11/A15	SWIFT MT103
Document +FITo FICustomer Credit Transfer V02	FIToFICstmrCdtTrf	1..1	1..1				
Group Header	GrpHdr	1..1	1..1				
Group Header +Message Identification	MsgId	1..1	1..1	Message Identification Only the SWIFT character set excluding spaces is permitted for this element. It is used together with <InstgAgt> for duplicate checking at message level and may only occur once within the permitted value dates. Permitted value dates are 5 days pre-value date, value date today and 2 days in the past. Note: For a payment to be processed successfully, no duplicates must be detected at either message level or transaction level.			
Group Header +Creation Date Time	CreDtTm	1..1	1..1	Creation Date Time			
Group Header +Number Of Transactions	NbOfTxs	1..1	1..1	Number Of Transactions The entry for the number of transactions must be "1".			
Group Header +Total Interbank Settlement Amount	TtlIntrBkSttlmAmt	0..1	0..1	Total Settlement Amount If present, the amount must be identical with the settlement amount in the <IntrBkSttlmAmt> element. Must contain no more than 13 digits (excl. decimal separator) including a maximum of 2 fractional digits. Amount must be >0, the maximum accepted amount is 99,999,999,999.99.	ESRPMT: Currency CHF: For payments to PostFinance the maximum accepted amount is 99,999,999.99. OUTPMT: Only "CHF" permitted. SEPPMT: Must be used. Only "EUR" permitted. The maximum accepted amount is 999,999,999.99.		
	Ccy			Currency Code If present, the currency must be identical with the currency of the settlement amount in the <IntrBkSttlmAmt/@Ccy> element. The currency code must be "CHF" or "EUR". The currency must correspond to the currency in the respective RTGS system.	OUTPMT: Only "CHF" permitted. SEPPMT: Only "EUR" permitted.		



ISO 20022 Standard			Swiss ISO 20022 Payments Standard				
Message Item	XML Tag	Mult.	Mult.	Definition	Payment Type-specific Definition	SIC A10/A11/A15	SWIFT MT103
Group Header +Interbank Settlement Date	IntrBkStlmDt	0..1	1..1	Requested Settlement Date Will be forwarded unchanged to the instructed participant. Must be a valid calendar date. Must not be more than 5 banking business days in the future. Must not be more than 90 calendar days in the past. The settlement date on the sight deposit accounts of the SNB and SECB is defined as follows on the SIC4 platform: (A) If the requested settlement date is after the current clearing date: if the requested settlement date is not a valid banking business day, the next following banking business day will be used as the settlement date, otherwise the settlement date will be copied from the requested settlement date. (B) If the requested settlement date is equal or before the current clearing date, the settlement date will be copied from the current clearing date.		MT A10 F16 Format = 8d MT A11 F16 Format = 8d MT A15 F16 Format = 8d	F32A Value Date Format YYYYMMDD
Group Header +Settlement Information	StlmInf	1..1	1..1	Settlement Information			
Group Header +Settlement Information ++Settlement Method	StlmMtd	1..1	1..1	Settlement Method SIC4: Content must be "CLRG" (Clearing).			
Group Header +Settlement Information ++Settlement Account	StlmAcct	0..1	0..1	Settlement Account SIC4: Must not be used.			

ISO 20022 Standard			Swiss ISO 20022 Payments Standard				
Message Item	XML Tag	Mult.	Mult.	Definition	Payment Type-specific Definition	SIC A10/A11/A15	SWIFT MT103
Group Header +Settlement Information ++Clearing System	ClrSys	0..1	0..1	Clearing System SIC4: Optional element to specify routing information in the FC RTGS.	CSTPMT: Currency CHF: Must not be used. Currency EUR: Permitted values according to separate instructions. ESRDEB: Must not be used. ESRPMT: Must not be used. IPIDEB: Must not be used. OUTPMT: Must not be used. SEPPMT: Message from SIC4 to participant: Will only be delivered, if the information about the clearing system is available. Message from participant to SIC4: Must not be used. SLRPMT: Must not be used.		
Group Header +Settlement Information ++Clearing System +++Code	Cd	1..1	1..1	Clearing System Identification (code)			
Group Header +Settlement Information ++Clearing System +++Proprietary	Prtry	1..1	1..1	Clearing System Identification (proprietary)			
Group Header +Settlement Information ++Instructing Reimbursement Agent	InstgRmbrsmntAgt	0..1	0..1	Instructing Reimbursement Agent SIC4: Must not be used.			
Group Header +Instructing Agent	InstgAgt	0..1	1..1	Instructing Participant Must be used. Is used together with <Msgld> / <Txld> for duplicate checking. For addressing the participant, either the <BIC> or <ClrSysMmbld> element must be used. The instructing participant has a settlement account in the SIC4 system which is debited.			
Group Header +Instructing Agent ++Financial Institution Identification	FinInstnId	1..1	1..1				



ISO 20022 Standard			Swiss ISO 20022 Payments Standard				
Message Item	XML Tag	Mult.	Mult.	Definition	Payment Type-specific Definition	SIC A10/A11/A15	SWIFT MT103
Group Header +Instructing Agent ++Financial Institution Identification +++BIC	BIC	0..1	0..1	Identification of Instructing Participant (BIC) SWIFT address with 8 or 11 alphanumeric characters. This element must not be used at the same time as <ClrSysMmbld>. Must contain a valid value according to ISO 9362. Must contain a valid BIC of an active participant. Must not be concatenated.	SEPPMT: Must be used.		
Group Header +Instructing Agent ++Financial Institution Identification +++Clearing System Member Identification	ClrSysMmbld	0..1	0..1	Identification of Instructing Participant (proprietary) This element must not be used at the same time as <BIC>. Must contain a valid identification of an active participant. Must not be concatenated.	SEPPMT: Must not be used.		
Group Header +Instructing Agent ++Financial Institution Identification +++Clearing System Member Identification ++++Clearing System Identification	ClrSysId	0..1	1..1	Clearing System Identification Must be used to unambiguously identify the address type.			
Group Header +Instructing Agent ++Financial Institution Identification +++Clearing System Member Identification ++++Clearing System Identification +++++Code	Cd	1..1	1..1	Clearing System Identification (code) Permitted ISO code value: CHSIC (BC number, 6 digits).			
Group Header +Instructing Agent ++Financial Institution Identification +++Clearing System Member Identification ++++Clearing System Identification +++++Proprietary	Prtry	1..1	1..1	Clearing System Identification (proprietary) Is currently not supported.			



ISO 20022 Standard			Swiss ISO 20022 Payments Standard				
Message Item	XML Tag	Mult.	Mult.	Definition	Payment Type-specific Definition	SIC A10/A11/A15	SWIFT MT103
Group Header +Instructing Agent ++Financial Institution Identification +++Clearing System Member Identification ++++Member Identification	Mmbld	1..1	1..1	Member Identification BC number (=6n), must be contained in the BC bank master data, active, and not concatenated.		MT A10 F02 MT A11 F02 MT A15 F02	
Group Header +Instructed Agent	InstdAgt	0..1	1..1	Instructed Participant Must be used. For addressing the participant, either the <BIC> or <ClrSysMmbld> element must be used. The instructed participant has a settlement account in the SIC4 system which is credited.	OUTPMT: Must include the identification of PostFinance.		
Group Header +Instructed Agent ++Financial Institution Identification	FinInstnld	1..1	1..1				
Group Header +Instructed Agent ++Financial Institution Identification +++BIC	BIC	0..1	0..1	Identification of Instructed Participant (BIC) SWIFT address with 8 or 11 alphanumeric characters. This element must not be used at the same time as <ClrSysMmbld>. Must contain a valid value according to ISO 9362. Must contain a valid BIC of an active participant.	SEPPMT: Must be used.		
Group Header +Instructed Agent ++Financial Institution Identification +++Clearing System Member Identification	ClrSysMmbld	0..1	0..1	Identification of Instructed Participant (proprietary) This element must not be used at the same time as <BIC>. Must contain valid identification for an active participant.	SEPPMT: Must not be used.		
Group Header +Instructed Agent ++Financial Institution Identification +++Clearing System Member Identification ++++Clearing System Identification	ClrSysId	0..1	1..1	Clearing System Identification Must be used to unambiguously identify the address type.			

ISO 20022 Standard			Swiss ISO 20022 Payments Standard				
Message Item	XML Tag	Mult.	Mult.	Definition	Payment Type-specific Definition	SIC A10/A11/A15	SWIFT MT103
Group Header +Instructed Agent ++Financial Institution Identification +++Clearing System Member Identification ++++Clearing System Identification +++++Code	Cd	1..1	1..1	Clearing System Identification (code) Permitted ISO code value: CHSIC (BC number, 6 digits).			
Group Header +Instructed Agent ++Financial Institution Identification +++Clearing System Member Identification ++++Clearing System Identification +++++Proprietary	Prtry	1..1	1..1	Clearing System Identification (proprietary) Is currently not supported.			
Group Header +Instructed Agent ++Financial Institution Identification +++Clearing System Member Identification ++++Member Identification	Mmbld	1..1	1..1	Member Identification BC number (=6n), must be contained in the BC bank master data and active.		MT A10 F18 MT A11 F18 MT A15 F18	Input Header Block 2: Receiver's Address Input to SWIFT, conversion of BC number to BIC (if not concatenated)
Group Header +Instructed Agent ++Financial Institution Identification +++Other	Othr	0..1	0..1				
Group Header +Instructed Agent ++Financial Institution Identification +++Other ++++Identification	Id	1..1	1..1	Assigned Identification of the Instructed Participant Message from SIC4 to participant: In case of a concatenated BC number or direct routing, the identification of the instructed participant will be assigned by SIC and provided in this element. Message from participant to SIC4: Must not be used.		MT A10 F90 MT A11 F90 MT A15 F90	Input Header Block 2: Receiver's Address Input to SWIFT, conversion of BC number to BIC (if concatenated)

Table 8: Group Header (GrpHdr, A-Level)

4.2 Credit Transfer Transaction Information (CdtTrfTxInf, B-Level)

The "Credit Transfer Transaction Information" (B-Level of the message) contains the following information about the payment or transaction:

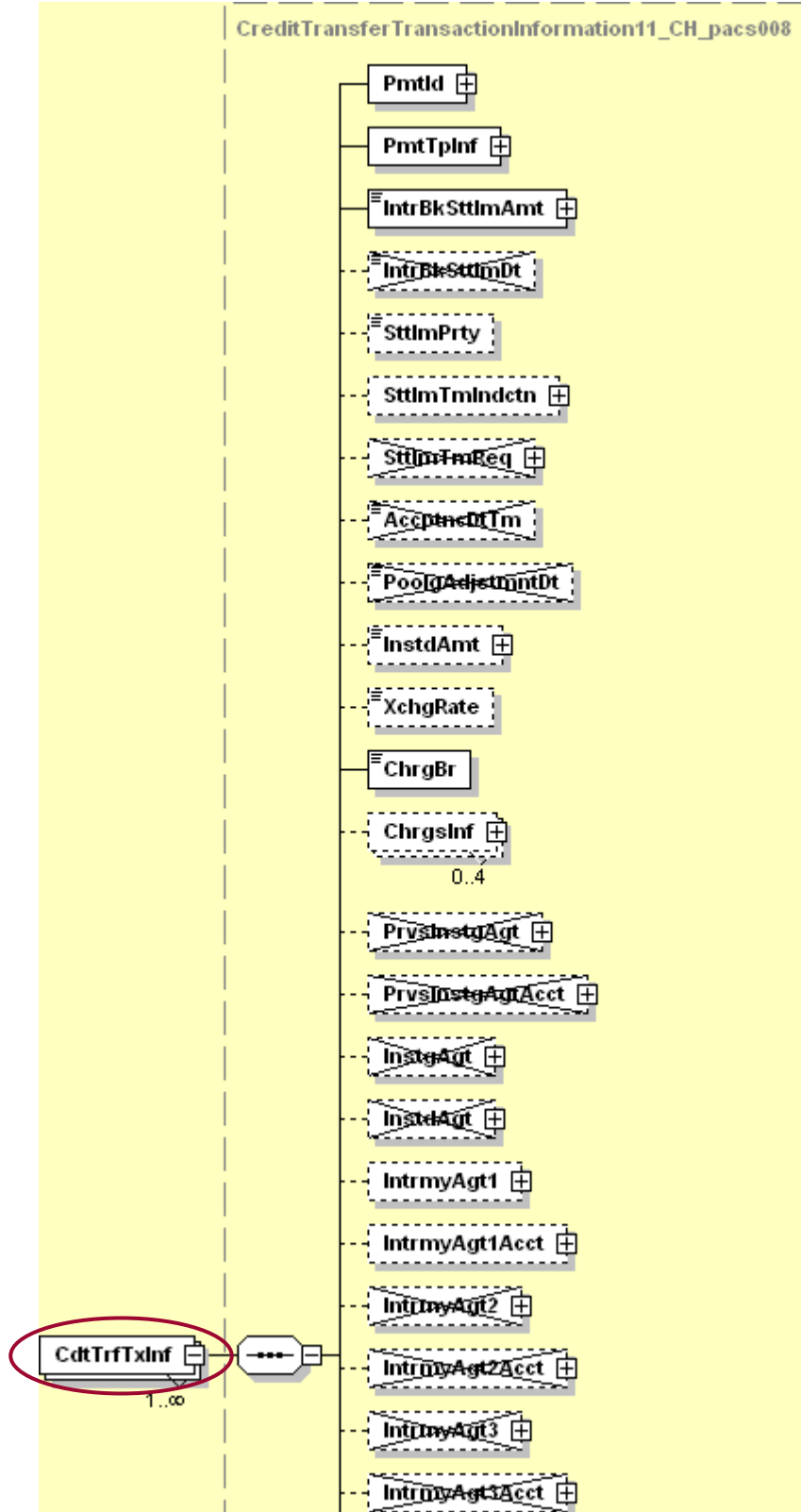

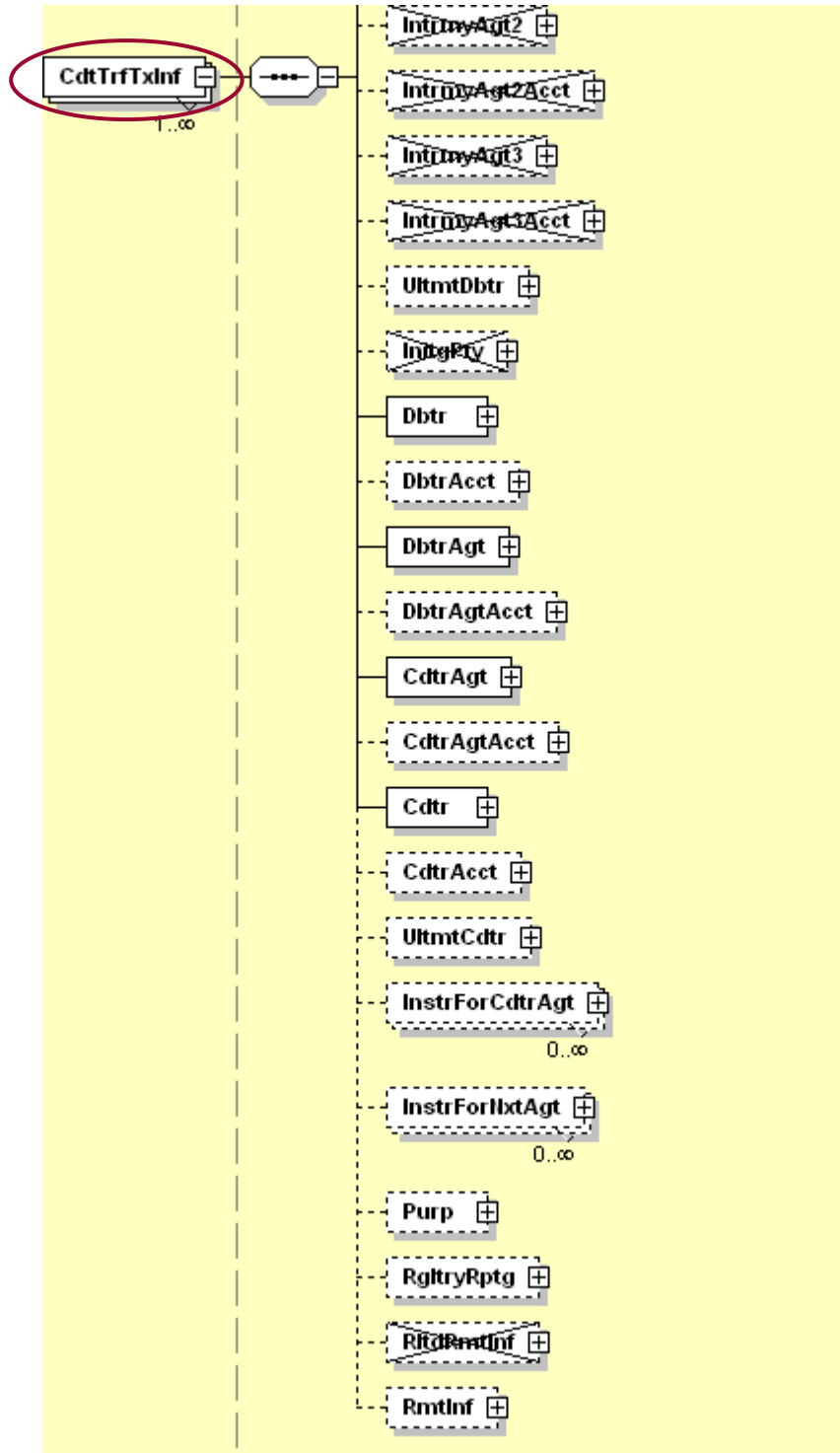

Figure 16: Credit Transfer Transaction Information (CdtTrfTxInf)

The following table specifies all the elements of the "Credit Transfer Transaction Information" of the XML message "pacs.008" that are relevant to the RTGS systems.



ISO 20022 Standard			Swiss ISO 20022 Payments Standard				
Message Item	XML Tag	Mult.	Mult.	Definition	Payment Type-specific Definition	SIC A10/A11/A15	SWIFT MT103
Credit Transfer Transaction Information	CdtTrfTxInf	1..n	1..n	SIC4: This element cannot be used more than once.			
Credit Transfer Transaction Information +Payment Identification	PmtId	1..1	1..1	Payment reference			
Credit Transfer Transaction Information +Payment Identification ++Instruction Identification	InstrId	0..1	0..1	Original SEPA Transaction Identification Only used for incoming SEPA payments from SECB and includes the original transaction reference for the sake of clarity.	CSTPMT: Must not be used. ESRDEB: Must not be used. ESRPMT: Must not be used. IPIDEB: Must not be used. OUTPMT: Must not be used. SLRPMT: Must not be used. SEPPMT: Message from SIC4 to participant: Contains the original transaction reference (content from <TxId>) of the SEPA payment. Message from participant to SIC4: Must not be used.	MT A11 F53 Line 2	
Credit Transfer Transaction Information +Payment Identification ++End To End Identification	EndToEndId	1..1	1..1	Debtor Reference The identification corresponds to the debtor's reference number. The element contains "NOTPROVIDED" if there is no known identification. The identification is exchanged between the creditor and the debtor.	OUTPMT: Recommendation: Use "NOTPROVIDED" because this information is usually not passed on to the creditor.	MT A10 F56 MT A11 F56 MT A15 F56	F70 Remittance Information Code /ROC/
Credit Transfer Transaction Information +Payment Identification ++Transaction Identification	TxId	1..1	1..1	Transaction Identification Only the SWIFT character set excluding spaces is permitted for this element. Only 16 characters permitted, must contain a digit 0 - 9 or a letter a - z or A - Z in the first position. It is used together with <InstgAgt> for duplicate checking at message level and may only occur once within the permitted value dates. Permitted value dates are 5 days pre-value date, value date today and 2 days in the past. Note: For a payment to be processed successfully, no duplicates must be identifiable at either message level or transaction level.	SEPPMT: Message from SIC4 to participant: Contains a new transaction reference generated by SECB. The original SEPA payment transaction reference can be found in the <InstrId> element.	MT A10 F03 MT A11 F03 MT A15 F03	F20 Sender's Reference
Credit Transfer Transaction Information +Payment Type Information	PmtTpInf	0..1	1..1	Payment Type Information Must be used.			
Credit Transfer Transaction Information +Payment Type Information ++Service Level	SvcLvl	0..1	0..1	Service Level	OUTPMT: Must not be used. SLRPMT: Must not be used. SEPPMT: Must be used.		



ISO 20022 Standard			Swiss ISO 20022 Payments Standard				
Message Item	XML Tag	Mult.	Mult.	Definition	Payment Type-specific Definition	SIC A10/A11/A15	SWIFT MT103
Credit Transfer Transaction Information +Payment Type Information ++Service Level +++Code	Cd	1..1	1..1	Service Level (code) The following ISO code values are taken into account: SEPA = SEPA payment URGP = Urgent payment, is forwarded as an urgent payment if converted to a SIC message type (Field 59 notification code = 2)	ESRPMT: Currency CHF: Must not be used. Currency EUR: Only code "URGP" is permitted. CSTPMT: Only code "URGP" is permitted. ESRDEB: Currency CHF: Must not be used. Currency EUR: Only code "URGP" is permitted. IPIDEB: Only code "URGP" is permitted. SEPPMT: Code "SEPA" is mandatory, other values are not permitted.	MT A11 F59 Code 2 = URGP MT A10 F59 Code 2 = URGP	F72 Sender to Receiver Information /SICAVIS/ plus 1-position code (Code 2 = URGP)
Credit Transfer Transaction Information +Payment Type Information ++Service Level +++Proprietary	Prtry	1..1	1..1	Service Level (proprietary) Only SWIFT Bank Operation Codes may be indicated in this element. Validation is made in accordance with SWIFT Field Specifications 23B. TRUNCATION: If the format "IS reference number" is selected for the creditor's account, then this element cannot be forwarded during conversion to a SIC/FIN message type. It is recommended that the element is not used.	ESRDEB: Must not be used. ESRPMT: Must not be used. IPIDEB: Must not be used. SEPPMT: Must not be used.	MT A11 F57B	F23B Bank Operation Code
Credit Transfer Transaction Information +Payment Type Information ++Local Instrument	LclInstrm	0..1	1..1	Payment Type Must be used for indicating system-specific codes to unambiguously identify the payment type.			
Credit Transfer Transaction Information +Payment Type Information ++Local Instrument +++Code	Cd	1..1	1..1	SIC4: Must not be used.			



ISO 20022 Standard			Swiss ISO 20022 Payments Standard				
Message Item	XML Tag	Mult.	Mult.	Definition	Payment Type-specific Definition	SIC A10/A11/A15	SWIFT MT103
Credit Transfer Transaction Information +Payment Type Information ++Local Instrument +++Proprietary	Prtry	1..1	1..1	Payment Type (proprietary) Unambiguous identification of the payment type, the following code values for payment types are available: ESRPMT = ISR payment ESRDEB = ISR payment resulting from a direct debit IPIDEB = IPI payment resulting from a direct debit OUTPMT = Outpayment order (CHF only) SEPPMT = SEPA payment (EUR only) SLRPMT = Salary payment CSTPMT = Generic customer payment		MT A10 F21 In the service application "LS" equates to the payment type ESRDEB or IPIDEB	
Credit Transfer Transaction Information +Payment Type Information ++Category Purpose	CtgyPurp	0..1	0..1	Category Purpose	ESRDEB: Must not be used. ESRPMT: Must not be used. IPIDEB: Must not be used. SLRPMT: Must be used.		
Credit Transfer Transaction Information +Payment Type Information ++Category Purpose +++Code	Cd	1..1	1..1	Category Purpose (code) TRUNCATION: In the case of conversion to a SIC/FIN message type, this data might not be fully transmitted under any circumstances.	CSTPMT: In the case of conversion to a SIC/FIN message type, content is not forwarded. SLRPMT: Must be used. The following ISO code values are supported: SALA = Salary payment, in the case of conversion to a SIC message type the payment will be flagged (Field 59 notification code = 1) as a salary payment. PENS = Pension payment, in the case of conversion to a SIC message type the payment will be flagged (Field 59 notification code = 1) as a pension payment.	MT A10 F59 Code 1 = SALA / PENS	F72 Sender to Receiver Information /SICAVIS/ plus 1-position code (Code 1 = SALA / PENS)
Credit Transfer Transaction Information +Payment Type Information ++Category Purpose +++Proprietary	Prtry	1..1	1..1	Category Purpose (proprietary) TRUNCATION: In the case of conversion to a SIC/FIN message type, this data might not be fully transmitted under any circumstances.	CSTPMT: In the case of conversion to a SIC/FIN message type, the content of this element will not be forwarded. SLRPMT: Must not be used.		

ISO 20022 Standard			Swiss ISO 20022 Payments Standard				
Message Item	XML Tag	Mult.	Mult.	Definition	Payment Type-specific Definition	SIC A10/A11/A15	SWIFT MT103
Credit Transfer Transaction Information +Interbank Settlement Amount	IntrBkSttlmAmt	1..1	1..1	Settlement Amount Must contain no more than 13 digits (excl. decimal separator), including a maximum of 2 fractional digits. Amount must be >0, the maximum accepted amount is 99,999,999,999.99.	ESRPMT: Currency CHF: For payments to PostFinance the maximum accepted amount is 99,999,999.99. OUTPMT: Only "CHF" permitted. SEPPMT: Only "EUR" permitted. The maximum accepted amount is 999,999.99.	MT A10 F17A Format = 15amt MT A11 F17A Format = 15amt MT A15 F17A Format = 15amt	F32A Interbank Settlement Amount
	Ccy			Currency Code The currency code must be "CHF" or "EUR". The currency must correspond to the currency in the respective RTGS system.	OUTPMT: Only "CHF" permitted. SEPPMT: Only "EUR" permitted.	MT A10 F15 CHF or EUR only MT A11 F15 CHF or EUR only MT A15 F15 CHF only	F32A Currency
Credit Transfer Transaction Information +Settlement Priority	SttlmPrty	0..1	0..1	Settlement Priority The following 3 levels of priority may be used: NORM = Normal priority, lowest level HIGH = High priority, medium level URGT = Urgent priority, highest level. If no priority is specified, normal priority applies.		MT A10 F20 B9 = NORM B7 = HIGH B1 = URGT MT A11 F20 B9 = NORM B7 = HIGH B1 = URGT MT A15 F20 B9 = NORM B7 = HIGH B1 = URGT	F72 Sender to Receiver Information /SICPRIO/ plus 2-position code
Credit Transfer Transaction Information +Settlement Time Indication	SttlmTmIndctn	0..1	0..1	Settlement Indication Used in messages from SIC4 to the participant to state the effective settlement time and the value date when the payment was booked on the settlement account. May optionally be used in the message from the participant to SIC4 to specify the earliest settlement time.			



ISO 20022 Standard			Swiss ISO 20022 Payments Standard				
Message Item	XML Tag	Mult.	Mult.	Definition	Payment Type-specific Definition	SIC A10/A11/A15	SWIFT MT103
Credit Transfer Transaction Information +Settlement Time Indication ++Debit Date Time	DbtDtTm	0..1	0..1	<p>Earliest Settlement Time SIC4: May be used by the debtor agent to specify the preferred settlement time. Must contain a valid calendar date and a valid time. If the specified time is before the time the message was received by SIC, it will be replaced by the reception time. The calendar date/time must be within the clearing day specified as the requested settlement date. The time must not be between clearing stop 1 and clearing stop 3 of the clearing day. Payments with an earliest settlement time are rejected if their value date would have to be adjusted because the requested settlement date cannot be fulfilled.</p>			
Credit Transfer Transaction Information +Settlement Time Indication ++Credit Date Time	CdtDtTm	0..1	0..1	<p>Credit Date Time Only used in messages from SIC4 to the participant. The settlement date is always the SNB/SECB value date on which the payment will be booked on the sight deposit account. The settlement time is set after final settlement.</p>		<p>MT A10 F92A Settlement Date Format = 8d MT A10 F92A Settlement Time Format = 6t MT A11 F92A Settlement Date Format = 8d MT A11 F92A Settlement Time Format = 6t MT A15 F92A Settlement Date Format = 8d MT A15 F92A Settlement Time Format = 6t</p>	<p>Header Block 3 F108: Settlement Date/Time Input to SWIFT: Format YYMMDD/HHMMSS</p>



ISO 20022 Standard			Swiss ISO 20022 Payments Standard				
Message Item	XML Tag	Mult.	Mult.	Definition	Payment Type-specific Definition	SIC A10/A11/A15	SWIFT MT103
Credit Transfer Transaction Information +Instructed Amount	InstdAmt	0..1	0..1	Instructed Amount and Currency Instructed amount before the deduction of charges and/or conversion from a foreign currency incl. currency. If used, <XchgRate> must also be present. Must contain no more than 14 digits (excl. decimal separator), including a maximum of 5 fractional digits. If used, amount must be >0.	OUTPMT: Must be used. Only "CHF" permitted. SEPPMT: Must not be used.	MT A10 F54 Amount Format = 15amt MT A11 F54 Amount Format = 15amt MT A15 F54 Amount Format = 15amt	F33B Instructed Amount
	Ccy			Currency Code Must contain a valid currency code according to ISO 4217.	OUTPMT: Only "CHF" permitted.	MT A10 F54 Currency MT A11 F54 Currency MT A15 F54 Currency	F33B Currency
Credit Transfer Transaction Information +Exchange Rate	XchgRate	0..1	0..1	Exchange Rate Exchange rate (foreign currency to CHF or EUR) of the instructed amount in the <InstdAmt> element. If used, <InstdAmt> must also be present.	SEPPMT: Must not be used.	MT A10 F54 Exchange Rate Format = 12x MT A11 F54 Exchange Rate Format = 12x MT A15 F54 Exchange Rate Format = 12x	F36 Exchange Rate

ISO 20022 Standard			Swiss ISO 20022 Payments Standard				
Message Item	XML Tag	Mult.	Mult.	Definition	Payment Type-specific Definition	SIC A10/A11/A15	SWIFT MT103
Credit Transfer Transaction Information +Charge Bearer	ChrgBr	1..1	1..1	<p>Charge Bearer CRED = All charges are charged to the creditor (= BEN) DEBT = All charges are charged to the debtor; the creditor receives the full instructed amount (= OUR) SHAR = Charges of the debtor agent are charged to the debtor; all other charges are charged to the creditor (= SHA) SLEV = Service Level Agreement, mandatory for SEPA payments (not permitted for other payment types)</p> <p>Note: If no explicit charge bearer is required, the code "SHAR" is regarded as the default value. If the code "SHAR" is used with no charges information in the <ChrgsInf> element, then the optional charge bearer is not used in case of conversions to a SIC message type.</p>	OUTPMT: Only charge bearer "DEBT" permitted. SEPPMT: Only charge bearer "SLEV" permitted.	<p>MT A10 F55A Conversion SIC – ISO required (SHA = SHAR, OUR = DEBT) MT A10 F55B Code Conversion SIC – ISO required (OUR = DEBT) MT A10 F55C Code Conversion SIC – ISO required (SHA = SHAR, BEN = CRED) MT A11 F55A Conversion SIC – ISO required (SHA = SHAR, OUR = DEBT) MT A11 F55B Code Conversion SIC – ISO required (OUR = DEBT) MT A11 F55C Code Conversion SIC – ISO required (SHA = SHAR, BEN = CRED) MT A15 F55A Conversion SIC – ISO required (SHA = SHAR, OUR = DEBT) MT A15 F55B Code Conversion SIC – ISO required (OUR = DEBT) MT A15 F55C Code Conversion SIC – ISO required (SHA = SHAR, BEN = CRED)</p>	<p>F71A Details of Charges Option "OUR", if SWIFT F71G is filled in and option "BEN" or "SHAR", if SWIFT F71F is filled in</p>
Credit Transfer Transaction Information +Charges Information	ChrgsInf	0..n	0..4	<p>Charges Information If <ChrgBr> = CRED: Must be used at least once, may be used max. 4 times. If <ChrgBr> = DEBT: May be used max. once. If <ChrgBr> = SHAR: May be used max. 4 times. If <ChrgBr> = SLEV: Must not be used.</p>	OUTPMT: Must be used. SEPPMT: Must not be used.		

ISO 20022 Standard			Swiss ISO 20022 Payments Standard				
Message Item	XML Tag	Mult.	Mult.	Definition	Payment Type-specific Definition	SIC A10/A11/A15	SWIFT MT103
Credit Transfer Transaction Information +Charges Information ++Amount	Amt	1..1	1..1	Charges Amount and Currency Must contain no more than 14 digits (excl. decimal separator), including a maximum of 5 fractional digits. If used, amount must be >0.	OUTPMT: Charges amount must be correctly calculated according to the PostFinance tariff. The calculation is based on the instructed payment amount in the <InstdAmt> element. It is also checked whether the settlement amount <IntrBkStlmAmt> is equal to the total of the instructed payment amount <InstdAmt> plus the charges amount <ChrgsInf><Amt>.	MT A10 F55B Amount Format = 15amt MT A10 F55C Amount Format = 15amt MT A10 F55C Inter- mediary Bank Amount Format = 15amt MT A11 F55B Amount Format = 15amt MT A11 F55C Amount Format = 15amt MT A11 F55C Inter- mediary Bank Amount Format = 15amt MT A15 F55B Amount Format = 15amt MT A15 F55C Amount Format = 15amt MT A15 F55C Inter- mediary Bank Amount Format = 15amt	F71F Sender's Charges Amount F71G Receiver's Charges Amount
	Ccy			Currency Code If <ChrgBr> = DEBT: The currency code must be "CHF" or "EUR" and must correspond to the currency in the respective RTGS system.	OUTPMT: Only "CHF" permitted.	MT A10 F55B Currency MT A10 F55C Currency MT A10 F55C Inter- mediary Bank Currency MT A11 F55B Currency MT A11 F55C Currency MT A11 F55C Inter- mediary Bank Currency MT A15 F55B Currency MT A15 F55C Currency MT A15 F55C Inter- mediary Bank Currency	F71F Sender's Charges Currency F71G Receiver's Charges Currency

ISO 20022 Standard			Swiss ISO 20022 Payments Standard				
Message Item	XML Tag	Mult.	Mult.	Definition	Payment Type-specific Definition	SIC A10/A11/A15	SWIFT MT103
Credit Transfer Transaction Information +Charges Information ++Party	Pty	1..1	1..1	Charges Receiver If no information can be given about the party bearing the charges, the element <Pty><FinInstnId><Nm> may be filled with the value "NOTPROVIDED". TRUNCATION: In the case of conversion to a SIC/FIN message type, this element cannot be forwarded.			
Credit Transfer Transaction Information +Intermediary Agent 1	IntrmyAgt1	0..1	0..1	Intermediary Agent Can generally be addressed using any kind of identification. The sub-elements <BIC> and <ClrSysMmbld> must not be used at the same time. A full address including the <Nm> and <PstlAdr> elements may also be provided. The following rules must be taken into account: a) If <BIC> is used, the indication of <Nm> / <PstlAdr> is not permitted. b) <PstlAdr> is only permitted together with <Nm>. c) <Nm> may also be used without <PstlAdr>. If present, <CdtrAgt> must not be identical with <InstAgt>. TRUNCATION: In the case of conversion to a SIC/FIN message type, this data might not be fully transmitted under any circumstances. If the length of the content of all the sub-elements of <IntrmyAgt1> exceeds 140 characters, it cannot be guaranteed that the information will be forwarded in full. If the format "IS reference number" is selected for the creditor's account, then this element cannot be forwarded during conversion to a SIC/FIN message type. It is recommended that the element is not used.	ESRDEB: Must not be used. ESRPMT: Must not be used. IPIDEB: Must not be used. OUTPMT: Must not be used. SEPPMT: Must not be used. SLRPMT: Must not be used.		
Credit Transfer Transaction Information +Intermediary Agent 1 ++Financial Institution Identification	FinInstnId	1..1	1..1				



ISO 20022 Standard			Swiss ISO 20022 Payments Standard				
Message Item	XML Tag	Mult.	Mult.	Definition	Payment Type-specific Definition	SIC A10/A11/A15	SWIFT MT103
Credit Transfer Transaction Information +Intermediary Agent 1 ++Financial Institution Identification +++BIC	BIC	0..1	0..1	Intermediary Agent Identification (BIC) SWIFT address with 8 or 11 alphanumeric characters. Must contain a valid value according to ISO 9362. This element must not be used at the same time as <ClrSysMmbld>.		MT A11 F40S	F56A Intermediary Institution Identifier Code (BIC)
Credit Transfer Transaction Information +Intermediary Agent 1 ++Financial Institution Identification +++Clearing System Member Identification	ClrSysMmbld	0..1	0..1	Intermediary Agent Identification (proprietary) This element must not be used at the same time as <BIC>.			
Credit Transfer Transaction Information +Intermediary Agent 1 ++Financial Institution Identification +++Clearing System Member Identification ++++Clearing System Identification	ClrSysId	0..1	1..1	Clearing System Identification Must be used to unambiguously identify the address type.			
Credit Transfer Transaction Information +Intermediary Agent 1 ++Financial Institution Identification +++Clearing System Member Identification ++++Clearing System Identification +++++Code	Cd	1..1	1..1	Clearing System Identification (code) Permitted ISO code values according to the External Code List.			
Credit Transfer Transaction Information +Intermediary Agent 1 ++Financial Institution Identification +++Clearing System Member Identification ++++Clearing System Identification +++++Proprietary	Prtry	1..1	1..1	Clearing System Identification (proprietary)			
Credit Transfer Transaction Information +Intermediary Agent 1 ++Financial Institution Identification +++Clearing System Member Identification ++++Member Identification	Mmbld	1..1	1..1	Member Identification			



ISO 20022 Standard			Swiss ISO 20022 Payments Standard				
Message Item	XML Tag	Mult.	Mult.	Definition	Payment Type-specific Definition	SIC A10/A11/A15	SWIFT MT103
Credit Transfer Transaction Information +Intermediary Agent 1 ++Financial Institution Identification +++Name	Nm	0..1	0..1	Agent Name Must not be used together with <BIC>.		MT A11 F40A Line 1 = <Nm>	F56D Intermediary Institution Name and Address Line 1 = <Nm>
Credit Transfer Transaction Information +Intermediary Agent 1 ++Financial Institution Identification +++Postal Address	PstlAdr	0..1	0..1	Agent Address Must be used in combination with <Nm>. Must not be used together with <BIC>. Using the structured elements <StrtNm> / <BldgNb> / <PstCd> / <TwnNm> at the same time as the unstructured element <AdrLine> is not permitted.			
Credit Transfer Transaction Information +Intermediary Agent 1 ++Financial Institution Identification +++Postal Address ++++Street Name	StrtNm	0..1	0..1	Street Name			
Credit Transfer Transaction Information +Intermediary Agent 1 ++Financial Institution Identification +++Postal Address ++++Building Number	BldgNb	0..1	0..1	Building Number			
Credit Transfer Transaction Information +Intermediary Agent 1 ++Financial Institution Identification +++Postal Address ++++Postcode	PstCd	0..1	0..1	Postcode			
Credit Transfer Transaction Information +Intermediary Agent 1 ++Financial Institution Identification +++Postal Address ++++Town Name	TwnNm	0..1	0..1	Town Name			
Credit Transfer Transaction Information +Intermediary Agent 1 ++Financial Institution Identification +++Postal Address ++++Country	Ctry	0..1	0..1	Country			



ISO 20022 Standard			Swiss ISO 20022 Payments Standard				
Message Item	XML Tag	Mult.	Mult.	Definition	Payment Type-specific Definition	SIC A10/A11/A15	SWIFT MT103
Credit Transfer Transaction Information +Intermediary Agent 1 ++Financial Institution Identification +++Postal Address ++++Address Line	AdrLine	0..7	0..2	Address Line (unstructured) Maximum of 2 address lines are permitted.		MT A11 F40A Line 2-4 = <AdrLine>	F56D Intermediary Institution Name and Address Line 2-4 = <AdrLine>
Credit Transfer Transaction Information +Intermediary Agent 1Account	IntrmyAgt1Acct	0..1	0..1	Intermediary Agent Account May only be used if <IntrmyAgt1> is present. TRUNCATION: If the format "IS reference number" is selected for the creditor's account, then this element cannot be forwarded during conversion to a SIC/FIN message type. It is recommended that the element is not used.	ESRDEB: Must not be used. ESRPMT: Must not be used. IPIDEB: Must not be used. OUTPMT: Must not be used. SEPPMT: Must not be used. SLRPMT: Must not be used.		
Credit Transfer Transaction Information +Intermediary Agent 1Account ++Identification	Id	1..1	1..1				
Credit Transfer Transaction Information +Intermediary Agent 1Account ++Identification +++IBAN	IBAN	1..1	1..1	IBAN Must contain a valid IBAN according to ISO 13616. The check digit (3rd and 4th position of the IBAN) must be in the range 02 to 98.		MT A11 F39I	F56A Intermediary Institution Party Identifier If IBAN F56D Intermediary Institution Party Identifier If IBAN
Credit Transfer Transaction Information +Intermediary Agent 1Account ++Identification +++Other	Othr	1..1	1..1	Proprietary Account Format			
Credit Transfer Transaction Information +Intermediary Agent 1Account ++Identification +++Other ++++Identification	Id	1..1	1..1	Account (proprietary)		MT A11 F39A	F56A Intermediary Institution Party Identifier If not IBAN F56D Intermediary Institution Party Identifier If not IBAN



ISO 20022 Standard			Swiss ISO 20022 Payments Standard				
Message Item	XML Tag	Mult.	Mult.	Definition	Payment Type-specific Definition	SIC A10/A11/A15	SWIFT MT103
Credit Transfer Transaction Information +Ultimate Debtor	UltmtDbtr	0..1	0..1	Ultimate Debtor TRUNCATION: In the case of conversion to a SIC/FIN message type, this element cannot be forwarded. It is recommended that this element is not used and the relevant information is sent under <RmtInf>.	OUTPMT: Must not be used.		
Credit Transfer Transaction Information +Ultimate Debtor ++Name	Nm	0..1	1..1	Name Must be used. Maximum of 70 characters permitted.			
Credit Transfer Transaction Information +Ultimate Debtor ++Postal Address	PstlAdr	0..1	0..1	Postal Address Using the structured elements <StrtNm> / <BldgNb> / <PstCd> / <TwnNm> at the same time as the unstructured element <AdrLine> is not permitted.	SEPPMT: Must not be used.		
Credit Transfer Transaction Information +Ultimate Debtor ++Postal Address +++Street Name	StrtNm	0..1	0..1	Street Name			
Credit Transfer Transaction Information +Ultimate Debtor ++Postal Address +++Building Number	BldgNb	0..1	0..1	Building Number			
Credit Transfer Transaction Information +Ultimate Debtor ++Postal Address +++Postcode	PstCd	0..1	0..1	Postcode			
Credit Transfer Transaction Information +Ultimate Debtor ++Postal Address +++Town Name	TwnNm	0..1	0..1	Town Name			
Credit Transfer Transaction Information +Ultimate Debtor ++Postal Address +++Country	Ctry	0..1	0..1	Country			
Credit Transfer Transaction Information +Ultimate Debtor ++Postal Address +++Address Line	AdrLine	0..7	0..2	Address Line (unstructured) Maximum of 2 address lines are permitted.			



ISO 20022 Standard			Swiss ISO 20022 Payments Standard				
Message Item	XML Tag	Mult.	Mult.	Definition	Payment Type-specific Definition	SIC A10/A11/A15	SWIFT MT103
Credit Transfer Transaction Information +Ultimate Debtor ++Identification	Id	0..1	0..1	Identification			
Credit Transfer Transaction Information +Ultimate Debtor ++Identification +++Organisation Identification	OrgId	1..1	1..1	Organisation Identification Only <BICOrBEI> or one sub-element of <Othr> is permitted. If used, <PrvtId> must not be used.			
Credit Transfer Transaction Information +Ultimate Debtor ++Identification +++Private Identification	PrvtId	1..1	1..1	Private Identification Only <DtAndPlcOfBirth> or one sub-element from <Othr> are permitted. If used, <OrgId> must not be used.			
Credit Transfer Transaction Information +Debtor	Dbtr	1..1	1..1	Debtor Is a customer of the debtor agent. Either the sub-element <Nm> or <Id><OrgId><BICOrBEI> must be used. Exception: For SEPA payments, the sub-element <Nm> must be used and it may optionally be used together with the sub-elements <PstlAdr> and <Id>. TRUNCATION: In the case of conversion to a SIC/FIN message type, this data might not be fully transmitted under any circumstances. If the length of the content of all the sub-elements of <Dbtr> exceeds 140 characters, it cannot be guaranteed that the information will be forwarded in full.	ESRDEB: Currency CHF: Data will only be forwarded if the creditor agent does accept ISO 20022 message types. ESRPMT: Currency CHF: Data will only be forwarded if the creditor agent does accept ISO 20022 message types.		
Credit Transfer Transaction Information +Debtor ++Name	Nm	0..1	0..1	Name Maximum of 70 characters permitted. If used, <Id><OrgId><BICOrBEI> must not be used.	ESRDEB: Recommendation: "NOTPROVIDED" may be used if no information is available about the debtor. ESRPMT: Recommendation: "NOTPROVIDED" may be used if no information is available about the debtor. SEPPMT: Must be used.	MT A10 F32A Line 1 = <Nm> MT A10 F32F Content from code 1/ (Name of the Ordering Customer) MT A11 F32A Line 1 = <Nm> MT A11 F32F Content from code 1/ (Name of the Ordering Customer)	F50F Ordering Customer Name and Address Content from code 1/ (Name of the Ordering Customer) F50K Ordering Customer Name and Address Line 1 = <Nm>



ISO 20022 Standard			Swiss ISO 20022 Payments Standard				
Message Item	XML Tag	Mult.	Mult.	Definition	Payment Type-specific Definition	SIC A10/A11/A15	SWIFT MT103
Credit Transfer Transaction Information +Debtor ++Postal Address	PstlAdr	0..1	0..1	Postal Address May only be used together with <Nm>. Using the structured elements <StrtNm> / <BldgNb> / <PstCd> /<TwnNm> at the same time as the unstructured element <AdrLine> is not permitted.			
Credit Transfer Transaction Information +Debtor ++Postal Address +++Street Name	StrtNm	0..1	0..1	Street Name	SEPPMT: Must not be used.	MT A10 F32F Content from code 2/ (Address Line) MT A11 F32F Content from code 2/ (Address Line)	F50F Ordering Customer Name and Address Content from code 2/ (Address Line)
Credit Transfer Transaction Information +Debtor ++Postal Address +++Building Number	BldgNb	0..1	0..1	Building Number	SEPPMT: Must not be used.		
Credit Transfer Transaction Information +Debtor ++Postal Address +++Postcode	PstCd	0..1	0..1	Postcode	SEPPMT: Must not be used.		
Credit Transfer Transaction Information +Debtor ++Postal Address +++Town Name	TwnNm	0..1	0..1	Town Name	SEPPMT: Must not be used.	MT A10 F32F Content from code 3/ (Country and Town), part Town MT A11 F32F Content from code 3/ (Country and Town), part Town	F50F Ordering Customer Name and Address Content from code 3/ (Country and Town), part Town
Credit Transfer Transaction Information +Debtor ++Postal Address +++Country	Ctry	0..1	0..1	Country		MT A10 F32F Content from code 3/ (Country and Town), part Country MT A11 F32F Content from code 3/ (Country and Town), part Country	F50F Ordering Customer Name and Address Content from code 3/ (Country and Town) , part Country
Credit Transfer Transaction Information +Debtor ++Postal Address +++Address Line	AdrLine	0..7	0..2	Address Line (unstructured) Maximum of 2 address lines are permitted.		MT A10 F32A Line 2-4 = <AdrLine> MT A11 F32A Line 2-4 = <AdrLine>	F50K Ordering Customer Name and Address Line 2-4 = <AdrLine>



ISO 20022 Standard			Swiss ISO 20022 Payments Standard				
Message Item	XML Tag	Mult.	Mult.	Definition	Payment Type-specific Definition	SIC A10/A11/A15	SWIFT MT103
Credit Transfer Transaction Information +Debtor ++Identification	Id	0..1	0..1	Identification			
Credit Transfer Transaction Information +Debtor ++Identification +++Organisation Identification	OrgId	1..1	1..1	Organisation Identification Only <BICOrBEI> or one sub-element from <Othr> is permitted.			
Credit Transfer Transaction Information +Debtor ++Identification +++Organisation Identification ++++BICOr BEI	BICOrBEI	0..1	0..1	BIC or BEI Must contain a valid value according to ISO 9362. If used, there must be no other sub-elements under <Dbtr>. Exception: For SEPA payments, the sub-element <Nm> must be used and it may optionally be used together with the sub-elements <PstlAdr> and <Id>.		MT A10 F32S MT A11 F32S	F50A Ordering Customer Identifier Code (BIC)
Credit Transfer Transaction Information +Debtor ++Identification +++Organisation Identification ++++Other	Othr	0..n	0..1	Other Organisation Identification Maximum of 1 variation permitted. May only be used if <Nm> is present.			
Credit Transfer Transaction Information +Debtor ++Identification +++Private Identification	PrvtId	1..1	1..1	Private Identification May only be used if <Nm> is present.	SEPPMT: Only <DtAndPlcOfBirth> or one sub-element of <Othr> is permitted.		
Credit Transfer Transaction Information +Debtor ++Identification +++Private Identification ++++Date And Place Of Birth	DtAndPlcOfBirth	0..1	0..1	Date And Place Of Birth			
Credit Transfer Transaction Information +Debtor ++Identification +++Private Identification ++++Date And Place Of Birth +++++Birth Date	BirthDt	1..1	1..1	Birth Date		MT A10 F32F Content from code 4/ (Date of Birth) MT A11 F32F Content from code 4/ (Date of Birth)	F50F Ordering Customer Name and Address Content from code 4/ (Date of Birth)



ISO 20022 Standard			Swiss ISO 20022 Payments Standard				
Message Item	XML Tag	Mult.	Mult.	Definition	Payment Type-specific Definition	SIC A10/A11/A15	SWIFT MT103
Credit Transfer Transaction Information +Debtor ++Identification +++Private Identification ++++Date And Place Of Birth +++++Province Of Birth	PrvcOfBirth	0..1	0..1	Province Of Birth			
Credit Transfer Transaction Information +Debtor ++Identification +++Private Identification ++++Date And Place Of Birth +++++City Of Birth	CityOfBirth	1..1	1..1	City Of Birth		MT A10 F32F Content from code 5/ (Place of Birth), Place MT A11 F32F Content from code 5/ (Place of Birth), Place	F50F Ordering Customer Name and Address Content from code 5/ (Place of Birth), Place
Credit Transfer Transaction Information +Debtor ++Identification +++Private Identification ++++Date And Place Of Birth +++++Country Of Birth	CtryOfBirth	1..1	1..1	Country Of Birth		MT A10 F32F Content from code 5/ (Place of Birth), Country MT A11 F32F Content from code 5/ (Place of Birth), Country	F50F Ordering Customer Name and Address Content from code 5/ (Place of Birth), Country
Credit Transfer Transaction Information +Debtor ++Identification +++Private Identification ++++Other	Othr	0..n	0..4	Other Private Identification Maximum of 4 variations permitted.	SEPPMT: Maximum of 1 variation permitted.		



ISO 20022 Standard			Swiss ISO 20022 Payments Standard				
Message Item	XML Tag	Mult.	Mult.	Definition	Payment Type-specific Definition	SIC A10/A11/A15	SWIFT MT103
Credit Transfer Transaction Information +Debtor ++Identification +++Private Identification ++++Other +++++Identification	Id	1..1	1..1	Identification		MT A10 F31F Identifier from the display format 4!a/2!a/27x (Cd/Country Cd/Identifier) MT A10 F32F Content from code 6/ (Customer Identification Number) or code 7/ (National Identity Number), part Identifier or code 8/ (Additional Information) MT A11 F31F Identifier from the display format 4!a/2!a/27x (Cd/Country Cd/ Identifier) MT A11 F32F Content from code 6/ (Customer Identification Number) or code 7/ (National Identity Number), part Identifier or code 8/ (Additional Information)	F50F Ordering Customer Party Identifier (Identifier) F50F Ordering Customer Name and Address Content from code 6/ (Customer Identification Number) or code 7/ (National Identity Number), part Identifier or code 8/ (Additional Information)
Credit Transfer Transaction Information +Debtor ++Identification +++Private Identification ++++Other +++++Scheme Name	SchmeNm	0..1	0..1	Identification Type			
Credit Transfer Transaction Information +Debtor ++Identification +++Private Identification ++++Other +++++Scheme Name +++++Code	Cd	1..1	1..1	Identification Type (code) Permitted ISO code values according to the External Code List.		MT A10 F31F Cd from the display format 4!a/2!a/27x (Cd/Country Cd/Identifier) MT A10 F32F Code 6/ = CUST, Code 7/ = NIDN MT A11 F31F Cd from the display format 4!a/2!a/27x (Cd/Country Cd/Identifier) MT A11 F32F Code 6/ = CUST, Code 7/ = NIDN	F50F Ordering Customer Party Identifier (Cd) F50F Ordering Customer Name and Address Code 6/ = CUST, Code 7/ = NIDN



ISO 20022 Standard			Swiss ISO 20022 Payments Standard				
Message Item	XML Tag	Mult.	Mult.	Definition	Payment Type-specific Definition	SIC A10/A11/A15	SWIFT MT103
Credit Transfer Transaction Information +Debtor ++Identification +++Private Identification ++++Other +++++Scheme Name +++++Proprietary	Prtry	1..1	1..1	Identification Type (proprietary)		MT A10 F32F Code 8/ MT A11 F32F Code 8/	F50F Ordering Customer Name and Address Code 8/
Credit Transfer Transaction Information +Debtor ++Identification +++Private Identification ++++Other +++++Issuer	Issr	0..1	0..1	Identification Issuer		MT A10 F31F Country Code and, if present, the Issuer from the display format 4!a/2!a/27x (Cd/Country Cd/Identifier) MT A10 F32F Content from code 6/ (Customer Identification Number) or Code 7/ (National Identity Number), part Country Code and Issuer MT A11 F31F Country Code and, if present, the Issuer from the display format 4!a/2!a/27x (Cd/Country Cd/Identifier) MT A11 F32F Content from code 6/ (Customer Identification Number) or Code 7/ (National Identity Number), part Country Code and Issuer	F50F Ordering Customer Party Identifier (Country Cd) With code CUST / DRLC / EMPL: If present, the Issuer from the display format 4!a/2!a/27x (Cd/Country Cd/Issuer/Identifier) F50F Ordering Customer Name and Address Content from code 6/ (Customer Identification Number) or Code 7/ (National Identity Number), part Country Code and Issuer
Credit Transfer Transaction Information +Debtor Account	DbtrAcct	0..1	0..1	Debtor Account	SEPPMT: Must be used.		
Credit Transfer Transaction Information +Debtor Account ++Identification	Id	1..1	1..1				



ISO 20022 Standard			Swiss ISO 20022 Payments Standard				
Message Item	XML Tag	Mult.	Mult.	Definition	Payment Type-specific Definition	SIC A10/A11/A15	SWIFT MT103
Credit Transfer Transaction Information +Debtor Account ++Identification +++IBAN	IBAN	1..1	1..1	IBAN Must contain a valid IBAN according to ISO 13616. The check digit (3rd and 4th position of the IBAN) must be in the range of 02 to 98.	SEPPMT: Must be used.	MT A10 F31F Display format /34x (Account), if IBAN MT A10 F31I MT A11 F31F Display format /34x (Account), if IBAN MT A11 F31I	F50A Ordering Customer Account If IBAN F50F Ordering Customer Party Identifier (Account) If IBAN F50K Ordering Customer Account If IBAN
Credit Transfer Transaction Information +Debtor Account ++Identification +++Other	Othr	1..1	1..1	Proprietary Account Format	SEPPMT: Must not be used.		
Credit Transfer Transaction Information +Debtor Account ++Identification +++Other ++++Identification	Id	1..1	1..1	Account (proprietary)		MT A10 F31A MT A10 F31F Display format /34x (Account), if not IBAN MT A11 F31A MT A11 F31F Display format /34x (Account), if not IBAN	F50A Ordering Customer Account If not IBAN F50F Ordering Customer Party Identifier (Account) If not IBAN F50K Ordering Customer Account If not IBAN

ISO 20022 Standard			Swiss ISO 20022 Payments Standard				
Message Item	XML Tag	Mult.	Mult.	Definition	Payment Type-specific Definition	SIC A10/A11/A15	SWIFT MT103
Credit Transfer Transaction Information +Debtor Agent	DbtrAgt	1..1	1..1	Debtor Agent Can generally be addressed using any kind of identification. The sub-elements <BIC> and <ClrSysMmbld> must not be used at the same time. A full address including the <Nm> and <PstlAdr> elements may also be provided. The following rules must be taken into account: a) If <BIC> is used, <Nm> / <PstlAdr> must not be provided. b) <PstlAdr> is only permitted together with <Nm>. c) <Nm> may also be used without <PstlAdr>. TRUNCATION: In the case of conversion to a SIC/FIN message type, this data might not be fully transmitted under any circumstances. If the length of the content of all the sub-elements of <DbtrAgt> exceeds 140 characters, it cannot be guaranteed that the information will be forwarded in full.	ESRDEB: Currency CHF: Must be identical with <InstgAgt>. ESRPMT: Currency CHF: Must be identical with <InstgAgt>. OUTPMT: Must be identical with <InstgAgt>. SEPPMT: Must be a participant in the "SEPA Credit Transfer Scheme".		
Credit Transfer Transaction Information +Debtor Agent ++Financial Institution Identification	FinInstnId	1..1	1..1				
Credit Transfer Transaction Information +Debtor Agent ++Financial Institution Identification +++BIC	BIC	0..1	0..1	Debtor Agent Identification (BIC) SWIFT address with 8 or 11 alphanumeric characters. Must contain a valid value according to ISO 9362. This element must not be used at the same time as <ClrSysMmbld>.	SEPPMT: Must be used.	MT A10 F36S MT A11 F36S	Output Header Block 2: Sender's Address Output from SWIFT, if Field 52y (Ordering Institution) is not present. F52A Ordering Institution Identifier Code (BIC)
Credit Transfer Transaction Information +Debtor Agent ++Financial Institution Identification +++Clearing System Member Identification	ClrSysMmbld	0..1	0..1	Debtor Agent Identification (proprietary) This element must not be used at the same time as <BIC>.	SEPPMT: Must not be used.		



ISO 20022 Standard			Swiss ISO 20022 Payments Standard				
Message Item	XML Tag	Mult.	Mult.	Definition	Payment Type-specific Definition	SIC A10/A11/A15	SWIFT MT103
Credit Transfer Transaction Information +Debtor Agent ++Financial Institution Identification +++Clearing System Member Identification ++++Clearing System Identification	ClrSysId	0..1	1..1	Clearing System Identification Must be used to unambiguously identify the address type.			
Credit Transfer Transaction Information +Debtor Agent ++Financial Institution Identification +++Clearing System Member Identification ++++Clearing System Identification +++++Code	Cd	1..1	1..1	Clearing System Identification (code) Permitted ISO code values according to the External Code List.			
Credit Transfer Transaction Information +Debtor Agent ++Financial Institution Identification +++Clearing System Member Identification ++++Clearing System Identification +++++Proprietary	Prtry	1..1	1..1	Clearing System Identification (proprietary)			
Credit Transfer Transaction Information +Debtor Agent ++Financial Institution Identification +++Clearing System Member Identification ++++Member Identification	Mmbld	1..1	1..1	Member Identification		MT A10 F02 If field 36y (sender's address) is not present. MT A11 F02 If field 36y (sender's address) is not present.	
Credit Transfer Transaction Information +Debtor Agent ++Financial Institution Identification +++Name	Nm	0..1	0..1	Agent Name Must not be used together with <BIC>.	SEPPMT: Must not be used.	MT A10 F36A Line 1 = <Nm> MT A11 F36A Line 1 = <Nm>	F52D Ordering Institution Name and Address Line 1 = <Nm>
Credit Transfer Transaction Information +Debtor Agent ++Financial Institution Identification +++Postal Address	PstlAdr	0..1	0..1	Agent Address Must be used in combination with <Nm>. Must not be used together with <BIC>. Using the structured elements <StrtNm> / <BldgNb> / <PstCd> /<TwnNm> at the same time as the unstructured element <AdrLine> is not permitted.	SEPPMT: Must not be used.		



ISO 20022 Standard			Swiss ISO 20022 Payments Standard				
Message Item	XML Tag	Mult.	Mult.	Definition	Payment Type-specific Definition	SIC A10/A11/A15	SWIFT MT103
Credit Transfer Transaction Information +Debtor Agent ++Financial Institution Identification +++Postal Address ++++Street Name	StrtNm	0..1	0..1	Street Name			
Credit Transfer Transaction Information +Debtor Agent ++Financial Institution Identification +++Postal Address ++++Building Number	BldgNb	0..1	0..1	Building Number			
Credit Transfer Transaction Information +Debtor Agent ++Financial Institution Identification +++Postal Address ++++Postcode	PstCd	0..1	0..1	Postcode			
Credit Transfer Transaction Information +Debtor Agent ++Financial Institution Identification +++Postal Address ++++Town Name	TwnNm	0..1	0..1	Town Name			
Credit Transfer Transaction Information +Debtor Agent ++Financial Institution Identification +++Postal Address ++++Country	Ctry	0..1	0..1	Country			
Credit Transfer Transaction Information +Debtor Agent ++Financial Institution Identification +++Postal Address ++++Address Line	AdrLine	0..7	0..2	Address Line (unstructured) Maximum of 2 address lines are permitted.		MT A10 F36A Line 2-4 = <AdrLine> MT A11 F36A Line 2-4 = <AdrLine>	F52D Ordering Institution Name and Address Line 2-4 = <AdrLine>
Credit Transfer Transaction Information +Debtor Agent Account	DbtrAgtAcct	0..1	0..1	Debtor Agent Account May only be used if the instructing participant in the <InstgAgt> element does not correspond to the debtor agent in the <DbtrAgt> element.	ESRDEB: Currency CHF: Must not be used. ESRPMT: Currency CHF: Must not be used. OUTPMT: Must not be used. SEPPMT: Must not be used.		
Credit Transfer Transaction Information +Debtor Agent Account ++Identification	Id	1..1	1..1				

ISO 20022 Standard			Swiss ISO 20022 Payments Standard				
Message Item	XML Tag	Mult.	Mult.	Definition	Payment Type-specific Definition	SIC A10/A11/A15	SWIFT MT103
Credit Transfer Transaction Information +Debtor Agent Account ++Identification +++IBAN	IBAN	1..1	1..1	IBAN Must contain a valid IBAN according to ISO 13616. The check digit (3rd and 4th position of the IBAN) must be in the range of 02 to 98.		MT A10 F35I MT A11 F35I	F52A Ordering Institution Identifier If IBAN F52D Ordering Institution Identifier If IBAN
Credit Transfer Transaction Information +Debtor Agent Account ++Identification +++Other	Othr	1..1	1..1	Proprietary Account Format			
Credit Transfer Transaction Information +Debtor Agent Account ++Identification +++Other ++++Identification	Id	1..1	1..1	Account (proprietary)		MT A10 F35A MT A11 F35A	F52A Ordering Institution Identifier If not IBAN F52D Ordering Institution Identifier If not IBAN
Credit Transfer Transaction Information +Creditor Agent	CdtrAgt	1..1	1..1	Creditor Agent Can generally be addressed using any kind of identification. The sub-elements <BIC> and <ClrSysMmbld> must not be used at the same time. Alternatively, the full address including the <Nm> and <PstlAdr> elements may also be provided. The following rules must be taken into account: a) If <BIC> is used, <Nm> / <PstlAdr> must not be provided. b) <PstlAdr> is only permitted together with <Nm>. c) <Nm> may also be used without <PstlAdr>. Must not be identical with <InstdAgt>, if <IntrmyAgt1> is present. TRUNCATION: In the case of conversion to a SIC/FIN message type, this data might not be fully transmitted under any circumstances. If the length of the content of all the sub-elements of <CdtrAgt> exceeds 140 characters, it cannot be guaranteed that the information will be forwarded in full.	CSTPMT: Must be identical with <InstdAgt>, if an "IS reference number" is used to specify the creditor account. ESRDEB: Must be identical with <InstdAgt>. ESRPMT: Must be identical with <InstdAgt>. IPIDEB: Must be identical with <InstdAgt>. OUTPMT: Must be identical with <InstdAgt>. SLRPMT: Must be identical with <InstdAgt>. SEPPMT: Must be a participant in the "SEPA Credit Transfer Scheme".		



ISO 20022 Standard			Swiss ISO 20022 Payments Standard				
Message Item	XML Tag	Mult.	Mult.	Definition	Payment Type-specific Definition	SIC A10/A11/A15	SWIFT MT103
Credit Transfer Transaction Information +Creditor Agent ++Financial Institution Identification	FinInstnId	1..1	1..1				
Credit Transfer Transaction Information +Creditor Agent ++Financial Institution Identification +++BIC	BIC	0..1	0..1	Creditor Agent Identification (BIC) SWIFT address with 8 or 11 alphanumeric characters. Must contain a valid value according to ISO 9362. This element must not be used at the same time as <ClrSysMmbld>.	SEPPMT: Must be used.	MT A11 F42S	F57A Account with Institution Identifier Code (BIC)
Credit Transfer Transaction Information +Creditor Agent ++Financial Institution Identification +++Clearing System Member Identification	ClrSysMmbld	0..1	0..1	Creditor Agent Identification (proprietary) This element must not be used at the same time as <BIC>.	SEPPMT: Must not be used.		
Credit Transfer Transaction Information +Creditor Agent ++Financial Institution Identification +++Clearing System Member Identification ++++Clearing System Identification	ClrSysId	0..1	1..1	Clearing System Identification Must be used to unambiguously identify the address type.			
Credit Transfer Transaction Information +Creditor Agent ++Financial Institution Identification +++Clearing System Member Identification ++++Clearing System Identification +++++Code	Cd	1..1	1..1	Clearing System Identification (code) Permitted ISO code values according to the External Code List.			
Credit Transfer Transaction Information +Creditor Agent ++Financial Institution Identification +++Clearing System Member Identification ++++Clearing System Identification +++++Proprietary	Prtry	1..1	1..1	Clearing System Identification (proprietary)			
Credit Transfer Transaction Information +Creditor Agent ++Financial Institution Identification +++Clearing System Member Identification ++++Member Identification	Mmbld	1..1	1..1	Member Identification		MT A10 F18 MT A11 F18 If Field 42y (Account-with-bank) is not present MT A15 F18	



ISO 20022 Standard			Swiss ISO 20022 Payments Standard				
Message Item	XML Tag	Mult.	Mult.	Definition	Payment Type-specific Definition	SIC A10/A11/A15	SWIFT MT103
Credit Transfer Transaction Information +Creditor Agent ++Financial Institution Identification +++Name	Nm	0..1	0..1	Agent Name Must not be used together with <BIC>.	ESRDEB: Must not be used. ESRPMT: Must not be used. IPIDEB: Must not be used. OUTPMT: Must not be used. SEPPMT: Must not be used. SLRPMT: Must not be used.	MT A11 F42A Line 1 = <Nm>	F57D Account with Institution Name and Address Line 1 = <Nm>
Credit Transfer Transaction Information +Creditor Agent ++Financial Institution Identification +++Postal Address	PstlAdr	0..1	0..1	Agent Address Must be used in combination with <Nm>. Must not be used together with <BIC>. Using the structured elements <StrtNm> / <BldgNb> / <PstCd> / <TwnNm> at the same time as the unstructured element <AdrLine> is not permitted.	ESRDEB: Must not be used. ESRPMT: Must not be used. IPIDEB: Must not be used. OUTPMT: Must not be used. SEPPMT: Must not be used. SLRPMT: Must not be used.		
Credit Transfer Transaction Information +Creditor Agent ++Financial Institution Identification +++Postal Address ++++Street Name	StrtNm	0..1	0..1	Street Name			
Credit Transfer Transaction Information +Creditor Agent ++Financial Institution Identification +++Postal Address ++++Building Number	BldgNb	0..1	0..1	Building Number			
Credit Transfer Transaction Information +Creditor Agent ++Financial Institution Identification +++Postal Address ++++Postcode	PstCd	0..1	0..1	Postcode			
Credit Transfer Transaction Information +Creditor Agent ++Financial Institution Identification +++Postal Address ++++Town Name	TwnNm	0..1	0..1	Town Name			
Credit Transfer Transaction Information +Creditor Agent ++Financial Institution Identification +++Postal Address ++++Country	Ctry	0..1	0..1	Country			



ISO 20022 Standard			Swiss ISO 20022 Payments Standard				
Message Item	XML Tag	Mult.	Mult.	Definition	Payment Type-specific Definition	SIC A10/A11/A15	SWIFT MT103
Credit Transfer Transaction Information +Creditor Agent ++Financial Institution Identification +++Postal Address ++++Address Line	AdrLine	0..7	0..2	Address Line (unstructured) Maximum of 2 address lines are permitted.		MT A11 F42A Line 2-4 = <AdrLine>	F57B Account with Institution Location F57D Account with Institution Name and Address Line 2-4 = <AdrLine>
Credit Transfer Transaction Information +Creditor Agent Account	CdtrAgtAcct	0..1	0..1	Creditor Agent Account May only be used if the instructed participant in the <InstdAgt> element does not correspond to the creditor agent in the <CdtrAgt> element.	ESRDEB: Must not be used. ESRPMT: Must not be used. IPIDEB: Must not be used. OUTPMT: Must not be used. SEPPMT: Must not be used. SLRPMT: Must not be used.		
Credit Transfer Transaction Information +Creditor Agent Account ++Identification	Id	1..1	1..1				
Credit Transfer Transaction Information +Creditor Agent Account ++Identification +++IBAN	IBAN	1..1	1..1	IBAN Must contain a valid IBAN according to ISO 13616. The check digit (3rd and 4th position of the IBAN) must be in the range of 02 to 98.		MT A11 F41I	F57A Account with Institution Party Identifier If IBAN F57B Account with Institution Party Identifier If IBAN F57D Account with Institution Party Identifier If IBAN
Credit Transfer Transaction Information +Creditor Agent Account ++Identification +++Other	Othr	1..1	1..1	Proprietary Account Format			



ISO 20022 Standard			Swiss ISO 20022 Payments Standard				
Message Item	XML Tag	Mult.	Mult.	Definition	Payment Type-specific Definition	SIC A10/A11/A15	SWIFT MT103
Credit Transfer Transaction Information +Creditor Agent Account ++Identification +++Other ++++Identification	Id	1..1	1..1	Account (proprietary)		MT A11 F41A	F57A Account with Institution Party Identifier If not IBAN F57B Account with Institution Party Identifier If not IBAN F57C Account with Institution Party Identifier F57D Account with Institution Party Identifier If not IBAN
Credit Transfer Transaction Information +Creditor	Cdtr	1..1	1..1	Creditor Is a customer of the creditor agent. Either the sub-element <Nm> or <Id><OrgId><BICOrBEI> must be used. Exception: For SEPA payments, the use of the sub-element <Nm> is mandatory and it may optionally be used together with the sub-elements <PstlAdr> and <Id>. TRUNCATION: In the case of conversion to a SIC/FIN message type, this data might not be fully transmitted under any circumstances. If the length of the content of all the sub-elements of <Cdtr> exceeds 140 characters, it cannot be guaranteed that the information will be forwarded in full.	ESRDEB: Currency CHF: Data will only be forwarded if the creditor agent does accept ISO 20022 message types. ESRPMT: Currency CHF: Data will only be forwarded if the creditor agent does accept ISO 20022 message types		
Credit Transfer Transaction Information +Creditor ++Name	Nm	0..1	0..1	Name Maximum of 70 characters permitted. If used, <Id><OrgId><BICOrBEI> must not be used.	ESRDEB: Recommendation: "NOTPROVIDED" may be used if no information is available about the creditor. ESRPMT: Recommendation: "NOTPROVIDED" may be used if no information is available about the creditor. SEPPMT: Must be used.	MT A10 F46A Line 1 = <Nm> MT A10 F46D Line 1 = <Nm> MT A11 F46A Line 1 = <Nm>	F59 Beneficiary Customer Name and Address Line 1 = <Nm>



ISO 20022 Standard			Swiss ISO 20022 Payments Standard				
Message Item	XML Tag	Mult.	Mult.	Definition	Payment Type-specific Definition	SIC A10/A11/A15	SWIFT MT103
Credit Transfer Transaction Information +Creditor ++Postal Address	PstlAdr	0..1	0..1	Postal Address May only be used if <Nm> is present. Using the structured elements <StrtNm> / <BldgNb> / <PstCd> / <TwnNm> at the same time as the unstructured element <AdrLine> is not permitted.	OUTPMT: Must be present.		
Credit Transfer Transaction Information +Creditor ++Postal Address +++Street Name	StrtNm	0..1	0..1	Street Name	SEPPMT: Must not be used.	MT A10 F46D Lines 2 / 3 = <StrtNm>	
Credit Transfer Transaction Information +Creditor ++Postal Address +++Building Number	BldgNb	0..1	0..1	Building Number	SEPPMT: Must not be used.		
Credit Transfer Transaction Information +Creditor ++Postal Address +++Postcode	PstCd	0..1	0..1	Postcode	SEPPMT: Must not be used. OUTPMT: Must be present (CH or LI postcode)	MT A10 F46D Line 4, part Postcode = <PstCd>	
Credit Transfer Transaction Information +Creditor ++Postal Address +++Town Name	TwnNm	0..1	0..1	Town Name	SEPPMT: Must not be used. OUTPMT: Must be present.	MT A10 F46D Line 4, part Town = <TwnNm>	
Credit Transfer Transaction Information +Creditor ++Postal Address +++Country	Ctry	0..1	0..1	Country	OUTPMT: May only include "CH" or "LI".		
Credit Transfer Transaction Information +Creditor ++Postal Address +++Address Line	AdrLine	0..7	0..2	Address Line (unstructured) Maximum of 2 address lines are permitted.	OUTPMT: Must not be used.	MT A10 F46A Line 2-4 = <AdrLine> MT A11 F46A Line 2-4 = <AdrLine>	F59 Beneficiary Customer Name and Address Line 2-4 = <AdrLine>
Credit Transfer Transaction Information +Creditor ++Identification	Id	0..1	0..1	Identification	OUTPMT: Must not be used.		
Credit Transfer Transaction Information +Creditor ++Identification +++Organisation Identification	OrgId	1..1	1..1	Organisation Identification Only <BICOrBEI> or one sub-element of <Othr> is permitted.			



ISO 20022 Standard			Swiss ISO 20022 Payments Standard				
Message Item	XML Tag	Mult.	Mult.	Definition	Payment Type-specific Definition	SIC A10/A11/A15	SWIFT MT103
Credit Transfer Transaction Information +Creditor ++Identification +++Organisation Identification ++++BICOr BEI	BICOrBEI	0..1	0..1	BIC or BEI Must contain a valid value according to ISO 9362. If used, there must be no other sub-elements under <Ctr>. Exception: For SEPA payments, the sub-element <Nm> must be used and it may optionally be used together with the sub-elements <PstlAdr> and <Id>.		MT A10 F46S MT A11 F46S	F59A Beneficiary Customer Identifier Code (BIC)
Credit Transfer Transaction Information +Creditor ++Identification +++Organisation Identification ++++Other	Othr	0..n	0..1	Other Organisation Identification Maximum of 1 occurrence permitted. May only be used if <Nm> is present.			
Credit Transfer Transaction Information +Creditor ++Identification +++Private Identification	PrvtId	1..1	1..1	Private Identification Only <DtAndPlcOfBirth> or one sub-element from <Othr> is permitted. May only be used if <Nm> is present.			
Credit Transfer Transaction Information +Creditor ++Identification +++Private Identification ++++Date And Place Of Birth	DtAndPlcOfBirth	0..1	0..1	Date And Place Of Birth			
Credit Transfer Transaction Information +Creditor ++Identification +++Private Identification ++++Other	Othr	0..n	0..1	Other Private Identification Maximum of 1 variation permitted.			
Credit Transfer Transaction Information +Creditor Account	CdtrAcct	0..1	0..1	Creditor Account	ESRDEB: Must be used. ESRPMT: Must be used. IPIDEB: Must be used. SEPPMT: Must be used. OUTPMT: Must not be used.		
Credit Transfer Transaction Information +Creditor Account ++Identification	Id	1..1	1..1				



ISO 20022 Standard			Swiss ISO 20022 Payments Standard					
Message Item	XML Tag	Mult.	Mult.	Definition	Payment Type-specific Definition	SIC A10/A11/A15		SWIFT MT103
Credit Transfer Transaction Information +Creditor Account ++Identification +++IBAN	IBAN	1..1	1..1	IBAN Must contain a valid IBAN according to ISO 13616. The check digit (3rd and 4th position of the IBAN) must be in the range of 02 to 98.	ESRDEB: Must not be used. ESRPMT: Must not be used. IPIDEB: Must be used. SEPPMT: Must be used.	MT A10 F45I MT A11 F45I		F59 Beneficiary Customer Account If IBAN F59A Beneficiary Customer Account If IBAN
Credit Transfer Transaction Information +Creditor Account ++Identification +++Other	Othr	1..1	1..1	Proprietary Account Format	ESRDEB: Must be used. ESRPMT: Must be used. IPIDEB: Must not be used. SEPPMT: Must not be used.			
Credit Transfer Transaction Information +Creditor Account ++Identification +++Other ++++Identification	Id	1..1	1..1	Account (proprietary) The account number is individually checked on the basis of the code entry for the type given in <SchmeNm><Prtry>: PRTRY = Max. 34 character account number, conventional format PCACC = Postal account number complying with the following requirements: - Mandatory 9-digit numerical value (no hyphens), constructed as follows: VV999999P - VV = Leading characters, any value in the range 00 to 99 - 999999 = Ordinal number: If < 6-digits, left-padded with zeros, but must be >000000 - P = Check digit according to Modulo 10, recursive ESRPT = ISR participation number complying with the following requirements: - Mandatory 9-digit numerical value (no hyphens), constructed as follows: VV999999P - VV = Leading characters, permitted values: 01 03 - 999999 = Ordinal number: If < 6-digits, left-padded with zeros, but must be >000000 - P = Check digit according to Modulo 10, recursive PSREF = IS reference number complying with the following requirements: - Mandatory 27-digit numerical value from the IS code line - Check digit in the last position according to Modulo 10, recursive	CSTPMT: Currency CHF: Only conventional format, postal account number or IS reference number permitted. Currency EUR: Only conventional format or postal account number permitted. ESRDEB: Only ISR participant number permitted. Currency CHF: Only leading characters 01 permitted. Currency EUR: Only leading characters 01 or 03 permitted. ESRPMT: Only ISR participant number permitted. Currency CHF: Only leading characters 01 permitted. Currency EUR: Only leading characters 03 permitted. SLRPMT: Currency CHF: Only conventional format, postal account number or IS reference number permitted. Currency EUR: Only conventional format or postal account number permitted.	MT A10 F45A MT A10 F45C MT A10 F45E MT A11 F45A MT A11 F45C MT A15 F45D	F59 Beneficiary Customer Account If not IBAN F59A Beneficiary Customer Account If not IBAN	



ISO 20022 Standard			Swiss ISO 20022 Payments Standard				
Message Item	XML Tag	Mult.	Mult.	Definition	Payment Type-specific Definition	SIC A10/A11/A15	SWIFT MT103
Credit Transfer Transaction Information +Creditor Account ++Identification +++Other ++++Scheme Name	SchmeNm	0..1	1..1	Account Type Must be used to unambiguously identify the account number type.			
Credit Transfer Transaction Information +Creditor Account ++Identification +++Other ++++Scheme Name +++++Code	Cd	1..1	1..1	SIC4: Must not be used.			
Credit Transfer Transaction Information +Creditor Account ++Identification +++Other ++++Scheme Name +++++Proprietary	Prtry	1..1	1..1	Account Type The following code values are available: PRTRY = Conventional format PCACC = Postal account number ESRPT = ISR participant number PSREF = IS reference number	CSTPMT: Currency CHF: Only PRTRY, PCACC and PSREF permitted. Currency EUR: Only PRTRY and PCACC permitted. ESRDEB: Only ESRPT permitted. ESRPMT: Only ESRPT permitted. SLRPMT: Currency CHF: Only PRTRY, PCACC and PSREF permitted. Currency EUR: Only PRTRY and PCACC permitted.		
Credit Transfer Transaction Information +Ultimate Creditor	UltmtCdtr	0..1	0..1	Ultimate Creditor TRUNCATION: In the case of conversion to a SIC/FIN message type, this element cannot be forwarded. It is recommended that this element is not used and the relevant information is sent under <RmtInf>.			
Credit Transfer Transaction Information +Ultimate Creditor ++Name	Nm	0..1	1..1	Name Must be used. Maximum of 70 characters permitted.			
Credit Transfer Transaction Information +Ultimate Creditor ++Postal Address	PstlAdr	0..1	0..1	Postal Address Using the structured elements <StrtNm> / <BldgNb> / <PstCd> /<TwnNm> at the same time as the unstructured element <AdrLine> is not permitted.	SEPPMT: Must not be used.		
Credit Transfer Transaction Information +Ultimate Creditor ++Postal Address +++Street Name	StrtNm	0..1	0..1	Street Name			



ISO 20022 Standard			Swiss ISO 20022 Payments Standard				
Message Item	XML Tag	Mult.	Mult.	Definition	Payment Type-specific Definition	SIC A10/A11/A15	SWIFT MT103
Credit Transfer Transaction Information +Ultimate Creditor ++Postal Address +++Building Number	BldgNb	0..1	0..1	Building Number			
Credit Transfer Transaction Information +Ultimate Creditor ++Postal Address +++Postcode	PstCd	0..1	0..1	Postcode			
Credit Transfer Transaction Information +Ultimate Creditor ++Postal Address +++Town Name	TwnNm	0..1	0..1	Town Name			
Credit Transfer Transaction Information +Ultimate Creditor ++Postal Address +++Country	Ctry	0..1	0..1	Country			
Credit Transfer Transaction Information +Ultimate Creditor ++Postal Address +++Address Line	AdrLine	0..7	0..2	Address Line (unstructured) Maximum of 2 address lines are permitted.			
Credit Transfer Transaction Information +Ultimate Creditor ++Identification	Id	0..1	0..1	Identification			
Credit Transfer Transaction Information +Ultimate Creditor ++Identification +++Organisation Identification	OrgId	1..1	1..1	Organisation Identification Only <BICOrBEI> or one sub-element of <Othr> is permitted. If used, <PrvtId> must not be used.			
Credit Transfer Transaction Information +Ultimate Creditor ++Identification +++Private Identification	PrvtId	1..1	1..1	Private Identification Only <DtAndPlcOfBirth> or one sub-element of <Othr> is permitted. If used, <OrgId> must not be used.			

ISO 20022 Standard			Swiss ISO 20022 Payments Standard				
Message Item	XML Tag	Mult.	Mult.	Definition	Payment Type-specific Definition	SIC A10/A11/A15	SWIFT MT103
Credit Transfer Transaction Information +Instruction For Creditor Agent	InstrForCdtrAgt	0..n	0..n	<p>Instruction For Creditor Agent / Instruction Code Element is used for giving instructions to the creditor agent or instructed participant, either in structured form as a SWIFT Instruction Code or unstructured.</p> <p>Sending a SWIFT Instruction Code (reflecting SWIFT Field 23E / SIC Field 57E):</p> <ul style="list-style-type: none"> - This element cannot be used more than five times. - Version a): SWIFT Instruction Code in the sub-element <Cd> (CHQB,HOLD,PHOB,TELB) with Additional Information in the sub-element <InstrInf>. - Version b) for code values that are not permitted under <Cd> (SDVA,INTC,REPA,CORT,PHON,TELE,PHOI,TELI): Sub-element <Cd> must not be used, delivery of SWIFT Instruction Code and SWIFT Additional Information in sub-element <InstrInf>, format in accordance with SWIFT Format Specifications 23E. - If the following SWIFT Instruction Codes are used, dependencies with other elements must also be taken into account: CHQB: <CdrAcct> must not be used. TELE / PHON: <CdrAgt> must be different from <InstdAgt>. TELI / PHOI: May only be used if <IntrmyAgt1> is present. - Validation of permitted code combinations is done in accordance with SWIFT Field Specifications 23E. <p>Use of an instruction for the creditor agent (unstructured, reflects SWIFT Field 72 / SIC Field 53):</p> <ul style="list-style-type: none"> - The element must not be used more than twice. - Sub-element <Cd> must not be used. - Sub-element <InstrInf> must not start with a SWIFT Instruction Code. 	<p>ESRDEB: Must not be used. ESRPMT: Must not be used. IPIDEB: Must not be used. OUTPMT: Must not be used. SEPPMT: Must not be used. SLRPMT: Must not be used.</p>	<p>MT A11 F53 MT A11 F57E</p>	<p>F23E Instruction Code F72 Sender to Receiver Information</p>



ISO 20022 Standard			Swiss ISO 20022 Payments Standard				
Message Item	XML Tag	Mult.	Mult.	Definition	Payment Type-specific Definition	SIC A10/A11/A15	SWIFT MT103
				TRUNCATION: In the case of conversion to a SIC/FIN message type, this data might not be fully transmitted under any circumstances. If the format "IS reference number" is selected for the creditor's account, then this element cannot be forwarded during conversion to a SIC/FIN message type. It is recommended that the element is not used.			
Credit Transfer Transaction Information +Instruction For Creditor Agent ++Code	Cd	0..1	0..1	Instruction Code			
Credit Transfer Transaction Information +Instruction For Creditor Agent ++Instruction Information	InstrInf	0..1	0..1	Instruction for Creditor Agent (text)			
Credit Transfer Transaction Information +Instruction For Next Agent	InstrForNxtAgt	0..n	0..n	Processing Instruction Element is used for sending system-specific instructions from the instructing participant to SIC4. The element must not be used more than three times. Only one instruction may be present in each variation. The same instructions must not be provided more than once.	ESRDEB: Maximum of 2 occurrences permitted. ESRPMT: Maximum of 2 occurrences permitted. IPIDEB: Maximum of 2 occurrences permitted. OUTPMT: Maximum of 2 occurrences permitted. SEPPMT: Maximum of 2 occurrences permitted. SLRPMT: Maximum of 2 occurrences permitted. CSTPMT: CHF: Maximum of 2 occurrences permitted. EUR: Maximum of 3 occurrences permitted.		
Credit Transfer Transaction Information +Instruction For Next Agent ++Code	Cd	0..1	0..1	Processing Instruction (code) Element must not be used.			



ISO 20022 Standard			Swiss ISO 20022 Payments Standard				
Message Item	XML Tag	Mult.	Mult.	Definition	Payment Type-specific Definition	SIC A10/A11/A15	SWIFT MT103
Credit Transfer Transaction Information +Instruction For Next Agent ++Instruction Information	InstrInf	0..1	0..1	Processing Instruction (text) The following values are permitted for processing instructions in SIC4: CONF = Settlement confirmation request. After settlement of the payment a settlement confirmation will be issued to the participant being debited. LIQU = Request to use reserved liquidity. Liquidity reserved by the participant being debited is claimed for this payment.	ESRDEB: Only codes CONF and LIQU permitted. ESRPMT: Only codes CONF and LIQU permitted. IPIDEB: Only codes CONF and LIQU permitted. OUTPMT: Only codes CONF and LIQU permitted. SEPPMT: Only codes CONF and LIQU permitted. CSTPMT: CHF: Only codes CONF and LIQU permitted. SLRPMT: Only codes CONF and LIQU permitted.	MT A10 F19 0 = no entry in pacs.008, 1 = CONF MT A11 F19 0 = no entry in pacs.008, 1 = CONF	
Credit Transfer Transaction Information +Purpose	Purp	0..1	0..1	Transaction Purpose May be used to provide additional information about the purpose of the transaction. TRUNCATION: In the case of conversion to a SIC/FIN message type, this data might not be fully transmitted under any circumstances.	ESRDEB: Must not be used. ESRPMT: Must not be used. IPIDEB: Must not be used.	MT A10 F51A Only ISO 20022 to SIC MT A11 F51A Only ISO 20022 to SIC	F70 Remittance Information Only ISO 20022 to SWIFT
Credit Transfer Transaction Information +Purpose ++Code	Cd	1..1	1..1	Transaction Purpose (code)			
Credit Transfer Transaction Information +Purpose ++Proprietary	Prtry	1..1	1..1	Transaction Purpose (proprietary)		MT A11 F58T Only SIC to ISO 20022: Code is supplemented with the identification "TransactionType"	F26T Transaction Type Code Only SWIFT to ISO 20022: Code is supplemented with the identification "TransactionType"
Credit Transfer Transaction Information +Regulatory Reporting	RgltryRptg	0..10	0..1	Regulatory Reporting TRUNCATION: If the format "IS reference number" is selected for the creditor's account, then this element cannot be forwarded during conversion to a SIC/FIN message type. It is recommended that the element is not used.	ESRDEB: Must not be used. ESRPMT: Must not be used. IPIDEB: Must not be used. OUTPMT: Must not be used. SEPPMT: Must not be used. SLRPMT: Must not be used.		
Credit Transfer Transaction Information +Regulatory Reporting ++Details	Dtls	0..n	1..1	Details			



ISO 20022 Standard			Swiss ISO 20022 Payments Standard				
Message Item	XML Tag	Mult.	Mult.	Definition	Payment Type-specific Definition	SIC A10/A11/A15	SWIFT MT103
Credit Transfer Transaction Information +Regulatory Reporting ++Details +++Information	Inf	0..n	1..3	Information Maximum of 3 lines permitted.		MT A11 F60R	F77B Regulatory Reporting
Credit Transfer Transaction Information +Remittance Information	RmtInf	0..1	0..1	Remittance Information This information must be forwarded to the creditor and may be present in either unstructured (<Ustrd>) or structured (<Strd>) format.	ESRDEB: Must be used. ESRPMT: Must be used. IPIDEB: Must be used.		
Credit Transfer Transaction Information +Remittance Information ++Unstructured	Ustrd	0..n	0..2	Remittance Information Unstructured May only be used if no structured notification is present. SIC4: The element must not be used more than once.	ESRDEB: Must not be used. ESRPMT: Must not be used. IPIDEB: Must not be used.	MT A10 F51A MT A11 F51A	F70 Remittance Information
Credit Transfer Transaction Information +Remittance Information ++Structured	Strd	0..n	0..1	Remittance Information Structured May only be used if no unstructured notification is present.	CSTPMT: Maximum of 140 characters including XML tags, otherwise it cannot be guaranteed that all the information will be forwarded. SLRPMT: Maximum of 140 characters including XML tags, otherwise it cannot be guaranteed that all the information will be forwarded. ESRDEB: Must be present. ESRPMT: Must be present. IPIDEB: Must be present. OUTPMT: Must not be used. SEPPMT: May be used, may contain maximum of 140 characters including XML tags.		
Credit Transfer Transaction Information +Remittance Information ++Structured +++Referred Document Information	RfrdDocInf	0..n	0..1	Referred Document Information Contains the requested processing date and the LSV-ID for the original direct debit. TRUNCATION: CSTPMT: In the case of conversion to a SIC/FIN message type, this element cannot be forwarded.	ESRDEB: Must be present. IPIDEB: Must be present. ESRPMT: Must not be used. OUTPMT: Must not be used. SEPPMT: Must not be used. SLRPMT: Must not be used.		
Credit Transfer Transaction Information +Remittance Information ++Structured +++Referred Document Information +++Type	Tp	0..1	1..1	Type			



ISO 20022 Standard			Swiss ISO 20022 Payments Standard				
Message Item	XML Tag	Mult.	Mult.	Definition	Payment Type-specific Definition	SIC A10/A11/A15	SWIFT MT103
Credit Transfer Transaction Information +Remittance Information ++Structured +++Referred Document Information ++++Type +++++Code Or Proprietary	CdOrPrtry	1..1	1..1				
Credit Transfer Transaction Information +Remittance Information ++Structured +++Referred Document Information ++++Type +++++Code Or Proprietary +++++Code	Cd	1..1	1..1	SIC4: Must not be used.			
Credit Transfer Transaction Information +Remittance Information ++Structured +++Referred Document Information ++++Type +++++Code Or Proprietary +++++Proprietary	Prtry	1..1	1..1	Type of Additional Remittance Information Permitted code value: LSVBDD			
Credit Transfer Transaction Information +Remittance Information ++Structured +++Referred Document Information ++++Number	Nb	0..1	1..1	LSV ID LSV identification of the original direct debit.		MT A10 F52B Identification MT A15 F52B Identification	F72 Sender to Receiver Information /SICLSVID/ plus 5-position ID for the creditor
Credit Transfer Transaction Information +Remittance Information ++Structured +++Referred Document Information ++++Related Date	RltdDt	0..1	1..1	Requested Processing Date Contains the requested processing date of the original direct debit.		MT A10 F52B Date Format = 8d MT A15 F52B Date Format = 8d	F72 Sender to Receiver Information /SICLSVGV/ plus requested processing date
Credit Transfer Transaction Information +Remittance Information ++Structured +++Referred Document Amount	RfrdDocAmt	0..1	0..1	Referred Document Amount TRUNCATION: CSTPMT: In the case of conversion to a SIC/FIN message type, this element cannot be forwarded.	ESRDEB: Must not be used. ESRPMT: Must not be used. IPIDEB: Must not be used. OUTPMT: Must not be used. SEPPMT: Must not be used. SLRPMT: Must not be used.		
Credit Transfer Transaction Information +Remittance Information ++Structured +++Creditor Reference Information	CdtrRefInf	0..1	1..1	Creditor Reference Information			



ISO 20022 Standard			Swiss ISO 20022 Payments Standard				
Message Item	XML Tag	Mult.	Mult.	Definition	Payment Type-specific Definition	SIC A10/A11/A15	SWIFT MT103
Credit Transfer Transaction Information +Remittance Information ++Structured +++Creditor Reference Information ++++Type	Tp	0..1	1..1	Reference Type			
Credit Transfer Transaction Information +Remittance Information ++Structured +++Creditor Reference Information ++++Type +++++Code Or Proprietary	CdOrPrtry	1..1	1..1				
Credit Transfer Transaction Information +Remittance Information ++Structured +++Creditor Reference Information ++++Type +++++Code Or Proprietary ++++++Code	Cd	1..1	1..1	Reference Type (code) The following ISO code value is permitted: SCOR = Structured customer reference for the creditor.	CSTPMT: Must not be used. ESRDEB: Must not be used. ESRPMT: Must not be used. IPIDEB: Must not be used. OUTPMT: Must not be used. SLRPMT: Must not be used. SEPPMT: Must be present if <RmtInf><Strd> is present. Only value "SCOR" is permitted.		
Credit Transfer Transaction Information +Remittance Information ++Structured +++Creditor Reference Information ++++Type +++++Code Or Proprietary ++++++Proprietary	Prtry	1..1	1..1	Reference Type (proprietary) The following ISO code values are permitted: ESR = ISR reference IPI = Structured details of payment from the IPI	CSTPMT: Must be present if <RmtInf><Strd> is present. Only value "IPI" is permitted. ESRDEB: The value "ESR" must be used. ESRPMT: The value "ESR" must be used. IPIDEB: The value "IPI" must be used. SEPPMT: Must not be used. SLRPMT: Must be present if <RmtInf><Strd> is present. Only value "IPI" is permitted.	MT A10 F51I equates to the value "IPI" MT A11 F51I equates to the value "IPI" MT A15 F49E equates to the value "ESR"	F70 Remittance Information Codes /IPI/, /ESR/
Credit Transfer Transaction Information +Remittance Information ++Structured +++Creditor Reference Information ++++Type +++++Issuer	Issr	0..1	0..1	Issuer of the Creditor Reference TRUNCATION: In the case of conversion to a SIC/FIN message type, this element cannot be forwarded.	CSTPMT: Must not be used. ESRDEB: Must not be used. ESRPMT: Must not be used. IPIDEB: Must not be used. OUTPMT: Must not be used. SLRPMT: Must not be used.		

ISO 20022 Standard			Swiss ISO 20022 Payments Standard				
Message Item	XML Tag	Mult.	Mult.	Definition	Payment Type-specific Definition	SIC A10/A11/A15	SWIFT MT103
Credit Transfer Transaction Information +Remittance Information ++Structured +++Creditor Reference Information ++++Reference	Ref	0..1	1..1	Creditor Reference The creditor reference will individually be checked on the basis of the code provided in <Tp><CdOrPrtry><Cd> or <Prtry>: ESR (<Prtry>) = ISR reference number complying with the following requirements: - Mandatory 27-digit numerical value, no spaces permitted. - If the reference number is < 27 digits, it must be left-padded with zeros. - Must be >0. - Check digit in the last position according to Modulo 10, recursive. IPI (<Prtry>) = structured details of payment from the IPI complying with the following requirements: - Mandatory 20-digit value. - Must contain a correct check digit pair in positions 1 – 2. SCOR (<Cd>) = Structured customer reference for the creditor. RF Creditor Reference according to ISO 11649 may be used.	CSTPMT: Must be present, if <RmtInf><Strd> is used, may only contain the structured purpose of payment of the IPI. SLRPMT: Must be present, if <RmtInf><Strd> is used, may only contain the structured purpose of payment of the IPI. ESRDEB: Must contain ISR reference number. ESRPMT: Must contain ISR reference number. IPIDEB: Must contain structured details of payment from the IPI. SEPPMT: Must be present, if <RmtInf><Strd> is used.	MT A10 F511 MT A11 F511 MT A15 F49E	F70 Remittance Information Codes /IPI/, /ESR/
Credit Transfer Transaction Information +Remittance Information ++Structured +++Invoicer	Invcr	0..1	0..1	Invoicer TRUNCATION: CSTPMT: In the case of conversion to a SIC/FIN message type, this element cannot be forwarded.	ESRDEB: Must not be used. ESRPMT: Must not be used. IPIDEB: Must not be used. OUTPMT: Must not be used. SEPPMT: Must not be used. SLRPMT: Must not be used.		
Credit Transfer Transaction Information +Remittance Information ++Structured +++Invoicee	Invcee	0..1	0..1	Invoicee TRUNCATION: CSTPMT: In the case of conversion to a SIC/FIN message type, this element cannot be forwarded.	ESRDEB: Must not be used. ESRPMT: Must not be used. IPIDEB: Must not be used. OUTPMT: Must not be used. SEPPMT: Must not be used. SLRPMT: Must not be used.		



ISO 20022 Standard			Swiss ISO 20022 Payments Standard				
Message Item	XML Tag	Mult.	Mult.	Definition	Payment Type-specific Definition	SIC A10/A11/A15	SWIFT MT103
Credit Transfer Transaction Information +Remittance Information ++Structured +++Additional Remittance Information	AddlRmtInf	0..3	0..3	Additional Remittance Information TRUNCATION: CSTPMT: In the case of conversion to a SIC/FIN message type, this element cannot be forwarded.	ESRDEB: Must not be used. ESRPMT: Must not be used. IPIDEB: Must not be used. OUTPMT: Must not be used. SEPPMT: Must not be used. SLRPMT: Must not be used.		

Table 9: Credit Transfer Transaction Information (CdtTrfTxInf, B-Level)

5 Example

5.1 Use case: customer payment to a bank account (STP customer payment)

This use case applies to processing customer payments made into a bank account with no accompanying deposit slip:

The Remote Bank Frankfurt transfers CHF 1111 on behalf of the watch wholesaler to the account of the Horlogerie de Joux at the Banque Commerciale, Fribourg. Since the payment complies with the requirements of the Swiss STP definition, the transaction counts as STP.

Business elements of the payment

Business element	Content
Payment type	Customer payment
Message identification	2012012500001
Transaction identification	2012012500001
Identification of instructing participant	098064 (CHSIC)
Currency code	CHF
Requested settlement date	20121025
Settlement amount	1111,00
Identification of instructed participant	092052 (CHSIC)
Debtor account	CH4089999001234567890
Creditor account	CH1708841000987654321
Debtor name	Uhrengrosshandel Buxtehude
Debtor address	Buxtehude
Creditor name	Horlogerie du Joux
Creditor address	Les Brenets

Depiction of the payment using SIC A10

Field designation	Content
<02> BC number ordering bank	098064
<03> Transaction reference number	2012012500001
<15> Currency code	CHF
<16> Value date debit	20120125
<17A> Credit amount	000000001111,00
<18> BC number beneficiary bank	092052
<31I> Client account number, IBAN	CH4089999001234567890
<32A> Client's address, Full address	Uhrengrosshandel Buxtehude Buxtehude
<45I> Beneficiary's account number, IBAN	CH1708841000987654321
<46A> Beneficiary's address, Full address	Horlogerie du Joux Les Brenets

The outgoing message to the *"Instructed Agent"* also contains the following element:

Field designation	Content
<92A> Settlement date/settlement time	20120125#094545

Depiction of the payment using SWIFT MT103

Field designation	Content
20: Sender's Reference	2012012500001
23B: Bank Operation Code	CRED
32A: Val Dte/Curr/Interbnk Settl'd Amt	Date : 25 January 2012 Currency : CHF Amount : #1,111.#
33B: Currency/Instructed Amount	Currency : CHF Amount : #1,111.#
50K: Ordering Customer Name & Address	/CH4089999001234567890 Uhrengrosshandel Buxtehude Buxtehude
57C: Account With Institution	//SW092052
59: Beneficiary Customer Name & Address	/CH1708841000987654321 Horlogerie du Joux Les Brenets
71A: Details of Charges	SHA

Depiction of the payment using ISO 20022 pacs.008

FIToFICstmrCdtTf	GrpHdr	MsgId	MSGID-0001		
		CreDtTm	2001-12-17T09:30:47Z		
		NbOfTxs	1		
		IntrBkSttlmDt	2012-01-25		
	SttlmInf	SttlmMtd	CLRG		
	InstgAgt	FinInstnId	ClrSysMmbld	ClrSysId	Cd CHSIC
				Mmbld	098064
		FinInstnId	ClrSysMmbld	ClrSysId	Cd CHSIC
				Mmbld	092052
InstdAgt					
CdtTrfTxInf	PmtId	EndToEndId	NOTPROVIDED		
		TxId	2012012500001		
	PmtTplnf	LclInstrm	Prtry	CSTPMT	
	IntrBkSttlmAmt	1111 CHF			
	ChrgBr	SHAR			
	Dbtr	Nm	Uhrengrosshandel Buxtehude		
		PstlAdr	AdrLine	Buxtehude	

DbtrAcct	Id	IBAN	CH4089999001234567890						
DbtrAgt	FinInstnId	ClrSysMmbld	<table border="1"> <tr> <td>ClrSysId</td> <td>Cd</td> <td>CHSIC</td> </tr> <tr> <td>Mmbld</td> <td></td> <td>098064</td> </tr> </table>	ClrSysId	Cd	CHSIC	Mmbld		098064
ClrSysId	Cd	CHSIC							
Mmbld		098064							
CdtrAgt	FinInstnId	ClrSysMmbld	<table border="1"> <tr> <td>ClrSysId</td> <td>Cd</td> <td>CHSIC</td> </tr> <tr> <td>Mmbld</td> <td></td> <td>092052</td> </tr> </table>	ClrSysId	Cd	CHSIC	Mmbld		092052
ClrSysId	Cd	CHSIC							
Mmbld		092052							
Cdtr	Nm	Horlogerie du Joux							
	PstIAdr	AdrLine	Les Brenets						
CdtrAcct	Id	IBAN	CH1708841000987654321						

The outgoing message to the "Instructed Agent" also contains the following element:

Field designation	Content
Credit Transfer Transaction Information +Settlement Time Indication ++Credit Date Time	2012-01-25T09:45:45

For XML versions of the examples see Appendix A.

Appendix A: XML schema and example

XML schema

The XML schema for "pacs.008" for the RTGS systems

- ***pacs.008.001.02.ch.01.xsd***

is published on the SIX Interbank Clearing Ltd website.

It should preferably be opened using specific XML software.

Example

The example shown in section 5 is published on the SIX Interbank Clearing Ltd website as an XML file:

- ***pacs_008_Beispiel_1_Kundenzahlung_Bankkonto_STP.xml***

Validation Portal

The above mentioned example message as well as this implementation guideline, the XML schema and additional examples can also be downloaded from the SIC⁴ Validation Portal (<https://validation.iso-payments.ch/SIC4>).

After successful registration users can upload their own messages and have them validated against this implementation guideline.

Appendix B: Table of figures

Figure 1:	Documentation structure	6
Figure 2:	Basic message structure for XML message "pacs.008"	7
Figure 3:	Indication of the payment type in the XML message	9
Figure 4:	Use of references	13
Figure 5:	Message Identification	13
Figure 6:	Transaction Identification	14
Figure 7:	Creditor reference (Remittance Information)	14
Figure 8:	Creditor Reference Information	15
Figure 9:	Creditor Reference Type	16
Figure 10:	Identifier for direct debits	17
Figure 11:	Account number definition	18
Figure 12:	Entering a code for the reference type	19
Figure 13:	Entering a code for sending processing instructions to the RTGS systems	20
Figure 14:	Entering an earliest settlement time	22
Figure 15:	Group Header (GrpHdr) pacs.008	23
Figure 16:	Credit Transfer Transaction Information (CdtTrfTxInf)	31

Appendix C: Table of tables

Table 1:	Situations where the ISO 20022 message type "pacs.008" is used	8
Table 2:	List of payment types and their code values in the XML message	9
Table 3:	Names of the parties involved in transfers	10
Table 4:	Code value for LSV ⁺ /BDD transactions	17
Table 5:	Defining creditor account numbers	18
Table 6:	Code values for reference types	19
Table 7:	Code values for sending processing instructions to the RTGS systems	20
Table 8:	Group Header (GrpHdr, A-Level)	29
Table 9:	Credit Transfer Transaction Information (CdtTrfTxInf, B-Level)	72