

# INSTRUCTION MANUAL

## CHEMTROL® PC PROGRAMMABLE CONTROLLERS

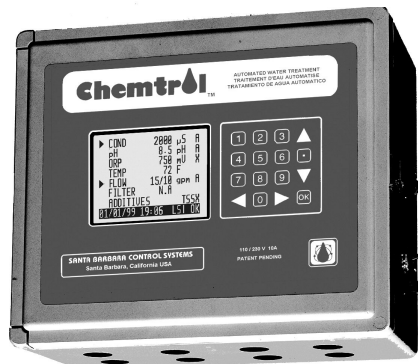
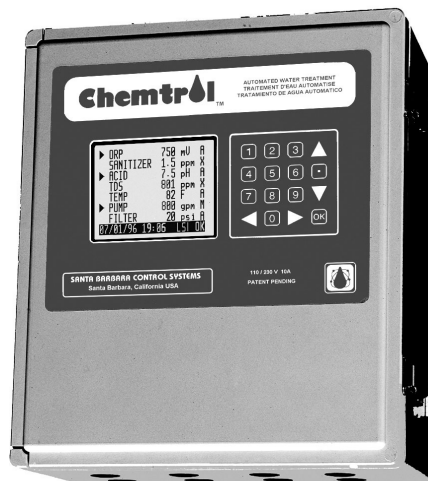

- MODEL PC7000** \_\_\_\_\_
- PC6000** \_\_\_\_\_
- PC5000** \_\_\_\_\_
- PC3000** \_\_\_\_\_

### WARRANTY

This CHEMTROL® Controller S/N \_\_\_\_\_ is warranted by SANTA BARBARA CONTROL SYSTEMS (SBCS) to be free from defects in manufacturing and workmanship for a period of FIVE (5) YEARS from the date of purchase for the printed circuit boards and ONE (1) YEAR for all other components. SBCS will repair or replace at its option any defective part during the warranty period. Labor, shipping or incidental expenses are specifically excluded from this warranty. For warranty coverage, defective parts should be returned immediately to your CHEMTROL® Dealer or to our factory postpaid with a copy of your purchase receipt and a description of the malfunction.

<b>TECHNICAL SUPPORT</b>	
<b>US/CANADA</b>	<b>800-621-2279</b>
<b>OTHER COUNTRIES</b>	<b>805-683-8833</b>
<b>FAX</b>	<b>805-683-1893</b>
<b>INTERNET</b>	<b>support@sbcontrol.com</b>

**Chemtrol®**

**SANTA BARBARA CONTROL SYSTEMS**  
5375 Overpass Road – Santa Barbara, CA 93111

# MENU TREE

## MENU TREE CHEMTROL<sup>(R)</sup> PC CONTROLLERS

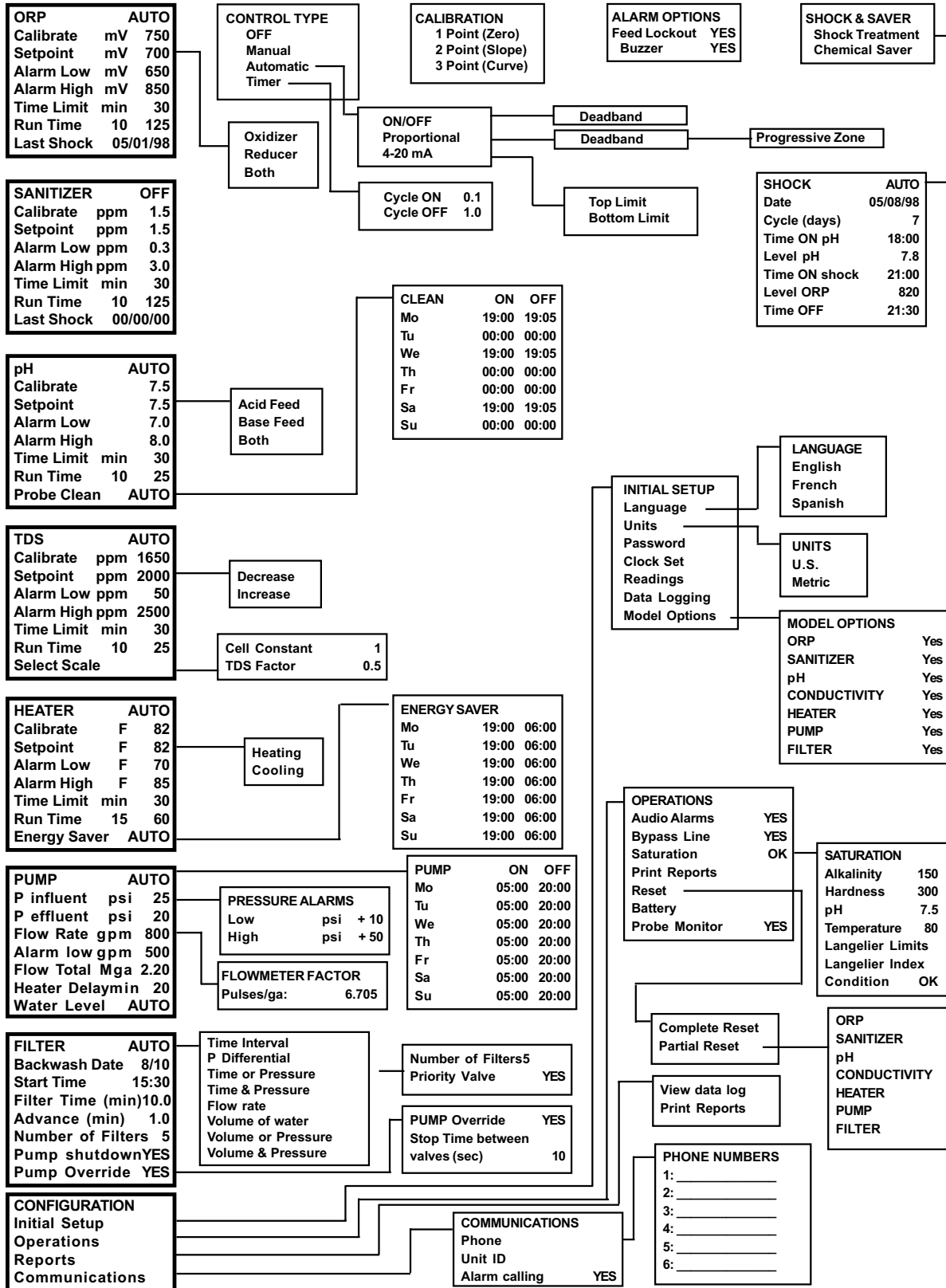

## **IMPORTANT SAFETY INSTRUCTIONS**

Specified by ITS Testing Services for Swimming Pools and Spas

1. **READ AND FOLLOW ALL INSTRUCTIONS**
2. **WARNING** - To reduce the risk of injury, do not permit children to use this product unless they are closely supervised at all times.
3. A wire connector is provided on this unit to connect a minimum No. 8 AWG solid copper conductor between this unit and any metal equipment, metal enclosures or electrical equipment, metal water pipe or conduit within 5 feet of this unit.
4. **DANGER** - Risk of injury.
  - a) Replace damaged cord immediately.
  - b) Do not bury cord.
  - c) Connect to a grounded, grounding type receptacle only.
5. **WARNING** - This product must be connected to a power source equipped with a ground-fault circuit interrupter (GFCI). The GFCI must be tested before each use. With the product operating, open the service door. If the product stops operating, this merely indicates that the door is equipped with an electrical interlock. Next, push the test button on the GFCI and close the service door. The product should not operate. Now open the service door, push the reset button on the GFCI and close the service door. The product should now operate normally. If the product fails to operate in this manner, there is a ground current flowing indicating the possibility of an electric shock. Disconnect the power until the fault has been identified and corrected.
8. **DANGER** - Risk of electric shock. Install at least 5 feet (1.5 m) from inside wall of tub or spa using nonmetallic plumbing.
7. **DANGER** - Risk of electric shock. Do not permit any electric appliance, such as a light, telephone, radio, or television, within 5 feet (1.5 m) of a spa or hot tub.
8. **WARNING** - To reduce the risk of injury:
  - a) The water in a spa should never exceed 40 °C (104 °F). Water temperatures between 38 °C (100 °F) and 40 °C (104 °F) are considered safe for a healthy adult. Lower water temperatures are recommended for young children and when spa use exceeds 10 minutes.
  - b) Since excessive water temperatures have a high potential for causing fetal damage during early months of pregnancy, pregnant or possibly pregnant women should limit spa water temperatures to 38 °C (100 °F).
  - c) Before entering a spa or hot tub, the user should measure the water temperature with an accurate thermometer since the tolerance of water temperature-regulating devices varies.
  - d) The use of alcohol, drugs or medication before or during spa or hot tub use may lead to unconsciousness with the possibility of drowning.
  - e) Persons suffering from obesity or with a medical history of heart disease, low or high blood pressure, circulatory system problems or diabetes should consult a physician before using a spa.
  - f) Persons using medication should consult a physician before using a spa or hot tub since some medication may induce drowsiness while other medications may affect heart rate, blood pressures and circulation.
9. **SAVE THESE INSTRUCTIONS**

# TABLE OF CONTENTS

<b>MENU TREE .....</b>	<b>II</b>	<i>Remote Alarm .....</i>	<i>10</i>
<b>IMPORTANT SAFETY INSTRUCTIONS .....</b>	<b>II</b>	<i>Mother Board .....</i>	<i>10</i>
<b>IMPORTANT SAFETY INSTRUCTIONS .....</b>	<b>III</b>	<i>Sensor Connections.....</i>	<i>10</i>
<b>TABLE OF CONTENTS .....</b>	<b>IV</b>	<i>Buzzer.....</i>	<i>10</i>
<b>LIST OF FIGURES .....</b>	<b>3</b>	<i>Display Brightness .....</i>	<i>10</i>
<b>CHAPTER I - INTRODUCTION .....</b>	<b>1</b>	<i>Backup Battery.....</i>	<i>11</i>
<i>Water Maintenance .....</i>	<i>1</i>	<i>Remote Communications.....</i>	<i>11</i>
<i>Reference Manuals.....</i>	<i>1</i>	<i>Multiple Serial Connections (Option).....</i>	<i>11</i>
<b>CONTROLLER FEATURES .....</b>	<b>2</b>	<i>4-20 mA Converter Boards .....</i>	<i>12</i>
<i>New Features.....</i>	<i>2</i>	<i>Field Installation.....</i>	<i>12</i>
<i>Models.....</i>	<i>2</i>	<i>4-20 mA Connections .....</i>	<i>12</i>
<i>Automated Water Treatment.....</i>	<i>2</i>	<i>PPM Sensor Board.....</i>	<i>12</i>
<i>Control Functions.....</i>	<i>2</i>	<b>PLUMBING .....</b>	<b>13</b>
<i>Free Chlorine.....</i>	<i>3</i>	<i>Installation of Sensors.....</i>	<i>13</i>
<i>Free Chlorine control .....</i>	<i>3</i>	<i>In-line Installation (2" Pipe) .....</i>	<i>13</i>
<i>ORP control .....</i>	<i>3</i>	<i>Flow Cell Assembly.....</i>	<i>13</i>
<i>Probe Failure Analysis .....</i>	<i>3</i>	<i>Sensor Cell Cabinet (Option).....</i>	<i>13</i>
<b>CONTROL PANEL.....</b>	<b>4</b>	<i>Water Flow.....</i>	<i>14</i>
<i>LCD Display Screen.....</i>	<i>4</i>	<i>Paddle Wheel Rotary Flow Switch.....</i>	<i>14</i>
<i>Display Readings.....</i>	<i>4</i>	<b>PPM SENSORS .....</b>	<b>15</b>
<i>Data Entry Keyboard.....</i>	<i>4</i>	<i>New PPM Sensors.....</i>	<i>15</i>
<i>Remote Communications.....</i>	<i>4</i>	<i>PPM Sensor Flow Cell.....</i>	<i>15</i>
<b>PROGRAM MENUS.....</b>	<b>5</b>	<i>PPM Sensor Installation.....</i>	<i>15</i>
<i>Initial Screens.....</i>	<i>5</i>	<b>ORP AND pH SENSORS.....</b>	<b>16</b>
<i>Display Screens.....</i>	<i>5</i>	<i>Properties.....</i>	<i>16</i>
<i>Main Menus and Submenus.....</i>	<i>5</i>	<i>Packaging .....</i>	<i>16</i>
<i>Alarm Displays .....</i>	<i>5</i>	<i>Sensor cables .....</i>	<i>16</i>
<b>CHAPTER II - INSTALLATION .....</b>	<b>6</b>	<i>Electrical Interference .....</i>	<i>16</i>
<b>SAFETY NOTICE.....</b>	<b>6</b>	<i>Storage and Winterizing.....</i>	<i>17</i>
<b>UNPACKING.....</b>	<b>6</b>	<i>Sensor Warranties .....</i>	<i>17</i>
<b>INSTALLATION REPORT .....</b>	<b>6</b>	<b>TEMPERATURE SENSOR.....</b>	<b>17</b>
<b>TECHNICAL SUPPORT.....</b>	<b>6</b>	<b>CONDUCTIVITY SENSOR .....</b>	<b>17</b>
<b>PRINCIPLE OF INSTALLATION .....</b>	<b>6</b>	<b>FLOW SENSOR.....</b>	<b>18</b>
<b>CONTROLLER CABINET .....</b>	<b>6</b>	<i>Flow Sensor Location .....</i>	<i>18</i>
<b>LOCATION.....</b>	<b>6</b>	<i>Flow Sensor Saddles.....</i>	<i>18</i>
<b>ELECTRICAL.....</b>	<b>8</b>	<i>Flow Sensor Connections.....</i>	<i>18</i>
<i>Electrical Codes .....</i>	<i>8</i>	<b>PRESSURE TRANSDUCERS .....</b>	<b>19</b>
<i>AC Power Input .....</i>	<i>8</i>	<i>Transducer Connections.....</i>	<i>19</i>
<i>Grounding (GFI).....</i>	<i>8</i>	<b>WATER LEVEL SENSOR.....</b>	<b>19</b>
<i>Main Power Interlock.....</i>	<i>8</i>	<i>Installation.....</i>	<i>19</i>
<i>Panel Interlock .....</i>	<i>8</i>	<i>Maintenance .....</i>	<i>19</i>
<i>PC Boards.....</i>	<i>8</i>	<i>Figure 28 - Optical Level Sensor.....</i>	<i>19</i>
<i>Power Board .....</i>	<i>8</i>	<b>CHEMICAL FEEDERS.....</b>	<b>20</b>
<i>115V/230V Power Transformer.....</i>	<i>8</i>	<i>WARNING: Tank Sizing.....</i>	<i>20</i>
<i>Relay Jumpers (PC7000).....</i>	<i>8</i>	<i>Chemical Feed Pumps.....</i>	<i>20</i>
<i>Relays and Fuses.....</i>	<i>10</i>	<i>Carbonic Acid (CO<sub>2</sub>) Valve.....</i>	<i>20</i>
		<i>Gas Chlorinator.....</i>	<i>20</i>
		<i>Erosion Feeders.....</i>	<i>20</i>
		<i>Back Diffusion.....</i>	<i>20</i>
		<b>FILTER BACKWASH.....</b>	<b>21</b>
		<i>Main Pump Shutoff .....</i>	<i>21</i>
		<i>Single Filter Backwash.....</i>	<i>21</i>
		<i>Multiple Filter Backwash .....</i>	<i>21</i>
		<i>Backwash Stager.....</i>	<i>21</i>
		<i>Electrical Valves.....</i>	<i>21</i>
		<i>Hydraulic Valves.....</i>	<i>21</i>
		<i>Pneumatic Valves .....</i>	<i>21</i>
		<b>CHAPTER III - STARTUP .....</b>	<b>22</b>

<b>CONTROLLER STARTUP</b> .....	<b>22</b>	<b>2 - SANITIZER MENU</b> .....	<b>33</b>
<i>Initial Reset</i> .....	22	<i>Input Selection</i> .....	33
<i>Configuration Menu</i> .....	22	<i>Free Chlorine Control</i> .....	33
<i>Alarm Buzzer</i> .....	22	<i>Calculated PPM Readings</i> .....	33
<i>Bypass Line</i> .....	22	2.1 - <i>Display and Calibration</i> .....	33
<i>Battery Check</i> .....	22	Free Chlorine Calibration.....	33
<i>PPM Board Initialization</i> .....	22	Calculated PPM Calibration.....	33
<b>CHEMICAL CONTROL</b> .....	<b>22</b>	2.3 - <i>Setpoint</i> .....	34
<i>Initial Activation of Sensors</i> .....	22	2.4 - <i>Low Alarm</i> .....	34
<i>Bypass Line Test</i> .....	22	2.5 - <i>High Alarm</i> .....	34
<i>Water Chemistry Adjustment</i> .....	22	2.6 - <i>Time Limit</i> .....	34
<i>Water Sampling</i> .....	22	2.7 - <i>Run Time</i> .....	34
<i>pH Calibration</i> .....	22	2.8 - <i>Last Shock</i> .....	34
<i>pH Feed (Acid or Base)</i> .....	23	2.8.1 - <i>Superchlorination</i> .....	34
<i>pH Setpoint</i> .....	23	2.8.2 - <i>Deshock</i> .....	34
<i>ORP Calibration</i> .....	23	2.8.3 - <i>Chemical Saver</i> .....	34
<i>ORP Setpoint</i> .....	23	<b>3 - pH MENU</b> .....	<b>35</b>
<i>Sanitizer Calibration</i> .....	23	<i>Operation</i> .....	35
<i>Time Limits</i> .....	23	3.1- <i>Control Mode</i> .....	35
<i>Shock Treatment</i> .....	23	3.2 - <i>Display and Calibration</i> .....	35
<i>Chemical Saver</i> .....	23	3.3 - <i>Setpoint</i> .....	35
<b>WATER SATURATION</b> .....	<b>23</b>	3.4 - <i>Low Alarm</i> .....	36
<b>CHAPTER IV - CONTROLLER OPERATION</b> .....	<b>24</b>	3.5 - <i>High Alarm</i> .....	36
<i>Access</i> .....	24	3.6 - <i>Time Limit</i> .....	36
<i>Default Setup</i> .....	24	3.7 - <i>Run Time</i> .....	36
<b>8 - CONFIGURATION MAIN MENU</b> .....	<b>24</b>	3.8 - <i>Probe Clean</i> .....	36
8.1 - <i>INITIAL SETUP SUBMENU</i> .....	25	<b>4 - CONDUCTIVITY MENU</b> .....	<b>37</b>
8.1.1 - <i>Language</i> .....	25	<i>Conductivity and TDS</i> .....	37
8.1.2 - <i>Units</i> .....	25	<i>Conductivity or TDS Displays</i> .....	37
8.1.3 - <i>Code Number</i> .....	25	4.1- <i>Control Mode</i> .....	37
8.1.4 - <i>Clock</i> .....	26	4.2 - <i>Display and Calibration</i> .....	37
8.1.5 - <i>Readings</i> .....	26	4.3 - <i>Setpoint</i> .....	37
8.1.6 - <i>Data Logging</i> .....	26	4.4 - <i>Low Alarm</i> .....	37
8.1.7 - <i>Model Options</i> .....	26	4.5 - <i>High Alarm</i> .....	37
8.2 - <i>OPERATIONS SUBMENU</i> .....	27	4.6 - <i>Time Limit</i> .....	38
8.2.1 - <i>Audio Alarms</i> .....	27	4.7 - <i>Run Time</i> .....	38
8.2.2 - <i>Bypass Line</i> .....	27	4.8 - <i>Select Scale</i> .....	38
8.2.3 - <i>Langelier Saturation Index</i> .....	27	4.8.1 - <i>Scale Selection</i> .....	38
8.2.4 - <i>Reset</i> .....	28	4.8.2 - <i>Cell Constant</i> .....	38
8.2.5 - <i>Backup Battery</i> .....	28	4.8.3 - <i>TDS Factor</i> .....	38
8.2.6 - <i>Probe Monitor</i> .....	28	<b>5 - TEMPERATURE MENU</b> .....	<b>39</b>
8.3 - <i>REPORT SUBMENU</i> .....	28	<i>Operation</i> .....	39
8.3.1 - <i>View Data Log</i> .....	28	5.1 - <i>Control Mode</i> .....	39
8.3.2 - <i>Print Reports</i> .....	29	5.2 - <i>Display and Calibration</i> .....	39
On-Site Printing .....	29	5.3 - <i>Setpoint</i> .....	39
On-Site Download.....	29	5.4 - <i>Low Alarm</i> .....	39
8.4 - <i>COMMUNICATIONS SUBMENU</i> .....	30	5.5 - <i>High Alarm</i> .....	39
8.4.1 - <i>Phone Numbers</i> .....	30	5.6 - <i>Time Limit</i> .....	39
8.4.2 - <i>Unit Identification</i> .....	30	5.7 - <i>Run Time</i> .....	39
8.4.3 - <i>Alarm Calling</i> .....	30	5.8 - <i>Energy Saver</i> .....	39
8.4.4 - <i>4-20 mA Output</i> .....	30	<b>6- PUMP MENU</b> .....	<b>40</b>
<b>1 - ORP MENU</b> .....	<b>31</b>	<i>Operation</i> .....	40
<i>Operation</i> .....	31	6.1- <i>Control Mode</i> .....	40
1.1 - <i>Control Mode</i> .....	31	6.2 - <i>Influent Pressure</i> .....	41
1.2 - <i>Display and Calibration</i> .....	31	Pressure Alarms.....	41
1.3 - <i>Setpoint</i> .....	31	Calibration .....	41
1.4 - <i>Low Alarm</i> .....	31	6.3 - <i>Effluent Pressure</i> .....	41
1.5 - <i>High Alarm</i> .....	32	<i>Differential Pressure</i> .....	41
1.6 - <i>Time Limit</i> .....	32	6.4 - <i>Flow Rate</i> .....	42
1.7 - <i>Run Time</i> .....	32	6.5 - <i>Flow Total</i> .....	42
1.8 - <i>Last Shock</i> .....	32	6.6 - <i>Heater Delay (Cooldown Safety)</i> .....	43
1.8.1 - <i>Shock Treatment</i> .....	32	6.7 - <i>Water Level Control</i> .....	43
1.8.2 - <i>Deshock</i> .....	32	<b>7 - FILTER MAIN MENU</b> .....	<b>44</b>
1.8.3 - <i>Chemical Saver</i> .....	32	<i>Filter Backwash</i> .....	44
		7.1 - <i>Automatic Backwash</i> .....	44
		7.1.2 - <i>Pressure Differential</i> .....	45

7.1.3 - Time or Pressure Differential .....	45	<i>Limit Timers (Overfeed Safety)</i> .....	57
7.1.4 - Time and Pressure Differential .....	45	Timer Settings .....	57
7.1.5 - Flow Rate .....	45	<b>PERIODIC MAINTENANCE</b> .....	<b>57</b>
7.1.6 - Volume of Water .....	46	<i>Water Testing</i> .....	57
7.1.7 - Volume or Pressure Differential .....	46	<i>Shock Treatment</i> .....	57
7.1.8 - Volume and Pressure Differential .....	46	Precautions .....	57
Safety Shutoff .....	46	<b>PORTABLE TESTER</b> .....	<b>58</b>
7.6 - Priority Valve .....	46	<i>ORP SENSOR TESTING</i> .....	58
7.7 - Pump Shutdown .....	46	<i>pH SENSOR TESTING</i> .....	58
7.8 - Pump Override .....	46	<i>ORP AND pH SIMULATION</i> .....	58
<b>CONTROL SUBMENUS</b> .....	<b>47</b>	<i>CONDUCTIVITY AND TEMPERATURE</i> .....	58
<i>Features</i> .....	47	<b>TROUBLESHOOTING</b> .....	<b>59</b>
<i>X.1 - Control Type</i> .....	47	<b>PARTS, ACCESSORIES AND UPGRADES</b> .....	<b>60</b>
X.0.1 - Deadband .....	47	<b>INDEX</b> .....	<b>62</b>
X.0.2 - Progressive Zone .....	47		
X.1.3 - Automatic Control .....	48		
X.1.4 - Timer Control .....	48		
<b>CALIBRATION SUBMENUS</b> .....	<b>49</b>		
<i>X.2 - Calibration Options</i> .....	49		
X.2.1 - One-Point Calibration .....	49		
X.2.2 - Two-Point Calibration .....	49		
X.2.3 - Three-Point Calibration .....	49		
<b>SHOCK AND SAVINGS SUBMENUS</b> .....	<b>50</b>		
<i>X.8 - Treatment Selection</i> .....	50		
X.8.1 - Shock Treatment Program .....	50		
X.8.2 - Deshock Program .....	50		
X.8.3 - Chemical Saver Program .....	50		
<b>CHAPTER V - COMMUNICATIONS</b> .....	<b>51</b>		
<b>CHEMCOM™ PROGRAM</b> .....	<b>51</b>		
<b>MODEM CONNECTIONS</b> .....	<b>52</b>		
<b>COMPUTER SOFTWARE INSTALLATION</b> .....	<b>52</b>		
<b>REMOTE OPERATION</b> .....	<b>52</b>		
<i>Secondary Units</i> .....	52		
<i>Duplex Operation</i> .....	52		
<b>DATA COLLECTION</b> .....	<b>53</b>		
<b>AUTOMATIC SCANNING</b> .....	<b>53</b>		
<i>Direct Scanning</i> .....	53		
<i>Data Log Download</i> .....	54		
<b>DATA DISPLAY</b> .....	<b>54</b>		
<i>Text Data Display</i> .....	54		
<i>Graphic Data Display</i> .....	54		
<b>CHAPTER VI - MAINTENANCE</b> .....	<b>55</b>		
<b>CONTROLLER MAINTENANCE</b> .....	<b>55</b>		
<i>Regular Maintenance</i> .....	55		
<i>The Acid Test</i> .....	55		
<i>Sensor Cleaning</i> .....	55		
PPM Sensor: .....	55		
ORP and pH Sensors: .....	55		
Conductivity Sensor .....	55		
<i>PPM Sensor Storage</i> .....	55		
<i>ORP and pH Sensor Storage</i> .....	55		
<i>Sensor Winterizing</i> .....	55		
<i>Battery Replacement</i> .....	55		
<i>Software Upgrade</i> .....	55		
<b>CHEMICAL MAINTENANCE</b> .....	<b>56</b>		
<i>Overview</i> .....	56		
<i>pH Control</i> .....	56		
<i>ORP and Sanitizer Control</i> .....	56		

## **LIST OF FIGURES**

Figure 1 – PC6000/7000 Controller.....	2	Figure 26 - Saddle for FS 2540.....	18
Figure 2 – PC3000/PC5000 Controller.....	2	Figure 27 - Pressure Transducer.....	19
Figure 3 - Equilibrium of Free Chlorine.....	3	Figure 28 - Optical Level Sensor.....	19
Figure 4 - Control Panel.....	4	Figure 29 - Optical Beam Path.....	19
Figure 5 - Remote Computer.....	4	Figure 30 - Water Level Assembly.....	19
Figure 6 - Schematic of Installation.....	7	Figure 31 - Erosion Feeder Control.....	20
Figure 7 - PC3000/5000 Cabinet.....	7	Figure 32 - Single Filter Backwash.....	21
Figure 8 - PC6000/7000 Cabinet.....	7	Figure 33 - Multiple Filter Backwash.....	21
Figure 9 - Mother Board.....	9	Figure 34 - On-screen Data Log.....	28
Figure 10 - Power Board.....	9	Figure 35 - Proportional Feed Rate.....	48
Figure 11 - Multiplex Connections.....	11	Figure 36 - CHEMCOM™ Program Menu.....	51
Figure 12 - Installation of Optional Boards.....	12	Figure 37 - CHEMCOM™ System Setup.....	51
Figure 13 - 4-20 mA Converter Board.....	12	Figure 38 - CHEMCOM™ Facility Menu.....	51
Figure 14 - Sensor Installation.....	13	Figure 39 - CHEMCOM™ Facility Selection.....	52
Figure 15 - Flow cell Assembly.....	13	Figure 40 - CHEMCOM™ Secondary Units.....	52
Figure 16 - Sensor Cell Cabinet (Option).....	13	Figure 41 - CHEMCOM™ Remote Operation Screen.....	52
Figure 17 - PPM Sensor Flow Cell.....	15	Figure 42 - CHEMCOM™ Automatic Scanning.....	53
Figure 18 - PPM Sensor Package.....	15	Figure 43 - CHEMCOM™ Scan Facilities.....	53
Figure 19 - ORP and pH Sensors.....	16	Figure 44 - CHEMCOM™ Manual Scanning.....	53
Figure 20 - Temperature Sensor.....	17	Figure 45 - CHEMCOM™ Recent Scans.....	53
Figure 21 - Conductivity Sensor.....	17	Figure 46 - CHEMCOM™ Data Display.....	54
Figure 22 - Flow Sensor Installation.....	18	Figure 47 - CHEMCOM™ Text Data Display.....	54
Figure 23 - Model 2536 Flow Sensor.....	18	Figure 48 - CHEMCOM™ Graphic Data Display.....	54
Figure 24 - Model 2540 Flow Sensor.....	18	Figure 49 - PORTA-PROBE™ Portable Tester.....	58
Figure 25 - Saddle for FS2536.....	18	Figure 50 - pH / mV Scale.....	58

## CHAPTER I - INTRODUCTION

Congratulations on your selection of a *CHEMTROL®* PC Programmable Controller for your water treatment facility.

*CHEMTROL®* Automation uses advanced electronic sensing technology to monitor and control the most control critical parameters in water, such as sanitizer activity, pH, temperature, conductivity or total dissolved solids (TDS). These are all essential to maintaining safe and enjoyable water.

### Water Maintenance

The primary purpose of water maintenance is to maintain clean and safe water that meets the bacteriological and physiological requirements of state and local Health Departments, as shown, for example, in the table for the State of California.

Equally important is protection of the equipment from the aggressiveness of water and its constituents.

The guidelines adopted by the National Spa and Pool Institute (NSPI), as shown in the second table.

For chemical automation, we recommend:

- adequate filtration with a maximum turnover rate of six hours for a pool or 30 minutes for a spa,
- proper water balance with a pH between 7.4 and 7.6, alkalinity between 80 and 120 ppm (mg/l) and Langelier Saturation Index between 0 and 0.3,
- a minimum Free Chlorine level of 1.0 ppm (mg/l) ,
- an Oxidation-Reduction Potential (ORP) above 650 mV,
- if required, stabilization not exceeding a cyanuric acid level above 40 ppm (mg/l),
- Total Dissolved Solids (TDS) less than 1,500 ppm (mg/l).

The *CHEMTROL®* PC is designed to automate and facilitate the attainment of these goals.

### Reference Manuals

For more information on water treatment, see the Maintenance section in this Instruction Manual or refer to one of the following reference manuals:

- **“Basic Pool and Spa Technology”**  
National Spa and Pool Institute (NSPI)
- **“Pool/Spa Operators Handbook”**  
National Swimming Pool Foundation(NSPF)
- **“Aquatic Facility Operator Manual**  
National Recreation and Park Association (NRPA).

<b>1986 CALIFORNIA HEALTH CODE for Swimming Pools</b>	
CLARITY	Main drain to be visible from deck.
STANDARD PLATE COUNT at 35°, per ml	Less than 200 Bacteria
TOTAL COLIFORM COUNT per 100 ml	Less than 2.2 organisms
PHYSIOLOGICAL QUALITY	No eye or skin irritation. No objectionable physiological effect.

TEST	MIN	IDEAL	MAX
pH	7.2	7.5	7.6
FREE CL, ppm			
Non-stabilized	1	1.5	2
Stabilized	1.5	2	3
Spa	2	3	5
COMBINED CL, ppm	0	0	0.2
BROMINE, ppm	2	3	4
OZONE, ppm	0.01	-	1
ORP, mV	650	750	-
CYANURIC ACID, ppm			
Outdoor Pool	30	40	100
Indoor Pool	0	0	0
Spa	0	0	100
TOTAL ALKALINITY, ppm	100	125	150
TDS, ppm	300	1000	3000
Based on Standards for Public Pools and Spas. Published in 1988 by the <b>NATIONAL SPA AND POOL INSTITUTE</b>			



## CONTROLLER FEATURES

The *CHEMTROL*<sup>®</sup> PC Controllers are microprocessor-based programmable controllers designed for automatic control of water chemistry, water balance and filtration in swimming pools, spas, cooling towers and industrial applications.

### New Features

This manual introduces two new features:

- on-screen data display, available on all models,
- the new solid state PPM sensor for Free Chlorine, available on the PC 5000 and PC 7000 controllers.

### Models

The manual covers four *CHEMTROL*<sup>®</sup> models: PC7000, PC6000, PC5000 and PC3000 (Figure 1 and Figure 2). Please refer to the sections corresponding to your options. The PC7000 and PC6000 include filtration control. The Free Chlorine sensor is included only with the PC7000 and PC5000. All other functions are similar.

### Automated Water Treatment

The *CHEMTROL*<sup>®</sup> PC controllers are advanced automation systems for water maintenance. Designed around a sophisticated microprocessor, the controllers display user-friendly menus and submenus on an easy-to-read LCD (Liquid Crystal Display) screen. All the displays and adjustments are accessible from menu screens that are laid out in a logical and intuitive order. They can in fact be used without reference to the instruction manual.

All sensing devices are connected to the central control module. That makes it possible to monitor the status of all operational parameters at a glance. Also, in case of malfunction or alarm, the operator is immediately alerted.

### Control Functions

The following display and control functions are:

- **Oxidation-Reduction Potential (ORP or Redox)** in millivolts with programmable oxidizer feed, superoxidation and chemical savings program,
- **Sanitizer Concentration** in parts per million (ppm) or milligrams per liter (mg/l) with programmable sanitizer feed, superchlorination and chemical savings program,
- **pH** from 0 to 14 with capability for acid and base feed,
- **Conductivity** in microsiemens/cm or **Total Dissolved Solids (TDS)** in ppm or mg/l with capability for programmed dumping and replacement of water and for addition of three different chemical additives, such as inhibitor, different biocides or probe cleaner.
- **Heater Control** with temperature display in degrees Fahrenheit or Celsius, programmable heater control and energy savings program,

- **Water Recirculation** with automatic programming or manual control of main pump plus display of flowrate in gallons per minute (gpm) or liters per minute (l/m) and cumulative flow in Millions of Gallons (Mga) or cubic meters (m3),
- **Water Balance and Saturation Condition** derived from the **Langelier Saturation Index** and showing water balance conditions as either OK, corrosive or scaling.
- **Filtration** with display of inlet and outlet pressure and programmable filter backwashing (PC7000 and PC6000 only) based on choice of time, inlet pressure, pressure differential or combinations of the above.

In addition, a 24-hour clock/calendar shows the date and time on the main screen. For models that do not include all the functions listed above, only the applicable screens and menus are shown.

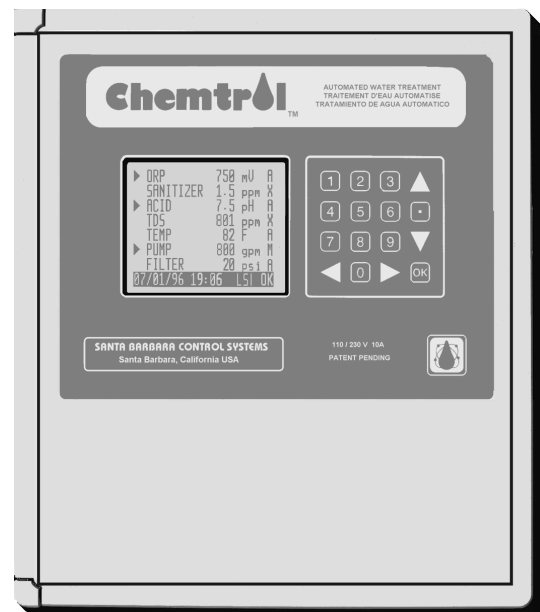

Figure 1 – PC6000/7000 Controller

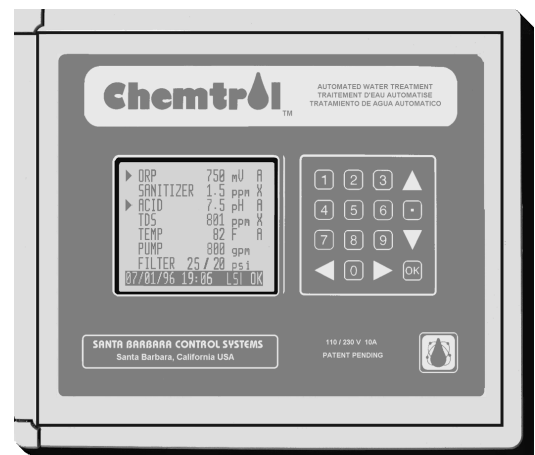

Figure 2 – PC3000/PC5000 Controller

## Sanitizer Control

The CHEMTROL® PC controllers offer two choices for sanitizer control:

- Direct chlorine control using a solid state sensor with a selective membrane for Free Chlorine (available on the PC5000 and PC7000 only),
- Oxidation-Reduction Potential control for chlorine or bromine using an ORP sensor with a platinum ring (available on all PC controllers).

### Free Chlorine

When chlorine in any form is introduced in water it forms Hypochlorous Acid HOCl, which is called Free Chlorine and is an excellent bactericide.

As shown in, HOCl is a weak acid. It dissociates to produce an hypochlorite ion OCl<sup>-</sup> and a hydrogen ion H<sup>+</sup>:

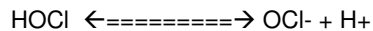

Free chlorine in water is therefore always present in two forms:

- Hypochlorous acid HOCl, which is Fast Acting Free Chlorine,
- Hypochlorous ion OCl<sup>-</sup>, which is a much slower acting sanitizer.

Note in that the concentration of HOCl decreases very rapidly with increasing pH in the range of 7 to 8. At a pH of 7.5, it is equally divided between HOCl and OCl<sup>-</sup>.

### Free Chlorine control

The CHEMTROL® PC7000 and PC5000 include true Free Chlorine control using a solid state sensor with a selective membrane for Free Chlorine.

The controller displays the concentration of Total Free Chlorine (HOCl + OCl<sup>-</sup>) in PPM (parts per million or milligrams/liter). It does not respond to Bromine and is not affected by oxidizers.

The Free Chlorine display does not vary with pH.

The PPM setpoint default value on the controller is 1.0 ppm, which is recommended to kill germs and bacteria and maintain good water quality. It can be adjusted to meet local conditions and Health Department requirements.

### ORP control

The oxidizing activity of the sanitizer (chlorine or bromine) can be monitored with a special electrode for Oxidation-Reduction Potential, called ORP or Redox.

ORP does not measure sanitizer concentration but only the activity of the more active forms: HOCl or HOBr. As shown in, their concentration varies with pH. Therefore, for ORP control, it is important to maintain a constant pH in the water.

## DISSOCIATION OF CHLORINE

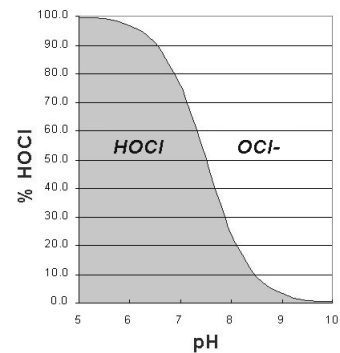

Figure 3 - Equilibrium of Free Chlorine

ORP readings are measured in millivolts (mV). They are valuable because they provide an excellent index of bacteriological water quality.

In 1971, the third edition of the "International Standards for Drinking Water Quality" of the **WORLD HEALTH ORGANIZATION (WHO)** stated:

*"A redox potential of 650 mV (measured between platinum and calomel electrodes) will cause almost instantaneous inactivation of even high concentrations of virus. Such a potential can be obtained with even a low concentration of free chlorine but only with an extremely high concentration of combined chlorine."*

In 1985, a study of thirty commercial spas by the **OREGON DEPARTMENT OF HEALTH** also confirmed 650 mV to be the minimum value required to prevent growth of germs and bacteria. Public pools and spas in many European countries are required by law to maintain an ORP level of 750 mV or more.

In the US, the 1988 revision of the Standards for Public Spas published by the **NATIONAL SPA AND POOL INSTITUTE (NSPI)** states:

*"When chlorine or bromine is used as a primary disinfectant, ORP can be used as a supplemental measurement of proper sanitizer activity. The recommended minimum is 650 mV with no ideal and no maximum. The use of ORP testing does not eliminate the need for testing the sanitizer level with standard test kits."*

## Probe Failure Analysis

All CHEMTROL® PC controllers include the exclusive safety feature called Probe Failure Analysis.

With this proprietary technology (US Patent No. 5,895,565), the controller continuously monitors and tests the dynamic response of the ORP and pH sensors (see page 28). This important feature allows early detection of probe failure, thereby avoiding the dangerous out-of-range conditions that can develop with other controllers.

Other controllers have to wait until there is an out-of-range or an alarm condition in order to alert the operator. This could result in serious damage and liability.

Figure 4 - Control Panel

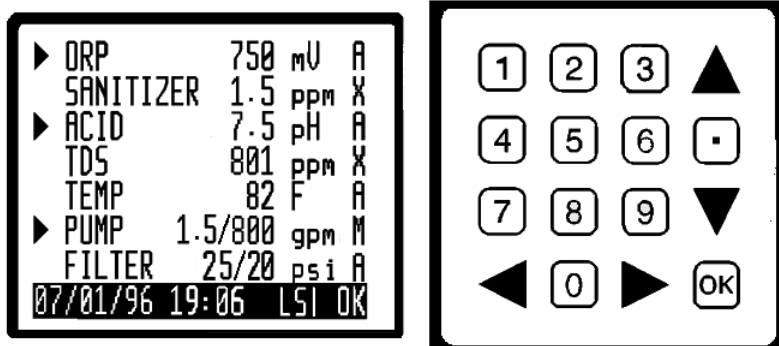

## CONTROL PANEL

### LCD Display Screen

The operator interacts with the controller with the LCD display screen and the 16-key data entry keyboard on the front panel, both shown in Figure 4.

The display shows eight lines of text that can be scrolled up and down with the UP and DOWN ARROW keys to highlight each of the menu lines.

The LCD display shows either "normal" characters (black on white), or reverse characters (white on black) to highlight selected options, or also flashing characters to alert alarm conditions.

The brightness of the LCD display screen is adjusted at the factory before shipping. If required, it can be re-adjusted at any time with the potentiometer on the Mother Board (Figure 9) inside the cabinet. It is located near the center of the board and marked R39.

The LCD display screen features backlight illumination for better viewing at night and in dark areas. To protect the display, the backlight turns off automatically after a short time. It turns on again as soon as a key is pressed.

### Display Readings

As shown on the Display Screen (Figure 4), the operator can check all operating parameters at a glance.

Line 1 shows an **ORP reading of 750 mV** with the feed pump in Automatic feed mode (A) and running (>).

Line 2 shows a **Sanitizer level of 1.5 ppm** with the feed mode OFF (X).

Line 3 shows a **pH reading of 7.5** with the Acid feed mode in Automatic (A) and the pump not running (no >).

Line 4 shows the **Total Dissolved Solids (TDS)** at 801 ppm and bleed valve control OFF (X).

Line 5 shows a **Temperature reading of 82 F** with the heater control on Automatic (A).

Line 6 shows **Flow Rates of 1.5 and 800 gpm** in the Bypass line and Main line and the Pump in Manual mode (M).

Line 7 shows an **Influent Pressure of 25 psi**, an **Effluent Pressure of 20 psi** and the backwash program in Automatic mode (A).

Line 8 shows the **Date and Time** and an indication that the **water saturation condition is OK**. The line is highlighted to give access to the Configuration Menu.

### Data Entry Keyboard

The data entry keyboard replaces the knobs and switches of conventional controllers. All operational entries such as choice of operational mode, calibration, control setpoints, alarms and programming are performed with the 16 keys of the keyboard.

The keyboard consists of a full 16-key numeric keypad. There are ten digits from "0" to "9" plus the decimal point "." for data entry.

The operator navigates through all the menus and submenus with four directional arrow keys: UP, DOWN, LEFT, and RIGHT.

### Remote Communications

The *CHEMTROL®* controller features remote operation by computer (Figure 5).

Unlike less advanced controllers, the *CHEMTROL®* PC operates in true duplex mode with full access to all menus and submenus.

This means that any change on the controller screen is immediately reproduced on the remote computer screen. And vice versa, any operation that is performed on the remote computer screen is reproduced immediately on the controller.

The same commands are available on both units. This facilitates operator training and allows instant verification and adjustment of all control parameters. Changes in parameter settings are subject to password verification to prevent unauthorized access.

Figure 5 - Remote Computer



**PROGRAM MENUS**

**Initial Screens**

When power is applied to the controller, the *CHEMTROL®* PC displays the Welcome Screen shown on the right. It includes the version of operating software installed on the controller and the numbers for Technical Support from the factory by phone 805-683-8833 or by fax 805-683-1893. In the USA and Canada, technical support is also available toll-free at 800-621-2279.

These screens can also be accessed at any time from the Main Display Screen by pressing the LEFT ARROW key.

**Display Screens**

The Welcome Screen is followed by one of the display screens, as shown on the right. The PC7000 and PC5000 show 8 lines of display.

The Display Screen is the normal monitoring screen. It displays several lines of information, one for each operating function and one for system conditions.

The underlines        on this screen, and all menus and submenus, show operator adjustable entries, selections and calibrations.

Each line displays operational information on five columns, from left to right:

1. operational status (ON or OFF) with a small arrow indicating outlet activation,
2. function identification: ORP, SANITIZER, pH, CONDUCTIVITY, TEMPERATURE, PUMP and FILTER,
3. Sensor readings,
4. units of measurement (US or metric),
5. operational mode, represented by a single letter:

- A for automatic control,
- M for manual operation,
- T for timer control,
- X for OFF.

**Main Menus and Submenus**

As shown on the Menu Tree included in the manual, there are several Main Menus that are accessed directly from the Display Screen, one for each operating function and one for system configuration. The submenus are additional menus that are accessed from one of the main menus or other submenus.

Navigation through the menus is done with the four arrow keys located on the front panel keypad. To access any menu or submenu, use the UP and DOWN ARROW keys to highlight the desired line and press the RIGHT ARROW key. To exit from any menu or submenu, press the LEFT ARROW key.

In this chapter, each menus and submenus is identified by its on line number. It provides a road map for quick location.



Welcome Screen

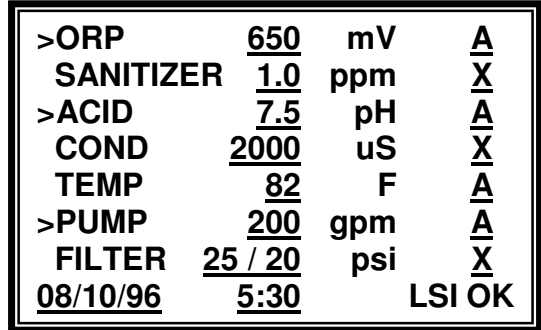

PC7000 Main Display

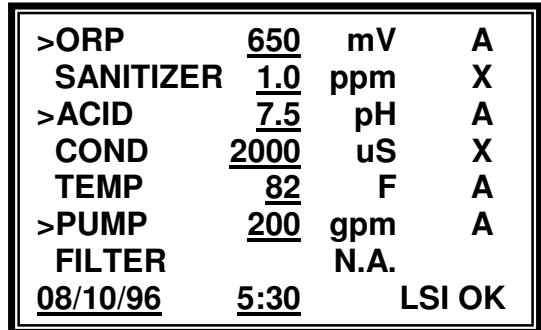

PC5000 Main Display

**Alarm Displays**

Probe failure, out-of-range and overfeed conditions are indicated on the Display Screen and on the Main Menus with flashing characters. For probe failure, the display flashes "Probe" on the corresponding line.

If the display shows an out-of-range or overfeed alarm condition, press the DOWN ARROW key to the flashing line and enter the submenu with the RIGHT ARROW key to determine the cause of alarm.

## CHAPTER II - INSTALLATION

### SAFETY NOTICE

See important safety information on the first page of the manual.

### UNPACKING

Immediately upon receipt of your shipment, check the shipping carton carefully for damage and report any damage directly to the shipping company. Please report any shortage immediately to the factory.

Before opening the carton, check the outside label and verify the model number, voltage, tee size and feed mode. Unpack the carton carefully, taking care not to lose any of the smaller parts, such as PVC fittings.

The controller carton should include the following:

- Controller Cabinet,
- Sensors as required for selected model,
- Instruction Manual and Warranty Card,
- Installation Report to be mailed back to factory upon completion of installation,
- Bypass Line Assembly (Optional).

### INSTALLATION REPORT

The Installation Report is a triplicate form designed to assure warranty coverage, technical updates and factory support.

1. White copy: to mail back to factory.
2. Pink copy: to Facilities Manager.
3. Yellow copy: to Qualified Dealer.

Upon completion of installation, it must be filled out and signed by the Qualified Dealer and by the facilities manager.

### TECHNICAL SUPPORT

Please take the time to read this detailed Instruction Manual to insure proper installation and operation. If you need further technical assistance, you can contact your Qualified *CHEMTROL®* Representative, call our Technical Department toll free at 800-621-2279 or e-mail us at [chemtrol@sbcontrol.com](mailto:chemtrol@sbcontrol.com).

### PRINCIPLE OF INSTALLATION

The *CHEMTROL®* PC constitutes an integrated command center for complete monitoring and control of all water treatment operations, including chemistry, filtration, heating recirculation pump and water level.

All information provided by the sensors is processed by the microprocessor on the Mother Board and displayed on the Main Display screen. Command signals are then sent to the different control outputs on the Power Board (see ELECTRICAL below).

The schematic of installation in Figure 6 shows the principle of installation for the *CHEMTROL®* PC7000 with all options installed. **Error! Reference source not found.** and **Figure 16** show the details of installation for the bypass line and sensor cell assembly.

### CONTROLLER CABINET

The *CHEMTROL®* PC controller is contained in a rain proof and splash proof NEMA Type 3 cabinet.

The external dimensions of the cabinets and the positioning of the mounting holes as shown in Figure 8.

For ease of installation, there are two external mounting ears on the top of the cabinet.

All the electronic and electrical components are mounted inside the cabinet on two separate PC Boards, the Mother Board (Figure 9) and the Power Board (Figure 10). Outlets are provided on the bottom of the cabinet for 1/2" conduits connectors.

### LOCATION

Mount the cabinet on a wall in a secure location:

- more than 10' (3 m) away from the water edge to comply with electrical code requirements,
- within 10' (3 m) of the main recirculation line or of the bypass line - unless special extension cables are used for the sensors (see Sensor Cables),
- not exposed to direct sunlight as the LCD display screen will darken at high temperature,
- easily accessible to maintenance personnel,
- if possible in a separate room, or in a well-ventilated room as far away as possible from corrosive chemicals and storage tanks,
- at a safe distance from power transformers, pump motors or high voltage power lines,
- safe from unauthorized access or vandalism

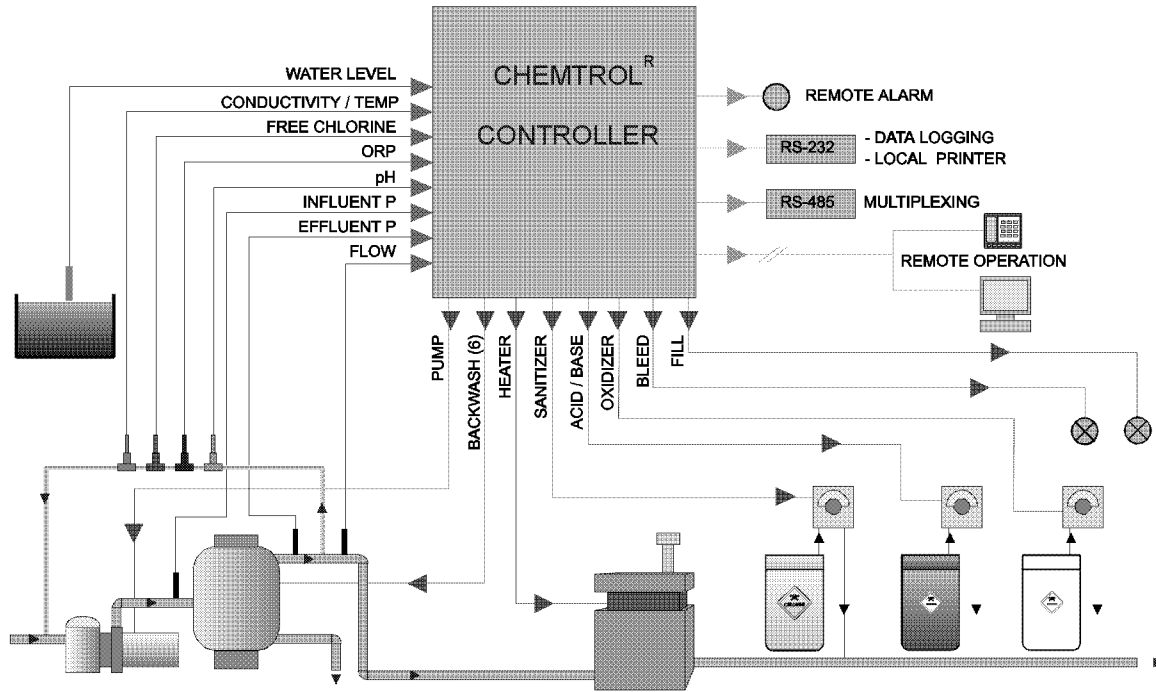

Figure 6 - Schematic of Installation

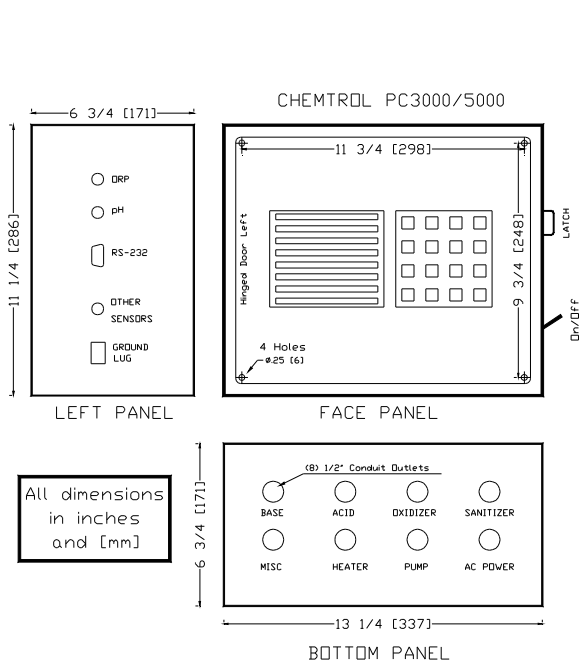

Figure 7 - PC3000/5000 Cabinet

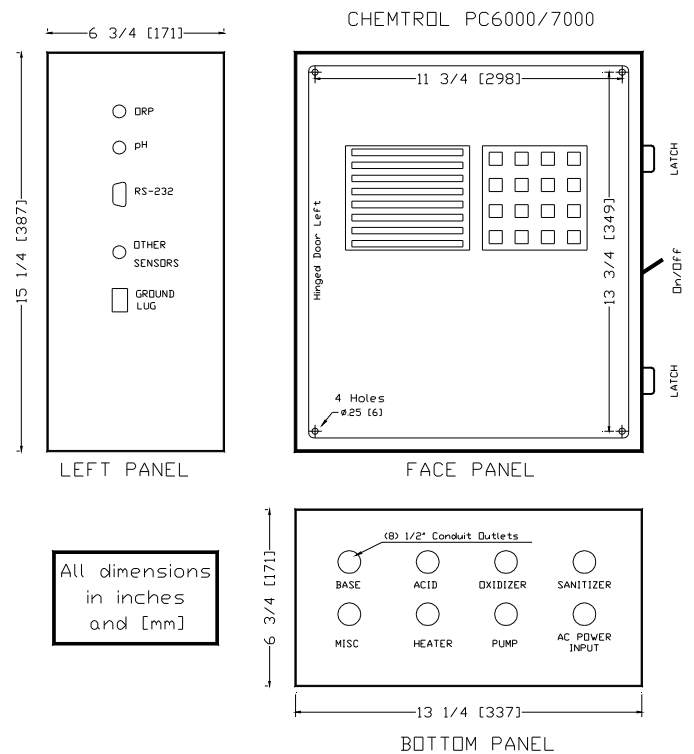

Figure 8 - PC6000/7000 Cabinet

## ELECTRICAL

### Electrical Codes

**INSTALLATION MUST FOLLOW  
ALL APPLICABLE ELECTRICAL CODES**

The controller is available in either hard-wiring or plug-in configurations. Make sure to use the proper type of wiring according to the local electrical code, usually the same as for the chemical feeders.

The internal wiring and labeling for the Power Board of the controller (Figure 10) are as follows:

		RELAYS	POWER IN
GREEN	GROUND	GND	GND
BLACK	HOT	NO1	L1
WHITE	NEUTRAL	NO2	L2

### AC Power Input

The *CHEMTROL®* PC is a dual-voltage controller with a voltage selector switch located inside the cabinet on the Power Board (see Figure 10). Before connecting the unit to an external power supply, make sure that the voltage selector switch is set to the proper AC power input: 115 V or 230 V.

**CAUTION:** Damage resulting from improper voltage selection is not covered by manufacturer warranty.

### Grounding (GFI)

A grounding lug is provided on the right side of the cabinet. It is important to connect it to a proper earth ground to prevent dangerous current leakage and electrical shock. Ground Fault Interruption (GFI) protection is also strongly recommended for all installations.

### Main Power Interlock

To prevent accidental chemical feeding, the controller and the chemical feeders should always be interlocked - i.e. wired in parallel - with the manual switch for the main pump. This prevents feeding chemicals when there is no water flow in the recirculation line.

### Panel Interlock

For safety of operation, a panel interlock switch is mounted inside the cabinet to shut off all internal power when the control panel is open.

**DO NOT ATTEMPT TO DEFEAT ITS PURPOSE !!!**

## PC Boards

The *CHEMTROL®* PC controllers use two PC boards:

- a Mother Board (Figure 9) located behind the front panel contains the software, memories and operating electronics,
- a Power Board (Figure 10) located in the back of the cabinet and containing the power input and the output relays.

The two boards are connected together with a ribbon connector.

The schematics in Figure 9 and Figure 10 show the location of the key components. In addition, the components are also labeled on the PC boards themselves.

The PC boards are protected with a 1 A fuse located on the Power board. It is mounted on the upper right of the Power Board and marked F2. If the fuse has to be replaced, make sure to use a 1 A fuse only. The use of a larger fuse may cause irreparable damage to the electronic boards.

### Power Board

The Power Board (Figure 10) is mounted on the back panel of the controller cabinet. As shown on the schematic, it contains all the high voltage (115 or 230 V) circuits and components for inputs and outputs.

### 115V/230V Power Transformer

The *CHEMTROL®* PC is equipped with a switchable, dual voltage power transformer that is mounted on the Power Board inside the cabinet.

The voltage selector switch is located near the upper right of the board. Always verify that the switch is set to the correct voltage, either 115 or 230V. Connecting the controller to higher voltage may cause damage to the electronics that is not covered by the manufacturer's warranty.

### Relay Jumpers (PC7000)

The PC7000 and PC5000 use two jumpers (J1 and J2) on the Power Board (Figure 10) to determine the connections for five of the output relays. These jumpers are normally set at the factory and should only be changed by a Qualified *CHEMTROL®* dealer.

The pin connector must be set to **Filter** for automatic backwashing according to the program set in the Filter Menu.

The **TDS** connection is used in CT6000 cooling tower controllers for dump and fill valves and for chemical additives feeders.

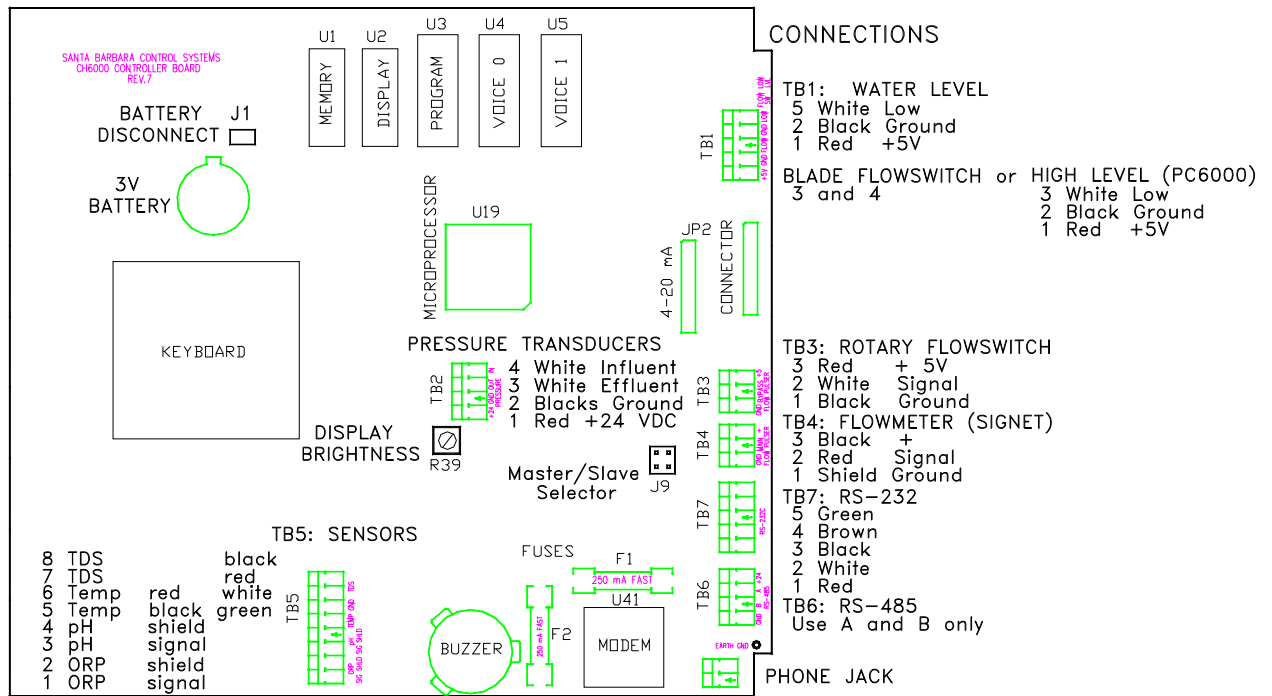

Figure 9 - Mother Board

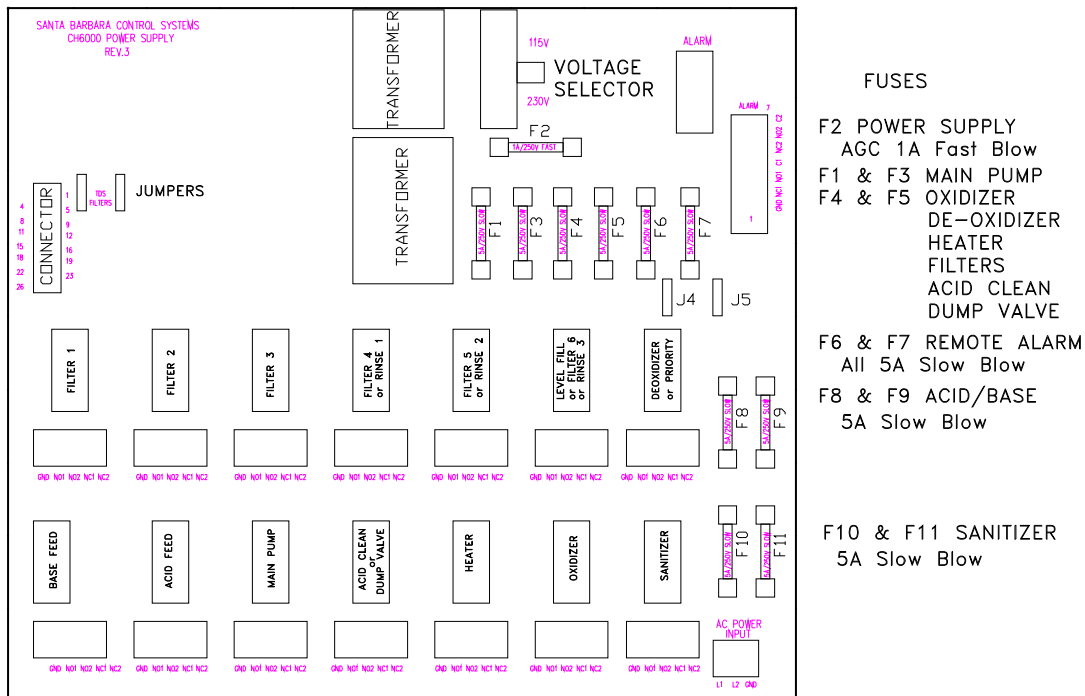

Figure 10 - Power Board



## Relays and Fuses

**NOTE:** *The fuses for the Power Supply to each PC board are AGC-1 Fast Blow. The two modem fuses are 250 mA Fast Blow.*

All other fuses for relay outputs are 5A Slow Blow. All output relays are fused on the Normally Open (NO) and Normally Closed (NC) sides. Both the Hot and the Neutral sides are fused with 5A Slow Blow fuses.

Make sure not to overload the relays. Chemical feed pumps normally draw less than 5A. If a pump draws more than 5A, it will need a motor starter or a magnetic switch.

**NOTE:** Not all relays may be included on the Power Board, depending on specified options.

### Remote Alarm

The remote alarm is a 5A DPDT relay located on the upper right corner of the Power Board. The remote alarm relay can be set for dry or hot contacts, or for any external signal.

*To avoid damaging the Power Board, make sure to use the right type of contacts. Call your dealer or the factory if you are not sure.*

With hot contacts, the controller powers the alarm with 110 or 230V, depending on the setting of the input voltage of the controller (see preceding page). Connect the leads to the alarm to the Normally Open contacts (NO1 and NO2) on the terminal strip located next to the alarm relay.

With dry contacts, remove the two shunts from J1 located just below the fuses marked F7 and F8. Wire the remote alarm to NO1 and C1.

For an external power source, wire the input power to the terminals marked NC1 and NC2. Wire the remote alarm to the normally open contact (NO1 and NO2). The alarm voltage will be the same as the external power source.

### Mother Board

The Mother Board (Figure 9) is mounted directly behind the face panel of the controller and contains all the low voltage circuitry including the microprocessor and program chips, the LCD display and the keyboard pad. It is also used to connect all the sensor inputs.

The key electronic components are the microprocessor and the programmable chips for Program, Display and Memory. The program chips are located in the center at the very top of the board. They can be replaced for upgrading of the software program, which should be done only by an experienced technician.

### Sensor Connections

All sensor connections are on the Terminal Barrier strips on the Mother Board, as shown on Figure 9. The pH and ORP sensors are connected externally to the bulkhead BNC connectors on the left side of the cabinet.

The temperature sensor has two leads, black and red. The combined conductivity/temperature sensor has four leads: white, green, red and black. Connect all leads as shown on the Mother Board schematic (Figure 9).

The color coding for the connections are as follows.

TB1 - Level control sensor and blade-type flow switch (PC3) or high alarm sensor (PC6)

5 = Low	White wire from level sensor
4 = Ground	
3 = Flow switch	NO f/s wire or white wire high alarm
2 = Ground	Black wires
1 = +5vdc	Red wires from level sensors

TB2 - Pressure transducer

4 = In	White wire from influent transducer
3 = Out	White wire from effluent transducer
2 = Ground	Black wire
1 = 24vdc	Red wire from transducers

TB3 - Bypass line flow pulser

3 = +5VDC	Red wire
2 = Signal	White wire
1 = Ground	Black wire

TB4 - Main flow pulser (Signet)

3 = +	Black
2 = Signal	Red
1 = Ground	Shield

TB5 - Temp & TDS, pH, ORP

8 = TDS	Black
7 = TDS	Red
6 = Temperature	White Red
5 = Temperature	Green Black
4 = pH	Shield
3 = pH	Signal
2 = ORP	Shield
1 = ORP	Signal

TB6 - RS-485 Communications

Connect to A and B only, for multiple serial installations, using Host/Slave configurations (see Remote Communications below).

TB7 - RS-232 Communications

5 = Green
4 = Brown
3 = Black
2 = White
1 = Red

### Buzzer

The buzzer is located near the bottom of the Mother Board, as shown on Figure 9. It can be turned on for specific alarm conditions through the software program or for all alarms using the Audio Alarm Submenu 8.2.1 (see page 27).

### Display Brightness

The brightness of the display can be adjusted with the potentiometer marked R-39 that is located in the center of the Mother Board (Figure 9).

**Backup Battery**

The 3V Backup Battery is located on the left side of the Mother Board (Figure 9). It is used to maintain the memory settings in case of loss of AC power. This battery is designed to last for several years in normal operation.

Under normal conditions, the controller will operate without battery power. However, the clock and other memory settings will have to be restored in case of complete power shutdown. Replace the battery if the voltage falls below 2.6 V. The voltage is displayed in Configuration Menu / Battery Submenu.

**Remote Communications**

The Remote Communications option connects the modem with a standard US-type, 6-position RJ12 phone jack located on the center right hand side of the Mother Board (Figure 9).

If possible, connect the controller to a direct outside telephone line dedicated for remote operation. If the line is also used for voice communications, users should wait for at least three rings to allow the modem to answer a call.

The modem is a combination Data/Fax/Voice multimedia device registered by the Federal Communications Commission (FCC), Number B46USA-22429-MN-E.

MODEM SPECIFICATIONS	
FCC Registration Number B46USA-22429-MN-E	Ring Equivalency Number (REN) 0.2 A

The Ring Equivalency Number (REN) is 0.2 A. Most telephone companies require that the sum of all devices connected to a telephone line do not exceed 5. If a problem arises as a result of operating this equipment, you may have to provide information about this modem to the Phone Company or to the FCC. If the equipment causes disruption to the telephone network, the Phone Company may disconnect your service.

**Multiple Serial Connections (Option)**

Up to thirty (30) CHEMTROL® PC controllers can be multiplexed to a single phone line or a single computer line by using a network consisting of a host and several slaves. The connections are made through RS485 Serial Ports (Option RS485).

Different models of CHEMTROL® PC controllers can be mixed and matched in a network. Each controller has its own ID number. This number is set up through software in the Communications Submenu 8.3.1 (see Page 30)

As shown in Figure 11, the host controller includes a modem and an RS485 connection (Option REM). It is connected to the telephone line by modem or to a computer equipped with an RS485 communication card. The slave units need only an RS485 connection (no modem needed) and an internal ID number.

Any controller can be set up at any time as either host or slave by orienting the jumper JP9 as marked on the motherboard (Figure 9).

The slave units must be located within 3,000 feet of the host controller and connected with two Category 5 wires (one pair). The RS485 terminal has four terminals, only two of which, marked A and B, are used. Each unit must be wired A to A and B to B for proper communications. The slave units can be connected directly to the host unit or through any other slave units.

**CAUTION:** Do not wire the connections marked 24 VDC or GND on the RS485 terminal. This could cause serious damage to the terminal.

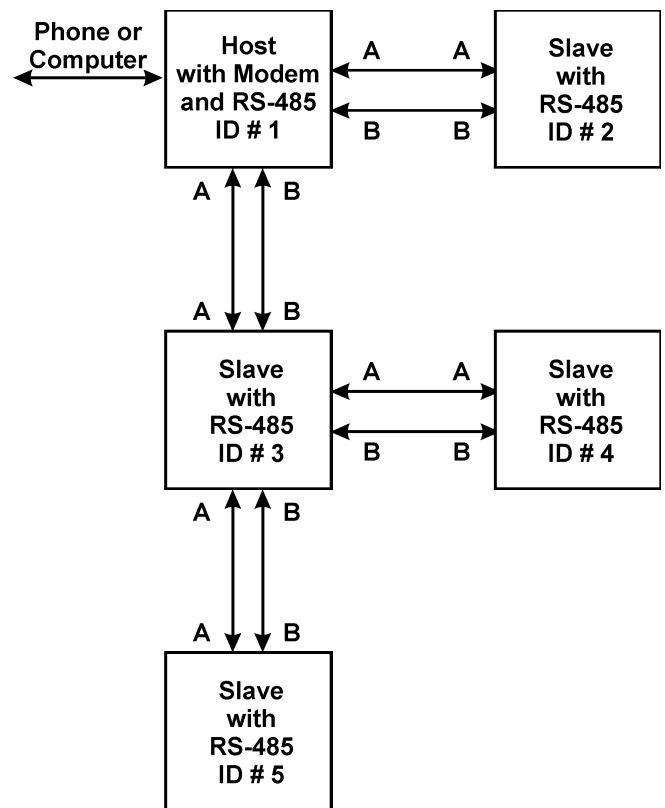

**Figure 11 - Multiplexed Connections**

**4-20 mA Converter Boards**

The 4-20 mA Converter Boards are two optional piggyback boards. They convert the digital outputs of the controller (sensor or control outputs) into analog signals that can be used by analog monitoring and control equipment.

The two boards are identical and are normally installed at the factory on the motherboard before shipping, as shown in (Figure 12). The location on the motherboard determines the function, i.e. sensor signal or control outputs. Either one of the boards or both can be installed, depending on requirements.

If the boards are installed properly, the controller software automatically shows the 4-20 mA menu line in the Submenu 8.3 - Communications.

**Field Installation**

For field installation, turn off all power to the controller. Position the converter board on top of the motherboard as shown on Figure 12. Press the electrical connector J21 into the socket of the motherboard marked JP1 (or JP2 depending on option) and the three plastic standoffs fittings into the three corresponding holes on the motherboard.

**4-20 mA Connections**

Figure 13 shows the connections for each Converter Board. Determine the type of signal required by the host system. There are two types of signals used in 4-20mA communications, Internal source or external sink. Each communication channel has four sets of jumpers that must be shunted to the proper setting. (Please note that the factory settings are generally for internal source).

The 4-20mA output signals from the board are located on the terminal boards marked TB1 and TB2. Each channel has a + and - indication corresponding to the markings on the board.

The 4-20mA Signal Board has five communication channels for pH, ORP, TDS, temperature and PPM readouts. Each analog signal requires two wires for connection to the central monitoring system.

The 4-20mA Control Board also has five pump control channels for acid, sanitizer, oxidizer, deoxidizer and base feed. Each analog control signal requires two wires for connection to the corresponding pump.

**PPM Sensor Board**

For new controllers, the PPM sensor board is already installed on the lower left quadrant of the motherboard, as shown in Figure 9.

For upgrades and retrofits, the PC board can be easily installed on the motherboard.

At the bottom of the keypad between **S15 / S16** locate the jumper marked **JP3**. Insert the black pin receptacle on the back of the PPM board into the **JP3** pin connector. The two plastic standoffs located on opposite sides of the pin receptacle will snap into the two holes on the motherboard to secure it.

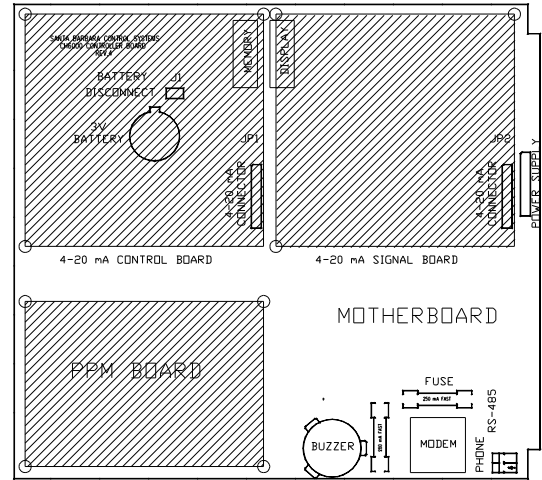

**Figure 12 - Installation of Optional Boards**

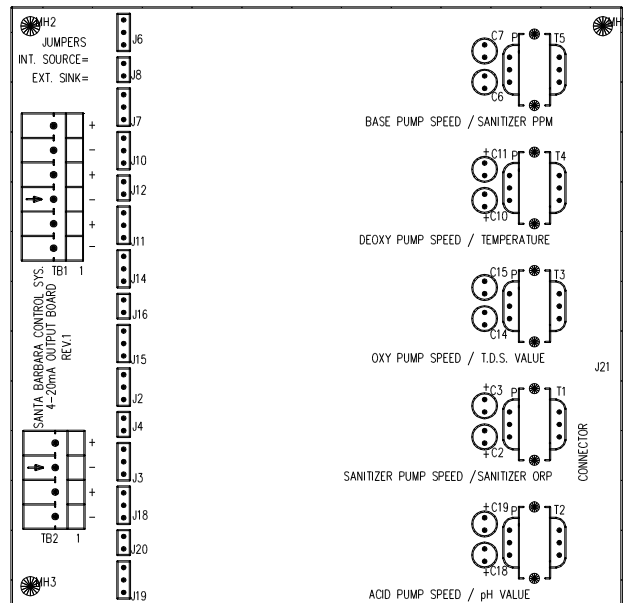

**Figure 13 - 4-20 mA Converter Board**

**PLUMBING**

This section covers the installation of the sensors and the connection of the chemical feeders or control valves.

All chemical injection should be done on the return line, i.e. downstream of the sensors and pool equipment, as explained in the Chemical Feeders section.

**Installation of Sensors**

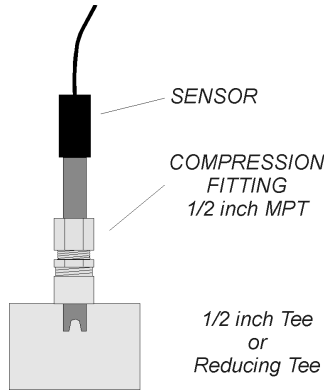

**Figure 14 - Sensor Installation**

The CHEMTROL® PC controllers use up to nine different sensors for measurement of water chemistry, temperature, flow rate, pressure and water level:

- amperometric sensor for Free Chlorine,
- potentiometric sensors for pH and ORP,
- thermistor for temperature,
- conductivity sensor for Total Dissolved Solids,
- Hall effect pulse generator for flow rate,
- piezoelectric sensors for influent and effluent pressures,
- electro-optical water level sensor.

The first five sensors measure water chemistry (Free Chlorine, ORP, pH, conductivity and temperature). These can be mounted directly on a 2-inch main recirculation line using PVC reducing tees Figure 14). On larger diameter lines, they must be mounted on a 1/2-inch bypass line - using a Sensor Cell Cabinet (Figure 16).

**In-line Installation (2" Pipe)**

On smaller installations (2 " pipe diameter), the sensors can be mounted directly on the main recirculation line between the strainer and the pump (Figure 14).

Use only 2x2x1/2 in. SST reducing tees without reducers. Do not install the sensors near an elbow or a constriction where there might be excessive turbulence.

Install the tees on the suction side of the pump and make sure that the tip of the sensor is oriented downward - as shown in Figure 14 - to avoid formation of air pockets near the tip. The sensors should be readily accessible for servicing but not exposed to physical damage.

After inserting the sensor, be careful not to overtighten the compression fitting as it can crush the small glass tube inside the sensor. Make it finger tight (no wrench).

**Flow Cell Assembly**

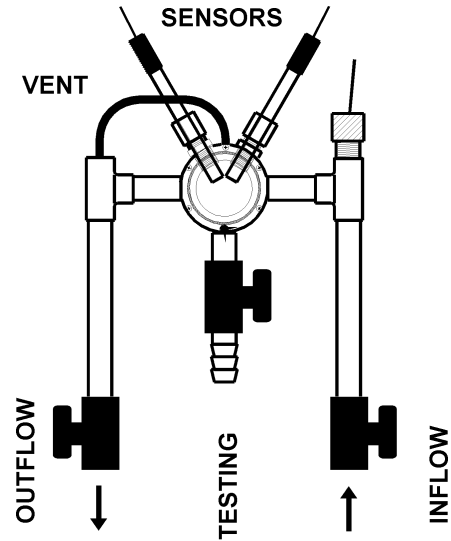

**Figure 15 - Flow cell Assembly**

For ease of installation and maintenance, the sensors should be mounted on the Flow Cell Assembly, as show above. It includes a sensor cell with an air vent and a clear cover, two compression fittings for the ORP and pH sensors, a water sampling tap and two ball valves for controlling the water flow in and out.

**Sensor Cell Cabinet (Option)**

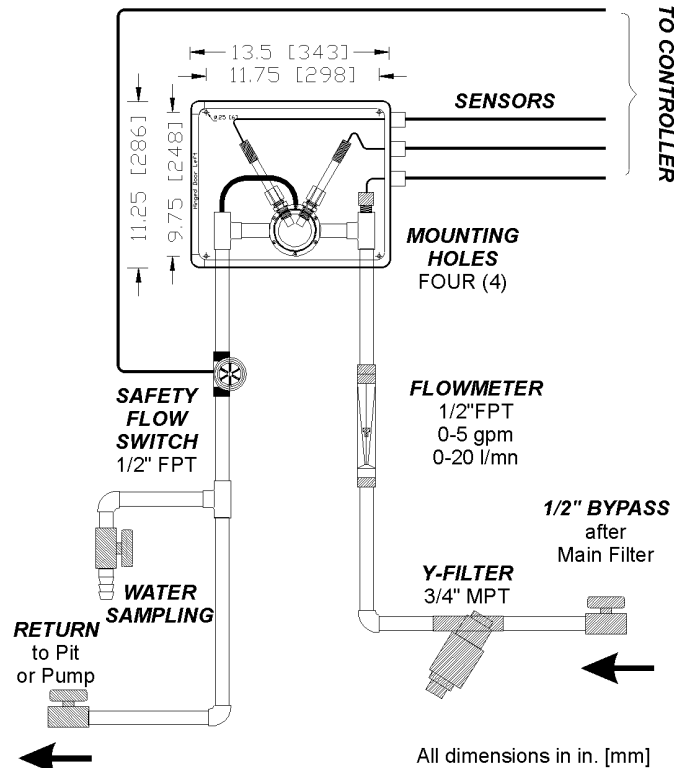

**Figure 16 - Sensor Cell Cabinet (Option)**

For even greater ease of installation and maintenance, the components of the bypass line assembly can be supplied in a pre-plumbed Sensor Cell Cabinet (also called Wet Box). The Flow Cell Assembly is mounted in a fiberglass cabinet containing the sensor cell assembly. Also included is a Y-filter, a flowmeter and a paddle wheel safety flow switch. Install on a ½" bypass line, as shown in **Figure 16**,

Make sure that the Sensor Cell Cabinet is located within 2' (60 cm) of the controller cabinet or order sensor extension cables (see Sensor Cables). See wiring instructions in the ELECTRICAL section and operational instructions under WATER FLOW below.

### Water Flow

Proper flow of water past the sensors is essential to obtaining good readings. To check the water flow in the bypass line, start the main recirculation pump. Open both the intake and the return valves on the bypass line and read the flow rate on the flowmeter. It should be in the middle of the range, i.e. about 2-3 gpm (about 8 to 12 l/min). If the water flow is too high, reduce it by closing down the valve on the RETURN SIDE of the bypass line. If there is no water flow, replumb the bypass line as shown on the schematic.

**NOTE:** The most common installation problems with bypass line or wet box installations are caused by faulty hydraulics.

To ensure proper water flow, make sure that the bypass line is properly connected. The intake side should be off the pressure side of the recirculation system, i.e. after the filter. The return side should be to a low-pressure area - such as the vacuum side before the recirculation pump, or downstream after the heater, or atmospheric pressure in the pit of a vacuum sand filter or balancing tank.

### Paddle Wheel Rotary Flow Switch

The Rotary Flow Switch is a safety switch for the bypass line.

The switch contains a transducer that generates an electrical signal proportional to the water flow. The relay trip point is factory adjusted for a minimum flow rate of 1 gpm (about 4 l/min). (*Make sure to use the flow restrictor included in package*).

**CAUTION:** *Improper wiring will result in switch burnout (not covered under warranty).*

The black, red and white leads should be connected to the contacts marked "BYPASS FLOW PULSER" on the terminal board marked TB3 on the right side of the Mother Board (Figure 9), as indicated:

BLACK	Ground
WHITE	Signal
RED	+ 5VDC or +24 VDC

## PPM SENSORS

### New PPM Sensors

The following new, improved PPM Sensors (Model 2010) are available with PC controllers:

- PPM002 for 0-2 PPM (mg/l) of Free Chlorine
- PPM010 for 0-10 PPM (mg/l) of Free Chlorine

Both use the same membrane Part Number PPM01

- PPM200 for 0-200 PPM (mg/l) of Free Chlorine with membrane part number PPM02

- PPMSLT 0-10 PPM Membraneless Sensor for electrolytic chlorine generators.

### NOTES

1. These new sensors are not affected by cyanuric acid - therefore the new CH255/265 (Version 2010) have no GAIN FACTOR adjustment.

2. All sensors use the same flow cell PPMCLL and do not require the plastic spacer ring.

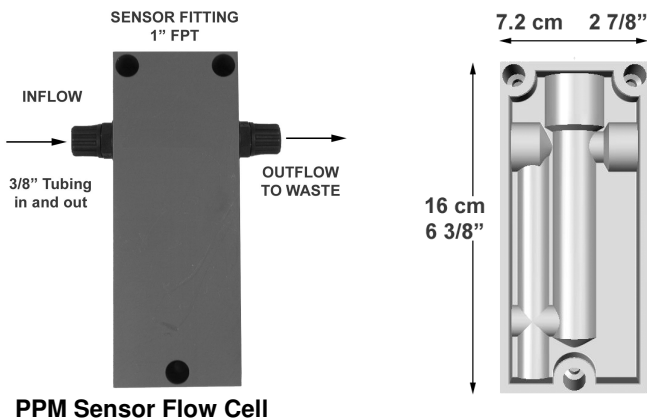

**Figure 17 - PPM Sensor Flow Cell**

The PPM Sensor must be installed in the specially designed flow cell for better water flow control. Install the flow cell on a bypass line with 3/8" tubing as shown above.

Make sure that the bypass line is located after the filter and that there is a sufficient but not excessive flow of water. The recommended flow rate is between 20 to 100 l/h (0.1 to 0.6 gal/min.) with a best value of about 30l/h (0.2 gal/min.).

### SPAS

For a spa, it is recommended to increase the flow rate sufficiently to avoid the formation of air bubbles and to install the cell horizontally with the inflow coming in from the bottom.

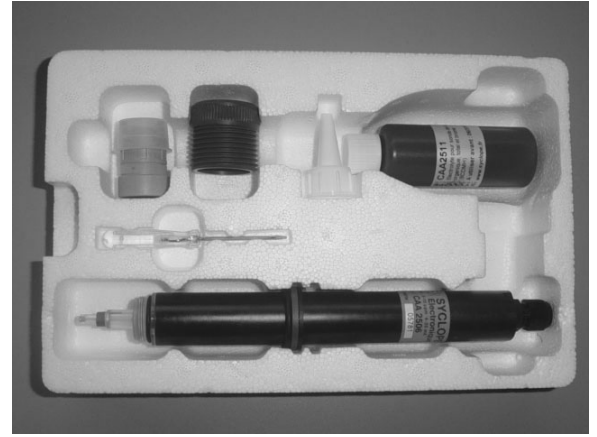

**Figure 18 - PPM Sensor Package**

### PPM Sensor Installation

The new PPM Sensors are shipped in a molded foam package containing:

- One (1) chlorine sensor with warranty serial number,
- One (1) compression fitting with O-ring,
- One (1) electrolyte cap with membrane,
- One (1) electrolyte bottle and screw-on filling tip,
- One (1) screwdriver (not needed if pre-wired).

In order to prevent serious damage to the sensor, be careful not to touch the membrane or the electrodes. To facilitate shipment and storage of the sensor, it is not fitted with the electrolyte cap until ready for installation. The sensor cap must be filled with the electrolyte solution immediately before usage and emptied during storage.

Fill the sensor cap with the electrolyte taking care to prevent air bubbles. Fill the cap to the bottom of the threaded section. Thread the sensor into the cap as far as it will go while making sure not to touch the membrane film at the bottom with your fingers. Excess air and electrolyte may escape through the hole below the rubber seal. Wipe any excess electrolyte with a soft tissue. Contact your CHEMTROL<sup>(R)</sup> dealer if you need additional electrolyte.

Slide the O-ring over the sensor tip up to the compression ring. Finally, insert the sensor with O-ring in the flow cell and make it finger tight.

*For best performance, it is recommended to change the membrane cap and electrolyte at least once a year.*

### PPMSLT SENSOR

The PPMSLT sensor does not use a membrane and has a different open-through cap that holds the electrolyte solution around the electrodes glass shaft. Because this cap is opened from both sides, the procedure to fill it with the necessary electrolyte is slightly different in that you must do so with the accompanied lid on before fully screwing that cap onto the electrodes then finally removing that lid.

The PPMSLT sensor is the only sensor that requires cleaning of its gold electrodes tip and you do so with the small special abrasive cleaner the sensor is shipped with.

## ORP AND pH SENSORS

### Properties

The ORP and pH sensors are non-corroding sealed combination electrodes (Figure 19). They do not require refilling. Each sensor has an external plastic body and an inner glass tube that can be broken if stressed too severely.

The potentiometric sensors produce small voltages - in the millivolts range. Since they have a high impedance (20 to 50 megohms), the electrical current produced by the sensors is extremely small - in the picoamp ( $10^{-9}$  A) range. The output is so small that it cannot be measured with ordinary voltmeters and must be internally amplified by the controller.

There is no electrical current flowing from the controller to the ORP and pH sensors. They are optically isolated from the high voltage circuit inside the electronic module. Therefore, they create no electrical danger.

The ORP (Oxidation-Reduction Potential or Redox) Sensor monitors the activity of the sanitizer (Fast Acting Free Chlorine, Bromine or Ozone) through its oxidizing power. It is recognized by its red color, the wide platinum band at the tip of the electrode and the white plastic tag on the cable.

The pH Sensor monitors the acidity of the water. It works with any acid or base. It is recognized by its blue color and by the glass bulb at the tip.

### Packaging

The pH and ORP sensors are shipped in individual cartons for extra protection. When ready for installation, remove the plastic cap on the tip of the sensor. If it is difficult to remove, dip it in water for a few seconds. It should then slide off easily. There may be a white crystalline deposit around the cap. This is produced by the salt solution that is used for shipping. It does not affect the performance of the sensor.

### Sensor cables

The sensors are supplied with a standard 10' (3 m)-long cable made of coaxial wire designed to minimize electrical interference. For ease of identification, all ORP cables have a white marker.

The cables are terminated with bayonet-type, spring-loaded, push-and-twist male BNC connectors. These are connected to the proper female BNC connectors located on the left side of the controller cabinet.

If the cable is longer than needed, it should be coiled neatly and attached under the cabinet. **DO NOT ATTEMPT TO CUT THE SENSOR CABLE** under any circumstances.

If a longer cable is needed, custom-made extension cables with BNC connectors can be ordered from the factory in lengths of up to 1000 feet. For longer distances, a pre-amplifier may be required. Consult your dealer or the factory for details.

### Electrical Interference

The *CHEMTROL*® PC controllers feature differential amplification of the sensor signals to reduce electrical interference from stray currents in the water.

Electrolytic chlorine generators are a frequent source of current leakage. This should not be a problem with properly designed commercial-type generators. If using several generators, **DO NOT** install them in series. Instead, use a manifold and plumb the generators in parallel.

To check for current leakage, compare the readings of the sensors when they are in line and when they are dipped in a plastic bucket containing the same water from the pool or spa. If you get different readings, there is current leakage. Its source must be identified and eliminated with proper grounding by a qualified electrician.



Figure 19 - ORP and pH Sensors

## Storage and Winterizing

**CAUTION:** STORING OR SHIPPING A SENSOR WITHOUT CAP OR WATER WILL VOID ITS WARRANTY.

All ORP and pH sensors are shipped with a plastic cap on the tip to protect the tip from physical damage. This cap also contains water to prevent the sensor from drying out.

Remember to store the protective caps inside the sensor box or inside controller cabinet so that they are available for storage, winterizing or shipping. When storing or returning any sensor for warranty consideration, always add water inside the cap to prevent the sensor from drying out.

Freezing can damage the ORP and pH sensors. They should be removed from the line and stored at room temperature whenever freezing is expected.

## Sensor Warranties

The PPM, ORP and pH sensors are covered by a standard one-year manufacturer warranty. This does not include damage caused by physical abuse such as breakage of the inner glass tubing or by drying out of the tip. **BE CAREFUL IN HANDLING THE SENSORS and ALWAYS REPLACE THE CAP WITH WATER INSIDE** when not in use.

In case of sensor failure, return it as soon as possible with its cap on and with water inside the cap for warranty consideration or replacement.

## TEMPERATURE SENSOR

If the CONDUCTIVITY option is not included, the Temperature Sensor is supplied separately as a thermistor imbedded inside a 1/4" MPT fitting with a 10-ft (3 m) connecting cable (Figure 20). A 1/4" reducer epoxied to a 1/2" SxS PVC tee is also supplied.

Install the sensor near the ORP and pH sensors, either directly on the main line or on the bypass line (**Error! Reference source not found.**), flow cell) or sensor cell cabinet (Figure 16).

Connect the red and black leads to the Terminal Barrier strip TB5 as indicated on the schematic of the Mother Board (Figure 9).

**NOTE:** When the CONDUCTIVITY option (TDS) is specified, the temperature sensor is incorporated in the conductivity sensor (Figure 21). This simplifies installation, as only one sensor fitting is required.



Figure 20 - Temperature Sensor

## CONDUCTIVITY SENSOR

The Conductivity or TDS (Total Dissolved Solids) Sensor consists of two graphite electrodes forming the measuring cell. It also contains a thermistor that is embedded inside the sensor. The sensor is supplied with a 10-ft (3-m) connecting cable and a specially drilled 1/2" MPT PVC fitting, as shown on Figure 21.

Using a 1/2" FPT PVC tee, install the sensor near the ORP and pH sensors, either directly on the main line or in a 90° elbow on the bypass line (**Error! Reference source not found.**), flow cell) or sensor cell cabinet (**Figure 16**). Make sure that the sensor is oriented so that the water flows smoothly through the measuring cell.

The four leads from the conductivity/temperature sensor must be connected to the Terminal block strip TB5 on the Mother Board (Figure 9).



Figure 21 - Conductivity Sensor



## FLOW SENSOR

### Flow Sensor Location

Always install the flow sensor as far away as possible from obstructions that can affect the flow profile around the sensor.

Figure 22 shows manufacturer guidelines for minimum lengths of straight pipe before and after the sensor. For best results, respect these guidelines as much as possible.

Depending on pipe diameter, three different models of sensors are used for flow monitoring:

- Model 2536-P0 for diameters from 2 to 4 in (50 to 100 mm) (Figure 23),
- Model 2536-P1 for diameters from 5 to 8 in (100 to 200 mm) (Figure 23),
- Model 2540 for lines over 10 in. (250 mm) in diameter (Figure 24).

The rotor shaft should be inserted at least 10% of the pipe diameter into the water. The sensors are paddle wheel-type, Hall effect generators with a true square wave. They are rated at 200 psi (14 bar) at 68°F (20°C). The signal can be transmitted up to 1000 feet (300 m) without distortion.

Follow manufacturer instructions carefully and do not install while the line is under pressure.

### Flow Sensor Saddles

Saddle assemblies for flow sensors are available in 2, 4, 6 and 8 in. diameter (see Figure 25 and Figure 8). For larger sizes, call the factory for special order.

### Flow Sensor Connections

Connect the three leads from the sensor to the Terminal Barrier strip TB 4 as indicated on the Mother Board Schematic (Figure 9).

**CAUTION:** A 24 V DC signal is used for signal generation. Reversing the wires may cause damage to the sensor and to the microprocessor.

Enter the **calibration K-factor** in pulses per unit of volume flow (gpm or l/m) for the specific pipe diameter and thickness, as discussed in Chapter IV - Operation (Page 42).

Minimum Pipe Diameters Before Flow Sensor

Flange:	10 x I.D.
Reducer:	15 x I.D.
90 Elbow:	20 x I.D.
2x 90 Elbows:	40 I.D.
Valve/Gate:	50 x I.D.
Pump:	50 x I.D.

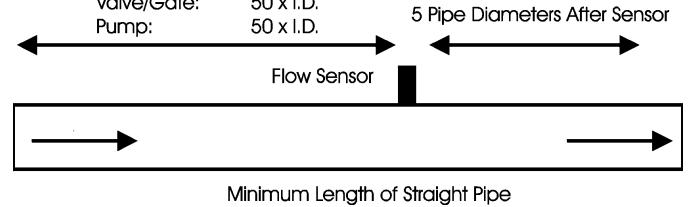

Figure 22 - Flow Sensor Installation

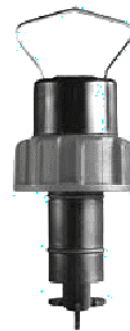

Figure 23 - Model 2536 Flow Sensor



Figure 24 - Model 2540 Flow Sensor

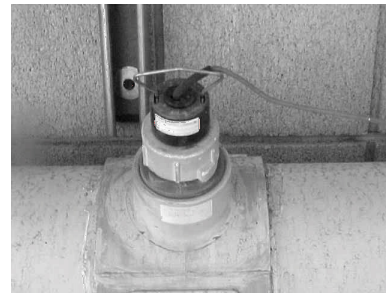

Figure 25 - Saddle for FS2536

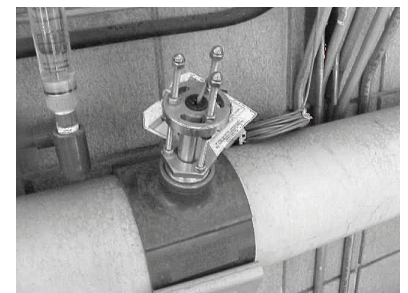

Figure 26 - Saddle for FS 2540

**PRESSURE TRANSDUCERS**

The pressure sensors are *CHEMTROL®* Series 1200 transducers (Figure 27) with a 1/4-18 NPT thread connection rated at -15 to 45 psi (-1 to 3 bar).

For differential pressure monitoring, a transducer should be installed on the intake (influent) side of the filter or bank of filters and another one on the return (effluent) side.

**Transducer Connections**

Connect the leads from the sensors to the Terminal Barrier strip TB2 as indicated on the Mother Board Schematic (Figure 9). For calibration, enter a factor of 4.3 through the PUMP Submenu 6.2.1 (Page 41).

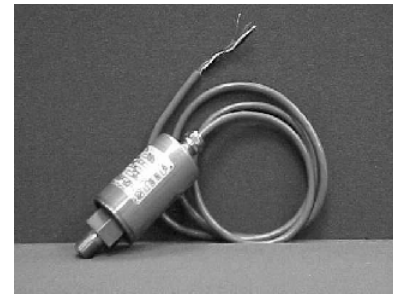

**Figure 27 - Pressure Transducer**

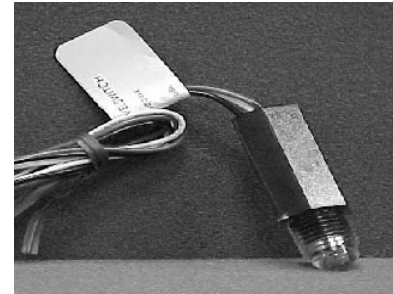

**Figure 28 - Optical Level Sensor**

**WATER LEVEL SENSOR**

The water level in the pool can be automatically maintained with a fill valve controlled by the water level sensor. The sensor is an ELS-1100 Series electro-optical sensor with a 1/4" NPT thread (Figure 28). Having no moving parts, it is simpler and more reliable than mechanical systems.

The optical sensor uses the reflection of an LED light beam inside a prism to determine the position of the water level (Figure 29). With no liquid present, the light beam from the LED is reflected within the prism to the receiver. When the liquid level reaches the prism, the index of refraction is changed and the beam is cannot be detected by the receiver.

**Installation**

Locate the sensor in a convenient location in the pool, surge pit or water tank as shown on Figure 30. Wire the fill valve to the Level Fill relay.

Connect the leads from the sensor to the Terminal Barrier strip TB1 as indicated on the Mother Board Schematic (Figure 9).

**Maintenance**

The surface of the prism should always be kept clean and should be positioned at least 2" (cm) away from reflective surfaces.

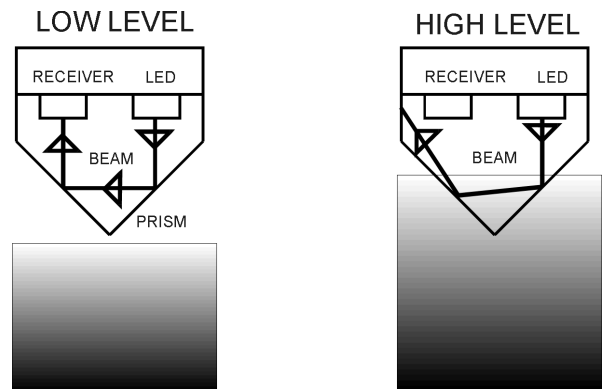

**Figure 29 - Optical Beam Path**

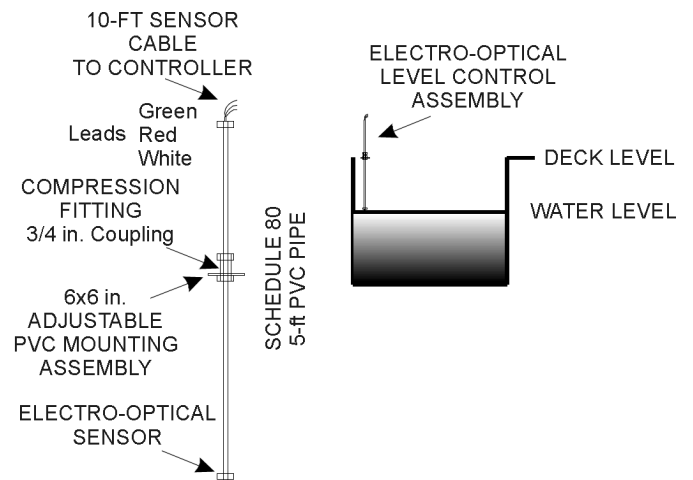

**Figure 30 - Water Level Assembly**

## CHEMICAL FEEDERS

### WARNING: Tank Sizing

The *CHEMTROL®* PC controller includes many safeguards to prevent overfeeding of chemicals. However, there is always a risk of physical failure of the electronics or feed equipment that could cause overfeeding of chemicals. To prevent damage or injury to persons, it is imperative to size the chemical tanks so that no dangerous amount of chemicals will be fed in case of equipment failure.

### Chemical Feed Pumps

Chemical feed pumps are used to feed liquid sanitizers, such as sodium hypochlorite NaOCl, also known as liquid chlorine, or solutions of calcium hypochlorite or dichlor powder. Liquid chemicals for pH control include muriatic acid, caustic soda or solutions of soda ash.

Any standard chemical feed pumps (diaphragm, piston or peristaltic) approved by NSF (National Sanitation Foundation), UL (Underwriters' Laboratories), ETL (Electrical Test Laboratories), CSA (Canadian Standards Association) or similar national and international organizations, can be used, as long as they are properly sized for the installation.

Install the pumps as shown in Figure 6, following the electrical code and the pump manufacturer's instructions.

### Carbonic Acid (CO<sub>2</sub>) Valve

A special solenoid valve for carbonic acid can be used to control the addition of CO<sub>2</sub>, an acid used to lower pH. It also increases Total Alkalinity making pH control difficult. Add muriatic acid, HCl, to reduce high alkalinity.

### Gas Chlorinator

*NOTE: Use of Chlorine gas is very dangerous. Make sure to follow all local safety codes.*

Gas chlorinators should be installed and maintained only by factory-trained technicians following the instructions of the manufacturer.

If required, the injection line for chlorine gas can be controlled with a specially designed, corrosion-proof solenoid valve installed between the gas chlorinator and a Venturi injector. Alternatively, a magnetic starter can be used to control a booster pump for the chlorinator bypass line.

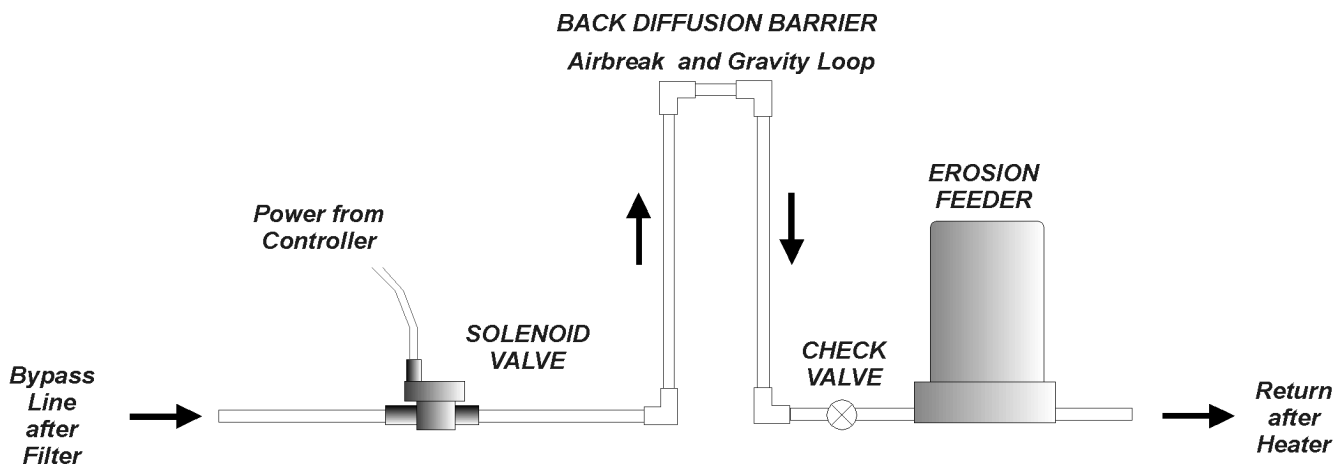

Figure 31 - Erosion Feeder Control

### Erosion Feeders

Erosion feeders for bromine, chlorine or calcium hypochlorite tablets can be controlled with a solenoid valve that is mounted on the intake side of the bypass line before the feeder (Figure 31). This allows the controller to modulate the flow of water through the feeder.

For proper valve operation, the pressure differential through the feeder must be at least 15 psi (1 kPa). This may require installation of a pump on the bypass line.

With less corrosive chemicals, such as bromine dihalo or calcium hypochlorite tablets, the solenoid valve can be mounted before the erosion feeder.

### Back Diffusion

With corrosive trichloro tablets, it is recommended to protect the solenoid valve with a check valve and an anti-diffusion loop, as shown in Figure 31.

The loop must be narrow to facilitate formation of an air break and tall to maximize the effect of the gravity barrier.

This design reduces – but does not eliminate – corrosive back diffusion. A better idea is to switch to a less aggressive sanitizer.

**FILTER BACKWASH**

The Power Board (Figure 10) of the CHEMTROL® PC7000 includes six (6) double-pole, double-throw (DPDT) 5A relays for automated filter backwash. They can be used to control solenoid valves, motorized valves, hydraulic valves or pneumatic valves.

**Main Pump Shutoff**

To relieve pressure on the backwash valves, it may be desirable to shut off the main recirculation pump during opening and closing of the valves.

Use Filter Submenu 7.8.1 in the CHEMTROL® PC7000 to specify if the main recirculation pump is to be shutoff during cycling of the valves. The standard shutoff value is 5 seconds but it can be changed through Submenu 7.8.1.1.

**Single Filter Backwash**

As shown in Figure 32, backwashing of a single filter is controlled with four valves that are connected to the Normally Open (NO) and Normally Closed (NC) poles of Filter Relay 1.

Valves # 1 and #4 are connected to the Normally Open connectors on Relay #1 (marked NO1 and NO2). These valves are open for filtration and closed for backwash.

Valves # 2 and #3 are connected to the Normally Closed connectors on Relay #1 (marked NC1 and NC2). These valves are closed for filtration and open for backwash.

**Multiple Filter Backwash**

Figure 33 shows the connections for sequential backwashing of multiple filters with three-way valves connected to Filter Relays 1 to 6. If more than six filters are used, several filters can be banked together.

For filtration, the valves are in the normally open position and connect the influent and effluent lines through each filter. In backwash operation (normally closed), the valve is connected to the waste discharge line.

A partial closure valve (priority valve or flow control valve) can be connected to the relay marked Deoxidizer. Specify in Submenu 7.8.1 if it is to be activated during backwash.

**Backwash Stager**

Multiple filter backwash can also be done with a backwash stager, a mechanical port selector for multiple filters that can be used in place of solenoid valves.

The stager is operated through a dry contact relay connected to Filter Relay #1 on the Power Board.

**CHEMTROL™ PC6000 FILTER BACKWASH**

**CONTROLLER**



NO1 and NO2 to Valves #1 and #4 (Filtration)

NC1 and NC2 to Valves #2 and #3 (Backwash)

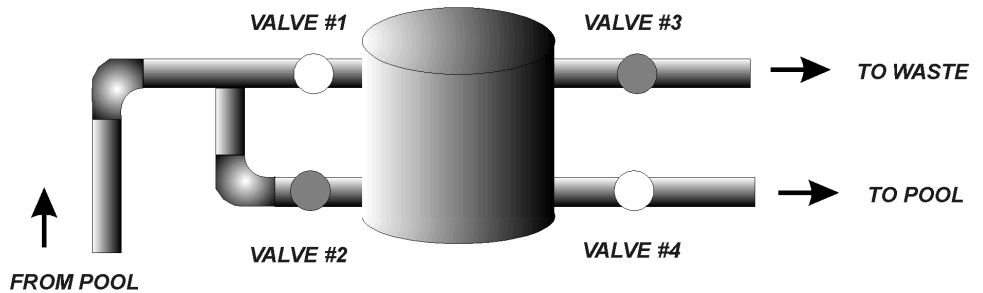

**Figure 32 - Single Filter Backwash**

**Electrical Valves**

Solenoid or motorized valves can be connected directly to the NO and NC sides of the filter relays if they draw less than 5 A. If more than 5 A, an intermediate relay of sufficient amperage should be installed.

**Hydraulic Valves**

Water pressure for a hydraulic valve can be controlled with a three-way piston valve, one port being used to apply water pressure for backwash and one port open to the atmosphere to relieve the pressure on termination.

For EPD or STARK filters, use an ASCO 3-way Solenoid Valve P/N 8221G2, Normally Closed - or equivalent.

**Pneumatic Valves**

Air pressure to pneumatic valves can be controlled with a standard two-way solenoid valve installed on the air line.

For MIAMI TANK filters, use an ASCO Solenoid Valve P/N 8210G94, Normally Closed - or equivalent.

**Figure 33 - Multiple Filter Backwash**

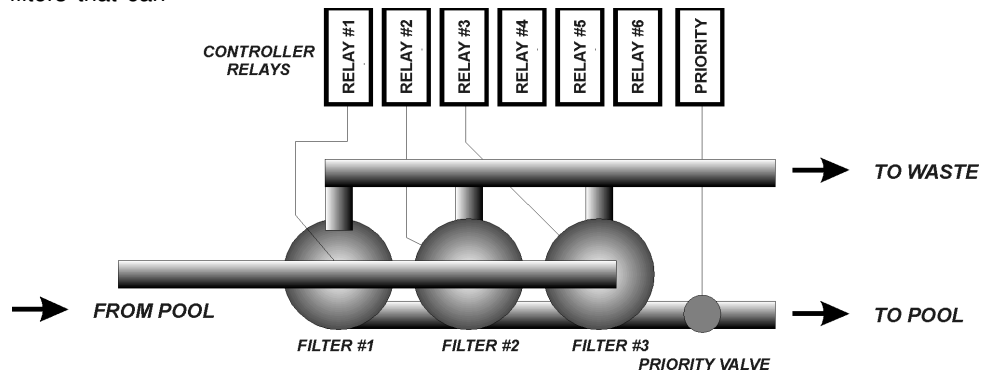

## CHAPTER III - STARTUP

### CONTROLLER STARTUP

#### Initial Reset

Before powering up the controller, locate the Battery Jumper J1 on the Mother Board (Figure 9). Remove it, wait one minute and reinstall it. This clears up any unwanted changes in the program and resets the original default values.

With the front door open, verify that the CPU Fail Light on the microprocessor, turns ON when power is applied to the unit is turned OFF when the program is running.

#### Configuration Menu

Upon startup, verify the initial setup through the CONFIGURATION Menu 8.1 (see page 24) and adjust the values as required. This includes adjusting the clock for different time zones and selecting the proper language and units system.

#### Alarm Buzzer

The Audible Alarm option is normally turned off until the sensors are installed. Use Submenu 8.2.1 (page 27) to turn it on for normal operation.

#### Bypass Line

By default, the Bypass Line Option is factory-set to YES to prevent accidental feeding when there is no water flow in the bypass line. To turn it off, set the Option to "NO" in Submenu 8.2.2 (page 27).

#### Battery Check

Check the condition of the Backup Battery. It prevents the loss of memory data in case of power shutdown. The voltage of the battery can be seen through the CONFIGURATION / BATTERY Submenu 8.2.6 (page 28).

If the battery voltage is less than 2.5V, the battery should be replaced with a 3V-lithium battery, Panasonic CR2330 or equivalent.

#### PPM Board Initialization

The PC board for the PPM sensor on the PC5000 and PC7000 must be initialized prior to calibration of the PPM sensor itself.

Turn the controller on and wait at least 30 minutes to allow the sensor to charge. Read the **PPM SANITIZER** display on the controller.

Go to Initial Setup and enter **Submenu 8.1.5 - Readings** to adjust the default value of the sensor readings to one (1) second.

Adjust the potentiometer on the PPM board marked (**R14 SENS. ADJ.**) to make the controller display agree with the DPD test kit reading. Wait 10 seconds and repeat if necessary.

After calibration is completed, remember to set the **Readings** back to the default value of ten (10) seconds.

### CHEMICAL CONTROL

#### Initial Activation of Sensors

For a new pool or spa, it is recommended to wait for a week or two after filtration is started before installing the sensors. This will prevent damage to the sensors until all the dirt and debris have been filtered out of the water. When ready to start the controller, install the sensors in the recirculation line and run the recirculation pump for 30 to 60 minutes or until the readings of the sensors stabilize.

#### Bypass Line Test

If there is a bypass line, open the sampling tap on the bypass line and adjust the two shutoff valves until there is a smooth flow of water coming out of the tap (no suction or excessive pressure).

#### Water Chemistry Adjustment

Before starting automatic control, the water chemistry should be adjusted to near the recommended values of 7.5 for pH and about 1 ppm for chlorine (2 ppm for bromine). The chemicals can be added manually or with the controller set on Manual Mode.

**NOTE:** *The controller will not operate in the Automatic Mode if the sensor readings are below or above the alarm settings.*

Also, verify that the cyanuric acid level is below 40 ppm, the Alkalinity between 80-120 ppm and the Total Dissolved Solids (TDS) level below 1,500 ppm. If either one of these limits is exceeded, the water is contaminated. It should be replaced with as much fresh water as needed.

#### Water Sampling

Proper water sampling is essential for accurate calibration of the pH and ORP sensors. The preferred method is to sample the water as close as possible to the location of the sensors, usually on the bypass line. The bypass line should be therefore equipped with a water-sampling tap, which can be a ball valve.

Because of the instability of chlorine, particularly under sunlight, samples taken near the surface of the water can give false results.

#### pH Calibration

**NOTE:** Always calibrate the pH sensor first, i.e. before the sanitizer.

Test the pH of the water at least twice with a fresh solution of a standard Phenol Red test kit, or until you get consistent readings.

The pH of the water should be near 7.4 to 7.5. If not, adjust it manually or with manual feed control:

If the pH is below 7.0:

**CAUTION: CORROSIVE CONDITION.** Add a base (Soda Ash, Caustic Soda NaOH, pH PLUS, pH UP, etc.) to raise it as soon as possible.

If the pH is above 8.0:

**CAUTION: SCALING CONDITION.** Add an acid (Muriatic Acid, Hypochloric Acid HCl, Sodium Bisulfate, pH MINUS, pH DOWN, etc.) to lower it.

If the test kit value differs from the value shown on the controller display, select the pH Calibration Submenu 3.2 (see page 35) and enter the value indicated by the test kit, using the 1-Point Calibration option.

For more accurate calibration with two or three points, repeat the same process at two or three different pH values using calibrated standard solutions of appropriate values. Most common values are for pH 4.0, 7.0 and 10.0.

### pH Feed (Acid or Base)

The *CHEMTROL®* PC has two pH control relays, one for Acid feed and one for Base feed. Acid Feed is activated when the pH is above the setpoint and Base Feed when it is below the setpoint.

In most cases, only one type of chemical is required, i.e. either acid or base, depending mostly on the type of sanitizer used. Make sure to connect the acid or base chemical feeder to the proper outlet on the Power Board (Figure 10).

### pH Setpoint

The default value for the pH setpoint is 7.5. It can be modified at any time through the pH Menu.

### ORP Calibration

The ORP sensor is direct reading and does not require calibration.

### ORP Setpoint

The default value for the ORP setpoint is 700 mV. It can be modified at any time through the ORP Setpoint Submenu 1.3 (page 31).

The controller will automatically activate the chlorinator, brominator or ozonator whenever the reading is below the ORP deadband. It will stop automatically as soon as the reading is above the ORP setpoint.

### Sanitizer Calibration

**NOTE:** *Make sure to adjust the pH between 7.4 to 7.5 before calibration of the sanitizer.*

Test the water with a DPD or FACTS test kit for Free Chlorine or Bromine. Do not use an OTO (Total Chlorine) test kit. Make sure that the test solution is fresh and test at least twice or until you get consistent readings.

The water should test close to 1.5 ppm for chlorine or 3.0 PPM for bromine.

- If the water tests below these values: Add sanitizer as needed to bring the PPM reading to a proper value.
- If the water tests above 3.0 ppm for chlorine or 8.0 ppm for bromine:
  - a. wait until the level is reduced to below these values,
  - b. add a reducing agent (Sodium Thiosulfate), or
  - c. replace part or all of the water.

Select the Sanitizer Calibration Submenu 2.1 (page 33) and enter the value indicated by the test kit.

### Time Limits

The Time Limits for each outlet should be set for the length of time that can be safely tolerated for chemical overfeeding - in case of equipment malfunction or operator error. This time limit varies with each installation, based on the size of the installation (gallons of water) and the feed rate of the chemical feeders.

If needed, see your *CHEMTROL®* PC Qualified Dealer for assistance.

### Shock Treatment

It is recommended to wait several weeks before using the automatic superoxidation or superchlorination cycle, or until all the other operating functions of the controller have been properly tested.

### Chemical Saver

The Chemical Saver program is used to lower the oxidizer or sanitizer level when there is little use, such as at night or on weekends.

Chlorination should be prevented completely whenever a pool cover is in place.

It is also recommended to stop sanitizer feed for pools where there is insufficient mixing of water at night - due to the lack of water mixing by swimmers or convection currents. This can lead to stratification of the chemicals in the water and eventual overchlorination.

### WATER SATURATION

The *CHEMTROL®* PC features automatic calculation of the Langelier Saturation Index Submenu 8.2.3 (page27).

It is recommended to check the water saturation as soon as possible after installation to prevent damage to the equipment through corrosion or scaling. This should be done immediately after calibration of the pH and temperature sensors, using a reliable test kit to obtain the alkalinity and calcium hardness values.

## CHAPTER IV - CONTROLLER OPERATION

Chapter IV describes the menus and submenus used to operate the CHEMTROL® PC controllers. For an overview, refer to the Menu Tree at the beginning of this manual.

On the right are shown screens for the standard version and for the two models: the PC7000 and the PC5000. The PC6000 and PC3000 are similar except that the Free Chlorine sensor is not included for sanitizer control.

The underlines \_\_\_\_\_ on this screen, and all menus and submenus, show operator adjustable entries, selections and calibrations.

### Access

The submenus are accessed by first highlighting a line in the Main Display screen with the UP and DOWN ARROW keys and then pressing the RIGHT ARROW key to enter the submenu. Each menu or submenu is therefore identified by a series of numbers - from 1 to 8 - which correspond to the display lines that are used to access it. For instance, Submenu 8.1.4 for Configuration/Initial Setup/Clock is accessed by scrolling down to and pressing on line 8 on the Main Display Screen, then line 1 on the Configuration Menu and finally line 4 on the Initial Setup Submenu. To return to any previous menu, press the UP ARROW key.

For ease of operation, the Configuration and Setup (Menu 6) is discussed first. The other menus are discussed afterwards in numerical order.

### Default Setup

The controller is initially loaded with standard default values that allow it to start operating normally. It is therefore not required to initialize it in order to operate the controller, as it defaults automatically to standard setup values, such as "English" language, "U.S. Units", "No password", as well as standard setpoints and alarm values.

The operator can change the original default settings at any time to fit his preferences. If needed, the original default values can also be restored through the Reset Submenu. They will always be automatically restored in case of complete loss of power, including backup battery power.

### 8 - CONFIGURATION MAIN MENU

As shown on Menu 8, the Configuration Menu is used for Initial Setup, Operations, viewing or printing of Reports (data logs) and Communications.

To access the Configuration Menu, use the DOWN ARROW key on the Main Display screen to highlight the time/date line and then press the RIGHT ARROW key to show the next menu. It includes the three submenus shown on the right (Menu 8).

>ORP	<u>650</u>	mV	<u>A</u>
SANITIZER	<u>1</u>	ppm	<u>A</u>
>ACID	<u>7.5</u>	pH	<u>A</u>
COND	<u>2000</u>	uS	<u>X</u>
TEMP	<u>82</u>	F	<u>A</u>
>PUMP	<u>200</u>	gpm	<u>A</u>
FILTER	<u>25 / 20</u>	psi	<u>X</u>
<u>08/10/96</u>	<u>5:30</u>		LSI OK

PC7000 Main Display

>ORP	<u>650</u>	mV	<u>A</u>
SANITIZER	<u>1</u>	ppm	<u>A</u>
>ACID	<u>7.5</u>	pH	<u>A</u>
COND	<u>2000</u>	uS	<u>X</u>
TEMP	<u>82</u>	F	<u>A</u>
>PUMP	<u>200</u>	gpm	<u>A</u>
FILTER		N.A.	
<u>08/10/96</u>	<u>5:30</u>		LSI OK

PC5000 Main Display

<b>CONFIGURATION</b>
<b>Initial Setup</b>
<b>Operations</b>
<b>Reports</b>
<b>Communications</b>

Menu 8

**8.1 - INITIAL SETUP SUBMENU**

The Initial Setup Submenu is used to specify basic operating conditions of the *CHEMTROL*® PC. It is accessed through the Configuration Menu on the last line of the Display Screen.

*8.1.1 - Language*

The Language Submenu allows the user to select either one of three languages: English, French or Spanish for all displays screens. The standard (default) language is English. Language changes take effect immediately.

*8.1.2 - Units*

The Units Submenu allows the choice system of U.S. or Metric units to be used throughout the program. The standard (default) value is the U.S. system. The change of units takes place immediately.

Unit equivalencies are as follows:

	<b>U.S.</b>	<b>METRIC</b>
ORP	mV	mV
Sanitizer	ppm	mg/l
pH	pH	pH
Conductivity	µ S	µ S
TDS	ppm	mg/l
Temperature	F	C
Pressure	psi	kPa
Flow Rate	gpm	l/m
Flow	Mga	m3

*8.1.3 - Code Number*

The Code Number Submenu is used to define different operator access levels. Code numbers may be required for access at key points in the program and for remote communications.

Up to ten Code NUMBERS (of one to five digits each - no letters) may be entered, along with an associated access level from one to three. Make sure to select an easy to remember number, such as a familiar name on a standard telephone keypad.

The following access levels are available:

- Level 1: View only,
- Level 2: Calibration,
- Level 3: All functions.

To clear an existing Code Number, its access level is set to zero.

Once a Code Number has been acknowledged, it remains valid for an hour of continuous operation so that the operator does not have to re-enter it constantly. If necessary, it can be changed by returning to the Welcome screen.

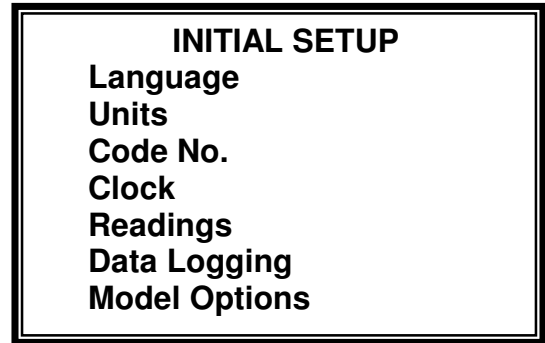

Submenu 8.1



Submenu 8.1.1

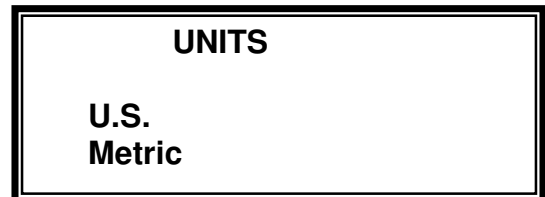

Submenu 8.1.2

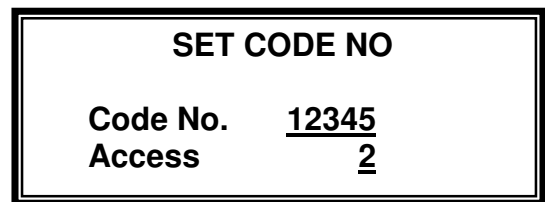

Submenu 8.1.3



8.1.4 - Clock

The clock/calendar is used for programming of daily and weekly schedules. It keeps track of odd months and leap years. In case of power shutdown, the backup battery maintains power to the board. The clock needs to be reset only in case of complete power shutoff with loss of battery power.

The Clock Submenu is used to set the DATE, TIME and DAY of the week.

NOTE: The date display uses the MM/DD/YY (Month/Day/Year) format and the time display, the 24:00 hour format.

8.1.5 - Readings

The DISPLAY HOLD parameter is used to stabilize the readings of the sensors and to eliminate excessive random fluctuations. It specifies the time interval over which the sensor data is averaged before the screen is updated. It can be set between 1 and 60 seconds with a default value of 10 seconds,

8.1.6 - Data Logging

The DATA LOGGING screen selects the time interval for storing test data in the controller memory. Intervals can be between 1 to 999 minutes, with a default value of 60 minutes.

The memory chip can store up to 999 test results. When full, the oldest entries are overwritten by the new ones. Therefore the greater the interval is, the longer it takes to fill the memory. For instance, an interval of 60 minutes (one hour) fills the memory in 41 days. With data logging every four hours, the memory holds 5 ½ months of data.

To avoid losing test data, remember to print it or download it to a computer before the memory is full (see Submenu 8.2.4 - Print Reports). After data download is completed, the Reset function in Submenu 8.1.6 can be used to remove all data and start with a clean slate.

8.1.7 - Model Options

The Model Options Submenu is used to specify the functions that are actually installed on the controller. Non-installed functions should be set to "NO". The Main Display Screen then shows N/A for that function.

For demonstration purposes, it is possible to access any function and review its features - even if it is not actually installed on the controller - by selecting "YES" for that option.

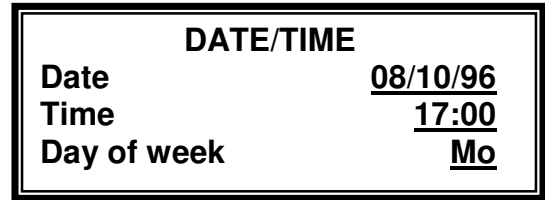

Submenu 8.1.4.

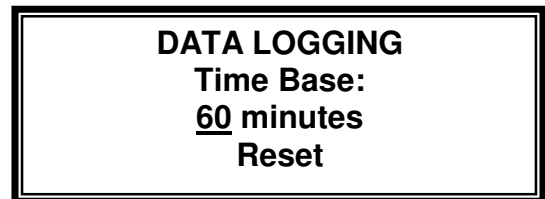

Submenu 8.1.5

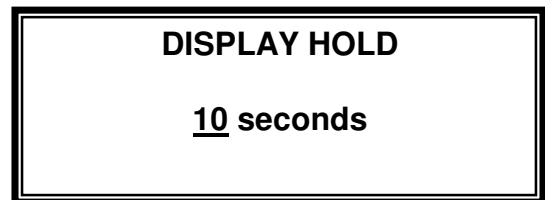

Submenu 8.1.6

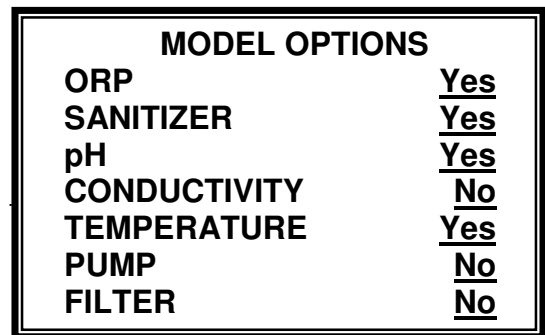

Submenu 8.1.7

**8.2 - OPERATIONS SUBMENU**

The Operations Submenu allows the operator to access and change operating conditions during normal operation.

*8.2.1 - Audio Alarms*

This option is used to disconnect the audio alarm (buzzer) and remote alarm in case of out-of-range or other alarm conditions. All visual alarms, such as flashing on the screen, still remain operative.

*8.2.2 - Bypass Line*

The bypass line is a recommended feature for sensor installation on large recirculation lines, i.e. over 2 inches in diameter. It is included with all PC5000 and PC7000 controllers.

A Safety Flow Switch is used to prevent operation when there is insufficient water flow in the bypass line. This can occur particularly when the bypass line is shut down for maintenance.

The standard flow switch provided with the *CHEMTROL® PC* is a rotary flowmeter with a paddle wheel. The shutoff is set at 1 gpm (about 4 l/m).

The Bypass Line Protection option should always be set to YES, indicating that the alarm is active and will cause the interruption of all feed events.

If the flow switch is defective or temporarily disabled, the bypass alarm can be overridden by setting the Bypass option to NO. This override should be used with extreme caution:

**WARNING:** Feeding chemicals when there is no water running in the bypass line may cause dangerous chemical reactions.

*8.2.3 - Langelier Saturation Index*

The Langelier Saturation Index is used for monitoring the development of corrosive or scaling tendencies in water. The Saturation Index SI is calculated from the formula:

$$SI = pH + TF + AF + CF - 12.1$$

where:

- pH = pH sensor reading or keyboard input,
- TF = Temperature factor calculated from sensor input or keyboard input,
- AF = Alkalinity factor from data table,
- CF = Calcium Hardness factor from data table.

The microprocessor inside the controller calculates the factors TF, AF and CF directly from the raw data input for temperature (degrees), alkalinity (ppm) and hardness (ppm). The operator therefore does not have to resort complicated conversion tables.

<b>OPERATIONS</b>	
Audio Alarms	<u>YES</u>
Bypass Line	<u>YES</u>
Saturation Index	OK
Print Reports	
Reset	
Battery	
Probe Monitor	<u>YES</u>

Submenu 8.2

<b>SATURATION</b>	
Alkalinity (ppm)	<u>150</u>
pH	<u>7.5</u>
Temperature	<u>80</u>
Limits	
Langelier Index	0.23
Condition	OK

Submenu 8.2.3

<b>LANGELIER LIMITS</b>	
Scaling above	<u>+ 0.3</u>
Corrosive below	<u>- 0.0</u>

Submenu 8.2.3.5

Langelier Limits

The standard limits for the Langelier Index show "OK" between 0 and +0.3, "CORR" if below 0, and "SCALE" above +0.3. If an alarm condition develops, the Display Screen alerts it with flashing characters.

The above values are the generally accepted limits for water saturation. Some experts however, recommend different values, such as -0.3 and +0.3 instead. The limits can therefore be changed by in Submenu 8.2.3. 5.

Submenu 8.2.4

8.2.4 - Reset

The Reset Submenu is used to take the calibration parameters back to the initial factory settings. This may be done on initial installation or whenever incorrect parameters have been entered. **Complete Reset** resets all system parameters to their initial "default" settings. **Partial Reset** allows partial resetting of individual functions, such as ORP, Sanitizer, pH, etc.

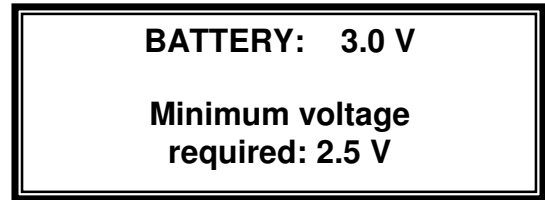

8.2.5 - Backup Battery

The CHEMTROL® PC uses a 3 V lithium battery to maintain calibration, setup and test data in memory storage in case of power shutdown. The battery is designed to last for more than 200 days without any power being supplied to the unit. The minimum voltage required is about 2.5 V. The Battery Submenu displays the voltage of the battery for information. A flashing display on the Main Display screen indicates a low battery voltage. To prevent loss of memory data, the battery should be replaced when the voltage gets below 2.5 V.

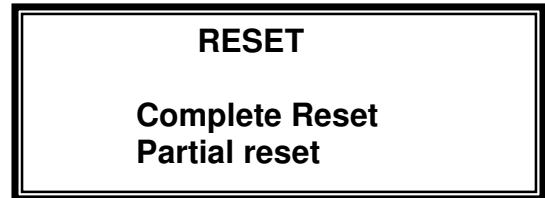

Submenu 8.2.5

If power to the memory is completely discontinued, all settings revert automatically to the initial default values. If required, they may have to be individually reset to their proper values by the operator. When changing the battery, it is important to keep power supplied to the unit to keep the proper settings in memory.

Submenu 8.3

8.2.6 - Probe Monitor

Probe monitoring is a very useful, patented CHEMTROL® PC feature (US Patent No. 5,895,565) that allows dynamic monitoring of the ORP and pH sensors to alert a probe failure as soon as it happens.

Other controllers have to wait until there is an out-of-range or alarm condition in order to alert the operator. This could result in serious damage and liability.

To activate or disable the Probe Monitor function, use the RIGHT ARROW to select YES or NO in Submenu 8.2, line 7.

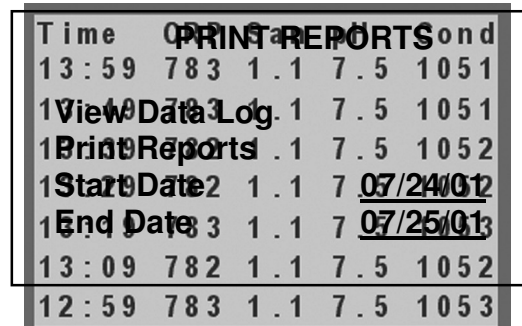

Figure 34 - On-screen Data Log

8.3 - REPORT SUBMENU

8.3.1 - View Data Log

The View Data Log Submenu allows on-screen viewing of the test data that has been logged in the internal memory chip of the controller (see Submenu 8.1.6 - Data Logging), as shown on Figure 34.

This is an exclusive new feature that was not previously available on PC controllers. It eliminates the need for remote or on-site download on computers or printers.

To view the data, just click on the Right Arrow after specifying the start date and end date, if different from the default values.

Click on the Down Arrow to scroll the page down and see older data. Click on the Right Arrow to see other parameters on the right side of the screen.

To exit, click on the Left Arrow.

### 8.3.2 - Print Reports

The Print Reports Submenu is used to download the test data that has been logged in the internal memory chip of the controller (see Submenu 8.1.6 - Data Logging).

The data is saved in memory in standard ASCII. It can be printed on site or downloaded to a computer using three different methods:

- on-site printing to a serial printer,
- on-site downloading to a computer or laptop,
- remote downloading by modem to a computer using the CHEMCOM<sub>TM</sub> program.

After downloading into a computer, the data log can be displayed, edited and printed in text format using a text editor, such as *Windows Notepad*, or *Microsoft Word*.

NOTE: In the COMMUNICATIONS Chapter (Page 51), it can be seen that the same data log can be displayed directly through the CHEMCOM<sub>TM</sub> software program, either as text (Figure 47) or as graphical display (Figure 48).

Since a maximum number of 999 sets of test data can be stored in the memory chip, it is recommended to download the data periodically in order not to lose it.

Downloading the data does not erase it from the memory chip. To erase all data in memory, use Submenu 8.1.6 - Data Logging and select Reset.

For printing, use the desired setup below, then enter Submenu 8.3.4 - Print Reports, select the proper dates, move to Print Data Log and press the RIGHT ARROW. A counter shows the number of tests being printed.

### On-Site Printing

For on-site printing, connect a serial printer (usually a thermal printer) to the RS-232 serial outlet on the left side of the controller.

### On-Site Download

For direct download to a computer (that is without a modem), you must first set up communication parameters as shown below for DOS or *Windows*. Then connect the serial port on the computer (COM1: or other) to the RS-232 serial outlet on the CHEMTROL<sup>®</sup> PC, using a null-modem connector, or an adapter available from local electronics stores, or from your CHEMTROL<sup>®</sup> dealer.

**8.4 - COMMUNICATIONS SUBMENU**

The details of the communications features are discussed in the COMMUNICATIONS Chapter (page 51).

The Communications Submenu is used to select the phone numbers to report alarm conditions and to enter the identification number for voice telephone reporting.

*8.4.1 - Phone Numbers*

Up to six (6) different phone numbers can be entered for automatic calling in case of an alarm condition. Each number is called sequentially until one of the numbers is answered and the proper password is entered.

To delete a number, replace it with 0.

*8.4.2 - Unit Identification*

The unit identification number is used to identify individual controllers in multiple unit facilities that are connected to the same phone line. The default value is 1.

It should be set correctly for each controller to be able to be accessed individually in remote multiplex operation.

*8.4.3 - Alarm Calling*

Select YES if you want the controller to dial automatically the phone numbers listed in Submenu 8.4.1 or NO to disable it.

*8.4.4 - 4-20 mA Output*

The 4-20 mA output is an option (OPTION 4-20) to convert sensor readings and/or control outputs into analog signals that can be fed into analog monitoring or control equipment.

The 4-20 mA power outputs can be used for electronic pumps or valves with analog control circuitry.

The option includes one or two identical converter boards that plug into separate areas of the mother board of the controller (see Chapter IV - INSTALLATION).

The 4-20 mA Output Submenu is used to set the lower and upper limits for data conversion for each of the functions shown on the screen (Submenus 8.4.4 and 8.4.4.1).

The standard (default) values for the 4-20 mA limits are the values that have been selected for the out-of-range limits. This means that the lower out-of-range limit corresponds to the minimum signal of 4 mA and the higher limit to 20 mA.

To change the limit values of one of the functions, highlight the desired function in Submenu 8.4.4 with the UP or DOWN ARROW key and press the RIGHT ARROW key to access the 4-20 mA LIMITS screen, as shown on the Submenu 8.4.4.1 for ORP.

<b>PHONE NUMBERS</b>	
1:	_____
2:	_____
3:	_____
4:	_____
5:	_____
6:	_____

Submenu 8.4

<b>4-20 mA LIMITS</b>	
<b>ORP TOP</b>	<u>850</u>
<b>ORP BOTTOM</b>	<u>650</u>

Submenu 8.4.1

<b>ORP</b>
<b>SANITIZER</b>
<b>pH</b>
<b>CONDUCTIVITY</b>
<b>TEMPERATURE</b>
<b>PUMP</b>
<b>INFLUENT P</b>
<b>EFFLUENT P</b>

Submenu 8.4.4

<b>COMMUNICATIONS</b>	
<b>Phone Numbers</b>	
<b>Unit I.D.</b>	
<b>Alarm Calling</b>	<u>YES</u>
<b>4-20 mA Output</b>	

Submenu 8.4.4.1

**1 - ORP MENU**

*Operation*

The ORP sensor is used to monitor and control an oxidizing sanitizer, like chlorine or bromine, or a true oxidizer like ozone.

The ORP Menu screen is used to access all the ORP submenus for Control Mode, setpoint and alarm settings as well as shocking program (superchlorination if using chlorine).

It also displays the actual run time for individual feed events and the cumulative run time since last reset to zero.

**1.1 - Control Mode**

Line 1 shows the Control mode that is currently selected to control the ORP relay outlet: OFF, Manual, AUTO or Timer.

To change the Control Mode, select the first line with the UP or DOWN ARROW keys and press the RIGHT ARROW key. The Control Mode submenu 1.1 is then displayed.

The selection procedures for control are common to all the control functions. See the CONTROL Submenu further down.

**1.2 - Display and Calibration**

The second line displays the current reading of the ORP sensor in mV. There is no calibration menu for ORP since there are no readily available calibration solutions in the range of operation for water treatment.

**1.3 - Setpoint**

The ORP SETPOINT determines the ORP level that the controller maintains automatically when placed in the Automatic control mode.

To change the setpoint, press the RIGHT ARROW key and enter the desired value. After pressing the OK key, the SETPOINT Submenu 1.3 is displayed asking whether the control is to be set for an Oxidizer or a Reducer. Use the UP and DOWN keys to highlight the desired selection. Then press the RIGHT ARROW key to confirm the selection (Oxidizer or Reducer).

The controller includes two relays, one for oxidizer feed and one for reducer (de-oxidizer) feed. The normal (default) setting is for an oxidizer. This means that the oxidizer feed outlet is automatically activated when the sensor reading falls below the setpoint. If set for a reducer, the de-oxidizer outlet is activated when the sensor reading is above the setpoint.

**1.4 - Low Alarm**

The ALARM LOW value is set to generate an alarm when the ORP reading falls below the set value. To change the value, press the RIGHT ARROW key and enter the numerical value with the digital keypad.

After the alarm value is set, the ALARM OPTIONS Submenu 1.4.1 is displayed, to set the feed interlock and alarm buzzer options. Use the UP and DOWN keys to highlight the desired selection and press the RIGHT ARROW key to change to Yes or No.

<b>ORP</b>		<b>AUTO</b>
<b>Calibrate</b>	mV	<u>750</u>
<b>Setpoint</b>	mV	<u>700</u>
<b>Alarm Low</b>	mV	<u>650</u>
<b>Alarm High</b>	mV	<u>850</u>
<b>Time Limit</b>	min	<u>30</u>
<b>Run Time</b>	10	125
<b>Last Shock</b>		05/01/96

Menu 1

<b>Off</b>
<b>Manual</b>
<b>Auto</b>
<b>Timer</b>

Submenu 1.1

<b>CALIBRATION</b>
<b>Do not change ORP calibration</b>

Submenu 1.2

<b>SETPOINT</b>
<b>Oxidizer</b>
<b>Reducer</b>
<b>Both</b>

Submenu 1.3

<b>ALARM OPTIONS</b>	
<b>Feed lockout</b>	<b>YES</b>
<b>Alarm buzzer</b>	<b>YES</b>

Submenu 1.4.1

Selecting YES for FEED LOCKOUT will inhibit any chemical feed from occurring in case of alarm. Selecting NO will allow feeding to continue. This may be used to continue feeding an oxidizer or sanitizer even if the sensor reading is sometimes low, such as in an overcrowded spa.

Setting ALARM BUZZER to NO disables the buzzer in an alarm condition. There is also a general buzzer shutoff option in the Configuration Menu.

**1.5 – High Alarm**

The ALARM HIGH value is set to generate an alarm when the ORP reading rises above the set value. After the alarm value is set, the ALARM OPTIONS screen is shown, asking whether a high alarm condition should stop the feeder and activate the alarm buzzer.

**1.6 - Time Limit**

The TIME LIMIT sets the maximum allowed time (in minutes) for continuous oxidizer feed. This acts as a safety feature to prevent overfeeding in case of malfunction of the chemical feeder or as an alarm if the feed tank runs empty. The standard (default) value for ORP is 15 minutes.

When in alarm, Time Limit is reset by highlighting the value and pressing "OK". To defeat the safety timer, enter zero (0).

**1.7 - Run Time**

The RUN TIME line displays two separate values: the amount of running time in minutes for each current activation event and the total run time since last reset to zero.

To reset the cumulative run time, enter zero in the far right column. To reset only the current run time, highlight Time Limit value and press "OK".

The Total Feed Time submenu 1.7.1 is used to show the feed time from a chemical tank since last reset to zero. Knowing the pump feed rate, it can be used to monitor the emptying of the tank and set a low-level alarm. This feature is particularly useful for remote monitoring of the chemical tanks.

**1.8 - Last Shock**

The LAST SHOCK line shows the last date of Shock Treatment. It is shown for display only, no adjustment can be made to this date.

Press the RIGHT ARROW key to enter the Submenu 1.8 for Shock Treatment, De-shock and Chemical Saver.

*1.8.1 - Shock Treatment*

Shock Treatment refers to treatment with an elevated level of oxidizer. It should be performed from time to time to prevent the accumulation of noxious chemicals (chloramines) or biological forms (algae, etc.).

Submenu 1.8.1 is used to set the parameters for the shock treatment program.

<b>Total Feed Time</b>	
<b>Max (min)</b>	<u>120</u>
<b>Actual (min)</b>	<u>17</u>
<b>Enter 0 for no alarm</b>	

Submenu 1.7.1

<b>SHOCK AND SAVER MENU</b>	
<b>Shock Treatment</b>	
<b>Deshock</b>	
<b>Chemical Saver</b>	

Submenu 1.8

<b>ORP SHOCK</b>	<u>ON</u>
<b>Date</b>	<u>08/10/01</u>
<b>Cycle (weeks)</b>	<u>1</u>
<b>Time ON</b>	<u>21:00</u>
<b>Time OFF</b>	<u>22:00</u>
<b>Level (mV)</b>	<u>850</u>

Submenu 1.8.1

<b>SAVER</b>	<b>ON</b>	<b>OFF</b>
<b>MO</b>	<u>18:00</u>	<u>06:30</u>
<b>TU</b>	<u>20:00</u>	<u>08:30</u>
<b>WE</b>	<u>20:00</u>	<u>08:30</u>
<b>TH</b>	<u>21:00</u>	<u>07:30</u>
<b>FR</b>	<u>21:00</u>	<u>12:30</u>
<b>SA</b>	<u>17:00</u>	<u>13:30</u>
<b>SU</b>	<u>14:00</u>	<u>08:30</u>

Submenu 1.8.2

*1.8.2 - Deshock*

Deshock refers to the addition of a reducing agent (such as Sodium Thiosulfate) which is used to reduce excessive amounts of oxidizer introduced during Shock Treatment.

*1.8.3 - Chemical Saver*

Submenu 1.8.2 is a weekly program to reduce chemical usage by stopping chemical feed when the facility is not in use, such as at nighttime or on weekends.

## 2 - SANITIZER MENU

### Input Selection

The SANITIZER function is used to monitor the concentration of chlorine (or bromine) using two types of inputs:

- Free Chlorine sensor input for the PC7000 and PC5000,
- PPM values calculated from ORP and pH inputs for the PC6000 and PC3000.

The SANITIZER Menu screen gives access to submenus for control mode, sensor calibration, setpoint, low and high alarms, and superchlorination.

### Free Chlorine Control

The PC7000 and PC5000 controllers use the input from the solid state Free Chlorine sensor. The sensor does not sense bromine and is not affected by oxidizers. The displayed value does not vary with pH.

### Calculated PPM Readings

For the PC6000 and PC3000 controllers, the PPM values are calculated from ORP and pH readings - using a CHEMTROL® proprietary algorithm.

The algorithm is most accurate for clean water. It can be affected by the presence of organic and inorganic contaminants (including cyanuric acid).

In general, clean water shows higher ORP values at lower ppm values. As the water gets dirtier, it takes more ppm to generate the same ORP level. If it becomes excessive, shock treatment or water replacement is needed.

### 2.1 - Display and Calibration

Line 2 displays the SANITIZER concentration in ppm (parts per million) or mg/l (milligrams per liter), as shown on the Main Display screen.

#### *Free Chlorine Calibration*

The Free Chlorine sensor is calibrated on startup. Its signal is vary stable. If it need to be recalibrated, test the water with a DPD test kit and do a second point calibration only (submenus 2.1.2.1 and 2.1.2.2).

#### *Calculated PPM Calibration*

A special 2-point calibration procedure is used for calculated PPM values, as shown on submenus 2.1.2.1 and 2.1.2.2.

**NOTE:** Before recalibration, always do a partial reset of PPM readings using the Operations Menu 8.2.5.

For a pH of 7.5, the calibration algorithm assumes a baseline default value of 635 mV of ORP for 0 ppm (Submenu 2.1.2.1).

For heavily contaminated water, the baseline can be readjusted to lower values. For instance, if the controller readings are too low by 1 to 2 ppm, a baseline value of 600 mV gives better results. For more than 2 ppm, use 575 mV.

<b>SANITIZER</b>	<b>AUTO</b>
<b>Calibrate</b>	ppm <u>1.5</u>
<b>Setpoint</b>	ppm <u>1.5</u>
<b>Alarm Low</b>	ppm <u>0.3</u>
<b>Alarm High</b>	ppm <u>3.0</u>
<b>Time Limit</b>	min <u>30</u>
<b>Run Time</b>	15 60
<b>Last Shock</b>	05/01/98

Menu 2

<p><b>1-PT CALIBRATION</b>  <b>Enter Measurement</b>  <b>from Test Kit:</b>  <u>1.5 ppm</u></p>
---

Submenu 2.1.1

<p><b>2-PT CALIBRATION</b>  <b>Enter ORP value for</b>  <b>0 PPM and pH=7.5:</b>  <u>600 mV</u></p>
---

Submenu 2.1.2.1

<p><b>Enter PPM measurement</b>  <b>from test kit:</b>  <u>1.5 ppm</u></p>
--

Submenu 2.1.2.2



### 2.3 - Setpoint

The SETPOINT determines the SANITIZER level that will be maintained automatically by the controller when placed in the AUTO control mode.

To change the setpoint, press the RIGHT ARROW key and enter the numerical value with the digital keypad. After pressing the OK key, the SETPOINT TYPE Submenu 2.3 is displayed asking whether the control is for a Sanitizer, or for De-sanitization with a reducer, or for both.

The normal (default) setting is for a sanitizer. This means that the oxidizer feed outlet is automatically activated when the sensor reading falls below the setpoint. When set for a reducer, the reducer relay is activated when the sensor reading is above the setpoint.

### 2.4 - Low Alarm

The ALARM LOW value is set to generate an alarm when the SANITIZER reading falls below the set value. After the alarm value is set, the ALARM OPTIONS Submenu 2.4.1 is shown, asking whether a low alarm condition should stop the feeder and activate the alarm buzzer.

### 2.5 - High Alarm

The ALARM HIGH value is set to generate an alarm when the SANITIZER reading rises above the set value. After the alarm value is set, the ALARM OPTIONS Submenu 2.4.1 is shown, asking whether a high alarm condition should stop the feeder and activate the alarm buzzer.

### 2.6 - Time Limit

The TIME LIMIT sets the maximum amount of time in minutes that is allowed for continuous feeding of the oxidizer to correct a high or low SANITIZER reading. This acts as a safety feature to prevent overfeeding in case of a malfunction of the chemical feeder or as an alarm if the feed tank runs empty.

When in alarm, Time Limit is reset by highlighting the value and pressing "OK". To defeat the safety timer, enter zero (0).

### 2.7 - Run Time

The RUN TIME displays the amount of running time in minutes for each current activation event and the cumulative run time since last reset to zero.

To reset the cumulative run time, enter zero in the last column. To reset only the current run time highlight Time Limit value and press "OK".

### 2.8 - Last Shock

The LAST SHOCK line shows the last date of Shock Treatment. It is shown for display only; no adjustments can be made to this date.

If the RIGHT ARROW key is pressed while on this prompt, the screen for Superchlorination, De-shock and Chemical Saver Program will be displayed.

For details on the following options, see the SHOCK and SAVER Submenu further down in Chapter II.

<p><b>SETPOINT</b></p> <p><b>Sanitizer</b></p> <p><b>De-sanitizer</b></p> <p><b>Both</b></p>
--

<p><b>ALARM OPTIONS</b></p>	
<p><b>Feed lockout</b></p>	<p><b><u>YES</u></b></p>
<p><b>Alarm buzzer</b></p>	<p><b><u>YES</u></b></p>

#### 2.8.1 - Superchlorination

Superchlorination refers to treatment with an elevated level of chlorine which should be performed from time to time to prevent the accumulation of noxious chemicals (chloramines) or biological forms (algae, etc).

#### 2.8.2 - Deshock

Deshock refers to the addition of a reducing agent (such as Sodium Thiosulfate) which is used to reduce excessive amounts of chlorine introduced during superchlorination.

#### 2.8.3 - Chemical Saver

The Chemical Saver program is used to save chemicals by reducing the treatment level when the facility is not used, such as during nighttime or on weekends.

### 3 - pH MENU

#### Operation

The pH sensor monitors the concentration of acid or base in the water.

The pH Menu screen is used to access all the pH submenus for Control Mode, sensor calibration, setpoint and alarm settings.

It also displays the actual run time for individual feed events and the cumulative run time since last reset to zero.

#### 3.1- Control Mode

Line 1 shows the pH Control mode that is currently selected: OFF, Manual, AUTO or Timer.

To change the Control Mode, select the first line with the UP or DOWN ARROW keys and press the RIGHT ARROW key. The Control Mode Submenu 3.1 is then displayed.

The control mode screen and selection procedures are common to all control functions. See CONTROL Submenus, page 47.

#### 3.2 - Display and Calibration

The second line displays the current reading of the pH sensor in pH units.

The pH sensor is best calibrated by testing the sample solution with a Phenol Red test kit. If needed, the CALIBRATION value may be adjusted to allow for differences or changes in pH sensor readings.

The pH sensor can be calibrated with 1, 2 or 3-Point calibration for origin, slope and curvature. First, press the RIGHT ARROW key to enter the CALIBRATION Submenu. The calibration procedure is common to all control functions. See CALIBRATION Submenu, page 49.

After calibration, the operator is shown the Submenu 3.2.1 asking whether automatic temperature compensation is to be used for pH readings. This option requires the use of the temperature sensor. The correction is normally small near neutral pH and is used only if large temperature fluctuations are expected.

#### 3.3 - Setpoint

The pH SETPOINT determines the pH level that will be maintained automatically by the controller when placed in the AUTO control mode.

To change the setpoint, first press the RIGHT ARROW key and enter the numerical value with the digital keypad. After pressing the OK key, the SETPOINT TYPE Submenu 3.3.1 is displayed asking whether the control is for Acid or Base.

The normal (default) setting is for Acid feed. This means that the acid feed relay is automatically activated when the pH sensor reading rises above the setpoint. When set to base feed, the base relay is activated when the pH reading is below the setpoint.

pH	<u>AUTO</u>
Calibrate	<u>7.4</u>
Setpoint	<u>7.5</u>
Alarm Low	<u>7.0</u>
Alarm High	<u>8.0</u>
Time Limit	min <u>30</u>
Run Time	15 60
Probe Clean	<u>AUTO</u>

Menu 3

Off
Manual
Auto
Timer

Submenu 3.1

Use Automatic Temperature Compensation for pH ? <u>YES</u>
---

Submenu 3.2.1

SETPOINT
Acid Feed
Base Feed
Both

Submenu 3.3.1

**3.4 - Low Alarm**

The ALARM LOW value is set to generate an alarm when the pH reading falls below the set value. To change the value, press the RIGHT ARROW key and enter the numerical value with the digital keypad (see ORP submenus).

After the alarm value is set, the ALARM OPTIONS Submenu 1.4.1 is displayed, to set the feed interlock and alarm buzzer options. Use the UP and DOWN keys to highlight the desired line and press the RIGHT ARROW key for Yes or NO.

If the Sanitizer Lock option is set to YES, a low pH condition disables the sanitizer feed (ORP and Sanitizer functions).

**3.5 - High Alarm**

The ALARM HIGH value is set to generate an alarm when the pH reading rises above the set value. After the alarm value is set, the ALARM OPTIONS screen is shown, asking whether a high alarm condition should stop the feeder and activate the alarm buzzer (see ORP submenus).

If the Sanitizer Lock option is set to YES, a high pH condition disables the sanitizer feed (ORP and Sanitizer functions).

**3.6 - Time Limit**

The TIME LIMIT sets the maximum allowed time (in minutes) for continuous acid or base feed (see ORP submenus). This acts as a safety feature to prevent overfeeding in case of malfunction of the chemical feeder or as an alarm if the feed tank runs empty. The standard (default) value for pH is 15 minutes.

When in alarm, Time Limit is reset by highlighting the value and pressing "OK". To defeat the safety timer, enter zero (0).

**3.7 - Run Time**

The RUN TIME line displays two separate values: the amount of running time in minutes for each current activation event and the total run time since last reset to zero.

To reset the cumulative run time, enter zero in the far right column. To reset only the current run time, highlight Time Limit value and press "OK" (see ORP submenus).

The Total Feed Time submenu 3.7.1 is used to show the feed time from a tank since last reset to zero. Knowing the pump feed rate, it can be used to monitor the emptying of the tank and set a low-level alarm. This feature is particularly useful for remote monitoring of the chemical tanks.

**3.8 - Probe Clean**

The Probe Clean Menu is used for automatic rinsing of the tips of the ORP and pH sensors by injection of a cleaning solution (usually a weak acid solution) through the recirculation line.

It has three modes of operation: Off, Manual and Automatic (see Submenu 3.8).

In both the Manual and Automatic modes, it allows a recovery time for the sensors to prevent chemical overfeeding while the signal is still affected by the cleaning solution (see Submenu 3.8.1). The recommended minimum is 1 minute.

<b>ALARM OPTIONS</b>	
<b>Feed lockout</b>	<u>YES</u>
<b>Alarm buzzer</b>	<u>YES</u>
<b>Sanitizer Lock</b>	<u>NO</u>

Submenu 3.4.1

<b>Total Feed Time</b>	
<b>Max (min)</b>	<u>120</u>
<b>Actual (min)</b>	<u>17</u>

Submenu 3.7.1

<b>PROBE CLEAN</b>	
<b>OFF</b>	
<b>Manual</b>	
<b>Auto</b>	

Submenu 3.8

<b>PROBE CLEAN</b>	
<b>Electrode Recovery</b>	
<b>Time (min: 1 min)</b>	
<b>3 min</b>	

Submenu 3.8.1

	<b>PROBE CLEAN ON</b>	<b>OFF</b>
<b>MO</b>	<u>19:00</u>	<u>19:05</u>
<b>TU</b>	<u>00:00</u>	<u>00:00</u>
<b>WE</b>	<u>19:00</u>	<u>19:05</u>
<b>TH</b>	<u>00:00</u>	<u>00:00</u>
<b>FR</b>	<u>19:00</u>	<u>19:05</u>
<b>SA</b>	<u>00:00</u>	<u>00:00</u>
<b>SU</b>	<u>19:00</u>	<u>19:05</u>

Submenu 3.8.2

In the Automatic mode, a 7-day weekly program is used to set up the ON and OFF times for probe cleaning any day or every day of the week (see Submenu 3.8.2).

**IMPORTANT NOTE:** Probe Clean is available only when Conductivity control is OFF.

## 4 - CONDUCTIVITY MENU

### Conductivity and TDS

The Conductivity sensor monitors the concentration of **Total Dissolved Solids (TDS)** in the water. The conductivity of the water - in microsiemens per centimeter ( $\mu\text{S}/\text{cm}$ ) - is converted into ppm or mg/l of TDS with a conversion factor that depends on the type of ionic species that are present in the water. Normally, a value of 0.5 is used for water solutions containing different species of carbonate and chloride ions (see 4.8).

Conductivity or TDS can be controlled in two different directions:

- downward (decrease) to bleed water when the TDS level gets too high, or
- upward (increase) to add a salt brine solution for an electrolytic generator when the TDS level gets too low.

**IMPORTANT NOTE:** Conductivity control is available only when Probe Clean control is OFF. It activates the relay labeled "Acid Clean" located on the Power board.

### Conductivity or TDS Displays

Depending on the application, it may be customary to control either conductivity or TDS. The display is therefore available in the two systems, as shown on the sample screens.

To change the displays from conductivity to TDS, one simply enters a TDS factor different from 1 in Submenu (see 4.8 and 4.8.2). If the TDS Factor is 1, the display shows Conductivity in  $\mu\text{S}/\text{cm}$ . If different from 1, it shows TDS in ppm or mg/l.

The CONDUCTIVITY or TDS Main Menu screens are similar to the ones used for other functions, except for the extra line for SELECT SCALE.

#### 4.1- Control Mode

Line 1 shows the Control mode that is currently selected: OFF, Manual, AUTO or Timer. To change the Control Mode, select the first line with the UP or DOWN ARROW keys and press the RIGHT ARROW key. The Control Mode screen is then displayed.

The Control Mode screen and selection procedures are common to all control functions. See CONTROL Submenus, page 47.

#### 4.2 - Display and Calibration

Line 2 displays the current reading of conductivity in  $\mu\text{S}/\text{cm}$  or TDS in ppm or mg/l. The conductivity or TDS readings are best calibrated with standard calibrated test solutions. If needed, the CALIBRATION value may be adjusted to allow for differences or changes in sensor readings.

As with all sensor calibrations, the conductivity sensor can be calibrated with 1, 2 or 3-Point calibration for origin, slope and curvature. Press the RIGHT ARROW key to enter the CALIBRATION Submenu 4.1. The calibration procedure is common to all control functions. See CALIBRATION details, page 49.

Menu 4

<b>CONDUCTIVITY</b>		<b>AUTO</b>
<b>Calibrate</b>	uS	<u>1500</u>
<b>Setpoint</b>	uS	<u>1500</u>
<b>Alarm Low</b>	uS	<u>100</u>
<b>Alarm High</b>	uS	<u>3000</u>
<b>Time Limit</b>	min	<u>30</u>
<b>Run Time</b>	15	<u>60</u>
<b>Select Scale</b>		

Menu 4 (TDS Alternate)

<b>TDS</b>		<b>AUTO</b>
<b>Calibrate</b>	ppm	<u>750</u>
<b>Setpoint</b>	ppm	<u>750</u>
<b>Alarm Low</b>	ppm	<u>50</u>
<b>Alarm High</b>	ppm	<u>1500</u>
<b>Time Limit</b>	min	<u>30</u>
<b>Run Time</b>	15	<u>60</u>
<b>Select Scale</b>		

Menu 4.3.1

<b>SETPOINT</b>
<b>Decrease</b>
<b>Increase</b>

#### 4.3 - Setpoint

The SETPOINT determines the conductivity or TDS level that will be maintained automatically by either dumping (bleeding) water or adding a brine solution - as determined in submenu 4.3.1. To change the setpoint, press the RIGHT ARROW key and enter the desired value with the digital keypad.

#### 4.4 - Low Alarm

The ALARM LOW value is set to generate an alarm when the conductivity or TDS reading falls below the set value. After the alarm value is set, the ALARM OPTIONS screen is shown, asking whether a low alarm condition should stop the dump valve and activate the alarm buzzer. There is no particular danger resulting from a low TDS condition but it may be an indication of a faulty sensor.

#### 4.5 - High Alarm

The ALARM HIGH value is set to generate an alarm when the conductivity or TDS reading rises above the set value. After the alarm value is set, the ALARM OPTIONS screen is shown, asking whether a high alarm condition should stop the dump valve and activate the alarm buzzer.

#### 4.6 - Time Limit

The TIME LIMIT sets the maximum amount of time in minutes that is allowed for continuous dumping of water to correct a high conductivity or TDS reading. This acts as a safety feature to prevent overdumping of water in case of a malfunction of the dump valve.

When in alarm, Time Limit is reset by highlighting the value and pressing "OK". To defeat the safety timer, enter zero (0).

#### 4.7 - Run Time

The RUN TIME line displays two separate values: the amount of running time in minutes for each current activation event and the total run time since last reset to zero.

To reset the cumulative run time, enter zero in the far right column. To reset only the current run time, highlight Time Limit value and press "OK" (see ORP submenus).

The Total Feed Time submenu 4.7.1 is used to show the feed time from a tank since last reset to zero. Knowing the pump feed rate, it can be used to monitor the emptying of the tank and set a low-level alarm. This feature is particularly useful for remote monitoring of the chemical tanks.

#### 4.8 - Select Scale

The Select Scale prompt takes the operator to the SELECT SCALE Submenu 4.8.

##### 4.8.1 - Scale Selection

Submenu 4.8.1 is used to select the conversion parameters for different types of conductivity sensors. The SCALE may be set to 500, 2000, 5000, 10000, or 20000  $\mu\text{S}/\text{cm}$ .

##### 4.8.2 - Cell Constant

The Cell Constant is the aspect ratio of the conductivity sensor (length divided by cross sectional area) in  $\text{cm}^{-1}$ . It should be set according to the probe manufacturer specifications.

##### 4.8.3 - TDS Factor

The TDS Factor is the conversion factor used to convert from conductivity readings (in  $\mu\text{S}/\text{cm}$ ) to Total Dissolved Solids concentrations (in ppm or mg/l).

Because the conductivity of ionic species varies with the type of electronic charges, the TDS factor is somewhat empirical. For typical water treatment solutions, it is about 0.5. For instance, a Sodium Chloride solution with a conductivity of 2,000  $\mu\text{S}/\text{cm}$  contains about 1,020 ppm (mg/l) of NaCl. This indicates a TDS factor of 1020/2000 or about 0.5.

When a TDS Factor different from 1 is entered in Submenu 4.8.3, all the readings and displays are changed automatically from conductivity to TDS values. They can be changed back to conductivity by re-entering a value of 1 for the TDS factor.

Total Feed Time	
Max (min)	<u>120</u>
Actual (min)	<u>17</u>

Submenu 4.7.1

SELECT SCALE	
$\mu\text{S}/\text{cm}$	<u>2000</u>
Cell Constant	<u>1.00</u>
TDS Factor	<u>0.50</u>

Submenu 4.8

SELECT SCALE	
500 $\mu\text{S}/\text{cm}$	
2,000 $\mu\text{S}/\text{cm}$	
5,000 $\mu\text{S}/\text{cm}$	
10,000 $\mu\text{S}/\text{cm}$	
20,000 $\mu\text{S}/\text{cm}$	

Submenu 4.8.1

TDS FACTOR: <u>0.50</u>
For TDS Factor
different from 1
Display shows TDS

Submenu 4.8.3

## 5 - TEMPERATURE MENU

### Operation

The Temperature Menu, or Heater Menu, is used to control the operation of the heater with the temperature sensor. All displays can be shown in either degrees Fahrenheit or Celsius.

The Temperature Menu screen is used to access all the Temperature submenus for Control Mode, sensor calibration, setpoint and alarm settings. It also displays the actual run time for the heater and the cumulative run time since last reset to zero.

### 5.1 - Control Mode

Line 1 shows the Control mode that is currently selected: OFF, Manual, AUTO or Timer. To change the Control Mode, select the first line with the UP or DOWN ARROW keys and press the RIGHT ARROW key. The control mode screen and selection procedures are common to all control functions. See CONTROL Submenus, page 47.

### 5.2 - Display and Calibration

The second line displays the current reading of the Temperature sensor in either temperature units.

The temperature sensor can be calibrated with 1, 2 or 3-Point calibration for origin, slope and curvature. Press the RIGHT ARROW key to enter the CALIBRATION Submenu. The calibration procedure is common to all control functions. See CALIBRATION Submenus, page 49.

### 5.3 - Setpoint

The SETPOINT determines the temperature level in the AUTO control mode. To change the setpoint, press the RIGHT ARROW key and enter the numerical value with the digital keypad. After pressing the OK key, the SETPOINT TYPE Submenu 5.3.1 is displayed asking whether the control is for Heating or Cooling.

The normal (default) setting is for Heating. This means that the heater is automatically activated when the temperature sensor reading falls below the setpoint. If it is set for Cooling, the cooler is activated when the temperature sensor reading is above the setpoint.

### 5.4 - Low Alarm

The ALARM LOW value is set to generate an alarm when the temperature reading falls below the set value. After the alarm value is set, the ALARM OPTIONS screen is shown, asking whether a low alarm condition should stop the heater and activate the alarm buzzer.

<b>HEATER</b>		<b>AUTO</b>
<b>Calibrate</b>	F	<u>80</u>
<b>Setpoint</b>	F	<u>80</u>
<b>Alarm Low</b>	F	<u>70</u>
<b>Alarm High</b>	F	<u>85</u>
<b>Time Limit</b>	min	<u>30</u>
<b>Run Time</b>	15	<u>60</u>
<b>Energy Saver</b>		<u>OFF</u>

Menu 5

<b>SETPOINT</b>
<b>Heating</b>
<b>Cooling</b>

Submenu 5.3.1

### 5.5 - High Alarm

The ALARM HIGH value is set to generate an alarm when the temperature reading rises above the set value. After the alarm value is set, the ALARM OPTIONS screen is shown, asking whether a high alarm condition should stop the heater and activate the alarm buzzer.

### 5.6 - Time Limit

The TIME LIMIT sets the maximum amount of time in minutes that is allowed for continuous heating to correct a low temperature reading. This acts as a safety feature to prevent overheating in case of a malfunction of the heater or sensor.

When in alarm, Time Limit is reset by highlighting the value and pressing "OK". To defeat the safety timer, enter zero (0).

### 5.7 - Run Time

The RUN TIME line displays two separate values: the amount of running time in minutes for each current activation event and the total run time since last reset to zero.

To reset the cumulative run time, enter zero in the far right column. To reset only the current run time, highlight Time Limit value and press "OK".

### 5.8 - Energy Saver

The Energy Saver program is used to reduce the temperature when the pool is not in use in order to save energy costs. It includes a seven-day programmer for OFF and ON times and a temperature level adjustment.

When the energy saver is on, the control temperature is lowered.

**6- PUMP MENU**

**Operation**

The Pump Menu is used to monitor and control the operation of the main recirculation pump, including pressure and flow rate. It is also used for programming of pump shutoff delay (fireman) that allows time for cooling off the heater.

The main pump may be on, off, or set to start automatically. Note that it will run for the amount of time set in the SHUTOFF DELAY after being turned off, to avoid system damage that could occur from excessive chemical concentrations in the plumbing. Thirty seconds before the pump starts automatically, the alarm sounds a warning beep in case maintenance operations are being performed.

**NOTE: If the Pump function is activated, all other control functions are shut down when the pump is set to OFF.** No alarms occur. The controller may still be operated via the keyboard and display, or remotely by computer or telephone.

If the controller appears to be nonfunctioning, always check that the pump is operating (small ARROW on Display Screen). This is true even if the pump is not physically connected to the controller.

**6.1- Control Mode**

Submenu 6.1 is used to select the Control mode: OFF, MANUAL, AUTO or TIMER.

TIMER is to be used ONLY on installations with vacuum sand filters.

When AUTO is selected, the Pump Schedule Submenu 6.1.1 is displayed. Daily ON and OFF times can be selected by the operator. If nothing is selected, the pump stays off all the time.

All scheduled times should be entered in the 24:00 hour format. Different times can be entered for different days. This allows for reduced costs of operation on weekends.

<b>PUMP</b>		<b><u>AUTO</u></b>
<b>P influent</b>	psi	<b><u>25</u></b>
<b>P effluent</b>	psi	<b><u>20</u></b>
<b>Flow rate</b>	gpm	<b><u>800</u></b>
<b>Flow Total</b>	Kga	<b><u>0</u></b>
<b>Heater delay</b>	min	<b><u>20</u></b>
<b>Water Level</b>		<b><u>AUTO</u></b>

Menu 6

<b>PUMP</b>	
<b>Off</b>	
<b>Manual</b>	
<b>Automatic</b>	
<b>Timer</b>	

Submenu 6.1

<b>PUMP</b>	<b>ON</b>	<b>OFF</b>
<b>Mo</b>	<b><u>06:00</u></b>	<b><u>20:00</u></b>
<b>Tu</b>	<b><u>06:00</u></b>	<b><u>20:00</u></b>
<b>We</b>	<b><u>06:00</u></b>	<b><u>20:00</u></b>
<b>Th</b>	<b><u>06:00</u></b>	<b><u>20:00</u></b>
<b>Fr</b>	<b><u>06:00</u></b>	<b><u>20:00</u></b>
<b>Sa</b>	<b><u>06:00</u></b>	<b><u>18:00</u></b>
<b>Su</b>	<b><u>09:00</u></b>	<b><u>18:00</u></b>

Submenu 6.1.1

## 6.2 - Influent Pressure

Line number 2 in the Pump Menu screen displays the current reading of the Influent Pressure sensor, i.e. before the first filter.

It is one of the parameters that can be used to initiate the filter backwashing operation when it exceeds a specified value that is indicative of a dirty filter condition (see Menu 7 - Filter Menu).

### *Pressure Alarms*

Submenu 6.2 is used to specify the alarm limits for the influent pressure in case of malfunction of the pump, filter or valves. There is no equivalent submenu for the effluent pressure. To change the limits, (1) select the + or - sign using the right arrow, (2) press "OK", (3) enter the limit value, (4) press "OK".

Submenu 6.2.1 sets the options for the low alarm while submenu 6.2.2 sets the options for the high alarm. If set on YES, the Feed Limit alarm shuts off the main pump and the buzzer alerts the operator.

Upon exit from this submenu, the calibration submenu is displayed.

### *Calibration*

The pressure sensor is calibrated in the Submenu 6.2.1.1 by entering two factors representing (1) the output of pressure per volt, and (2) the output in volts corresponding to zero pressure, as specified by the manufacturer of the sensor.

The factory set **default factors of 12.0 and 1.75** are valid for *CHEMTROL®* pressure transducer Series 1200 in the pressure range of -15 to 45 psi. It should normally not require any adjustment.

## 6.3 - Effluent Pressure

Line number 3 in the Pump Menu screen shows the value of the Effluent Pressure, i.e. after the filter(s).

The effluent pressure sensor is calibrated in the same way as the Influent Pressure sensor.

### **Differential Pressure**

The controller automatically calculates the value of the Differential Pressure, i.e. Influent Pressure minus Effluent Pressure.

This is one of the parameters that can be used to initiate the filter backwashing operation when it exceeds a specified value that is indicative of a dirty filter condition (see Menu 7 - Filter Menu).

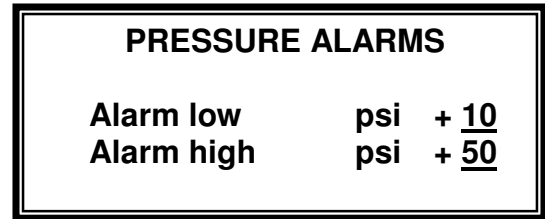

Menu 6.2

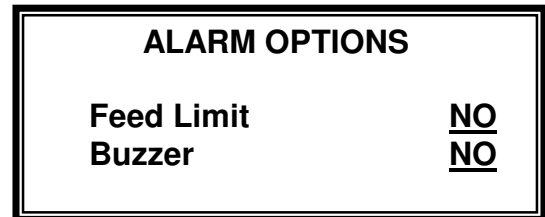

Menu 6.2.1 and 6.2.2

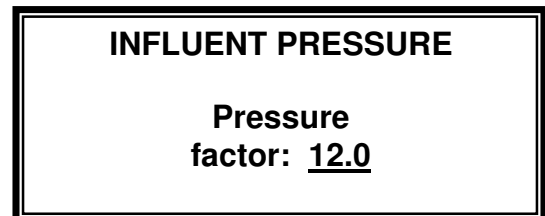

Submenu 6.2.1.1

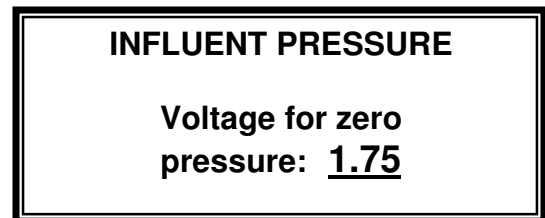

Submenu 6.2.1.2



**6.4 - Flow Rate**

This line displays the flow rate through the main recirculation line using input from the square wave pulse sensor. To calibrate the flow sensor, press the RIGHT ARROW key to enter Submenu 6.4.

The flow sensor is calibrated by entering the K-factor provided by the sensor manufacturer. These values correspond to the number of pulses per unit of volume in gallons or liters, which are given by the sensor manufacturer.

The values shown in the two tables below are for ideal conditions according to ASTM-D-1785. K-factors provided by the sensor manufacturer should be used when available.

These K values however are accurate only under **ideal flow conditions that are rarely met in practice** (see Chapter II - Installation).

For best results, the flowmeter should be calibrated by one of the following methods, listed in order of decreasing accuracy:

1. Measurement with ultrasonic flow meter,
2. Calculation from pump manufacturer curve and pressure differential before and after the pump,
3. Hydrodynamic calculations from engineering design.

It should be noted that the readings can vary with actual flow conditions in the pipe.

If further adjustments are needed, note that **higher K values correspond to lower flow rates**.

**6.5 - Flow Total**

Line number 5 in the Pump Menu shows the cumulative flow since last reset to zero or since the last backwash.

To reset the cumulative flow counter, press the RIGHT ARROW key. This will automatically reset the counter to 0.

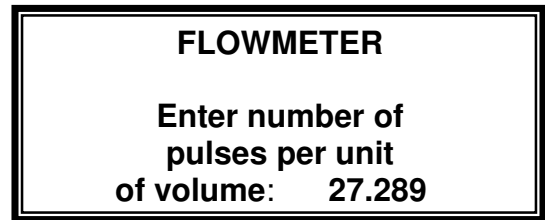

**Submenu 6.4**

<i><b>SCHEDULE 80</b></i> DIAM (in.)	<i><b>K-FACTOR</b></i> U.S. GA	<i><b>K-FACTOR</b></i> LITERS
1.5	175.394	46.339
2.0	105.032	27.749
2.5	74.093	19.576
3.0	47.411	12.526
3.5	35.482	9.374
4.0	27.289	7.210
5.0	17.113	4.521
6.0	11.932	3.152
8.0	6.795	1.795
10.0	4.164	1.100
12.0	2.854	0.754

**Schedule 80 Factors**

<i><b>SCHEDULE 40</b></i> DIAM (in.)	<i><b>K-FACTOR</b></i> U.S. GA	<i><b>K-FACTOR</b></i> LITERS
1.5	151.145	39.933
2.0	89.666	23.690
2.5	65.054	17.187
3.0	42.703	11.282
3.5	31.661	8.365
4.0	24.387	6.443
5.0	15.463	4.085
6.0	10.692	2.825
8.0	6.095	1.610
10.0	3.726	0.984
12.0	2.571	0.679

**Schedule 40 Factors**

**6.6 - Heater Delay (Cooldown Safety)**

The cooldown safety (or Fireman) is a delay for heater cooldown before shutoff of the main recirculation pump. It is used to protect the heater from overheating due to lack of water circulation.

The minimum value recommended by most heater manufacturers is 20 minutes. When the pump is programmed to turn off, it turns the heater off immediately and then waits 20 minutes for the water to cool down before it actually shuts off the recirculation pump.

In case of emergency, the main power supply to the pump should be turned off at the main circuit breaker.

**6.7 - Water Level Control**

The water level in the pool can be maintained automatically with a water level sensor (OPTION LEVEL) and fill valve.

The sensor is an electro-optical sensor P/N 138167 (Figure 28, Page 19) that can be located in the pool or in the surge pit (Figure 30, Page 19).

The sensor uses the reflection of a LED beam inside a prism to determine the position of the water level (see Figure 29, Page 19). With no liquid present, the light beam from the LED is reflected within the prism to the receiver. When the liquid level reaches the prism, the index of refraction is changed and the beam does not reflect into the receiver. For best results, the surface of the prism must remain clean.

Submenu 6.7 is used to set the automatic fill valve to OFF, Manual or AUTO. During fill, chemistry adjustment can be put on hold by setting the Feed lockout option to YES. The submenu also allows the setting of a Time Limit for valve actuation to avoid overfilling. Line 4 displays the actual and cumulative run times for water filling.

Submenu 6.7 also allows to set the high level alarm safety feature for PC7000 controllers, used during filter backwash to avoid overflowing the waste pit. When set to YES, the controller senses the input of the "high level" sensor and will shut off the backwash cycle if a high level is detected.

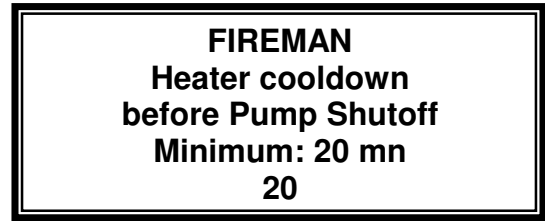

Submenu 6.6

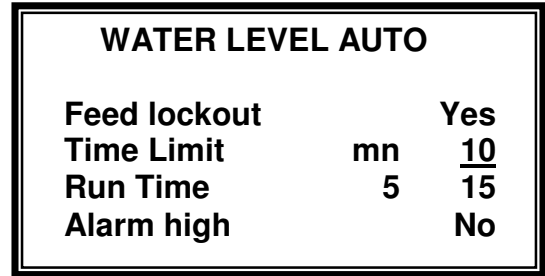

Submenu 6.7

## 7 - FILTER MAIN MENU

### Filter Backwash

The Filter Menu for the *CHEMTROL®* PC7000 allows the operator to set the parameters for automatic backwashing. It can be applied to one filter (Figure 10, Page 21) or to several filters (Figure 33, Page 21) with programmable sequencing of multiple filters.

During backwash operation, the "BACKWASH CYCLE" message is displayed on the Main Screen (Figure 4, Page 4).

The backwash operation is controlled with up to six (6) double-pole, double-throw (DPDT) relays to allow sequential closing and opening of backwash valves. See Filter Backwash in Chapter IV - INSTALLATION for details (Page 21).

Line 7.1 sets the BACKWASH mode to OFF, MANUAL or AUTO.

-OFF disables all backwash operations. If a backwash cycle is in progress, it is terminated immediately.

-MANUAL initiates an immediate backwash cycle.

-In the AUTO mode, the backwash cycle is initiated under programmable parameters set in Submenu 7.1, either time schedule and/or differential pressure.

Line 7.2 sets the START DATE for the first timed cycle.

Line 7.3 sets the START TIME for automatic cycles.

Line 7.4 sets the backwash and rinse durations per filter. To defeat the Rinse cycle, set it to zero (0). If Rinse is used, a maximum of 3 filter backwash/rinse cycles are available and the rinse relays are as follows: rinse1="filter4", rinse2="filter5", rinse3="filter6".

Line 7.5 sets the delay time between filters.

Line 7.6 sets the number of filters (maximum of 6 - or 5 if Water Level control is used).

It then leads to Submenu 7.6.1 asking if a priority valve is used. This feature, which uses the De-Oxy relay is not available if the ORP control is set to Reducer or Both.

Line 7.7 shows the status of the Pump Shutdown backwash alarm. When set to YES, the pump is shut off automatically if the flow rate at the end of the cycle plus 3 minutes is not restored to at least its initial value - indicating mechanical failure.

Line 7.8 sets the PUMP OVERRIDE option to shut off the main pump during cycling of the backwash valves. This is sometime recommended to reduce pressure on the valves.

### 7.1 - Automatic Backwash

Before accessing the setup screen, Submenu 7.1 shows a reminder indicating that the pump must be set to MANUAL or AUTO for the automatic backwash program.

Press the RIGHT ARROW key to enter the Automatic Backwash Submenu 7.1 for program selection.

<b>BACKWASH</b>	<b>AUTO</b>
<b>Start Date</b>	<b>08/10/96</b>
<b>Start Time</b>	<b>15:30</b>
<b>Filter Time (min)</b>	<b>10</b>
<b>Advance Time (min)</b>	<b>1</b>
<b>Number of Filters</b>	<b>6</b>
<b>Pump Shutdown</b>	<b>YES</b>
<b>Pump Override</b>	<b>YES</b>

Menu 7

<b>Time Interval</b>
<b>P Differential</b>
<b>Time or Pressure</b>
<b>Time &amp; Pressure</b>
<b>Flow rate</b>
<b>Volume of water</b>
<b>Volume or Pressure</b>
<b>Volume &amp; Pressure</b>

Submenu 7.1

<b>PRIORITY VALVE ?</b>
<b>YES</b>
<b>NO</b>

Submenu 7.6.1

## 7.1.1 - Time Interval

This option allows the operator to set a cycle schedule with a fixed interval of days between successive backwash operations. Pressure differential is not considered. If this option is selected, the program asks for the number of days between backwash cycles and then returns to the Backwash Submenu to specify the starting date and starting time of the day.

The standard (default) value for the backwash cycle is 14 days following the initial startup date set on the Backwash Submenu screen. It can be changed at any time by the operator.

## 7.1.2 - Pressure Differential

This option causes a backwash cycle to be initiated when the difference between the influent and effluent pressures at the filter exceeds the set amount. The difference entered can range from 1 to 99 psi or kg/cm<sup>2</sup>.

## 7.1.3 - Time or Pressure Differential

This option causes a backwash cycle to be initiated when EITHER the specified interval number of days has passed OR the specified difference between the influent and effluent pressures exceeds the set amount.

The default difference value is 5 psi or kg/cm<sup>2</sup>. It can be changed to any value in the range of 1 to 99 psi or kg/cm<sup>2</sup>. The time interval between backwash cycles can range from 1 to 99 days.

## 7.1.4 - Time and Pressure Differential

This option causes a backwash cycle to be initiated when BOTH the specified interval number of days has passed AND the specified difference between the INFLUENT and EFFLUENT pressures exceeds the set amount.

The default difference value is 5 psi or kg/cm<sup>2</sup>. It can be changed to any value in the range of 1 to 99 psi or kg/cm<sup>2</sup>.

The time interval between backwash cycles can range from 1 to 99 days.

## 7.1.5 – Flow Rate

This option causes a backwash cycle to be initiated when the main recirculating flow rate, measured by the square wave flow sensor, falls below the set amount.

**TIME INTERVAL**

**Days between  
Backwash Cycles:  
14**

Submenu 7.1.1

**PRESSURE DIFFERENTIAL**

**Backwash starts when  
Influent Pressure minus  
Effluent Pressure  
exceeds: 5 psi**

Submenu 7.1.2

**TIME OR PRESSURE  
Backwash starts when  
either Time OR  
Pressure Differential  
is reached.**

**Time (days): 7  
Difference: 5 psi**

Submenu 7.1.3

**TIME AND PRESSURE  
Backwash starts when  
both Time AND  
Pressure Differential  
are reached.**

**Time (days): 7  
Difference: 5 psi**

Submenu 7.1.4

**FLOW RATE**

**Backwash starts when  
flow rate falls below:  
140 gpm**

Submenu 7.1.5

7.1.6 – Volume of Water

This option causes a backwash cycle to be initiated when the volume of water accumulated since the last backwash exceeds the set amount. The default value 0 disables the function.

7.1.7 – Volume or Pressure Differential

This option causes a backwash cycle to be initiated when EITHER the specified volume of water has accumulated OR the specified difference between the influent and effluent pressures exceeds the set amount.

7.1.8 - Volume and Pressure Differential

This option causes a backwash cycle to be initiated when BOTH the specified volume of water has accumulated AND the specified difference between the INFLUENT and EFFLUENT pressures exceeds the set amount.

Safety Shutoff

**NOTE: 7.1.2, 7.1.3, 7.1.4, 7.1.7 and 7.1.8: if the pressure differential at the end of the backwash cycle + 3 minutes is not restored to normal clean filter operation, the Filter control mode will be turned to OFF.**

**NOTE: 7.1.5: if the flow rate at the end of the backwash cycle + 3 minutes is not restored to normal clean filter operation, the Filter control mode will be turned to OFF.**

7.6 - Priority Valve

A Priority Valve can be specified in Submenu 7.6 to allow backwashing of the filters with clean water, as shown in Figure 33.

7.7 - Pump Shutdown

If set to YES, the Main Pump will be shut down if the flow rate at the end of the Backwash Cycle + 3 minutes is not restored to or above its initial value before backwash.

7.8 - Pump Override

The PUMP OVERRIDE option is used to shut off the main pump during cycling of the backwash valves. This is sometime recommended to reduce pressure on the valves.

The minimum default value is 5 seconds, which shuts the pump for a total of 10 seconds (5 seconds before start of valve cycling to reduce flow and 5 seconds after to cycle valves).

**VOLUME OF WATER**

**Backwash starts when  
Volume of water accumulated  
since last backwash  
exceeds: 300,000 Gal**

Submenu 7.1.6

**VOLUME OR PRESSURE**

**Backwash starts when  
either Volume OR  
Pressure Differential  
is reached.**

**Volume (Gal): 300,000**  
**Difference (psi): 5**

Submenu 7.1.7

**VOLUME AND PRESSURE**

**Backwash starts when  
both Volume AND  
Pressure Differential  
are reached.**

**Volume (Gal): 300,000**  
**Difference (psi): 5**

Submenu 7.1.8

**PUMP OVERRIDE**

**Stop pump before changing  
backwash valves ?**  
**YES NO**

**Time for valve motion  
(min 5 sec)**  
**10**

Submenu 7.8

## CONTROL SUBMENUS

### Features

The CONTROL Submenus are common to all the functions that require control of the operating variable at a fixed setpoint. This includes ORP, pH, Conductivity and Temperature.

For all functions, control can be made more effective and precise with the use of a deadband and a progressive zone.

Since they are the same for each variable, the Control Submenus are identified below with the generic letter X.

### X.1 - Control Type

The Control Submenu X.1 is used to select the control type: OFF, Manual, Automatic or Timer. Use the UP and DOWN keys to highlight the desired selection and then press the RIGHT ARROW key to confirm the selection.

If the operator selects OFF, the controller turns off the feed control outlet immediately and returns to the previous menu.

If the operator selects Manual, the controller turns on the feed control outlet immediately and returns to the previous menu.

**CAUTION:** On Manual setting, the outlet stays on until turned off regardless of sensor readings. If the run time exceeds the Time Limit set by the operator in the specified submenu, the outlet will be turned off to prevent accidental overfeeding.

#### X.0.1 - Deadband

In both automatic control modes (ON/OFF and Proportional), the controller uses a deadband zone near the setpoint. In this zone, there is no outlet activation. This is designed to prevent chattering of the relay. The deadband is expressed as a percentage of the setpoint value and can be adjusted by the operator on the DEADBAND screen.

With the deadband, the outlet remains activated until the sensor reading reaches the setpoint, at which point it is deactivated. In order for the relay to be re-activated, the reading has to get outside the deadband, thus eliminating the effect of small fluctuations.

#### X.0.2 - Progressive Zone

The **PROGRESSIVE ZONE** is a control zone around the setpoint where the outlet activation depends on how far the sensor reading is from the setpoint (see Figure 35, Page 48).

If the sensor reading is outside of the zone, then the outlet is turned on 100% of the time. The activation rate then decreases progressively as the reading nears the setpoint value. It goes to 0% when the reading reaches the setpoint.

This control mode is available in Proportional Control only (see next page). It provides more precise control than ON/OFF control and reduces overfeeding, particularly in small bodies of water.

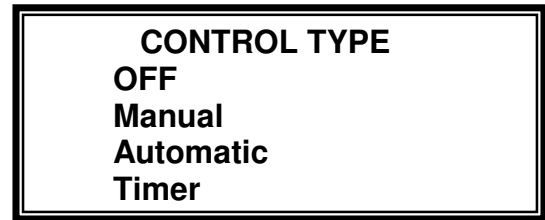

Submenu X.1

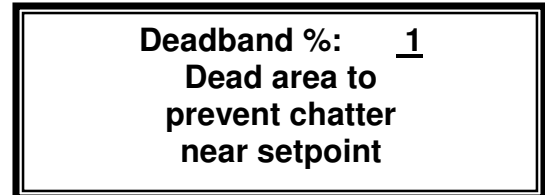

Submenu X.0.1

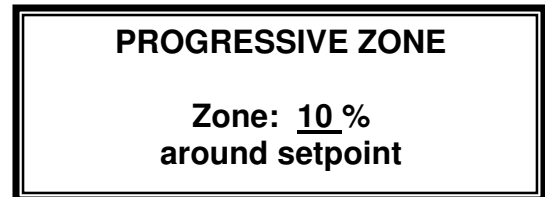

Submenu X.0.2

*X.1.3 - Automatic Control*

In the **Automatic Control Type**, the operator can choose among two different Control Modes: ON/OFF or, as shown on Submenu X.1.3.

**X.1.3.1 ON/OFF Control**

In the ON/OFF Control mode, the controller activates the control outlet until the setpoint is reached, at which point it is turned off. It is turned on again when the reading is outside of the deadband.

Selection of the ON/OFF control mode leads to the DEADBAND submenu screen X.0.1 discussed above.

**X.1.3.2 Proportional Control**

The Proportional Control mode is recommended only for small pools and spas to prevent overfeeding from oversized feeders. In this mode, the outlet relay is turned ON and OFF at a rate that decreases as the setpoint is neared. The rate goes down from 100% ON in a 100-second CYCLE TIME at the edge of the Progressive Zone to 0% at the setpoint (see Figure 35).

Proportional control operates only within the defined Progressive Zone (see Submenu X.0.2 on previous page). Outside the zone, control reverts to standard ON/OFF mode.

The wider the Progressive Zone is, the more slowly and precisely the controller will return to the setpoint. As the width of the Progressive Zone is decreased, the reaction becomes faster and faster until eventually, one gets near the conditions of ON/OFF control.

It should be noted that longer time limits may be required to account for the slower effective feed rates.

**X.1.3.3 - 4-20 mA Control**

In the special option for "4-20 mA" Control Mode, the controller sends an electronic signal output from 4 to 20 mA that is proportional to the distance from the setpoint. A 4 mA output corresponds to 0% feed rate, 12 mA to 50% and 20 mA corresponds to 100%. The values of the 0 and 100% limits are adjustable for each function.

This type of control requires a device - usually an electronic feed pump - with a linear response to output currents.

*X.1.4 - Timer Control*

In the Timer Control mode, the controller activates the control outlet according to fixed ON and OFF cycles (in minutes), regardless of sensor input. This allows programmable metered operation in case of sensor failure.

It can also be used to feed a supplementary oxidizer, as in the Automated Chloramine Treatment (ACT) process.

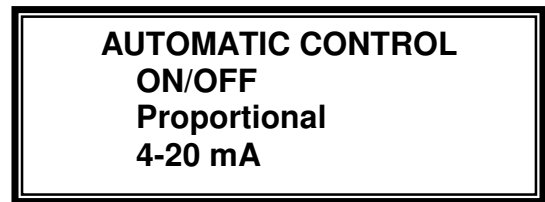

Submenu X.1.3

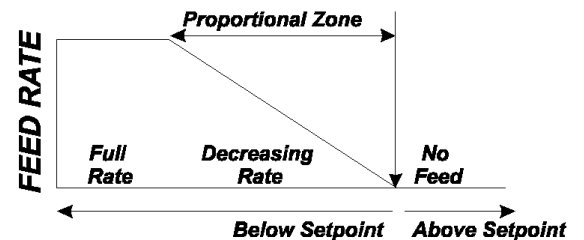
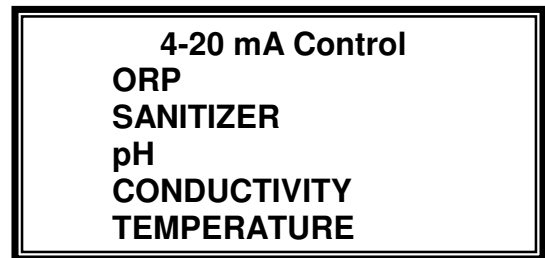
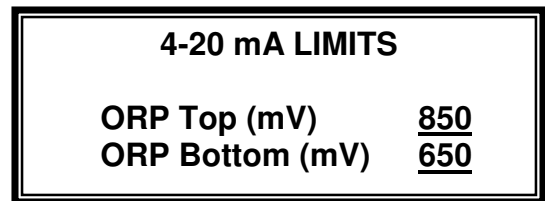

Figure 35 - Proportional Feed Rate



Submenu X.1.3.3



Submenu X.1.3.3.1

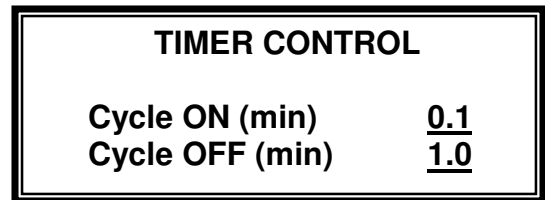

Submenu X.1.4

## CALIBRATION SUBMENU

### X.2 - Calibration Options

The CALIBRATION Submenu is common to all the functions that require sensor calibration. This includes Sanitizer, pH, Conductivity and Temperature. It allows calibration for 1, 2 or 3-point - depending on the degree of accuracy that is required.

The CALIBRATION OPTION Submenu is used to select the number of calibration points desired. Most applications require only 1- Point calibration but any number up to three can be selected. If more than 1-point calibration is selected, the operator needs to use the required number of sample solutions. These sample solutions must be spaced sufficiently from one another to yield meaningful calibration values.

#### X.2.1 - One-Point Calibration

When using 1-Point calibration, the conversion curve for the sensor readings is a straight line. The slope is a default value that is built in the program.

1-Point calibration should be satisfactory for most applications. The operator places the sensor in a single water sample and tests it with an appropriate test kit. The value obtained is then entered on the calibration screen as the new display value.

The controller uses the calibration value that has been entered by the operator to calculate the origin "a" of the representative linear equation:

$$\text{DISPLAY} = a + \text{SLOPE} * \text{INPUT}$$

#### X.2.2 - Two-Point Calibration

With 2-Point calibration, the operator needs to use two different solutions with values that are spaced widely enough to show significant differences in the slope of the calibration curve.

The controller uses these values to calculate the origin "a" and slope "b" in the equation:

$$\text{DISPLAY} = a + b * \text{INPUT}$$

#### X.2.3 - Three-Point Calibration

With 3-Point calibration, the straight line is replaced by a second-degree polynomial curve. The operator needs three calibration solutions with values that are sufficiently spaced apart to show differences in the curvature of the polynomial.

The controller uses these three values to calculate the origin "a", slope "b" and curvature "c" in the equation:

$$\text{DISPLAY} = a + b * \text{INPUT} + c * \text{INPUT} * \text{INPUT}$$

**CALIBRATION**  
**1 Point (zero)**  
**2 Point (slope)**  
**3 Point (curve)**

Submenu X.2

**1-PT CALIBRATION**

**Point 1**      **7.5**

Submenu X.2.1

**2-PT CALIBRATION**

**Point 1**      **7.5**  
**Point 2**      **10.0**

Submenu X.2.2

**3-PT CALIBRATION**

**Point 1**      **4.0**  
**Point 2**      **7.5**  
**Point 3**      **10.0**

Submenu X.2.3



**SHOCK AND SAVINGS SUBMENUS**

**X.8 - Treatment Selection**

Submenu X.8 is used to select the shock treatment and savings program.

The **Shock Treatment** program is used to destroy harmful elements, such as chloramines, germs and algae, by raising the oxidizer or sanitizer level on a specified schedule. This can be done either with the ORP function menu (Shock Treatment) or with the Sanitizer function menu (SUPERCHLORINATION), depending on which activation outlet is used.

The **Deshock** program can be used after the Shocking program to return the concentration levels back to normal values.

The **Chemical Savings** program is used to save chemicals by reducing the treatment level when the facility is not in use, such as at nighttime or on weekends.

*X.8.1 - Shock Treatment Program*

The Shock Treatment Submenu X.8.1 allows the operator to set the program to OFF, MANUAL or AUTO.

When set to MANUAL, the Shock Treatment program starts immediately. When set to Automatic, the operator selects the date of the first treatment and the cycle in weeks for repeat treatments. He also sets the time to start and time to stop as well as the level of shock treatment to reach, in mV for Shock Treatment or in ppm or mg/l for Superchlorination.

Chemical injection stops when either the set level is reached or the end time is reached.

*X.8.2 - Deshock Program*

The deshock program is set to feed a reducing agent - such as Sodium Thiosulfate - to eliminate excessive amounts of sanitizer after superchlorination. The operator may set the desired level, and the time limit in hours for the deshock process. When enabled, deshock immediately follows the shock treatment process. It stops when either the set level or the time limit is reached.

*X.8.3 - Chemical Saver Program*

The Chemical Saver program may be set to MANUAL, OFF or AUTO. If set MANUAL, it will start immediately and will continue until changed back to OFF or placed in AUTO. If AUTO is selected, the Weekly Scheduling Submenu X.8.3.1 is displayed.

All times are expressed in standard 24:00 time format. The operator can select any start and end time for the chemical saver program for any day of the week, as shown on the sample screen.

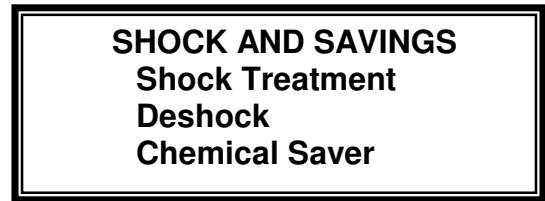

Submenu X.8

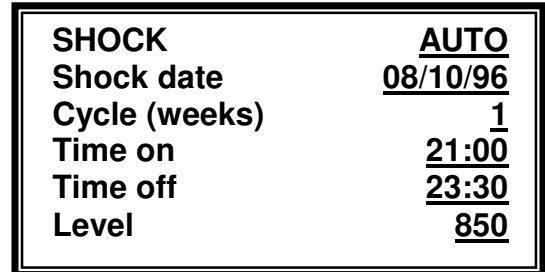

Submenu X.8.1

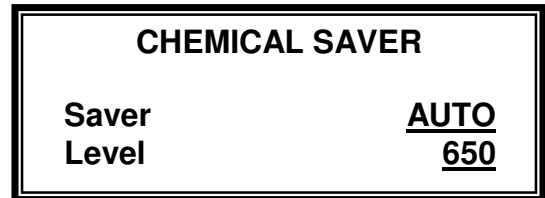

Submenu X.8.3

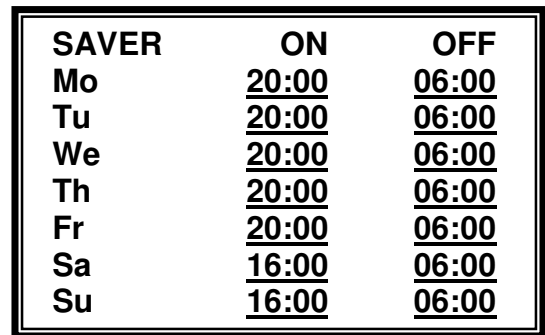

Submenu X.8.3.1

## CHAPTER V - COMMUNICATIONS

The *CHEMROL*® PC controller features remote operation with PC-compatible computer using the CHEMCOM™ software program for *Windows*.

The CHEMCOM™ program is a proprietary program that allows true duplex operation. This means that any action on the remote computer is immediately implemented on the screen of the controller, and vice versa.

### CHEMCOM™ Program

The menu screen on Figure 36 shows that the CHEMCOM™ program is fully menu-driven and easy to use, even by staff without computer experience.

Menu 1 INSTRUCTIONS shows basic operating information.

Menu 2 SYSTEM (Figure 37) is used to customize the communications options for the remote computer. If unsure about the communication port setting, try COM1. If you get an error message when trying remote communications, try COM2, etc.

Menu 3 FACILITIES (Figure 38) is used to enter the name and phone number of each facility. It is important to specify the model number of the controller, i.e. PC6000 or other.

The unit I.D. number is used for secondary units that are connected to a phone line through a primary unit.

Set the facility to “Active” for automatic scanning.

Upon entering the “NAME” of the facility, the program creates automatically, two storage files:

- a scan file called S-“NAME”. Text on line 9,
- a datalog file called L-“NAME”.txt on line 10.

These files can later be accessed through Menu 8 - DISPLAY DATA.

Menu 4 SCANNING SCHEDULE specifies the automatic scanning mode. It does not affect Remote Operation.

Menu 5 ACTIVATE SCANNING is used to initiate automatic scanning of remote facilities.

Menu 6 REMOTE CONTROL is used to access and operate the remote facilities.

Menu 7 SCAN FACILITIES allows direct scanning of multiple facilities.

Menu 8 DISPLAY DATA is for display of downloaded data either in graphical or text format.

Menu 9 FILE MANAGEMENT is used to manage downloaded data files including selective copying and erasing.

Menu 10 QUIT is used to exit the CHEMCOM™ program and return to *Windows*.

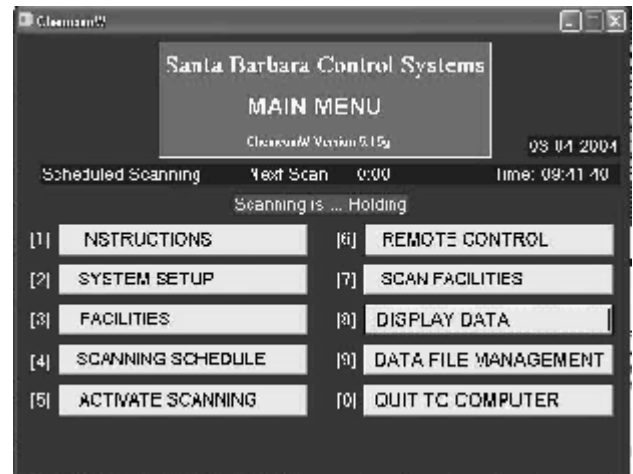

Figure 36 - CHEMCOM™ Program Menu



Figure 37 - CHEMCOM™ System Setup

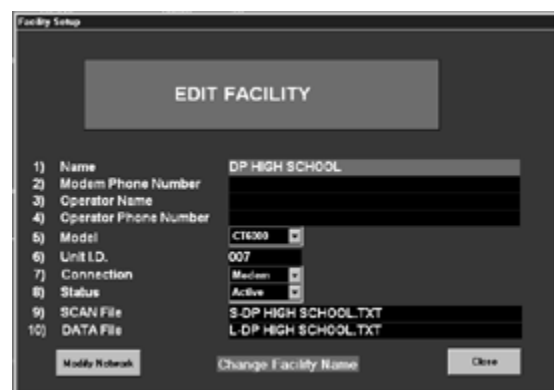

Figure 38 - CHEMCOM™ Facility Menu

## Modem Connections

On *CHEMTROL*® PC controllers with the REM option, the data/voice/communications modem is mounted on the Mother Board and is connected to a standard US-type RJ11 phone jack located on the lower right hand side of the Mother Board (see schematic in Figure 9).

Using the phone extension cable, connect the jack on the *CHEMTROL*® PC to a telephone line. The phone line does not have to be a dedicated line and it can be used for other communications when not in use for the controller. When called by a remote computer, the controller answers on the first ring, unless somebody else answers the call.

The modem on the remote computer is connected to one of the communication ports. The CHEMCOM™ program will need to know which one is used. It is usually COM1 or COM2, and more rarely COM3 or COM4.

## Computer Software Installation

The CHEMCOM™ computer software program used for remote operation is supplied on a CD-ROM. It is self installing under *Windows*.

To install the program on the remote computer, click on Run on the Desktop screen and select the drive where the CHEMCOM™ program disk is located. Then click on Setup.

To start the program, go to the Start/Program menu or click on the CHEMCOM icon.

## Remote Operation

To establish connection from a remote computer, select Menu 6 - REMOTE CONTROL on the CHEMCOM™ menu screen.

The Facility Selection menu (Figure 39) appears. Scroll down to the name of the facility and click on "Direct Dial" or "Manual Dial" (to enter the phone number manually).

The computer dials the telephone number of the facility, to connect to the controller. There is no dialing for RS-485 and Ethernet connections since these are direct connections.

## Secondary Units

If secondary units are connected to a phone line through a primary unit, they can be selected by clicking the mouse on the pulldown menu that appears directly above the numeric key on the remote computer screen (Figure 40).

## Duplex Operation

Upon connection, the program displays an image of the actual controller screen in **true duplex representation**, as shown on Figure 41.

True duplex operation means that all the moves and operations on the remote computer screen are simultaneously executed in real time on the controller screen, and vice versa. This allows 100% remote control of all operating functions.

Navigation through the menus and submenus on the remote computer is done exactly as with the actual controller, by using the computer arrow keys or, under *Windows*, by clicking on the arrows shown on the computer screen with the mouse.

With CHEMCOM™, the remote operator can verify all the operating conditions at a glance.



Figure 39 - CHEMCOM™ Facility Selection



Figure 40 - CHEMCOM™ Secondary Units



Figure 41 - CHEMCOM™ Remote Operation Screen

- Line 1 shows an **ORP reading of 710 mV** with the sanitizer pump feeding (>) in the Automatic mode (A).
- Line 2 shows a **Sanitizer level of 3.3 ppm** with the feed mode OFF (X).
- Line 3 shows a **pH reading of 7.7** with the Acid pump feeding (>) in the Automatic mode (A).
- Line 4 shows the **Total Dissolved Solids** readings at 781 ppm with the automatic bleed control off (X). Will display **Conductivity** if so configured.
- Line 5 shows a **Temperature reading of 82 F** with the heater control on Automatic (A).

- Line 6 shows the **Pump** running on Manual (M) with a flow rate of 240 gpm and a Bypass flow of 1 gpm.
- Line 7 shows that the **Filter Backwash** is in the Automatic mode (A) with influent and effluent pressures of 25 and 24 psi respectively.
- Line 8 shows the **Date and Time** and the saturation condition as OK. This last line also gives access to the Configuration Menu.

**Data Collection**

Test data for operating parameters can be collected in two different ways:

1. By data logging in the controller internal memory (available on all CHEMTROL® PC controllers),
2. By scanning with a remote computer using the CHEMCOM™ program.

**Automatic Scanning**

Automatic scanning is used to scan all facilities defined as “Active” in Menu 3 - FACILITIES according to the schedule defined in Menu 4 – SCANNING SCHEDULE on the CHEMCOM™ Main Menu.

To start automatic scanning, select Menu 5 - ACTIVATE SCANNING on the CHEMCOM™ Main Menu.

The menu for Automatic Scanning (Figure 42) offers two options:

- “Scan data” to activate automatic scanning. Upon activation, the scanning line below the header on the Main Menu changes from “Holding” to “Active”.
- “Datalog” to retrieve previously collected data with selection of start and end dates.

**Direct Scanning**

Menu 7 – SCAN FACILITIES allows direct scanning and retrieving of data log for one or all the active facilities.

To start manual scanning, select Scan Facilities Menu 7 – SCAN FACILITIES on the CHEMCOM™ Main Menu. Then the display will appear as shown in Figure 43.

When the remote controller is contacted, the test data is displayed on the computer screen, as shown in Figure 44 and stored on disk file for later retrieval.

For unattended monitoring, a dedicated computer is recommended. However, the computer can also be used for other tasks under *Windows* while the CHEMCOM™ program runs in the background.

To see all recent scanned data, click on “Recent scans”. It allows selection of the facilities and directories for the data files. As shown in Figure 45, the operator can monitor several remote facilities on a computer screen. In automatic mode, it scans all the facilities that have been set up as “Active” in Menu 3 - FACILITY Menu. Alarm conditions are shown in red.



Figure 42 - CHEMCOM™ Automatic Scanning

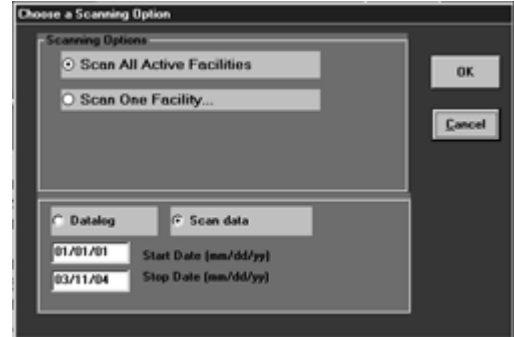

Figure 43 - CHEMCOM™ Scan Facilities

Date	Time	ORP	San	pH	Cond	Tmp	Flow	Filter
03/10/04	09:59	710	3.3	7.7	781	79	240	2.5
03/10/04	09:30	710	3.3	7.7	781	79	240	2.5
03/10/04	09:00	710	3.3	7.7	781	79	240	2.5
03/10/04	08:30	710	3.3	7.6	781	79	240	2.5
03/10/04	08:00	710	3.3	7.5	781	79	240	2.5
03/10/04	07:30	710	3.3	7.5	791	79	240	2.5

Figure 44 - CHEMCOM™ Manual Scanning

mm	yy	dd	hh	mm	ss	Cond	mp	Flow	Filter
10	02	05	00	22	34	77	1019	81	280
10	02	05	00	22	32	76	1003	80	282
10	02	05	00	21	17	74	1000	80	281
08	02	01	55	22	32	74	1803	78	280
08	02	01	53	22	32	74	1802	78	282
08	02	01	50	22	31	74	1800	78	281
08	02	01	45	22	32	74	1803	78	280
08	02	01	43	22	32	74	1802	78	282
08	02	01	40	22	31	74	1800	78	281
10	02	05	02	22	34	77	2590	81	280
10	02	05	02	22	32	77	2100	81	282
10	02	05	02	22	31	77	2110	81	281

Figure 45 - CHEMCOM™ Recent Scans

**Data Log Download**

Data logged in the controller can be downloaded by selecting Data log option as shown in Figure 43. This data can be displayed in the Recent Scans display as shown above.

NOTE: The data log can also be accessed outside of the CHEMCOM™ program by direct on-screen viewing or by downloading to an on-site computer.

See Submenu 8.2.4 (page 29) for Operations/Print Reports, as explained in the OPERATIONS Chapter, page 29.

**Data Display**

All the data retrieved from the remote controllers can be viewed and displayed either graphically or as text files using Menu 8 - DISPLAY DATA on the CHEMCOM™ Main Menu.

The Data Display menu is shown in Figure 46.

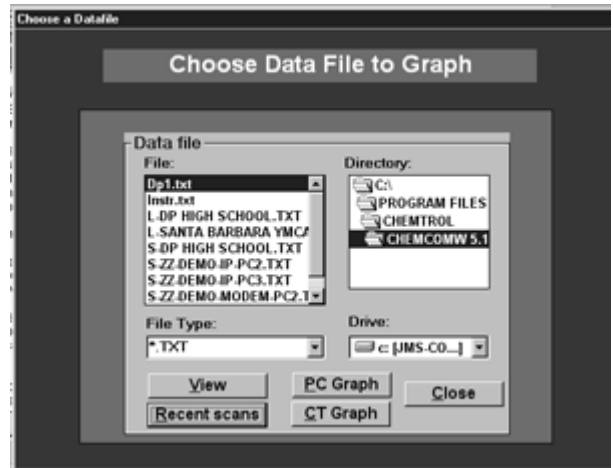

Figure 46 - CHEMCOM™ Data Display

**Text Data Display**

The data is stored as a text file in the computer. It can easily be displayed as text data using Windows Notepad or any conventional word processor.

It can also be displayed directly through the CHEMCOM™ program, as shown in Figure 47, using Menu 8 - DISPLAY DATA and VIEW.

The text data can also be easily copied and incorporated into other documents, such as reports to management or to the health department.

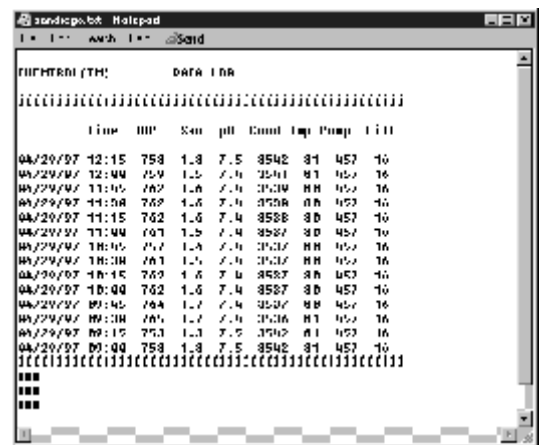

Figure 47 - CHEMCOM™ Text Data Display

**Graphic Data Display**

The data log can be displayed graphically with the CHEMCOM™ software program, using Menu 8 for DISPLAY DATA and GRAPH.

As shown on Figure 48, the graphics program displays two parameters simultaneously, such as ORP as a main variable and pH as an overlay, as shown on the right.

By clicking on the ZOOM ENABLE icon, windows can be drawn around parts of the graphs to display enlarged and more detailed views for selected dates or times. The left and right arrows allow scanning of the graph in either direction. To return to the full graph, click on ZOOM RESET.

The tool bar can be turned on to allow changes in scales, type of display and colors.

Using the ALT/Print Screen Windows command, the graphic data display can also be copied as an image to other documents or reports.

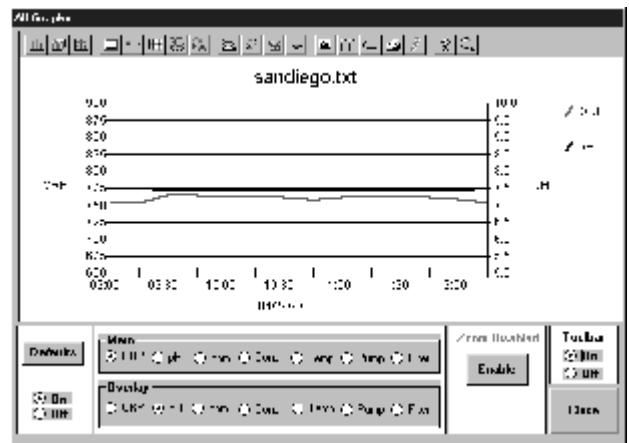

Figure 48 - CHEMCOM™ Graphic Data Display

## CHAPTER VI - MAINTENANCE

### CONTROLLER MAINTENANCE

#### Regular Maintenance

The *CHEMTROL®* PC controller requires little maintenance besides cleaning of the sensors and replacement of the battery, if needed, after a long shutdown.

How often the sensors require cleaning depends on the quality and flow of water. Use the Acid Test below to check the ORP and pH sensors. For commercial and public pools or spas, it is recommended to schedule preventive cleaning programs on a weekly or monthly basis.

#### The Acid Test

The Acid Test can be used to check the ORP and pH sensors.

Carefully add a small amount (½ cup or less for a public pool, a small capful for a spa) of hydrochloric (muriatic) acid HCl in the intake side of the recirculation line, upstream of the sensors, and observe the ORP and pH readings on the Main Display. After a few minutes, the pH reading should go down and the ORP reading up. After several minutes, both readings should return to their original values.

#### Sensor Cleaning

##### *PPM Sensor:*

DO NOT CLEAN the PPM sensor. Cleaning the membrane. May cause irreparable damage.

##### *ORP and pH Sensors:*

The sensors stop reading when they become coated with oil, calcium or dirt. To clean the ORP or pH sensors, carefully remove it from the compression fitting and clean the tip in a liquid soap solution (such as Joy, Palmolive, etc.). If it still does not work, dip it again for 5 to 10 seconds in muriatic acid (hydrochloric acid HCl). Rinse in clean water and reinsert it in the fitting.

##### *Conductivity Sensor*

The electrodes of the TDS/Conductivity Sensor can be cleaned with a mild abrasive (brush or sandpaper) to remove non-conducting deposits.

#### PPM Sensor Storage

Store the PPM sensor dry and protected.

#### ORP and pH Sensor Storage

- store at room temperature,
- keep the protective cap on the sensor filled with water to keep the tip moist. Check periodically that there is always some water inside the cap,
- store the sensors with the tips down to prevent the air bubble from migrating toward the junction,
- soak the sensor in a salt solution if stored over 3 months.

#### Sensor Winterizing

During cold weather, all sensors must be protected from freezing.

#### Battery Replacement

The memory battery is located in the upper left corner of the Mother Board. It keeps the settings for configuration, operation and calibration in memory - if the power supply is shut down. A low battery condition does not affect the operation of the controller as long as the main power is on.

To check the voltage of the battery, go to Configuration/Operations/Battery to display Submenu 8.2.6 (page 28).

If the battery shows a voltage below 2.5 V, it should be replaced with a 3V lithium battery, Panasonic CR 2330 or equivalent.

To replace the battery, turn off the power to the controller, slide out the old battery and insert the new one, making sure to set it in with the positive (+) side up.

After full power shutdown, the controller reverts to the original factory default settings. You must re-enter your own settings if they are different.

#### Software Upgrade

The software program in the *CHEMTROL®* PC controller can be upgraded by replacing the program and display chips that are located on the Mother Board. To avoid damaging the chips, follow the procedure below carefully.

1. Disconnect all power to the unit and remove the jumper J1 next to the battery on the motherboard.
2. Locate the Display Chip U2 and the Program Chip U3 in the upper section of the board.
3. Insert a flat screwdriver under the old chip and pry it gently away from its socket. Store it as a backup.
4. Handle the new chip carefully and avoid electrostatic discharge. Identify the chip orientation with the small half-moon indent upward. CAREFUL: wrong installation can damage the program.
5. Make sure all the pins are straight. Insert the new chip in the socket by aligning all the pins on one side first, then on the other side, applying lateral pressure to facilitate insertion.
8. Replace the jumper in J1 and restore power to the controller. You should see the *CHEMTROL®* logo displayed on the screen twice. When the display screen shows asterisks (\*\*\*) for date and time, you can be assured that the old program has been erased in its entirety.
7. Reprogram the controller to the desired parameters.

## CHEMICAL MAINTENANCE

### Overview

**For best results, it is strongly recommended to have the same operator in charge of water maintenance and testing, as different people read test kits differently.**

In addition, it is recommended to check the calibration of the controller at the same time of the day, preferably in the morning after a couple of hours of operation, but before full sun. This is especially important for pools stabilized with cyanuric acid as the effects of sunlight on chlorine activity are not detected by the test kits and may lead to false and unnecessary readjustments.

Finally, the pool operator should become familiar with ORP technology (see below) and learn to trust the information it provides rather than less reliable test kits.

### pH Control

The importance of proper pH control cannot be over emphasized, as it affects every aspect of water chemistry.

For pools and spas, the recommended pH setpoint is between 7.4 and 7.8. Below 7.4, the water becomes increasingly corrosive and causes stains, etching of plaster and eye irritation. Above 7.5, the efficiency of the sanitizer decreases rapidly and the water becomes too alkaline - which causes cloudiness, stains and scaling.

pH control is also affected by Total Alkalinity (TA). If it is too high (above 150 ppm), pH response is slow and requires more acid or base feed. If it is too low (under 100 ppm), pH control becomes very sensitive.

Because of the Time Lag for mixing of the chemicals in the water, there is always a fluctuation (0.1 to 0.2 pH units) above or below the setpoint, depending on the chemical feed rate.

If the pH tends to overshoot the setpoint, the Control Mode should be set to Proportional. Alternatively, the feed rate of the acid or soda feed pump can be reduced or a more dilute solution can be used (especially in a small body of water, like a spa). **DO NOT CHANGE THE SETPOINT.**

In an ACID FEED system, if the pH display consistently reads too high (not enough acid), the feed rate of the acid feed pump should be increased, or a stronger solution should be used. **DO NOT CHANGE THE SETPOINT.**

In a SODA FEED system, if the pH display consistently reads too low (not enough soda), the feed rate of the soda feed pump should be increased, or a stronger solution should be used. **DO NOT CHANGE THE SETPOINT.**

### ORP and Sanitizer Control

The recommended control level is 1.5 to 2.0 ppm of chlorine or 3.0 to 4.0 ppm of bromine at a pH of 7.5. To be sure of proper sanitation, the ORP should always be above 650 mV.

Even if using additional purification systems, such as ozone, UV systems or metal ion systems, **THE ORP READING MUST ALWAYS BE MAINTAINED ABOVE 650 mV.**

Because of the Time Lag between injection of chemicals, mixing in pool water, and return to the sensors, it is normal to see a variation of a few tenths of a PPM around the setpoint, depending on the feed rate of the chlorinator or brominator.

If the display shows too much overshoot, the Control Mode should be set to Proportional to reduce the feed rate. **DO NOT CHANGE THE SETPOINT.**

If the display consistently reads below the set point, reduce the width of the Progressive Zone or set the control mode to ON/OFF to increase the feed rate. **DO NOT CHANGE THE SETPOINT.**

The sensor reads ORP (Oxidation-Reduction Potential) which is closely related to the FAST ACTING FREE CHLORINE (HOCl), the most effective sanitizer. The DPD and FACTS test kits - and most other controllers - however read only the combination of FAST ACTING and SLOW ACTING FREE CHLORINE (HOCl and OCl<sup>-</sup>). This is not very meaningful because the slow acting form of chlorine is about 80 to 100 times slower than HOCl in killing bacteria.

With proper automatic pH control, the reading on the sanitizer display is very close to test kit readings. If the pH varies too much however, the *CHEMTROL*® controller will show the variations in HOCl - which are not shown by normal test kits. It is normal therefore to see small differences in readings between display and test kit if the pH varies.

If the ORP reading is maintained above the recommended minimum of 650 to 750 mV, the water should be free of germs and bacteria. Below 650 mV, germs and bacteria will develop rapidly.

ORP readings are closely tied to the concentration of Fast Acting Free Chlorine (HOCl), which is affected by pH and by the cyanuric acid level. If the pH and/or cyanuric acid level is too high, the ORP will be reduced even with high levels of chlorine.

With stabilized forms of chlorine (dichlor powder or trichlor tablets), it is important to test the cyanuric acid level in the water regularly and to dump or replace part of the water when it gets over 40 ppm - especially in spas.

If other purification systems are used (ozone, UV or metal ions systems), it is very important to maintain the proper ORP level at all times with chlorine or bromine residuals.

**NOTE:** Make sure to shut off the Bypass Line when adding sequestering agents as they will coat the platinum ring of the ORP sensor, resulting in false readings.

### Limit Timers (Overfeed Safety)

The Time Limit settings are designed to disable the feeders or other equipment in case of equipment failure or operator error such as:

- sensor or electronics failure,
- chemical feeder malfunction,
- improper valving of the recirculation system,
- manual override of automatic control by untrained or unauthorized personnel,
- depletion of chemical supply.

In normal operation, the chemical feeders are activated only for a short period - that is until the chemical level in the water has returned to the proper value. As soon as the chemical feeder is activated, the safety timer is turned on. Normally, feeding stops before the time limit is reached. The timer then resets to zero and waits for the next activation cycle.

However, if feeding continues over the preset time, the timer immediately stops the feeder and activates the overfeed alarm. After correcting the malfunction, reset the timer by momentarily setting the limit to 0 (see Chapter IV – Operation, page 24).

#### Timer Settings

To select the proper setting for each safety timer, the operator must take into consideration the size of the pool or spa and the feed rate of the chemical feeder. In case of doubt, make sure to consult a qualified *CHEMTROL®* representative or call the factory.

**NOTE 1:** The chemical feeders should be properly sized for the installation so that they do not have to feed continuously for more than 3 hours - even during peak usage periods.

**NOTE 2:** Once tripped, the safety timer has to be reset manually by the operator after investigation and correction of the malfunction.

## PERIODIC MAINTENANCE

### Water Testing

1. Test the water with a reliable and fresh test kit daily or as often as required by the local health department.
2. Adjust the reading of the display if needed.
3. If the PPM or pH readings are out-of-range:
  - a. Investigate and correct the cause of the problem immediately,
  - b. Readjust the water manually if needed and recalibrate the displays.
4. If the displays cannot be recalibrated after adjustment of the water chemistry, clean the sensor tips and recalibrate the displays.
5. If the displays still cannot be calibrated, see the TROUBLESHOOTING section.

### Shock Treatment

Even when maintaining the proper chlorine residual level with Chemical Automation, it is recommended to shock or superchlorinate the water periodically for the following reasons:

1. To prevent algae growth resulting from genetic adaptation of algae species to chlorine, i.e. becoming chlorine resistant.
2. In the event that the chlorine level is allowed to fall below the normal level, even for a short period (due to exhaustion of chemicals or technical malfunction), there can be formation of chloramines. These can be destroyed only by breakpoint superchlorination.

**WARNING:** If the chloramine concentration exceeds 0.2 PPM (mg/l), it is recommended to superchlorinate at 10 times the combined chlorine level.

The shock treatment program can be set up either through the ORP Menu, using the proper daily or weekly program schedule.

#### Precautions

- A. During superchlorination, the Limit Safety Timer is disabled.
- B. A SHOCK treatment warning is displayed on the Display Screen when activated.
- C. The out-of-range alarms stay on as long as the oxidizer or sanitizer levels are above the high limits.

**ALWAYS MAKE SURE TO TURN  
OFF THE CONTROLLER AND  
SHUT OFF THE BYPASS LINE  
WHEN DOING GENERAL POOL  
MAINTENANCE SUCH AS  
BACKWASHING OR REPAIRS.**



**PORTABLE TESTER**

The PORTA-PROBE™ II (**Error! Reference source not found.**) is a battery-operated digital portable tester/signal generator. It is designed to test the ORP, pH, conductivity and temperature sensors and to generate calibrated signals to test the controller. It is supplied with a 9V battery and a pair of shielded cables with BNC connectors.

The PORTA-PROBE™ II is not used to calibrate the ORP and pH sensors. This should be done with a chemical test kit, such as DPD for Free Chlorine and Phenol Red for pH.

**ORP SENSOR TESTING**

Set the Mode Switch to TESTING. Connect the ORP sensor to the ORP BNC connector on the tester. Turn the Selector Knob to ORP.

Place the sensor in balanced water (pH = 7.5 / PPM = 1.0 Cl). You should get an ORP reading within 650 to 750 mV.

Place the sensor in an acid solution. You should get a HIGH POSITIVE reading.

Place the sensor in a BLEACH (liquid chlorine) solution. You should get a LOW POSITIVE reading.

**pH SENSOR TESTING**

The PORTA-PROBE™ II shows actual pH sensor readings in millivolts, as shown on the Table on the right.

Set the Mode Switch to TESTING. Connect the pH sensor to the pH BNC connector on the tester. Turn the Selector Knob to pH.

Place the pH sensor in nearly neutral water (pH = 7.5). You should get a pH reading of about -30 mV.

Place the sensor in an acid solution. You should get a HIGH POSITIVE reading.

Place the sensor in a BLEACH solution. You should get a HIGH NEGATIVE reading.

The pH scale on the right shows the conversion of millivolt readings into pH units.

**ORP AND pH SIMULATION**

Set the Mode Switch to SIMULATOR.

Use the two coaxial cables to connect the BNC connectors on the tester to the respective BNC connectors on the controller.

Set the Selector Knob to either pH or ORP Simulator. The readings on the controller should match the readings of the tester display (unless offset by calibration of the pH probe).

**CONDUCTIVITY AND TEMPERATURE**

Connect the respective sensors and controller inputs to the connectors as indicated on the portable tester.



**Figure 49 - PORTA-PROBE™ Portable Tester**

The outputs of the ORP and pH simulators can be adjusted with the two small knobs located below the digital display. The ORP range is 0 to 1,000 mV.. The pH range is -180 to + 180 mV (10 to 4 on the pH scale). These outputs can be used to test for proper operation of the feed and alarm features of the controller.

NOTE 1: Due to signal stabilization, the readings on the controller may take up to 10 seconds to reach full value.

NOTE 2: ORP and pH signals can be generated simultaneously but only one signal is displayed.

<b>pH Scale</b>	
<i><b>mV</b></i>	<i><b>pH</b></i>
+420	0
+30	6.5
0	7.0
-6	7.1
-12	7.2
-18	7.3
-24	7.4
<b>-30</b>	<b>7.5</b>
-60	8.0
-90	8.5
-420	14.0

**Figure 50 - pH / mV Scale**

## **TROUBLESHOOTING**

<b>PROBLEMS</b>	<b>SOLUTIONS</b>
1. NO DISPLAY.	1a. Check power to system. 1b. Check On/Off Switch on right side of cabinet. 1b. Check Voltage Selector Switch in upper section of Power Board. Verify proper input voltage 110V or 230V. 1d. Check Fuse F2 on Power Board. If blown, replace with AGC1 fast blow fuse..
2. FAINT OR DARK DISPLAY	2a. Adjust contrast with Display Potentiometer R39 in center of Mother Board.
3. ERRATIC DISPLAY.	3a. Turn Power Switch off for 10 seconds and back on. 3b. Check power cable contacts. 3c. Check power strip connecting Mother Board and Power Board. 3d. Press program and memory chips on Mother Board to assure proper contacts.
4. NO CHEMICAL FEED NO HEATER ACTIVATION NO VALVE ACTIVATION	5a. Check flashing line in Main Display Screen. Highlight flashing line with UP or DOWN arrow. Press RIGHT arrow to enter submenu. Check flashing line in Submenu. 5b. If LOW or HIGH ALARM is flashing: Adjust water chemistry manually. Press RIGHT arrow to change alarm limits. Set Feed Lockout to Off (CAUTION !!!). 5c. If TIME LIMIT line is flashing: Increase chemical feeder rate. Increase Limit Timer setting. Reset Time Limit with AUTO setting. 5d. If BYPASS LINE is flashing on Main Display: Check water flow in bypass line. Check Safety Flow Switch in bypass line. Set Bypass Line to Off in Operations Submenu (CAUTION !!!). 5e. Set Feed Mode to MANUAL. Feed Indicator on Main Display should turn on. 5f. Check Relay Fuses on Power Board. ORP:       Fuses F4 and F5 Sanitizer: Fuses F10 and F11 pH:        Fuses F8 and F9 Heater:     Fuses F4 and F5 TDS:       Fuses F4 and F5 Filters:    Fuses F4 and F5
8. CANNOT CALIBRATE	NOTE: The ORP needs to be above 650 mV for Sanitizer calibration. 6a. Check water balance and adjust if needed. 6b. Clean faulty sensor as indicated. 6c. Check sensor connections. 6d. Check sensor with the PORTAPROBE™. 6e. Test electronics with the PORTAPROBE™.
7. CHLORINE OR pH OVERFEED	7a. Clean and test the faulty sensor. 7b. Check and adjust the calibration. 7c. Check and adjust the setpoint. 7d. Check the relay. 7e. Check the chemical feeder for leaks. 7f. Reduce feed rate or dilute the solution. 7g. Check the Superchlorination Program.
8. IMPROPER READINGS	8a. Clean the faulty sensor. 8b. Test the sensor with the PORTAPROBE™. 8c. Test the electronics with the PORTAPROBE™.

## ***PARTS, ACCESSORIES AND UPGRADES***

ORP	ORP SENSOR with 10-ft (3-m) shielded cable and BNC connector.
pH	pH SENSOR with 10-ft (3-m) shielded cable and BNC connector.
PPM002	0-2 PPM Chlorine Sensor with connector
PPM0100	10 PPM Chlorine Sensor with connector
PPM200	0-200 PPM Chlorine Sensor with connector
PPMSLT	0-10 PPM Membraneless Sensor for Electrolytic Salt Generator with connector
PPMCLL	Flow Cell for Chlorine sensor
PPMM01	Membrane for PPM002/PPM010 Sensors
PPMM02	Membrane for PPM200
TEMP	TEMPERATURE SENSOR, 1/4" MPT, 10-ft (3-m) cable
T/C	TEMPERATURE + CONDUCTIVITY SENSOR with 10-ft (3m) cable.
PWFS	ROTARY SAFETY FLOW SWITCH, 1/2" FPT, for bypass line.
MB6000	MOTHERBOARD, electronic PC board for PC7000 with microprocessor.
PB6000	POWER BOARD, electronic PC board for PC7000 with relays (specify).
MB3000	MOTHERBOARD, electronic PC board for PC5000 with microprocessor.
PB3000	POWER BOARD, electronic PC board for PC5000 with relays (specify).
4-20 mA Board	COMMUNICATIONS BOARD for 4-20 mA input or output (specify), 5 channels.
PPM Board	PC Board for Free Chlorine sensor.
PTR	THERMAL PRINTER, 40-column digital, 110V or 230V (specify)
BPL	BYPASS LINE ASSEMBLY, 1/2-in with Y-filter, flowmeter, safety flow switch, three (3) ball valves ...
SC	SENSOR CELL, 3 1/2-inch PVC cell, clear cover, two (2) 1/2-inch compression fittings,
FCA	FLOW CELL ASSEMBLY, PVC sensor cell, two (2) 1/2-inch compression fittings, sampling tap, two (2) 1/2-inch ball valves.
SCC	SENSOR CELL CABINET with Flow Cell Assembly.
205T	PVC SOLENOID VALVE for erosion feeder, 1" or 3/4" FPT (specify 24 V or 110VAC).
REM3:	UPGRADE for remote operation with true duplex CHEMCOM™ Remote Operation
RS485	UPGRADE for direct computer operation with communication converter and true duplex CHEMCOM™ Windows software

S45M3-V	MULTIPOINT SOLENOID VALVE, 3-way, 3-position motorized ball valve, PVC body, 2" FPT, 110 VAC, 150 psi for electrically operated filter backwash.
8221G2	SOLENOID VALVE, 3-way, brass body, 3/8" FPT, Normally Closed (NC), for hydraulically operated filter backwash.
8262G208	SOLENOID VALVE, brass body, 1/4" FPT, Normally Open (NO), for pneumatically operated filter backwash..
MULTI2	UPGRADE for Multiplex communications through host controller with RS485 and modem

## INDEX

115 V power input .....	8	Data logging .....	26
230 V power input .....	8	Data storage .....	29
4-20 mA control .....	48	Deadband .....	23, 47
4-20 mA Converter .....	12	Default setup .....	24
4-20 mA Output .....	30	Deshock .....	50
AC power input .....	8	Dichlor .....	20, 56
Access .....	24	Direct Scanning .....	53
Acid Feed .....	35, 56	Display screen .....	4
Acid Test .....	55	Download .....	29
Air break .....	20	DPD test kit .....	23, 56
Alarm .....	31, 36, 37, 39	Duplex Operation .....	52
Alarm Calling .....	30	Electrical .....	8
Algae .....	57	Electrical code .....	6, 8
Alkalinity .....	1	Electrical interference .....	16
Audio Alarm .....	27	Electrolytic chlorine generators .....	16
Automatic backwash .....	44	EPD Filters .....	21
Automatic control .....	48	Erosion feeder .....	20
Automatic Scanning .....	53	Etching of plaster .....	56
Backwash .....	21, 44	Eye irritation .....	56
Bacteria .....	1, 56	Feed pumps .....	20
Base Feed .....	35	Feeder Sizing .....	20
Battery .....	28, 55	Filter backwash .....	21, 44
Battery Check .....	22	Filtration .....	2
Battery Replacement .....	55	Fireman .....	43
Brightness .....	4, 10	Flow Rate .....	42, 45
Bromine .....	1, 20	Flow sensor .....	42
Bromine level .....	56	Free chlorine .....	56
Buzzer .....	10, 27	Free Chlorine .....	3
Cal hypo tablets .....	20	Fuses .....	10
Calcium hypochlorite .....	20	Gas chlorine .....	20
Calibration .....	22	Germs .....	56
Calibration of sensors .....	56	GFI .....	8
Calibration Submenu .....	49	Graphic Data Display .....	54
Caustic soda .....	20, 23	Grounding .....	8
CHEMCOM™ Program .....	51	Health Departments .....	1
Chemical feed pumps .....	20	Heater Control .....	2
Chemical saver .....	32, 50	Heater cooldown .....	43
Chemical tanks .....	20	Heater Delay .....	43
Chemistry adjustment .....	22	Heater Menu .....	39
CHEMTROL® Automation .....	1	High Alarm .....	32
Chips upgrade .....	55	HOCl .....	23
Chloramines .....	57	Hydraulic valve .....	21
Clarity .....	1	Hypochloric acid .....	23
Clock .....	26	Identification .....	30
Coliforms .....	1	Influent pressure .....	41
Combined chlorine .....	1	Initial setup .....	25
Communications Submenu .....	30	Installation of Sensors .....	13
Conductivity .....	2	Interlock .....	iii, 8
Conductivity Menu .....	37	Jumpers .....	8
Conductivity Sensor .....	17	Keyboard .....	4, 10
Configuration Menu .....	24	Langelier Saturation Index .....	27
Control Submenu .....	47	Language .....	25
Control type .....	47	Laptop .....	29
Controller Maintenance .....	55	Last Shock .....	32
Corrosion .....	27, 56	LCD display .....	4, 5, 10
Cumulative flow .....	42	Level alarm .....	32, 36, 38
Current leakage .....	16	Liquid chlorine .....	20
Cyanuric acid .....	1, 56	Location .....	6
Data Collection .....	53	Low level alarm .....	32, 36, 38
Data Display .....	54	Maintenance .....	55
Data download .....	29	Manual control .....	47
Data entry .....	4	Metal ion systems .....	56
Data Log Download .....	54	Metric units .....	25

MIAMI TANK filters.....	21	Pump Shutdown.....	46
Microprocessor.....	10	Readings.....	26
Model options.....	26	Redox.....	2
Modem.....	11	Reducer feed.....	31
Modem Certification.....	11	Relays.....	10
Modem Connections.....	52	Remote communications.....	4
Mother board.....	8	Remote operation.....	52
Motorized valves.....	21	Reset.....	28
Multiple Connections.....	11	Run time.....	32, 36, 38, 39
Multiple filters.....	21	Safety Notice.....	6
Multiplexing.....	11	Sanitizer calibration.....	23
Muriatic acid.....	20, 23	Sanitizer concentration.....	2
NaOCl.....	20	Sanitizer control.....	3, 56
NaOH.....	23	Sanitizer level.....	56
National Spa and Pool Institute.....	1	Sanitizer Lock.....	36
Night control.....	23	Sanitizer Menu.....	33
ON/OFF control.....	48	Saturation Index.....	27
on-screen viewing.....	28	Savings Submenu.....	50
Operations submenu.....	27	Scaling.....	27
Options.....	26	Secondary Units.....	52
ORP.....	2	Sensor Cleaning.....	55
ORP minimum.....	56	Sensor Storage.....	55
OTO test kit.....	23	Sensor Warranty.....	17
Out-of-range alarm.....	27	Sensor Winterizing.....	55
Overfeed.....	56	Serial Connections.....	11
Overfeed Safety.....	57	Serial printer.....	29
Overfeeding.....	20	Setpoint adjustment.....	56
Oxidation-Reduction Potential.....	2	Shock Submenu.....	50
Oxidizer calibration.....	23	Shock treatment.....	32, 50
Oxidizer feed.....	31	Shutoff Delay.....	40
Ozone.....	56	Signal generator.....	58
Panel interlock.....	8	Simulator.....	58
Passwords.....	25	Sizing.....	20
PC boards.....	8	Soda ash.....	20, 23
Periodic maintenance.....	57	Soda feed.....	23, 56
pH calibration.....	22	Sodium bisulfate.....	23
pH Menu.....	35	Sodium hypochlorite.....	20
pH scale.....	58	Software Installation.....	52
pH setpoint.....	23, 56	Software upgrade.....	55
pH variations.....	56	Solenoid valves.....	21
pH, high.....	23, 56	Stabilized chlorine.....	1, 20, 56
pH, low.....	22, 56	Stains.....	56
Phenol Red test kit.....	35	STARK filters.....	21
Phone jack.....	11	Storage and Winterizing.....	17
Phone numbers.....	30	Superchlorination.....	50, 57
Plaster.....	56	Superoxidation.....	32, 50
Plate count.....	1	Tanks Sizing.....	20
Pneumatic valves.....	21	TDS.....	1, 37
Portable tester.....	58, 59	TDS Menu.....	37
PORTA-PROBE™.....	58	Technical support.....	6
Potentiometric sensors.....	13	Temperature Menu.....	39
Power Board.....	8	Temperature Sensor.....	17
Power interlock.....	8	Test kit.....	35
Power transformer.....	8	Test Standards.....	1
PPM Board Initialization.....	22	Text Data Display.....	54
PPM Sensor Cleaning.....	55	Time Lag.....	56
PPM Sensor Storage.....	55	Time limit.....	32, 36, 38, 39, 47
Pressure.....	41	Timer control.....	48
Print reports.....	29	Total Alkalinity.....	1, 56
Priority valve.....	21	Total Dissolved Solids.....	1, 37
Priority Valve.....	46	Total feed Time.....	32, 36, 38
Probe Failure Analysis.....	3, 28	Transformer.....	8
Program upgrade.....	55	Trichlor.....	20, 56
Progressive zone.....	47, 48	Trichlorinator.....	20
Proportional control.....	47, 48	Troubleshooting.....	59
Proportional mode.....	56	Turnover rate.....	1
Public pools.....	1	Unit system.....	25
Pump interlock.....	8	Unpacking.....	6
Pump override.....	44, 46	Upgrade.....	55

US units.....	25	Water Level.....	43
UV systems .....	56	Water level control .....	19, 43
View Data Log.....	28	Water level sensor .....	19
Voltage selector.....	8	Water Maintenance .....	1
Warranty Card.....	6	Water recirculation .....	2
Water balance .....	2	Water sampling .....	22
Water flow .....	14	Winterizing .....	55

**NOTES**

## YOUR CHEMTROL™ PC6000 / PC3000 SETUP

**ORP** \_\_\_\_\_  
 Calibrate mV \_\_\_\_\_  
 Setpoint mV \_\_\_\_\_  
 Alarm Low mV \_\_\_\_\_  
 Alarm High mV \_\_\_\_\_  
 Time Limit min \_\_\_\_\_  
 Run Time \_\_\_\_\_  
 Last Shock 00/00/00

OFF Manual Automatic Timer ————  
 ON/OFF Proportional ————  
 Deadband \_\_\_\_\_  
 Deadband \_\_\_\_\_  
 Prog. Zone \_\_\_\_\_

Oxidizer Reducer Both \_\_\_\_\_  
 ALARMLOW Feed Lockout Buzzer \_\_\_\_\_  
 ALARMHIGH Feed Lockout Buzzer \_\_\_\_\_  
 TOTAL FEED TIME MAX TIME \_\_\_\_\_

**SHOCK** \_\_\_\_\_  
 Date \_\_\_\_\_  
 Cycle (days) \_\_\_\_\_  
 Time ON pH \_\_\_\_\_  
 Level pH \_\_\_\_\_  
 Time ON shock \_\_\_\_\_  
 Level ORP \_\_\_\_\_  
 Time OFF \_\_\_\_\_

**SANITIZER** \_\_\_\_\_  
 Calibrate ppm \_\_\_\_\_  
 Setpoint ppm \_\_\_\_\_  
 Alarm Low ppm \_\_\_\_\_  
 Alarm High ppm \_\_\_\_\_  
 Time Limit min \_\_\_\_\_  
 Run Time \_\_\_\_\_  
 Last Shock 00/00/00

OFF Manual Automatic Timer ————  
 ON/OFF Proportional ————  
 Deadband \_\_\_\_\_  
 Deadband \_\_\_\_\_  
 Prog. Zone \_\_\_\_\_

Oxidizer Reducer Both \_\_\_\_\_  
 ALARMLOW Feed Lockout Buzzer \_\_\_\_\_  
 ALARMHIGH Feed Lockout Buzzer \_\_\_\_\_  
 TOTAL FEED TIME MAX TIME \_\_\_\_\_

**SHOCK** \_\_\_\_\_  
 Date \_\_\_\_\_  
 Cycle (days) \_\_\_\_\_  
 Time ON pH \_\_\_\_\_  
 Level pH \_\_\_\_\_  
 Time ON shock \_\_\_\_\_  
 Level ORP \_\_\_\_\_  
 Time OFF \_\_\_\_\_

**pH** \_\_\_\_\_  
 Calibrate \_\_\_\_\_  
 Setpoint \_\_\_\_\_  
 Alarm Low \_\_\_\_\_  
 Alarm High \_\_\_\_\_  
 Time Limit min \_\_\_\_\_  
 Run Time \_\_\_\_\_  
 Probe Clean \_\_\_\_\_

OFF Manual Automatic Timer ————  
 ON/OFF Proportional ————  
 Deadband \_\_\_\_\_  
 Deadband \_\_\_\_\_  
 Prog. Zone \_\_\_\_\_

Acid Feed Base Feed Both \_\_\_\_\_  
 ALARMLOW Feed Lockout Buzzer \_\_\_\_\_  
 ALARMHIGH Feed Lockout Buzzer \_\_\_\_\_  
 TOTAL FEED TIME MAX TIME \_\_\_\_\_

**PROBECLEAN ON OFF**

Mo \_\_\_\_\_  
 Tu \_\_\_\_\_  
 We \_\_\_\_\_  
 Th \_\_\_\_\_  
 Fr \_\_\_\_\_  
 Sa \_\_\_\_\_  
 Su \_\_\_\_\_

**TDS** \_\_\_\_\_  
 Calibrate ppm \_\_\_\_\_  
 Setpoint ppm \_\_\_\_\_  
 Alarm Lo ppm \_\_\_\_\_  
 Alarm Hi ppm \_\_\_\_\_  
 Time Limit min \_\_\_\_\_  
 Run Time \_\_\_\_\_  
 Select Scale \_\_\_\_\_

OFF Manual Automatic Timer ————  
 ON/OFF Proportional ————  
 Deadband \_\_\_\_\_  
 Deadband \_\_\_\_\_  
 Prog. Zone \_\_\_\_\_

Decrease Increase \_\_\_\_\_  
 ALARMLOW Feed Lockout Buzzer \_\_\_\_\_  
 ALARMHIGH Feed Lockout Buzzer \_\_\_\_\_  
 TOTAL FEED TIME MAX TIME \_\_\_\_\_

**Cell Constant** \_\_\_\_\_  
**TDS Factor** \_\_\_\_\_

**HEATER** \_\_\_\_\_  
 Calibrate F \_\_\_\_\_  
 Setpoint F \_\_\_\_\_  
 Alarm Low F \_\_\_\_\_  
 Alarm High F \_\_\_\_\_  
 Time Limit min \_\_\_\_\_  
 Run Time \_\_\_\_\_  
 Energy Saver \_\_\_\_\_

OFF Manual Automatic Timer ————  
 ON/OFF Proportional ————  
 Deadband \_\_\_\_\_  
 Deadband \_\_\_\_\_  
 Prog. Zone \_\_\_\_\_

Heating Cooling \_\_\_\_\_  
 ALARMLOW Feed Lockout Buzzer \_\_\_\_\_  
 ALARMHIGH Feed Lockout Buzzer \_\_\_\_\_

**SAVER ON OFF**

Mo \_\_\_\_\_  
 Tu \_\_\_\_\_  
 We \_\_\_\_\_  
 Th \_\_\_\_\_  
 Fr \_\_\_\_\_  
 Sa \_\_\_\_\_  
 Su \_\_\_\_\_

**PUMP** \_\_\_\_\_  
 P influent psi \_\_\_\_\_  
 P effluent psi \_\_\_\_\_  
 Flow Rate gpm \_\_\_\_\_  
 Alarm lo gpm \_\_\_\_\_  
 Flow Total Mga \_\_\_\_\_  
 Heater Delay min \_\_\_\_\_  
 Water Level \_\_\_\_\_

**PUMP ON OFF**

Mo \_\_\_\_\_  
 Tu \_\_\_\_\_  
 We \_\_\_\_\_  
 Th \_\_\_\_\_  
 Fr \_\_\_\_\_  
 Sa \_\_\_\_\_  
 Su \_\_\_\_\_

**PRESSURE INFLUENT**

Low psi \_\_\_\_\_  
 High psi \_\_\_\_\_

ALARMLOW Pump Lockout Buzzer \_\_\_\_\_  
 ALARMHIGH Pump Lockout Buzzer \_\_\_\_\_

**FLOWMETER FACTOR**

Pulses/ga: \_\_\_\_\_

ALARMLOW Pump Lockout Buzzer \_\_\_\_\_

**WATER LEVEL** \_\_\_\_\_

Feed lock gpm \_\_\_\_\_  
 Time limit min \_\_\_\_\_  
 Run Time \_\_\_\_\_  
 Alarm High \_\_\_\_\_

**FILTER** \_\_\_\_\_  
 Backwash Date \_\_\_\_\_  
 Start Time \_\_\_\_\_  
 Filter Time (min) \_\_\_\_\_  
 Advance (min) \_\_\_\_\_  
 Number of Filters \_\_\_\_\_  
 Pump shutdown \_\_\_\_\_  
 Pump Override \_\_\_\_\_

Time Interval \_\_\_\_\_  
 P Differential \_\_\_\_\_  
 Time or Pressure \_\_\_\_\_  
 Time & Pressure \_\_\_\_\_  
 Flow rate \_\_\_\_\_  
 Volume of water \_\_\_\_\_  
 Volume or Pressure \_\_\_\_\_  
 Volume & Pressure \_\_\_\_\_

**BACKWASH ON OFF**

Mo \_\_\_\_\_  
 Tu \_\_\_\_\_  
 We \_\_\_\_\_  
 Th \_\_\_\_\_  
 Fr \_\_\_\_\_  
 Sa \_\_\_\_\_  
 Su \_\_\_\_\_

No of Filters \_\_\_\_\_  
 Priority Valve \_\_\_\_\_

PUMP Override \_\_\_\_\_  
 Stop Time between valves (sec) \_\_\_\_\_

**MODEL OPTIONS**

ORP \_\_\_\_\_  
 SANITIZER \_\_\_\_\_  
 pH \_\_\_\_\_  
 CONDUCTIVITY \_\_\_\_\_  
 HEATER \_\_\_\_\_  
 PUMP \_\_\_\_\_  
 FILTER \_\_\_\_\_

**CONFIGURATION**

Initial Setup \_\_\_\_\_  
 Operations \_\_\_\_\_  
 Communications \_\_\_\_\_

**OPERATIONS**

Audio Alarms \_\_\_\_\_  
 Bypass Line \_\_\_\_\_  
 Probe Monitor \_\_\_\_\_

**SATURATION**

Alkalinity \_\_\_\_\_  
 Hardness \_\_\_\_\_

**COMMUNICATIONS**

Phone \_\_\_\_\_  
 Unit ID \_\_\_\_\_  
 Alarm calling \_\_\_\_\_