



TOSHIBA
Leading Innovation >>>

32BL505B
DIGITAL Series

>SUPPORT

 PLEASE VISIT:
WWW.TOSHIBA.CO.UK/TV-DVD-SUPPORT

 OR CONTACT THE TOSHIBA CUSTOMER
HELPLINE ON **0844 856 0730**

"Register your TV online at:
www.toshiba.co.uk/registration"



OWNER'S MANUAL

TOSHIBA
Leading Innovation >>>

User Manual

DIGITAL Series

This standard user's manual is designed to show you how to connect and tune in your Toshiba TV and to operate the most commonly used functions.

If you want to view advanced functions for your TV you can do so by visiting

www.toshiba-om.net



“Register your TV online at: www.toshiba.co.uk/registration”

Toshiba estimates that the initiative of making the advanced functions available online rather than in this book will save over 25,000 trees per year (1.6 Million kg CO₂).

If you wish to view the advanced functions but do not have access to a computer or the internet then please contact your local owner's manual Helpline number. Contact details are shown at the back of this book.

Re-tuning: TOSHIBA Freeview Products

Toshiba Digital TV

This guide can be used to help you re-tune the following product with the remote control below.

Make sure your TV is on and press 80 for the BBC News channel



- 1) Press **MENU** and press **◀** or **▶** to select **Install and Retune** and press **OK**. Press **▲** or **▼** to select **Automatic channel scan (Retune)** to start the process.

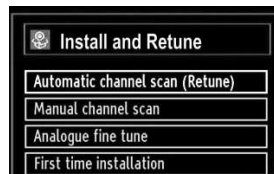
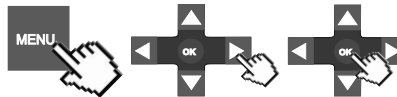

- 2) Select the desired search mode using **▶** and press **OK** button.



- 3) Whenever you select an automatic search type and press **OK** button, a confirmation screen will appear on the screen. To start installation process, select **Yes** by using **◀** or **▶** and **OK** button.

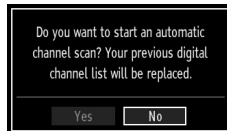

- 4) After auto channel scan type is set and selected and confirmed, installation process will start and progress bar will move along. The television will start to search for all available stations. You must allow the television to complete the search.

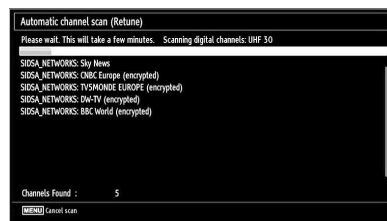

* This process may affect any saved information stored on your product. Please consult your instruction manual or contact the manufacturer using the details above.

TOSHIBA Customer Helpline: 0844 856 0730 **TOSHIBA Online Support:** www.toshiba.co.uk/tv-dvd-support

Manual Re-tuning

Your guide to

Manual re-tuning

If you are comfortable with technical information and your basic re-tune hasn't worked, you can use this manual re-tune guide.

If your Freeview TV or box picks up a different regional service to your preferred service (e.g. BBC England instead of BBC Scotland, or ITV Central instead of ITV Anglia), you can use this manual re-tune. If you are missing some services you may find they have moved to channel 800 or above, this guide will help you put them in your preferred position. If you find manual re-tuning too difficult, contact your local electrical retailer or installer. This is a guide only, Freeview models operate slightly differently. Some early models do not offer a manual re-tune facility – check your instruction book. Please note: Every time you re-tune, you will need to go through this process.

1) Go to the Postcode Checker at digitaluk.co.uk Enter your postcode on the right hand side of the web page. Remember to include your house number or name. If you do not have internet access, contact the Digital UK helpline on 08456 50 50 50* and ask for manual re-tune guide support.



2) Once you have entered your address details, the next page gives you an indication of which TV services you should receive, based on your most likely transmitter. You may be able to receive television services from more than one transmitter and you can check alternatives, where available. On the results page click on the pink button to see your full reception forecast and channel information for switchover.

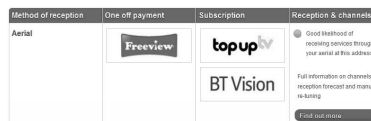

3) Click on the How do I re-tune? pink banner. Scroll down to the manual re-tune table where you will see the relevant "RF Channel" numbers for the digital services that can be received at your home.**

	Friday 19 Jun 2011	Saturday Aug 2011	7 Sep 2011 Switchover stage 1	21 Sep 2011 Switchover stage 2
	No re-tune required	No re-tune required	Re-tune required at switchover stage 1	Re-tune required at switchover stage 2
Group 1	ch 52	ch 52	ch 47	ch 47
Group 2	ch 60	ch 60	ch 65	ch 64
Group 3	ch 46	ch 46	ch 46	Not available
Group 4	ch 43	ch 43	ch 52	ch 51
Group 5	ch 50	ch 50	ch 50	ch 52

*Calls are free for BT customers within inclusive calling plans. Call charges from other providers may vary. The standard business hours for Digital UK's contact centre are 9am to 7pm Monday to Friday and 10am to 4pm on a Saturday. Opening hours will be extended during switchover in each area. Digital UK, PO Box 26833, Kirkcaldy, KY2 9AG. **Please note that the Freeview channel line-up is subject to change.



4) Write down the "RF Channel" numbers for your transmitter using the Group boxes here:

Group 1	<input type="text"/>	Group 4	<input type="text"/>
Group 2	<input type="text"/>	Group 5	<input type="text"/>
Group 3	<input type="text"/>	Group 6	<input type="text"/>

5) Press **MENU** and use ◀ or ▶ to select **Install and Retune**.

6) Select **Manual Channel Scan** from the Installation menu and press OK.



7) Select **Search Type** as **Digital** by using ◀ or ▶.

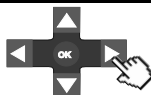
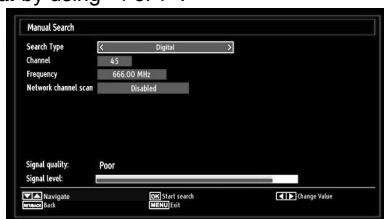

8) Select **Channel** and use ◀ or ▶ to change the channel number.

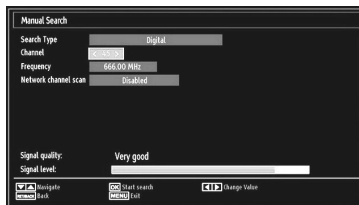

9) Press **OK** to start search.

10) Press **MENU** button. You should find that you now have your preferred service installed.



If you need any more help, contact your retailer, installer, manufacturer or the Digital UK helpline on 08456 50 50 50 *

digitaluk

Contents

Digital Switchover	2	Renaming a Channel	24
Re-tuning: TOSHIBA Freeview Products.....	3	Locking a Channel	24
Manual Re-tuning	4	Viewing Info Banner, Electronic Programme Guide	25
Safety Precautions	8	Viewing Info Banner.....	25
Air Circulation	8	Electronic Programme Guide.....	25
Heat Damage.....	8	Language Selection	26
Mains Supply	8	Language Settings.....	26
Warning	8	Preferred.....	26
Do	8	Current.....	26
Do not	8	Digital Settings - Parental Control, Menu Lock, Set PIN.....	27
Installation and Important Information	9	Viewing Parental Control Menu	27
EXCLUSION CLAUSE.....	9	Menu Lock	27
Important safety information	10	Child Lock	27
Removing the pedestal stand	12	Set PIN	27
The Remote Control	13	Configuring Picture Settings	28
Inserting Batteries and Effective Range of the Remote Control.....	13	Configuring Picture Settings	28
Connecting External Equipment	14	Picture Mode.....	28
Connecting an HDMI® or DVI Device to the HDMI Input.....	15	Contrast	28
To Connect an HDMI Device	15	Brightness.....	28
To Connect a DVI Device.....	15	Sharpness.....	28
Connecting a Computer.....	16	Colour	28
To Connect a Computer.....	16	Power Save Mode	28
Connecting to a DVD Player via YPbPr.....	16	Backlight (optional)	28
Connecting a USB Memory	17	Noise Reduction	28
To Connect a USB Disk	17	Advanced Settings.....	29
USB Memory Connection	17	Resetting.....	29
Power Save Mode	18	Changing Picture Format.....	30
Environmental Information	18	Configuring PC Picture Settings.....	31
Controlling the TV	19	PC Picture Settings (*).....	31
Switching on	19	PC Position	31
Using the Remote Control	19	Autoposition	31
Using the Controls and Connections on the TV...	19	H Position	31
Initial Installation	20	V Position.....	31
Auto Tuning.....	21	Dot Clock	31
Auto Tuning	21	Phase.....	31
Manual Tuning, Analogue Fine Tuning	22	Configuring Sound Settings.....	32
Digital Manual Search.....	22	Configuring Sound Settings	32
Analogue Manual Search	22	Operating Sound Settings Menu Items.....	32
Analogue Fine Tune.....	22	Volume.....	32
General Operation	23	Equalizer (Only for speaker).....	32
Stereo and Bilingual Transmissions.....	23	Balance (Only for speaker).....	32
Displaying Subtitles	23	Headphone	32
Viewing Main Menu	23	Sound Mode	32
Controlling Volume and Muting Sound	23	AVL	32
Selecting Programme Positions.....	23	Dynamic Bass.....	32
Standby Notifications	23	Digital Out.....	32
Channel List, Sorting Programmes, Programme Locking	24	Settings Menu Operation, Conditional Access	33
Viewing Channel List	24	Configuring Your TV's Settings	33
Moving a Channel.....	24	Viewing Settings Menu	33
Deleting a Channel.....	24	Conditional Access	33
		Language.....	33
		Parental	33
		Timers.....	33

Date/Time Settings	33
Sources.....	33
Other Settings.....	33
Using a Conditional Access Module	33
Setting Timers, Setting Date/Time.....	34
Timers.....	34
Setting Sleep Timer	34
Setting Programme Timers	34
Configuring Date/Time Settings.....	34
Source Settings, Other Controls.....	35
Configuring Source Settings.....	35
Input Selection.....	35
Configuring Other Settings - General	35
Operation	35
Menu Timeout.....	35
Scan Encrypted Channels	35
Other Controls	36
Application Version	36
Blue Background	36
Software Upgrade.....	36
Hard of Hearing	36
Audio Description.....	36
Auto TV Off	36
Standby Search (*)	36
Full Mode (optional).....	36
HDMI True Black (optional).....	36
Manual Start	37
Auto Start.....	37
Playing MP3 Files	37
USB Media Browser	37
Viewing JPG Files.....	38
Slideshow Feature	38
Video Playback	38
Media Browser Settings.....	39
To Close the Media Player.....	39
Analogue Text Services	40
Using Text Button -TEXT	40
Accessing Sub-Pages	40
Revealing Concealed Text.....	40
Holding a Page	40
To display an initial page.....	40
Analogue Text Services	40
Appendix A: PC Input Typical Display Modes.....	41
Appendix B: AV and HDMI Signal Compatibility (Input Signal Types).....	42
Appendix C: Supported File Formats for USB Mode.....	43
Appendix D: PIN Information	43
Specifications and Accessories	44
License Information	45
Questions and Answers.....	46
Toshiba One (1) Year Limited Warranty For TV's (the "Products").....	48



Safety Precautions

This equipment has been designed and manufactured to meet international safety standards but, like any electrical equipment, care must be taken to obtain the best results and for safety to be assured. Please read the points below for your own safety. They are of a general nature, intended to help with all electronic consumer products and some points may not apply to the goods you have just purchased.

Air Circulation

Leave more than 10cm clearance around the television to allow adequate ventilation. This will prevent overheating and possible damage to the television. Dusty places should also be avoided.

Heat Damage

Damage may occur if the television is left in direct sunlight or near a heater. Avoid places subject to extremely high temperatures or humidity, or locations where the temperature is likely to fall below 5°C (41°F).

Mains Supply

The set should be operated only from a 220-240 V AC 50 Hz outlet. DO ensure that the television is not standing on the mains lead. DO NOT cut off the mains plug from this equipment, this incorporates a special Radio Interference Filter, the removal of which will impair its performance. In the UK, the fuse fitted in this plug is approved by ASTA or BSI to BS1362. It should only be replaced by a correctly rated and approved type and the fuse cover must be refitted. IF IN DOUBT PLEASE CONSULT A COMPETENT ELECTRICIAN.

Warning

To prevent the spread of fire, keep candles or other open flames away from this product at all times.



Do

DO read the operating instructions before you attempt to use the equipment.

DO ensure that all electrical connections (including the mains plug, extension leads and interconnections between pieces of equipment) are properly made and in accordance with the manufacturers' instructions. Switch off and withdraw the mains plug before making or changing connections.

DO consult your dealer if you are ever in doubt about the installation, operation or safety of your equipment.

DO be careful with glass panels or doors on equipment.

Do not

DON'T remove any fixed cover as this may expose dangerous voltages.

DON'T obstruct the ventilation openings of the equipment with items such as newspapers, tablecloths, curtains, etc. Overheating will cause damage and shorten the life of the equipment.

DON'T allow electrical equipment to be exposed to dripping or splashing or objects filled with liquids, such as vases, to be placed on the equipment.

DON'T place hot objects or naked flame sources, such as lighted candles or nightlights on, or close to equipment. High temperatures can melt plastic and lead to fires.

DON'T use makeshift stands and NEVER fix legs with wood screws. To ensure complete safety, always fit the manufacturers' approved stand, bracket or legs with the fixings provided according to the instructions.

DON'T leave equipment switched on when it is unattended, unless it is specifically stated that it is designed for unattended operation or has a standby mode. Switch off by withdrawing the plug, make sure your family know how to do this. Special arrangements may need to be made for people with disabilities.

DON'T continue to operate the equipment if you are in any doubt about it working normally, or it is damaged in any way - switch off, withdraw the mains plug and consult your dealer.

WARNING - excessive sound pressure from earphones or headphones can cause hearing loss.

ABOVE ALL - NEVER let anyone, especially children, push or hit the screen, push anything into holes, slots or any other openings in the case.

NEVER guess or take chances with electrical equipment of any kind - it is better to be safe than sorry.

THE MAINS PLUG IS USED AS A DISCONNECTING DEVICE AND THEREFORE SHOULD BE READILY OPERABLE.

Note : Interactive video games that involve shooting a "gun" type of joystick at an on-screen target may not work with this TV.

Installation and Important Information

Where to install

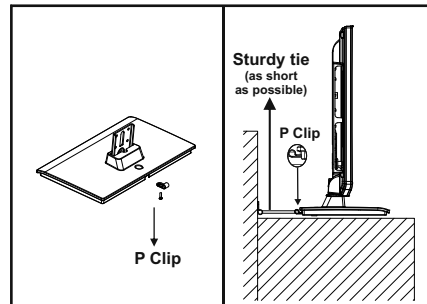

** P Clip position on TV is dependent on model.*

** Button and stand style is dependent on model.*

Locate the television away from direct sunlight and strong lights. Soft, indirect lighting is recommended for comfortable viewing. Use curtains or blinds to prevent direct sunlight falling on the screen.

Place the TV on a stable, level surface that can support the weight of the TV. In order to maintain stability and prevent it falling over, secure the TV to a wall using a sturdy tie to the clip on TV.

The LCD display panels are manufactured using an extremely high level of precision technology; however, sometimes some parts of the screen may be missing picture elements or have luminous spots. This is not a sign of a malfunction.

Make sure the television is located in a position where it cannot be pushed or hit by objects, as pressure will break

or damage the screen. Also, please be certain that small items cannot be inserted into slots or openings in the case.



Avoid using chemicals (such as air refreshers, cleaning agents, etc.) on or near the TV pedestal. Studies indicate that plastics may weaken and crack over time from the combination effects of chemical agents and mechanical stress (such as weight of TV). Failure to follow these instructions could result in serious injury and/or permanent damage to TV and TV pedestal.

Cleaning the screen and cabinet...

Turn off the power, and clean the screen and cabinet with a soft, dry cloth. We recommend that you do not use any proprietary polishes or solvents on the screen or cabinet as this may cause damage.

Please take note

The digital reception function of this television is only effective in the countries listed in the "Country" section during the first time installation menu. Depending on country/area, some of this television's functions may not be available. Reception of future additional or modified services can not be guaranteed with this television.

If stationary images generated by 4:3 broadcasts, text services, channel identification logos, computer displays, video games, on screen menus, etc. are left on the television screen for any length of time, they could become conspicuous. It is always advisable to reduce both the brightness and contrast settings.

Very long, continuous use of the 4:3 picture on a 16:9 screen may result in some retention of the image at the 4:3 outlines. This is not a defect of the LCD TV and is not covered under the manufacturer's warranty. Regular use of other size modes will prevent permanent retention.

EXCLUSION CLAUSE

Toshiba shall under no circumstances be liable for loss and/or damage to the product caused by:

- i) fire;
- ii) earthquake;
- iii) accidental damage;
- iv) intentional misuse of the product;
- v) use of the product in improper conditions;
- vi) loss and/or damage caused to the product whilst in the possession of a third party;
- vii) any damage or loss caused as a result of the owner's failure and/or neglect to follow the instructions set out in the owner's manual;
- viii) any loss or damage caused directly as a result of misuse or malfunction of the product when used simultaneously with associated equipment;

Furthermore, under no circumstances shall Toshiba be liable for any consequential loss and/or damage including but not limited to the following, loss of profit, interruption of business, the loss of recorded data whether caused during normal operation or misuse of the product.

Note: A Toshiba wall bracket or stand, where available, must be used.



Important safety information

USE OF CONTROLS OR ADJUSTMENTS OR PERFORMANCE OF PROCEDURES OTHER THAN THOSE SPECIFIED HEREIN MAY RESULT IN HAZARDOUS RADIATION EXPOSURE.

DO NOT OPEN COVERS AND DO NOT REPAIR YOURSELF. REFER SERVICING TO QUALIFIED PERSONNEL.

Headphone Warning

Loud music can damage your hearing irreversibly. Do not set the volume to a high level when listening through headphones, particularly for extended listening periods.

Information for the DVB-T function

- Any function relative to the digital television (with the DVB logo) is available only within the country or area where such signals are transmitted. Verify with the salesperson if it is possible to receive a DVB-T signal in the zone where you live.
- Even if the television conforms to the DVB-T specifications, the compatibility to future digital DVB-T transmissions is not guaranteed.
- Some digital television functions may not be available in some countries.
- The DVB-T system present in this device is FTA (Free to air).
- DVB is a registered trademark of the DVB Project. This logo indicates that the product is compliant with European Digital Broadcasting.

Possible Adverse Effects on LCD Screen

If a fixed (non-moving) pattern remains on the LCD screen for long periods of time, the image can become permanently retained on the LCD TV panel and cause subtle but permanent ghost images. This type of damage is NOT COVERED BY YOUR WARRANTY. Never leave your TV on for long periods of time while it is displaying the following formats or images:

- Fixed Images, such as stock tickers, video game patterns, TV station logos, and websites.
- Special Formats that do not use the entire screen. For example, viewing letterbox style (16:9) media on a normal (4:3) display (Black bars at top and bottom of screen); or viewing normal style (4:3) media on a widescreen (16:9) display (Black bars on left and right sides of screen).

IMPORTANT INFORMATION

TV Installation

If a television is not positioned in a sufficiently stable location, it can be potentially hazardous due to falling. Many injuries, particularly to children, can be avoided by taking simple precautions such as:

- Using stands recommended by the manufacturer of the television.
- Only using furniture that can safely support the television.
- Ensuring the television is not overhanging the edge of the supporting furniture.
- Not placing the television on tall furniture (for example, cupboards or bookcases) without anchoring both the furniture and the television to a suitable support.
- Not standing the televisions on cloth or other materials placed between the television and supporting furniture.
- Educating children about the dangers of climbing on furniture to reach the television or its controls.

Place the TV on a stable, level surface that can support the weight of the TV. In order to maintain stability and prevent it from falling over, secure the TV to a wall using a sturdy tie to the clip on the back of the table top stand.

This unit has been produced according to all current safety regulations. The following safety tips should safeguard users against careless use and the dangers related to such use.

- Although this unit has been carefully manufactured and rigorously checked prior to leaving the factory as with all electrical appliances, it is possible for problems to develop. If you notice smoke, an excessive build-up of heat or any other unexpected phenomena, you should disconnect the plug from the mains power socket immediately.
- Ensure that the unit is sufficiently ventilated! Never place it next to or underneath curtains!



Important safety information (continued)

- This set should only be connected to an 220-240V AC 50Hz mains power supply. Do not attempt to connect it to any other type of supply.
 - The socket outlet must be installed near the equipment and is easily accessible.
 - Do not open this unit. An attempt to repair the unit by a non-expert could be dangerous and potentially cause a fire hazard. All repairs must be carried out by qualified service personnel only.
 - Keep away from rodents. Rodents (and also cockatiels) enjoy biting electric flexes. They can cause a short circuit (fire hazard!) and receive a fatal electric shock.
 - Always hold the plug when disconnecting the unit from the socket outlet. Do not pull on flex. The flex can become overloaded and cause a short circuit.
 - Use a soft, dry cloth to clean the unit.
 - Set up unit so that no one will trip over the flex.
 - This unit is recommended to be installed on shock-free benches in order to avoid any danger from falling.
 - Take note that toddlers can pull the unit down from a table or cupboard by means of its flex. Children can hurt themselves when doing this.
 - Do not use the unit near heat sources. The casing and flex could be damaged by the intensity of the heat.
 - The screen is made of glass and can break if damage is done to it. Be careful when collecting sharp edged glass splinters.
 - If you intend to wall mount the unit, contact the shop where you purchased the unit for advice, and leave the installation work to professionals. Improper installation can cause damage and/or injuries.
 - When installing the set on a wall, allow at least 10 cm clearance between the rear of the set and the wall. Clearance of less than 10 cm will obstruct the vents and cause overheating to the interior of the set, resulting in faults or damage to the set.
 - Taking fall-prevention measures
 - If these measures are not taken, the unit can fall and cause damage and/or injuries.
 - Contact the shop where you purchased the unit to obtain full details of the measures.
 - When a TV stand is used,
 - Ensure the unit is fully on the stand and placed in the centre.
 - Do not leave the stand doors open. You could be hurt as a result of the unit falling or breaking, or your fingers being caught or jammed. Take extra precautions if you have children.
 - Avoid placing the unit on any surfaces that may be subject to vibrations or shocks.
 - To protect the unit during a thunder storm, unplug the AC power cord and disconnect the aerial.
- Caution:** Do not touch the aerial connector.
- When you leave your home for a long period of time, unplug the AC power cord for safety.
- The unit becomes warm when in operation. Do not place any covers or blankets on the unit in order to prevent overheating.
- The ventilation holes should not be blocked. Do not set up near radiators. Do not place in direct sunshine.
- When placing on a shelf, allow at least 10 cm clearance space around the whole unit.
 - The unit shall not be exposed to dripping or splashing, and no objects filled with liquids, such as vases, shall be placed on the apparatus.
 - Liquids spilled into the unit can cause serious damage. Switch the set off and disconnect the mains power supply, then consult a qualified service person before attempting to use the unit again.
 - Moisture condensation occurs, for example, when you pour a cold drink into a glass on a warm day and drops of water form on the outside of the glass. In the same way, moisture may condense on this unit's internal optical pick-up lens, one of the most crucial internal parts of the unit.
 - Moisture condensation occurs in the following situations:
 - When you move the unit from a cold place to a warm place.
 - When you use the unit in a room where the heater was just turned on.
 - When you use the unit in an area where cold air from an air conditioner directly hits the unit.
 - When you use the unit in a humid place.
 - Never use the unit when moisture condensation may occur.
 - Using the unit when moisture condensation exists may damage its own internal parts and discs. Connect the power cord of the unit to the wall outlet, turn on the unit, remove the disc, and leave it for two or three hours. After two or three hours, the unit will warm up and moisture will be evaporated. Leaving the TV connected to the wall outlet will help prevent moisture condensation in the unit.
 - Never place hot objects or open flame sources, such as lighted candles or night lights, on or close to the TV. High temperatures can melt plastic and lead to fires.



Removing the pedestal stand

Removing the pedestal stand

(1) Carefully lay the front of the TV face down on a flat, cushioned surface such as a quilt or blanket. Leave the stand protruding over the edge of the surface.

Note: Extreme care should always be taken when removing the pedestal stand to avoid damage to the LCD panel.

(2) Remove the four screws on the stand. This will allow removal of the pedestal stand.

(3) Once you have removed four screws holding the pedestal stand in place, remove the pedestal stand and the plastic molding from the TV by removing away from the TV.

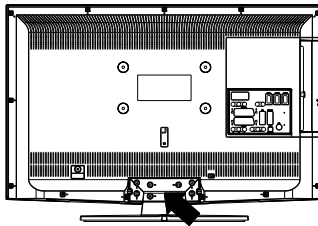
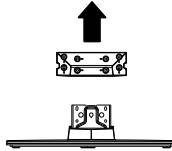
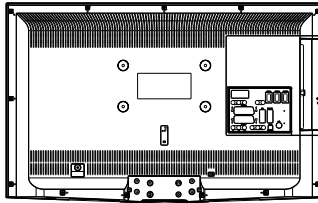

For 32BL505B model



The Remote Control

Simple at-a-glance reference of your remote control.

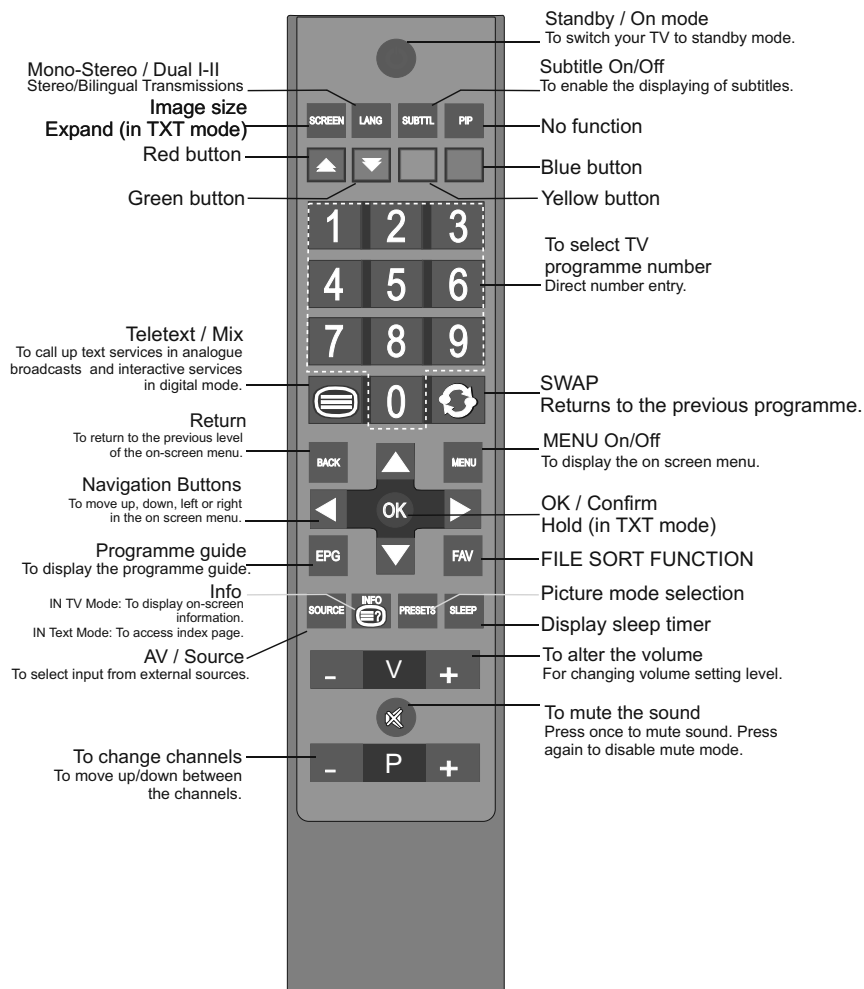

Inserting Batteries and Effective Range of the Remote Control



Remove the back cover to reveal the battery compartment and make sure the batteries are inserted the right way round. Suitable battery types for this remote are AAA, IEC R03 1.5V.

Do not combine a used, old battery with a new one or mix battery types. Remove dead batteries immediately to prevent acid from leaking into the battery compartment. Dispose of them in a designated disposal area.

Warning: Batteries must not be exposed to excessive heat such as sunshine, fire or the like.

The performance of the remote control will deteriorate beyond a distance of five metres or outside an angle of 30 degrees from the centre of the television. If the operating range becomes reduced the batteries may need replacing.

Connecting External Equipment

Before connecting any external equipment, remove the mains plug from the wall socket.

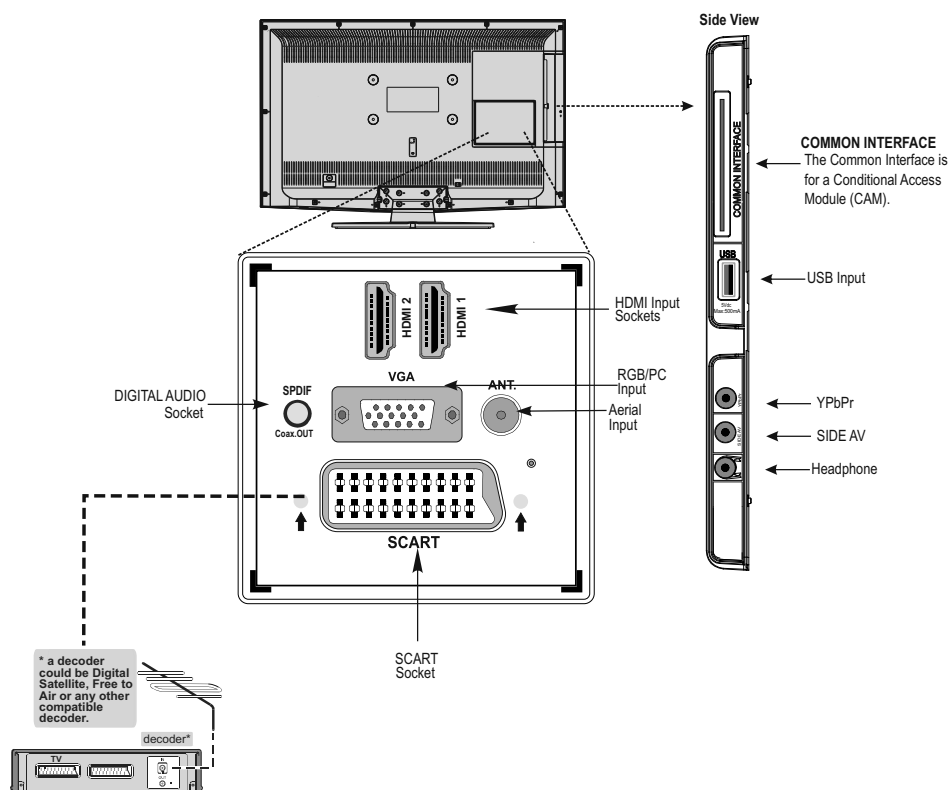

Aerial cable:.....
Connect the aerial to the AN.T. socket on the rear of the TV.

SCART lead:.....
If you use a **decoder*** or a **media recorder**, it is essential that the scart cable is connected to the TV.

Before running **first time installation**, any connected devices need to be set to standby mode.

The DIGITAL AUDIO socket enables the connection of a suitable surround sound system.

HDMI® (High-Definition Multimedia Interface) is for using with a DVD decoder or other equipment with digital audio and video output. It is designed for best performance with 1080i and 1080p high-definition video signals but will also accept and display VGA, 480i, 480p, 576i, 576p and 720p signals. PC format signals will also be displayed.

NOTE: Although this TV is able to connect to HDMI equipment, it is possible that some equipment may not operate correctly.

A wide variety of external equipment can be connected to the TV; therefore, the relevant owner's manuals for all additional equipment must be referred to for exact instructions.

If the TV automatically switches over to monitor external equipment, return to normal TV by pressing the desired programme position button. To recall external equipment, press **SOURCE** button repeatedly to switch between sources.

Regardless of source's property, audio output from the DIGITAL AUDIO socket cannot be copied.

Connecting an HDMI® or DVI Device to the HDMI Input

The HDMI inputs on your TV receive digital audio and uncompressed digital video from an HDMI source device or uncompressed digital video from a DVI (Digital Visual Interface) source device.

These inputs are designed to accept HDCP (High-Bandwidth Digital-Content Protection) programme material in digital form from EIA/CEA-861-D-compliant [1] consumer electronic devices (such as a set-top box or DVD player with HDMI or DVI output).

NOTE:

- Some early HDMI equipment may not work properly with your latest HDMI TV.
- Supported Audio format: Linear PCM, sampling rate 32/44.1/48kHz.

To Connect an HDMI Device

Connect an HDMI cable (type A connector) to the HDMI terminal. For proper operation, it is recommended that you use an HDMI cable with the HDMI Logo ().

- If your HDMI connection is capable of 1080p and/or your TV is capable of refresh rates greater than 50Hz, you will need a Category 2 cable. Conventional HDMI/DVI cable may not work properly with this mode.
- HDMI cable transfers both video and audio. Separate analogue audio cables are not required (see illustration).
- To view the HDMI device video, press **SOURCE** button to select HDMI1 or HDMI2.

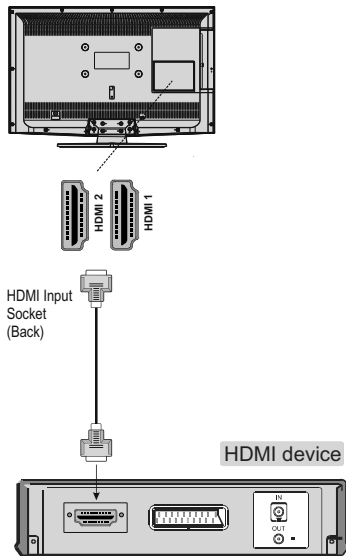

To Connect a DVI Device

Connect an HDMI-to-DVI adaptor cable (HDMI type A connector) to the HDMI input socket and audio cables to the SIDE AV socket, using the supplied Side AV connection cable's RED and WHITE inputs (see illustration).

- The recommended HDMI-to-DVI adaptor cable length is 6.6 ft (2m).
- An HDMI-to-DVI adaptor cable transfers video only. Separate analogue audio cables are required.

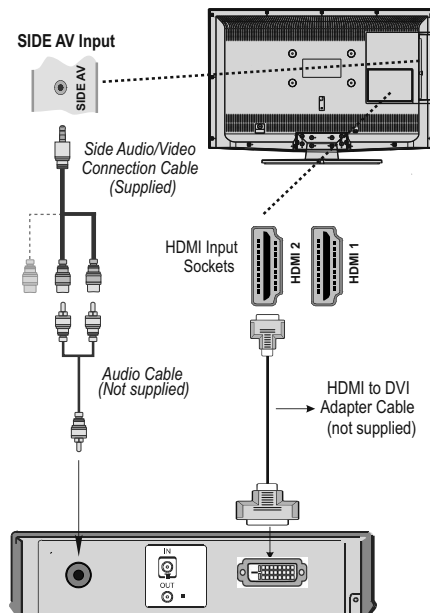

NOTE:

To ensure that the HDMI or DVI device is reset properly, it is recommended that you follow these procedures:

- When turning on your electronic components, turn on the TV first, and then the HDMI or DVI device.
- When turning off your electronic components, turn off the HDMI or DVI device first, and then the TV.

Connecting a Computer

To Connect a Computer

With either an RGB/PC or an HDMI connection, you can watch your computer's display on the television and hear the sound from the television's speakers.

When connecting a PC to the VGA input on television, use an analogue RGB (15-pin) computer cable and use the SIDE AV socket with a PC audio cable (not supplied) for audio connection, using the supplied SIDE AV connection cable's RED and WHITE inputs (see illustration).

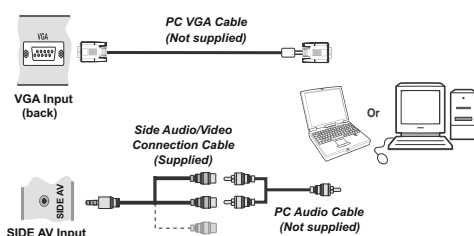

To use a PC, set the monitor output resolution on the PC before connecting it to the TV. To display the optimum picture, use the PC setting feature.

NOTE:

- Some PC models cannot be connected to this television. An adaptor is not needed for computers with a compatible mini D-sub15-pin terminal.
- Depending on the DVD's title and the specifications of the PC on which you are playing the DVD-Video, some scenes may be skipped or you may not be able to pause during multiangle scenes.

Connecting to a DVD Player via YPbPr

Some DVD players are connected through COMPONENT SOCKETS (YPbPr). In this case, you must use the supplied Component YPbPr video connection cable for enabling connection. First, plug the single jack of the cable to the TV's YPbPr socket (side). Afterwards, insert your YPbPr cable's (not supplied) connectors into the plural part of the supplied YPbPr video connection cable (see illustration below). Colours of the connected jacks should match.

To enable audio connection, use the supplied Side AV connection cable. First, plug single jack of the cable to the Side AV Input of the TV. Afterwards, insert your DVD player's audio cable's connectors into the plural part of the supplied Side AV connection cable (see illustration below). Colours of the connected jacks should match.

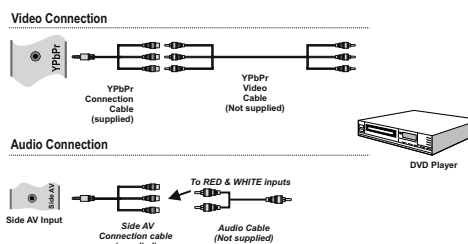

Connecting a USB Memory

To Connect a USB Disk

- You can connect a USB disk to your TV by using the USB input of the TV. This feature allows you to display/play music, photo or video files stored in a USB stick.
- It is possible that certain types of USB devices (e.g. MP3 Players) may not be compatible with this TV.
- You may back up your files before making any connections to the TV set in order to avoid any possible data loss. Note that manufacturer will not be responsible for any file damage or data loss.
- Do not pull out USB module while playing a file.

CAUTION: Quickly plugging and unplugging USB devices, is a very hazardous operation. Especially, do not repeatedly quickly plug and unplug the drive. This may cause physical damage to the USB player and especially the USB device itself.

USB Memory Connection

- Plug your USB device to the USB input of the TV.

SIDE VIEW

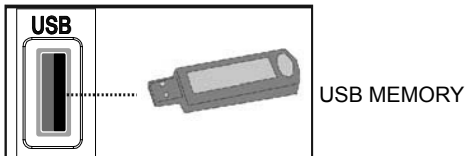

NOTE: The USB socket has limited functionality, and Toshiba can take no responsibility for damage to other connected equipment.



Power Save Mode

Environmental Information

- This television is designed to consume less energy to save environment.

You not only help to save the environment but also can save money by reducing electricity bills, thanks to the energy efficiency feature of this TV. To reduce energy consumption, you should take the following steps:

You can use Power Save Mode setting, located on **page 27**. If you set Power Save Mode as On, the TV will switch to energy-saving mode and luminance level of TV set will be decreased to optimum level. Note that some picture settings will be unavailable to be changed when the TV is in Power Save Mode.

Power Save Mode



Off



When the TV is not in use, please switch off or disconnect the TV from the mains plug. This will also reduce energy consumption.

- Disconnect power when going away for longer time.

Note that annually, using the TV set in Power Save Mode has more power efficiency than disconnecting the TV from the mains plug instead of keeping stand-by mode. Therefore it is highly recommended to activate Power Save Mode setting to reduce your annual power consumption. And also it is recommended to disconnect the TV from the mains plug to save energy more when you do not use.

- Please helps us to save environment by following these steps.
- This television is designed to consume less energy.
- Harmful substances and contents that are dangerous to health, are eliminated in its design.
- This product is designed to endure longer and it is subject to recycling at the end of its service life.

When the TV reaches the end of its service life, dispose the product in accordance with the proper recycling process as explained on **page 45**.

Repair Information

Please refer all servicing to qualified personnel. Only qualified personnel must repair the TV. Please contact your local dealer, where you have purchased this TV for further information.

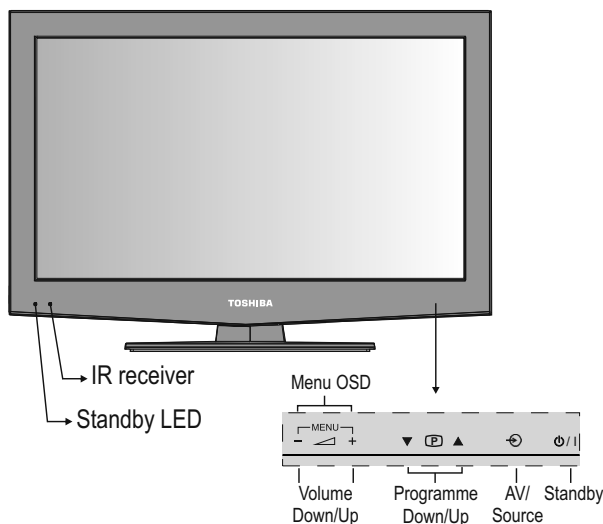

Controlling the TV

A wide variety of external equipment can be connected via the sockets located on the side and back of the TV. Whilst all the necessary adjustments and controls for the TV are made using the remote control, the button on the left side of the TV may be used for some functions.



Switching on

If the standby LED is unlit, check that the mains plug is connected to the power and press the  button on the right side of the television to switch the television on.

To put the television into Standby, press  button on the remote control or on the TV. To view the television, press  button again. The picture may take a few seconds to appear.

Note: The active Standby LED may appear for a few moments when the TV is switched off.

For energy saving:

Turning the TV off at its mains supply, or un-plugging it, will cut energy use to nearly zero for all TV's. This is recommended when the TV is not being used for a long time, e.g. when on holiday.

Reducing the brightness of the screen will reduce energy use. Energy efficiency cuts energy consumption and thus saves money by reducing electricity bills.

NOTE: Putting the TV into standby mode, will reduce energy consumption, but will still draw some power.

Using the Remote Control

Press the **MENU** button on the remote control to see the menus.









The main menu appears as a group of icons each for a menu option. Press the Left or Right button to select a topic.

In sub menu screen mode the menu appears as a list. Press the Up or Down button to select a topic.

To use the options press the Up and Down buttons on the remote control to move up and down through them and **OK**, Left or Right buttons to select the required choice. Follow the on screen instructions. The functions of each menu are described in detail throughout the manual.

Using the Controls and Connections on the TV

Using the control buttons on the front of the TV:

- To alter the volume press +  or - .
- To alter the programme position press   on the right side of the TV.
- Press +  - buttons at the same time to view main menu and use   to navigate and +  - to change value.

To select an external input, press  until the appropriate input source is selected.

Please always refer to the owner's manual of the equipment to be connected for full details.

Initial Installation

Before switching on the television put your decoder and media recorder to **Standby** if they are connected and ensure the aerial is connected to your television. To set up the television use the buttons on the remote control as detailed on **page 13**.

IMPORTANT: Ensure that the aerial is connected and a Common Interface module is not inserted before switching on the TV for the first time installation.

1. Connect the mains plug and switch the TV to on using the **⏻** button. If the TV does not switch on, press any numbered or **⏻** button on the remote control, then the language selection menu will be displayed. This screen will appear the first time that the TV is switched on and each time the TV is reset.

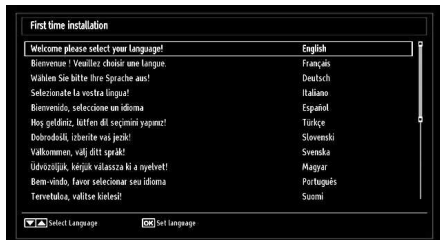

2. By pressing **Up** or **Down** button, highlight the language you want to set and press **OK** button. The following message will be displayed next:



3. By pressing **Left** or **Right** button, select the **country** you want to set and press **Down** button to highlight the **Search Type** option. Use **Left** or **Right** to set the desired search type. Available search types are Digital and analog, digital only and analog only.
4. When set, **Down** button to select Teletext Language. Use **Left** or **Right** button to select desired Teletext Language.
5. Press **Down** button after setting Teletext Language option. **Scan Encrypted** will be then highlighted. You can set **Scan Encrypted** as **Yes** if you want to scan coded stations.

6. Press **OK** button on the remote control to continue and the following message will be displayed on the screen:

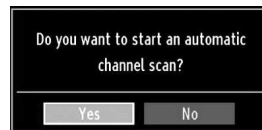

7. Select **Yes** button by using **Left** or **Right** button and press **OK** button to continue.
8. The Auto tuning screen will appear and the television will start to search for available stations. The progress bar will move along the line. You must allow the television to complete the search. The following OSD will be displayed on the screen and the television will search for the selected broadcasts:



Note: You can press **MENU** button to cancel.

- After the available stations are stored, Channel List will be displayed on the screen. If you like the sort channels, according to the LCN, please select **Yes** and then press **OK** button (if available).



- Press **OK** button to quit channel list and watch TV.
- Note:** Do not turn off the TV while initializing first time installation.

Auto Tuning

Auto Tuning

As new services are broadcast, it will be necessary to retune the television in order to view them.

- Auto Tuning will completely retune the television and can be used to update the channel list. It is recommended that Auto Tuning is run periodically to ensure that all new services are added. All current channels and settings, i.e. locked channels, will be lost.
- Press **MENU** button on the remote control and select **Install and Retune** by using **Left** or **Right** button. Press **OK** button and the following menu screen will be displayed.

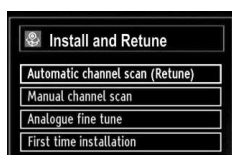

- Select **Automatic Channel Scan (Retune)** by using **Up** or **Down** button and press **OK** button. Automatic Channel Scan options will be displayed. You can select options by using **Up** or **Down** and **OK** buttons.

Auto Channel Scan Menu Operation

Digital: Searches and stores aerial DVB stations.

Analogue: Searches and stores analogue stations.

Full: Searches and stores both analogue and aerial DVB stations

- Whenever you select an automatic search type and press **OK** button, a confirmation screen will appear on the screen. To start installation process, select **Yes**, to cancel select **No** by using **Left** or **Right** and **OK** button.
- After auto channel scan type is set and selected and confirmed, installation process will start and progress bar will move along. Press **MENU** button to cancel process. In such a case, located channels are not stored. The television will start to search for all available stations. You must allow the television to complete the search.

Manual Tuning, Analogue Fine Tuning

The television can be tuned-in manually using Manual Search feature.

Digital Manual Search

The feature is available for service engineers or can be used for direct channel entry if the multiplex channel is known.

- Select **Manual Search** from the Installation menu and press **OK**.

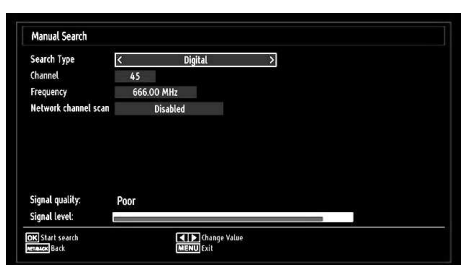

- After selecting search type as **Digital**, you can enter the multiplex or frequency number using the numeric buttons and press **OK** button to search.
- Enter the multiplex number using the numeric buttons. The television will automatically search for that multiplex. When the multiplex is found any channels not currently on the programme list will be added and the programme information at the top of the screen will be updated.
- Repeat as necessary.

Analogue Manual Search

The television can be tuned-in manually. For example: if the television cannot be connected to a media recorder/decoder with a SCART lead or to tune-in a station on another System.

To allocate a programme position on the television for a decoder and media recorder: turn the decoder on, insert a pre-recorded film into the media recorder and press PLAY, then manually tune.

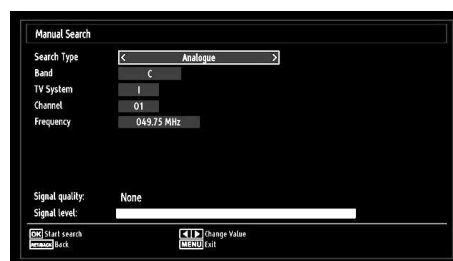

After selecting search type as **Manual Channel scan**, you can use **Up** or **Down** button to highlight an item and then press **Left** or **Right** button to set an option.

Enter the channel number or frequency using the numeric buttons. You can then press **OK** button to search. When the channel is located, any new channels that are not on the list will be stored.

Analogue Fine Tune

- Select **Analogue Fine Tune** from the Installation menu by using **Up** or **Down** and **OK** buttons. Analogue fine tune screen will be displayed. Analogue Fine Tune feature will not be available if there are no analogue channels, digital channels and external sources stored.
- Press **OK** button to proceed. Use **Left** or **Right** button to set Fine Tune. When finished, press **OK** button again.

General Operation

Stereo and Bilingual Transmissions

If stereo or dual language broadcasts are transmitted, the word Stereo or Dual will appear on the screen each time positions are changed, disappearing after a few seconds. If the broadcast is not in stereo, the word Mono will appear.

Stereo... Press **LANG.** to select Stereo or Mono.

Bilingual... Bilingual transmissions are rare. If they are transmitted, the word Dual will be displayed. Choose the required programme number, and if the word Dual appears, press **LANG.** to select Dual 1, Dual 2 or Mono.

For DTV broadcasts

To view current language and for changing to an alternative language (if available), press **LANG.** button. Available options will be listed.

Displaying Subtitles

In digital broadcasts, this feature will show subtitles on the screen in the selected language provided they are being broadcast.

- Press **SUBTTL** button to activate available subtitles. Press **SUBTTL** button again to turn off subtitles.

Viewing Main Menu

- Press **MENU** button on the remote control to view main menu.

Controlling Volume and Muting Sound

Volume

Press **V+** or **V-** button to adjust the volume.

Sound Mute

Press "**M**" button once to turn the sound off and again to cancel.

Selecting Programme Positions

To select a programme position use the numeric buttons on the remote control. Programme positions can also be selected using **P+** or **P-** button.

Press **INFO** button to display the on-screen information i.e. programme position, stereo/mono signal and picture format.

Standby Notifications

If the TV switches off while in No Signal mode, the following on-screen message will be displayed on the next switch-on:

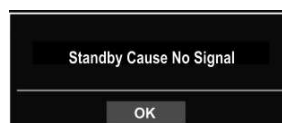

If the TV switches off owing to the auto power down feature, the following on-screen message will be displayed on the next switch-on:



Channel List, Sorting Programmes, Programme Locking

You can view stored channels and sort them by using the Channel List feature.

Viewing Channel List

The channel order may be changed to suit your personal preference.

- Select **Channel List** from the main menu and press **OK** button. The following menu will be displayed:



- Select **Edit Channel List** to manage all stored channels. Use **Up** or **Down** and **OK** buttons to select **Edit Channel List**.



- Press **Up** or **Down** button for selecting a channel. You can press **P+** or **P-** button to move page up or page down.
- To watch a specific channel, highlight it by using **Up** or **Down** button. Afterwards press **OK** button.
- Press **BLUE** button to view filtering options.
- Press **MENU** button to exit.

Note: The channels listed are mixed at the channel list. Channel types can be differentiated by the icons next to them: **DTV** (digital tv), **HD** (HD TV), **ATV** (Analogue TV), **TV** (TV), **RD** (Radio), encrypted, lock, and at the favourite list. Listed channels can also be sorted by using the active channel list filter.

Moving a Channel

- Highlight the desired channel by using **Up** or **Down** buttons.
- Select **Move** option in the channel list and press **OK** button.
- Edit Number screen will be displayed. Enter the desired channel number by using the numeric buttons on the remote control. If there is a previously stored channel on that number, a warning screen will be displayed. Select **Yes** if you want to move the channel and press **OK**.
- Selected channel is now moved.

Deleting a Channel

You can press **GREEN** button to tag/untag all channels; **YELLOW** button to tag/untag channel.

- Select the channel that you want to delete and select **Delete** option. Press **OK** button to continue.
- A warning screen will appear. Select **Yes** to delete, select **No** to cancel. Press **OK** button to continue.

Renaming a Channel

- Select the channel that you want to rename and select **Edit Name** option. Press **OK** button to continue.
- Pressing **Left** or **Right** button moves to the previous/next character. Pressing **Up** or **Down** button changes the current character. Pressing the numeric buttons '0...9' replaces the highlighted character with the characters printed above the button one by one as the button is pressed.
- When finished, press **OK** button to save. Press **MENU** to cancel.

Locking a Channel

You can press **GREEN** button to tag/untag all channels; **YELLOW** button to tag/untag a single channel.

- Select the channel that you want to lock by using **Up** or **Down** buttons.
- Select **Lock** option by using **Left** or **Right** buttons. Press **OK** button to continue.
- You will be asked to enter parental control PIN. Enter the PIN number.

Note: Default PIN is set to 0000.

- Press **OK** button when the desired channel is highlighted to lock/unlock the channel. Lock symbol will be displayed next to the selected channel.

Viewing Info Banner, Electronic Programme Guide

Viewing Info Banner

- Press **INFO** button. The information screen will appear giving details of the channel and programme currently being viewed.



- Whenever you change channel, the TV displays the broadcast picture along with an information banner at the bottom of the screen (available only in DTV mode). This will remain on the screen for a few seconds.
- If the selected channel is locked, you must enter the correct four numeric code to view the channel. "Enter PIN" will be displayed on the screen in such a case:



- Enter the 4-digit PIN number to continue.

Note: Factory set default PIN code is 0000.

Electronic Programme Guide

- Select the on-screen guide by pressing **EPG** button, the guide screen will appear highlighting details of the channel and programme currently being viewed. This may take a few moments to appear.

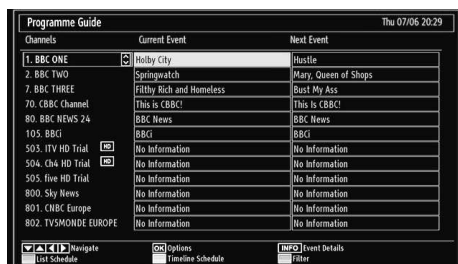

- For information on a highlighted programme, press **INFO** button.
- For details of other programmes currently available, press **navigation buttons** to scroll up and down or scroll left/right through the list. As channels are selected, details of the programme currently being broadcast will appear.
- To set the timer for a selected programme, press **OK** button to select Timers menu.
- Press **YELLOW** button to switch to timeline view.

- Press **GREEN** button to list the schedule.
- Press **BLUE** button to display filtering options.

Note: There are alternative views of EPG screen. Button functions will be displayed at the bottom of the menu screen.

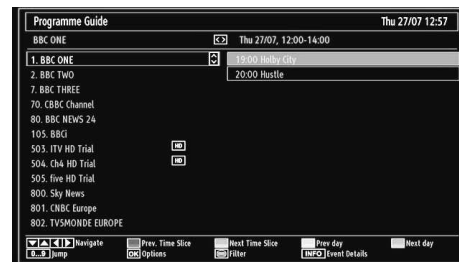

Language Selection

Language Settings

Using this menu you can adjust the preferred language settings.

- Select Language from Setup menu and press **OK** to view this menu. Press the **RETURN** button on the remote control to exit.

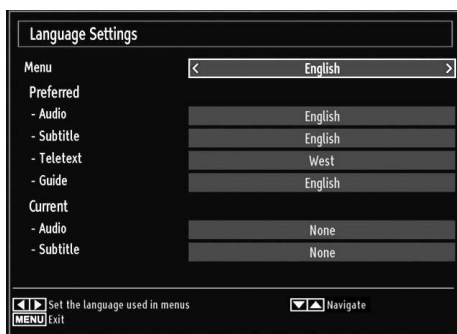

Preferred

These settings will be used if available. Otherwise the current settings will be used.

Audio: by pressing **Left** or **Right** keys change the audio language.

Subtitle: alter the subtitle language with **Left** or **Right** keys. The chosen language will be seen in subtitles.

Teletext: changes the preferred teletext language.

Guide: By pressing **Left** or **Right** buttons change the guide language.

Current

Audio: if audio language is supported change the audio language by pressing **Left** or **Right** buttons.

Subtitle: if subtitle is backed up, alter the subtitle language with **Left** or **Right** buttons. The chosen language will be seen in subtitles.

Digital Settings - Parental Control, Menu Lock, Set PIN

You can view or set parental preferences of your TV.

Viewing Parental Control Menu

Press **MENU** button and select the **Settings** by using **Left** or **Right** button. Press **OK** button to view Settings menu. Use **Up** or **Down** button to highlight **Parental** and press **OK** to continue:



- A dialogue box asking for the lock key will be displayed. The default key is set to **0000**. Enter the PIN.
- If it is incorrect, **“Wrong PIN”** OSD will be displayed. If it is correct, the Parental Control menu will be displayed:



Menu Lock

In Menu lock you can set locking for All menus, or the Installation Menu to restrict access to these menus. If the menu lock is disabled, there will be free access to the menu system.

- Use **Up** or **Down** buttons to go to Menu Lock option. Use **Left** or **Right** buttons to choose Menu Lock Mode.

DISABLED : All menus are unlocked.

ALL MENUS : All Menus are accessible only with the correct lock key. So the user cannot add, delete, rename, channels, cannot set timers.

INSTALLATION MENU: Installation menu is locked. So the user can't add channels. Changes will be updated after exiting 'Configuration Menu'.

Child Lock

Press **MENU** button and select settings by using **Left** or **Right** button. Press **OK** to continue. Use **Up** or **Down** to select parental and then press **OK** to continue. Enter the pin number. Child Lock disables the buttons on the television. All buttons on the remote control can still be used.

Set PIN

- Use **Up** or **Down** buttons to select **Set PIN** option. Press **OK** to display the **Set PIN** window.
- Use numeric buttons to enter new pin number. You will need to input your new pin a second time for verification purposes.
- After typing correct PIN numbers, PIN number will be changed.

Note: The factory default pin number is 0000, if you change the pin number make sure you write it down and keep it safe.

Configuring Picture Settings

You can configure picture settings of your TV by using Picture Settings menu.

Configuring Picture Settings

You can use different picture settings in detail. You can customize current picture mode settings as desired. For example you change items such as, Brightness, Contrast, Colour, Sharpness and Hue.

Press **MENU** button and select the Picture icon by using **Left** or **Right** button. Press **OK** button to view Picture Settings menu.

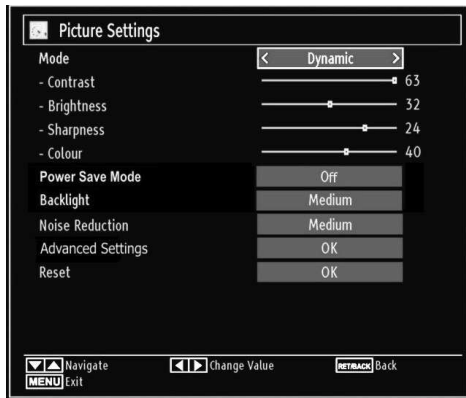

Operating Picture Settings Menu Items

- Press **Up** or **Down** button to highlight a menu item.
- Use **Left** or **Right** button to set an item.
- Press **MENU** button to exit.

Picture Mode

Press **MENU** button and select picture by using **Left** or **Right** button. Press **Up** or **Down** to select mode. This television offers the choice of personalising the picture style. **Cinema**, **Game**, **Dynamic** and **Natural** are preset options and affect settings within the television.

- In the **Picture Settings** menu, press **Up** or **Down** to select Mode. Press **Left** or **Right** to select the picture mode you prefer.

Contrast

Press **MENU** button and select picture by using **Left** or **Right** button. Press **Up** or **Down** to select contrast. Sets the lightness and darkness values of the screen.

Brightness

Press **MENU** button and select picture by using **Left** or **Right** button. Press **Up** or **Down** to select brightness. Sets the brightness value for the screen.

Sharpness

Press **MENU** button and select picture by using **Left** or **Right** button. Press **Up** or **Down** to select sharpness. Sets the sharpness value for the objects displayed on the screen.

Colour

Press **MENU** button and select picture by using **Left** or **Right** button. Press **Up** or **Down** to select colour. Sets the colour value, adjusting the colors.

Power Save Mode

Enables or disables the power save mode. Use **Up** or **Down** button to select Power Save Mode. Press **Left** or **Right** button to set **Power Save Mode** as On or Off. See the section, *Environmental Information* in this manual for further information on **Power Save Mode**.

Note: The backlight function will be inactive if Power Save Mode is set to on.

Backlight (optional)

This setting controls the backlight level and it can be set to Auto, Maximum, Minimum, Medium and Eco Mode.

Note: Backlight can not be activated in VGA or Media Browser mode or while picture mode is set as Game.

Noise Reduction

Sometimes some words or picture elements may become distorted or pixelated. Using the Noise Reduction feature reduces this effect by smoothing out the edges. Press **MENU** button and select **Picture** by using **Left** or **Right** button. Press **Up** or **Down** button to select **Noise Reduction**.

Configuring Picture Settings - continued

Advanced Settings

Some additional controls in the picture menu are grouped under the title **Advanced Settings**. To view or change, first press **Up** or **Down** button to select **Advanced Settings**. Press **OK** button to view. **Advanced Settings** menu controls are as the following:

- **Colour Temp**: Colour Temperature increases the 'warmth' or 'coolness' of the picture by increasing the red or blue tint. Press **MENU** button and select **Picture** by using **Left** or **Right** button. Press **Up** or **Down** button to select **Colour Temp**.
- **Picture Zoom**: Sets the picture size to Auto,16:9, Subtitle,14:9, 14:9 Zoom, 4:3, Panoramic or Cinema. Press **MENU** button and select **Picture** by using **Left** or **Right** button. Press **Up** or **Down** button to select **Picture Zoom**.
- **HDMI True Black (optional)**: While watching from HDMI source, this feature will be visible in the Picture Settings menu. You can use this feature to enhance blackness in the picture. You can set this feature as "On" for activating HDMI True Black mode.
- **Film Mode (optional)**: Films are recorded at a different number of frames per second to normal television programmes. Press "▼" or "▲" buttons to select Film mode. Press "◀" or "▶" buttons to set this feature Auto or Off. Turn this feature to Auto when you are watching films to see the fast motion scenes clearly.
- **Colour Shift**: Adjust the desired colour tone. Press **MENU** button and select **Picture** by using **Left** or **Right** button. Press **Up** or **Down** button to select **Colour Shift**.

Resetting

Press **MENU** button and select picture by using Left or Right button. Press Up or Down to select reset and press **OK**. This feature allows you to reset the current Picture Settings to the default values.



Changing Picture Format

Depending on the type of broadcast being transmitted, programmes can be viewed in a number of formats. Press **SCREEN** button repeatedly to select between **Auto**, **16:9**, **Subtitle**, **14:9**, **14:9 Zoom**, **4:3**, **Panoramic** or **Cinema**. When **auto** is selected the format being displayed is determined by the picture being broadcast.

"Note: Using the special functions to change the size of the displayed image (i.e. changing the height/width ratio) for the purposes of public display or commercial gain may infringe on copyright laws."

Note: You can shift to screen up or down by pressing "▲"/"▼" buttons while picture zoom is selected as Panoramic, 14:9 Zoom, Cinema or Subtitle.

16:9	<i>Use this setting when watching a widescreen DVD, widescreen video tape or a 16:9 broadcast (when available). Due to the range of widescreen formats (16:9, 14:9 etc.) black bars may be visible on the top and bottom of the screen.</i>	→	
subtitle	<i>When subtitles are included on a letterbox format broadcast, this setting will raise the picture to ensure that all the text is displayed.</i>	→	
14:9	<i>This zooms up the wide picture (14:9 aspect ratio) to the upper and lower limits of the screen</i>	→	
14:9 zoom	<i>This option zooms to the 14:9 picture.</i>	→	
4:3	<i>Use this setting to view a true 4:3 broadcast.</i>	→	
panoramic	<i>This stretches the left and right sides of a normal picture (4:3 aspect ratio) to fill the screen, without making the picture appear unnatural. The top and bottom of the picture are slightly cut off.</i>	→	
cinema	<i>This zooms up the wide picture (16:9 aspect ratio) to the full screen.</i>	→	



Configuring PC Picture Settings

You can set PC Mode picture settings when using the TV as a PC monitor.

PC Picture Settings (*)

(*) While in VGA/PC mode, some items in Picture menu will be unavailable. Instead, VGA mode settings will be added to the Picture Settings while in VGA/PC mode.

PC Picture controls

Contrast, Brightness and Colour Temperature adjustments in this menu are identical to adjustments defined in TV picture menu.

Select **Reset** and press **OK** button to reset the adjustments.

Note:

For switching to **VGA/PC** source, press **SOURCE** button on your remote control and select **VGA/PC** input.

Note that **VGA/PC** mode menu settings are available only while the TV is in **PC** source.

PC Position

Select this to display PC position menu items.

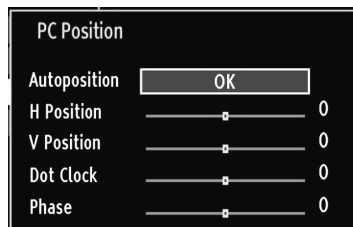

Autoposition

If you shift the picture horizontally or vertically to an unwanted position, use this item to put the picture into correct place automatically.

- Select the **PC POSITION** option from the main menu. **PC Position** menu appears on the screen.
- Press the **Down** button to highlight **Autoposition** and then press the **OK** button.

H Position

H (Horizontal) Position shifts the image horizontally to right hand side or left hand side of the screen.

- In the **PC POSITION** menu press the **Down** button until **H Position** is highlighted.
- Press the **Left** or **Right** button to adjust the value.

V Position

V (Vertical) Position shifts the image vertically towards the top or bottom of the screen.

- In the **PC POSITION** menu press the **Down** button until **V Position** is highlighted.
- Press the **Left** or **Right** button to adjust the value.

Dot Clock

Dot Clock adjustment corrects the interference that appear as vertical banding in dot intensive presentations like spreadsheets or paragraphs or text in smaller fonts.

- In the **PC POSITION** menu press the **Down** button until **Dot Clock** is highlighted.
- Press the **Left** or **Right** button to adjust the value.

Phase

Depending on the resolution and scan frequency that you input to the TV Set, you may see a hazy or noisy picture on the screen. In such a case you can use this item to get a clear picture by trial and error method.

- In the **PC POSITION** menu press the **Down** button until **Phase** is highlighted.
- Press the **Left** or **Right** button to adjust the value.

Configuring Sound Settings

You can configure sound settings of your TV by using Sound Settings menu.

Configuring Sound Settings

Sound settings can be configured according to your personal preferences.

Press **MENU** button and select the Sound icon by using Left or Right button. Press **OK** button to view Sound Settings menu.

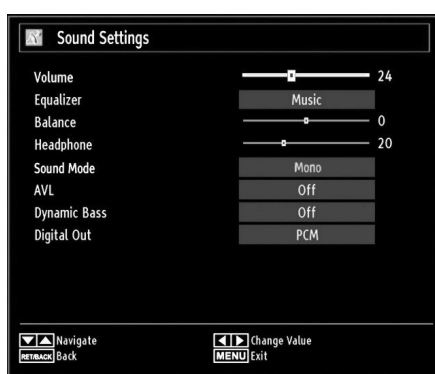

In equalizer menu, the preset can be changed to **Music, Movie, Speech, Flat, Classic** and **User**. Press the **MENU** button to return to the previous menu.

Note: Equalizer menu settings can be changed manually only when the **Equalizer Mode** is in **User**.

Balance (Only for speaker)

This setting is used for emphasizing left or right speaker balance.

- Press **Left** or **Right** button to change the level of the balance. Balance level can be adjusted between **-31** and **+31**.

Headphone

This setting is used to set the sound output when headphones are connected.

- Press **Up** or **Down** button to select **Headphone**.
- Press **Left** or **Right** button to select Volume. Press **Right** button to increase headphone volume level. Press **Left** button to decrease headphone volume level. Headphone volume level can be adjusted between 0 and 63.

Sound Mode

This setting is used to set the sound mode. Highlight **Sound Mode** by using **Up** or **Down** button. Press **Left** or **Right** button to set.

You can select Mono, Stereo, Dual I or Dual II mode, only if the selected channel supports that mode.

AVL

Sometimes there can be large changes in volume when switching from a DTV 5.1ch to a DTV 2ch, an ATV channel, or an external input. Using the AVL feature reduces these volume differences.

- In the **SOUND** menu, press **Up** or **Down** to highlight **AVL**. Press **Left** or **Right** button to set AVL as On or Off.

Dynamic Bass

Dynamic Bass is used to increase bass effect of the TV set.

Digital Out

Select Digital Out using Up or Down button and then use Left or Right button.

Operating Sound Settings Menu Items

- Press **Up** or **Down** button to highlight a menu item.
- Use **Left** or **Right** button to set an item.
- Press **MENU** button to exit.

Volume

Select Volume using Up or Down button and then use Left or Right button to set volume level.

Equalizer (Only for speaker)

You can customize current sound mode settings. Select the appropriate mode in accordance with the installation location of the TV and adjust the equalizer on-screen as desired. Press **OK** button to view equalizer sub-menu.

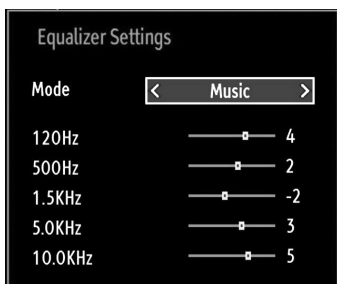

Settings Menu Operation, Conditional Access

Configuring Your TV's Settings

Detailed settings can be configured to suit your personal preferences.

Viewing Settings Menu

Press **MENU** button and select Settings icon by using **Left** or **Right** button. Press **OK** button to view Settings menu.

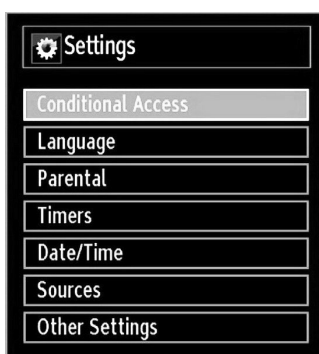

Operating Settings Menu Items

- Press **Up** or **Down** button to highlight a menu item.
- Press **OK** button to select an item.
- Press **MENU** button to exit.

Conditional Access

Select Setting from the main menu by using Left or Right button and press **OK**. Afterwards, use Up or Down button to set Conditional Access. Press **OK** to continue. This setting controls conditional access modules when available.

Language

Press **MENU** button and select settings by using Left or Right button. Press **OK** to continue. Use Up or Down to select language and then press **OK** to continue. Using this menu you can adjust the preferred language settings.

Configures language settings.

Parental

Configures parental settings.

Timers

Sets timers for selected programmes. Press **MENU** button and select **Settings** by using **Left** or **Right** button. Press **OK** button to continue. Use **Up** or **Down** button to select **Timers** and then press **OK** button to continue.

Date/Time Settings

You can configure date/time preferences by using this menu screen. Press **MENU** button and select **Settings** by using **Left** or **Right** button. Press **OK** button to continue. Use **Up** or **Down** button to select **Date/Time** and then press **OK** button to continue.

Sources

Enables or disables selected source options. Press **MENU** button and select **Settings** by using **Left** or **Right** button. Press **OK** button to continue. Use **Up** or **Down** button to select **Sources** and then press **OK** button to continue.

Other Settings

Press **MENU** button and select settings by using Left or Right button. Press **OK** to continue. Use Up or Down to select other settings and then press **OK** to continue. Using this menu you can adjust the preferred language settings.

Displays other setting options of the TV set.

Using a Conditional Access Module

The Common Interface Slot, situated on the side of the television, enables the insertion of a CAM (Conditional Access Module) and card. These are purchased from a service provider and allow additional subscription broadcasts to be viewed. For more information, see a service provider.

IMPORTANT: Insert or remove the CI module only when the TV is SWITCHED OFF.

- In order to watch certain digital channels, a conditional access module (CAM) is necessary. This module must be inserted in the CI slot of your TV.
- Obtain the Conditional Access Module (CAM) and the viewing card by subscribing to a pay channel company, then insert those to the TV using the following procedure.
- Insert the CAM and then the viewing card to the slot that is located in the terminal cover at the rear side of the TV.

Setting Timers, Setting Date/Time

- The CAM should be correctly inserted, it is impossible to insert fully if reversed. The CAM or the TV terminal may be damaged if the CAM is forcefully inserted.

Connect the TV to the mains supply, switch on and then wait for few moments until the card is activated.

- When no module is inserted, "No Common Interface module detected" message appears on the screen.
- Refer to the module instruction manual for details of the settings.

Viewing Conditional Access Menu (*)

(*) These menu settings may change depending on the service provider.

Press **MENU** button and select the Settings icon by using **Left** or **Right** button. Press **OK** button to view Settings menu. Use **Up** or **Down** button to highlight **Conditional Access** and press **OK** to view menu items.

Timers

Sets timers for selected programmes. Press **MENU** button and select **Settings** by using **Left** or **Right** button. Press **OK** button to continue. Use **Up** or **Down** button to select **Timers** and then press **OK** button to continue.

Setting Sleep Timer

The television can be set to turn itself Off after a certain length of time.

- Highlight Sleep Timer by using **Up** or **Down** button.
- Use **Left** or **Right** button to set. The timer can be programmed between **Off** and **2.00** hours (120 minutes) in steps of 30 minutes.

Setting Programme Timers

This feature will set the television to go to a specific channel at a certain time. It can be used to view a particular programme, or by setting the mode to daily or weekly, can be used to view a series of programmes.

Press **Down** button to set timers on an event. Programme timer function buttons will be displayed on the screen.

Adding a Timer

- Press **YELLOW** button on the remote control to add a timer. The following menu appears on the screen:

Channel: Changes channel by using **Left** or **Right**.

Timer/Record Type: This feature is unavailable to be set.

Date: Enter a date using the numeric buttons.

Start: Enter a starting time using the numeric buttons.

End: Enter an ending time using the numeric buttons.

Duration: Displays duration between the starting and ending time.

Repeat: Sets a timer to be repeated as Once, Daily or Weekly. Use **Left** or **Right** buttons to select an option.

Change/Delete: Controls parental settings on timers.

- Press **GREEN** button to save the timer. Press **RED** button to cancel.

Editing a Timer

- Select the timer you want to edit by pressing **Up** or **Down** button.
- When finished with editing, press **GREEN** button to save. You can press **MENU** button to cancel.

Deleting a Timer

- Select the timer you want to delete by pressing **Up** or **Down** button.
- Press **RED** button.
- Select **YES** by using **Left** or **Right** buttons to delete the timer. Select **NO** to cancel.

Configuring Date/Time Settings

You can configure date/time preferences by using this menu screen.

- Select **Date/Time** in the Settings menu to configure Date/Time settings. Press **OK** button.

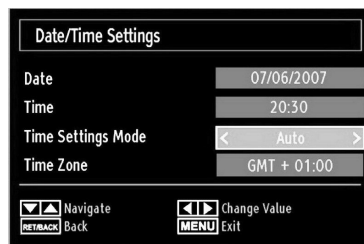

- Use **Up** or **Down** buttons to highlight an option.
- Use **Left** or **Right** buttons to change a setting and press **MENU** to exit.

Source Settings, Other Controls

Configuring Source Settings

You can enable or disable selected source options. The TV will not switch to the disabled source options when **SOURCE** button is pressed.

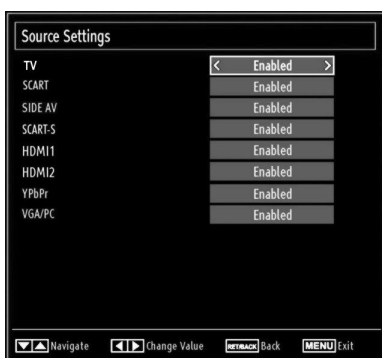

- Select **Sources** in the Settings menu and press **OK** button.
- Press **Up** or **Down** buttons to select a source.
- Use **Left** or **Right** button to enable or disable the selected source. Changes are automatically stored.

Input Selection

Use the Input Selection window if the television does not switch over to a connected source automatically.

- Press **SOURCE** button on your remote control for directly changing sources. Select settings tab and then use Up or Down to select Source. Press **OK** button. Use then Up or Down button to highlight an input and press Right button to select.

Configuring Other Settings - General

You can configure the settings of your TV. Select Configuration from Setup menu and press **OK** to view this menu. Press the **RETURN** button on the remote control to exit.

To view general configuration preferences, select **Other Settings** in the Settings menu and press **OK** button.

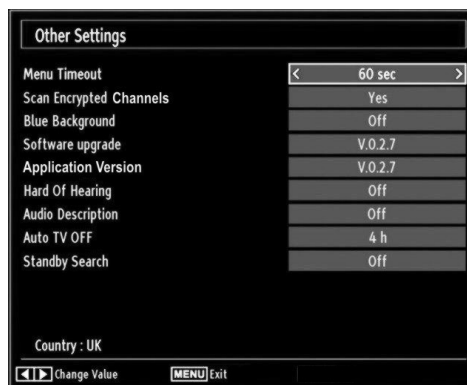

Operation

- Press **Up** or **Down** buttons to select an item.
- Use **Left** or **Right** button to set an option.
- Press **OK** button to view a sub-menu.

Menu Timeout

Press **MENU** button and select **Settings** by using **Left** or **Right** button. Press **OK** button to continue. Use **Up** or **Down** button to select **Other Settings** and then press **OK** button. Select **Menu Timeout** using **Up** or **Down** button and use **Left** or **Right** button to set a specific display timeout for menu screens.

Scan Encrypted Channels

Press **MENU** button and select settings by using **Left** or **Right** button. Press **OK** to continue. Use **Up** or **Down** to select others settings and then press **OK**. Select **Scan Encrypted** using **Up** or **Down** buttons and use **Left** or **Right** to set. When this setting is on, search process will locate the encrypted channels as well. If it is set as **OFF** manually, encrypted channels will not be located while in automatic search or manual search. **Scan Encrypted Channel** feature will always be **ON** after performing first time installation.

Other Controls

Application Version

Displays the current application version.

Blue Background

Press **MENU** button and select settings by using Left or Right button. Press **OK** to continue. Use Up or Down to select others settings and then press **OK**. Select Blue Background using Up or Down buttons and use Left or Right to set. If the signal is weak or absent, the TV will automatically change to a blue screen. To enable this, set Blue Background to On.

Software Upgrade

This feature helps to keep your TV updated. It works automatically and searches for new information when available. Note that this setting is inactive to be modified.

To ensure that your TV always has the most update information, you can use this setting. In order for the proper operation, please ensure that the TV is set to standby mode.

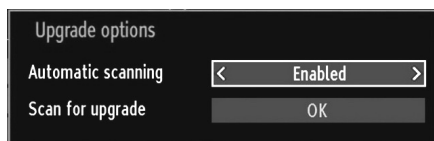

You can enable or disable automatic upgrade by setting **Automatic Scanning** option.

You can manually search for new software by selecting **Scan for upgrade**.

Hard of Hearing

Press **MENU** button and select settings by using Left or Right button. Press **OK** to continue. Use Up or Down to select others settings and then press **OK**. Select Hard of Hearing using Up or Down buttons and use Left or Right to set. If the broadcaster enables any special signal concerning the audio, you can set this setting as On to receive such signals.

Audio Description

Press **MENU** button and select settings by using Left or Right button. Press **OK** to continue. Use Up or Down to select others settings and then press **OK**. Select Audio Description using Up or Down buttons.

Audio description refers to an additional narration track for blind and visually impaired viewers of visual media, including television and movies. The description narrator talks through the presentation,

describing what is happening on the screen during the natural pauses in the audio (and sometimes during dialogue, if deemed necessary). You can use this feature, only if the broadcaster supports that additional narration track.

Auto TV Off

Press **MENU** button and select settings by using Left or Right button. Press **OK** to continue. Use Up or Down to select others settings and then press **OK**. Select Auto TV Off using Up or Down buttons. You can set the timeout value of auto off feature. After the timeout value is reached and the TV is not operated for selected time, the TV will go off.

Standby Search (*)

() This setting is visible only when the Country option is set to Denmark, Sweden, Norway or Finland.*

Press **MENU** button and select settings by using Left or Right button. Press **OK** to continue. Use Up or Down to select others settings and then press **OK**. Select Standby Search using Up or Down buttons and use Left or Right to set.

If the Standby Search is set to on and the TV is in standby mode, the TV will look for any changes in the saved channels.

Full Mode (optional)

If you connect a device via HDMI or YPbPr connectors and set 1080i/1080p resolutions, Full Mode item will be visible.

HDMI True Black (optional)

While watching from HDMI source, this feature will be visible in the Picture Settings menu.

Press **MENU** button and select settings by using Left or Right button. Press **OK** to continue. Use Up or Down to select others settings and then press **OK**. Select HDMI True Black using Up or Down buttons and use Left or Right to set.

You can use this feature to enhance blackness in the picture. You can set this feature as "On" for activating HDMI True Black mode.

Note: HDMI True Black On/Off feature functions only when the HDMI device output is set to RGB.

USB Media Browser

This TV allows you to enjoy photo, video or music files stored on a USB device.

Manual Start

- To display Media Browser window, you can press **MENU** button on the remote control and then select **Media Browser** by pressing **Left** or **Right** button.
- Press **OK** button to continue. Media Browser menu contents (depending on the contents of your USB drive) will be displayed.

Auto Start

- When you plug a USB device, the following menu will be displayed.



You can play music, picture and video files from a USB memory.

- To display All files in a list, select Settings tab and change View Style to Folder. Then go back to main media browser screen and you will see that now All tab will be available. Select All tab and press **OK** button.

Note:

Some USB compliant devices may not be supported. If the USB memory is not recognized after power off/on or First Time Installation, plug the USB memory out and power off/on the TV set. Then plug the USB memory in again.

- Do not use a USB Hub.
- You must obtain any required permission from copyright owners to use copyright content.
Toshiba cannot and does not grant such permission.
- Depending on the file size and amount in your USB memory, it may take some time for loading to view. A message will display on-screen when loading files from the USB memory.
- Only limited types of U3 USB device are supported. Therefore, it is suggested not to use U3 USB for playing Media Player.
- Non-supported characters will be replaced with a square (□).

Playing MP3 Files

To play mp3 files from a USB disk, you can use this menu screen.

When you select Music from the main options, available music files will be filtered and listed on this screen.



- Use **Up** or **Down** button to highlight a file.
- Use **Numeric Buttons** to jump to the previous or next file to play.
- Use **RED** button to stop playback.
- Press **GREEN** button to play all media files in the folder starting with the selected one.
- Press **YELLOW** button to pause a playing file.
- Use **BLUE** button to play the selected file repeatedly or in shuffle mode.
- Press **INFO** button to display filtering options.
- Press **FAV** button to sort files by Title, Artist or Album.
- Press **OK** to play the selected file.
- Use **Left** or **Right** button to jump previous or next file.

USB Media Browser - continued

This TV allows you to enjoy photo, video or music files stored on a USB device.

Viewing JPG Files

To view photo files from a USB Memory, you can use this menu screen. When you select **Photos** from Media Browser, available image files will be filtered and listed on this screen.



If you select a subtitle file and press **OK** button, you can select or deselect that subtitle file. The following menu will be displayed while playing a video file:

- Use **Numeric Buttons** to jump to the previous or next file. Press **OK** to play.
- Press **OK** button to view the selected picture in full screen.
- Press **GREEN** button to start a slideshow.
- Press **BLUE** button to activate loop/shuffle.
- Press **INFO** button to display filtering options.
- Press **FAV** button to sort files by date.
- Press **Menu** button to view thumbnails.

Slideshow Feature

You can use this feature to display photos on your TV.



- Press **RED** button to zoom picture.
- Press **GREEN** button to continue with the slideshow.
- Press **YELLOW** button to pause a playing file.
- Press **BLUE** button to activate loop/shuffle mode.
- Press **Left** or **Right** button to jump to previous or next file of slideshow.
- Use **▲** or **▼** button to rotate the picture.
- Press **INFO** button to activate the operations bar.
- Press **RETURN** to go back.

Video Playback

When you select **Videos** from Media Browser, available video files will be filtered and listed on this screen. You can use **Up** or **Down** button to select a video file and press **OK** button to play a video.

Note: If you set **View Style** from **Media Browser Settings** menu as **'Folder'**, media browser main selection screen will include **ALL** tab as well.



If you select a subtitle file and press **OK** button, you can select or deselect that subtitle file.

- Use **Up** or **Down** button to highlight a file.
- Press **OK** button to start the video playback and play the selected file. Press **GREEN** button to play all.
- The following menu will be displayed while playing a video file:

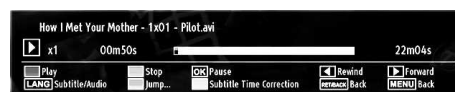

- Press **BLUE** button to stop the video playback.
- Press **OK** button to pause the video playback.
- Press **LEFT** button to go backward.
- Press **RIGHT** button to go forward.
- Use **LANG** button to set subtitle/Audio.
- Use **GREEN** button to jump to a time.
- Use **YELLOW** button to Open subtitle time correction menu



USB Media Browser - continued

This TV allows you to enjoy photo, video or music files stored on a USB device.

Note:

You can set subtitles by using **OK** button before starting the playback or by using **LANG** button during the playback. Selected subtitles may not be displayed correctly in some cases.

In order to display movie subtitles correctly, you should set a "Movie Subtitle" language. See the section, "Movie Subtitle" in "Language Settings" for selecting Movie Subtitle language.

- Press **BACK** button to switch back to previous menu.

Media Browser Settings

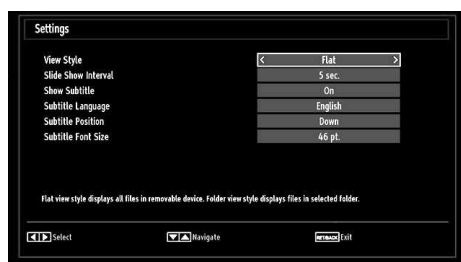

You can set your Media Browser preferences by using the Settings dialog. Press "▼" or "▲" button to highlight an item and use "◀" or "▶" button to set.

View Style: Sets default browsing mode.

Slide Show Interval: Sets slide show interval time.

Show Subtitle: Sets subtitle enabling preference.

Subtitle Language: Sets supported subtitle language.

Subtitle Position: Sets subtitle position as up or down.

Subtitle Font Size: Sets subtitle font size (max. 54pt).

To Close the Media Player

- Press **MENU** button on the remote control.

Analogue Text Services





This television has a multi-page text memory, which takes a few moments to load.

Analogue Text Services

Before using the text services, the required language region must be chosen.

- Select **Language** from the **SETTINGS** menu.
- Press the **Left** or **Right** button to choose the required language region.
- After the teletext language is selected, press **MENU** button to exit.

Using Text Button -TEXT

- To view text services press . Press  again to superimpose text over a normal broadcast picture.
- Press  again to return to normal viewing.
- Programmes cannot be changed until text is cancelled.
- The first text page shown will be the initial page.
- Any text page can be accessed by entering the 3 digit page number using the numbered buttons, pressing the coloured buttons or pressing  to advance to the next page and  to go back to the previous page.
- Four coloured titles will appear at the base of the screen. To access one of the four given subjects, press the relevant coloured button on the remote control.
- For further information on your particular text system(s), see the broadcast text index page or, consult your local Toshiba dealer.

Below is a guide to the functions of the remote control text buttons.

Accessing Sub-Pages

If a text page has sub-pages, press  and enter the sub-page numbers 01,02,03 etc. which can be selected using **Left/ Right** buttons at the bottom of the text page under the coloured links.

Revealing Concealed Text

To discover the solutions on quiz and joke pages press the **INFO** button.

Holding a Page

At times it is convenient to hold a page of text. Press **OK** and **HOLD** will appear in the top left of the screen. The page will be held on screen until the button is pressed again.

To display an initial page

Press **INFO** to access an initial page. The one displayed is dependant on the broadcaster.

Appendix A: PC Input Typical Display Modes

The following table is an illustration of some of the typical video display modes. Some, due to the display native resolution, are scaled automatically to enable correct image to be displayed.

Your TV may not support different resolutions. Supported resolution modes are listed below.

If you switch your PC to an unsupported mode, a warning OSD will appear on the screen.

Index	Resolution	Frequency
1	640x350	85 Hz
2	640x400	70 Hz
3	640x480	60Hz-66Hz-72Hz -75Hz-85Hz
4	800x600	56Hz-60Hz-70Hz-72Hz -75Hz-85Hz
5	832x624	75 Hz
6	1024x768	60Hz-66Hz-70Hz-72Hz -75Hz
7	1152x864	60Hz-70Hz-75Hz -85 Hz
8	1280x768	60 HzA
9	1280x768	60 HzB
10	1280x768	75Hz-85Hz
11	1280x960	60Hz-75Hz-85Hz
12	1280x1024	60Hz-75Hz-85Hz
13	1360x768	60 Hz
14	1400x1050	60 HzA
15	1400x1050	60 HzB
16	1400x1050	75Hz-85Hz
17	1400x900	65Hz-75Hz
18	1600x1200	60 Hz
19	1680x1050	60 Hz
20	1920x1080	60 HzA
21	1920x1080	60 HzB
22	1920x1200	60HzA
23	1920x1200	60Hz

Appendix B: AV and HDMI Signal Compatibility (Input Signal Types)

Source	Supported Signals	
EXT (SCART)	PAL 50/60	
	NTSC 60	
	RGB 50	
	RGB 60	
Side AV	PAL 50/60	
	NTSC 60	
YPbPr	480i	60Hz
	480p	60Hz
	576i	50Hz
	576p	50Hz
	720p	50Hz
	720p	60Hz
	1080i	50Hz
	1080i	60Hz
	1080p	50Hz
	1080p	60Hz
HDMI1 HDMI2	480i	60Hz
	480p	60Hz
	576i	50Hz
	576p	50Hz
	720p	50Hz
	720p	60Hz
	1080i	50Hz
	1080i	60Hz
	1080p	24Hz
	1080p	25Hz
	1080p	30Hz
	1080p	50Hz
1080p	60Hz	

Note: In some cases a signal on the LCD TV may not be displayed properly. The problem may be an inconsistency with standards from the source equipment (DVD, Set-top box, etc.). If you do experience such a problem please contact your dealer and also the manufacturer of the source equipment.

Appendix C: Supported File Formats for USB Mode

Media	File Extension	Format		Remarks (Maximum resolution/Bit rate etc.)
		Video	Audio	
Movie	.mpg, .mpeg	MPEG1, 2	MPEG Layer 1/2/3	MAX 1920x1080 @ 30p 20Mbit/sec
	.dat	MPEG1, 2	MPEG2	
	.vob	MPEG2		
	.avi	MPEG2	PCM/MP3	MAX 1920x1080 @ 30p 20Mbit/sec
	Xvid 1.00, Xvid 1.01, Xvid 1.02, Xvid 1.03, Xvid 1.10-beta1/2	PCM		
Music	.mp3	-	MPEG 1 Layer 1 / 2 (MP3)	32kbps ~ 320kbps(Bit rate) 32kHz ~ 48kHz(Sampling rate)
Photo	.jpg .jpeg	Baseline JPEG		max WxH = 15360x8640 4147200bytes
		Progressive JPEG		max WxH = 1024x768 6291456bytes
	.bmp	-		max WxH = 9600x6400 3840000bytes
Subtitle	.sub	-		-
	.srt	-		

Appendix D: PIN Information

Before connecting any external equipment, turn off all main power switches. If there is no switch, remove the mains plug from the wall socket. Signal information for Mini D-sub 15 pin connector

Pin No.	Signal name	Pin No.	Signal name	Pin No.	Signal name
1	R	6	Ground	11	NC
2	G	7	Ground	12	NC
3	B	8	Ground	13	H-sync
4	NC*	9	NC	14	V-sync
5	NC	10	Ground	15	NC

* NC = not connected

Specifications and Accessories

Broadcast Systems/Channels

DVB-T, MPEG2

Video Input PAL, SECAM, NTSC 4.43

Stereo Nicam

External Connections

1-SCART 1	Input	21-pin SCART	RGB, A/V
2-SCART-S (via SCART 1)	Input	21-pin SCART	S-Video
3-YPbPr (via VGA)	Input	Mini D-Sub 15-Pin Analogue	
4-SIDE AV	Input	Side AV Cable input	Video + Audio L + R
5-HDMI	Input	Type A	
6-PC	Input	Mini D-Sub 15-Pin Analogue	RGB Signal
7-Digital Audio	Output	S/PDIF	(Coaxial)
8-YPbPr	Input	YPbPr Connection Jack	
USB Port	Media Browser Interface Version: USB 2.0		
	USB Class: Mass Storage		
	File System: FAT32		

Headphone Socket 3.5mm stereo

Operating Conditions Temperature 5°C - 35°C (41°F - 94°F)
Humidity 20 - 80% (non-condensing)

Supplied Accessories
Remote Control
2 batteries (AAA, IEC R03 1.5V)
Four screws
Side AV Connection Cable
YPbPr Connection Cable
Stand fixing cover
P Clip

32BL505B	
Energy Efficiency Class	A
Visible Screen Size (approx.)	80cm / 32"
On Mode Power Consumption (approx.)	37W
Annual Power Consumption (approx.)	54 kWh
Standby Power Consumption (approx.)	< 0.50 W
Screen Resolution (pixels)	1366 x 768
Display	16:9
Sound Output (at 10% distortion)	2 x 6
Power Consumption Model (approx.)	135W
Weight	
TV with stand	11.5
Gross weigh	14
TV without stand	10

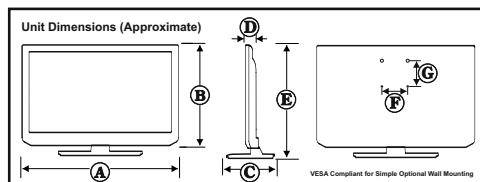

	A (mm)	B (mm)	C (mm)	D (mm)	E (mm)	F (mm)	G (mm)
32BL505B	769.7	487.8	204.80	39.5	527.2	200	100



License Information

- HDMI, the HDMI logo, and High-Definition Multimedia Interface are trademarks or registered trademarks of HDMI Licensing LLC in the United States and other countries.
- DVB is a registered trademark of the DVB Project.
- [1] EIA/CEA-861-D compliance covers the transmission of uncompressed digital video with high-bandwidth digital content protection, which is being standardized for reception of high-definition video signals. Because this is an evolving technology, it is possible that some devices may not operate properly with the television.

MP3 licence letter

MPEG Layer-3 audio coding technology licensed from Fraunhofer IIS and Thomson.

AVC licence letter

THIS PRODUCT IS LICENSED UNDER THE AVC PATENT PORTFOLIO LICENSE FOR THE PERSONAL AND NON-COMMERCIAL USE OF A CONSUMER TO (I) ENCODE VIDEO IN COMPLIANCE WITH THE AVC STANDARD ("AVC VIDEO") AND/OR (II) DECODE AVC VIDEO THAT WAS ENCODED BY A CONSUMER ENGAGED IN A PERSONAL AND NON-COMMERCIAL ACTIVITY AND/OR WAS OBTAINED FROM A VIDEO PROVIDER LICENSED TO PROVIDE AVC VIDEO. NO LICENSE IS GRANTED OR SHALL BE IMPLIED FOR ANY OTHER USE. ADDITIONAL INFORMATION MAY BE OBTAINED FROM MPEG LA, L.L.C. SEE [HTTP://WWW.MPEGLA.COM](http://www.mpegla.com)



Cleaning the screen and cabinet...
Turn off the power, clean the screen and cabinet with a soft, dry cloth. We recommend that you do not use any proprietary polishes or solvents on the screen or cabinet as this may cause damage.

Disposal...

The following information is only for EU-member states:

Disposal of products
The crossed out wheeled dust bin symbol indicates that products must be collected and disposed of separately from household waste. Integrated batteries and accumulators can be disposed of with the product. They will be separated at the recycling centres.
The black bar indicates that the product was placed on the market after August 13, 2005.
By participating in separate collection of products and batteries, you will help to assure the proper disposal of products and batteries and thus help to prevent potential negative consequences for the environment and human health.
For more detailed information about the collection and recycling programmes available in your country, please contact your local city office or the shop where you purchased the product.

Disposal of batteries and/or accumulators
The crossed out wheeled dust bin symbol indicates that batteries and/or accumulators must be collected and disposed of separately from household waste.
If the battery or accumulator contains more than the specified values of lead (Pb), mercury (Hg), and/or cadmium (Cd) defined in the Battery Directive (2006/66/EC), then the chemical symbols for lead (Pb), mercury (Hg) and/or cadmium (Cd) will appear below the crossed out wheeled dust bin symbol.
By participating in separate collection of batteries, you will help to assure the proper disposal of products and batteries and thus help to prevent potential negative consequences for the environment and human health. For more detailed information about the collection and recycling programmes available in your country, please contact your local city office or the shop where you purchased the product.

In conformity with the EEE Regulation.

Questions and Answers

Q *Why is there no sound or picture?*
A Check the TV is not in standby mode.
Check the mains plug and all mains connections.

Q *Why is there a picture but no sound?*
A Check the volume has not been turned down or that sound mute has not been selected.

Q *What can cause a poor picture?*
A Interference or a weak signal. Try a different TV station.

Q *Why doesn't the video/DVD being played show on screen?*
A Make sure the VCR or DVD player is connected to the TV as illustrated in the beginning chapters, then select the correct input by pressing SOURCE .

Q *Why is the VCR/DVD picture in black and white?*
A Check the correct **input** has been chosen.

Q *Why is there a good video picture but no sound?*
A Check the SCART lead connection.

Q *Why doesn't the remote control work?*
A Check the batteries aren't exhausted or inserted incorrectly.

Q *Why don't the controls of the TV work?*
A Check that **CHILD LOCK** is not selected.

Q *Why is the sound only coming from one speaker when stereo sound is selected?*
A Check that the balance in the **SOUND** menu hasn't been set to one side.

Q *Why are there problems with analogue text service?*
A Good performance of the analogue text depends on a good strong broadcast signal. This normally requires a roof or loft aerial. If the text is unreadable or garbled, check the aerial. Go to the *main index* page of the analogue text service and look for the *User Guide*.

Q *What is DVB-T?*
A Digital Video Broadcast via an aerial/antenna.

Q *How are radio channels selected?*
A You can select them via the Channel List.

Q *What can be done if the PIN number has been forgotten?*
A You can reset TV and perform first time installation. Ensure that no-one else can use this by removing the Owner's Manual.

Q *Why are there horizontal stripes and/or blurred images on the screen when in PC mode?*
A The Phase may need adjustment. Select PC Settings and highlight Phase and adjust until the picture is clear.



Questions and Answers

Below are the answers to some of the most common queries. For more information go to www.toshiba.co.uk

Q *Why doesn't the Media Browser feature operate?*

A Make sure that USB is connected correctly. Incorrect behaviour may occur with a USB Hub connection.

Q *Why is the digital channel locked?*

A Parental control is activated. Check parental settings.

Q *Why are some encrypted digital channels unavailable?*

A Your subscription needs upgrading. Contact your service provider.

Q *Why when digital subtitles have been selected are they not showing on screen?*

A Subtitles are not currently being transmitted by the broadcaster.

Q *Why is the soundtrack in English when a different audio language has been selected?*

A The programme is currently being broadcast with an English soundtrack only.

Q *Why does the active standby LED sometimes take longer to go out?*

A When put into standby the television's active standby will automatically search all available channels for downloads, provided Automatic Download is enabled. The time it takes to do this may vary.



EU Conformity Statement



"This product is marked with "CE" and complies therefore with the applicable harmonized European standards listed under the Low Voltage Directive 2006/95/EC and the EMC Directive 2004/108/EC."

Responsible for CE-marking is TOSHIBA INFORMATION SYSTEMS (U.K.) LTD,
Toshiba Court, Weybridge Business Park, Addlestone Road, Weybridge,
Surrey, KT15 2UL, United Kingdom



Toshiba One (1) Year Limited Warranty For TV's (the "Products")

1. THE TERMS OF THIS WARRANTY DO NOT AFFECT YOUR STATUTORY RIGHTS.
2. Your Product is warranted to be free from defects in material and workmanship arising under normal use and service, for one (1) year from the date of original purchase when brand new ("Warranty Period").
3. If a failure or defect covered by the warranty arises and a valid claim is received by Toshiba within the Warranty Period, Toshiba shall at its option and to the extent permitted by law, repair or replace the machine or any components free of charge or refund the purchase price of the Product.
4. This warranty is valid ONLY in relation to the Product for which your warranty has been registered. It is the Product that is warranted rather than the owner.
5. Toshiba, its authorised resellers ("Authorised Resellers") and authorised service providers ("Authorised Service Providers") reserve the right to request proof of purchase (e.g. a paid and dated invoice) showing model and serial number before providing any warranty confirmation.
6. Any Product or component repaired or replaced under the warranty shall be subject to the balance of the original Warranty Period applying to the Product or component, or three months from the date of replacement or repair, whichever is the greater. All Products and components replaced under warranty shall become Toshiba's property. Where a refund is given, the Product for which the refund is provided must be returned to Toshiba and becomes Toshiba's property.
7. This warranty shall not apply: a) to extrinsic cause or cosmetic damage, including but not limited to scratches and dents; b) to damage caused by use with non-Toshiba products; c) to damage caused by accident, abuse, misuse, liquid spill or submersion, flood, fire, earthquake or other external causes; d) to damage caused by operating the product outside the permitted or intended uses described by Toshiba; e) to a product or part that has been modified to alter functionality or capability without the written permission of Toshiba or f) to any failure or defect attributable to any neglect or wear and tear. This also applies to the hardware casing. Should you claim a repair that is not covered under the warranty terms, any of Toshiba, Authorised Reseller or the Authorised Service Provider may charge you the costs of the repair.
8. This warranty shall be inapplicable if failure of the Product or component has resulted from service, maintenance or repair other than by Toshiba, an Authorised Reseller or Authorised Service Provider, or if the Product or component labels/serial numbers have been altered or obscured.
9. Toshiba shall not be liable for any transport/delivery costs incurred in returning the Product or components to an Authorised Reseller or Authorised Service Provider in support of a warranty claim.
10. Except for the express warranty provided, Toshiba, its Authorised Resellers or Authorised Service Provider do not issue any warranty or guarantee for your Product.
11. Toshiba expressly disclaims and excludes all conditions, warranties and other terms with regard to the Product, including, but not limited to, in every case whether express or implied by statute, common law, custom, collaterally or otherwise, to the fullest extent permitted by applicable law. In particular, but without limit to the generality of the foregoing exclusion, any conditions, warranties and other terms as to merchantability, satisfactory quality, fitness for a particular purpose, hidden or latent defects, ownership of any software, as to price and / or non-infringement of third party rights are excluded whether in contract or tort. Any implied warranties that may be imposed by applicable law are limited in duration, subject to such applicable law, to the term of the express limited warranty given by Toshiba. No Toshiba reseller, agent or employee is authorised to make any modification, extension or addition to this warranty. If any term is held to be illegal or unenforceable, the legality or enforceability of the remaining terms shall not be affected or implied.
12. Also, Toshiba does not warrant that operation of the Product will be uninterrupted or error free. You must read and follow all set-up and usage instructions in the Product safety instruction and user's manuals, as provided. If you fail to do so, the Product may not function properly. Even if you follow the instructions, Toshiba does not warrant that compliance with the instructions in the above manuals will ensure that the Product will function properly in all circumstances.
13. To the maximum extent permitted by applicable law, and except as provided herein in no event shall Toshiba, Authorised Resellers, Authorised Service Providers or Toshiba's supplier be liable for any direct, special, incidental or consequential damages resulting from any breach of warranty, condition, strict liability or tort or under any other legal theory, including but not limited to loss of use; loss of revenue; loss of actual or anticipated profits (including loss of profits on contracts); loss of the use of money; loss of anticipated savings; loss of business; loss of opportunity; loss of goodwill; loss of reputation; loss of, damage to or corruption of data; or any indirect or consequential loss or damage howsoever caused including the replacement of equipment and property. The foregoing limitation applies even if Toshiba, Authorised Resellers, Authorised Service Providers or Toshiba's supplier, have been advised of the possibility of such damages or of any claim by any third party. In any event, any liability of Toshiba Authorised Resellers, Authorised Service Providers or Toshiba's supplier which is not excluded shall be limited to the purchase price of the Product. However, Toshiba shall accept liability for personal injury or death caused by or arising from its negligence or from fraudulent misrepresentation and as otherwise required by applicable law.
14. This warranty shall be governed by and construed in accordance with the laws of England and Wales. You agree to submit to the exclusive jurisdiction of the courts of England over any claim, matter or dispute arising under or in connection with this warranty (including as to its validity) or the legal relationships established by this warranty.

NOTE - Toshiba reserves the right to alter or cancel this program at any time without prior notice.

- 48 -

If you wish to view the advanced functions but do not have access to a computer or the internet then please contact your nearest owner's manual Helpline number from the numbers shown below.

Country name locally	Contact Number
Österreich	0810 - 144 122 (7,3 ct/min aus dem Festnetz der Telekom Austria, Mobil ggf. abweichend)
Belgique / Belgie	02 391 01 01
България	0294 21141
Hrvatska	01 653 9737
Κύπρος	22 872 111
Česká republika	323 204191
Danmark	80 88 93 38
Eesti Vabariik	69 97 800
Suomen tasavalta	0800 77 35 03
France	09 69 32 64 84
Deutschland	0431 24 89 45 50 (Ortsstarif, abweichender Mobilfunktarif möglich)
Gibraltar	200 76334
Ελληνική	210 9554298
Magyar Köztársaság	23 428 870
Ísland	00 45 80 88 93 38
Yisrâ'el	03 953 5900
Italia	039 609 9301
Latvijas	00 372 69 97 800
Lietuvos	00 372 69 97 800
Luxembourg	00 32 2 391 01 01
Moldova	00380 443 511 317
Nederlanden	00 32 2 391 01 01
Norge	800 573 57
Polska	0 71 796 95 05
Portugal	707 265 265
Republic of Ireland	01 246 7780
România	021 3169 393
Россия	8 800 100 05 05
Slovensko	0042 323 204191
España	902 33 22 34
Sverige	0201 70 16 00
Schweiz / Suisse	0900 57 58 58 (CHF 1.49 / Min.)
Türkiye	0 212 340 6080
U.K.	0844 856 0730
Україна	8(044) 351 13 17

Please note the telephone number only applies to advanced owner's manual enquiries and not general operation of the TV.



"Printed on Recycled Paper" "100% Chlorine free"