

**Continental Disc
Corporation**

CLEAN-SWEEP® Technical Product Specifications

2-3307-7

The CLEAN-SWEEP Rupture Disc Assembly provides overpressure relief protection for viscous media processes, particularly where product build-up in a piping system may cause excessive overpressure conditions.

For many years, pipe tees were used in process lines with the rupture disc assembly installed off the leg of the tee. However, viscous product build-up could affect the proper operation and accuracy of the rupture disc.

Continental Disc Corporation developed the CLEAN-SWEEP Assembly to eliminate the dead space of a pipe tee assembly, as well as the pressure, temperature, and material availability limitations caused by older, diaphragm valve body-based designs.

The NEW CLEAN-SWEEP Rupture Disc Assembly offers significant design improvements over previous designs (see diagram at right). The body casting of the CLEAN-SWEEP Assembly is specifically designed for a rupture disc.

The CLEAN-SWEEP Rupture Disc Assembly permits the rupture disc to be installed directly on the body casting, adjacent to the process flow. Compared to other designs, it requires fewer joints to be sealed and greatly reduces the possibility of product build-up (dead space) under the rupture disc.

Designed for operating pressures up to 1440 psig (99,3 barg), the CLEAN-SWEEP Assembly is custom machined to bolting classes of ANSI, DIN, JIS or as specified by the customer. Alignment pins in the assembly inlet provide correct rupture disc orientation during installation. Once installed, the 3-Dimensional Flow Direction Tag, which is permanently attached to the rupture disc, is a visual reference that the rupture disc will discharge in the intended flow direction.

The CLEAN-SWEEP Assembly body is available in standard materials of 316 Stainless Steel, Monel®, or Hastelloy C®. The rupture disc holder outlet and outlet companion flange are available in materials of Carbon Steel, Monel, Inconel®, Nickel, 316 Stainless Steel, or Hastelloy C.

A permanently attached nameplate with flow direction indication is supplied on the CLEAN-SWEEP assembly. Whenever specific identification tagging is required, a stainless steel customer identification tag is permanently attached at no extra charge.

There are two CLEAN-SWEEP rupture disc assemblies to choose from:

- (CU) CLEAN-SWEEP
- (CR) CLEAN-SWEEP

Both assemblies are described on page 3.

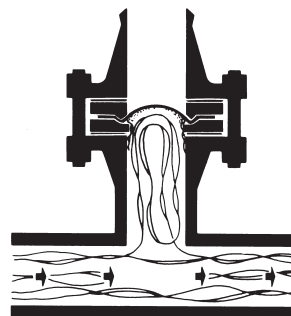
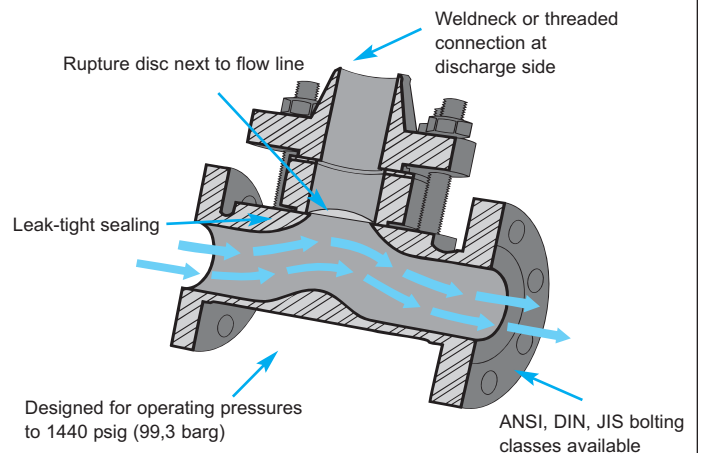
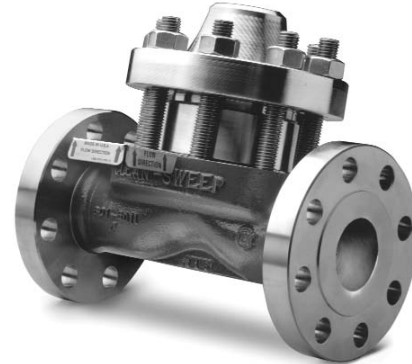

Standard rupture disc assembly installed in a "T" off the flow line. Dead space permits highly viscous product to collect and build up, preventing the rupture disc from sensing overpressure.

*Inconel and Monel are registered trademarks of the Inco family of companies.
Hastelloy is a registered trademark of Haynes International.

Rupture Disc Compatibility

The CLEAN-SWEEP assembly is designed to house either a Composite (CF) or MICRO X® (CF) rupture disc, both of which have a flat seat configuration.

Besides a full, instantaneous opening, the Composite and MICRO X rupture discs provide many outstanding features:

- Excellent corrosion resistance.
- Wide range of burst ratings.
- Smooth surface against the process media.
- Excellent for use in gaseous or liquid service.
- 80% operating-to-burst-pressure ratio.
- Non-fragmenting design (applicable to all MICRO X Rupture Discs, and to Composite Rupture Discs supplied with a non-metallic seal).

Sizes

The MICRO X and Composite flat seat rupture discs manufactured for use with the CLEAN-SWEEP assembly are available in nominal sizes ranging from 1" to 6" (25-150mm). Refer to the MICRO X or Composite Rupture Disc Technical Product Specifications documents (TDB-04 or TDB-02) or CDC Bulletin No. 2-2203-2 for the minimum and maximum burst pressures.

Liners / Coatings

Continental Disc Corporation offers both protective liners and coatings to provide additional protection from the effect of corrosives or product build up which might have on the performance of the rupture disc. Typically, liners are made of Teflon®*. Teflon coating is also used.

Protective Rings

Protective rings may be used with rupture discs made of thin materials or in instances where delicate liners or seals are used. These rings protect the rupture disc from foreign material in the sealing area where holders may be pitted or corroded from extended use.

Gaskets

Gaskets may be used to provide additional sealing and to prevent leakage through the seating area of a scratched or pitted holder. They are located on the process side of the rupture disc and are usually manufactured of Teflon. Other materials are available upon request.

Vacuum Support

Due to the thinness of some rupture disc materials, it is necessary to support a rupture disc when a system vacuum occurs. Continental Disc Corporation provides vacuum supports for Composite and MICRO X rupture discs that will withstand full vacuum. For back pressure conditions higher than 14.7 psig (1 barg), consult the factory.

Tagging / Certification

Every lot of rupture discs manufactured by Continental Disc Corporation is furnished with a BURST CERTIFICATE and permanently attached FLOW DIRECTION TAG stating the manufacturing number, burst rating, temperature rating and any required customer identification information.

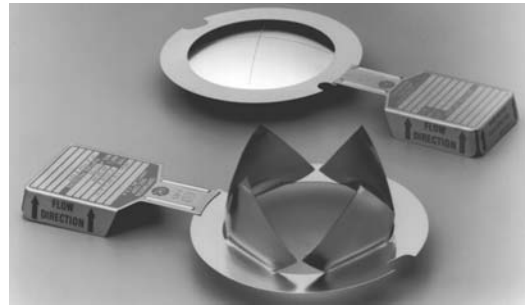

MICRO X (CF) Rupture Disc



Composite (CF) Rupture Disc

Code Compliance

C.D.C. will manufacture, temperature test and mark rupture discs in compliance with the requested code. Product may be supplied to ASME Section VIII, DIN, BSI, JIS, ISO, EN or other codes as required.

Continental Disc Corporation has been accredited and is authorized by the ASME Code to utilize the  Code Symbol Stamp for product built in accordance with the requirements of the ASME Boiler and Pressure Vessel Code, Section VIII, Division 1.

B.D.I.®** (Burst Disc Indicator) Alarm System

Where immediate notification of pressure relief is required, Continental's patented B.D.I. (Burst Disc Indicator) Alarm System should be used. Designed for use with Continental's rupture discs, the B.D.I. Alarm System automatically notifies the operator, via audio and/or visual warnings, that a rupture disc has burst. The B.D.I. Alarm Monitor is available with intrinsically safe signal output and is computer compatible.

Compatible with either the MICRO X or Composite flat seat rupture discs, the Universal B.D.I. is an alarm strip attached to a Teflon membrane and assembled between non-asbestos gaskets.



* Teflon is a registered trademark of E.I. du Pont de Nemours and Company used under license.

** Burst Disc Indicator (B.D.I.) Alarm System incorporates United States patent no.'s Re.34,308 and 4,408,194; Australia patent no. 539415; Canada patent no. 1199990; Germany patent no. 3174227.0; Belgium, France and United Kingdom patent no. EP 0 033 867; Japan patent no. 2032464.

(CU) CLEAN-SWEEP Assembly

For use with moveable discharge piping arrangements.

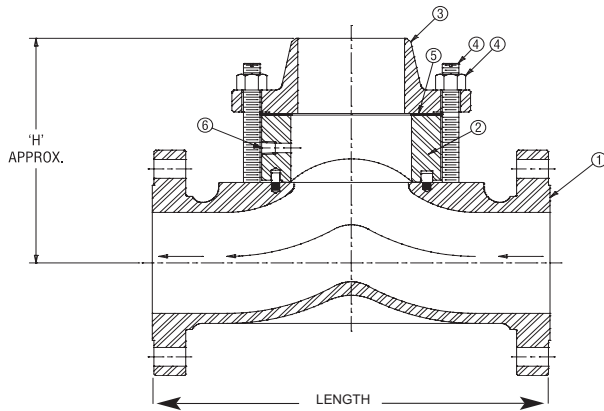

Component Parts:

1. Body casting
2. Holder outlet
3. Outlet companion flange (available in threaded or welded connection)
4. Studs and nuts for outlet bolting
5. Gasket
6. Optional 1/4", 3/8" or 1/2" FPT

(CR) CLEAN-SWEEP Assembly

For use with fixed discharge piping arrangements.

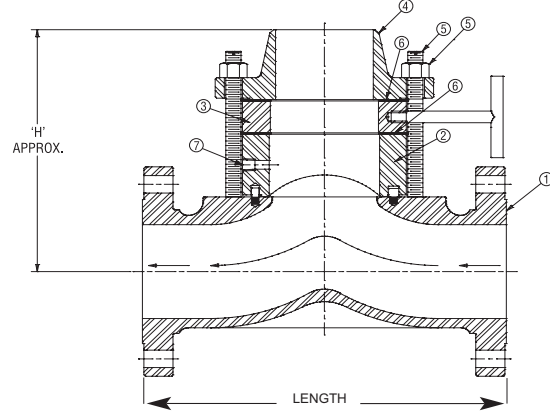

Component Parts:

1. Body casting
2. Holder outlet
3. Spacer ring with handle
4. Outlet companion flange (available in threaded or welded connection)
5. Studs and nuts for outlet bolting
6. Gaskets
7. Optional 1/4", 3/8" or 1/2" FPT

Table I - CLEAN-SWEEP Dimensions and Weights

Size*			CLEAN-SWEEP CU						CLEAN-SWEEP CR						Length of Assembly	
			"H" Dimension Without Spacer						"H" Dimension With Spacer							
			Companion Flange Option		Welded		Threaded		Weight		Companion Flange Option		Welded			
inches	mm	Class*	inches	mm	inches	mm	lbs.	kg.	inches	mm	inches	mm	lbs.	kg.	inches	mm
1"	25	150# ANSI	4.28	108,7	2.78	70,6	18	8,2	5.21	132,3	3.71	94,2	20	9,1	8.75	222,3
1"	25	300/600# ANSI	4.78	121,4	3.40	86,4	25	11,3	5.71	145,0	4.33	110,0	27	12,2	8.75	222,3
1"	25	ND10/40 DIN	3.66	93,0	3.19	81,0	20	9,1	4.59	116,6	4.12	104,6	22	10,0	8.75	222,3
1"	25	10/20K JIS	4.28	108,7	2.78	70,6	21	9,5	5.21	132,3	3.71	94,2	23	10,4	8.75	222,3
1"	25	30/40K JIS	4.78	121,4	3.40	86,4	26	11,8	5.71	145,0	4.33	110,0	28	12,7	8.75	222,3
1-1/2"	40	150# ANSI	4.97	126,2	3.47	88,1	28	12,7	5.90	149,9	4.40	111,8	30	13,6	9.00	228,6
1-1/2"	40	300/600# ANSI	5.53	140,5	4.03	102,4	39	17,7	6.46	164,1	4.96	126,0	42	19,1	9.00	228,6
1-1/2"	40	ND10/40 DIN	4.30	109,2	3.79	96,3	33	15,0	5.23	132,8	4.72	119,9	36	16,3	9.00	228,6
1-1/2"	40	10/20K JIS	4.97	126,2	3.47	88,1	30	13,6	5.90	149,9	4.40	111,8	33	15,0	9.00	228,6
1-1/2"	40	30/40K JIS	5.53	140,5	4.03	102,4	41	18,6	6.46	164,1	4.96	126,0	43	19,5	9.00	228,6
2"	50	150# ANSI	6.01	152,7	4.51	119,6	38	17,2	6.94	176,3	5.44	138,2	41	18,6	10.75	273,1
2"	50	300/600# ANSI	6.64	168,7	5.20	132,1	47	21,3	7.57	192,3	6.13	155,7	51	23,1	10.75	273,1
2"	50	ND10/40 DIN	5.40	137,2	4.85	123,2	41	18,6	6.33	160,8	5.78	146,8	44	20,0	10.75	273,1
2"	50	10K JIS	6.01	152,7	4.51	119,6	39	17,7	6.94	176,3	5.44	138,2	41	18,6	10.75	273,1
2"	50	16/20K JIS	6.64	168,7	5.20	132,1	44	20,0	7.57	192,3	6.13	155,7	47	21,3	10.75	273,1
2"	50	30/40K JIS	6.64	168,7	5.20	132,1	47	21,3	7.57	192,3	6.13	155,7	51	23,1	10.75	273,1
3"	80	150# ANSI	7.43	188,7	5.87	149,1	67	30,4	8.61	218,7	7.05	179,1	72	32,7	13.00	330,2
3"	80	300/600# ANSI	8.19	208,0	6.75	171,5	85	38,6	9.37	238,0	7.93	201,4	92	41,7	13.00	330,2
3"	80	ND10 DIN	6.65	168,9	6.26	159,0	72	32,7	7.83	198,9	7.44	189,0	78	35,4	13.00	330,2
3"	80	ND16/40 DIN	6.96	176,8	6.25	158,8	70	31,8	8.14	206,8	7.43	188,7	76	34,5	13.00	330,2
3"	80	10K JIS	7.43	188,7	5.87	149,1	65	29,5	8.61	218,7	7.05	179,1	70	31,8	13.00	330,2
3"	80	16/20K JIS	8.19	208,0	6.75	171,5	79	35,8	9.37	238,0	7.93	201,4	85	38,6	13.00	330,2
3"	80	30/40K JIS	8.19	208,0	6.75	171,5	85	38,6	9.37	238,0	7.93	201,4	92	41,7	13.00	330,2
4"	100	150# ANSI	8.96	227,6	7.27	184,7	106	48,1	10.39	263,9	8.70	221,0	115	52,2	15.00	381,0
4"	100	300 ANSI	9.34	237,2	7.84	199,1	125	56,7	10.77	273,6	9.27	235,5	135	61,2	15.00	381,0
4"	100	ND10/16 DIN	8.01	203,5	7.70	195,6	94	42,6	9.44	239,8	9.13	231,9	102	46,3	15.00	381,0
4"	100	ND25/40 DIN	8.78	223,0	7.95	201,9	107	48,5	10.21	259,3	9.38	238,3	116	52,6	15.00	381,0
4"	100	16/20K JIS	9.34	237,2	7.84	199,1	108	49,0	10.77	273,6	9.27	235,5	115	52,2	15.00	381,0
4"	100	30K JIS	9.34	237,2	7.84	199,1	114	51,7	10.77	273,6	9.27	235,5	124	56,2	15.00	381,0
6"	150	150# ANSI	11.89	302,0	9.95	252,7	127	57,6	14.07	357,4	12.13	308,1	142	64,4	17.00	431,8
6"	150	300# ANSI	12.27	311,7	10.44	265,2	172	78,0	14.45	367,0	12.63	320,8	197	89,4	17.00	431,8

* For other sizes or classes consult your Continental Disc Representative or the factory.

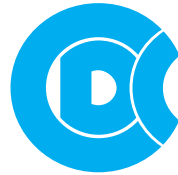

Continental Disc[®] Corporation

Performance Under Pressure[®]

A Siegel-Robert Company



Certified Quality System
First Certified In 1992



ASME Code Symbol Stamp
Available When Specified



China Manufacture License
Available When Specified



Pressure Equipment Directive
Available When Specified

To order a CLEAN-SWEEP Rupture Disc Assembly

CLEAN-SWEEP ASSEMBLY

Quantity _____ Size _____

Rupture disc type _____ Size _____

Materials of construction _____

Rupture disc _____ CLEAN-SWEEP Holder _____

Options Linings _____ Rings _____

Gaskets _____ Vacuum Support _____

Specified pressure _____ Temperature _____

Manufacturing range of rupture disc _____

Does this application require the use of a non-fragmenting disc? YES / NO

OPERATING SPECIFICATIONS

M.A.W.P. _____

Operating Pressure _____

Operating Temperature _____

Vacuum / Backpressure conditions _____

Cycle conditions _____

Required relieving capacity _____

Process media _____

Molecular weight /specific gravity /viscosity _____

ASME Code tests/special cleaning/other _____

Continental Disc Corporation has representatives located throughout the world.
Contact the C.D.C. office nearest you for the authorized representative in your area.

CORPORATE HEADQUARTERS

Continental Disc Corporation
3160 West Heartland Drive
Liberty, Missouri 64068-3385
Phone: + 816-792-1500
FAX: + 816-792-2277
E-mail: pressure@contdisc.com
Website: www.contdisc.com

THE NETHERLANDS

Continental Disc Corporation
Energieweg 20
2382 NJ Zoeterwoude-Rijndijk
The Netherlands
Phone: + (31) 71-5412221
FAX: + (31) 71-5414361
E-mail: cdcnl@contdisc.com

GERMANY

Continental Disc
Deutschland GmbH
Virmondstrasse 151
47877 Willich
Germany
Phone: + (49) 2156-490802
FAX: + (49) 2156-492547
E-mail: cdd@contdisc.com

UNITED KINGDOM

Continental Disc UK Ltd.
Unit C, The Business Centre
Faringdon Avenue,
Harold Hill, Romford
Essex RM3 8EN
United Kingdom
Phone: + (44) 1708-386444
FAX: + (44) 1708-386486
E-mail: cduk@contdisc.com

CHINA

Continental Disc Corporation
2026 The Executive Center
20/F The Center
989 Changle Rd.
Shanghai, 200031
P.R. China
Phone: + (86) 21-5117-5848
Fax: + (86) 21-5117-5849
Mobile: + (86) 137-8897-2291
E-mail: jyang@contdisc.com

DUBAI

Continental Disc Corporation
P.O. Box 2234
Dubai, U.A.E.
Phone: + (971) 43214490
Fax: + (971) 43438840
Mobile: + (971) 508129525
E-mail: kannan@contdisc.com