

**Hamilton Beach®**

# *Humidifier*

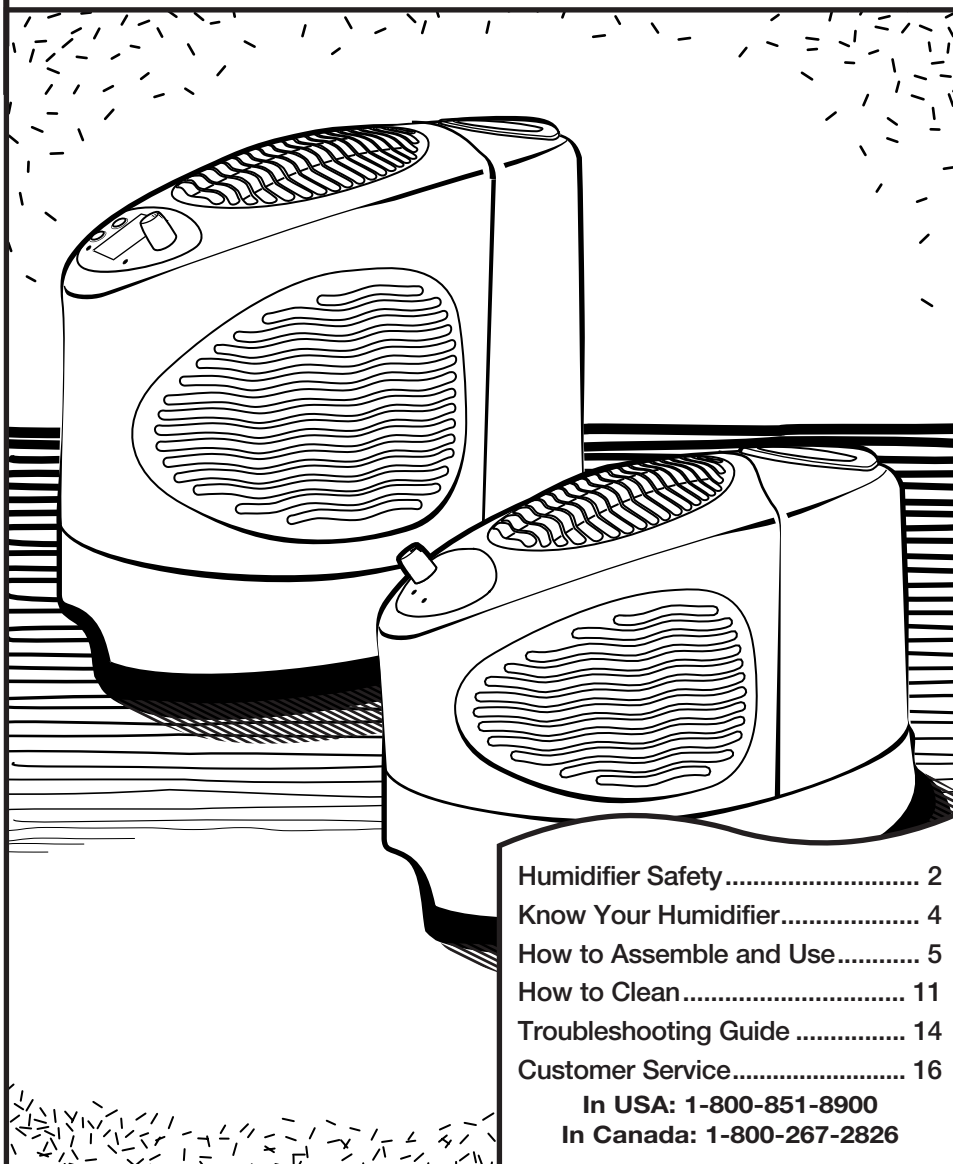

Humidifier Safety.....	2
Know Your Humidifier.....	4
How to Assemble and Use.....	5
How to Clean.....	11
Troubleshooting Guide .....	14
Customer Service.....	16
<b>In USA: 1-800-851-8900</b>	
<b>In Canada: 1-800-267-2826</b>	

840074800

# *Humidifier Safety*

## **IMPORTANT SAFEGUARDS**

### **READ AND SAVE THESE INSTRUCTIONS.**

When using electric appliances, basic safety precautions should always be followed, including the following:

1. Read all instructions before using this humidifier. Save these instructions for reference.
2. Always place the humidifier on a firm, flat, level, water-resistant surface.
3. To reduce the risk of electrical shock, never plug humidifier into an outlet while your hands are wet.
4. Never drop or insert any objects into any openings.
5. Never place the humidifier in a location where it is accessible to children.
6. Do not place the humidifier on or near heat sources such as stoves, radiators, heaters, or in direct sunlight.
7. Never connect the humidifier to any power source other than 120 V AC.
8. Always unplug the humidifier before refilling, cleaning, servicing, or moving.
9. Before each use, check the cord and plug for damage. Do not operate any appliance with a damaged cord or plug, or after the appliance malfunctions or is dropped or damaged in any manner. Call our toll-free customer service number for information on examination, repair or electrical or mechanical adjustment.
10. Always unplug and empty humidifier and tank when it is not in use.
11. Never tilt or attempt to move the humidifier or supporting surface while it is operating or full of water. Turn off and unplug the humidifier before removing the water tank and moving the unit.
12. This humidifier requires regular cleaning and maintenance. Refer to the instructions in the "How to Clean" section. Never clean the humidifier in a manner other than described in this manual.
13. Do not immerse fan enclosure in water or other liquids, or allow it to get wet.
14. Never use detergents, household cleaners, or other solvents to clean the humidifier, other than those specified in the Cleaning Instructions provided in this manual.
15. Do not direct output from unit at walls, furniture, or the like.
16. Do not use filters or other replacement parts not recommended or sold by Hamilton Beach/Proctor-Silex, Inc.
17. To disconnect cord, turn the control to OFF, then remove plug from wall outlet.
18. Do not use appliance for other than its intended purpose.
19. Never stand or sit on any part of the humidifier, and never place objects on the humidifier.

**SAVE THESE INSTRUCTIONS!**

## Consumer Safety Information

---

### **This appliance is intended for household use only.**

This appliance is equipped with a polarized plug. This type of plug has one blade wider than the other. The plug will fit into an electrical outlet only one way. This is a safety feature intended to help reduce the risk of electrical shock.

If you are unable to insert the plug into the outlet, try reversing the plug. If the plug should still fail to fit, contact a qualified electrician to replace the obsolete outlet. Do not attempt to defeat the safety purpose of the polarized plug by modifying the plug in any way.

If a longer cord is necessary an approved extension cord may be used. The electrical rating of the extension cord must be equal to or greater than the rating of the humidifier. Care must be taken to arrange the extension cord so that it will not drape over the countertop or tabletop where it can be pulled on by children or accidentally tripped over.

## Do Not Over-humidify

---

Do not over-humidify. The suggested level for the best health benefit is 50%. Some units can be set for desired humidity ranges from 20 to 90%, but care should be taken not to over-humidify, which will be dependent on both the construction of your home and the outside weather conditions.

Do not allow water to condense on walls, floors, or windows as water damage could result. If you see these conditions occur, lower the desired humidity level on the humidifier or turn the unit off. Hamilton Beach/Proctor-Silex, Inc. will not be responsible for damage caused by water.

## Before First Use

---

Be sure to remove all packing materials. Choose a flat, level, water-resistant location for the humidifier that will allow for good air circulation and that is not accessible to children.

Do not place the humidifier where it or its cord presents a tripping or stumbling hazard, or where the air vents are blocked.

# *Know Your Humidifier*

## **Parts and Features**

---

### **Fan Enclosure**

- 1. Control Panel
- 2. Exhaust Grille
- 3. Cord Wrap (see page 6)
- 4. Air Intake Grilles

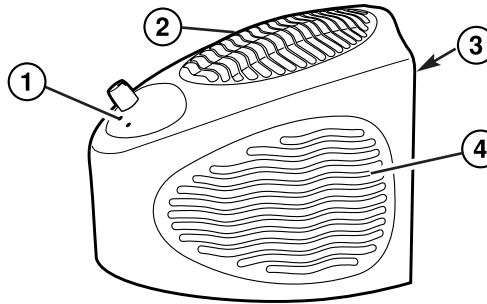

### **Water Tank Assembly**

- 5. Carrying Handle
- 6. Water Tank
- 7. Gasket
- 8. Filler Cap

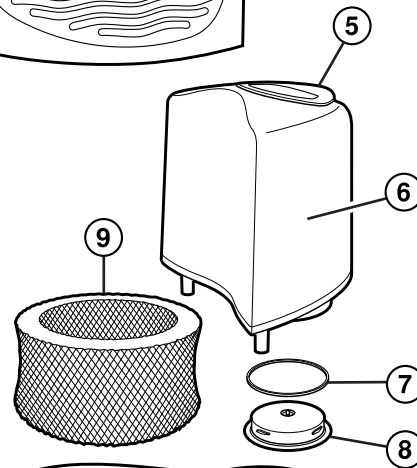

### **Base Assembly**

- 9. Filter
- 10. Water Tray
- 11. Humidifier Base

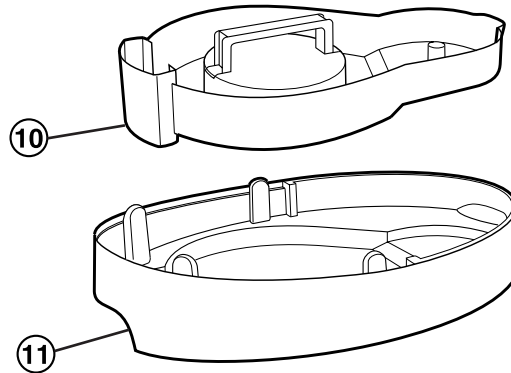

# How to Assemble and Use

**IMPORTANT:** Your Hamilton Beach humidifier is designed for easy use and maintenance. Make sure that the water tray and filter are properly installed before filling the tank and operating the humidifier.

**DO NOT USE THE HUMIDIFIER WITHOUT THE FILTER IN PLACE!**

## Selecting the Proper Location

---

To prevent the risk of injury or damage to the humidifier and furnishings and provide the best possible performance of your humidifier, follow the placement guidelines below:

### DO:

- Place the humidifier on a flat, stable, waterproof surface.

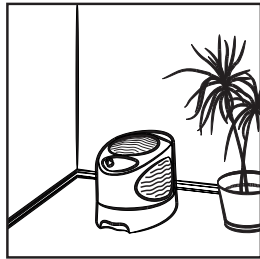

- Place the humidifier along an inside wall near an electrical outlet where it is out of the way and it and its cord do not present a tripping hazard.
- Select a location with adequate air circulation.
- Leave at least six inches (15 cm) between the humidifier and any walls or furnishings. Failure to do so could cause poor air circulation and mildew or moisture damage to walls or furniture.
- Unplug the humidifier and empty the water tank and tray if the humidifier is to be moved, or will not be used for several days.

### DO NOT:

- Do not stand, sit, or place any objects on the humidifier. It is not designed to support additional weight.



- Do not block the air intake and exhaust grilles. This will cause poor performance and may cause moisture damage and mildew build-up.
- Do not use in a small, enclosed space or in an area with a humidity level above 50%. Excessive humidity could result.
- Do not place on or near heat sources such as stoves, radiators, or heaters, or in direct sunlight.
- Never place the humidifier in a closed room. A closed room may result in excessive humidity.
- To reduce electrical noise and interference, do not place on or near, or plug into the same outlet as, TVs, baby monitors, or cordless phones.

## Humidifier Assembly

---

1. Insert the water tray into the humidifier base. Be sure that it is securely seated in the indent in the base.

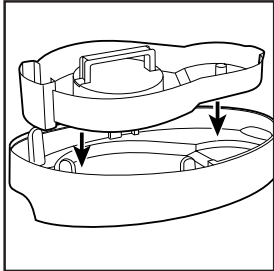

Be sure that it is securely seated in the indent in the base.

2. Place the filter on the water tray as shown.

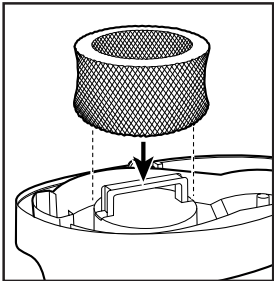

3. Slide the cord through the notch at the bottom of the cord wrap compartment. Excess cord can be stored in the cord wrap compartment.

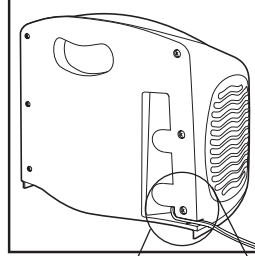

Excess cord can be stored in the cord wrap compartment.

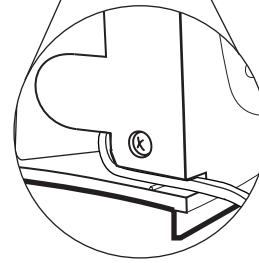

4. Set the fan enclosure onto the humidifier base. Make sure that the filter lines up with the fan cover.

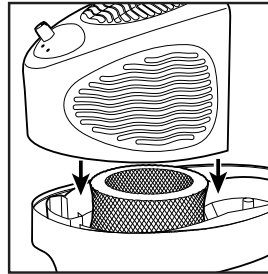

Make sure that the filter lines up with the fan cover.

## Filling the Water Tank

1. Remove the filler cap on the bottom of the tank by turning it counter-clockwise until the UNLOCK arrows line up with the ridges on the tank.

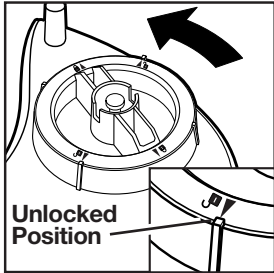

2. Fill the tank with COOL tap water. DO NOT USE HOT WATER. Be sure to keep the tank free of debris.

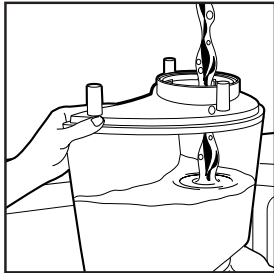

**NOTE:** Using distilled or deionized water will prolong the life of the filter.

3. Replace the filler cap and turn clockwise until the LOCK arrows line up with the ridges on the tank opening. Return the tank to an upright position. When carrying the tank, use the carry handle and support the tank from the other side.

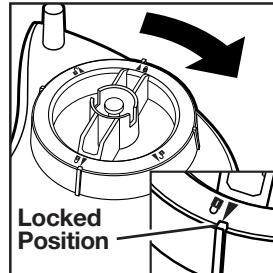

**NOTE:** Always make sure the filler cap is locked and the gasket is in place before inverting water tank.

### *Filter Tip!*

To prolong the life of the filter, it is recommended that you turn over the filter each time you fill the water tank.

## Placing the Water Tank on the Base

---

Lower the tank into place until it is properly seated, using the fan enclosure and the base to align the tank.

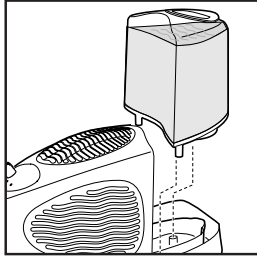

**NOTE:** Some water will flow out of the tank and into the water tray when the tank is in position.

**CAUTION:** Once the humidifier has been filled, do not attempt to tilt or move it. If it is necessary to move the humidifier, make sure it is unplugged and remove the water tank first.

**IMPORTANT!** Never pour water into or allow water to splash into air intake or exhaust grilles.

## Plugging in the Humidifier

---

**WARNING: To reduce the risk of electrical shock, never plug in the humidifier while your hands are wet!** Once the humidifier has been assembled and placed in its final location, and the tank has been filled, plug the humidifier into a wall outlet.

**NOTE:** The polarized plug will only fit in one direction—DO NOT try to force the plug! If you are unable to insert the plug into the outlet, try reversing the plug. If the plug still does not fit, contact a qualified electrician to replace the obsolete outlet.



## Setting the Controls – 2-Speed Humidifier

### Setting the fan speed

Turn the fan speed knob to the desired setting. To increase the humidity in a room more quickly, set the knob to **HI**. For quiet, nighttime operation or for a more gradual increase, set the knob to Quietmist™.

### Indicator lights

The power on indicator will light to indicate that the humidifier is on.

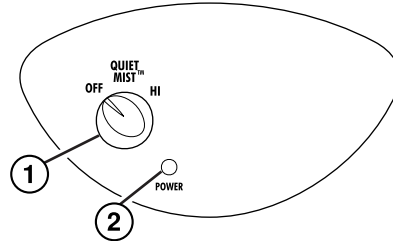

1. Fan Speed Knob
2. Power On Indicator – lights when unit is on.

## Setting the Controls – 2-Speed Humidifier with Humidistat

### Setting the fan speed

Turn the fan speed knob to the desired setting. To increase the humidity in a room more quickly, set the knob to **HI**. For quiet, nighttime operation or for a more gradual increase, set the knob to Quietmist™.

### Setting the humidistat

The desired humidity knob allows you to set the humidifier to cycle on and off to maintain a selected humidity level. Turn the knob clockwise for higher humidity, counterclockwise for less. Once the desired humidity level is reached, the desired humidity indicator will light and the fan will turn off (unit is in stand-by mode).

### Indicator lights

The power on indicator will light to indicate that the humidifier is on.

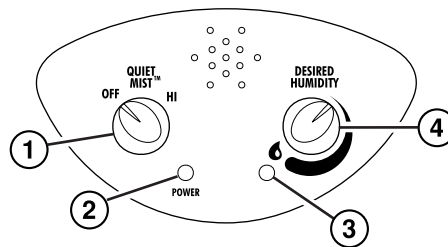

1. Fan Speed Knob
2. Power On Indicator – lights when unit is on.
3. Desired Humidity Indicator – lights when desired humidity is reached.
4. Desired Humidity Setting Knob

### Quietmist™

For quiet, nighttime operation or for a more gradual increase in the humidity level, set the knob to Quietmist™.

## Setting the Controls – 3-Speed Humidifier with Electronic Humidistat

### Setting the fan speed

Turn the fan speed knob to the desired setting. To increase the humidity in a room more quickly, set the knob to **HI**. For normal operation, set the knob to **MED**. For quiet, nighttime operation or for a more gradual increase, set the knob to Quietmist™

### Setting the electronic humidistat

The electronic humidistat allows you to set the humidity within a range from 20% to 90%, in 5% increments. The current room humidity level is displayed in large numbers, while the desired humidity level is displayed in smaller numbers. If the current room humidity level drops below 20%, the display will show **LO**. If it is higher than 90%, **HI** will be displayed. Press the ▲ and ▼ buttons to adjust the humidity level. The humidifier will then turn on automatically whenever the current room humidity drops more than 2% below the desired humidity. Once the desired humidity is reached, the fan will turn off and the unit will go into stand-by mode.

### Indicator lights

The power on indicator will light to indicate that the humidifier is on.

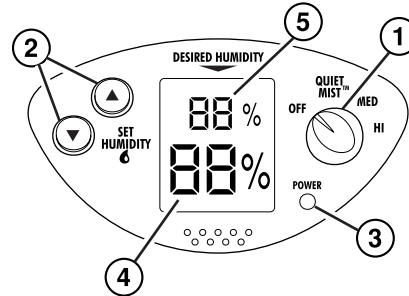

1. Fan Speed Knob
2. Humidity Setting Buttons (▲/▼)
3. Power On Indicator – lights when unit is on

### Digital Display

4. Current Room Humidity Percentage
5. Desired Humidity Percentage

## Quietmist™

For quiet, nighttime operation or for a more gradual increase in the humidity level, set the knob to Quietmist™

# How to Clean

The evaporative, wick-type humidifier adds moisture to the air in the form of water vapor, by using a fan to force air through a moistened-filter medium.

To ensure the proper and efficient operation of your humidifier, the following cleaning and maintenance procedures must be followed.

Failure to follow the recommended care and maintenance instructions could lead to a buildup of micro-organisms, including algae, bacteria, and mildew, which may lead to respiratory or other ailments in some individuals.

	<b>⚠ WARNING</b>
	<b>To reduce risk of electric shock:</b> <ul style="list-style-type: none"><li>• Always unplug before cleaning.</li><li>• Do not immerse fan enclosure in water or other liquid.</li></ul>

## Cleaning the Humidifier

Wipe the fan enclosure, control panel, and cord with a damp cloth or sponge.

### Daily Maintenance:

1. Turn off the humidifier and unplug it from electrical outlet.
2. Lift off the fan enclosure and remove the filter.
3. Remove the water tank and tray and carry them to the sink. Pour any remaining water into the sink.
4. Rinse the water tray and tank thoroughly to remove any dirt or sediment. Wipe clean, then dry with a clean cloth or paper towel.
5. Reinstall the water tray and filter, replace the fan enclosure, and refill the water tank with cool tap water as instructed on page 7.

**NOTE:** To prolong the life of the filter, it is recommended that you turn over the filter each time you fill the water tank.

### Weekly Maintenance:

1. Turn off the humidifier and unplug it from electrical outlet.
2. Lift off the fan enclosure and remove the filter.
3. Remove the water tank and tray and carry them to the sink. Pour any remaining water into the sink.
4. To remove scale caused by hard water deposits and to clean the tank and water tray, these parts can be either cleaned in a dishwasher or washed by hand.
5. Inspect the filter each week. If it becomes hard to the touch, or shows discoloration (caused by mineral deposits or mold/mildew buildup), it should be replaced. See page 16 for information about ordering a replacement filter.
6. After cleaning and drying all parts, follow the instructions on page 6 to reassemble the humidifier. If the humidifier will not be used for at least two weeks, see the "Storing the Humidifier" section.

---

### Preferred Cleaning Method (Cleaning in a dishwasher)

The parts shown on the right are dishwasher-safe for easy cleaning. These parts are a transparent smoke color for easy identification.

#### NOTES:

- Always wash humidifier parts separately from dishes.
  - Always use a heated water wash cycle.
  - If your dishwasher has a heated dry cycle, it should be turned OFF.
  - Do not use rinse aid while cleaning humidifier parts.
  - ALWAYS remove the filler cap from the water tank before placing the tank in the dishwasher.
1. Place the filler cap in the dishwasher's silverware basket. This small part must be secured in the silverware basket to prevent it from being damaged by the dishwasher.
  2. Place water tank in the dishwasher with the tank opening facing down if possible. This position will trap the least amount of water in the tank.

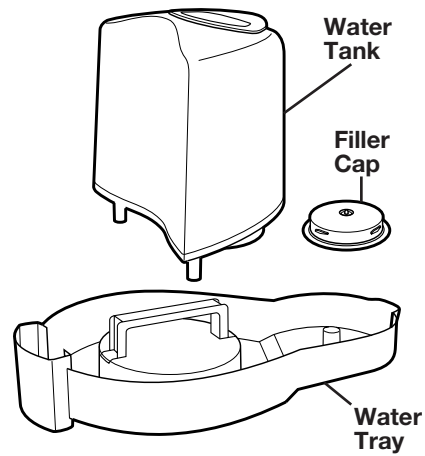

#### *Tip!*

If the water tank won't stand up in your dishwasher, try moving the silverware basket to another area in the dishwasher and place the tank in the silverware basket recess.

## **Alternate Cleaning Method (Cleaning by hand)**

### **To remove mineral deposits:**

1. Partially fill the water tray with a solution of one gallon water and 8 ounces undiluted white vinegar.
2. Allow to stand for 20 minutes, then clean all interior surfaces with a soft brush.
3. Dampen a soft cloth and wipe out entire tray to remove scale.
4. Rinse thoroughly with clean warm water to remove any remaining scale and vinegar/water solution.

### **To clean the tank:**

1. Fill the tank with one gallon of water and one teaspoon of chlorine bleach.
2. Replace the filler cap, and let the solution stand for 20 minutes, swirling it around the tank every few minutes to wet all inside surfaces.
3. Empty the tank, rinse tank and filler cap thoroughly with water until no bleach smell is noticeable. Dry with a clean cloth or paper towel.

## **Storing the Humidifier**

---

### **If the humidifier will not be used for at least two weeks:**

1. Unplug the humidifier.
2. Empty the water tank and water tray.
3. Discard the filter. DO NOT leave it in the humidifier. To order a new filter, see page 16.
4. Follow the cleaning instructions for weekly maintenance.
5. On models with a manual humidistat, turn the humidistat to the minimum setting.
6. Make sure all parts are completely dry. DO NOT leave any water in the humidifier when storing it.
7. Place the humidifier in the original box and store in a cool, dry place.
8. Clean the humidifier and install the new filter before using it again.

# *Troubleshooting Guide*

The following section provides the solutions to many common problems and questions. If your humidifier is not working correctly, review these solutions first; it may save you a phone call. If your problem is still not solved after reviewing this guide, call our toll-free customer service number, listed on the cover of this manual.

## **The Humidifier Will Not Turn On**

---

- Is the tank filled and properly seated on the base?
- Is the humidifier plugged into a powered outlet?
- Is the humidifier turned on?
- Is the desired humidity set lower than the current room humidity level? The humidifier turns on automatically when the desired humidity is higher than the current room humidity.

## **The Tank Leaks**

---

- Is the filler cap gasket in place? If not, press it into the groove around the tank fill opening. If the gasket seal is missing or damaged, call the customer service number on the cover to order a replacement gasket. Do not use the humidifier without the gasket in place.
- Is the filler cap locked tightly? Make sure that the “LOCKED” arrows line up with the ridges on the fill neck.
- Is something trapped under the edge of the rubber seal in the center of the filler cap? Check for debris under the edge of the seal, or for damage to the seal. If the seal is damaged, a replacement seal can be ordered by calling the customer service number on the cover.

## **The Tank Is Full But the Tray Does Not Fill**

---

- Is the cord or another object trapped under the tank? Make sure that the tank is properly seated on the base and that the power cord is routed correctly. If the tank will not seat properly, see “**Fan Enclosure or Tank Does Not Fit on Base.**”

## The Filler Cap Is Difficult to Remove

- Sometimes a vacuum can form in the tank, especially if it has not been seated on the base for a long period of time. Press the button in the center of the filler cap to relieve the vacuum.

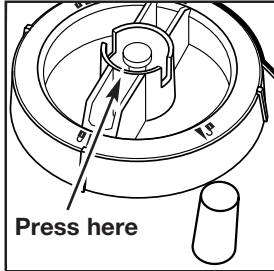

- Apply 100% pure petroleum jelly to the filler cap gasket. Wipe off any excess.

## Fan Enclosure or Tank Does Not Fit on Base

- Make sure that the cord or other objects are not trapped under the fan enclosure or tank.

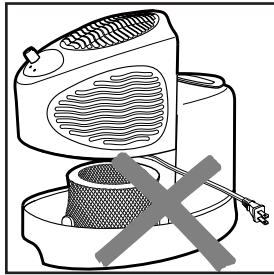

- New filters are shipped flat and must be "rounded" before installation. Gently pull the filter into a round shape, being careful not to tear it. Once the filter is properly rounded, install it and lower the fan enclosure into place (as described on page 6).

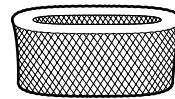

New filter

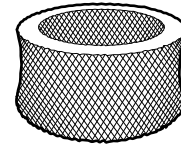

Rounded filter

- Is the cord routed correctly? The cord should be pressed completely into the cord exit notch. Any excess cord should be completely behind the tabs in the cord storage compartment, as shown above.

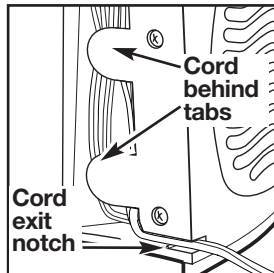

# Customer Service

If you have a question about your humidifier, call our toll-free customer service number. Before calling, please note the model, type, and series numbers and fill in that information below. These numbers can be found on the back of the fan enclosure. This information will help us answer your question much more quickly.

**MODEL:** \_\_\_\_\_ **TYPE:** \_\_\_\_\_ **SERIES:** \_\_\_\_\_

## THREE-YEAR LIMITED WARRANTY

Hamilton Beach/Proctor-Silex, Inc. warrants this appliance to be free from defects in material and workmanship for a period of three (3) years from the date of original purchase, except as noted. There is no warranty with respect to the following, which may be supplied with this appliance: the filter. This warranty extends only to the original consumer purchaser and does not cover damage from abuse, neglect, use for commercial purposes, or any other use not found in the printed directions. HAMILTON BEACH/PROCTOR-SILEX, INC. EXPRESSLY DISCLAIMS ANY AND ALL IMPLIED WARRANTIES, INCLUDING WARRANTIES OF MERCHANTABILITY AND FITNESS FOR A PARTICULAR PURPOSE. ANY LIABILITY HEREUNDER IS EXPRESSLY LIMITED TO THE REPAIR OR REPLACEMENT OF A DEFECTIVE PRODUCT OR AN AMOUNT EQUAL TO THE PURCHASE PRICE PAID THEREFOR, AND ALL CLAIMS FOR SPECIAL AND CONSEQUENTIAL DAMAGES ARE HEREBY EXCLUDED. Some states or provinces do not allow this exclusion or limitation of incidental or consequential losses, so the foregoing disclaimer may not apply to you. If you have a claim under this warranty, DO NOT RETURN THE APPLIANCE TO THE STORE! Please call our CUSTOMER SERVICE NUMBER. (For faster service please have model, series, and type numbers ready for operator to assist you.)

### CUSTOMER SERVICE NUMBERS

In the U.S. 1-800-851-8900

In Canada 1-800-267-2826

**Web site address: [www.hamiltonbeach.com](http://www.hamiltonbeach.com)**

### KEEP THESE NUMBERS FOR FUTURE REFERENCE!

This warranty gives you specific legal rights, and you may also have other legal rights which vary from state to state, or province to province.

### Replacement Filters:

Humidifier Capacity:	USA Models:	Canada Models:	Filter Part Number:
2.5 gallons/day	05518 & 05519	05518C & 05519C	05910
3.5 gallons/day	05520 & 05521	05520C & 05521C	05920

HAMILTON BEACH ♦ PROCTOR-SILEX, INC.

263 Yadkin Road  
Southern Pines, NC 28387

PROCTOR-SILEX CANADA, INC.

Picton, Ontario K0K 2T0

840074800

Web site address: [www.hamiltonbeach.com](http://www.hamiltonbeach.com)

8/00