

**Hamilton Beach®**

*Meal Maker Express™*

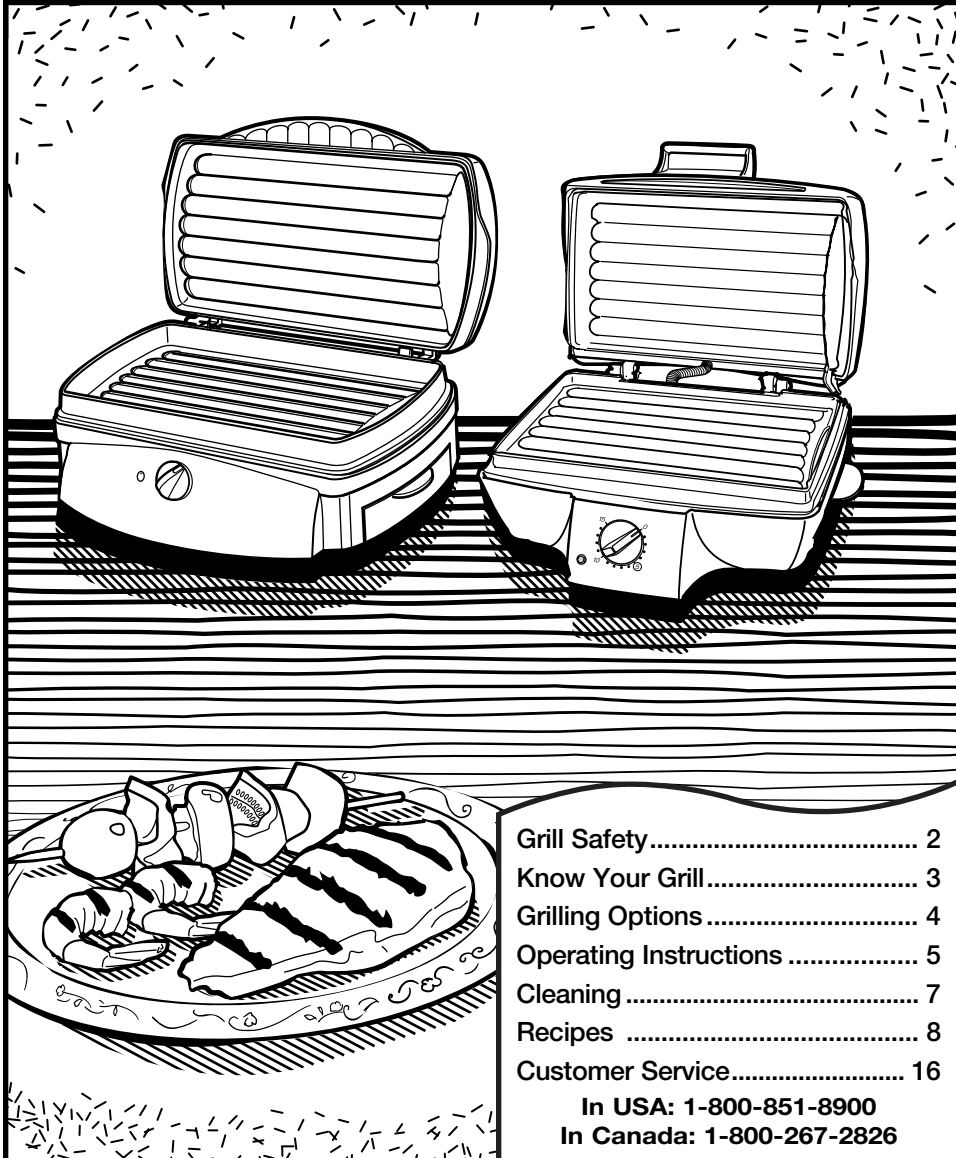

Grill Safety .....	2
Know Your Grill .....	3
Grilling Options .....	4
Operating Instructions .....	5
Cleaning .....	7
Recipes .....	8
Customer Service.....	16

**In USA: 1-800-851-8900**  
**In Canada: 1-800-267-2826**

# Grill Safety

## IMPORTANT SAFEGUARDS

In order to prevent the risk of fire, electric shock, burns or other injury or damage, follow these instructions carefully. When using electrical appliances, basic safety precautions should always be followed including the following:

1. Read all instructions.
2. Do not touch hot surfaces. Use handles or knobs.
3. To protect against risk of electrical shock, do not immerse appliance, cord or plug in water or other liquid.
4. Close supervision is necessary when any appliance is used by or near children.
5. Unplug from outlet when not in use and before cleaning. Allow to cool before putting on or taking off parts, and before cleaning the appliance.
6. Do not operate any appliance with a damaged cord or plug, or after the appliance malfunctions or is dropped or damaged in any manner. Call our toll-free customer service number for information on examination, electrical repair, mechanical repair, or adjustment.
7. Do not use outdoors.
8. The use of accessory attachments not recommended by Hamilton Beach/Proctor-Silex, Inc. may cause injuries or serious damage to the unit.
9. Do not let cord hang over edge of table or counter, or touch hot surfaces, including stove.
10. Do not place on or near a hot gas or electric burner, or in a heated oven. Do not use this unit near oven, heater or fireplace.
11. Extreme caution must be used when moving an appliance containing hot oil or other hot liquids.
12. To disconnect, turn any control to "OFF," then remove plug from wall outlet.
13. Do not use appliance for other than intended purpose.
14. For units with detachable cooking plates, be sure they are secured before cooking.

## SAVE THESE INSTRUCTIONS!

### Consumer Safety Information

This appliance is intended for household use only.

This appliance is equipped with a grounded-type 3-wire cord (3-prong plug). This type of plug will only fit into an electrical outlet made for a 3-prong plug. This is a safety feature intended to help reduce the risk of electrical shock. If the plug should fail to fit contact a qualified electrician to replace the obsolete outlet. Do not attempt to defeat the safety purpose of the grounding pin by modifying the plug in any way.

**To reduce risk of electrical shock, do not immerse the grill in water.**

To avoid an electrical circuit overload do not use another high wattage appliance on the same circuit with the grill.

The length of the cord used on this appliance was selected to reduce the hazards of becoming tangled in, or tripping over a longer cord. If a longer cord is necessary an approved extension cord may be used. The electrical rating of the extension cord must be equal to or greater than the rating of the grill. Care must be taken to arrange the extension cord so that it will not drape over the countertop or tabletop where it can be pulled on by children or accidentally tripped over.

An extension cord should be connected to the appliance first, before it is plugged into the outlet.

Always use a hot mitt to protect hand when opening the grill.

**CAUTION:** Escaping steam may cause burns.

# Know Your Grill

## Parts and Features

---

- 1. Cover
- 2. Nonstick Grill Surfaces
- 3. Base
- 4. Timer
- 5. Drip Cup
- 6. Support Leg
- 7. Spatula/Scraper  
(available with select models)

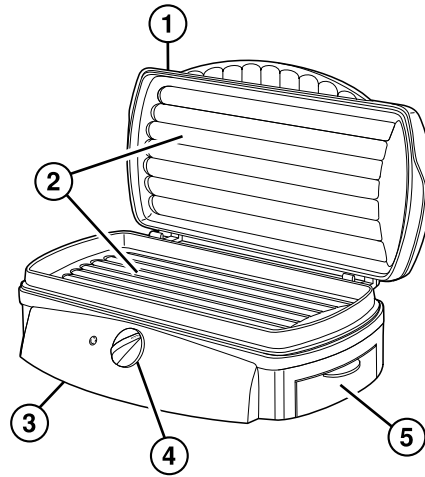
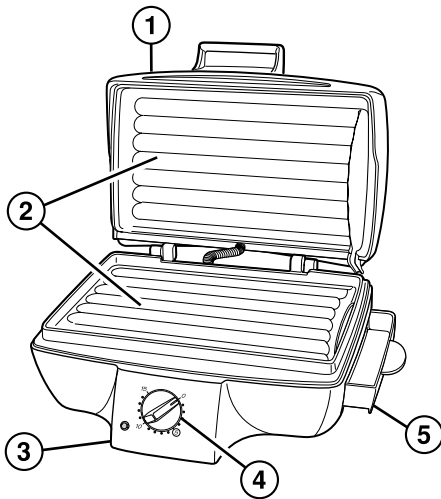
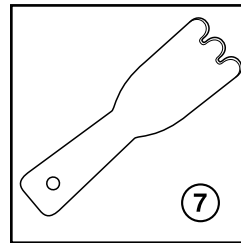
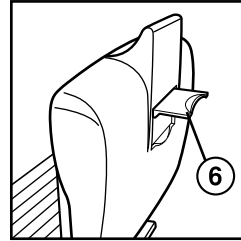
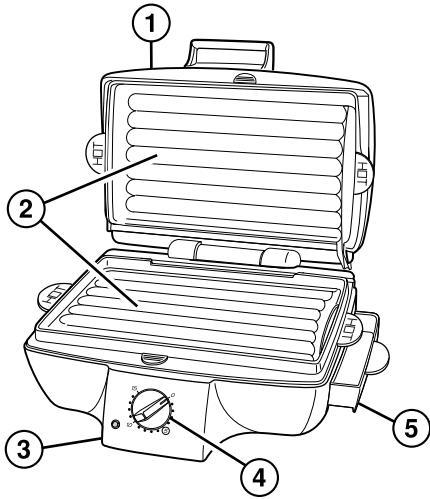

## Optional Features (on select models)

### Drain Spout

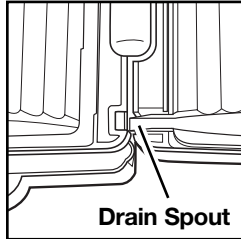

### Removable Grids

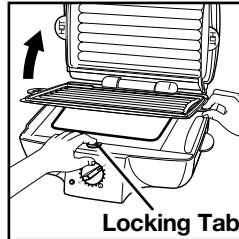

### Cord Wrap

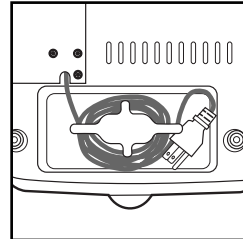

## Grilling Options

The grill may be used in two different positions:

### Closed Cover

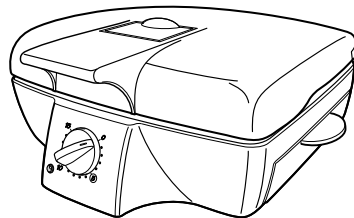

This will cook the food on both sides at the same time. This is the quickest method.

### Flat

Open the grill for more grilling surface. This will require a longer cooking time but you can cook twice as much.

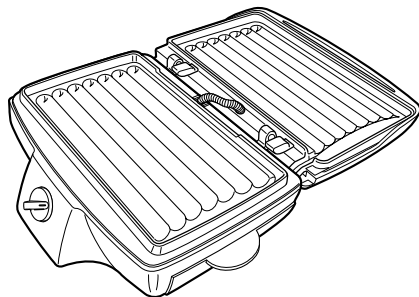

1. Flip up the support leg, then lift

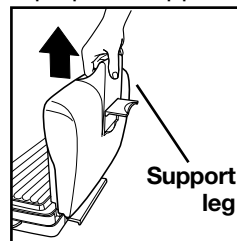

cover straight up (this will disengage the locked hinge).

2. Lower the cover as far as it will go to the flat position.

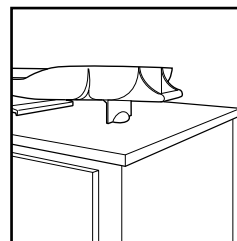

# Operating Instructions

**BEFORE FIRST USE:** Please wash the cooking surfaces of the grill as instructed under “Cleaning.”

1. Plug into 120 volt AC outlet.
2. Brush grilling surfaces with oil or spray with nonstick cooking spray.
3. Preheat grill by turning timer to 5 minutes. Keep cover closed.
4. When preheated, raise grill cover. Place food to be cooked onto grill and lower grill cover. Always use grill with drip cup in place.
5. Set timer. The ON light comes on when the timer is set.

6. When timer rings, use a hot mitt and

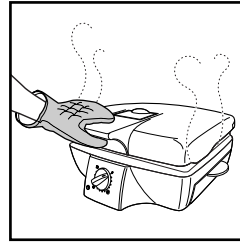

carefully lift grill cover and check food to see if cooked to desired degree. Do not cut food on nonstick grilling surface.

If additional cooking time is needed, reset timer.

7. To turn food, use spatula/scrapper (available with select models), or another utensil safe for nonstick surfaces.
8. When food is cooked to desired degree, remove the food and unplug the grill. Let cool slightly before cleaning.

## Tips for Easy Grilling

- **ALWAYS PREHEAT THE GRILL 5 MINUTES BEFORE USING.**
- Read the Grill Use & Care Guide before starting to grill.
- Grill cooking is so easy because you can brown meats, cook onions, grill vegetables, “stir-fry” dishes, steam fish and toast sandwiches with little attention from the cook.
- Use the grill to “prep and cook” foods for traditional range-top recipes: brown ground beef for spaghetti sauce or stir-fry beef strips for a Chinese dish. Since the grill cooks top and bottom at the same time, there’s no need to stir while cooking.
- Cook “guilt-free” French fries without the extra oil or make perfect French toast that doesn’t need to be turned during cooking.
- Use vegetable cooking spray for convenient, stick-free grilling. Or if you prefer, brush grill surfaces with vegetable oil before preheating.
- Use plastic utensils on the nonstick grill surfaces. Do not use metal utensils as they will damage the nonstick surface.
- Plan ahead for quick meals by freezing boneless chicken breasts and burger patties for future meals. Place individual servings on a baking sheet and freeze. When frozen, place in plastic bags. To grill, see the “Grilling Chart” on page 6.
- Cleanup is easy! Let grill cool down. Wipe grill surfaces with damp paper towel or dish cloth.

## Grilling Chart

**PREHEAT GRILL 5 MINUTES WITH COVER CLOSED.**

The following times are guidelines.

FOOD	COOK TIME	DONENESS
Beef strip steak, boneless, fresh (8 oz.)	5 min.	Slightly pink in center; brown on outside
Chicken breast, boneless, fresh (4-6 oz.)	5-8 min.	No longer pink in center
Chicken breast, boneless, frozen (4 oz.)	10-12 min.	No longer pink in center
Fish fillet squares, frozen (about 2 oz.)	6-8 min.	Fish looks white
Frankfurter (hot dog)	5 min.	Heated through
Hamburger, fresh (4 oz.)	5-7 min.	No longer pink in center
Hamburger, frozen (4 oz.)	10-12 min.	No longer pink in center
Pork chops, boneless, fresh (4 oz., ¾" thick)	6-8 min.	No longer pink in center
Pork chops, boneless, frozen (4 oz.)	10-12 min.	No longer pink in center
<b>Vegetables (frozen)</b>		
Peppers and onions	6 min.	Cooked through
Potato wedges, frozen	8 min.	Cooked through
Stir-fry vegetable mix	6 min.	Tender-crisp
<b>Vegetables (fresh)</b>		
Broccoli florets	6 min.	Tender-crisp
Green or red bell pepper strips	5 min.	Tender-crisp
Mushrooms, sliced	6 min.	Tender-crisp
Onions, sliced	4 min.	Soft
Zucchini or summer squash, sliced	4 min.	Tender-crisp
Grilled Cheese or Cheese and Ham	4-5 min.	Golden brown on outside; melted cheese

# Cleaning

**NOTE:** If your grill has removable grids, see the following section.

1. Unplug grill from electrical outlet and allow to cool slightly.
2. Wipe grilling surfaces with a paper towel to remove drippings.
3. Use the spatula/scrapper (available with select models) to scrape away cooked-on food or grease.
4. Use a damp sponge with a small

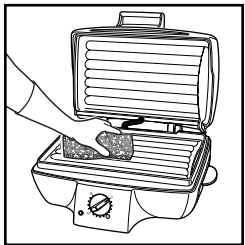

amount of dishwashing detergent to scrub grilling surfaces. See illustration. Rinse out sponge and wipe surfaces

clean. Use a clean, damp cloth to wipe surfaces again.

5. Do not use steel wool or any type of abrasive cleaner to clean the grill, as it will damage the nonstick grilling surface, and void the warranty.
6. Use a clean, damp cloth to wipe clean the outside of grill.
7. Empty drip cup. Wash drip cup and spatula/scrapper in hot, soapy water. Rinse and dry. (They can also be put in top rack of dishwasher.)
8. The grill can be stored, closed and upright, sitting on the hinge side.

**DO NOT IMMERGE THE GRILL IN WATER. DO NOT CLEAN THE GRILL IN THE DISHWASHER.**

## Removable Grids (on select models)

1. Unplug grill from electrical outlet and allow to cool.
2. While holding grid, slide locking tab
3. Wash grids in hot soapy water. Rinse then dry. Grids may also be washed in dishwasher.

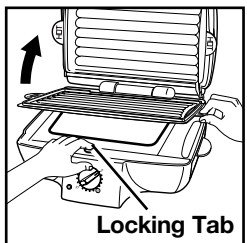

to release grid. Open grill flat and repeat with other grid. **DO NOT REMOVE THE GRID WITH THE GRILL IN AN UPRIGHT**

**POSITION. THE GRILL SHOULD BE FLAT TO REMOVE THE GRID.**

# Recipes

These recipes were developed for use with all sizes of the Meal Maker Express™ Contact Grills. Some ingredients are listed as a range; for example, 2 or 4 slices of bread. Use the smaller amount for the small grill or if you're only cooking for two on the large grill. Use the larger amount for the large grill.

## **Guilt-Free Hash Browns**

---

1½ or 3 cups frozen hash brown potatoes, Southern style  
½ or 1 green onion, finely chopped (optional)

1. Spray grill with cooking spray. Preheat grill for 5 minutes.
2. Place potatoes and onion on grill. Close lid and cook 10 minutes or until potatoes are tender and browned.

**Makes 2 or 4 servings.**

## **Ham & Cheese on a Bagel**

---

2 or 4 regular-sized bagels  
4 or 8 slices (½ ounce each) American cheese  
2 or 4 ounces thinly sliced ham

1. Preheat grill for 5 minutes.
2. Place bagel **tops** on grill. Close lid and heat 3 minutes. Remove and keep warm.
3. Meanwhile, place cheese slices on bagel **bottoms**. Top with ham. Place on grill. Cover and cook 3 minutes or until cheese melts. Top with bagel **tops**.

**Makes 2 or 4 servings.**

## **Toasted Peanut Butter & Jelly**

---

4 or 8 slices firm white bread  
Peanut butter  
Jelly or jam

1. Spray grill with cooking spray. Preheat grill for 5 minutes.
2. On half of the slices of bread, spread peanut butter and jelly or jam. Top with remaining bread.
3. Close lid and cook sandwiches 5 minutes or until heated through.

**Makes 2 or 4 servings.**



## **Cinnamon French Toast**

---

3 eggs  
1/3 cup milk  
1 tablespoon sugar  
1/2 teaspoon vanilla  
4 slices bread  
Cinnamon

1. Spray grill with cooking spray. Preheat grill for 5 minutes.
2. In a medium shallow bowl, whisk together eggs, milk, sugar, and vanilla. Soak slices of bread in egg mixture.
3. On the small grill, place 2 slices of bread. Close lid and cook 4 minutes or until done. Repeat with remaining bread. OR,
4. On the large grill, place 2 slices of bread and top with the remaining slices of bread, making a French toast "sandwich." Close lid and cook 5 minutes or until done.
5. Sprinkle with cinnamon before serving with butter and syrup.

**Makes 2 servings.**

## **Pizza Burgers**

---

1/2 or 1 pound lean ground beef  
1/4 or 1/2 cup shredded mozzarella cheese (1 or 2 ounces)  
1/4 or 1/2 teaspoon dried oregano leaves, crushed  
2 or 4 sandwich-size English muffins, split and toasted

1. Preheat grill for 5 minutes.
2. Combine beef, cheese, and oregano. Mix well. Shape mixture into two or four 3 1/2-inch patties.
3. Place patties on grill. Close lid and cook 5 to 7 minutes or until beef is no longer pink. Serve on English muffins. Top with pizza sauce, if desired.

**Makes 2 or 4 servings.**

## **Grilled Ham & Cheese Special**

---

4 or 8 slices rye bread  
Thousand Island or Russian salad dressing  
4 or 8 ounces thinly sliced ham  
2 or 4 ounces thinly sliced Swiss cheese  
1/2 or 1 cup deli coleslaw

1. Spray grill with cooking spray. Preheat grill for 5 minutes.
2. On half of the bread, spread salad dressing. Top with ham, cheese, and coleslaw. Top with remaining bread.
3. Close lid and cook sandwiches for 5 minutes or until heated through and cheese melts.

**Makes 2 or 4 servings.**

## Turkey Garden Burgers

---

½ or 1 pound lean ground turkey  
½ or 1 cup shredded carrot and zucchini  
1 or 2 tablespoons finely chopped onion  
1 tablespoon finely chopped fresh parsley  
2 or 4 whole wheat or white sandwich buns

1. Spray grill with cooking spray. Preheat grill for 5 minutes.
2. Combine turkey, carrot and zucchini, onion, and parsley; mix well. Shape mixture into two or four 3½-inch patties.
3. Place patties on grill. Close lid and cook 5 to 6 minutes or until turkey is no longer pink. Serve on buns. Top with low-fat mayonnaise, lettuce and tomato, if desired.

**Makes 2 or 4 servings.**

## Pepperoni Pizzawiches

---

2 or 4 English muffins, split  
16 or 32 pepperoni slices  
2 or 4 slices Cheddar or American cheese  
4 to 8 tomato slices  
Dried oregano leaves, crushed

1. Preheat grill for 5 minutes.
2. On half of muffin halves, layer pepperoni, cheese, and tomato. Sprinkle with oregano. Top with remaining muffin halves. Close lid and grill 5 minutes or until cheese melts.

**Makes 2 or 4 servings.**

## Cheesy Bean Quesadillas

---

½ or 1 can (about 16 ounces) refried beans  
4 or 8 flour tortillas (6-inch)  
¼ or ½ cup shredded Cheddar cheese (1 or 2 ounces)  
¼ or ½ cup picante sauce  
1 to 3 green onions, sliced

1. Preheat grill for 5 minutes.
2. Spread beans on half of tortillas to within ½ inch of edges. Top each with cheese, picante sauce, and green onions. Moisten edges of tortillas with water. Top with remaining tortillas and press edges together. Cut each into halves.
3. Place one half on small grill or 4 halves on large grill. Close lid and cook 4 to 5 minutes. Remove from grill and cut each half into 3 triangles. Repeat with remaining quesadillas.

**Makes 2 or 4 servings.**

## **Tuna Burgers**

---

1 or 2 cans (6 ounces each) chunk light tuna, drained and flaked  
¼ or ½ cup dry bread crumbs  
¼ or ½ cup finely chopped celery  
2 tablespoons or ¼ cup finely chopped onion  
1 or 2 tablespoons chopped fresh parsley  
2 tablespoons or ¼ cup salad dressing or mayonnaise

1. Spray grill with cooking spray. Preheat grill for 5 minutes.
2. For burgers, combine all ingredients and mix well. Shape mixture into two or four 3½-inch patties.
3. Close lid and cook 5 minutes or until burgers are lightly browned and heated through.

**Makes 2 or 4 servings.**

## **Grilled Chicken Caesar Salad**

---

1 or 2 boneless, skinless chicken breast halves (about 4 or 8 ounces)  
1 egg white, beaten slightly  
2 tablespoons or ¼ cup grated Parmesan cheese  
3 or 6 cups coarsely cut-up romaine lettuce  
1 or 2 green onions, sliced  
¼ or ½ cup croutons  
Caesar salad dressing

1. Spray grill with cooking spray. Preheat grill for 5 minutes.
2. Dip chicken into egg white and then coat with cheese.
3. Place chicken on grill. Close lid and cook 7 to 9 minutes or until no longer pink. Remove and let cool slightly.
4. Cut chicken into strips. Combine lettuce, green onions, croutons, and sliced chicken. Add enough salad dressing to taste. Toss to coat.

**Makes 2 or 4 servings.**

## **Grilled Vegetables on Italian Bread**

---

½ or 1 small eggplant, cut into 4 or 8 (½-inch) slices  
½ or 1 medium red bell pepper, cut into strips  
½ or 1 medium onion, sliced  
1 or 2 cloves garlic, minced or ¼ teaspoon garlic powder  
½ or 1 cup shredded mozzarella or pizza cheese  
½ or 1 loaf Italian or French bread, about 12 ounces  
Italian salad dressing

1. Spray grill with cooking spray. Preheat grill for 5 minutes.
2. Place eggplant, pepper, onion, and garlic on grill. Close lid and cook 5 minutes or until vegetables are tender. Sprinkle with cheese.
3. Cut bread into lengthwise halves. Drizzle bread halves with salad dressing. Arrange vegetables with cheese on bottom half and top with remaining bread half. Cut into 2 or 4 sandwiches.

**Makes 2 or 4 servings.**

## **“Meatball” Sandwiches**

---

½ or 1 pound lean ground beef  
¼ or ½ cup dry Italian seasoned bread crumbs  
2 tablespoons or ¼ cup chopped onion  
½ or 1 teaspoon dried basil leaves, crushed  
1 egg or 2 egg whites  
2 or 4 crusty Italian rolls, about 7 inches long  
1 8-oz. or 14-oz. jar spaghetti sauce, heated  
Grated Parmesan cheese

1. Spray grill with cooking spray. Preheat grill for 5 minutes.
2. In bowl, combine beef, bread crumbs, onion, basil, and egg; mix well. Shape mixture into two or four 3½-inch patties.
3. Place patties on grill. Close lid and cook 5 to 7 minutes or until beef is no longer pink. Cut each into 8 pieces. Place on rolls and top “meatballs” with hot spaghetti sauce. Sprinkle with cheese.

**Makes 2 or 4 servings.**

## **Speedy Beef and Mushrooms**

---

½ or 1 pound sirloin steak strips  
1 or 2 cups sliced fresh mushrooms (3 or 6 ounces)  
½ or 1 medium onion, sliced  
1 or 2 cloves garlic, minced or  
    ⅛ or ¼ teaspoon garlic powder  
¾ cup or 1 jar (12 ounces) beef gravy  
1 tablespoon Worcestershire sauce  
¼ or ½ cup sour cream  
Hot cooked noodles

1. Spray grill with cooking spray. Preheat grill for 5 minutes.
2. Place beef strips on grill. Close lid and cook 4 minutes or until beef is browned and no longer pink. Remove.
3. Add mushrooms, onion, and garlic to grill. Close lid and cook 3 minutes or until vegetables are tender.
4. Meanwhile, heat gravy, Worcestershire sauce, and sour cream in saucepan. (Or, microwave on HIGH for 2 minutes or until hot.) Stir in cooked beef and mushroom mixture. Serve over noodles.

**Makes 2 or 4 servings.**

## **Orange Glazed Pork Chops**

---

2 tablespoons or ¼ cup orange marmalade  
1 tablespoon soy sauce  
1 tablespoon lemon or lime juice  
¼ teaspoon ground ginger  
2 or 4 boneless pork chops, ¾ inch thick (about 1 pound)

1. Preheat grill for 5 minutes.
2. For glaze, combine orange marmalade, soy sauce, lemon juice, and ginger. Place chops on grill. Pour glaze over chops. Close lid and cook 6 to 8 minutes or until chops are no longer pink. Remove chops and pour glaze from grill over all.

**Makes 2 or 4 servings.**

## Really Easy Tacos

---

½ or 1 pound lean ground beef  
¼ or ½ cup chopped onion  
½ or 1 package (1¼ ounces) taco seasoning mix  
6 or 12 taco shells  
Shredded lettuce, chopped tomatoes, shredded cheddar cheese  
Sour cream and/or salsa

1. Preheat grill for 5 minutes.
2. Crumble beef on grill and top with onion. Sprinkle with taco seasoning. Close lid and cook 4 minutes or until beef is no longer pink.
3. In each taco shell, place cooked beef mixture. Top with lettuce, tomatoes, and cheese. Add sour cream and/or salsa.

**Makes 2 or 4 servings.**

## Steamed Shrimp

---

½ or 1 pound large shrimp with shells  
2 tablespoons or ¼ cup vinegar  
2 tablespoons or ¼ cup water  
1 tablespoon shrimp/crab boil seasoning  
½ teaspoon salt

1. Preheat grill for 5 minutes.
2. Arrange shrimp in a single layer on grill. Pour combined vinegar and water over all. Sprinkle with seasoning and salt. Close lid and cook 3 to 5 minutes or until shrimp turn pink.

**Makes 2 or 6 appetizers.**

## Chicken & Pepper Wraps

---

½ or 1 pound boneless, skinless chicken breasts  
½ or 1 cup picante sauce  
1 or 2 medium green or red bell peppers, cut into strips  
½ or 1 medium onion, sliced  
¼ or ½ teaspoon dried oregano leaves, crushed  
2 or 4 flour tortillas (8-inch)  
½ or 1 cup shredded Cheddar cheese (2 or 4 ounces)

1. Spray grill with cooking spray. Preheat grill for 5 minutes.
2. Season chicken with salt, if desired. Place chicken on grill and brush with ¼ cup of the picante sauce. Close lid and cook 5 to 7 minutes or until chicken is no longer pink. Remove chicken and keep warm.
3. Place peppers and onion on grill. Sprinkle with oregano. Close lid and cook 3 minutes or until vegetables are tender-crisp.
4. Warm tortillas in microwave oven according to package directions. Slice chicken into thin strips and place down center of each tortilla. Top with pepper mixture and cheese. Fold over one side and then roll up. Serve with remaining picante sauce.

**Makes 2 or 4 servings.**

## **Chicken & Vegetable Packets**

---

2 or 4 cooked chicken breasts (about ½ to 1 pound uncooked)\*  
14 or 28 frozen potato wedges with skin (about 12 ounces)  
1 or 2 cups frozen peas  
½ or 1 can (10½ ounces) condensed cream of mushroom soup  
Dried thyme leaves, crushed

1. Preheat grill for 5 minutes.
2. Place 1 chicken breast in center of a piece of aluminum foil, about 12x16 inches long. Top each with layer of seven potato wedges, ½ cup peas and ¼ can mushroom soup. Sprinkle with thyme. Wrap with foil, making a 6x4-inch packet.
3. Place two packets on grill. Close lid and cook 8 minutes or until heated through.

\*Note: To grill chicken breasts, see the “Grilling Chart” on page 6.

**Makes 2 or 4 servings.**

## **Spicy Pepper Steak**

---

½ or 1 pound sirloin steak strips  
1 or 2 small green or red bell peppers, cut into strips  
½ or 1 medium onion, sliced  
1 or 2 cloves garlic, minced or ¼ teaspoon garlic powder  
½ or 1 jar (12 ounces) beef gravy  
1 or 2 tablespoons soy sauce  
¼ or ½ teaspoon crushed red pepper  
Hot cooked rice

1. Spray grill with cooking spray. Preheat grill for 5 minutes.
2. Place beef strips on grill. Close lid and cook 4 minutes or until beef is browned and no longer pink. Remove and keep warm.
3. Add peppers, onion, and garlic to grill. Close lid and cook 3 minutes or until vegetables are tender-crisp.
4. Meanwhile, heat gravy, soy sauce, and crushed red pepper in saucepan. (Or, microwave on HIGH for 2 minutes or until hot.) Stir in cooked beef and vegetable mixture. Serve over rice.

**Makes 2 or 4 servings.**

## **Grilled Vegetable Medley**

---

1 or 2 medium zucchini or yellow summer squash, sliced

½ or 1 medium onion, sliced

1 or 2 cups sliced fresh mushrooms (3 or 6 ounces)

1 or 2 medium or plum tomatoes, sliced

½ or 1 teaspoon dried basil leaves, crushed

1. Spray grill with cooking spray. Preheat grill for 5 minutes.
2. Place zucchini and onion on grill. Close lid and cook 5 minutes or until vegetables are tender.
3. Remove to serving dish and keep warm. Add mushrooms and tomatoes to grill. Sprinkle with basil. Close lid and cook 5 minutes.
4. Pour tomato mixture with cooking juices from drip tray over zucchini mixture and toss to mix. Season with salt and pepper, if desired.

**Makes 2 or 4 servings.**

## **Extra-Quick Chicken Caesar Salad**

---

Slice one or two grilled chicken breasts (see the “Grilling Chart”). Toss with a bag of Complete Caesar Salad mix.

## **Barbecued Chicken Breasts**

---

Top grilled chicken breasts (see the “Grilling Chart”) with barbecue sauce and shredded cheese.

## **Spicy Potato Wedges**

---

Sprinkle cooked potato wedges (see the “Grilling Chart”) with chili powder.

## **Super Franks**

---

Top grilled frankfurter with peppers and onions (see the “Grilling Chart”). Serve in buns with mustard and ketchup.

# Customer Service

If you have a question about your grill, call our toll-free customer service number. Before calling, please note the model, type, and series numbers and fill in that information below. These numbers can be found on the bottom of your grill. This information will help us answer your question much more quickly.

**MODEL:** \_\_\_\_\_ **TYPE:** \_\_\_\_\_ **SERIES:** \_\_\_\_\_

## LIMITED WARRANTY

This product is warranted to be free from defects in material and workmanship for a period of two (2) years for Hamilton Beach Portfolio products or one (1) year for Hamilton Beach products from the date of original purchase, except as noted below. During this period, we will repair or replace this product, at our option, at no cost. THE FOREGOING WARRANTY IS IN LIEU OF ANY OTHER WARRANTY, WHETHER EXPRESS OR IMPLIED, WRITTEN OR ORAL INCLUDING ANY WARRANTY OF MERCHANTABILITY OR FITNESS FOR A PARTICULAR PURPOSE. ANY LIABILITY IS EXPRESSLY LIMITED TO AN AMOUNT EQUAL TO THE PURCHASE PRICE PAID, AND ALL CLAIMS FOR SPECIAL, INCIDENTAL AND CONSEQUENTIAL DAMAGES ARE HEREBY EXCLUDED. There is no warranty with respect to the following, which may be supplied with this product: glass parts, glass containers, cutter/strainer, blades, and/or agitators. This warranty extends only to the original consumer purchaser and does not cover a defect resulting from abuse, misuse, neglect, use for commercial purposes, or any use not in conformity with the printed directions. This warranty gives you specific legal rights, and you may also have other legal rights which vary from state to state, or province to province. Some states or provinces do not allow limitations on implied warranties or special, incidental or consequential damages, so the foregoing limitations may not apply to you.

If you have a claim under this warranty, DO NOT RETURN THE APPLIANCE TO THE STORE! Please call our CUSTOMER SERVICE NUMBER. (For faster service please have model, series, and type numbers ready for operator to assist you.)

## CUSTOMER SERVICE NUMBERS

In the U.S. 1-800-851-8900

In Canada 1-800-267-2826

Web site address: [www.hamiltonbeach.com](http://www.hamiltonbeach.com)

**KEEP THESE NUMBERS FOR FUTURE REFERENCE!**

HAMILTON BEACH ♦ PROCTOR-SILEX, INC.

PROCTOR-SILEX CANADA, INC.

263 Yadkin Road Southern Pines, North Carolina 28387

Picton, Ontario K0K 2T0

840100500

Web site address: [www.hamiltonbeach.com](http://www.hamiltonbeach.com)

4/02