

FORD MOTOR COMPANY OF CANADA LIMITED
FURNITURE GUIDELINES 2012



FORD MOTOR COMPANY OF CANADA LIMITED

FURNITURE GUIDELINES 2012



We are pleased to offer you a comprehensive program of furnishings for your dealership. The program was put together as a result of outfitting a number of dealerships across Canada, coupled with input from your design consultant and Ford Head Office.

This offering is designed to save you time and money. We have priced the product very competitively and chosen products that provide excellent value. We have also chosen finishes that will work with your standard decor so you do not have to spend time and effort searching through catalogues and finishes, to achieve a truly coordinated environment.

All products are discounted 50% (with the exception of Descor wood products which are 45%) with delivery, freight, installation and taxes extra. Your local Global Group dealer will gladly provide you with net pricing and figures for delivery, installation and freight. To find a local dealer simply go to **www.globaltotaloffice.com** and click on "Dealer Locator" and enter a postal code or city. We have included a list of showrooms and contacts across the country for your reference.

For additional information please contact **Harvey Lamb** at The Global Group **416-931-4457** or **harvey_lamb@globaltotaloffice.com**.



FORD MOTOR COMPANY OF CANADA LIMITED

FURNITURE GUIDELINES 2012

Global Showrooms

Pacific

GLOBAL VANCOUVER

110 – 3773 Still Creek Avenue
Burnaby, British Columbia V5C 4E2
Phone: 604-432-1701
Fax: 604-432-7475
E-Mail: scott_harman@globaltotaloffice.com
Contact: Scott Harman

Prairie

GLOBAL ALBERTA

12-2010-30th Avenue NE
Calgary, Alberta T2E 7K9
Phone: 403-250-7770
Fax: 403-250-7773
E-Mail: grant_mcneil@globaltotaloffice.com
Contact: Grant McNeil

GLOBAL WINNIPEG

1-1080 Waverley Street
Winnipeg, Manitoba R3T 5S4
Phone: 204-925-3350
Fax: 204-925-3356
E-Mail: liana_turanski@globaltotaloffice.com
Contact: Liana Turanski

Quebec

GLOBAL MONTREAL

996 St. Antoine Ouest
Montreal, Quebec H3C 1A7
Phone: 514-866-4331 or 1-800-361-7543
Fax: 514-866-8567
E-Mail: dany_oconnor@globaltotaloffice.com
Contact: Dany O'Connor

Central

GLOBAL TORONTO

1350 Flint Road
Downsview, Ontario M3J 2J7
Phone: 416-650-6500
Fax: 416-739-6319
E-Mail: harvey_lamb@globaltotaloffice.com
Contact: Harvey Lamb

GLOBAL OTTAWA

150 Isabella Street, Suite 201
Ottawa, Ontario K1S 1V7
Phone: 613-234-2881
Cell: 416-409-5301
Fax: 613-234-5350
E-Mail: yvon_morency@globaltotaloffice.com
Contact: Yvon Morency

Atlantic

GLOBAL HALIFAX

1310 Hollis Street, Suite 150
Halifax, Nova Scotia B3J 3P3
Phone: 902-422-7434
Fax: 902-423-9924
E-Mail: doug_reid@globaltotaloffice.com
Contact: Doug Reid



FORD MOTOR COMPANY OF CANADA LIMITED

FURNITURE GUIDELINES 2012

360° Thinking

Seeing the big picture.



At Global Group, it means integrating our efforts to sustain the earth, air and water into our entire corporate culture, at all levels, in all operations. 360° thinking means that at every stage of every product's life, from conceptualization through manufacturing to reclamation of resources at the end of its life, we ensure that it has the smallest possible negative impact on human well-being and the environment.

360° thinking means going beyond our own walls and working with our suppliers, customers and the broader community to achieve more than we could alone. It means building on past successes and developing new technologies to take us into the future. It's about seeing the results of our efforts in the world around us and knowing that we have laid the foundation so that future generations can carry our success even further.





GRAPHIC

2739

Graphic combines modern styling and detailing with standard posture back mechanism and high value pricing.

List Price

Grade 4
 \$ 536.00

Ford Program Price

\$ 268.00



AVANTI

1947-2

Avanti is the ultimate seating experience for hours of working comfort. The flexible back structure features elasticized mesh stretched over the frame and is augmented with an adjustable lumbar area.

List Price

Grade 4
 \$ 685.00

Ford Program Price

\$ 342.50



ASPEN (Lincoln Only)

2852-3

Aspen is a fully-featured task chair that delivers superior ergonomics, affordability and contemporary styling. What makes Aspen unique is the form fitting back profile, the result of years of extensive testing to determine the optimum support for the widest possible range of users and body types.

List Price

Grade 10 Leather
 \$ 1,198.00

Ford Program Price

\$ 599.00





SUPRA

5331-4

Contoured cushions support the user in comfortable, contemporary style. Supra is available with a standard black fiberglass reinforced nylon base or an optional Tungsten (TUN) finished steel base.

List Price

Grade 4
\$ 406.00

Ford Program Price

\$ 203.00



GLOBAL ACCORD

2671-4

Global Accord is an elegant and refined seating series designed by the renowned designer Zooeu Chu. Global Accord features a finely detailed polished aluminum arm with a sling style back, upholstered with rolled and pleated details, and is available in an array of fabrics. Clean simple lines make Global Accord the perfect choice for meeting rooms, boardrooms and private offices.

List Price

Grade 4
\$ 656.00

Ford Program Price

\$ 328.00



KARIZMA (Lincoln Only)

2761-4

Karizma's True Response™ Support System was designed to encourage movement and to automatically adjust to your body's seated position, personal preferences and body scale.

List Price

Grade 10 Leather
\$ 1,130.00

Ford Program Price

\$ 565.00





SONIC

6514

Sonic, offers exceptional value in a contemporary seating series. A wide range of models suits a variety of interior applications including: meeting rooms, offices, reception areas, cafeterias, waiting rooms and lecture halls.

List Price

Grade 4
 \$ 221.00

Ford Program Price

\$ 110.50



CAPRICE

3365

Caprice is a light scale guest chair. Molded black polypropylene armcaps enhance the comfort and durability of the chair. Seat bottom is finished. Durable black bullet style glide is standard. Steel self-leveling rubber cushioned glide also available as an option. Available in fabric and leather.

List Price

Grade 4
 \$ 420.00

Ford Program Price

\$ 210.00



ZOOEY

8585

Created by world renowned designer Zooney Chu, this high performance "skeletal" chair simplifies task seating. With its high-quality components and soft curved lines, the Zooney chair provides the user with an affordable mesh option.

List Price

Grade 4
 \$ 588.00

Ford Program Price

\$ 294.00



MICHIGAN (Lincoln Only)

1417

Michigan offers classic styling and value in a finely crafted transitional side chair. A combination side chair with wood back, metal frame and upholstered seat. Frame available in Matte Black (BE) or Chrome (CH).

List Price

Grade 10 Leather
 \$ 810.00

Ford Program Price

\$ 405.00





SONIC

6508

Sonic, durable, all purpose seating with arms or armless models.

List Price

Grade 4
 \$ 139.00

Ford Program Price

\$ 69.50



SONIC STOOL

6558

Sonic, durable, all purpose seating with arms or armless models.

List Price

Grade 4
 \$ 243.00

Ford Program Price

\$ 121.50



SONIC STOOL

6554

Sonic, durable, all purpose seating with arms or armless models.

List Price

Grade 4
 \$ 326.00

Ford Program Price

\$ 163.00



APP

1403N

Features curved ply seat with tubular metal base.

List Price

Grade 4
 \$ 632.00

Ford Program Price

\$ 316.00





SONIC BEAM

Sonic Beam is a durable and affordable way to furnish any public seating or reception area. Seating and table units can be placed in any order along the beam.

List Price

Ford Program Price

6500S2 Two Seat Table beam with metal Black beam and Chrome legs
\$ 377.00

\$ 188.50

6500S3 Three Seat Table Beam with metal Black beam and Chrome legs
\$ 446.00

\$ 223.00

6500S4 Four Seat Table Beam with metal Black beam and Chrome legs
\$ 620.00

\$ 310.00

List Price

Ford Program Price

6502 Armless seat unit for beam with upholstered seat and polypropylene back
\$ 246.00

\$ 123.00

6505 Seat unit for beam with arms and upholstered seat and polypropylene back
\$ 284.00

\$ 142.00

6507 Table top for beam
\$ 155.00

\$ 77.50





CITI

7875 RTL

Citi offers a contemporary timeless look that fits anywhere, it is finely scaled – just 31" deep and 30" wide for the club chair, so it works particularly well where space is at a premium or where a lighter scale presence is desired. Citi is finished beautifully in Italian Leather or Leather/Mock Leather combinations. Cushions are sewn with double-needle-stitched seams and sits high and firm, making it extremely appropriate as reception area or office seating.



List Price

Grade 7 Leather / Vinyl
\$ 999.00

Grade 10 Leather
\$ 1,431.00

Ford Program Price

\$ 499.50

\$ 715.50

DOUBLETON (Lincoln Only)

8597HP

The Doubleton lounge chair provides supportive comfort with a crisp, clean, contemporary aesthetic. Available with or without a tablet. A glide / caster option is also available with a chrome pull handle on the exterior of the backrest for easy movement.



List Price

Grade 10 Leather
\$ 2,645.00

Ford Program Price

\$ 1,322.50





3356



WIND TABLES

3356 / 3358 / 3357

Table tops are available in any standard Global laminate finish with square edge detail. Epoxy finished is available at extra cost.

3358



List Price

Ford Program Price

3356 24" Square Corner Table
\$ 503.00

\$ 251.50

3357 Rectangular Corner Table
\$ 660.00

\$ 330.50

3357



3358 36" Square Corner Table
\$ 845.00

\$ 422.50

7886



CITI TABLES

7886 / 7888 / 7889

List Price

Ford Program Price

7888



7886 End Table (20" x 24" x 20"H)
\$ 563.00

\$ 281.50

7888 Coffee Table (20" x 24" x 15"H)
\$ 651.00

\$ 325.50

7889



7889 Square Coffee Table (33" x 33" x 15"H)
\$ 772.00

\$ 386.00





CRR30 / CRR36 30" High Table

List Price

Table with 30" diameter top with chromed base
 \$ 380.00

Table with 36" diameter top with chromed base
 \$ 454.00

Ford Program Price

\$ 190.00

\$ 227.00



CRR30 42" High Table (SQ112013)

Table with 30" diameter top and chromed base.

List Price

\$ 465.00

Ford Program Price

\$ 232.50



ALBA

C36CF

Alba 36" Round Table shown in Tiger Maple (TMP) with four-legged base in Tungsten (TUN).

List Price

\$ 516.00

Ford Program Price

\$ 258.00





CF5036

CF4036

CF3036

CF2036



91365S1

91363S1

CF Series

List Price Ford Program Price

CF2036 Two High (36W x 18D x 27H)
BACWBLAT362H Cabinet with counterweight

\$ 1036.00 \$ 518.00

CF3036 Three High (36W x 18D x 40.5H)

\$ 1,064.00 \$ 532.00

CF4036 Four High (36W x 18D x 54H)

\$ 1,307.00 \$ 653.50

CF5036 Five High (36W x 18D x 62.25H)

\$ 1,622.00 \$ 811.00

BWF1836NFL 36" Top for above filing (Not shown)
All with lock, anti-tip device and hanging file bars

\$ 126.00 \$ 63.00

91363S1 (36W x 18D x 42H)

\$ 833.00 \$ 416.50

91365S1 (36W x 18D x 65.25H)

\$ 1,122.00 \$ 561.00

9300P Series (Not shown)

9336P2F1H Two High (36W x 18D x 27H)
Cabinet with counterweight

\$ 880.00 \$ 440.00

9336P3F1H Three High (36W x 18D x 40.5H)

\$ 864.00 \$ 432.00

9336P4F1H Four High (36W x 18D x 54H)

\$ 1,151.00 \$ 575.50

9336P5F1H Five High (36W x 18D x 62.25H)

\$ 1,422.00 \$ 711.00

* For finishes, please see finishes page at the back of the catalogue.





Other specifications available. Please ask your Global Dealer for details.

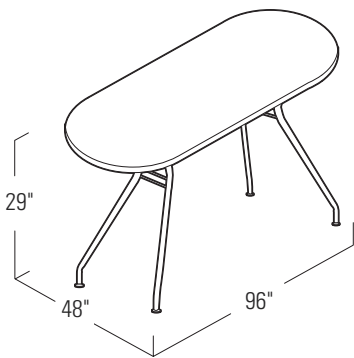

**ALBA
RT8WL**

From meeting rooms to cafeterias, Alba brings excellent value and contemporary styling to a wide range of interior applications.

List Price

\$ 1,243.00

Ford Program Price

\$ 621.50

96W x 48D x 29H - LB: 141.2 - FT³: 12.79





B2072BUF Buffet

Other specifications available. Please ask your Global Dealer for details.

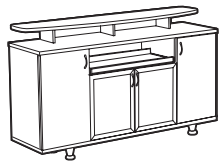

BUNGEE TABLES

BK156S / B2072BUF / B249072AV

Bungee comes complete with top, legs and Bungee cords for an innovative table solution. Ideal for classrooms, training rooms and boardrooms, Bungee tables are quickly and easily reconfigured without ever needing a tool. Tops are 1" thick and offered in a variety of laminate finishes. Legs are available in tapered or spider design. Customize tables with a choice of modesty panels, wire management, grommets and power blocks.

B249072AV Audio Visual Stand

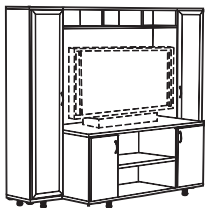

List Price

BK156S
\$ 3,482.00

B2072BUF
\$ 1,997.00

B249072AV
\$ 3,298.00

Ford Program Price

\$ 1,741.00

\$ 998.50

\$ 1,649.00





Option 1

Other specifications available. Please ask your Global Dealer for details.

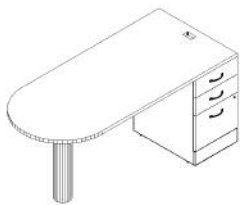

ZIRA/GENOA WORKSTATIONS

Zira is ideal for almost any office application – management, executive, shared teaming and open concept environments. Components can be freestanding for single work station configurations, or joined together to form multiple work groups. Storage can be added where needed.

Option 2

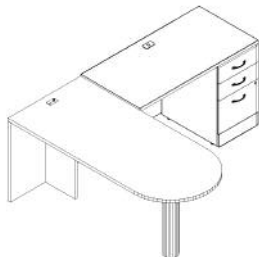

List Price

GWPS30BBF+G3066I

Option 1
\$ 888.00

Option 2
\$ 2,169.00

Ford Program Price

\$ 444.00

\$ 1,084.50



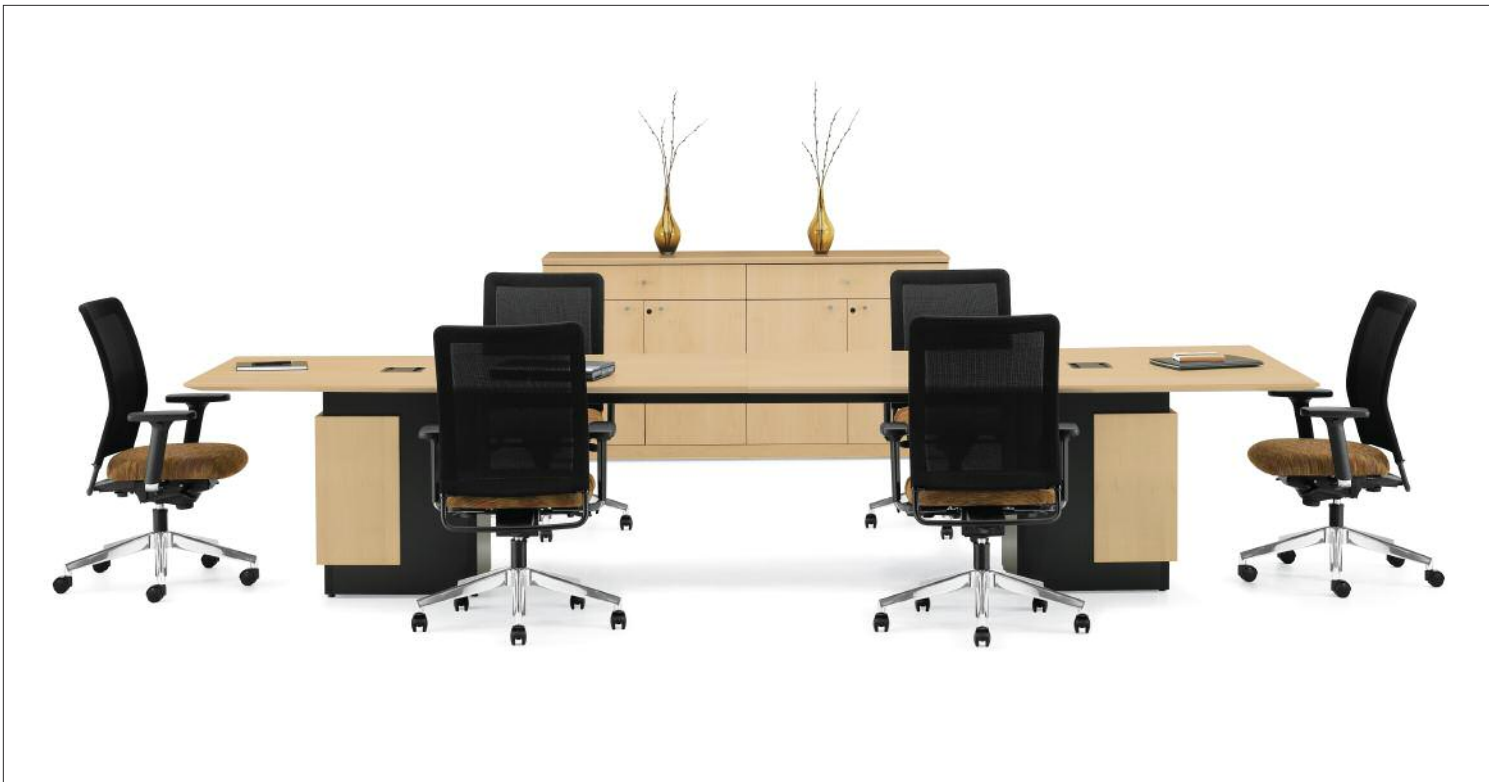

Custom-Designed Tables



Dufferin Table



Square Two Tone
Table Base



Square Two Tone
Mono Table Base



Lecturn



Mobile Server

Office Furniture Dealer will specify and price the required product to fit the space available. Please consult your local Global Group dealer and let them design you a custom tailored solution. To find a local dealer simply go to www.globalcontract.com and click on "Dealer Locator" and enter a postal code or dealer name.





Other specifications available. Please ask your Global Dealer for details.

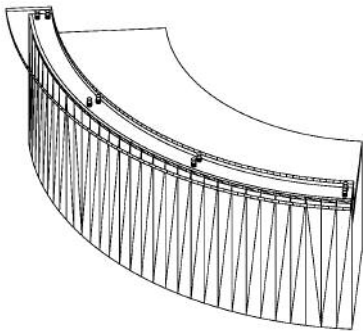

VERSAILLES

SQ58293

List Price

\$ 13,406.00

Ford Program Price

\$ 7,373.30





Option 1

Other specifications available. Please ask your Global Dealer for details.

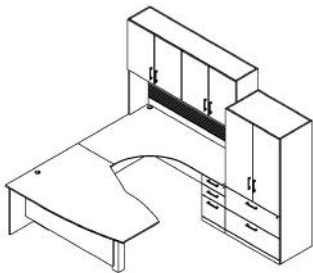

DESCOR DUFFERIN (Wood Veneer Finish)

Dufferin's inspired design fuses the warmth and beauty of real wood with laminate, glass and steel, to present a full spectrum of possibilities. The refined intelligent design creates a simple understated elegance that combines functionality with uncompromised quality.

List Price

Option 1 (Components as shown in photograph)
\$ 1,4024.00

Ford Program Price

\$ 7,713.20

Option 2 (DDDBS7230 with DERR4824DCG)
\$ 3,531.00

\$ 1,942.05

Option 2

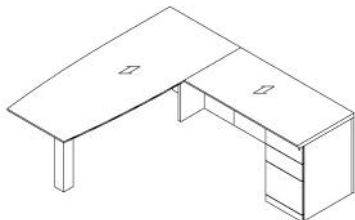



Option 1

Other specifications available. Please ask your Global Dealer for details.

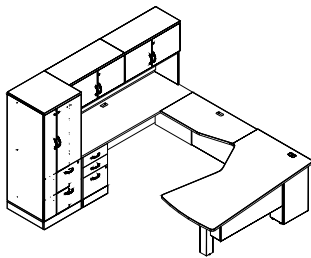

ZIRA DESKING (Laminate Finish)

Imagine an office environment that truly works for you featuring unlimited possibilities for teaming, managerial and executive suites. Zira works to make your work day more efficient. Endless work space components, hundreds of laminate finish combinations – and a host of contemporary options that allow Zira to fit the way you work.

Option 2

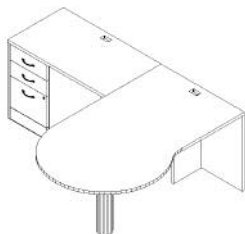

List Price

Option 1
\$ 5,829.00

Option 2
\$ 2,439.00

Ford Program Price

\$ 2,914.50

\$ 1,219.50





Option 1

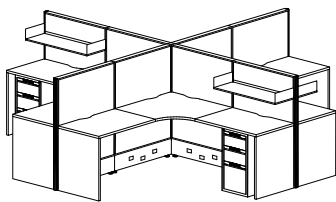

SYSTEM 3

Presenting System 3, the next generation of Boulevard. It brings more value and performance to the workplace than ever before.

List Price

Option 1
\$ 10,743.00

Ford Program Price

\$ 5,236.50

Option 2

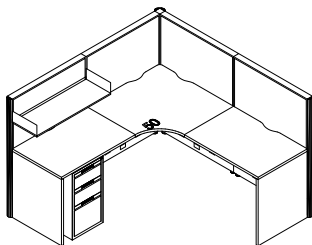

Option 2
\$ 3,907.00

\$ 1,953.50

Other specifications available. Please ask your Global Dealer for details. Finishes as shown for illustration only, for applicable finishes, see finish pages.



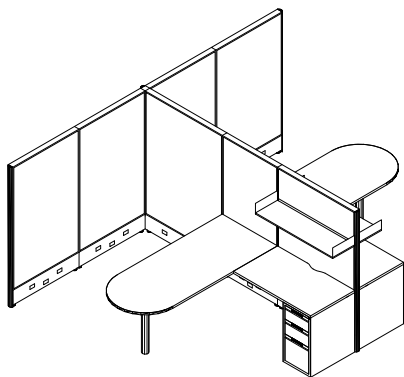

SYSTEM 3

Sales Double Person Station

Customize your work environment to suit your work style by integrating System 3 with Diet and Viceversa components.

List Price

Option 1
\$ 6,470.00

Ford Program Price

\$ 3,235.00

Other specifications available. Please ask your Global Dealer for details. Finishes as shown for illustration only, for applicable finishes, see finish pages.





Seating Fabrics



QUANTUM (Grade 4)
QU20 Cinder



CRESCENT (Grade 4)
792 Cinder Grey

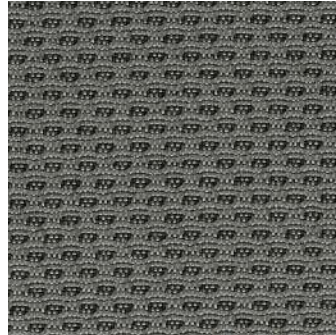

RENEWAL (Grade 4)
RN30 Pewter



CRESCENT (Grade 4)
789 Raven



GRADE 10 LEATHER
(Lincoln Only)
450 Black

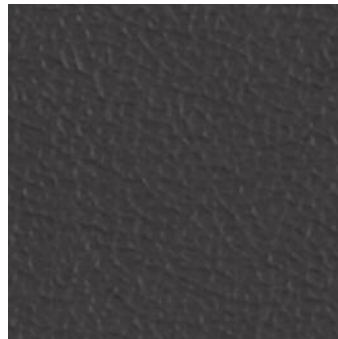

GRADE 10 LEATHER
(Lincoln Only)
477 Graphite



**GRADE 7 LEATHER VINYL
COMBINATION**
450 / 550

Wood Veneer



MPW Maple



JAW Café (Lincoln Only)





Filing

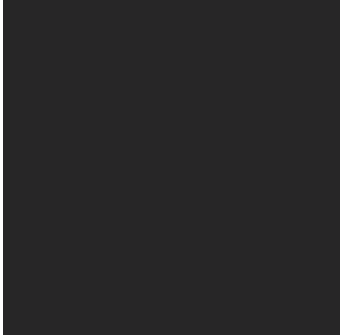

BLK Black

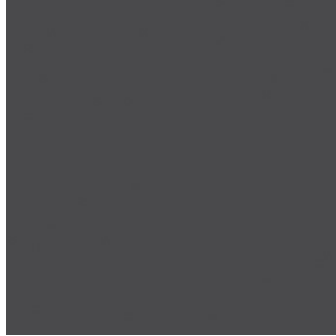

CHR Charcoal



GRY Grey

Laminate

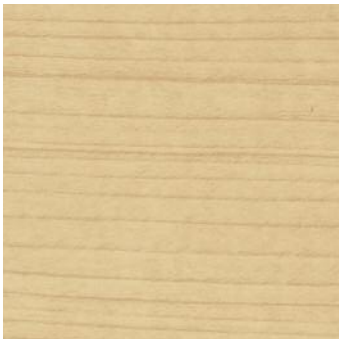

TMP Tiger Maple



BLK Black



TWL Tiger Walnut (Lincoln Only)



TMW Tungsten on Maple
(Reception Area Only)

Panel Fabric



LOOPY
LP62 Marble

**Worksurfaces
& Edge Detail**



CME 8340T Clear Maple

**Panel Frame
& Storage Components**



Tungsten

