

Product and Price Guide

Vorsprung durch Technik

Audi



Model Year 2014. Released September 2013

A5

A5/S5/RS 5 Coupé and A5/S5 Cabriolet

Contents

A5 Introduction	03
Efficiency	04
The advantage of quattro	05
PCP for the A5	06
Pricelist	07
Standard equipment	09
Audi Exclusive	12
SE & S Line	16
Upholstery options	18
Exterior colour options	20
Optional equipment	21
S Line options	25
quattro GmbH options	26
Wheels	27
Technology in the A5	28
Technical Data	30



Introduction

The Audi A5

- a combination of style and power

Exceptional design is something you'll find everywhere in the Audi A5 Coupé and A5 Cabriolet – from the beautiful lines of the exterior to the highly efficient fuel-injection technology within. An aerodynamic shape, muscular wheel arches and low-profile alloy wheels give this car a very special blend of style and performance, which is only emphasised by the choice of dynamic engines and transmissions available.

Audi Ireland has made every effort to ensure the accuracy of this information but does not accept any liability for errors.



Click this target for more information.
Targets are found throughout the Product Guide.

Audi Efficiency Leads the Way

For Audi, efficiency is the sum of a large number of individual measures that combine to produce one major result - the combination of low consumption, comfort and immense driving pleasure. In order to reduce fuel consumption and emissions, the engineers at Audi work intensively on all vehicle components and systems. This applies as much to the continued development of innovative engine technology as it does to highly efficient drivetrain and transmission components, intelligent lightweight body construction and streamlined aerodynamics.

New 1.8TFSI and 3.0TDI engines are the most efficient in their class. Start stop technology is now standard for all variants (manual and s-tronic). New technologies such as better thermal management and electromechanical steering reduce CO₂ emissions. All of this adds up to a clear reduction in CO₂ across the model range

Click the target to find out more about Audi Efficiency



The advantage of quattro®

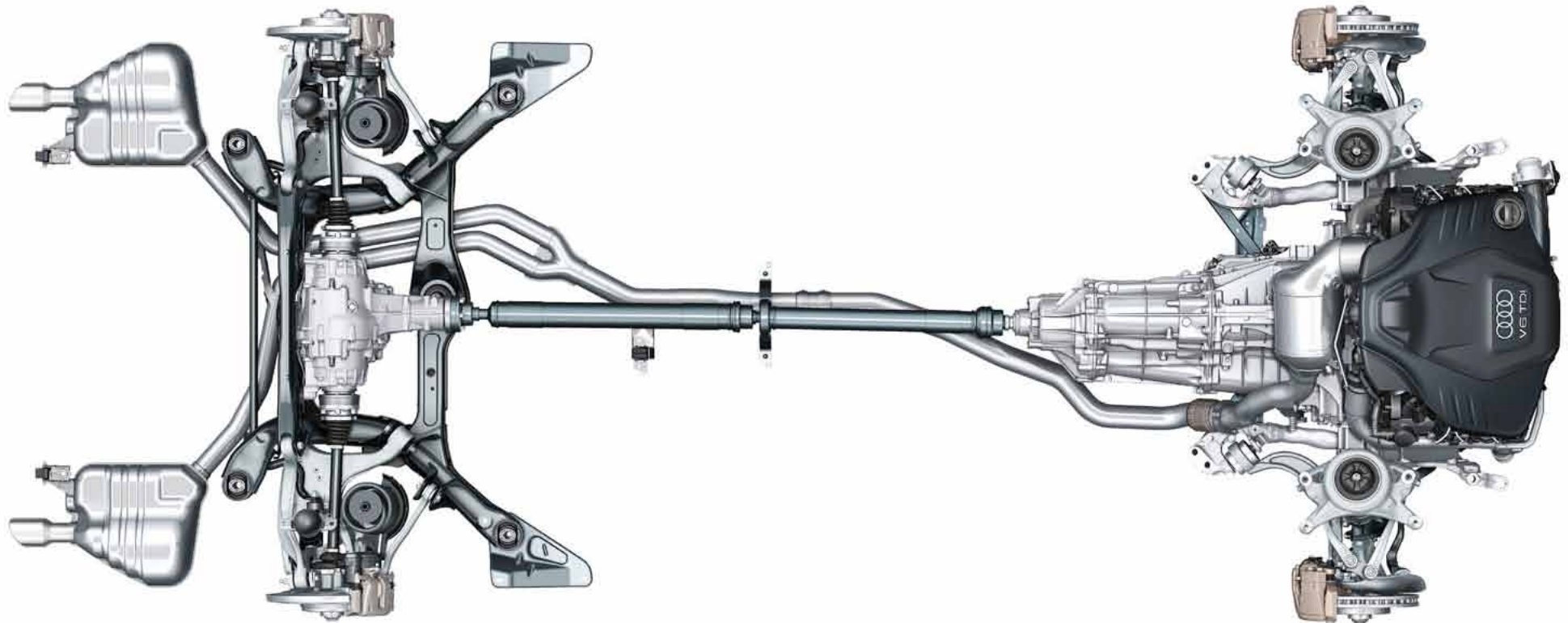

It's the technology that has given Audi the edge on the racetrack ever since it was first introduced over 30 years ago – a technology that delivers ultimate control whilst enhancing the sporty characteristics which make the A5 so thrilling to drive.

Click the target below for more information on quattro

It's called quattro® permanent all-wheel drive. The principle is simple: in the same way that four brakes ensure better deceleration, four permanently-driven wheels deliver better acceleration and road-holding, pushing or pulling the car as needed, for a driving experience that's both dynamic and safe. In the A5, asymmetric dynamic torque distribution continuously distributes drive power between the front and rear axles, depending on weather conditions, road surface and gradient. This leads to greater flexibility and an enhanced, sportier drive.

quattro® with Sports differential

The optional electronically regulated Sports differential distributes variable amounts of drive force to each rear wheel, ensuring outstanding acceleration performance in corners and stabilising the vehicle's response to load change. It also brings better direct steering characteristics and, as it requires less steering effort, more agile handling.

What is a Personal Contract Plan?



Options

Decide on 1 of 3 options

Audi Finance Personal Contract Plan (PCP) gives you flexible finance options and the convenience of a guaranteed future value (GFV) for your new Audi. This personal contract plan is based on a hire purchase agreement with a difference. It allows you to use the equity in the future value of your Audi to reduce your monthly payments and avail of a shorter termed agreement. A PCP contract over 36 months may have similar monthly rentals to a 60 month agreement using traditional hire purchase.

Finance

*Outstanding amount
between the deposit GFV*

You pay a small deposit (as little as 10% of the purchase price) and benefit from attractively low monthly installments and a guaranteed future value for your new Audi. At the end of your contract you may choose to change your Audi for a brand new model, keep it or simply return it to your dealer.

So, whether you want to drive the latest and safest model, upgrade regularly or simply keep your new Audi, Audi Finance PCP makes your money go further.

Deposit

*Click the target to find out more
about Audi Finance and PCP*

A5/S5 Coupé Retail Price List



Model Code	Description	En- gine CC	PS		VRT	Motor Tax	Avg. Fuel (l/100km)	Recomm. Retail Price	Recomm. On the Road Price
Petrol									
8T303CO	A5 Coupé 1.8TFSI 170HP	1798	170	134	B2	€280	5.7	€43,560	€44,360
8T303COE	A5 Coupé 1.8TFSI 170HP SE	1798	170	134	B2	€280	5.7	€46,060	€46,860
8T303COS	A5 Coupé 1.8TFSI 170HP S Line	1798	170	134	B2	€280	5.7	€48,560	€49,360
8T30AYOE	A5 Coupé 2.0TFSI 221HP quattro S-Tronic SE	1984	221	155	C	€570	6.7	€56,260	€57,060
8T30AYOS	A5 Coupé 2.0TFSI 221HP quattro S-Tronic S Line	1984	221	155	C	€570	6.7	€58,760	€59,560
8T3S4YO	S5 Coupe 3.0TFSI V6 333HP quattro S-Tronic	2995	333	189	E	€750	8.0	€79,680	€80,480
8T3RXYO	RS5 Coupe 4.2FSI V8 450HP quattro S-Tronic	4163	450	246	G	€2,350	10.5	€106,890	€107,690
Diesel									
8T30WCO	A5 Coupé 2.0TDI 177HP	1968	177	120	A4	€200	4.6	€46,150	€46,950
8T30WCOE	A5 Coupé 2.0TDI 177HP SE	1968	177	120	A4	€200	4.6	€48,650	€49,450
8T30WCOS	A5 Coupé 2.0TDI 177HP S Line	1968	177	120	A4	€200	4.6	€51,150	€51,950
8T30WHO	A5 Coupé 2.0TDI 177HP Multitronic	1968	177	123	B1	€270	4.7	€48,750	€49,550
8T30WHOE	A5 Coupé 2.0TDI 177HP Multitronic SE	1968	177	123	B1	€270	4.7	€51,250	€52,050
8T30WHOS	A5 Coupé 2.0TDI 177HP Multitronic S Line	1968	177	123	B1	€270	4.7	€53,750	€54,550
8T30W9O	A5 Coupé 2.0TDI 177HP quattro	1968	177	134	B2	€280	5.1	€48,750	€49,550
8T30W9OE	A5 Coupé 2.0TDI 177HP quattro SE	1968	177	134	B2	€280	5.1	€51,250	€52,050
8T30W9OS	A5 Coupé 2.0TDI 177HP quattro S Line	1968	177	134	B2	€280	5.1	€53,750	€54,550
8T30WYO	A5 Coupé 2.0TDI 177HP quattro S-Tronic	1968	177	139	B2	€280	5.3	€51,350	€52,150
8T30WYOE	A5 Coupé 2.0TDI 177HP quattro S-Tronic SE	1968	177	139	B2	€280	5.3	€53,850	€54,650
8T30WYOS	A5 Coupé 2.0TDI 177HP quattro S-Tronic S Line	1968	177	139	B2	€280	5.3	€56,350	€57,150
8T30JYOE	A5 Coupé 3.0TDI V6 245HP quattro S-Tronic SE	2967	245	149	C	€390	5.7	€63,940	€64,740
8T30JYOS	A5 Coupé 3.0TDI V6 245HP quattro S-Tronic S Line	2967	245	149	C	€390	5.7	€66,440	€67,240



A5/S5 Cabriolet Retail Price List



Model Code	Description	Engine CC	PS	Co2	VRT Band	Motor Tax	Avg. Fuel (l/100km)	Recomm. Retail Price	Recomm. On the Road Price
Petrol									
8F703COE	A5 Cabriolet 1.8TFSI 170HP SE	1798	170	143	C	€390	6.2	€53,060	€53,860
8F703COS	A5 Cabriolet 1.8TFSI 170HP S Line	1798	170	143	C	€390	6.2	€55,560	€56,360
8F703HOE	A5 Cabriolet 1.8TFSI 170HP Multitronic SE	1798	170	143	C	€390	6.2	€55,660	€56,460
8F703HOS	A5 Cabriolet 1.8TFSI 170HP Multitronic S-Line	1798	170	143	C	€399	6.2	€58,160	€58,960
8F70AYOE	A5 Cabriolet 2.0TFSI 221HP quattro S-Tronic SE	1984	221	159	D	€570	6.9	€63,260	€64,060
8F70AYOS	A5 Cabriolet 2.0TFSI 221HP quattro S-Tronic S-Line	1984	221	159	D	€570	6.9	€65,760	€66,560
Diesel									
8F7S4YO	S5 Cabriolet 3.0TFSI V6 333HP quattro S-Tronic	2995	333	199	F	€1,200	8.5	€86,680	€87,480
8F3RXYO	RS5 Cab 4.2FSI V8 450HP quattro S-Tronic	4163	450	249	G	€2,350	10.7	€113,890	€114,690
8F70SCOE	A5 Cabriolet 2.0TDI 150HP SE	1968	150	124	B1	€270	4.7	€54,890	€55,690
8F70SCOS	A5 Cabriolet 2.0TDI 150HP S-Line	1968	150	124	B1	€270	4.7	€57,390	€58,190
8F70WCOE	A5 Cabriolet 2.0TDI 177HP SE	1968	177	127	B1	€270	4.7	€55,650	€56,450
8F70WCOS	A5 Cabriolet 2.0TDI 177HP S-Line	1968	177	127	B1	€270	4.7	€58,150	€58,950
8F70WHOE	A5 Cabriolet 2.0TDI 177HP Multitronic SE	1968	177	132	B2	€280	5.0	€58,250	€59,050
8F70WHOS	A5 Cabriolet 2.0TDI 177HP Multitronic S-Line	1968	177	132	B2	€280	5.0	€60,750	€61,550
8F70JYOE	A5 Cabriolet 3.0TDI V6 245HP quattro S-Tronic SE	2967	245	154	C	€390	5.9	€70,940	€71,740
8F70JYOS	A5 Cabriolet 3.0TDI V6 245HP quattro S-Tronic S-Line	2967	245	154	C	€390	5.9	€73,440	€74,240
8F70JYOS	A5 Cabriolet 3.0TDI V6 245HP quattro S-Tronic S-Line	2967	245	154	C	€390	5.9	€72,710	€73,510

Errors and omissions excepted

Standard equipment

Safety and Security

- ▶ Brake pad wear indicator in centre display
- ▶ Front and rear curtain airbags
- ▶ LED Daytime running lights
- ▶ Dipping breakaway interior mirror
- ▶ Driver's and front passenger air bag with front passenger air bag deactivation
- ▶ Electric heated exterior mirrors
- ▶ Electromechanical parking brake
- ▶ Electronic differential lock
- ▶ Electronic stabilization program
- ▶ Electronic vehicle immobilization device
- ▶ First aid kit with warning triangle
- ▶ Front and rear isofix preparation
- ▶ Front and rear curtain airbags
- ▶ Headlight range adjustment
- ▶ Locking wheel bolts
- ▶ Intelligent key
- ▶ Side airbags front (with curtain Airbag for Coupe)
- ▶ Cruise Control
- ▶ Tyre Pressure Monitoring

Audio and communication

- ▶ 6 loudspeakers (80 watts)
- ▶ Audi music interface
- ▶ CD player
- ▶ Concert Radio system
- ▶ Audi Sound System
- ▶ Bluetooth Interface

Seats

- ▶ Head restraints fully adjustable
- ▶ Split folding rear seat
- ▶ Cosine Cloth upholstery
- ▶ Arcade Cloth upholstery (Cabriolet)
- ▶ Seat belts (front and rear) with three point securing mechanism
- ▶ Standard front seats - front seats with manual adjustment of seat height, seat fore / aft position and backrest angle
- ▶ Belt control, electric contact in buckle
- ▶ Electric Front Seat Adjustment (Models over 200bhp)

Interior equipment

- ▶ 2 cup holders in centre console
- ▶ Automatic air conditioning, with sun sensor
- ▶ Door sill trims with aluminium inlay
- ▶ Driver information system (for Start/Stop) with gearshift display in DIS
- ▶ Front and rear electric windows
- ▶ Front centre armrest
- ▶ Inlays in Micro metallic grey
- ▶ Instrument cluster with speedometer, odometer, rev counter & temp display
- ▶ Leather 3 spoke multifunction steering wheel
- ▶ Front and Rear Floor Mats
- ▶ Spectacles holder above rear view mirror
- ▶ Steering column adjustment for rake and reach
- ▶ Tailgate/trunk lid release from inside (electrically)
- ▶ Walnut dark brown inlays (3.0TDI only)
- ▶ Light and Rain Sensor
- ▶ 12V Power Socket (Cabriolet)
- ▶ Storage Package (Cabriolet)

Exterior equipment

- ▶ Diesel particle filter (TDI models only)
- ▶ Exterior Aluminium Pack (Cabriolet)
- ▶ Exterior mirror housings painted in body colour
- ▶ High-gloss package
- ▶ Radio remote controlled central locking
- ▶ Front and rear fog lights
- ▶ Two tone horn
- ▶ Lightweight aluminium hybrid construction body with high strength steel side impact protection
- ▶ Audi single frame grille in high gloss black
- ▶ Side indicators with LED integrated light signal
- ▶ Acoustic Electrically folding hood (Cabriolet)
- ▶ Rear Park Assist
- ▶ Xenon Headlights with LED Rear Lights
- ▶ Chrome covered twin tailpipes

Technical, Wheels, Tyres and suspension

- ▶ 17" cast aluminium alloy wheels, 7.5Jx17, in 5-Spoke design
- ▶ 6-speed manual transmission
- ▶ Brake System with anti-lock brakes ABS, electronic brake force distribution EBD and hydraulic brake assist
- ▶ Audi backguard head restraints
- ▶ Dynamic suspension
- ▶ Space saving spare wheel
- ▶ Start/stop system with energy recovery
- ▶ Recuperation
- ▶ Car Jack + Tool Kit
- ▶ Audi Hold Assist



17" 5 Spoke Alloy



Xenon Lights with LED daytime running lights



Concert Radio and Climate Control



Driver Information System

The Audi **S5** Standard Equipment

Wheels, Tyres and Suspension

- ▶ 'S' Sports suspension
- ▶ Size: 18" Alloy - Style: 5 S- spoke design
- ▶ 'S' model enhanced braking system



Interior Equipment

- ▶ 3-spoke 'S' Sports multi-function leather steering wheel with paddle shift and contrasting stitching
- ▶ Aluminium scuff plates with S5 logo
- ▶ Interior lighting package
- ▶ Inlays in matt-brushed aluminium
- ▶ 'S' instrument dials
- ▶ Driver Information System with Colour Display

Seats

- ▶ Alcantara/leather upholstery
- ▶ Sport seats with electric adjustment
- ▶ Electric Lumbar Support

Exterior Equipment

- ▶ Aluminium-effect door mirror housings
- ▶ Chrome Exhaust pipes – twin on left- and right-hand side
- ▶ 'S' radiator grille with S5 logo
- ▶ Painted brake callipers with S5 logo
- ▶ 'S' body styling



S5 Coupe / Cabriolet		Engine CC	BHP	Co2	Band	Motor Tax	Recomm. Retail Price	On the Road Price
8T3S4Y0	S5 Coupé 3.0TFSI V6 333HP quattro S-Tronic	2967	333	189	E	€ 750	€78,690	€79,490
8F7S4Y0	S5 Cabriolet 3.0TFSI V6 333HP quattro S-Tronic	2967	333	199	F	€ 1,200	€85,680	€86,480

The Audi **RS 5** Standard Equipment

Additional Standard Equipment over S5

- ▶ 19-inch forged aluminium wheels, 10-spoke design
- ▶ S sports seats at front
- ▶ Flat-bottomed RS 5 leather sports steering wheel with shift paddles
- ▶ Carbon inlays
- ▶ Audi drive select
- ▶ Parking system plus
- ▶ quattro with sports differential
- ▶ Fine Nappa leather Upholstery
- ▶ RS 5 Sports Suspension
- ▶ Folding Rear Seat bench
- ▶ Ant-glare rear view mirror
- ▶ Anti-Theft Alarm
- ▶ Tracker preparation
- ▶ Leather covered armrests



The standard specification of the Audi RS 5 Coupé is exemplary. It has been enhanced in comparison to the Audi S5 Coupé and impresses with its high quality and progressive technology. For details on option prices for the RS 5, please consult your local Audi Dealer

Selected Optional Extras for the RS 5

- ▶ 20-inch cast aluminium wheels, 5-arm "Rotor" design, optionally in titanium look, machine-polished
- ▶ Aluminium matt styling package
- ▶ Carbon design package for the engine compartment
- ▶ Sports exhaust system with black tailpipe trims
- ▶ Sports suspension plus with Dynamic Ride Control (DRC)
- ▶ Top speed limited to 280 km/h
- ▶ 19-inch ceramic brakes (at the front)
- ▶ RS 5 front bucket seats



RS 5 Coupé		Engine CC	BHP	Co2	Band	Motor Tax	Recomm. Retail Price	On the Road Price
8T3RXYO	RS5 Coupe 4.2FSI V8 450HP quattro S-Tronic	4163	450	246	G	€2,350	€105,560	€106,360
8F3RXYO	RS5 Cab 4.2FSI V8 450HP quattro S-Tronic	4163	450	249	G	€2,350	€112,560	€113,360

Audi Exclusive



[Click this target to find out more about Audi Exclusive](#)

Audi Exclusive



Every Audi is intrinsically exclusive. It's the breathtaking design, the exceptional engineering, the Vorsprung durch Technik. But for that special touch you can specify your new A5 with options from Audi exclusive.

Whether you want a unique, custom-mixed paint colour or seats in a combination of complementary shades, Audi exclusive will enable you to drive the car you've always imagined.

Both the exclusive and standard options can be found in this Product Guide



Audi Exclusive

Upholstery

With Audi exclusive, you can specify your seats in Valcona, Fine Nappa leather or a leather/Alcantara combination, in an array of different colours shown to the right.

Select just one all-over shade for each seat, or customise each panel in two or more complementary colours from the distinctive Audi exclusive palette. You can even choose the colour of the decorative stitching – to match or contrast with your chosen upholstery – from this varied collection. Whatever combination you decide upon, we think you'll be extremely comfortable with the result.

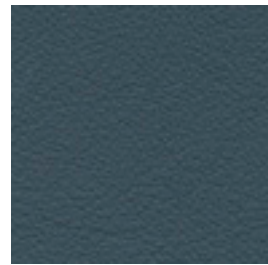

Jet grey

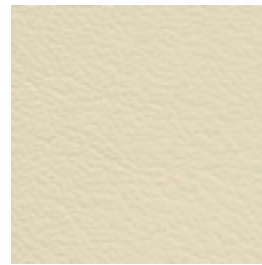

Alabaster white

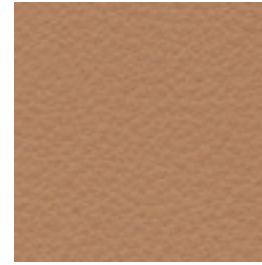

Sand beige

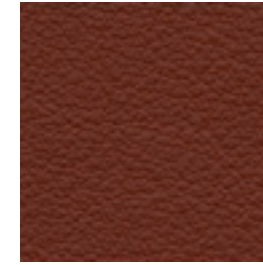

Saddle brown



Chestnut brown



Crimson red

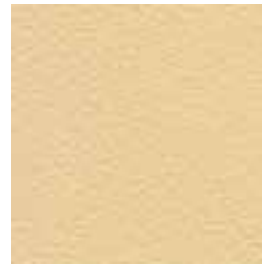

Magnolia white

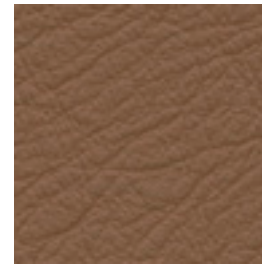

Havanna brown



Cognac brown

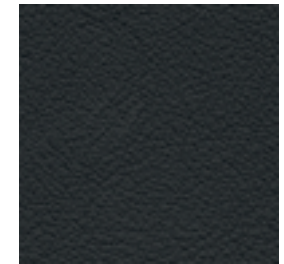

Night blue



Cloudy grey

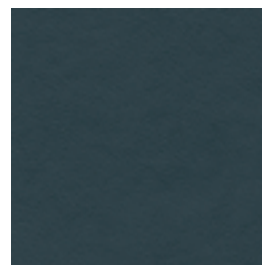

Smoky blue

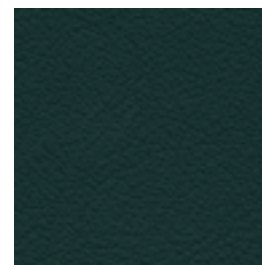

Iceland green



Powder beige



Classic red

Audi Exclusive leather package prices start from €2,844 on top of Nappa Leather prices.

Audi Exclusive

Paint

Everyone has a favourite colour. No matter what yours is, Audi exclusive provides a range of unique colours that have been designed to set your car apart. Choose from the swatches here, or specify any other paint colour in the Audi range – whether it's Jet blue from the Audi R8 or Alpine white from the original Audi quattro. The choice is yours.



Palace blue, pearl effect



Sand beige, pearl effect



Saddle brown, pearl effect

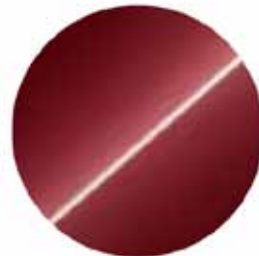

Classic red, pearl effect



Mamba black, metallic



Ipanema brown, metallic

Customised

If you have a particular colour in mind, we'll mix the exact metallic or pearl-effect shade you want.*

*Custom paint is subject to factory approval, and is available for metallic and pearl-effect water-based paints only. Three-colour process colours and two-tone schemes are not available.
*Visit your local Audi Dealer for colour samples.

All the colour swatches on this page are matched as accurately as possible to the actual paint colours used. However, due to print processes, Audi Ireland cannot guarantee that colours shown are 100% accurate. Visit your local Audi dealer for a more accurate colour swatch.



Customised paint

Audi Exclusive paint prices start from €2,274 (Tax Band A4) on top of metallic paint prices

SE

SE models add the following equipment for a premium of €2,500 over entry-level models

- ▶ 18" 5 V-spoke Alloy Wheels
- ▶ Milano Leather
- ▶ Heated front seats
- ▶ Colour Driver Information System
- ▶ Auto Dimming Rear View Mirror

Ordered individually, these items would cost almost €4,200, ensuring a customer advantage of €1,700, or over 40%.



18" 5-spoke-V design Alloys (Coupé)



18" 15 spoke star design - (Cabriolet)



Milano Leather Upholstery



Colour Driver Information System

S Line

S Line adds the following equipment for €2,500 over SE Models

- ▶ 18" 5 Twin spoke Alloy Wheels
- ▶ S Line Sport Suspension
- ▶ S Line door sill trims in aluminium
- ▶ Gear lever knob in black perforated leather
- ▶ 3 Spoke S Line sport multifunction steering wheel
- ▶ S line front and rear sports bumpers
- ▶ Chrome-plated trims for exhaust tailpipe
- ▶ S Line badges on the front wings
- ▶ Headlining in black cloth
- ▶ Leather/Alcantara sport seats with embossed S Line logo



S Line will also feature all the equipment in the SE. S Line will be available for €2,500 over SE pricing representing a customer advantage of 63%.



S Line 3 Spoke Sports Steering Wheel



18" 5 Twin-Spoke Alloy Wheels



Leather/Alcantara Sport Seats with S Line logo

Upholstery options - A5 Coupé

Order code		FZ	IB	IC	ID	IE	IF	VR	QE	QZ
Upholstery		Black	Garnet Red	Lunar Silver	Velvet Beige	Titanium Grey	Velvet Beige	Chestnut	Black	Black
										Jet grey
Dashboard		Black	Black	Black	Black	Steel Grey	Moor Brown	Black	Black	Black
		Black	Black	Black	Black	Steel Grey	Moor Brown	Black	Black	Black
Carpet		Black	Black	Black	Black	Steel Grey	Moor Brown	Black	Black	Black
Headlining		Lunar Silver	Lunar Silver	Lunar Silver	Pashmina Beige	Lunar Silver	Pashmina Beige	Lunar Silver	Black	Black
Standard Seats	N0B - Arcade Cloth	•				•	•			
	N5W - Milano Leather	•			•	•	•			
	N3Q / 7HB - Fine Nappa leather	•				•		•		
Sport Seats	N2E - Atrium cloth	•				•				
	N7U - Alcantara/leather	•		•		•				
	N5W - Milano Leather	•			•	•	•			
	N3Q / 7HB - Fine Nappa leather	•	•	•	•	•	•	•		
Comfort Seats (PS8)	N5W - Milano Leather	•			•	•	•	•		

S Line models only

Sport Seats (WQS)	N7K - S Line Alcantara / Leather									•
	N2R - S Line Fine Nappa Leather								•	

Upholstery options - A5 Cabriolet

Order code		JN	GD	IJ	BI	FW	AI	IH	AO	BF	AA	TZ	IF	QE	QZ
Upholstery		Black	Garnet Red	Lunar Silver	Lunar Silver	Lunar Silver	Lunar Silver	Chennai	Black	Red	Red	Chennai	Velvet Beige	Black	Black Jet grey
Dashboard		Black	Black	Black	Black	Black	Black	Black	Black	Black	Black	Black	Moor Brown	Black	Black
		Black	Black	Black	Black	Black	Black	Black	Black	Black	Black	Black	Moor Brown	Black	Black
Carpet		Black	Black	Black	Black	Black	Black	Black	Black	Black	Black	Black	Moor Brown	Black	Black
Headlining		Black	Lunar Silver	Lunar Silver	Pashmina	Black	Star Silver	Black	Black	Black	Star Silver	Black	Pashmina	Black	Black
Standard Seats	N0B - Arcade Cloth	•	•	•	•										
	N5W - Milano Leather	•	•	•	•							•	•		
Sport Seats	N7U - Alcantara/leather	•	•	•	•							•	•		
	N5W - Milano Leather	•	•	•	•							•	•		
	N3Q / 7HB - Fine Nappa leather	•	•	•	•	•	•	•	•	•	•	•	•		
Comfort Seats	N5W - Milano Leather	•	•	•	•			•	•			•	•		

S Line models

Sport Seats	N7K - S Line Alcantara / Leather															•
	N2R - S Line Fine Nappa Leather														•	

Hood Colours (Cabriolet)

			
Brown PW	Black PA	Red SE	Grey SW

Exterior colour options

Solid Paints



Brilliant Black
A2A2



Ibis White
T9T9



Brilliant Red
C8C8



Estoril Blue crystal effect
KOKO



Prisma Silver crystal effect
TOTO

Metallic and Pearl Effect Paints**



Glacier White metallic
2Y2Y



Monsoon Grey metallic
0C0C



Teak Brown metallic
4U4U



Moonlight Blue metallic
W1W1



Scuba Blue metallic
S9S9



Ice Silver metallic
P5P5



Dakota Grey metallic
Y7Y7



Shiraz Red metallic
3A3A



Cuvé Silver Metallic
0D0D



Lava Grey pearl effect
1R1R



Daytona Grey pearl effect
6Y6Y**



Misano Red pearl effect
N9N9**



Phantom Black pearl effect
L8L8

*Metallic and Pearl Effect paint prices begin at €1,138

** Daytona Grey pearl effect & Misano Red pearl effect available on S Line only at regular prices. Otherwise available on entry and SE models at Audi Exclusive Paint prices.

*** Crystal Effect paint prices start from €2,154 (Band E)

Optional equipment

Prices reflect VRT Band A4 unless otherwise stated. For option pricing for higher bands, please contact your Audi Dealer

		Prices From (€)
1BE	Sports Suspension	377
1BL	Damping Regulation - Can only be ordered with 2H1	1565
1BV	S Line Sports Suspension	803
1D2	Towing bracket - removable	1102
1N8	Dynamic Steering - Can only be ordered with 2H1	1422
1XX	Leather covered multifunctional sport steering wheel 3 Spoke with shift paddles. Automatic Transmissions only. Standard on S5	223
2H1	Audi Drive Select - changes your car's handling and responses at the touch of a button to suit the way you want to drive. There are five modes: comfort, dynamic, auto, individual and efficient. When operating in efficiency mode, the engine and gear shift programmes are altered to optimise fuel consumption. Even the air conditioning system is configured to allow for optimum energy use.	284
2PF	Leather covered Multifunction sports steering wheel 3 Spoke - flat bottomed	148
2PK	Leather covered Multifunction sports steering wheel 3 Spoke - flat bottomed with shift paddles Automatic Transmissions only.	373
2ZS	Leather covered multifunction steering wheel 4 Spoke with shift paddles. Automatic Transmissions only.	223
2Z0	Badge Deletion (Model and Capacity deletion). Not available on S5	0
3FC	Electric panoramic sunroof - Coupé Only	1607
3X2	Load through facility with removable ski bag	284
3Y2	Electric blind for rear window - Coupé Only	391
4A3	Seat heating for front seats - Individually adjustable to 6 settings.	499
4A4	Seat heating for front seats and outer rear seats - Can only be ordered with N2M, N5W or N3Q	881
4F2	Advanced Key - Access and authorisation system which automatically exchanges data between key and vehicle, allowing the driver to keep the key in their pocket or bag at all times. To unlock and open, simply lift the exterior door handle. To lock, press the button on the handle. Pressing the start/stop button integrated in the centre console starts and stops the engine	875
4L6	Interior Mirror with automatic anti glare action with rain sensor. Standard on SE	220
4ZD	Audi Exclusive Black Styling Package	527
5MG	Burr walnut dash shiny. Standard on 3.0TDI. Not available on S5	554



3FC Electric panoramic sunroof - Coupé Only



2PF Leather covered Multifunction sports wheel

Optional equipment

Prices reflect VRT Band A4 unless otherwise stated. For option pricing for higher bands, please contact your Audi Dealer

		Prices From (€)
5MU	Aluminium Trigon Inlays. Not on S5	270
5MT	Beaufort Oak Inlays. Not on S5	767
5TB	Inlays in Aluminium and Beaufort Wood black	1528
5TL	Piano Black Inlays	583
6NQ	Headlining in Black cloth - Coupé Only. Not on S5	363
6XE	Electrically adjustable/folding/heated exterior mirrors.	321
6XK	Electrically adjustable/folding/heated exterior mirrors with anti glare action - Can only be ordered with 4L6	491
6XL	Heated exterior mirrors with anti glare action and memory folding function - Can only be ordered with PV3 and 4L6	491
7AL	Anti theft alarm - Including interior monitoring and tow away protection.	641
7A6	CD changer for MMI & MMI plus. Only in conjunction with PNW	597
7D1	CD changer and DVD player (for PNG). Only in conjunction with PNQ	597
7G9	Preparation for theft tracking system. Only in conjunction with 7AL	150
7HB	Extended Leather Package	357
7P1	Electric lumbar support for the front seats	377
7S1	Wind Blocker - Cabriolet Only	445
7TL	Fine Grain Ash Inlays. Not on S5	555
7X4	Audi Parking System Plus. Includes parking sensors on the front and rear with a visual proximity warning in the MMI screen	541
7X8	Audi parking system advanced - Aids parking by acoustically and visually indicating distances to obstacles with guiding lines. Measured by sensors and reversing camera. - Can only be ordered with PNW	1180
7Y1	Audi side assist - Aids the driver when changing lane. Audi side assist monitors the area behind the car using radar sensors located discreetly in the rear bumper, informing the driver with a visual warning signal in the door mirror if there is a vehicle in their blind spot or approaching quickly from behind - Can only be ordered with 8N6	783
7Y4	Audi active lane assist - Uses a discreet camera mounted at the top of the windscreen to monitor the road ahead. Assists the driver to stay in lane with gentle steering impulses. Informs driver if car is drifting out of lane unintentionally above 60kph.	725
7Y5	Audi Side and Active Lane Assist	1508
8N7	Light and Rain sensor with high beam assist - Automatically adjusts headlights from high-beam to dipped-beam when another vehicle is approaching. - Can only be ordered with 4L6	399
8Q5	Adaptive lights - Swivelling headlights for improved illumination of a winding road	541



5MU Aluminium Trigon Inlays

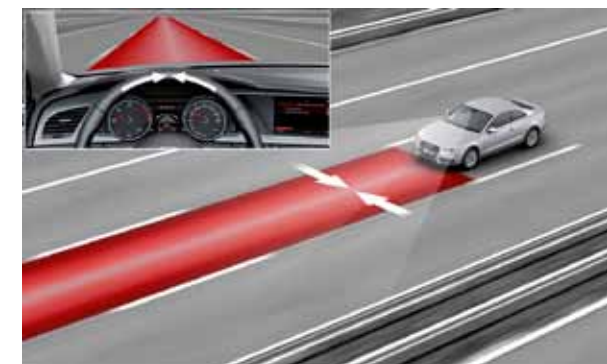

7Y5 Audi Active Lane Assist

Optional equipment

Prices reflect VRT Band A4 unless otherwise stated. For option pricing for higher bands, please contact your Audi Dealer

		Prices From (€)
8T4	Adaptive cruise control - Intelligent automatic speed and distance control system. Works at speeds from 19-155mph, using radar sensors to measure and maintain required distance to vehicle ahead by braking and accelerating. - Can only be ordered with 9Q8	1450
8UM	Symphony Radio - AM/FM twin tuner with TP memo function. Front-loading 6-CD changer with MP3 compatibility and active front and rear speakers. Includes colour centre console screen, SD memory-card reader and AUX-IN socket. Cannot be combined with Satellite Navigation.	369
9AQ	Automatic Air Conditioning plus - Can only be ordered with 9Q8	647
9Q8	Driver information system with colour display and efficiency program. Standard on SE	164
9VK	Bang & Olufsen Sound System - Designed specifically for the Audi A5 Coupé, providing surround sound reproduction with dynamic compensation for road noise, 5.1 surround sound. 10-channel amplifier and 14 speakers. Output 505 Watts. Savings when purchased with WI1	990
9Z3	230V socket - In rear centre console. Replaces rear 12v socket if ordered.	192
GH2	quattro - with sports differential . Only available on 245bhp and above	1447
MP1	Metallic Paint	1138
MP7	Pearl Effect Paint	1138
N3Q	Silk Nappa Leather - Can only be ordered with 7HB. Savings when ordered on SE models	3201
N5W	Milano Leather . Standard on SE.	2552
N7U	Alcantara / Leather - Can only be ordered with PS1. Not on S5	1857
PCB	Assistance Package - Park System Plus, Active Lane Assist and Active Cruise Control. Not on S5	1180
PKH	Luggage compartment package - consisting of a combined net in the luggage compartment, fastening hooks, luggage net on the righthand side of the luggage compartment, strap in the left-hand trim to secure small objects; loading sill cover in high gloss polished Stainless steel.	138
PNW	MMI® navigation - Includes MMI High and colour Driver's Information System (DIS). Integrated into the MMI is a clear map display with special destinations indicated by symbols, high-speed map loading, zoom function, selection of address book destinations, target memory, dynamic route guidance with TMC. Part of WI1	2474
PNQ	MMI® navigation plus - 3rd generation MMI system including single CD/DVD player, 2 FM tuners, high resolution (800x400) 7" colour TFT display, 2 SD card readers and 40GB hard drive, Jukebox (20 GB) for storing and managing music files in WMA and MP3 format. HDD navigation functionality includes advanced speech recognition, 3D and topographical mapping display and advanced 3D building display. Savings when purchased with WI1 . Only in conjunction with 9Q8	3484
PS1	Front Sports Seats . Only in conjunction with N2B, N7U or N5W	845

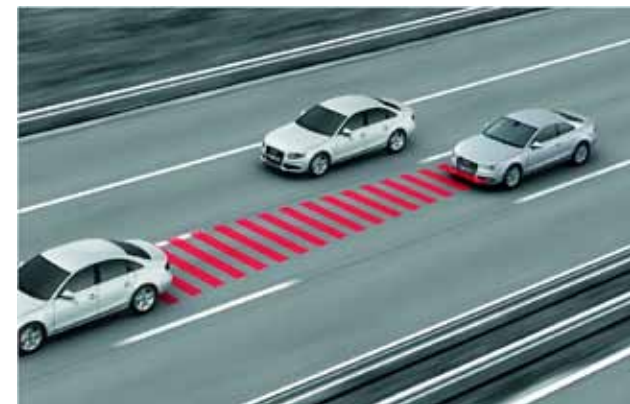

8T4 Adaptive Cruise Control



N3Q Silk Nappa Leather Interior

Optional equipment

Prices reflect VRT Band A4 unless otherwise stated. For option pricing for higher bands, please contact your Audi Dealer

		Prices From (€)
PS8	Climate Controlled Comfort Seats - Can only be ordered with 9AQ, N5W,4A3 and PV1/PV3	1252
PT4	Bluetooth car phone online with cordless handset. Can only be ordered with PNQ	1821
PT5	Bluetooth Mobile phone prep in centre armrest	747
PV1	Electrically Adjustable Front Seats. Standard on 204bhp and above	1464
PV3	Convenience Package - Comprising electric front seats with memory on driver's side & lumbar support. Includes folding and auto-dimming door mirrors with memory function and auto-dimming rearview mirror	2468
QE1	Storage Package - Includes nets on the back of the front seats, storage compartment under the front seats, drinks holder in rear centre armrest and lockable glove box. Standard on Cabriolet	164
QQ1	Lighting Package - Includes reading lights at rear, illuminated vents, make up mirrors, entrance lighting, front footwell lighting and illuminated glove box. Savings when purchased with W11. Standard on S5	192
QU6	Digital radio reception (DAB) and TV reception - Reception of digital (DVB-T) uncoded television stations (MPEG-2 standard), TV picture, teletext and Electronic Programme Guide (EPG). Facility to connect 2 external AV sources via adaptor cables (available from Audi Genuine Accessories). Please note: TV reception depends on local digital network availability. No AV or TV video output when driving (audio output available when driving). Can only be ordered with PNQ	1899
QU7	TV Reception - Reception of digital (DVB-T) uncoded television stations (MPEG-2 standard), TV picture, teletext and Electronic Programme Guide (EPG). Facility to connect 2 external AV sources via adaptor cables. Can only be ordered with PNQ	1422
QV3	Digital Radio Reception - Integrated into MMI, receives digitally-transmitted radio stations in addition to the range of analogue stations. Displays music track, artist and radio program. Reception dependent on local digital network. Automatic switch from DAB to FM reception if the network signal is not strong enough	477
UH2	Audi hold assist - Uses either ESP or electromechanical parking brake to hold the vehicle stationary. Standard on S5	114
VC1	Garage Door Opener - Programmable radio-operated remote control for compatible doors/gates. Control buttons integrated in the front roof module	335
VW1	Tinted windows - Translucence (27%) for rear door and side windows and rear window. Coupe Only	597



PS6 S Sport Seats



UH2 Audi Hold Assist

S Line Options

Prices reflect VRT Band A4 unless otherwise stated. For option pricing for higher bands, please contact your Audi Dealer



		Prices From (€)
WI2	S Line Black Package. Not available on S5	1911
N2R	Seat upholstery in Valcona Leather	1210
PS6	S Sport Seats - Can only be ordered with N3Q and PV1/PV3	1985
PQR	18" 5 spoke quattro GMBH alloys	0
PQ5	18" 10 spoke quattro GMBH alloys	0
PQ6	18" 5 segment quattro GMBH alloys	924
PQS	19" 15 spoke quattro GMBH alloys	924
PQF	20" 7 twin spoke quattro GMBH alloys	1707
PQT	19" 5 arm rotor design quattro GMBH alloys	1209
2PK	S Line sports steering wheel, 3-spoke, flat-bottomed, with shift paddles. Automatic Transmission Only	373
1XX	S Line sports steering wheel, 3-spoke design, with shift paddles. Automatic Transmission Only	0
5TL	Inlays in Piano finish black	555
5TZ	Inlays in Fine grain birch wood grey	555
5MZ	Inlays in Stainless steel mesh	635



Audi Exclusive



















Prices reflect VRT Band A4 unless otherwise stated. For option pricing for higher bands, please contact your Audi Dealer



		Prices From (€)
WQK	Audi exclusive line Sports seats including electric lumbar support. Seat upholstery in two-colour Valcona leather (seat side sections in black, seat centre section in cognac magnolia white or alabaster white). Seat side sections and head restraints with coloured piping steering wheel rim and gear gaiter with coloured stitching, piping and stitching to match seat centre section. Leather door trim inserts to match seat centre section. Inlays in matt brushed aluminium. Optional: Walnut brown inlay, Piano finish black inlay. Black floor mats with coloured leather piping, colour as for seat centre. Black cloth headlining. Leather-covered sports steering wheel with coloured stitching on steering wheel rim, colour as for seat centre section. Optional: 3-spoke leather-covered multifunction sports steering wheel with or without gearshift function with coloured stitching on steering wheel rim as seat centre. Door sill trims Audi exclusive	5,918
QOQO	Audi exclusive customised paint finish	3,300
YTA	Audi exclusive inlays	1316
5TL	Piano Black inlays	555
5TZ	Fine Grain birch wood grey inlays	555
YSQ	Audi exclusive carpet incl. additional front and rear floor mats	1422
YSR	Audi exclusive floor mats with leather piping	576
PYB/S3G	Audi exclusive leather trim (package 1), Leather Valcona The following items are in leather (Coupe only): Front and rear seat upholstery in leather. Head restraints in leather. Door trim inserts in leather. Front centre armrest (if ordered) in leather. Seat side trims and add-on seat parts are colour-coordinated with the interior code. Price given on SE Models	3,991
PYC/S3G	Audi exclusive leather trim - Package 1 (As PYB with the following additons) (Coupe only): Alcantara/Leather. The following items are in alcantara/leather: Front and rear seat centre section in alcantara, seat side trims in leather. Door trim inserts in alcantara. Price given on SE Models	3,991
PYE/S3G	Audi exclusive leather trim - Package 2 (As PYB with the following additons) (Coupe only): Leather Valcona. Leather backrest covers for front seats. Seat side trims and add-on seat parts are colour-coordinated with seat upholstery Arm rest in leather. Price given on SE Models	5,412
YRB/S3G	Audi exclusive "leather" control elements	1,137
YRI/S3G	Audi exclusive part wood leather - covered steering wheel	1,137
YRH/S3G	Audi exclusive "leather" steering wheel rim	654

A5 Wheels

Prices reflect VRT Band A4 unless otherwise stated. For option pricing for higher bands, please contact your Audi Dealer

			Prices From (€)			Prices From (€)			Prices From (€)					
CD7		Size: 17" Alloy Style: 5 arm styling Tyre Size: 225 / 50 R17 Wheel Size: 7.5J x 17	Entry	0	PQG		Size: 18" Alloy Style: 5 twin spoke design Tyre Size: 245 / 40 R18 Wheel Size: 8.5J x 18	Entry	1557	PQS		Size: 19" Alloy Style: 20-spoke design Tyre Size: 255 / 35 R19 Wheel Size: 9J x 19	Entry	2481
	SE	-	SE	-		SE	463	SE	1387					
PRW		Size: 17" Alloy Style: 7 arm parabolic Tyre Size: 225 / 50 R17 Wheel Size: 7.5J x 17	Entry	0	PQR		Size: 18" Alloy Style: 5 spoke design Tyre Size: 245 / 40 R18 Wheel Size: 8.5J x 18	Entry	1557	PRJ		Size: 19" Alloy. S5 Only Style: 5-parallel-spoke Tyre Size: 255 / 35 R19 Wheel Size: 8.5J x 19	Entry	0
	SE	-	SE	-		SE	463	SE	0					
PRS		Size: 17" Alloy Style: 6 spoke parabola Tyre Size: 245 / 45 R17 Wheel Size: 8J x 17	Entry	290	PQ5		Size: 18" Alloy Style: 10-spoke design Tyre Size: 245 / 40 R18 Wheel Size: 8.5J x 18	Entry	1557	PQT		Size: 19" Alloy Style: 5 arm rotor Tyre Size: 255 / 35 R19 Wheel Size: 9J x 19	Entry	2766
	SE	-	SE	-		SE	463	SE	1671					
PRM		Size: 18" Alloy Style: 5 V spoke design Tyre Size: 245 / 40 R18 Wheel Size: 8.5J x 18 Standard on SE Coupe	Entry	1094	PRK		Size: 19" Alloy Style: 10 Spoke Design Tyre Size: 255 / 35 R19 Wheel Size: 8.5J x 19	Entry	2190	PQF		Size: 20" Alloy Style: 7-double-spoke Tyre Size: 265 / 30 R20 Wheel Size: 9J x 20	Entry	3263
	SE	0	SE	0		SE	1096	SE	2170					
PRR		Size: 18" Alloy Style: 15 spoke star Tyre Size: 245 / 40 R18 Wheel Size: 8.5J x 18 Standard on SE Cab	Entry	1094	PRV		Size: 19" Alloy Style: 5 arm Y-styling Tyre Size: 255 / 35 R19 Wheel Size: 8.5J x 19	Entry	2190	PQK		Size: 20" Alloy Style: 7-double-spoke Titanium Look Tyre Size: 265 / 30 R20 Wheel Size: 9J x 20	Entry	3263
	SE	0	SE	0		SE	1096	SE	2170					
PRL		Size: 18" Alloy Style: 5 Arm Dynamic Tyre Size: 245 / 40 R18 Wheel Size: 8.5J x 18	Entry	1094	PQ6		Size: 19" Alloy Style: 5-segment-spoke design Tyre Size: 255 / 35 R19 Wheel Size: 9J x 19	Entry	2481	PQ8		Size: 19" Alloy Style: 5-segment-spoke design. Titanium Tyre Size: 255 / 35 R19 Wheel Size: 9J x 19	Entry	2481
	SE	0	SE	0		SE	1387	SE	1387					

Audi A5 Technology

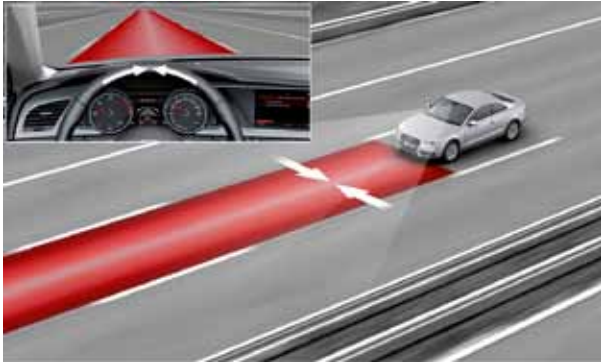

Audi active lane assist*

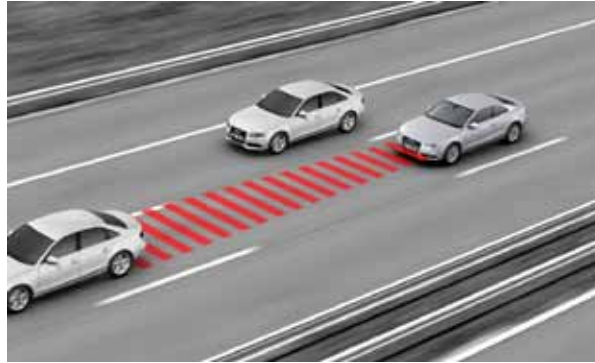

Audi pre-sense front*

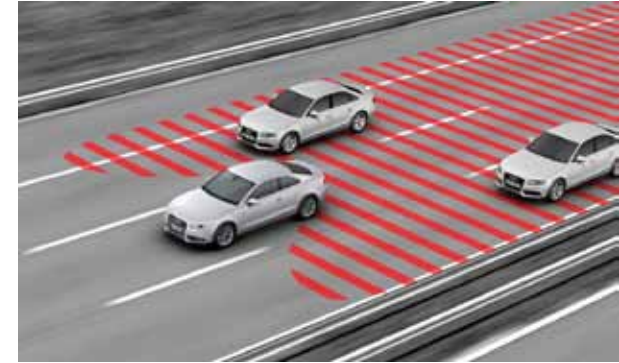

Audi side assist*

[Click target to find out more on Audi driver assistance systems](#)



LED Rear Lights



[Click target to find out more on Audi Lighting technology](#)

*Available as an optional extra

Technical Data

Model	2.0TDI 177	2.0TDI 177 Multitronic	2.0TDI 177 quattro	3.0TDI 204 Multitronic	3.0TDI 245 quattro S Tronic
Displacement in cc (valves per cylinder)	1968 (4)	1968 (4)	1968 (4)	2967 (6)	2967 (6)
Max. output ¹ in BHP at rpm	177/4200	177/4200	177/4200	204/4200	245/4000-6200
Max. torque in Nm at rpm	380/1750-2500	380/1750-2500	380/1750-2500	400/1250-3500	500/1400-3250

Power transmission/wheels

Transmission	6 Speed Manual	Multitronic	6 Speed Manual	Multitronic	S-Tronic
Type of drive	Front-wheel drive	Front-wheel drive	quattro permanent four wheel drive	Front-wheel drive	quattro permanent four wheel drive
Wheels	7.5J x 17 Alloys	7.5J x 17 Alloys	7.5J x 17 Alloys	8.5J x 18 Alloys	8.5J x 18 Alloys
Tyres	225 / 50 R17	225 / 50 R17	225 / 50 R17	245 / 40 R18	245 / 40 R18

Weights/capacities

Unladen weight in kg	1470 (1655)*	1495 (1680)*	1535	1565 (1760)*	1590 (1845)*
Gross vehicle weight in kg	1970 (2155)*	1995 (2180)*	2035	2065 (2260)*	2140 (2345)*
Roof load/trailer nose weight in kg	75/80 (80)*	75/80 (80)*	75/80 (80)*	75/80 (80)*	75/80 (80)*
Trailer load limit in kg	unbraked 750	750	750	750	750
	12% gradient 1600	1700	1600	1700	1900
	8% gradient 1800	1900	1800	1900	2100
Tank capacity, approx. in litres	63	63	61	63	61

Performance/consumption

Top speed in km/h	228 (213)*	221 (210)*	227	234 (229)*	248 (229)*
Acceleration 0–100 km/h in s	8.2 (8.8)*	7.8 (8.3)*	7.8	7.1 (7.6)*	5.8 (6.3)*
Fuel grade	Diesel - Sulphur Free	Diesel - Sulphur Free	Diesel - Sulphur Free	Diesel - Sulphur Free	Diesel - Sulphur Free
Fuel consumption in l/100 km					
	urban 5.5 (5.7)*	5.5 (5.6)*	6.1	5.5 (5.9)*	6.8 (7.0)*
	extra-urban 4.1 (4.3)*	4.3 (4.8)*	4.5	4.6 (4.9)*	5.0 (5.2)*
	combined 4.6 (4.8)*	4.6 (5.0)*	5.1	4.9 (5.2)*	5.7 (5.9)*
CO ₂ emissions in g/km	120 (127)*	123 (132)*	134	129 (138)*	149 (154)*
Emissions standard EU5	EU5	EU5	EU5	EU5	EU5

*Differing Cabriolet figures are shown in brackets beside Coupé figures

Technical Data

Model	1.8TFSI 170	1.8TFSI 170 Multitronic	2.0TFSI 221 quattro S Tronic	S5 3.0 TFSI 333 quattro S Tronic	RS5 4.2 FSI 430 quattro S Tronic
Displacement in cc (valves per cylinder)	1798 (4)	1798 (4)	1984 (4)	2993(6)	4163(6)
Max. output ¹ in BHP at rpm	170/3800-6200	170/3800-6200	211/4500-6250	333/ 4300-6000	450/ 8250
Max. torque in Nm at rpm	230/1500-3650	320/1400-3700	350/1500-4500	440/2900-5300	430/4000-6000
Power transmission/wheels					
Transmission	6 Speed Manual	Multitronic	7 Speed S-Tronic	S-Tronic	S-Tronic
Type of drive	Front-wheel drive	Front-wheel drive	quattro permanent four wheel drive	quattro permanent four wheel drive	quattro permanent four wheel drive
Wheels	7.5J x 17 Alloys	7.5J x 17 Alloys	8.5J x 18 Alloys	8.5J x 18 Alloys	9J x 19 Alloys
Tyres	225 / 50 R17	225 / 50 R17	245 / 40 R18	245 / 40 R18	265 / 35 R19
Weights/capacities					
Unladen weight in kg	1425 (1620)*	1455 (1655)*	1540 (1810)*	1675 (1880)*	1715
Gross vehicle weight in kg	1925 (2120)*	1955 (2155)*	2040 (2235)*	2175 (2380)*	2215
Roof load/trailer nose weight in kg	75/80 (80)*	75/80 (80)*	75/80 (80)*	75/80 (80)*	75/80
Trailer load limit in kg	unbraked 750 12% gradient 1500 8% gradient 1700	750 1300 1500	750 1700 1900	750 1900 2100	n/a n/a n/a
Tank capacity, approx. in litres	63	63	61	61	61
Performance/consumption					
Top speed in km/h	220 (210)*	224 (211)*	250 (240)*	250 (250) - Limited	250 (Limited)
Acceleration 0–100 km/h in s	8.3 (8.7)*	8.3 (8.9)*	6.4 (7.2)*	5.1 (5.4)*	4.5
Fuel grade	Unleaded 95 RON	Unleaded 95 RON	Unleaded 95 RON	Unleaded 95 RON	Unleaded 98 ROZ
Fuel consumption in l/100 km					
urban	7.4 (7.9)*	6.9 (7.2)*	8.5 (8.5)*	10.7 (11.2)*	14.4
extra-urban	4.8 (5.1)*	5.1 (5.6)*	5.6 (5.9)*	6.6 (6.9)*	8.3
combined	5.7 (6.2)*	5.8 (6.2)*	6.7 (6.9)*	8.1 (8.5)*	10.5
CO ₂ emissions in g/km	134 (143)*	134 (143)*	155 (159)*	190 (199)*	246
Emissions standard	EU5	EU5	EU6	EU5	EU5

*Differing Cabriolet figures are shown in brackets beside Coupé figures

