



# STS-2 Stroller 3210 Series Instruction Manual

Read all instructions BEFORE assembly and USE of product. **KEEP INSTRUCTIONS FOR FUTURE USE.** Record the following information for quick reference. Note: Illustrations are only representative and not actual. Attach copy of sales receipt.

Date Purchased: \_\_\_\_\_ Model Number: 3210 - \_\_\_\_\_ Color \_\_\_\_\_  
Attach copy of sales receipt. Located on the rear right leg.

## Parts List

Fabric Pattern \_\_\_\_\_

Make sure you have all the parts listed below before using your stroller. If any parts are missing, call Consumer Affairs at 1-800-992-6624.

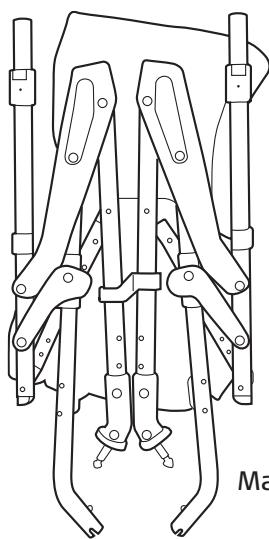

Main Body

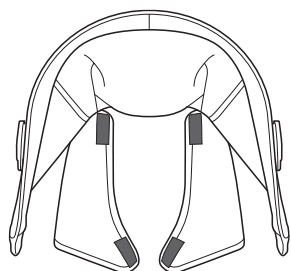

Canopy

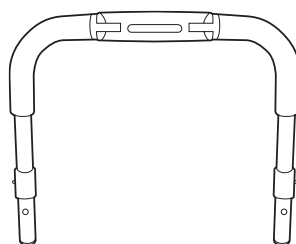

Handle

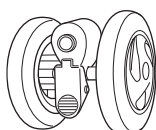

Front Wheels  
(x2)

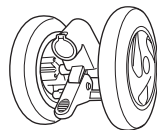

Rear Wheels  
(x2)

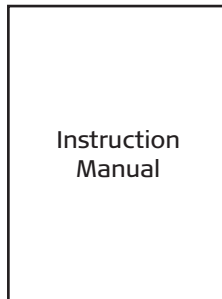

## Name of Parts



- 1 Handle Grip
- 2 Carry Strap
- 3 Folding Levers
- 4 Canopy With Mesh Window
- 5 Seat Cushion
- 6 Canopy Lever
- 7 Canopy Holder
- 8 Waist Belt
- 9 Armrest
- 10 Guardrail
- 11 Basket
- 12 Folding Latch
- 13 Foot Rest
- 14 Swivel Lock Lever

# ⚠️ WARNINGS For your child's safety:

If your stroller is not used in compliance with these instructions, serious injury may result.



**⚠️ WARNING**  
AVOID SERIOUS INJURY FROM FALLING OR SLIDING OUT. ALWAYS USE WAIST BELT.



**⚠️ WARNING**  
NEVER LEAVE CHILD UNATTENDED.

In the event of damage or problems, discontinue use and contact Consumer Affairs for instructions: 1-800-992-6624.



**⚠️ WARNING**  
Do not lift or carry the stroller while occupied. The stroller may fold.



**⚠️ WARNING**  
Do not use the stroller on steep slopes, stairs, escalators, beaches, rough roads, mud, etc.

**⚠️ WARNING**  
DO NOT ALLOW CHILD TO LEAN OVER SIDES OF STROLLER. IT MAY BECOME UNBALANCED AND TIP OVER.

**⚠️ WARNING**  
Excessive weight in basket (or items placed in basket which overflow the top or side of basket) may cause a hazardous condition to exist.



**⚠️ WARNING**  
Do not allow your child to stand in or on the stroller.



**⚠️ WARNING**  
Do not hang items on the handle or place items on canopy. This could cause the stroller to become unbalanced or tip over.

**⚠️ WARNING**  
Do not load more than 10 lbs. (4.5kg) in the basket.

**⚠️ WARNING**  
TO AVOID BURNS, do not place bottles/cups with hot liquids in the Stroller Pack. Do not place more than 2 lbs. in the Stroller Pack.



**⚠️ WARNING**  
Never carry more than one child in the stroller. Do not allow a child to ride or sit on areas of stroller other than the seat.  
**Maximum weight of child: 45 lbs. (20 kg)**



**⚠️ WARNING**  
Always engage both brakes when parking the stroller.

## CAUTIONS:

1. Improper usage or lack of knowledge regarding the instructions can result in dangerous situations, personal injury or damage to the stroller.
2. Completely remove all plastic bags and packing materials before using this product to prevent a possible choking hazard.
3. Push the stroller at a normal walking speed only.

All products specifications are subject to change without notice. Sizes and weights are intended as guides and are approximations. Combi® reserves the right to modify the products in its line during the course of the year. Non contractual media. Colors are as accurate as the media in which they appear allows.  
©Combi USA, Inc. 2004

## Assembling the Stroller

1. Remove stroller and rear wheel assemblies from the plastic bag
2. Remove canopy by detaching rubber bands.
3. Remove front wheel assemblies, guardrail and stroller handle from inside the stroller.
4. Lift locking lever from stroller frame and open stroller.
5. Grasp right and left steel tubes and snap the stroller away from you to open.

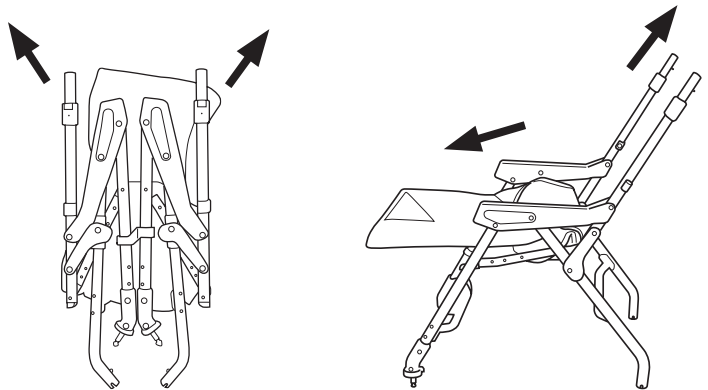

6. Insert stroller handle into frame by pressing chrome buttons into the back of the stroller frame.

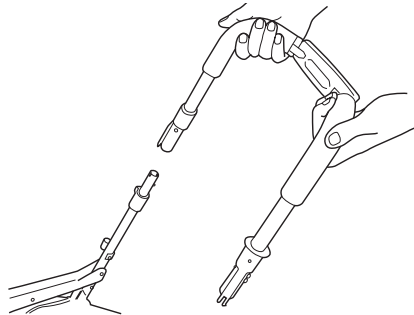

7. Insert long grey tabs into grey plastic slots on the stroller frame. Grey tabs must be fully inserted into the slots in order to fold the stroller.

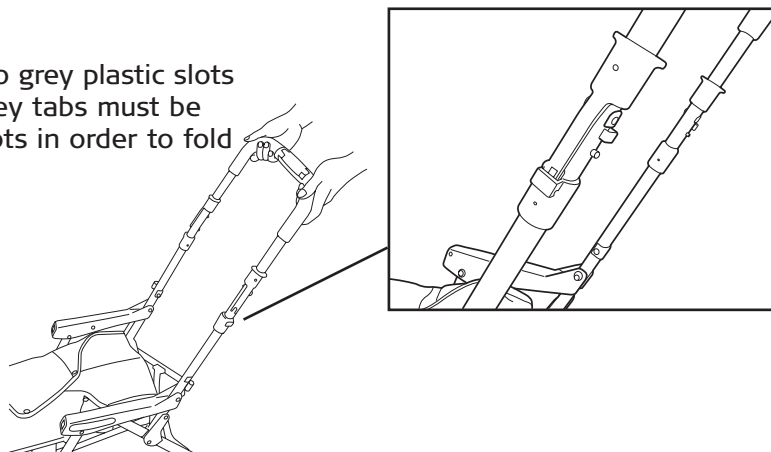

## Attaching & Removing the Front Swivel Wheels

1. Turn stroller over and remove packaging material from stroller frame.
2. Insert the front wheels onto the stroller leg. Make sure the swivel wheel lever is behind the stroller leg and released. You will hear a click when the wheel is properly attached.

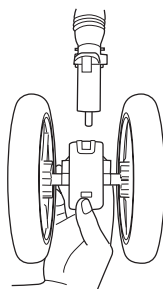

### Removing the Swivel Wheels

Press in the square button located at the bottom of the wheel holder while pulling the assembly off of the swivel shaft.

Release Button

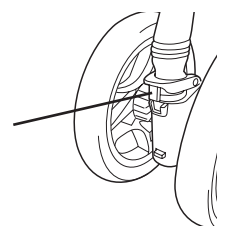

## Attaching the Rear Wheels

1. Stand behind the stroller.
2. Locate the small opening on each rear wheel assembly.

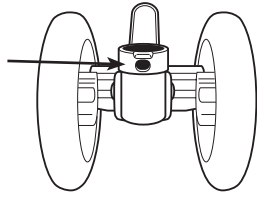

3. Locate the small chrome pin on each rear stroller leg.

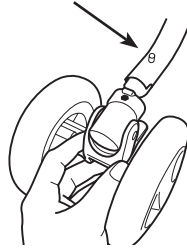

4. Insert the leg into the wheel assembly until the small chrome pin locks into the opening.

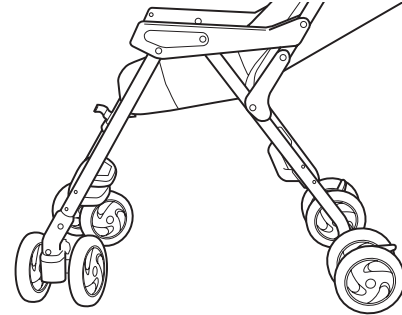

## Attaching the Seat Cushion

1. Stand behind the stroller and wrap the top of the seat cushion around the stroller frame.
2. Attach top right and left seat cushion clips to the tabs on the stroller frame.
3. Attach bottom right and left seat cushion snaps to the hooks on the stroller frame.

### CAUTION

If seat cushion is ripped or torn, do not use.  
Do not use the stroller without the seat cushion.

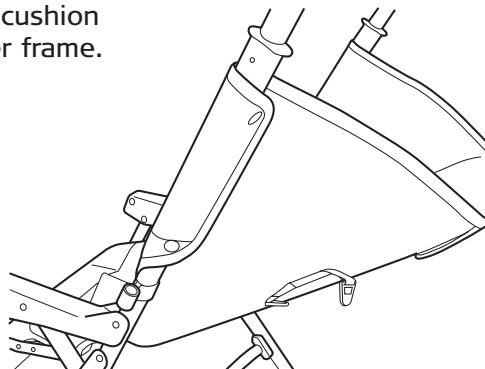

## Attaching the Canopy

### CAUTION

Failure to fully secure the canopy holders can cause the holders to bend. When storing the stroller by laying it down, be sure the canopy is off the ground to prevent it from bending.

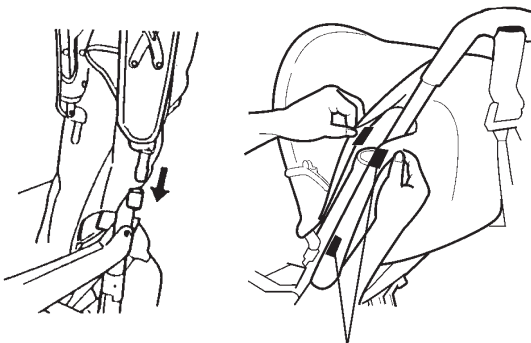

### Attaching the Canopy

1. Confirm the canopy is facing in the proper direction.
2. Fully insert the canopy holder (male) to the canopy holder (female) until a click is heard.
3. Fasten the canopy velcro together around the handle (2 places).

### Removing the Canopy

Pull the velcro apart, squeeze the bottom of the canopy holders (male) and pull the canopy up from above the canopy holder (female). This must be done on both sides of the canopy to completely remove it.

## Using the Swivel Wheels

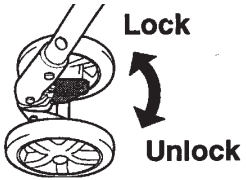

To lock swivels, lift both swivel lock levers up.

To unlock swivels, push both swivel lock levers down.

## Using the Brakes

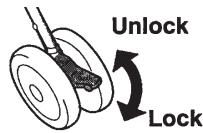

To lock brakes, push both brake levers down.

To unlock brakes, lift both brake levers up.

**CAUTION**  
Push the stroller forward to ensure that the brakes are properly engaged.

## Using the Reclining Backrest

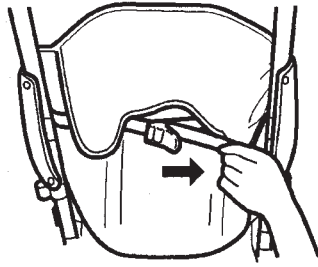
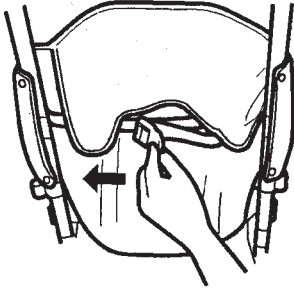

### CAUTION

Strollers which offer a partial recline are suitable for children that have fully developed neck muscles (typically 5-6 months of age) or when the baby can fully support his/her head. We do not recommend placing a newborn in a partially reclining stroller.

Be careful when reclining the backrest while baby is in the stroller to prevent abrupt changes in seating position.

1. Lift the end of the reclining buckle and move it to the left to recline the seat.

2. Pull the reclining strap toward the right to bring the seat upright.

3. Do not attempt to pass the double stitching on the end of the belt.

## Using the Guardrail

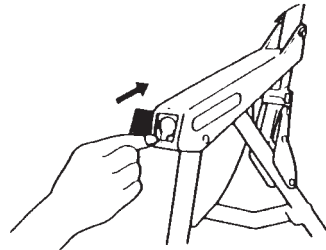
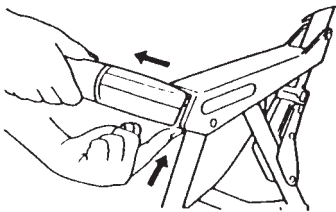

### CAUTION

Pull on each side of the guardrail to make sure it is completely attached.

When not using the guardrail, always use the guardrail hole caps.

When using the guardrail, remove the guardrail hole caps by inserting a thin coin to pop the cap out.

**Install the Guardrail** Push the guardrail into the opening in the armrest. make sure that the projections are facing down as you lock the guardrail into place.

**Remove the Guardrail** Remove the guardrail one side at a time while pressing the guardrail release button under each armrest.

## Using the Waist Belt



### WARNING

Avoid serious injury from falling or sliding out. Always use the waist belt.

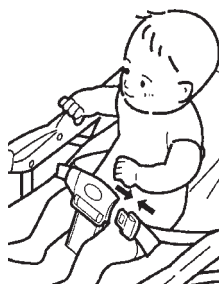

1. Place the crotch belt between baby's legs and fasten the waist belt buckles together.

2. To adjust waist belt, pull up the slack on each side of buckle.

3. After adjusting the waist belt, make sure it is fastened securely.

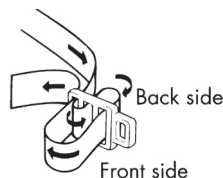

## Folding the Stroller

1. Lock both front swivel wheels.
2. Empty the basket.
3. Fold the canopy by lifting the canopy levers.
4. Lift the folding levers on both sides of the handle.
5. Tilt handle back and fold.
6. Fold handle inward and lock with the folding latch.

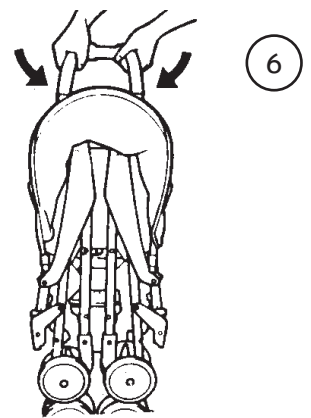
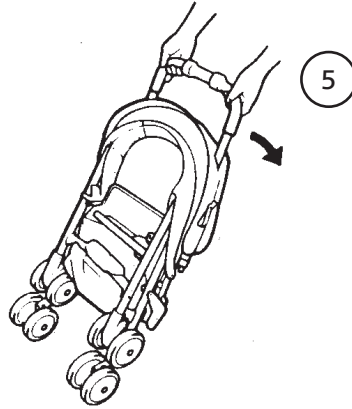
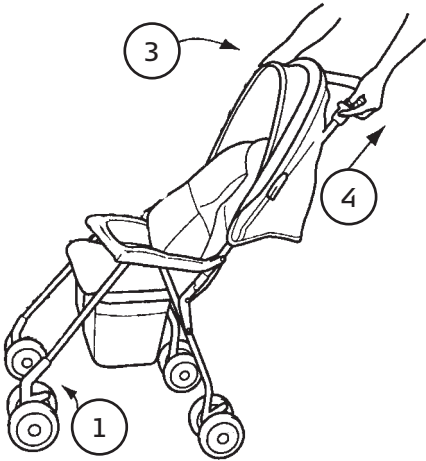

## Removing the Basket

### CAUTION

Do not place more than 10 lbs. in the basket.  
Remove all items from the basket before folding the stroller.

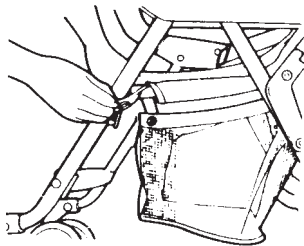

1. Loop the front strap of the basket over the seat frame and snap together.

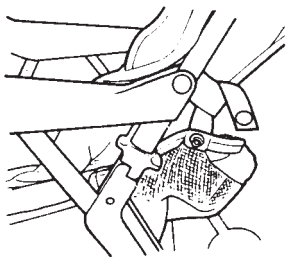

2. Loop the rear straps of the basket through the waist belt and snap together.

## Routine Maintenance

**STORE IN A COOL AND DRY AREA**, especially in the summer. Do not store the stroller in the trunk of a vehicle.

### **CANOPY, WAIST BELT, FIXED SEAT BASE, TRAVEL BAG AND BASKET**

Hand wash with brush. Wipe out excess water with a dry cloth and dry in a shaded area. For stubborn dirt, dilute a mild detergent and apply directly to the dirty area. Wipe out the detergent.

### **MAIN BODY**

Briskly wipe off any mud and dirt. To clean the body, wipe with a damp cloth then wipe out any traces of moisture on the body with a dry cloth. The main body might become moldy and musty if not wiped dry.

**Excessive exposure to the sun could cause premature color fading of stroller plastic and fabric.**

### **WHEEL ASSEMBLIES**

After prolonged normal use, the wheels of your stroller may not swivel or turn as easily as when the stroller was new. This is usually due to a buildup of dirt in the swivel mechanism. Before adding lubrication, remove the swivel wheels by pressing in the release button and wiping off mud and dirt. **Do not use soap and water to wash wheels.** Periodically check that all screws, bolts and nuts are tight.

Avoid lubricating the swivel wheels whenever possible. Excessive lubrication or adding lubricant to swivel wheels when new may cause them to develop a shimmy or wobble that may quicken their deterioration. Add silicone\* to the **wheel assemblies** in small amounts.

**Do not use lubricants because oil attracts dust and would hinder the movement rather than improve it.**

\*Silicone spray is available in varying size cans at most hardware stores.

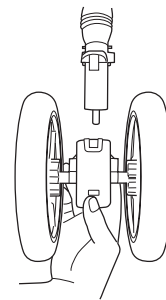

Front Swivel Wheel

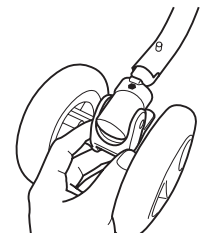

Rear Wheel

## Trouble Shooting

### **STROLLER WILL NOT FOLD**

- Check to see that the waist belt is not caught in the side.
- Make sure front swivels are locked.
- Remove all items from the basket.

### **DIFFICULT TO STEER/STROLLER PULLS TO ONE SIDE**

- Remove any items hanging from the handle.
- Make sure weight in basket is distributed evenly.
- Check that the brakes are not in the locked position.
- Clean and add silicone to wheels, if necessary.

### **DIFFICULT TO GET UP CURBS**

- Pulling stroller backward makes going up a curb difficult, and could pose a safety hazard. Pull the handle up to lift the rear wheels onto the curb, then pull the stroller backward until the front wheels clear.

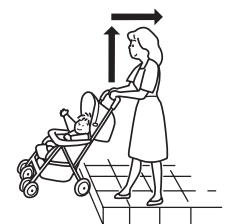
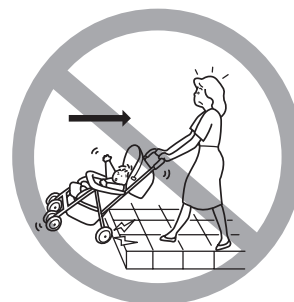

## LIMITED WARRANTY

1. Combi Juvenile Products, when purchased from an authorized retailer; are warranted to the original purchaser to be free of defect in materials and workmanship for a period of one (1) year from date of purchase. Warranty is valid for products purchased and used in the U.S. only, and used in compliance with the warrantor's use and maintenance instructions. Save your carton and receipt in case of return for warranty service is necessary.
2. During the warranty period your Combi product will either be repaired or replaced, at the warrantor's discretion, without charge if it is purchased from an authorized Combi dealer and is found to be defective in workmanship or materials. For service call 1-803-548-6633. The warrantor shall not be responsible for any costs incurred by the consumer in returning a defective product for repair.

This limited warranty shall not apply to normal wear to the product, or if the product has been:

- a. Damaged due to accidents, misuse, abuse or neglect as determined by Combi.
- b. Tampered with or repaired by other than an authorized Combi repair center or with parts other than Combi approved parts.
- c. Leased or rented for commercial use.

THE WARRANTY PROVIDED HEREIN IS EXCLUSIVE AND IS IN LIEU OF ALL OTHER EXPRESS WARRANTIES. ANY IMPLIED WARRANTIES, INCLUDING ANY IMPLIED WARRANTY OF MERCHANTABILITY OR FITNESS FOR A PARTICULAR PURPOSE ARE EXPRESSLY EXCLUDED. WARRANTOR'S OBLIGATIONS AND THE CONSUMER'S OR OTHER BUYER'S REMEDIES UNDER THE LIMITED WARRANTY ABOVE ARE EXCLUSIVE AND ARE STRICTLY LIMITED TO REPAIR OR REPLACEMENT AS STATED. ANY INCIDENTAL OR CONSEQUENTIAL DAMAGES ON THE PART OF THE WARRANTOR AND ANY SUPPLIER OR DEALER ARE HEREBY ALSO EXPRESSLY EXCLUDED.

Some states limit or do not allow exclusions or limitations on how long an implied warranty lasts so the above limitation may not apply to you. Some states do not allow the exclusion or limitation of incidental or consequential damages, so the above limitation or exclusion may not apply to you. This warranty gives you specific legal rights, and you may also have other rights which vary from state to state.





STS-2 Stroller 3210 Series

Instruction Manual

If you would like to place an order for the replacement parts, please fill out the form below and return to the following address:

Strolee
Attn: Consumer Affairs Department
1962 Highway 160 W, Suite 100
Fort Mill, SC 29708-8027

or Fax this completed form to
803-548-3663

IMPORTANT: We must have this information to process your order:

Model Number: 3210 - \_\_\_\_\_ Color & Pattern of Fabric: \_\_\_\_\_
Located on the rear right leg.

Parts List for the STS-2 (3210 Series) only.

Table with 4 columns: Item, Price, Quantity, Total. Rows include Canopy, Basket, Standard Guardrail, Guardrail Cover, Rear Wheel Assemblies, Front Wheel Assemblies, Handle, and empty rows 8-11.

If you need to order other parts for your stroller, please call us toll-free at 1-800-992-6624.

Shipping and Handling Fees: Add \$8.00 for orders \$34.99 and under. Add \$13.00 for orders \$35.00 and over. Note: Additional shipping charges will apply outside of the Continental U.S. Combi USA reserves the right to change pricing at any time.

Summary table with 4 columns: Description, Amount of Order, Shipping & Handling, Sales Tax (6%), Total.

Ship To:

Customer Name
Street Address
Street Address
City, State, Zip
Telephone Number

Charge to my credit card:
[ ] VISA [ ] MASTERCARD
[ ] AMERICAN EXPRESS [ ] DISCOVER

Card Number
Expiration Date \_\_\_\_\_ - \_\_\_\_\_ - \_\_\_\_\_

Cardholder's Signature 011505