

Portable Braking System

Model No. 9300

Towed Car Proportional Braking System

Owner must read all cautions, warnings and instructions prior to installation or operation of the braking system.



ATTENTION!
This unit
requires 15 amp
outlet
Refer to page 16
for further explanation

Part number
9300

*Thank you for
purchasing this great
ROADMASTER
product.*



The Finest Tow Bars and Braking Systems on the Planet

5602 NE Skyport Way Portland, Oregon 97218 1-800-669-9690 www.roadmasterinc.com



*Congratulations on your new braking system...and **THANK YOU.** Quality materials, computer technology and our reputation for craftsmanship have gone into each system. Each of our products is designed for safe, trouble-free towing. Your safety is important to us.*

*Before using your portable braking system, Model No. 9300, read this booklet. Enclosed you will find operating instructions and safety precautions. Read and carefully follow these instructions. **Remember, proper installation & use of this product is the sole responsibility of the purchaser. Improper installation, use or maintenance may result in malfunction or property damage.***

Finally, don't forget to fill-out and mail back your warranty card. You must register your braking system within 30 days of your purchase to qualify for your Warranty. For future reference please write down your serial number in the space provided. The serial number is located on the underside of the unit.

Once again, thank you!

Serial number

! WARNING
 FAILURE TO INSTALL AND OPERATE THE BRAKING SYSTEM AS INSTRUCTED MAY RESULT IN UNIT MALFUNCTION, PROPERTY DAMAGE, PERSONAL INJURY OR DEATH.

! WARNING

If you see a **WARNING**, this indicates a potentially hazardous situation which, if not avoided, could result in serious injury or death.

! CAUTION

If you see a **CAUTION**, this indicates a potentially hazardous situation which, if not avoided, may result in property damage or personal injury.

WARRANTY PROCEDURES
 If you have any problems with this product, immediately contact ROADMASTER at 1-800-669-9690. If necessary, we can direct you to your nearest warranty service center and make arrangements for any warranty repairs or replacements. While under warranty, ROADMASTER will make arrangements for your product to be repaired or replaced. **Do not purchase replacement parts or pay for labor - you will not be reimbursed.** See section titled "ROADMASTER Limited Warranty" for specific details.

Specifications

Height	12 1/4 inches	Length of standard power cord	42 inches
Width	13 1/2 inches	Max amperage draw	10.8 amps
Length	16 inches	Idle amperage draw	64 milliamps
Weight	20 lbs	Approximate max air pressure	60 psi
Voltage	12 volts DC	Maximum force exerted on brake pedal	106 lbs of force
		Minimum space unit can fit	16 inches

Portable Braking System

PART #9300

<i>Part Number</i>	<i>Description</i>
1 #650997	Brake pedal clamp assembly
2 } Assembly	Test button
3 } #650999	Max Brake Pressure button
4 } #650999	Brake Sensitivity button
5 #650996	Adjustable seat pad
6 #450952	Adjustment knob
7 #300075-03	Red RCA socket
8 #300075-10	White RCA socket
9 #300075-07	Blue BrakeAway jack
10 #450098	Air relief

<i>Part Number</i>	<i>Description</i>
11 #450105	Adjustable feet & lock nut
12 #300104-00	20 amp fuse (unthread end)
13 #650990	BrakeAlert Receiver
14 #300104-03	10 amp fuse (unthread end)
15 #650995	BrakeAlert Transmitter
16 #650898	Breakaway switch
17 #650899	Brakeaway wiring harness
18 #8602	Brakeaway cable
19 #9333	Brake Pedal Monitor Kit

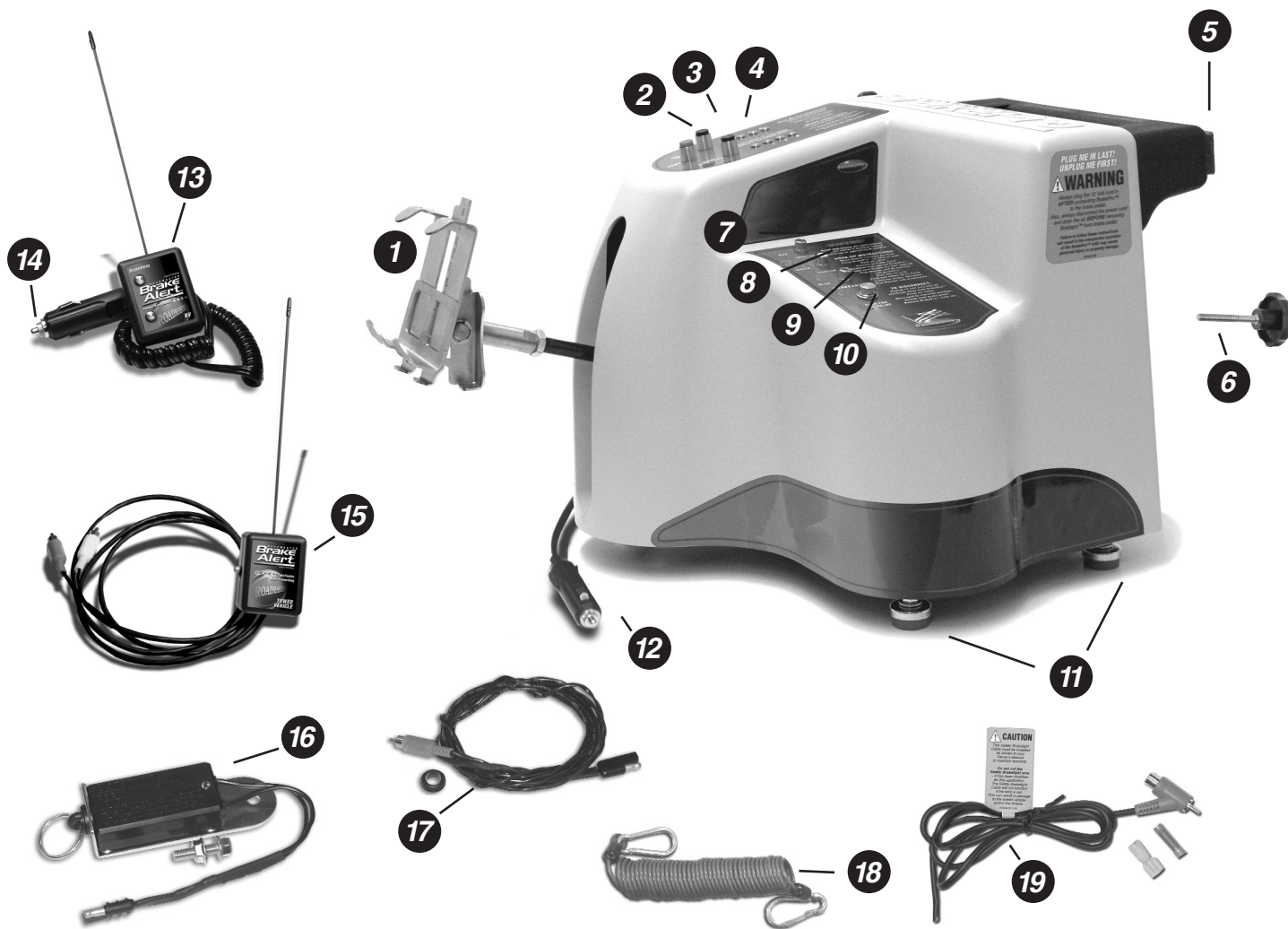

Optional accessories on page 15
Items not shown to scale

Installation**READ ALL INSTRUCTIONS FIRST BEFORE
INSTALLATION OR OPERATING.****WARNING:**

Not for use on older vehicles without power brakes. This system is designed to work with vehicles that have a power brake system (even though the power brakes are not activated while towing). Using this unit on vehicles that do not have power brakes will result in over-braking and severe non-warranty brake damage.

**WARNING:**

Never plug this unit into 12 volt outlet until braking system is completely connected to brake pedal and installed according to installation instructions. Once it receives power, any movement of the box could cause the unit to activate unexpectedly. Similarly, never try to un-install the unit without first unplugging the 12 volt cord. Failure to install and operate the braking system as instructed may result in property damage, personal injury or death.

Important! Although this system fits most vehicles as is, with no modifications needed, it may be necessary in some cases to gain additional clearance over obstructions on the floor. In other cases, it may be necessary to extend the reach of the unit to ensure a secure and stable fit. To accommodate every possible floor configuration and contour, Roadmaster has developed cylinder arm extensions in two sizes (#9336 and #9336-3), as well as feet extensions (#9337 and #9337-4). These extensions allow you to install in virtually any vehicle. The cylinder arm extensions increase the reach of the unit. Use a cylinder arm extension if the distance between the driver's seat and the brake pedal is too far to maintain a secure anchor point between the driver's seat and the braking system's seat pad - If the unit is properly installed to the brake pedal and there is a gap between the seat and the seat adjustment pad, use a cylinder extension of the appropriate length. Use one or more foot extensions to elevate over obstructions such as duct work, a door jam or a center console that juts into the available space, or if the floor is significantly out of level.

For further information, refer to "Optional Equipment" on page 15.

Helpful Hint! Before you begin the initial installation, verify that you have power in the towed vehicle's 12 volt outlet (with the key in the "tow" position). Some new vehicles only have power at the outlet when the vehicle is running. If you do not have power, you can install Roadmaster's optional 12 volt outlet kit number 9332. When installed, this outlet will provide power even when the engine is off.

Important! Some vehicles do not have 15 amps of power going to the cigarette outlet. This system requires 15 amps of power. It will not function properly with less than 15 amps. To remedy this situation, refer to the "install optional 12 volt 20 amp power" section in this manual.

1. Remove the braking system components from box and attach adjustable seat pad to the unit using the adjustment knob. The adjustable seat pad also functions as a carrying handle.
2. Adjust driver's seat to rearmost position.
3. Place the unit between driver's seat & brake pedal in the approximate position it will sit in when connected to the brake pedal.

Helpful Hint! The braking system may be placed in the vehicle without the handle attached if that provides the best fit.

**CAUTION**

DO NOT PLUG INTO CIGARETTE LIGHTER AT THIS TIME.

Doing so may cause unexpected operation the braking system resulting in personal injury or property damage.

4. Make sure that all of the air in the system has been released by depressing the air relief button. Any remaining air in the system will prevent the cylinder from extending when trying to connect to the car's brake pedal.
5. Disengage catch on pedal clamp as shown in Figure 1 and fully open pedal clamp.

Figure 1

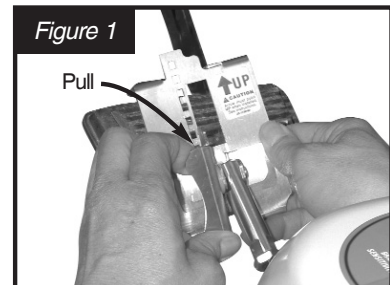

Figure 1a

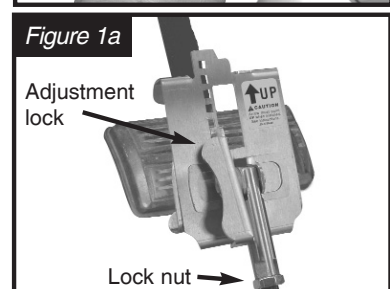
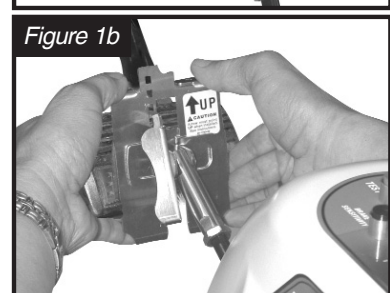

Figure 1b



Installation continued

- Place pedal clamp so that the bottom tabs are hooked on brake pedal as shown in Figure 1a. Now compress pedal clamp at top and bottom and ratchet it down until fully secure on brake pedal as shown in Figure 1b. Use pliers to bend the five tabs in Figure 2, to properly fit your car's brake pedal.

IMPORTANT! Verify that the clamp is right side up as shown in figure 1a. The sticker will point up when properly positioned.

CAUTION: Make sure you bend the five tabs on the pedal clamp to tighten around your brake pedal securely. If loose the pedal clamp can get out of position and hold the brakes in the on position even when not braking. This would result in non-warranty brake damage.

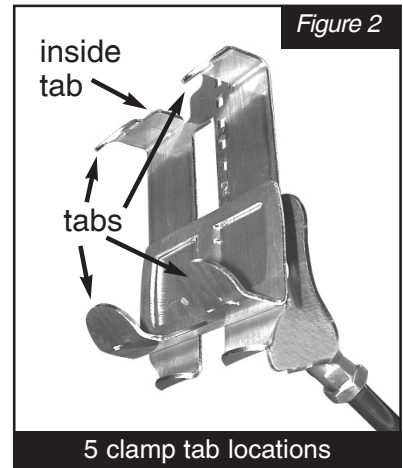

- Now move the braking system forward until cylinder is fully collapsed.
- Make sure the unit is approximately level. Adjust the feet on the bottom of the braking system making sure that all four feet are making contact with the floor of your vehicle. **IMPORTANT!** Once level, make sure lock nuts are tightened to secure feet. Feet may be removed if necessary or for fit options use feet extender parts #9337 & 9337-4 found in the optional equipment section featured later in this manual. **IMPORTANT!** The braking system must be close to level to operate properly.
- Loosen knob on back of the unit to adjust seat pad up or down as necessary to match seat height. **Note:** Adjustable seat pad may be rotated 180 degrees or removed for better fit. There are also two anchor holes that the adjustment knob may be threaded into for additional fit adjustment
- Now slide seat forward against the braking system adjustable seat pad. Once again, be certain the unit is not depressing brake pedal.

CAUTION:

Make sure the brake pedal is not being depressed as this will apply the brakes causing severe brake damage or even a brake fire.

THIS WILL NOT BE COVERED UNDER WARRANTY

CAUTION:

CHECK 12 VOLT OUTLET BEFORE PLUGGING IN THE UNIT. If you use any 12 volt socket other than your car's factory wired outlet, make certain that the socket has been wired correctly. The bottom center of the 12 volt outlet is always positive while the round outer shell is always negative. **If the positive and negative wires are reversed, you will blow the 20 amp fuse in the end of the 12 volt power cord.**

- Plug the 12 volt cord into the power outlet. Secure cord using the cord lock as shown in figure 2a through 2c. **IMPORTANT!** You must push the cord lock forward into the cigarette lighter to properly secure the plug. Failure to use the cord lock may allow the plug to vibrate loose, causing intermittent power supply and the Receiver lights to flash. If your Receiver lights flash for no apparent reason, verify that the 12 volt plug is properly secured with the cord lock.

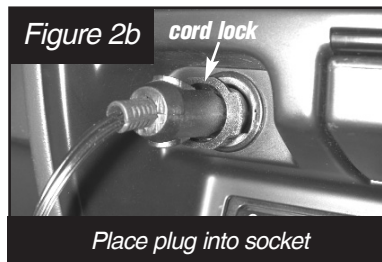

- At this time, the red light on the 12 volt plug should illuminate. If not, you have no power. Some cars have no power to the cigarette lighter connection unless the ignition is on. In that case, use part number 9332 (not included) to add a 12 volt outlet.
- Once you have power, the compressor should run briefly.

Installation continued**14. PROGRAMMING LEVEL**

Make sure the car is NOT running and it is on a LEVEL SURFACE. Also, verify that the unit is roughly level. Adjust feet as necessary to level. If the compressor is running, wait for compressor to stop.

Now press and hold the “Max Brake” and “Brake Sensitivity” buttons simultaneously to program level.

This calibrates level and gives the unit a starting point for sensing deceleration. Once you have pressed the “Max Brake” and “Brake Sensitivity” simultaneously, the row of lights for the “Brake Sensitivity” will flash two times to let you know that the unit’s level has been successfully programmed. **Do not proceed until the row of lights flashes or your braking system will NOT perform properly while towing.**

IMPORTANT! You only have to program level one time during the original installation. The next time you tow, you will not need to re-program level. The this unit remembers “level” even after being unplugged. The only time you need to re-program level is if you change towed cars. If the system is not performing properly, it is usually because “level” has not been programmed properly. In this case, re-program level as described above.

**IMPORTANT:**

Car must be roughly level. If the car is severely off level when you push the Max Brake and Brake Sensitivity buttons simultaneously, it will make the system too sensitive and cause it to brake at the slightest bump or rough spot in the road. Always be sure the car is on flat ground and not on ramps, hoists or a hill when setting level. This will help prevent unnecessary braking.

15. Set “Brake Sensitivity” to number 2.

16. Set “Max Brake” pressure to number 2.

HELPFUL HINT! Setting the **Brake Sensitivity** to a higher number means you will need more force on the RVs’ brake pedal to activate the braking system. Setting the **Max Brake Pressure** to a higher number means the braking unit is exerting more pressure on the towed cars brakes.

**CAUTION:**

This next step fully activates the unit.

17. Check for secure placement of the unit and seat. Do this by depressing the test button and holding it until the cylinder extends. If it moves excessively, or interferes with seat position controls, adjust positioning and retest. **Adjustable seat pad may need to be readjusted after pressing and holding the test button until the cylinder extends. Verify that it is not unlocking the seat, affecting seat position controls, or allowing the braking system to “climb”.**

HELPFUL HINT! Some rubberized floor mats will cause “climbing”. Remove the floor mat if this happens. If the unit is repositioned for any reason, be sure to reprogram level as described in step 14, before continuing.

**CAUTION:**

Don’t let the unit “climb”. If the braking system’s adjustable seat pad is not properly positioned on the front of the seat, the unit can “climb” up the seat with repeated braking. This will cause the rear of the box to raise up off the floor making the braking system more sensitive. If this occurs, you will experience excessive & unnecessary braking. Always push the test button and hold it until the cylinder extends after the installation to make sure the unit is secure and stable & will not “climb” up the seat. If it does, reposition the adjustable seat pad so that the unit cannot “climb”. Failure to follow these instructions will result in non-warranty brake damage.

Installation continued

! WARNING: *Make sure the system is not depressing the brake pedal.* If the unit is positioned improperly, or if the seat is too close, then the system will cause continual braking resulting in severe non-warranty brake damage. Once installed, follow the steps below to make certain that the unit is positioned correctly.

HELPFUL HINT! If you install the Brake-Lite Relay Kit number 88400, your brake lights will not come on unless the ignition switch is turned on. Therefore, always turn on the ignition switch when checking for brake lights. Manually depress the brakes to verify the brake lights are working.

- 18 a.) Turn ignition on. Do not start the vehicle, but make sure that the ignition is in the "ON" position, NOT the "ACCESSORY" position.
- b.) Go to the rear of the vehicle and see if brake lights are on. If so, DO NOT TOW. You must reposition the unit as its current position will cause the brakes to be on all the time. After repositioning, check the brake lights again. Now reprogram level (see step 14).
- c.) Now have someone push and hold the test button so that the Portable Braking System will activate. The brake lights should come on. This step is just to verify that your brake lights are functioning properly.

IMPORTANT! *The Brake Alert transmitter will alert you when the unit cylinder is extended, not necessarily when the brake pedal is being depressed. The system includes Brake Pedal Monitor Kit #9333 will illuminate the transmitter when the brake pedal is being depressed regardless of if the cylinder is extended such as when the seat is too far forward forcing the unit closer to the brake pedal. Refer to "Brake Pedal Monitor Wire Kit #9333 installation instructions later in this manual.*

Installation of BrakeAway System

Determine if you will be using the included BrakeAway System.

Visit www.roadmasterinc.com/laws.htm to see if a breakaway is required in your state. Roadmaster strongly recommends that you always use the BrakeAway System even if it is not required in your state or country.

The BrakeAway kit is an integral part of the braking system and should always be installed. Roadmaster strongly recommends that you install and use the BrakeAway. If you choose not to use the BrakeAway, Roadmaster will not be held responsible for any property damage, personal injury or liability that results.

Wiring harness with blue RCA connector
Part #650899

Cable
Part #8602

Breakaway pin

Breakaway switch
Part #650898

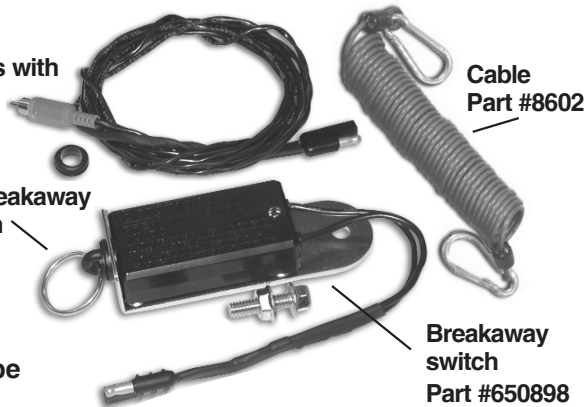

- a.) Mount the Breakaway switch to a metal surface (not plastic) on the car near the driver's side front of the vehicle. Make sure that the mounting location can be easily accessed. The Breakaway switch must be installed in a horizontal position that allows the Breakaway pin to point toward the motorhome. Be sure the install location allows the Breakaway pin to pull freely away from the car without any obstruction.

! WARNING: Do not attach the Breakaway switch to the brackets or the tow bar. If the tow bar or bracket fails, the BrakeAway will separate with the bar or bracket preventing the Breakaway switch from activating.

Installation continued

- b.) Start in front of the car on the driver's side. Carefully route the wire through the firewall using a pre-existing hole if possible. If not, drill a 1/2" size hole. Cut the included grommet on one side and place around the wire and then insert the included grommet in firewall. Feed the remaining wire through the grommet and carefully route the wire through the engine compartment to the inside of the car where the wire is within reach of the Breakaway switch. Avoid wire placement near moving parts or hot areas of the engine as this will cause non-warranty failure. Seal grommet with silicone sealer (not included).

Installation continued



CAUTION:

Make sure the cord to the BrakeAway system is routed so that it cannot get entangled with pedals or other moving parts. This may result in property damage or injury.

Plug BrakeAway wire into blue jack on the braking system after the unit has been properly installed in car. Upon completion of the installation, test system by pulling pin out of Breakaway switch. The unit should activate when pin is pulled.

Connecting Breakaway Cable

Clip the steel cable to the large ring on the Breakaway switch, then clip the other end of the steel cable to the center rear of the motorhome. Always check the following:

- Connect the cable close to the center of the rear of the motorhome. Connecting the cable towards the sides of the motorhome will cause the cable to activate the BrakeAway System when turning sharp corners.
- Be sure there are no obstructions that would prevent the cable from freely pulling away from the Breakaway switch. **DO NOT WRAP THE CABLE AROUND ANY COMPONENT. DOING SO COULD KEEP THE CABLE FROM PULLING THE PIN PREVENTING THE BRAKEAWAY SYSTEM FROM ACTIVATING.**
- Make sure the cable is long enough to prevent the Breakaway pin from being pulled out during normal towing.** Also, remember that if you have a telescoping tow bar, you must allow enough slack so that the tow bar can fully extend. If the cable is too short, the BrakeAway System will activate even though the car has not broken free.
- Be sure the cable is not too long. It should not hang way down or drag on the ground. This much slack could allow the cable to get caught going through dips or low spots causing the BrakeAway System to activate.
- Do not remove the Breakaway pin. This will activate the BrakeAway System and result in a dead battery. Only remove the pin to test for proper BrakeAway System operation.



CAUTION:

Do not forget to release your emergency brake before towing. Non-warranty brake damage or brake fire may occur

Brake Pedal Monitor Wire Kit #9333 installation instructions

Without Brake-Lite relay kit

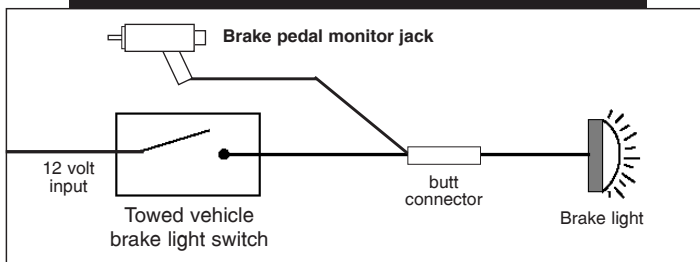

To install the Monitor Wire Kit use the included butt connector to join the monitor wire with the cold side of the towed car's brake light switch. For proper operation of the monitor kit, towed vehicle brake lights must be able to function with ignition key in towed position. Some vehicle's brake lights **ONLY** function with ignition system turned on. If this occurs, a separate 2 prong stop light switch and 10 amp fuse must be installed and custom fit to operate monitor kit. This stop light switch is not supplied and is available at local automotive parts stores.

With Brake-Lite relay kit

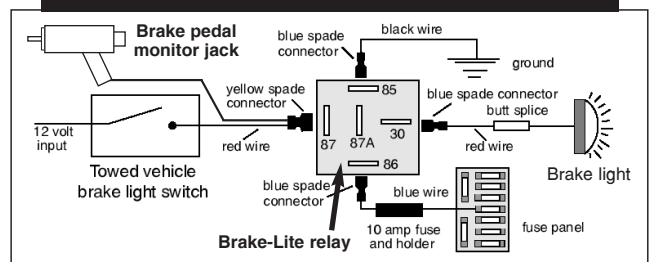

First install the Brake-Lite relay kit as described in the section titled "Optional Brake-Lite Relay Kit". To install the Monitor wire kit, connect the monitor wire using the included yellow spade connector to terminal 87 on the Brake-Lite relay.

Correct brake pedal monitor jack connection

The brake pedal monitor jack must be configured as shown in order for the unit to function properly.

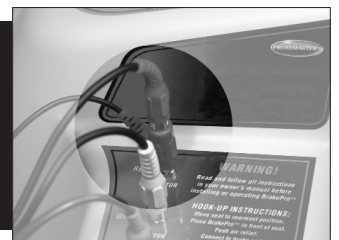

Installing BrakeAlert System

! WARNING: The BrakeAlert Monitor System is an integral part of the braking system. Roadmaster strongly recommends that you install and use it. If you do not use the BrakeAlert Monitor System, Roadmaster will not be held responsible for any property damage, personal injury or liability that results.

IMPORTANT! RECEIVER MUST BE LOCATED SUCH THAT THE DRIVER CAN EASILY VIEW THE LED INDICATORS ON THE RECEIVER IN THE MOTORHOME.

HELPFUL HINT! The Receiver will normally get a stronger signal closer to the driver's side window. It is not necessary to secure the Transmitter with the included Velcro; however, if you do, be sure to test the system for proper signal strength. Some mounting locations (for BOTH the Transmitter and Receiver) will afford a better signal than others. For testing purposes, be sure the car is connected to the motorhome with the RV's engine running while checking reception.

HELPFUL HINT! When choosing a mounting location for your antennas, never point them at each other as you will not get good reception. See figure 3.

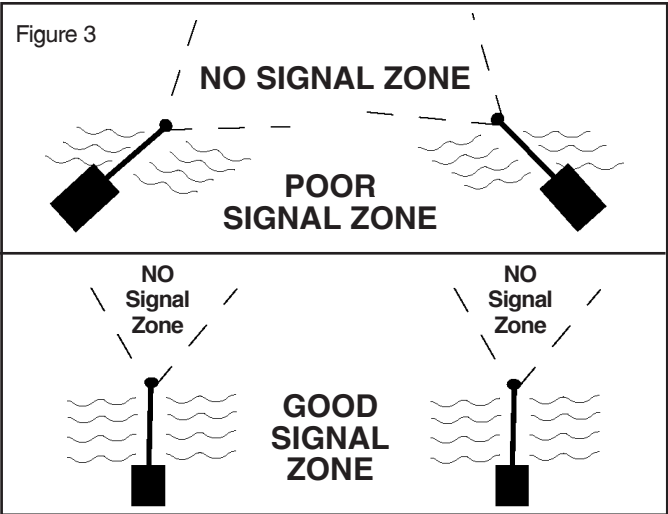

HELPFUL HINT! Many electrical components generate electrical interference. Before mounting your Transmitter and Receiver, turn on all large electrical components (such as generator, motorhome engine and roof air conditioner) to verify you are receiving a signal in the RV.

IMPORTANT! Do not route transmitter and/or receiver wires parallel to antenna as shown below or a false signal may result.

19. Install the Receiver in the motorhome and plug into 12 volt outlet. In order to ensure a secure power cord connection, use the included cord lock. Follow figure 2a through 2c shown earlier in the manual to properly use the cord lock. Now, install the Transmitter in the towed vehicle and plug into the Red and White RCA jacks on the braking system unit.

HELPFUL HINT! The Receiver's yellow light will illuminate briefly to verify the Receiver is getting 12 volts.

20. **INSTALLATION IS NOW COMPLETE.** As a safety precaution, drive RV and towed car and test system for proper operation. Check brake lights on towed vehicle to verify that your braking system is not depressing brake pedal except when braking.

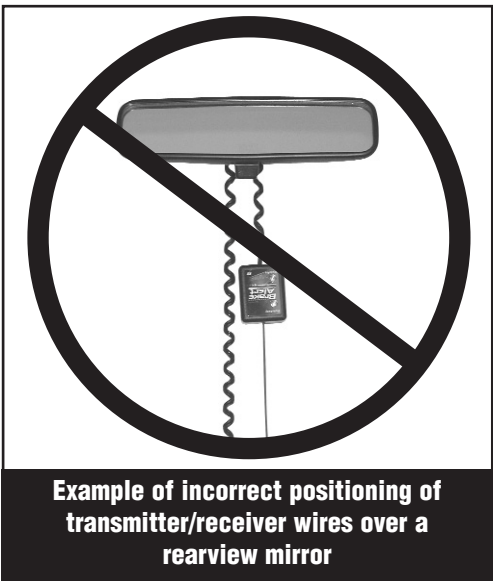

BrakeAlert operation



CAUTION:

Make sure the cord to the BrakeAlert system is routed so that it cannot get entangled with the steering wheel as it turns. This may result in property damage or injury.

The Receiver simply monitors for a transmission from the unit and communicates to you with its LED lights. During normal use, the red light on the Receiver will illuminate whenever the braking system activates. Following are the various light codes and what they mean:

1. *If red light is on -*
The brakes on your towed car are on.



WARNING:

The BrakeAlert monitor system is designed to communicate the braking status of the unit. **Red light staying on means the brakes on your towed vehicle are on.** If the red light stays on even when you are not braking and does not go off, immediately stop and investigate. **DO NOT** continue to tow until the problem has been corrected. Failure to do so will result in significant brake wear, damage or even a possible fire in your towed vehicle. Towing in this fashion voids warranty and will result in non-warranty property damage.

2. *If red light repeatedly flashes and does not stop -*

This is your low battery alarm. Your braking system has gone into sleep mode to prevent further depletion of your towed car's battery. Your battery needs to be charged.

The system monitors the battery voltage in your towed car. If the voltage starts to drop too low, this light will continually flash to let you know that your towed car's battery is going dead. This feature usually gives you the opportunity to start your car before it's too late. To turn off this alarm, simply charge the battery and re-plug in the unit.



WARNING:

Do not leave your car running while towing as this will allow your power brakes to function. This unit is designed to work with a dead pedal. The power brakes will cause excessive braking in the towed car resulting in significant brake and tire damage not covered by warranty. If for any reason you must have the towed vehicle running while being towed, it is imperative that you disconnect the System.



WARNING:

Your braking system will not function when in the sleep mode and you will not have the additional stopping power. You must take this into consideration if you choose to continue towing.

HELPFUL HINT! In addition to the red monitor light flashing, the red lights on the unit will also flash to remind you that it is in sleep mode and that the braking system is no longer functioning for normal braking. However, the system will still activate if a brakeaway should occur during the sleep mode.

HELPFUL HINT! Depending upon the condition and age of your battery, you will typically get 2 to 3 days of towing before your battery goes dead. We recommend recharging your towed cars battery each day after towing. Alternatively, you can route a charge line from the coach to the towed car that will continually charge your towed car's battery.

HELPFUL HINT! To wake your unit after recharging your battery plug the braking system back into a 12 volt outlet.

Receiver

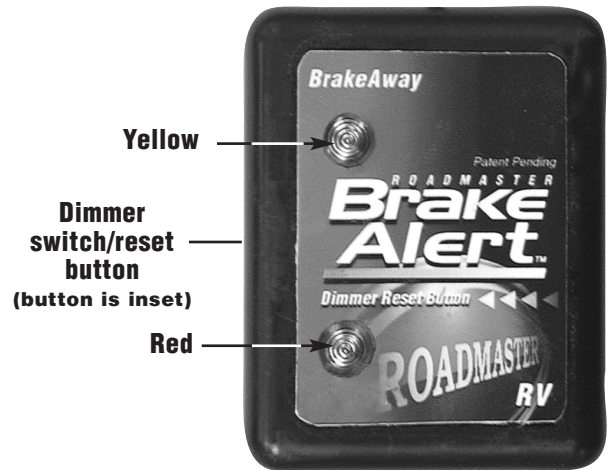

Part #650990

Dimmer Switch - Dims lights for night time driving. Press again to brighten.

Reset Button - The dimmer switch becomes the reset button when held down for 5 seconds. See section entitled "Recoding BrakeAlert" next.

Recoding BrakeAlert

The Receiver and Transmitter are coded alike at the factory for proper communication. Normally, you would never have to recode your Receiver. However, we have included the following instructions in case you ever lose your Receiver or Transmitter and have to replace it with a new one.

1. Push the reset button until the yellow light comes on (about 5 seconds). Be sure to release the button once the yellow light comes on. The red light will also flash every 5 seconds.
2. Have someone go to the towed car and activate the braking system by depressing the test button and holding it until the cylinder extends. This will cause the Transmitter to send the code to the Receiver. Keep the test button depressed. Hint: If you have an additional 12 volt outlet in the car, you can take the Receiver with you to the towed vehicle and perform the above instructions. If you do not have an additional 12 volt outlet you can purchase our optional 12 volt "Y" part number 9330.
3. While the test button is depressed on the unit, press and release the reset button on the Receiver several times until the red LED light illuminates. The Receiver is now programmed to match the Transmitter's code.

BrakeAlert Transmitter

The Transmitter simply relays braking information up to the Receiver in the motorhome. The red LED on the Transmitter will illuminate each time a signal is sent to the Receiver.



Part #650995

Check for proper operation of brake lights & turn signals

1. Connect car and motorhome as if you are towing.
2. Turn on the motorhome and activate your turn signal. The turn signal on the towed car should blink on and off. Leave turn signal flashing for now.
3. Go to the towed car and depress the brake pedal.
4. If depressing the brake pedal deactivates the turn signal on the towed car, you need to install the Brake-Lite Relay Kit number 88400. This kit will prevent the towed car's brake lights from overriding the turn signals. Refer to optional Brake-Lite Relay Kit instructions later in this manual.

Normal Operation

This braking system is designed to brake your towed car whenever it senses deceleration from your RV. Under normal circumstances, the unit will activate whenever your RV is decelerating faster than your towed car (that is, you are stopping your RV). If you are riding your foot on the brakes of the RV, then the braking system will not activate because the RV is not slowing more quickly than the car. Similarly, when you come to a full stop, the system will release since there is no longer any deceleration. The system will activate whenever it senses deceleration in the RV. The unit consumes battery power in your towed car as you drive. Roadmaster recommends that you start your towed vehicle after towing for more than 6 hours and let it idle 15 to 20 minutes to re-charge your battery. To make sure your battery is re-charged, make sure your low battery light on the towed vehicle is not lit.

IMPORTANT! Battery conditions such as age or capacity will affect usage, time, and time to recharge.



CAUTION:

Do not tow with your towed vehicle's engine running. This will energize the power brake system and cause severe braking, resulting in non-warranty brake damage.

How to remove the braking system

1. Unplug 12 volt power cord.
2. Unplug monitor and BrakeAway wires.
3. Press air relief.
4. Slide seat to rearmost position.
5. Detach clamp from brake pedal by pushing on the lower edge of the release tab or pulling the top of the release tab towards you which is located on the left of the clamp as seen in figure 4, and lift the unit out of vehicle.
6. Wrap 12 volt cord onto cord holder.
7. Transmitter and Receiver can be left in place or stored.
8. Be sure BrakeAway cord is safely secured so that it cannot become entangled while driving vehicle.
9. It is okay to remove Breakaway cable; however, do not remove the Breakaway pin as:
 - a.) Dirt will accumulate in Break Away switch possibly causing unwanted activation or preventing proper operation of Break Away.
 - b.) Failure to reinsert pin before installing the braking system unit will cause unwanted activation, potentially causing injury or property damage.

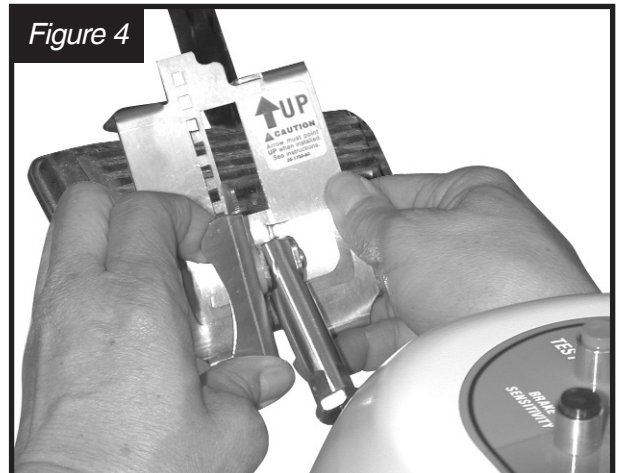

CAUTION:

Never leave Breakaway pin out of Break Away switch. Failure to reinsert pin before installing the unit will cause unwanted activation, potentially causing injury or property damage.

Troubleshooting

There are a wide variety of symptoms that can be related to something as simple as a blown fuse. The braking Unit, the Receiver, and the Transmitter each have their own fuse built into the end of the power cord. Simply unthread the ring at the end of the plug to remove the fuse. Be careful not to lose the spring inside. See figure 5.

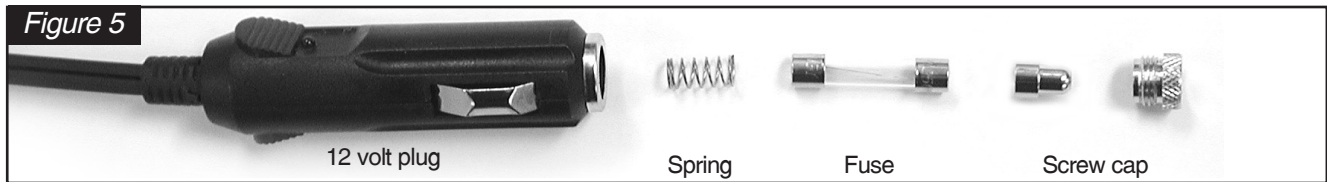

Symptom: The red light on the system continually flashes and does not stop.

Solution: This is your low battery voltage alarm. Please refer to the section titled “Brake Alert Operation” to see what this means and what to do.

Symptom: Red light flickers over rough terrain or when not braking.

Solution:

- Whenever the RV decelerates, the Unit’s module board will call for braking and send a signal to the Receiver in the motorhome causing the red light to illuminate. As a result, you may see the red light flicker on and off as you go over bumps and potholes (when not braking). It is important to know that when the red light flashes momentarily, that your brakes are NOT yet activated. In this case, the system anticipated braking, but then stopped calling for brakes as the deceleration immediately went away. In short, it is possible for the red light to flicker over rough terrain or slow deceleration, and that this is no cause for concern as your brakes are not actually depressed unless the red light stays on longer than momentarily.
- If the light is flickering too often, increase sensitivity setting by 1 to make the system less sensitive to rough terrain. It is important to note however, that the Unit may require more than light stopping before it will activate.

Symptom: The yellow light remains lit on the Receiver and the red light flashes every 5 seconds or so.

Solution: The reset button on the Receiver has been depressed too long causing the Receiver to go into the reprogramming mode. This can usually be resolved by unplugging the Receiver. Reconnect and test for proper operation. If the Receiver is not getting the signal from the Transmitter, then you will need to reprogram the Receiver as outlined in the section titled “Recoding BrakeAlert”.

Symptom: My Unit will not fit properly in my vehicle.

Solution: On some vehicles (such as the Jeep Liberty) the door jamb curves in sharply at the bottom restricting the floor space required for the Unit. In this event, you may be able to raise the feet on the unit to gain adequate clearance. An additional one inch of height can be gained by using Roadmaster’s optional feet extenders part number 9337-4 (set of 4).

Symptom: The test button is being depressed by the dashboard, it’s too close to the dash.

Solution: In order to alleviate this problem you need to adjust the position of the unit. Do this by:

- Lowering the braking system by threading the feet into the unit.
- Lowering the braking system further by removing the feet from the unit.
- Installing optional cylinder arm extender part number 9336 (1.5 inch) or 9336-3 (3.5 inch) to allow the unit to sit farther back from the dash board and still reach the brake pedal.

Symptom: The pedal clamp does not fit my brake pedal securely.

Solution: Use a pair of channel locks or pliers to bend the five tabs of pedal clamp assembly to better fit pedal. Contact Roadmaster in the rare event that your pedal clamp cannot be made to fit your brake pedal. Please have make, model and whether transmission is manual or automatic when calling Roadmaster.

Symptom: Air cylinder will not extend to connect to pedal clamp.

Solution: Air cylinder is full of air which will not allow pedal clamp to extend. Release air by holding air relief button.

FAILURE TO INSTALL AND OPERATE THE BRAKING SYSTEM AS INSTRUCTED MAY RESULT IN UNIT TO MALFUNCTION, PROPERTY DAMAGE, PERSONAL INJURY OR DEATH.

Troubleshooting continued

Symptom: The brake pedal clamp on the braking system comes into contact with the unit housing.

Solution: Brake pedals that are somewhat horizontal cause the pedal clamp to tilt. This angle causes the pedal clamp to interfere with the unit housing when it retracts. Use optional pedal extender part number 9336 (1.5 inch) or 9336-3 (3.5 inch) to gain additional clearance from the housing.

Symptom: Nothing happens after proper installation.

Solution:

- Check fuse on the end of power cord. The braking system unit uses a 20 amp fuse and the BrakeAlert uses a 10 amp fuse.
- Check power at 12 volt outlet with key in towed position. If there isn't any 12 volt power you will need an optional 12 volt power outlet (part number 9332).
- Polarity on 12 volt outlet kit has been crossed. Positive is connected to ground and ground to positive. This will blow the 20 amp fuse in the end of the 12 volt power cord. You will need to correct the wiring and replace the 20 amp fuse in the end of the power cord.

Symptom: Braking system is not running.

Solution: Check for red LED light on cigarette plug. Check fuse for towed vehicle. Also, check your battery voltage. If your battery does not have sufficient power it will put the unit into sleep mode, always make sure your battery has full power.

Symptom: As soon as I plug in the braking system, the compressor starts cycling on and off and the air cylinder starts pumping in and out ("jack-rabbiting").

Solution: Simultaneously press and hold the "Max Brake" button and "Brake Sensitivity" button until the row of sensitivity lights flash three times. This will program level and eliminate the symptom. If the box is not attached to the brake pedal and in position for towing, then you will have to re-program level again once the box is properly in position. See section titled "Programming Level" for more details.

Symptom: Braking system's air cylinder jack rabbits (extends and retracts) repeatedly.

Solution:

- Vehicles wiring is too small or low in power for the unit to operate properly. The braking system requires 15 amps to function properly. Install optional 12 volt power outlet (part number 9332) to supply sufficient power to the system.
- This unit needs to be re-programmed for level. See section titled "Programming Level"

Symptom: Towed vehicle seat moves after the braking system depresses the brake pedal.

Solution: The unit may cause the seat to move. To avoid this, make sure the seat is in a locked position when it is adjusted behind the system's housing. Readjust the adjustable seat pad and re-test. Depress the test button and hold it until the cylinder extends to check for proper position and seat stability.

Symptom: The unit rides up the seat.

Solution: Remove the floor mats under the braking system and/or check the position of the adjustable handle. The handle also serves as an anchor point to keep the unit down as it depresses the brake pedal.

Symptom: Braking system is activating before I want it to, or when I don't think it should be.

Solution:

- Check for level of the unit in the towed car. If level, raise sensitivity number by 1.
- Reprogram level as described under section "Programming Level"

Symptom: My brakes are applying when they should not be.

Solution:

- Reprogram level as described under section "Programming Level".
- The braking system may activate even when you are not depressing the motorhome's brakes. This is usually a result of an incorrect sensitivity setting. If you are experiencing unwanted activation while going down steep grades, increase the number on the Brake Sensitivity to make the unit activate to your preferences. Jake Brakes and Pac Brakes (that is engine braking systems) may also cause unwanted system activation which can be solved the same way.

IMPORTANT! THIS DECREASED BRAKING SENSITIVITY SETTING MAY PREVENT THE SYSTEM FROM ACTIVATING DURING NORMAL LIGHT BRAKING CONDITIONS.

FAILURE TO INSTALL AND OPERATE THE BRAKING SYSTEM AS INSTRUCTED MAY RESULT IN UNIT TO MALFUNCTION, PROPERTY DAMAGE, PERSONAL INJURY OR DEATH.

Troubleshooting continued

Symptom: Towed vehicle's fuse for 12 volt outlet keeps blowing.

Solution: Check towed vehicle's fuse size. The braking system uses a 20 amp fuse. If towed vehicle's is not sufficient, install optional 12 volt power outlet (part number 9332). If fuse is of sufficient size, unplug BrakeAway from the unit to see if fuse stops blowing. If so, you have a short in the BrakeAway wiring harness. Inspect wire for possible grounding and repair.

Symptom: The BrakeAlert system is not working.

Solution: Verify that all RCA plugs are connected to the correct jack: red to red, white to white, blue to blue. Check for red LED light on Transmitter in towed vehicle (should illuminate each time the system activates). Check fuse in the end of the 12 volt power cord for the unit, Transmitter & Receiver. Also, make sure the antennas on both the transmitter & receiver are not parallel to the power cords or near any other wiring or power sources as this may interfere with the BrakeAlert system.

Symptom: Red light on power cord is not illuminated when plugged into towed vehicle's 12 volt outlet.

Solution:

- Some vehicles do not have power unless vehicle is running. Start towed vehicle to see if you now have power. If so, install Roadmaster optional 12 volt power outlet (part number 9332).
- Check fuse for 12 volt outlet.
- Check fuse in end of the braking system 12 volt plug.

Symptom: Brake lights on towed vehicle are overriding turn signals.

Solution: May need to use optional Brake-Lite Relay Kit part number 88400. See "Brake-Lite Relay Kit" towards the rear of the manual.

Symptom: The compressor comes on when the system is plugged in, but not actually being used for braking.

Solution: The system's compressor will activate about every 10 minutes due to normal air dissipation. If compressor activates repeatedly within a ten minute or less period (when not braking), contact Roadmaster Inc., you may have an air leak.

Question: How do I increase brake power?

Answer: Push the Max Brake Pressure button to select a higher number. Setting 1 being the least braking and setting 4 being the greatest.

Question: How do I decrease brake power?

Answer: Push the Max Brake Pressure button to select a lower number.

Symptom: After towing there is excessive brake dust on wheels on towed vehicle.

Solution: Decrease Max Brake Pressure setting by 1 number.

Symptom: After towing there is an unusual odor coming from the brakes on towed vehicle.

Solution: Decrease Max Brake Pressure setting by 1 number.

HELPFUL HINT! Setting the **Brake Sensitivity** to a higher number means you will need more force on the RV brake pedal to activate the system. Setting the **Max Brake Pressure** to a higher number means the braking unit is exerting more pressure on the towed vehicle's brake pedal.

FAILURE TO INSTALL AND OPERATE THE BRAKING SYSTEM AS INSTRUCTED MAY RESULT IN UNIT TO MALFUNCTION, PROPERTY DAMAGE, PERSONAL INJURY OR DEATH.

Optional Equipment

Brake-Lite Relay Kit - #88400

This easy-to-install kit prevents the brake signal from over-riding the turn signal of a towed vehicle. It is necessary to install this kit on many vehicles with add-on braking systems that depress the car's brake pedal and will not interfere with the car's electronics when the ignition is on. See "Brake-Lite Relay Kit" install instructions later in this manual.

Kit includes:

- All wires and components needed • Easy to follow instructions



12 Volt "Y"- #9330

Use this "Y" to connect more than one 12 volt accessory to a single 12 volt outlet.



12 Volt Extension Cord - 6ft - #9331

This extension cord will extend your 12 volt outlet by 6 feet.



12 Volt Outlet Kit with 5ft. Wire - #9332

Some models of cars have no power to the cigarette lighter when the ignition key is off. The braking system cannot operate correctly with an outlet with less than 15 amps of power. Use this kit to create a new full time 12 volt, 20 amp power outlet.



Second vehicle BrakeAway kit - #98162

The BrakeAway is an integral and necessary part of a safe towing experience. Since the BrakeAway is hard wired into the car through the firewall, if you have a second car it is recommended that you purchase a second kit to make your towing experience safe and easy.



1.5" Cylinder arm extender - #9336

This option lengthens the reach of the braking system's cylinder arm 1 1/2 inches. Threads between pedal clamp and cylinder arm.



3.5" Cylinder arm extender - #9336-3

This option lengthens the reach of the braking system's cylinder arm 3 1/2 inches. Threads between pedal clamp and cylinder arm.

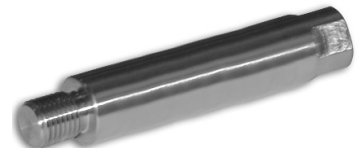

Foot extender - #9337 1 ea. #9337-4 (4 pack)

This option allows the braking system to sit higher in the vehicle. Threads into bottom of the unit, then adjustable feet thread into extensions.



How to install optional 12 volt, 20 amp power connector #9332

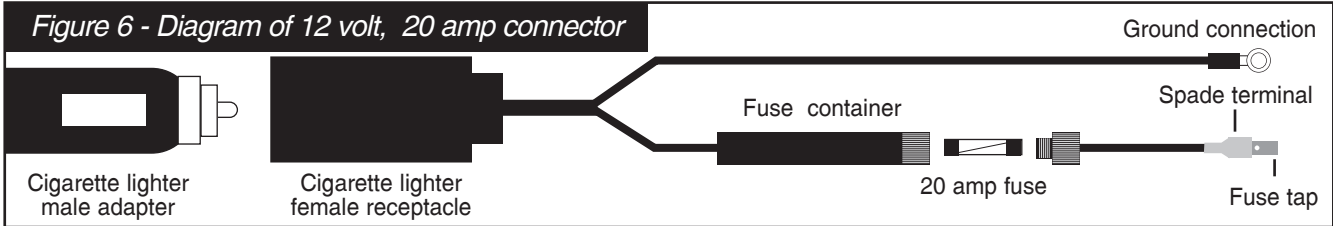

Some models of cars have no power to the cigarette lighter when the ignition key is in towed position. This braking system cannot operate without power. Also, some cars do not have the required 15 amp power supply for the cigarette lighter outlet. The following are instructions on how to install the number 9332 kit in order to provide the braking unit with a new full time 12 volt, 20 amp outlet.

1. Inspect the towed car's fuse panel with a test light. Some of the fuses will have power all the time, while others will only have power when the ignition is turned on. Find an ATC type fuse that has power with the ignition off. Pull the fuse.
2. Determine which side of the fuse terminal is "HOT". The "HOT" side will have power to it all the time.
3. Pull the fuse and install the fuse tap on the "HOT" side of the fuse as shown in Fig. 7. With the towed car's ignition off, replace the fuse into the socket. Make sure to crimp the fuse tap securely to the fuse blade. Use spade terminal to connect cigarette outlet to fuse tap. Connect the ground wire to chassis with the screw provided.

CAUTION **CHECK 12 VOLT OUTLET BEFORE PLUGGING IN SYSTEM.** Verify that the wire with the ring terminal is connected to ground while the wire with the fuse is connected to the fuse block. **If the positive and negative wires are reversed, the 20 amp fuse in the end of the 12 volt power cord will blow.**

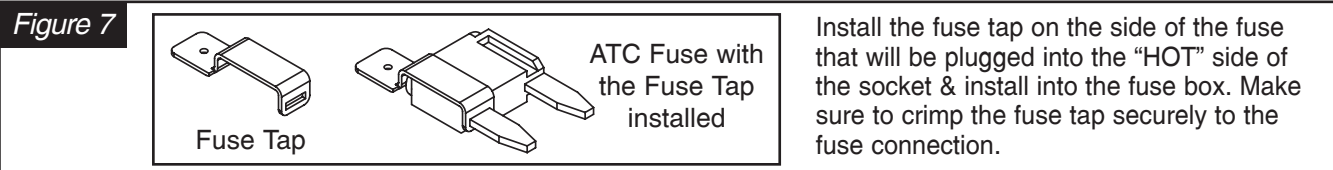

WARNING: Do not connect the fuse tap to the cold side of the fuse socket. If the towed vehicle's fuse blows, the braking system will not function and you will have no brakes on the towed vehicle while towing.

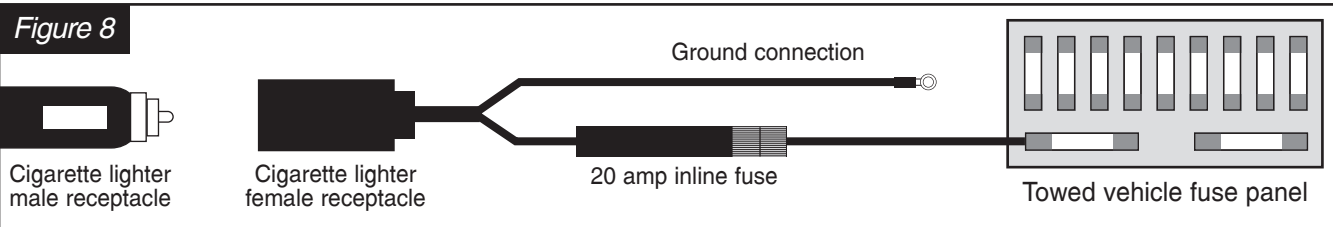

WARNING: Failure to install inline fuses as shown in Fig. 8 will result in electrical fire, property damage, personal injury or death, which Roadmaster will not be held liable for.

Brake Light Solutions

IMPORTANT! Depending on how your towed car is wired for lights, it is possible that the brake lights will override the turn signal. This occurs when the brake light power (from the towed car) overrides the turn signal power (from the motorhome). In short, the towed car is trying to flash the turn signal, but the power from the brake keeps the bulb illuminated preventing it from flashing. You can solve this by adding the Brake-Lite Relay Kit number 88400 or by adding additional wiring diodes to your towed car. Detailed instructions for both solutions follow. Alternatively, you can install Roadmaster's bulb and socket kit #155.

Optional Brake-Lite Relay Kit (part #88400)

! WARNING: **DO NOT USE BRAKE-LITE RELAY ON ANY FORD THAT HAS A "NEUTRAL TOW KIT". USE OF THE BRAKE-LITE RELAY MAY PREVENT DISENGAGEMENT OF THE TRANSMISSION FOR TOWING, CAUSING SEVERE NON-WARRANTY TRANSMISSION DAMAGE.** For all vehicles that have a Ford "Neutral tow kit" either use the Brake-Lite solution on the following page or install Roadmaster's Bulb & Socket kit #155.

Installation Instructions

1. Locate the towed vehicle's brake light switch. Cut the cold side of the brake light wire a few inches downstream from the brake light switch. **CAUTION:** Verify that you have the correct wire. When the wire has been cut, with the key in the "on" position, put your foot on the brake. If the brake lights remain on, you've cut the wrong wire. Once you have located the correct wire, install the Brake-Lite Relay in line as shown in Figure 9.

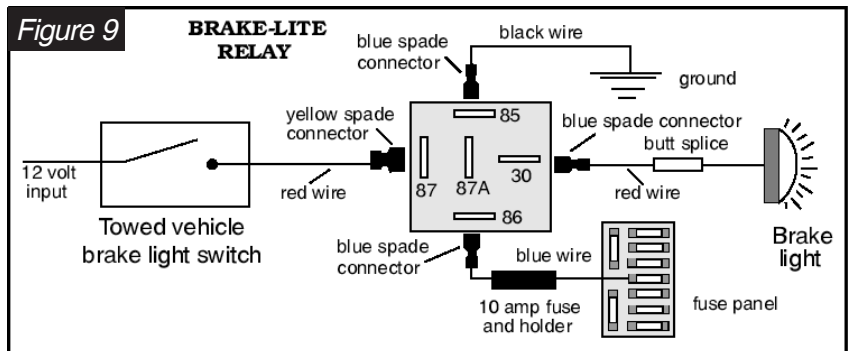

WARNING: Make sure that you install the 10 amp fuse assembly within 6" of the power source.

2. Using fuse tap, connect the blue wire from the Brake-Lite Relay to the "HOT" side of any fuse which is powered ONLY when the towed car's ignition is turned on. **NOTE:** The "HOT" side of the socket is the one that registers voltage when the fuse is pulled, the ignition switch is on and tester is connected between the socket and ground.
3. Connect the black wire to any good chassis ground.
4. Secure the Brake-Lite Relay and wiring harness using enclosed zip ties.
5. Test System:
 - a. When the car is running, the brake lights will function normally.
 - b. When car's ignition is off, brake lights will not function.

NOTE: Do NOT drive your vehicle if the brake lights are not functioning normally.

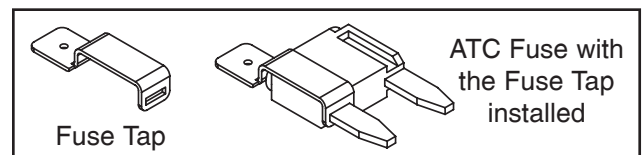

! CAUTION: With Brake-Lite Relay Kit installed, the towed vehicle's brake lights will ONLY function when the towed vehicle's ignition is ON.

Brake Light Solutions

Only use this solution if your motorhome has combined brake & turn signals and your towed vehicle has separate brake & turn signals

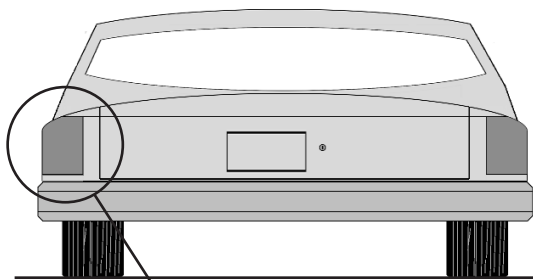

Combined Brake / Turn Light System

The brake light does the flashing for the turn signal

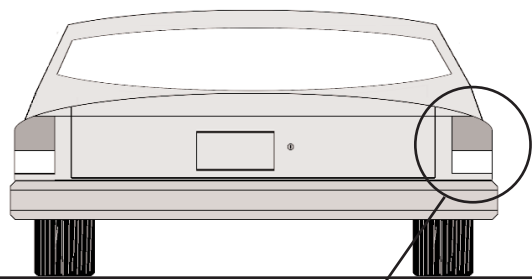

Separate Brake / Turn Light System

There are amber or red turn signals which are separated from the brake lights

Use two optional diodes and wire as shown in Figure 10. When wired properly, both the turn signal and brake light will flash when the turn signal is on. However, when the brake & turn signal is on, the brake light will stay illuminated while the turn signal flashes. If the turn signal on the towed vehicle stays on when the brake pedal is depressed, then you will need the Brake-Lite Relay Kit number 88400.

Figure 10

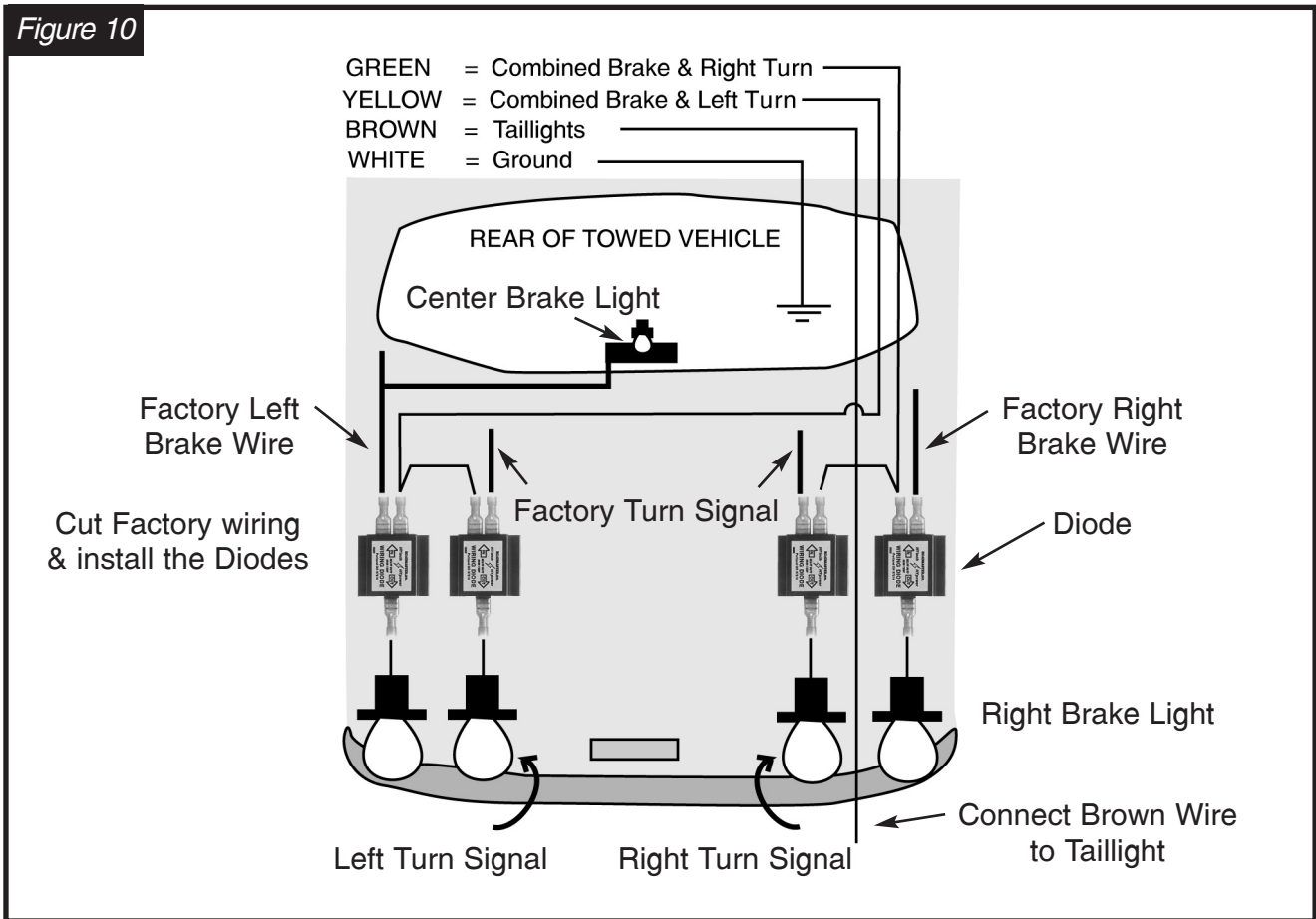

WARNINGS

Failure to release emergency brake on towed vehicle before towing will result in severe brake damage or brake fire and is not covered by warranty. It is important to note that the BrakeAlert monitor system will NOT illuminate when your emergency brake is on.

Do not leave your car running while towing as this will allow your power brakes to function. This unit is designed to work with a dead pedal. The power brakes will cause excessive braking in the towed car resulting in significant brake and tire damage not covered by warranty. If for any reason you must have the towed vehicle running while being towed, it is imperative that you disconnect the braking system.

WARNING! The BrakeAlert monitor system is designed to communicate the braking status of the braking unit. Light on means your brakes are on. If the light stays lit even when you are not braking the RV, immediately stop and investigate. DO NOT continue to tow until the problem has been corrected. Failure to do so will result in significant brake wear, damage or even a possible fire in your towed vehicle. Towing in this fashion voids warranty and will result in non-warrantable property damage.

FAILURE TO INSTALL AND OPERATE THE BRAKING SYSTEM AS INSTRUCTED MAY RESULT IN UNIT TO MALFUNCTION, PROPERTY DAMAGE, PERSONAL INJURY OR DEATH.

ROADMASTER LIMITED WARRANTY

1. WARRANTY

1a. WARRANTY OF CONFORMITY AT TIME OF SALE ROADMASTER, Inc. warrants that at the time of sale of this product it will be free from defects in material and manufacture and will conform to ROADMASTER'S specifications for the product.

1b. CONDITIONAL ONE-YEAR WARRANTY In addition to the preceding time-of-sale warranty, if the product registration card is completely and accurately filled out and mailed to ROADMASTER within thirty (30) days of purchase, ROADMASTER will provide an additional warranty that for a period of one year after sale the product will remain in good working order, PROVIDED THAT the product is installed and maintained in accordance with ROADMASTER'S instructions and is not subjected to: (a) alteration or unauthorized repairs or repairs by anyone other than ROADMASTER or a ROADMASTER-authorized service center, (b) misuse, abuse, commercial use, or improper maintenance, (c) Acts of God (including without limitation hurricanes, tornadoes, floods, or other severe weather or natural phenomena),

(d), failures due to products not supplied by ROADMASTER, or (e) other treatments, uses, or installations for which the product was not intended. This warranty extends only to the first retail purchaser-consumer of the product and is not transferable.

EXTENDED WARRANTY PERIOD: If ROADMASTER receives the product registration card, completely and accurately filled out, within twenty (20) days of purchase, ROADMASTER will enlarge the one-year warranty period in the preceding paragraph to a period of two years.

2. DISCLAIMER OF OTHER WARRANTIES

The preceding warranties are the exclusive and sole express warranties given by ROADMASTER. They supersede any prior, contrary or additional representations, whether oral or written. No agent, representative, dealer or employee has the authority to alter or increase the obligations or limitations of this warranty. Any implied warranties, including the WARRANTY OF MERCHANTABILITY and any WARRANTY OF FITNESS FOR A PARTICULAR PURPOSE, are limited in duration to thirty days or the term of the applicable express warranty provided above, whichever is longer. Some states do not allow limitations on how long an implied warranty lasts, so the above limitation may not apply to you.

3. EXCLUSIVE REMEDY FOR ANY NONCONFORMITIES

If during the applicable Warranty Period, the product does not conform to the preceding Warranties, notify ROADMASTER as provided below, and within a reasonable time ROADMASTER will provide, at its option, one of the following: (1) replacement components for any nonconforming or defective product or components or (2) the percentage of the purchase price for the nonconforming product equal to the percentage of the Warranty Period remaining when ROADMASTER is notified of the nonconformity. ROADMASTER will, at its option, (a) use new and/or reconditioned parts in performing warranty repairs and making replacement products, (b) use parts or products of original or improved design in the repair or replacement. If ROADMASTER repairs or replaces a product, its warranty continues for the remaining portion of the original Warranty Period or 60 days from the date of the return shipment to the customer, whichever is greater. All replaced products and all parts removed from repaired products become the property of ROADMASTER. ROADMASTER will not provide, and will not be liable for, labor, costs of removal or reinstallation of components, disposal, shipping, freight, taxes, or other incidental charges.

THESE REMEDIES ARE THE EXCLUSIVE AND SOLE REMEDIES FOR ANY BREACH OF WARRANTY.

For any breach of warranty, the Owner must telephone ROADMASTER at 1-800-669-9690 within thirty (30) days after discovering the nonconformity. Do not return any product without first calling ROADMASTER and getting a return authorization number. Returned products must include the return authorization number and a copy of the original invoice, bill or other proof of the date of purchase. The date of purchase must coincide with the original warranty registration card on file. ROADMASTER will authorize (a) shipment of the product to ROADMASTER or (b) repair or replacement at the nearest warranty service center—in both cases with shipping at your expense. Do not purchase replacement parts or pay for repair labor—you will not be reimbursed. Compliance with the requirements of this paragraph is a condition to coverage under the Warranty: if these requirements are not complied with, ROADMASTER will have no obligation to provide any remedy for any breach of warranty.

4. DISCLAIMER OF INCIDENTAL AND CONSEQUENTIAL DAMAGES

IN NO EVENT SHALL ROADMASTER BE LIABLE FOR ANY INCIDENTAL, SPECIAL, INDIRECT OR CONSEQUENTIAL DAMAGES, WHETHER RESULTING FROM NONDELIVERY OR FROM THE USE, MISUSE OR INABILITY TO USE THE PRODUCT OR FROM DEFECTS IN THE PRODUCT. Some states do not allow the exclusion or limitation of incidental or consequential damages, so the above limitation may not apply to you.

5. APPLICABLE LAW

This Warranty will be interpreted, construed, and enforced in all respects in accordance with the laws of the State of Oregon, without reference to its choice of law rules. The U.N. Convention on Contracts for the International Sale of Goods will not apply to this Warranty.

6. SEVERABILITY

If any provision of this warranty is found to be invalid or unenforceable, then the remainder shall have full force and effect, and the invalid provision shall be partially enforced to the maximum extent permitted by law to effectuate the purpose of the agreement.

7. ADDRESS FOR NOTICES TO ROADMASTER : ROADMASTER, Inc., 5602 N.E. Skyport Way, Portland, OR 97218

This warranty gives you specific legal rights, and you may also have other rights which vary from State to State.

All illustrations and specifications contained herein are based upon the latest information available at time of publication. ROADMASTER, INC. reserves the right to make changes at anytime without notice in material, specification and models or to discontinue models.

