

Valve Manufacturers Association

75th Annual Meeting

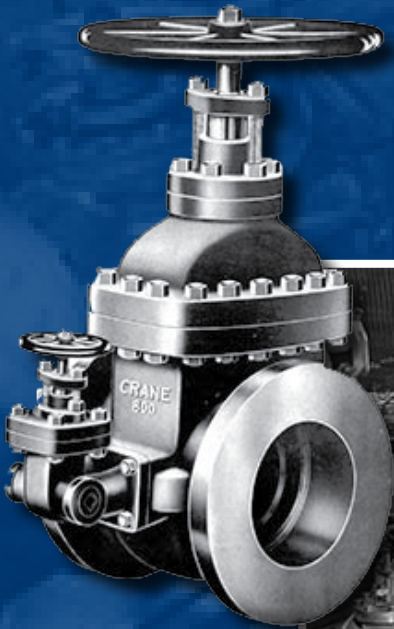

October 3-5, 2013
The Breakers / Palm Beach, Florida

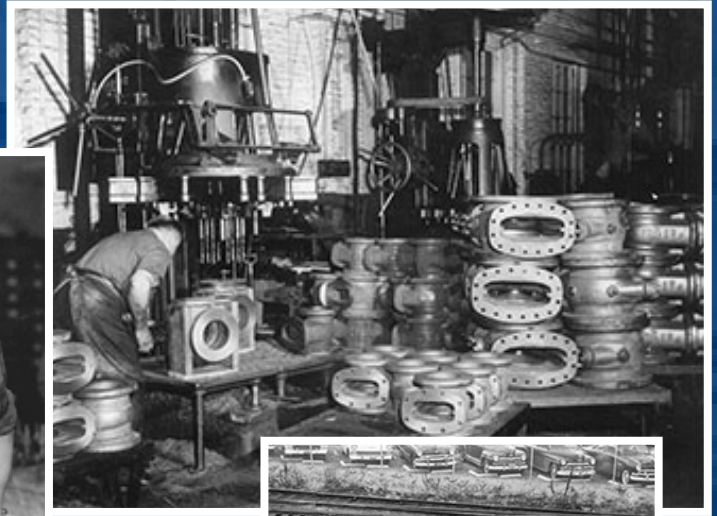
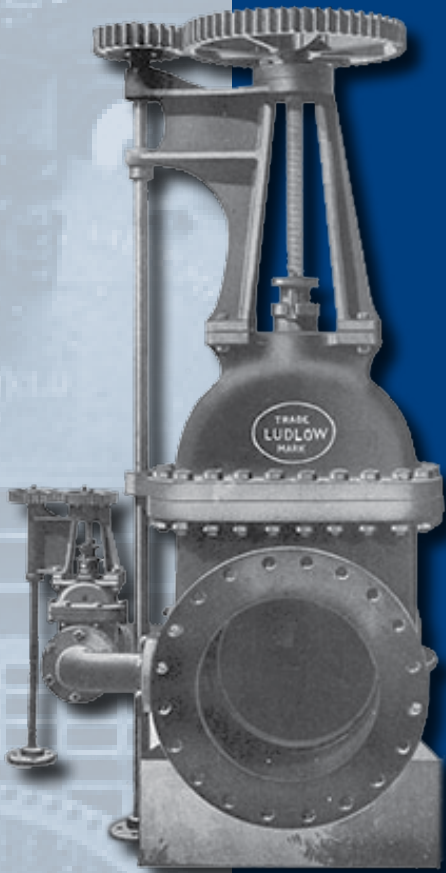

VMA CHAIRMAN'S LETTER

Pattie and I extend our warmest welcome to all of you for VMA's Special 75th Annual Meeting at the beautiful Breakers Hotel in Palm Beach, Florida. Once again, there is something planned for everyone. Educational, social, and sporting activities for members and their guests make for a full agenda.

I once again encourage members to bring the up and coming professionals on their staff. Program Committee Chairman Greg Rogowski (Mueller Co.) and his Committee colleagues Sam Bennardo (AUMA), Mike Mason (Fisher Controls), and Jim White (CWFC), have come up with an outstanding program for this special occasion featuring excellent speakers.

In addition to educational opportunities, we have a full program of social and sporting activities. The Spouse/Guest Program continues to provide an opportunity for the spouses and guests of VMA members to reacquaint themselves with old friends and meet new attendees. This year's Spouse/Guest Program will once again introduce attendees to the special attractions of the area.

As in the past, our Annual Meeting serves as a special occasion to recognize those who have served the industry through VMA activities. We realize that time given to VMA is especially valuable in these times of rebuilding our companies both domestically and abroad; so we are pleased that you are joining in an important VMA tradition, recognizing those special contributors with the Person of the Year Award and the Service Awards.

The past few years we have shared our Annual Meeting with representatives from our affiliated organization, the Valve Repair Council and this year we will once again share the entire program with them. I encourage your networking with their representatives during our meeting.

Additionally, we will once again be visited by our European colleagues.

I look forward to seeing you in Florida!

MARK CORDELL
Cameron Valves & Measurement
VMA Chairman

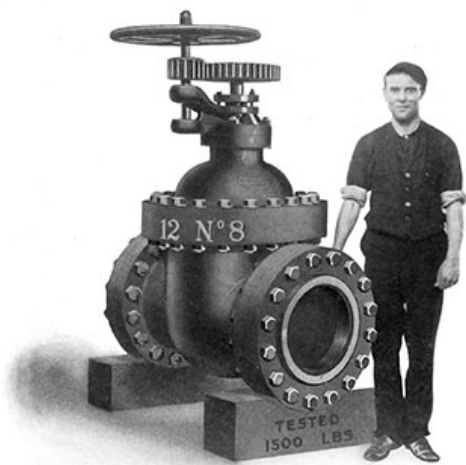

Schedule of Events

THURSDAY, OCTOBER 3

1:00 - 2:30pm

GENERAL SESSION I

(Spouses/Guests invited)

In the Company of Heroes

Speaker: Michael Durant, Best Selling Author and Inspiration for the Movie Black Hawk Down

Chief Warrant Officer Four Michael J. Durant is the best-selling author of *In the Company of Heroes* and the inspiration for the movie *Black Hawk Down*. He was the sole survivor of the helicopter crash caused by a Somali-fired grenade and held as a prisoner of war for 11 days. Prior to his time in Somalia, Durant had participated in combat operations in the Persian Gulf, Panama, and Kuwait. A highly-decorated soldier, his awards include the Purple Heart and the Distinguished Service Medal.

2:30 - 3:00pm

Coffee Break

Sponsored by Publications by Tibbs, Inc.

2:30 - 5:00pm

Spouse/Guest Event

Cheese Tasting

The VMA Spouse Committee, chaired by Pattie Cordell, Welcomes you to the Ponce De Leon Ballroom

[Click here for details or click here to register.](#)

(RSVP required)

Sponsored by QTRCO, Inc.

3:00 - 4:30pm

GENERAL SESSION II

Profitable Top-Line Growth for Industrial Companies

Speaker: Jim Hlavacek, Founder & Managing Director of Market Driven Management and Founder & CEO of The Corporate Development Institute, Inc., Charlotte, NC

Mr. Hlavacek has worked with numerous industrial companies and will give pointers on how to have profitable top line growth. He will differentiate between consumer and industrial approaches to profits.

4:30pm

Adjourn

6:00pm

Meet and Greet Reception

Dinner on your own

[*A list of local restaurants may be found here.*](#)

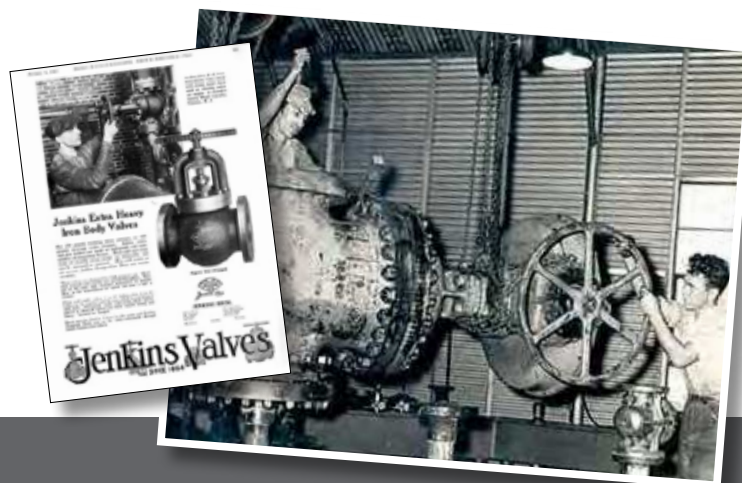

FRIDAY, OCTOBER 4

7:00 - 7:45am

Spouse/Guest Event

Sunrise Yoga on the Ocean Lawn, Channel your Inner Zen

[Click here to register.](#) (RSVP required)

7:30am

Continental Breakfast

(Spouses/Guests invited)

8:30 - 9:30am

GENERAL SESSION III

2014 Valve Industry Outlook

Alan Beaulieu, Principal, ITR Economic, Boscawen, NH

Mr. Beaulieu will give his latest outlook for the coming year for valves, actuators and controls, as well as the key end-user industries we sell.

9:30 am - 12noon

Spouse/Guest Event

Palm Beach Confidential!

[Click here for details](#) or [click here to register.](#) (RSVP required)

9:30 - 10:00am

Coffee Break

Sponsored by Furmanite

10:00 - 11:30am

GENERAL SESSION III (continued)

2014 Valve Industry Outlook

Alan Beaulieu, Principal, ITR Economic, Boscawen, NH

11:30am

Adjournment Session III

12:30pm

Men's and Women's Golf Tournament

Ocean Course

Competition Holes

Sponsored by DOWCO Valve Company

Golf Beverage Cart

Sponsored by Furmanite

[Click here for details](#) or [click here to register.](#)

Optional Activities

[Click here for details](#)

6:30pm

Informal Reception & Dinner

Ocean Lawn

8:30 - 11:00pm

Dessert & Friday Night Fever at the Discotheque!

Ponce de Leon Ballroom 6

[Click here to view invitation](#) or [click here to register.](#) (RSVP required)

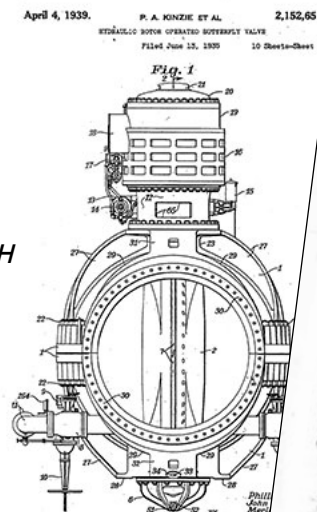

SATURDAY, OCTOBER 5

7:00 - 7:45am

Spouse/Guest Event

Sunrise Pilates on the Ocean Lawn

[Click here to register.](#) (RSVP required)

7:30am

Breakfast Presentation

(Spouses/Guests Invited)

Speaker, David Werner, Political Satirist

David Werner last performed for us in 2012. He is a former lawyer and congressional staffer turned political satirist and musical comedian. Werner offers a humorous, witty take on today's headlines mixed with musical impressions of top politicians.

Sponsored by Quality Valve

9:00 - 10:30am

GENERAL SESSION IV

Value Merchants

Speaker: James C. Anderson, William L. Ford Professor of Marketing and Wholesale Distribution, Kellogg School of Management, Northwestern University, Evanston, IL

Giving value away takes no particular skill. In stark contrast, a value merchant recognizes the supplier's own costs and the market offering's value to the customer and works to obtain a fair return for the both the supplier and customer firms. To transform their sales forces into value merchants, suppliers must adopt a philosophy of doing business based on demonstrated and documented superior value and put this philosophy into practice using a progressive, proven approach called customer value management. This presentation provides a basic understanding of customer value management and how to implement it.

10:30 - 10:45am

Coffee Break

10:45 - 11:30am

Annual Association Business Meeting

11:30am

Adjourn Session IV

12:30pm

Twellman Skins Golf Game

Ocean Course

[Click here for details](#) or [click here to register.](#)

Tennis Tournament - Round Robin

Tennis Beverage Table

Sponsored by Forum Energy Technologies

[Click here for details](#) or [click here to register.](#)

Optional Activities

[Click here for details.](#)

6:30 - 7:30pm

Cocktail Reception

Mediterranean Courtyard

7:30pm

Black Tie Dinner

Mediterranean Ballroom

Please join us in celebrating the VMA's very special 75th Anniversary. A Gala dinner; excellent and extra special entertainment; annual awards including Person of the Year, golf, tennis and fishing prizes of the day, and of course, Bill Sandler's traditional Coin Toss, and dancing the night away!

This year's entertainment are the Gin Blossoms. They are an American pop rock band formed in 1987 in Tempe, Arizona. They broke out with the song "Hey Jealousy" from their successful major label debut, *New Miserable Experience* (1992). After a series of charting singles, the band broke up in 1997. After they reunited in 2002 they released a fourth album, *Major Lodge Victory*, in 2006, and their fifth, *No Chocolate Cake*, in 2010.





Spouse/Guest Events

THURSDAY, OCTOBER 3

2:30 - 5:00pm

Spouse/Guest Event

The VMA Spouse Committee, chaired by Pattie Cordell, Welcome you to the Ponce De Leon Ballroom



Say "Cheese"

Not a course in photography but a new approach to the traditional cheese tasting. During this interactive learning session we will have the opportunity to learn about and enjoy the subtleties of Artisan cheese. Not only will we experience the wonderful flavors and characteristics of cheese but The Breakers culinary team will put a special twist on this old classic!

RSVP requested, please indicate on registration form.

FRIDAY, OCTOBER 4

9:30am - 12noon

Spouse/Guest Event

Palm Beach Confidential! Private motor coach tour

Leslie Diver, your tour guide, will introduce you to the town of Palm Beach with its colorful history, world-class architecture and its residents - both famous & infamous.

Sit back and enjoy yourself while Leslie entertains you with stories while pointing out such sites as: rocker Rod Stewart's home, Mar-a-Lago (Donald Trump's private club and residence), the infamous Ham Sandwich House (with its own segment of City Confidential tv show), the Yoko Ono House, James Patterson's home, and some of the most expensive estates ever sold in the United States - including a mansion that sold for \$92 million dollars 22 years ago to set the US record at that time. Only in Palm Beach - the richest town in the United States - can you have such a tour!!

Should we have a sign-up greater than 49 spouse/guests we will stay at The Breakers and Leslie will present her PowerPoint "Meeting Palm Beach!"

Leslie Diver, resident & tour guide in Palm Beach, entertains you with a lively talk and power point presentation of the famed town of Palm Beach. Leslie has owned her own tour business for the past decade in Palm Beach and has put together what she believes are the favorite stories about the town into a fun & informative presentation.

Learn who is the richest Palm Beacher and how you can easily see his home from The Breakers; learn how many wives Henry Flagler had and what became of them (was it murder or was it just a drug overdose?) learn about some of the town's "bad boys" including town commissioner Jim Sullivan - now in prison for the rest of his life. Finally, Palm Beach is the richest town and the richest zip code in the United States, come and join Leslie and find out why the residents really live here.

RSVP requested, please indicate on registration form.

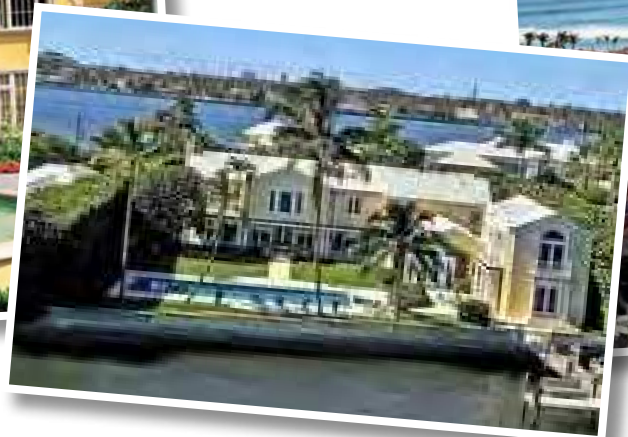
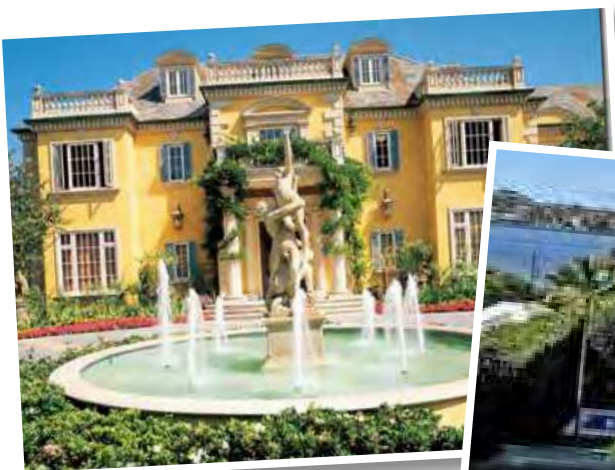



Optional Activities

FRIDAY, OCTOBER 4

12:30pm

2013 Men's and Women's Golf Tournament

Ocean Course

With fairways that weave between sandy hazards, the Ocean Course rewards wit over power, challenging golfers to play the ball low on 140 acres overlooking the Atlantic.

First laid out in 1896 by Alexander H. Findley, the Ocean Course was redesigned in 2000 by Brian Silva, Golf World's 1999 Architect of the Year. Combining a love of the game with technology, Silva preserved its unique attributes, while perfecting the course for the 21st century golfer. Silva's redesign addressed tee elevation, tee sizes, surface slopes, pin placement areas, the integration of sand and grass-faced bunkers and included a complex installation of new drainage and irrigation.

The Ocean Course features:

- 200 more yards of playing length
- 18 new putting surfaces
- 10,000 square-foot putting green
- 88 new and refurbished bunkers
- Left-to-right and right-to-left holes

- Continuous cart paths
- State-of-the-art turf TifEagle Bermuda grass from tee to green providing the truest roll
- Addition of a sixth lake
- Computerized drainage system lets the course dry out in record time
- Dozens of mature palm and tropical-flowering trees

Tournament fee is \$180 per person

Please use the registration form to sign up for golf, and please note your handicap. Tournament fees will be billed to your guest room folio. For a box lunch, please choose here, and mark your selection on the registration form.

Prizes will be awarded to the top three teams, as well as some 'special' prizes for select holes. Both experienced and novice golfers can win, in both the Ladies and Gents categories:

1. Closest to the Hole - Hole 5
2. Straightest Drive - Hole 7
3. Longest Putt - Hole 18

Prizes will be awarded during the Awards Ceremony on Saturday evening.





Optional Activities

FRIDAY, OCTOBER 4



Biking

Enjoy biking around historic Palm Beach on a beach cruiser style bike with back pedal brakes. Rentals are by the hour and are \$15 per hour.

[Click here to register!](#)

FRIDAY, OCTOBER 4

1:30 - 3:30pm

Flamenco Class

Venetian Ballroom

\$70 per person

Somewhere, deep inside, there's a flamenco dancer in us all! A perfect way to relieve stress, and get fit in this fun and feisty Spanish dance - with professional instructors. Liquid refreshments included.

[Click here to register!](#)



FRIDAY, OCTOBER 4

The Spa

Escape to the idyllic luxury of The Spa at The Breakers..... an oasis of relaxation and renewal, set amongst 140 acres of breathtaking ocean property and recognized as one of the top 25 spas in North America"

[Click here](#) for their menu of offerings.





Optional Activities

SATURDAY, OCTOBER 5

11:30am

The Norton Museum of Art

\$75 per person

The Norton Museum of Art was founded in 1941 by Ralph Hubbard Norton (1875-1953) and his wife, Elizabeth Calhoun Norton (1881-1947). The Nortons were actively interested in fine arts and developed a sizable collection of paintings and sculpture from the 19th and 20th masterpieces.

The Museum Collection consists of 7,000 works of art concentrated in the following departments: European, American, Chinese, Contemporary and Photography.

[Click here to register!](#)



SATURDAY, OCTOBER 5

12:30pm

Twellman Skins Golf Game

Ocean Course

Tournament fee is \$170 per person

Green fees will be billed to your guest room folio. Please link up with Steve Twellman for all other details.

Please use the registration form to sign up for golf, and please note your handicap. Fees will be billed to your guest room folio. For a box lunch, please choose here, and mark your selection on the registration form.

[Click here to register!](#)



Optional Activities

SATURDAY, OCTOBER 5

12:30pm

Fishing Tournament

\$205 per person

Deep sea fishing, to those that love it best, fishing is more than a sport, it's a way of life. Prizes will be awarded during the Awards Ceremony on Saturday evening.

[Click here to register!](#)



SATURDAY, OCTOBER 5

1:00pm

Tennis Tournament - Round Robin

\$107 per person

Another fun event for all levels of players!

Join us for a Round Robin format at one of the "top 50 tennis resorts" voted by *Tennis Magazine*. The Breakers tennis facility offers 10 beautifully groomed Har-Tru courts, a comprehensive pro shop with the latest fashions and equipment, USPTA/USPTR certified professional instruction, clinics and private court time. Lighted courts available for evening play.

Prizes will be awarded during the Awards Ceremony on Saturday evening.

[Click here to register!](#)



Hotel Information



THE BREAKERS

One South County Road, Palm Beach, FL 33480
561-655-6611

www.thebreakers.com

[Click here to view property map.](#)

Please contact the resort directly for your guest room accommodations at 888-273-2537.

VMA has negotiated special rates for three categories of rooms:

- Deluxe king rooms are \$260 per night, plus the additional taxes for Florida 6.5% (current) and 5% (current) Palm Beach local tax.
- Premium rooms are offered at \$320 per night, plus state and locals taxes.
- Oceanfront rooms are \$420 per night, plus state and locals taxes.

These rates are available three (3) days pre and/or post the main meeting dates (October 3-5, 2013) and subject to guest room categories and rate availability.

There is NO Resort Fee in conjunction with the above negotiated rate(s), and complimentary high-speed access is available in all guest rooms. The dress-code is resort casual in this non-smoking environment.

Check-in time is after 4:00pm on your arrival day, and check-out time is before 12:00noon.

The deadline for these special rates is close-of-business Wednesday, September 11, 2013, OR when the block is full, whichever comes first!

Please be aware that The Breakers cancellation policy is very strict during this extremely busy time; you will be charged should any cancellation not be received a minimum of three days prior to the previously anticipated arrival.

There is no self-parking at The Breakers, valet parking only at \$20 per night.

For any additional questions, please contact VMA Meetings Manager, Angela Hingston-Oliver via telephone at 202.331.8105 x312 or email at AHingstonOliver@vma.org.

Registration Information

Please print clearly

Name _____ **Badge Name** _____
 This is my first VMA/VRC Annual Meeting Yes No

 Title Company

 Address

 City State Zip

 Telephone Fax

 Email

Spouse/Guest Name _____ **Badge Name** _____
 This is my first VMA/VRC Annual Meeting Yes No

 Email (This will be used to forward any special spouse/guest program information.)

Choose check or charge:

- Charge:** Complete and fax to 202.296.0378, or scan and send as attachment to ahingstonoliver@vma.org
- VISA MasterCard Discover AmEx

 Name (exactly as printed on card)

 Billing address (if different than address on left)

 Card No.

 Exp. Date 3- or 4-digit code

Enclosed is a check in the amount of:

\$_____ representing ___ registrations
 Please make check payable to VMA, referencing the 2013 VMA Annual Meeting, and mail this form and check to: Valve Manufacturers Association, 1050 17th St., NW, Suite 280, Washington, DC 20036.

Please share with the VMA any details of your SPECIAL EVENT during the months of September/October.

Special Needs: Please indicate if you require special assistance and/or have any dietary requests/constraints that VMA should be aware of.

Meeting Fees

	Before 8/21/2013	After 8/21/2013	Total
MEMBER	\$850	\$900	\$ _____
GUEST	\$550	\$600	\$ _____
COUPLE	\$1,400	\$1,500	\$ _____
GRAND TOTAL			\$ _____

ACTIVITIES FEES

(See page 2 for activities fees)

3 Ways to Register

Mail:

Send completed form with payment to:
 VMA/2013 Annual Meeting
 1050 17th Street NW
 Suite 280
 Washington, DC 20036

Fax:

202/296-0378

Online:

www.vma.org/events

Meeting Cancellation Policy:

Full refund on meeting registration fee(s) provided written notice (fax or email) is received by the VMA office before close-of-business Wednesday, August 21, 2013.

A 75% refund will be provided for cancellations received Thursday, August 22 to COB Tuesday, September 3, 2013.

No refunds will be possible after September 3, 2013, and VMA/VRC is no longer able to provide credit towards future events/meetings.

Substitutions permitted at any time; please provide name changes before Friday, September 27, 2013, so that all meeting credentials can be corrected accordingly. Thank you.

Activities Fees

			Per Person	Members	Total
Thursday, October 3					
2:30 – 5:00pm	Spouse/Guest Event	Say Cheese (RSVP Necessary)	Complimentary	_____	Complimentary
Friday, October 4					
7:00 – 7:45am	Spouse/Guest Event	Sunrise Yoga	\$25 per person	_____	Charged to Guest Room
9:30am	Spouse/Guest Event	Palm Beach Confidential (RSVP Necessary)	Complimentary	_____	Complimentary
12:30pm	Golf Tournament				
Name _____		Handicap _____	\$180	_____	Charged to Guest Room
Club Rental (additional fees) <input type="checkbox"/> Right <input type="checkbox"/> Left					
Name _____		Handicap _____	\$180	_____	Charged to Guest Room
Club Rental (additional fees) <input type="checkbox"/> Right <input type="checkbox"/> Left					
Boxed Lunch – Sous vide med rare roast beef, portobellos, caramelized onions, grilled tomatoes, herb mayo on sesame brioche; grapes, chips, cookies, vitamin water			\$47	_____	Charged to Guest Room
Boxed Lunch – Cracked pepper turkey, brie, watercress, champagne mustard on multi-grain baguette, grapes, chips, Cookies, vitamin water			\$47	_____	Charged to Guest Room
Boxed Lunch – Vegetarian, mashed chick peas, egg, muenster cheeselemon, shaved fennel, diced roasted red pepper and chive remoulade on ciabatta; grapes, chips, cookies, vitamin water			\$47	_____	Charged to Guest Room
Biking	Time: _____ to _____		\$15 per hour	_____	Charged to Guest Room
1:30 – 3:30pm	Flamenco Class (includes liquid refreshments)		\$70 per person	_____	Charged to Guest Room
Saturday, October 5					
7:00 – 7:45am	Spouse/Guest Event	Sunrise Pilates	\$25 per person	_____	Charged to Guest Room
7:30 – 9:00am	Breakfast Speaker	David Werner, Political Satirist (RSVP Necessary)	Complimentary	_____	Complimentary
11:30am	The Norton Museum of Art		\$75	_____	Charged to Guest Room
12:30pm	Twellman “Skin” Game				
Name _____		Handicap _____	\$170	_____	Charged to Guest Room
Club Rental (additional fees) <input type="checkbox"/> Right <input type="checkbox"/> Left					
Name _____		Handicap _____	\$170	_____	Charged to Guest Room
Club Rental (additional fees) <input type="checkbox"/> Right <input type="checkbox"/> Left					
Boxed Lunch – Sous vide med rare roast beef, portobellos, caramelized onions, grilled tomatoes, herb mayo on sesame brioche; grapes, chips, cookies, vitamin water			\$47	_____	Charged to Guest Room
Boxed Lunch – Cracked pepper turkey, brie, watercress, champagne mustard on multi-grain baguette, grapes, chips, Cookies, vitamin water			\$47	_____	Charged to Guest Room
Boxed Lunch – Vegetarian, mashed chick peas, egg, muenster cheeselemon, shaved fennel, diced roasted red pepper and chive remoulade on ciabatta; grapes, chips, cookies, vitamin water			\$47	_____	Charged to Guest Room
12:30pm	Fishing Tournament		\$205	_____	Charged to Guest Room
Boxed Lunch – See above lunch choices and please write in your choice			\$47	_____	Charged to Guest Room
1:00pm	Tennis Tournament		\$107	_____	Charged to Guest Room
6:30pm	Black Tie Dinner Gala (RSVP Necessary)		Complimentary	_____	Complimentary

Please Note: All Optional Activity events are priced based on minimum/maximum participation. If item costs need to be amended, you will be notified accordingly, and in advance.

LOCAL DINING GUIDE

PALM BEACH

CAFÉ BOULUD **561/655-6060** **BRAZILIAN COURT HOTEL, 301 AUSTRALIAN AVE**

This trendy upscale café is the first location outside of New York City for renowned chef Daniel Boulud. It has become an instant classic featuring contemporary French cuisine with one-of-a-kind specialties. Breakfast, lunch and dinner served daily.

CAFÉ L'EUROPE **561/655-4020** **331 SOUTH COUNTY RD**

This is one of Palm Beach's favorite dining locations offering a culinary tour of Europe in both a formal dining room and an upscale bistro. Live music nightly. Reservations are highly recommended. Dinner served Tuesday through Sunday.

CHEZ JEAN-PIERRE **561/833-1171** **132 NORTH COUNTY RD**

The rustic-classic French cuisine served an intimate ambiance has made Chez Jean-Pierre a favorite among the Palm Beach locals. Dinner served Monday-Saturday.

CHARLEY'S CRAB **561/659-1500** **456 SOUTH OCEAN BLVD**

With views of the Atlantic Ocean, this popular location offers a wide selection of fresh fish and seafood. Lunch and dinner served daily.

RENATOS **561/655-9752** **87 VIA MIZNER**

Tucked away in the delightful Via Mizner courtyard, Renato's sets a high standard in both ambience and service. Enjoy the fine continental southern Italian cuisine served in an intimate and elegant dining room. Lunch and dinner served daily.

ROCCO'S TACOS **561/650-1001** **224 CLEMATIS ST.**

Rocco's Tacos is one of the most popular restaurants in West Palm Beach. Famous for its table-side guacamole, Rocco's Tacos offers Mexican cuisine in a very lively setting, Lunch and Dinner served daily

TABOO **561/835-3500** **221 WORTH**

Taboo is one of Palm Beach's most famous dining institutions. Located in the Worth Avenue shopping district, Taboo features a Continental American menu. Lunch and dinner served daily. Brunch is served on Sunday.

FRIDAY NIGHT FEVER



DISCOTHEQUE

*Come dance the night away
with your fellow VMA members
at the 70's disco night.
Complete with DJ, dessert table,
international coffee station,
and cash bar.*

FRIDAY, OCTOBER 4

RSVP Required on Meeting Registration Form