

N E T A F I M U S A

GREENHOUSE & NURSERY PRICE LIST

EFFECTIVE OCTOBER 15, 2014

TABLE OF CONTENTS

Ordering Information	4	Polyethylene Tubing	
Terms and Conditions	5	Black Polyethylene Tubing	19
Product Warranty	7	Black Polyethylene Pre-Punch Tubing	19
Spray Stake Assemblies		UV White™ Polyethylene Tubing	19
PC Spray Stake Assemblies	9	UV White™ Polyethylene Pre-Punch Tubing	19
Spray Stakes	9	Oval Tube	19
Flex Black Polyethylene Tubing	9	Driplines	
Pre-Cut Flex Black Polyethylene Tubing	9	Space-It™ Dripline	20
Dripper and Stake Assemblies		DripNet PC Dripline	20
SlimLine EZ Close™ Weight Assemblies	10	UniRam Dripline	20
Dripper Stake Assemblies	10	Dripline and Polyethylene Fittings	
Components	10	16 mm and 18 mm Fittings and Connectors	21
Dripper Assemblies		3/4" Fittings and Connectors	21
Multi-Outlet Drinker Assemblies	11	Thinwall Dripline Fittings and Connectors	21
Multi-Outlet Drinker Assembly Components	12	Filters	
Miscellaneous Components	12	Manual Disc Filters	22
Super Flex UV White™ Polyethylene Tubing	12	Automatic Disc-Kleen Filters	22
Pre-Cut Super Flex UV White™ Polyethylene Tubing	12	Apollo Automatic Disc-Kleen Filters	23
Drippers		Scan-Kleen Screen Filters	23
WPCJ Drippers - Barbed Outlet	13	Netafim Backflush Controllers	23
WPCJ Drippers - Nipple Outlet	13	Alex-Tronix Backflush Controllers	23
WPC Drippers - Nipple Outlet	13	Pressure Regulators	24
Sprinklers		Air Vents and Water Meters	
MegaNet Rotating Impact Sprinkler	14	Air Vents	25
Vibro-Spray HF Sprinkler	14	Fertilizer Meters	25
Sprinkler Components	14	Water Meters	25
Sprinkler, Mister and Fogger Assemblies		Valves	
Ordering Guidelines	15	Series 80 Nylon Control 2-Way Valves	26
Base Assemblies	15	Series 80 2-Way Valves with Controller	26
Head Assemblies	16	Aqua Pro Controller	26
Components		Series 80 Nylon Control 3-Way Valves	27
Sprinkler, Mister and Fogger Components	17	3-Way Valves	27
Assembly Components and Accessories	18		

ORDERING INFORMATION

Netafim USA appreciates your business and we maintain a policy of continued product improvement. For any ordering or pricing questions, contact our Customer Service Representatives at:

NETAFIM USA CUSTOMER SERVICE
888-638-2346 (888-NETAFIM)
ORDERS FAX 800-695-4753 SUPPORT FAX 866-253-2550
6:00 AM - 5:00 PM PST

PRICES AND SPECIFICATIONS ARE SUBJECT TO CHANGE WITHOUT PRIOR NOTICE.

ORDERING GUIDELINES

Use the following guidelines when placing an order with Netafim USA to ensure all the necessary information is provided.

1. Company Name and Netafim Account Number
2. Name of Person Placing Order and Phone Number
3. Shipping Information
Name of Company or Individual
Address (no PO Boxes)
City, State, Zip Code
Contact Name and Phone Number (optional for parcels)
Job Name or Reference (optional)
4. Purchase Order Number
5. Requested Ship Date
If a precise date is not known, provide an approximate date. If no date is given, the order will be placed at the first available time slot in scheduling and it will ship as soon as it is complete. If you have a precise ship date, we will make every effort to target that date and time. If a specific date is given, the order will ship automatically and you will not receive a call prior to pulling/packing/loading. For truck loads, the driver will call for an appointment. Please let us know if we are required to hold the order until we are notified to ship. Any changes to the original ship date must be communicated to Netafim Customer Service 48 hours prior to shipping. NOTE: Held orders are subject to restrictions and/or may incur extra fees.
6. Ship Method
If no preferences are specified, the order will ship best method at Netafim's discretion.
7. Netafim Item or Model Number for Products Needed
Use the correct item or model number and do not use a number with a different description. Consult your price list for the appropriate number or call Customer Service for assistance.
8. Specials or Price Quotes
If any specials or price quotes apply to the order, include this information on the purchase order.
9. Ship Order Complete
Indicate if the order is to ship complete. If not indicated on the order, it will be at Netafim's discretion to ship and backorder or ship complete.
10. Combining Orders
If order is to be combined with other orders for shipping, indicate the other order numbers.

TERMS AND CONDITIONS

PRICING

All prices shown are recommended retail prices. Wholesale prices are net pricing discounted from list prices. All prices are subject to change without notice. Orders will be invoiced at the prices and discounts in effect at the time of order. Prices do not include taxes, freight, or other surcharges.

PRODUCT CLASSIFICATION

Netafim USA's Greenhouse and Nursery Price Catalog represents our most commonly ordered products as well as some reference to options, which may be available. If you have a product requirement for something you do not see listed, please call Customer Service for availability, price, and delivery times. We will make every effort to fill your order and will work with you on Special Order or Custom requests. In the case of Special Orders or Custom requests, prices and delivery will be quoted and the order will not be eligible for cancellation or return. Also, Special Orders or Custom requested products, manufactured or ordered to "non-standard" specifications, will be shipped immediately upon availability.

TERMS

All invoices are payable in United States Dollars at net thirty (30) days from the date of invoice, unless otherwise stated. All past due balances will be assessed a three quarter of one percent (0.75%) monthly finance charge. Any check or remittance received from or for the account of buyer may be accepted and applied by Netafim USA against any indebtedness owed by buyer to Netafim USA without prejudice to or the discharge of the remainder of such indebtedness of any condition, provision, statement, legend or notation appearing on or referring to or accompanying such check or remittance.

ACCOUNT STATUS

All orders are subject to credit review. Shipments may be held until account is current.

FREIGHT TERMS

F.O.B./C.I.F. shipping location. Standard shipping method is our choice of carrier, shipped prepaid and added to the customer invoice. Shipments will be made within a one hundred fifty (150) mile radius of the dealer's store.

MINIMUM ORDER

Minimum invoice order amount is one hundred (\$100). This minimum order applies to whole good orders only and not to orders for repairs. A twenty dollar (\$20) per order charge will be assessed on all whole good orders less than the one hundred (\$100) minimum.

RETURNS

No merchandise may be returned without Netafim USA's written consent and authorization. Requests to return merchandise must be made within 120 days of receipt of shipment from Netafim USA and reference the Netafim USA invoice number. Any approved return must be accompanied by a return goods authorization (RGA) issued by Netafim USA, clearly marked on the exterior of the parcel and shipped freight prepaid within 30 days of RGA issue date. All merchandise must be new, in original packaging and in salable condition. Non-standard, Custom or Special Order items are not eligible for return. All approved returns are subject to a fifteen (15%) restocking fee. Any shipment not meeting these criteria will not be accepted.

RETURN OF DEFECTIVE GOODS

Netafim USA will be responsible for the return shipping of goods that are defective upon arrival, other than goods damaged in transport by the carrier. Notice of Defect must be received by Netafim USA within fourteen (14) days of the customer's receipt of said goods. The buyer agrees that failure to give notice of defects within such time is a waiver of any defect. Prior approval from the customer's District Sales Manager and an RGA must accompany all returns. Credit will not be given until the product has been received by Netafim USA and approved for warranty.

SPECIAL ORDERS

Custom assemblies (any assembly not listed in this catalog) will be billed as parts plus labor.

TERMS AND CONDITIONS

ACCEPTANCE

The customer acknowledges responsibility for inspecting all goods shipped by Netafim USA to determine whether said goods are conforming to the customer's order, including whether all goods listed on the packing list have been shipped and whether the shipment contains any damaged goods. The customer agrees that fourteen (14) days from receipt of said shipment is a reasonable time in which to perform the inspection and notify Netafim USA of any nonconformity. If Netafim USA has not received notice of nonconformity within fourteen (14) days of the customer's receipt of the shipment, the customer agrees that the customer has accepted the goods, as that term is defined by the California Commercial Code, and the customer's right to reject the shipment will be terminated. Also, if notice of nonconformity is not received within fourteen (14) days of the customer's receipt of the shipment, Netafim USA will be relieved of any obligation concerning the shipment, other than warranty obligations, and the customer will pay for the shipment in full. The customer shall bear the complete cost of the inspection in all circumstances. The customer agrees that Netafim USA will have an opportunity to cure any nonconforming shipment. The customer further agrees that, in the event that notice of nonconformity is received by Netafim USA, the time for Netafim USA's performance under the purchase agreement will be extended for a reasonable time to allow Netafim USA to tender conforming goods.

FREIGHT POLICY

Mixed Goods: A maximum freight allowance of three percent (3%) of invoice amount, not to exceed the total freight charge, will be paid on single purchases of ten thousand dollars (\$10,000) or greater. Polyethylene tubing and Thinwall Dripline not included. The three percent (3%) freight allowance will be given on invoice. Freight allowance does not apply to Will Call orders and only shipments in the continental United States.

Thinwall Driplines: Freight will be prepaid by Netafim USA on minimum orders of four (4) pallets of any combination of Space-It or DripNet PC. Product must be purchased in pallet increments to qualify.

Polyethylene Tubing: Complete truckloads of Polyethylene tubing will be shipped freight free in California only.

FREIGHT DAMAGES

The customer acknowledges that risk of loss during transport is on the customer. Netafim USA is not liable for damage or loss occurring during shipment. Claims for such damages must be filed with the freight carrier directly.

EXPORT COMPLIANCE

These commodities, technology, or software (the "Products") when exported from the United States are subject to the Export Administration Regulations ("EAR"). Diversion contrary to U.S. law is prohibited. Purchaser hereby certifies that it understands its obligations to comply with U.S. export controls and trade sanctions including the EAR and the laws and regulations implemented by the U.S. Department of the Treasury Office of Foreign Assets Control ("OFAC"). Purchaser agrees to obtain any necessary authorization to transfer the Products outside the U.S. or to non-U.S. persons within the U.S., and will not transfer Products to any entity or country prohibited under U.S. law including countries subject to U.S. economic sanctions administered under the EAR or by OFAC or to entities prohibited for export under the EAR or the laws and regulations implemented by OFAC.

PRODUCT CHANGES

Netafim USA reserves the right to redesign, alter, or modify its products at any time, without notice. Any catalog, design manual, price sheets, and/or other written material are subject to withdrawal or change at any time without prior notice. Possession of the current catalog or price sheets does not constitute an offer to sell.

BAGGED PRODUCTS

Netafim USA has a number of products that are packaged and sold in bagged or case quantities. Bagged parts are designated by placing a "-B" at the end of the product number. The quantities have been developed to provide the best value for the most standard quantities ordered and are intended for sale in the quantities listed.

PARTIAL SHIPMENTS/COMPLETE SHIPMENTS

Netafim USA's goal is to ship customer orders complete and within the requested delivery time. Netafim USA will ship orders from any available warehouse unless otherwise specified by the customer and will "Ship and Backorder" to meet requested delivery dates unless otherwise specified by the Customer.

PRODUCT WARRANTY

NETAFIM USA'S LIMITED WARRANTY/LIMITATION OF BUYER'S REMEDIES

(A) BASIC MANUFACTURER'S LIMITED WARRANTY

Except as to products described in Subsections (B), (C), (D), (E), (F), (G) and (H) below, products sold and/or manufactured by Netafim Irrigation, Inc. (Netafim USA) are warranted to be free from original defects in material and workmanship for a period of one (1) year from the date of delivery to the buyer unless (i) otherwise specified by and subject to the terms and conditions of any Warranty Supplements pertaining to specific products or, (ii) expressly disclaimed in writing by Netafim USA. Within the warranty period, Netafim USA at its sole discretion shall have the option to repair or replace part or all of a defective product, or refund part or all of the original purchase price, if any part proves to be defective in material or workmanship after return of such product at customer's expense and after such return has been authorized in writing by Netafim USA. THIS BASIC MANUFACTURER'S LIMITED WARRANTY IS SUBJECT TO THE TERMS AND PROVISIONS IN SUBSECTION (I), (LIMITATION OF REMEDIES AND DISCLAIMER OF WARRANTIES) SET FORTH BELOW IN THE EVENT OF ANY INCONSISTENCY BETWEEN SUBSECTION (A) AND SUBSECTION (I) OF THIS PRODUCT WARRANTY, THE PROVISIONS OF SUBSECTION (I) SHALL PREVAIL.

(B) DRIPPERS

Drippers are warranted to be free from original defects in materials and workmanship for a period of five (5) years.

(C) BLANK POLYETHYLENE TUBING AND HEAVYWALL DRIPLINES

Blank polyethylene tubing and heavywall driplines are warranted to be free from original defects in materials and workmanship for a period of five (5) years and seven (7) years for environmental stress cracking. This warranty shall apply only to products with a wall thickness of 35 mil or greater.

(D) THINWALL DRIPLINES

Warranted to be free from original defects in materials and workmanship in accordance with the following schedule:
8 mil driplines - 1 year
13 mil driplines - 2 years

(E) FILTERS

Disc filters are warranted to be free from original defects in materials and workmanship for a period of five (5) years. This warranty specifically excludes gaskets, seals and o-rings, which are subject to the basic one (1) year warranty. Scan-Kleen Screen Filters are warranted for 1 year.

(F) VALVES AND WATER METERS

Valve and water meter bodies are warranted to be free from original defects in materials and workmanship for a period of five (5) years. Water meter metering components (register and metering assembly) are warranted for three (3) years. Valve diaphragms are warranted for a period of two (2) years.

(G) AIR VENTS

Nylon air vent bodies are warranted to be free from original defects in materials and workmanship for a period of five (5) years. Polypropylene air vent bodies are warranted for two (2) years. This warranty specifically excludes internal seals, gaskets or o-rings which are subject to the basic one (1) year warranty.

(H) SPRINKLERS

MegaNet and Vibro-Spray HF Sprinklers are warranted to be free from original defects in material and workmanship for a period of one (1) year.

PRODUCT WARRANTY

(I) LIMITATION OF REMEDIES AND DISCLAIMER OF WARRANTIES

EXCEPT AS EXPRESSLY PROVIDED HEREIN, ALL WARRANTIES EXPRESSED OR IMPLIED, INCLUDING ANY IMPLIED WARRANTY OF MERCHANTABILITY OR FITNESS FOR A PARTICULAR PURPOSE OR USE, ARE HEREBY EXCLUDED AND DISCLAIMED.

THE REMEDIES PROVIDED HEREIN SHALL BE THE EXCLUSIVE AND SOLE REMEDY OF THE BUYER. NO OTHER EXPRESS WARRANTY IS GIVEN AND NO AFFIRMATION BY NETAFIM USA, BY WORDS OR ACTION, WILL CONSTITUTE A WARRANTY. NO OTHER EXPRESS WARRANTY NOR ANY OTHER REMEDY SHALL BE AVAILABLE TO THE BUYER AND NETAFIM USA SHALL NOT BE RESPONSIBLE OR LIABLE FOR ANY DAMAGES, INCLUDING ANY LOSS OF PROFIT, LOST SAVINGS, LOSS OF SALES, OR OTHER DIRECT, INDIRECT, INCIDENTAL, SPECIAL OR CONSEQUENTIAL DAMAGES, INJURY OR DAMAGES TO ANY PERSON OR PROPERTY ARISING OUT OF THE USE OR INABILITY TO USE THE PRODUCTS OR THE BREACH OF ANY EXPRESS WARRANTY, EVEN IF NETAFIM USA HAS BEEN ADVISED OF THE POSSIBILITY OF THOSE DAMAGES OR CLAIMS. NETAFIM USA SHALL NOT BE RESPONSIBLE FOR THE AFORESAID DAMAGES, CLAIMS OR LOSSES DUE TO LATE DELIVERY OR DELIVERY OR NON-DELIVER, OR OTHERWISE. THERE ARE NO WARRANTIES WHICH EXTEND BEYOND THE DESCRIPTION AS SET FORTH HEREIN. IF NETAFIM USA SHALL FURNISH TECHNICAL ADVICE OR ASSISTANCE WITH RESPECT TO THE PRODUCTS SOLD HEREUNDER, IT SHALL BE GIVEN WITHOUT CHARGE TO BUYER AND SHALL BE GIVEN AND ACCEPTED AT BUYER'S SOLE RISK WITHOUT ANY EXPRESS OR IMPLIED WARRANTY AND NETAFIM USA SHALL NOT BE RESPONSIBLE OR LIABLE FOR THE ADVICE OR THE RESULTS THEREOF BUYER ASSUMES ALL RISK AND LIABILITY RESULTING FROM USE OF THE PRODUCT PURCHASED.

This warranty is expressly conditioned upon proper storage, installation, application and normal greenhouse or nursery use and service as recommended by Netafim USA. Such recommendations may be updated from time to time. Any misuse, neglect, modifications, unauthorized repairs or replacement or uses of the product and/or any of its components for non-greenhouse or nursery purposes not recommended by Netafim USA, including but not limited to the following, shall completely void this warranty:

- (I) Irrigation water which has not been filtered or treated to the levels specified for individual components of the product by Netafim.
- (II) Chemical concentrates, used or applied internally or externally to the product, or mechanical abuse which is harmful to the product or its components.
- (III) Operating pressures greater than those specified by Netafim's individual component specifications.
- (IV) Damage or plugging caused by insects, rodents, other animals, improper installation or other mechanical damage.

THE EXPRESS WARRANTY PROVIDED HEREIN IS EFFECTIVE ONLY IF CLAIM IS MADE BY WRITTEN NOTICE WITHIN THE APPLICABLE WARRANTY PERIOD AND POSTMARKED WITHIN THIRTY (30) DAYS AFTER DISCOVERY OF THE DEFECT ON WHICH THE CLAIM IS BASED. SUCH NOTICE SHALL BE DELIVERED TO NETAFIM USA AT THE FOLLOWING ADDRESS:

**NETAFIM USA
5470 EAST HOME AVENUE
FRESNO, CALIFORNIA 93727
ATTN: PRODUCT MANAGEMENT**

The buyer shall, together with its notice of claim, offer Netafim USA in writing prompt opportunity to examine the defective product and correct the defect, if possible. This warranty shall be void unless buyer delivers the defective product to Netafim USA at buyer's sole cost and in accordance with Netafim USA's instructions.

SPRAY STAKE ASSEMBLIES

PC SPRAY STAKE ASSEMBLIES

Pressure Compensating - Standard with Flex PE Tubing

For complete assembly: Order one (A) Drinker Assembly and one (B) PC Spray Stake

Item Number	Model Number	Stake	Pattern	Tube Length	Pack Qty	Price Pack	Price Each
3.2 GPH PLUM STAKE							
A 40201-002020	01PSD032-36B	-	-	36"	25	20.25	0.81
A 40201-024700	01PSD032-48B	-	-	48"	25	21.75	0.87
B 22500-002030	01PSDS-PL1-B	Standard	Single	-	50	15.50	0.31
B 22500-005030	01PSDSR-PL1-B	Rod Mount	Single	-	50	15.50	0.31
6.6 GPH GREY STAKE							
A 40201-002320	01PSD066-36B	-	-	36"	25	20.25	0.81
A 40201-024800	01PSD066-48B	-	-	48"	25	21.75	0.87
B 22500-002130	01PSDS-GY1-B	Standard	Single	-	50	15.50	0.31
B 22500-002230	01PSDS-GY2-B	Standard	Double	-	50	15.50	0.31
B 22500-005180	01PSDSR-GY1-B	Rod Mount	Single	-	50	15.50	0.31
B 22500-005330	01PSDSR-GY2-B	Rod Mount	Double	-	50	15.50	0.31
7.9 GPH BROWN STAKE							
A 40201-024950	01PSD079-36B	-	-	36"	25	20.25	0.81
A 40201-024960	01PSD079-48B	-	-	48"	25	21.75	0.87
B 22500-002740	01PSDS-BR1-B	Standard	Single	-	50	15.50	0.31
B 22500-003100	01PSDS-BR2-B	Standard	Double	-	50	15.50	0.31
B 22500-005530	01PSDSR-BR1-B	Rod Mount	Single	-	50	15.50	0.31
B 22500-005730	01PSDSR-BR2-B	Rod Mount	Double	-	50	15.50	0.31
10.6 GPH BLUE STAKE							
A 40201-024910	01PSD106-36B	-	-	36"	25	20.25	0.81
A 40201-024900	01PSD106-48B	-	-	48"	25	21.75	0.87
B 22500-002420	01PSDS-BL1-B	Standard	Single	-	50	15.50	0.31
B 22500-002670	01PSDS-BL2-B	Standard	Double	-	50	15.50	0.31
B 22500-005880	01PSDSR-BL1-B	Rod Mount	Single	-	50	15.50	0.31
B 22500-006030	01PSDSR-BL2-B	Rod Mount	Double	-	50	15.50	0.31

Minimum operating pressure - 22 psi

NOTE: Sold in Pack Quantities ONLY.

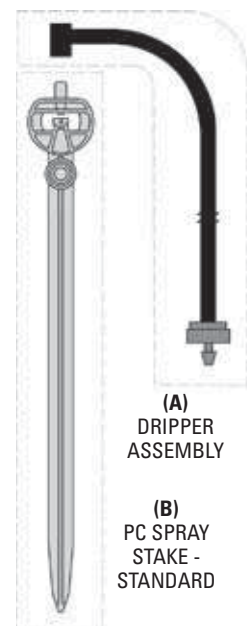

(A)
DRIPPER
ASSEMBLY

(B)
PC SPRAY
STAKE -
STANDARD



(B)
PC SPRAY
STAKE - ROD
MOUNT

SPRAY STAKES

Non-Pressure Compensating

Item Number	Model Number	Description	Bag Qty	Price Bag	Price Each
22500-001030	01SSYL-B	Yellow Stake 3.0 GPH	100	21.00	0.21
22500-001120	01SSGN-B	Green Stake 5.0 GPH	100	21.00	0.21
22500-001220	01SSBK-B	Black Stake 7.0 GPH	100	21.00	0.21

NOTE: Sold in Bag Quantities ONLY.



FLEX BLACK POLYETHYLENE (PE) TUBING (5/3 mm)

Item Number	Model Number	Description	Coil Length	Price Coil (ea)	Price Per 1,000'
40001-002000	15FPE53	Flex Black PE Tubing 5/3 mm	3,000'	182.82	60.94
40001-001980	15FPE53-1000	Flex Black PE Tubing 5/3 mm	1,000'	60.94	60.94

PRE-CUT FLEX BLACK POLYETHYLENE (PE) TUBING (5/3 mm)

Item Number	Model Number	Length	Pack Qty	Price Pack	Price Each
40001-001300	15FPE53-36	36"	100	37.00	0.37
40001-001400	15FPE53-48	48"	100	49.00	0.49

NOTE: Sold in Pack Quantities ONLY.

DRIPPER AND STAKE ASSEMBLIES

WPCJ DRIPPER
.5 GPH
01WPCJL2-B OR
21520-001040



**SUPER FLEX UV
WHITE PE TUBE**
15FPEW53-XX

**SLIMLINE EZ
CLOSE WEIGHT**
1107008SC-B OR
00130-000033

SLIMLINE EZ CLOSE™ WEIGHT ASSEMBLIES (0.5 GPH)

Pressure Compensating with Check Valve and Shut-Off Feature
Standard with Super Flex UV White PE Tubing

Item Number	Model Number	Tube Length	Pack Qty	Price Pack	Price Each
40201-015402	01HBA2W-18	18"	25	24.75	0.99
40201-015403	01HBA2W-24	24"	25	26.50	1.06
40201-015405	01HBA2W-36	36"	25	28.50	1.14
40201-015406	01HBA2W-48*	48"	25	37.00	1.48

*All tube lengths greater than 36" are assembled with a WPC5 dripper. 1.0 and 2.0 GPH also available.

NOTE: Sold in Pack Quantities ONLY.

WPCJ DRIPPER
.5 GPH
01WPCJL2-B OR
21520-001040

**SUPER FLEX UV
WHITE PE TUBE**
15FPEW53-XX



ANGLE BARBED STAKE
1101001-B OR
32000-001806

DRIPPER STAKE ASSEMBLIES (0.5 GPH)

Pressure Compensating with CNL Check Valve Feature
Standard with Super Flex UV White PE Tubing

Item Number	Model Number	Tube Length	Pack Qty	Price Pack	Price Each
40201-020600	01WPCJL2AW-24	24"	25	21.75	0.87
40201-020700	01WPCJL2AW-30	30"	25	22.75	0.91
40201-021000	01WPCJL2AW-36	36"	25	23.75	0.95

1.0 and 2.0 GPH assemblies also available.

NOTE: Sold in Pack Quantities ONLY.



①



②



③



④



⑤



⑥



⑦

DRIPPER AND SPRAY STAKE ASSEMBLY COMPONENTS

Key	Item Number	Model Number	Description	Bag Qty	Price Bag	Price Each
1	32500-001125	1109006-B	5 mm Insert Connector - Barb x Threaded	250	42.50	0.17
2	32000-002525	11002520-B	5 mm Elbow	50	7.50	0.15
3	32000-002030	11WPCON-B	3 mm Flex Tube Adapter (for nipple outlet drippers)	250	32.50	0.13
4	32000-001806	1101001-B	Angle Barbed Stake	250	42.50	0.17
5	32000-002220	1107008C-B	Red Plastic Weight with Shut-off Feature	25	13.00	0.52
6	32500-001335	11090552-B	5 mm Tee Barb x Threaded x Threaded	250	55.00	0.22
7	00130-000033	1107008SC-B	Slimline EZ Close White Weight	25	12.25	0.49
-	00130-000031	01PSDROD-8	8", 12 Gauge Metal Rod for PC Rod Mount Stake	25	4.00	0.16
-	00130-000032	01PSDROD-12	12", 12 Gauge Metal Rod for PC Rod Mount Stake	25	4.50	0.18

NOTE: Sold in Bag Quantities ONLY.

DRIPPER ASSEMBLIES

MULTI-OUTLET DRIPPER ASSEMBLIES

For a complete assembly, order one **A** Manifold Assembly and one **B** Woodpecker Pressure Compensating Junior Dripper.

The flow per arrow dripper is equal to the dripper flow divided by the number of arrow drippers on that assembly. To ensure plants will receive equal water flow, use the same assemblies on each zone.

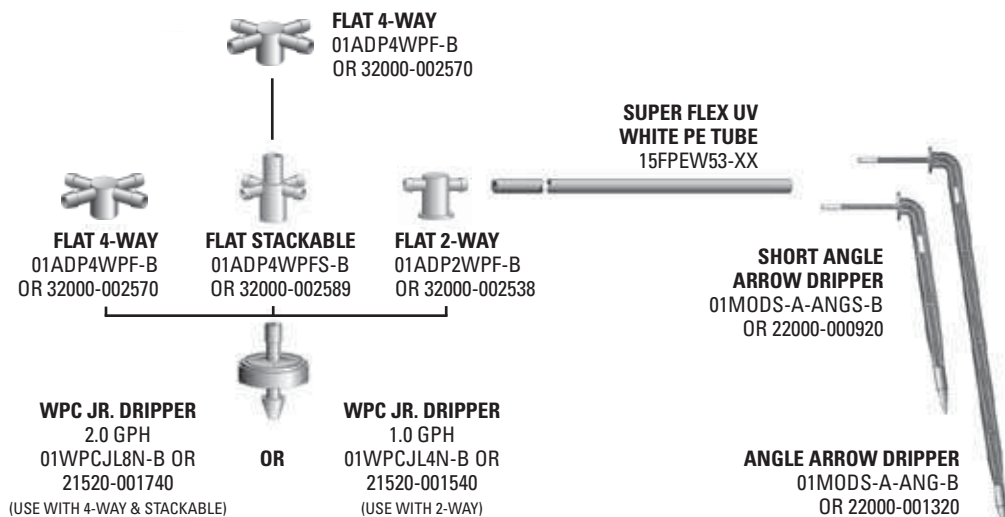

FLAT 4-WAY MULTI-OUTLET DRIPPER ASSEMBLIES

Standard with Super Flex UV White PE Tubing

Item Number	Model Number	Arrow Dripper	Tube Lengths	Pack Qty	Price Pack	Price Each
40201-002550	014DM-1818F	Standard	(4) at 18"	25	58.00	2.32
40201-002600	014DM-1818FS	Short	(4) at 18"	25	51.50	2.06
40201-003200	014DM-1830F	Standard	(2) at 18" & (2) at 30"	25	64.25	2.57
A 40201-003300	014DM-1830FS	Short	(2) at 18" & (2) at 30"	25	58.00	2.32
40201-003600	014DM-2424F	Standard	(4) at 24"	25	64.00	2.56
40201-003800	014DM-2424FS	Short	(4) at 24"	25	58.00	2.32
40201-003900	014DM-2436F	Standard	(2) at 24" & (2) at 36"	25	67.75	2.71
40201-004400	014DM-3030F	Standard	(4) at 30"	25	68.25	2.73
B 21520-001740	01WPCJL8N-B	WPC Jr. Dripper 2.0 GPH		250	90.13	-

NOTE: Sold in Pack Quantities ONLY.



FLAT STACKABLE MULTI-OUTLET DRIPPER ASSEMBLIES

Standard with Super Flex UV White PE Tubing

Item Number	Model Number	Arrow Dripper	Tube Lengths	Pack Qty	Price Pack	Price Each
40201-007500	014DMS-1818F	Standard	(4) at 18"	25	58.00	2.32
40201-008000	014DMS-2424F	Standard	(4) at 24"	25	64.00	2.56
A 40201-008200	014DMS-2436F	Standard	(2) at 24" & (2) at 36"	25	67.75	2.71
40201-008400	014DMS-3030F	Standard	(4) at 30"	25	68.25	2.73
B 21520-001740	01WPCJL8N-B	WPC Jr. Dripper 2.0 GPH		250	90.13	-

NOTE: Sold in Pack Quantities ONLY.



FLAT 2-WAY MULTI-OUTLET DRIPPER ASSEMBLIES

Standard with Super Flex UV White PE Tubing

Item Number	Model Number	Arrow Dripper	Tube Lengths	Pack Qty	Price Pack	Price Each
A 40201-001500	012DM-2424F	Standard	(2) at 24"	25	36.00	1.44
40201-001700	012DM-3030F	Standard	(2) at 30"	25	38.25	1.53
B 21520-001540	01WPCJL4N-B	WPC Jr. Dripper 1.0 GPH		250	90.13	-

NOTE: Sold in Pack Quantities ONLY.

COMPONENTS

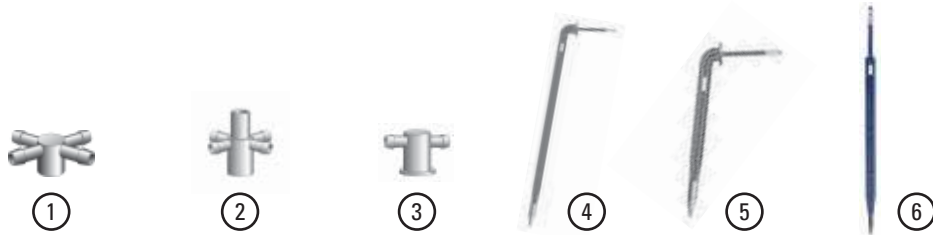

MULTI-OUTLET DRIPPER ASSEMBLY COMPONENTS

Key	Item Number	Model Number	Description	Bag Qty	Price Bag	Price Each
1	32000-002570	01ADP4WPF-B	Flat 4-Way Manifold	100	20.00	0.20
2	32000-002589	01ADP4WPFS-B	Flat 4-Way Stackable Manifold	100	20.00	0.20
3	32000-002538	01ADP2WPF-B	Flat 2-Way Manifold	100	24.00	0.24
4	22000-001320	01MODS-A-ANG-B	Angle Arrow Dripper (6 3/8" length)	100	24.00	0.24
5	22000-000920	01MODS-A-ANGS-B	Short Angle Arrow Dripper (3 3/4" length)	100	19.00	0.19
6	22000-001120	01MODS-ST-BK-B	Straight Arrow Dripper	100	24.00	0.24

NOTE: Sold in Bag Quantities ONLY.

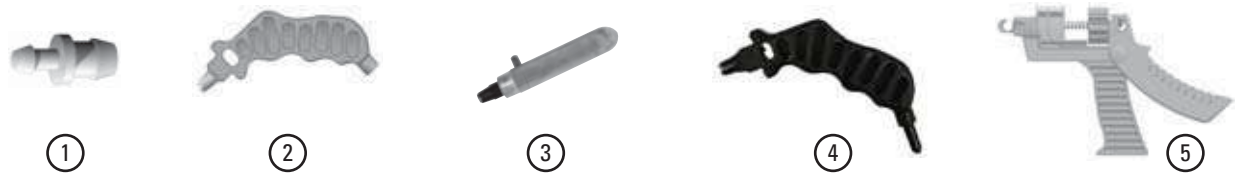

MISCELLANEOUS COMPONENTS

Key	Item Number	Model Number	Description	Bag Qty	Price Bag	Price Each
1	32000-001010	1107737-B	Goof Plug	10	1.70	0.17
2	45000-001200	682901033	3 mm Plastic Punch (for drippers/sprinklers)	1	20.00	20.00
3	45000-001400	6804080	8 mm Metal Punch	1	45.00	45.00
4	45000-001450	PPUNCH8	8 mm Plastic Punch	1	42.00	42.00
5	45000-002270	45000-002270	Hanging Sprinkler Assy Tool for tubes over 48"	1	72.00	72.00

NOTE: Sold in Bag Quantities ONLY.

SUPER FLEX UV WHITE™ POLYETHYLENE (PE) TUBING (5/3 mm)

Item Number	Model Number	Description	Coil Length	Price Coil (ea)	Price Per 1,000'
40001-002500	15FPEW53	Super Flex UV White PE Tubing 5/3 mm	1,000'	67.17	67.17

PRE-CUT SUPER FLEX UV WHITE™ POLYETHYLENE (PE) TUBING (5/3 mm)

Item Number	Model Number	Length	Pack Qty	Price Pack	Price Each
40001-002800	15FPEW53-18	18"	100	21.00	0.21
40001-002900	15FPEW53-24	24"	100	25.00	0.25
40001-003100	15FPEW53-30	30"	100	32.00	0.32
40001-003200	15FPEW53-36	36"	100	37.00	0.37

NOTE: Sold in Pack Quantities ONLY.



DRIPPERS



WOODPECKER PRESSURE COMPENSATING JUNIOR DRIPPERS (WPCJ)

With CNL Check Valve Feature and Barbed Outlet

Minimum Operating Pressure 10 psi

Used with SlimLine EZ Close™ Weight, Dripper Stake and PC Spray Stake Assemblies

Item Number	Model Number	Color-Coded Inlet/Outlet	Nominal Flow (GPH)	Carton Quantity	Bag Quantity	Price Per Carton or Bag	Price Per 1,000
21520-000950	01WPCJL1.2	Brown	0.26	13,000	-	4,109.30	316.10
21520-000930	01WPCJL1.2-B			-	250	90.13	360.50
21520-001051	01WPCJL2	Red	0.5	13,000	-	4,109.30	316.10
21520-001040	01WPCJL2-B			-	250	90.13	360.50
21520-001250	01WPCJL3	Blue	0.7	13,000	-	4,109.30	316.10
21520-001230	01WPCJL3-B			-	250	90.13	360.50
21520-001460	01WPCJL4	Grey	1.0	13,000	-	4,109.30	316.10
21520-001440	01WPCJL4-B			-	250	90.13	360.50
21520-001660	01WPCJL8	Green	2.0	13,000	-	4,109.30	316.10
21520-001640	01WPCJL8-B			-	250	90.13	360.50
21520-001698	01WPCJL12	Plum/Black	3.2	13,000	-	4,109.30	316.10
21520-001690	01WPCJL12-B			-	250	90.13	360.50
21630-001540	01WPCJL25	Orange/Grey	6.6	13,000	-	4,109.30	316.10
21630-001530	01WPCJL25-B			-	250	90.13	360.50
21630-001740	01WPCJL30	Orange/Brown	7.9	13,000	-	4,109.30	316.10
21630-001730	01WPCJL30-B			-	250	90.13	360.50
21630-002140	01WPCJL40	Orange/Blue	10.6	13,000	-	4,109.30	316.10
21630-002135	01WPCJL40-B			-	250	90.13	360.50

NOTE: Drippers Sold in Bag or Carton Quantities ONLY.



WOODPECKER PRESSURE COMPENSATING JUNIOR DRIPPERS (WPCJ)

With CNL Check Valve Feature and Nipple Outlet

Minimum Operating Pressure 10 psi

Used with Multi-Outlet Drinker Assemblies

Item Number	Model Number	Color-Coded Inlet	Nominal Flow (GPH)	Carton Quantity	Bag Quantity	Price Per Carton or Bag	Price Per 1,000
21520-001560	01WPCJL4N	Grey	1.0	12,000	-	3,793.20	316.10
21520-001540	01WPCJL4N-B			-	250	90.13	360.50
21520-001760	01WPCJL8N	Green	2.0	12,000	-	3,793.20	316.10
21520-001740	01WPCJL8N-B			-	250	90.13	360.50

NOTE: Drippers Sold in Bag or Carton Quantities ONLY.



WOODPECKER PRESSURE COMPENSATING DRIPPERS (WPC)

With CNL Check Valve Feature and Nipple Outlet

Minimum Operating Pressure 10 psi

Used with SlimLine EZ Close™ Weight Assemblies longer than 36"

Item Number	Model Number	Nominal Flow (GPH)	Bag Quantity	Price Per Bag	Price Per 1,000
21020-001333	WPC5-250	0.5	250	122.50	490.00

NOTE: Drippers Sold in Bag Quantities ONLY.

NOTES:

The nominal flow rate in liters per hour is indicated on the cap: 1, 2, 3, 4, and 8.

The barbed outlet fits Super Flex UV White PE Tubing, 15FPEW53 or Super Flex Black PE Tubing, 15FPE53.

SPRINKLERS

MEGANET ROTATING IMPACT SPRINKLER

1/2" Male Threaded Connection - Nominal Flow Rate at 33 psi

Item Number	Model Number	Description	Nominal Flow Rate	Trajectory	Price Each
63600-001700	MGN24D-088HO	Sprinkler Head Only - Yellow Nozzle	0.88 GPM		7.10
63600-001750	MGN24D-110HO	Sprinkler Head Only - Purple Nozzle	1.10 GPM		7.10
63600-001000	MGN24D-154HO	Sprinkler Head Only - Green Nozzle	1.54 GPM		7.10
63600-002000	MGN24D-198HO	Sprinkler Head Only - Blue Nozzle	1.98 GPM	High	7.10
63600-003000	MGN24D-242HO	Sprinkler Head Only - Brown Nozzle	2.42 GPM	24°	7.10
63600-004000	MGN24D-286HO	Sprinkler Head Only - Orange Nozzle	2.86 GPM		7.10
63600-004500	MGN24D-330HO	Sprinkler Head Only - Red Nozzle	3.30 GPM		7.10
63600-004900	MGN15D-088HO	Sprinkler Head Only - Yellow Nozzle	0.88 GPM		7.10
63600-004950	MGN15D-110HO	Sprinkler Head Only - Purple Nozzle	1.10 GPM		7.10
63600-005000	MGN15D-154HO	Sprinkler Head Only - Green Nozzle	1.54 GPM	Low	7.10
63600-006000	MGN15D-198HO	Sprinkler Head Only - Blue Nozzle	1.98 GPM	15°	7.10
63600-007000	MGN15D-242HO	Sprinkler Head Only - Brown Nozzle	2.42 GPM		7.10
63600-008000	MGN15D-286HO	Sprinkler Head Only - Orange Nozzle	2.86 GPM		7.10



VIBRO-SPRAY HIGH FLOW (HF) SPRINKLER

1/2" Female Threaded Connection. Nominal Flow 1 GPM at 30 psi.

Item Number	Model Number	Description	Bag Qty	Price Bag	Price Each
60500-024470	0302210-B	Vibro-Spray HF Sprinkler	25	70.00	2.80
63000-002360	032066208-B	1/2" Male Adapter x Male Micronet - Adapts to Hanging Sprinkler Assembly	25	39.25	1.57

NOTE: Sold in Bag Quantities ONLY.



VIBRO-SPRAY HF SPRINKLER



1/2" MALE ADAPTER



SPRINKLER STAND
FEMALE X BARB
CONNECTOR,
TUBING, 1/2" FIPT,
STAKE ADAPTER



MEGANET
ROAD GUARD

SPRINKLER COMPONENTS

Item Number	Model Number	Description	Bag Qty	Price Bag	Price Each
64520-002305	03N20STAND0948-B	Sprinkler Stand (connects to PE Lateral) includes: connector, 48" 9mm I.D. tubing, PE barb, 1/2" FIPT, 8mm stake adapter (no stake)	25	123.25	4.93
64520-002280	03N20STAND0948NODP	Sprinkler Stand (above) without Stake Adapter	1	4.60	4.60
65080-002610	03N265080002610	Female x Barb Connector for Sprinkler Stand	1	0.40	0.40
65080-002880	SSP	Sprinkler Stand Plug	1	0.41	0.41
63620-004400	MGNFIL	MegaNet Filter	1	0.39	0.39
63620-007000	MGNRG	MegaNet Road Guard	1	0.78	0.78
45000-001450	PPUNCH8	8mm Plastic Punch	1	42.00	42.00
45000-001400	6804080	8mm Metal Punch	1	45.00	45.00
65080-001220	03175648	6mm Steel Stake, 48" length	1	2.80	2.80

NOTE: Sold in Bag Quantities ONLY.

SPRINKLER, MISTER AND FOGGER ASSEMBLIES

ORDERING GUIDELINES

Ordering Netafim sprinkler, mister and fogger assemblies is a simple two step process:

1. Select a Sprinkler, Mister or Fogger head based on application:
 - Watering: Sprinkler
 - Germinating: Mister
 - Humidifying or Cooling: Fogger
2. Select a Base Assembly based on the type of pipe used to supply water:
 - Polyethylene
 - Threaded pipe
 - Retrofit adapter for other manufacturer's fittings

The assembly is shipped as two parts (Head Assembly and Base Assembly) to be connected by the installer in the greenhouse.

Sprinklers/Misters: Use a 35 psi regulator and 120 mesh filter.
Foggers: Use a 65 psi regulator and a 140 mesh filter.

EXAMPLE OF INSTALLED FINAL ASSEMBLY

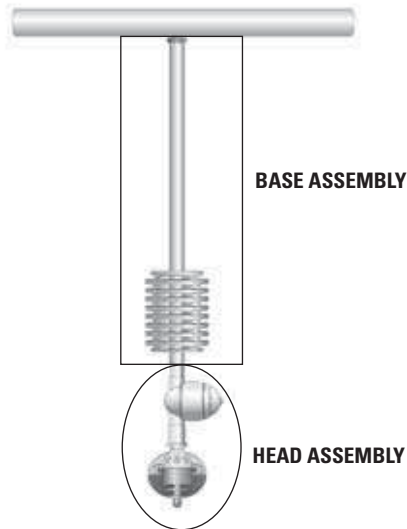

BASE ASSEMBLIES

BARB X BARB CONNECTOR
 031748W-B OR
 63000-001355

**SUPER FLEX UV WHITE PE
 (4/7 MM) TUBING**

STABILIZER WEIGHT
 03330C-B OR
 63000-002915

BARB X FEMALE CONNECTOR
 03220W-B OR
 63000-001953



HANGING ASSEMBLY FOR SPRINKLERS, MISTERS OR FOGGERS

For Connection to Polyethylene (PE) Pipe

Item Number	Model Number	Tube Length	Pack Qty	Price Pack	Price Each
63000-004070	0300HSAC-12-B	12"	25	44.75	1.79
63000-004460	0300HSAC-18-B	18"	25	47.00	1.88
63000-005870	0300HSAC-24-B	24"	25	49.00	1.96
63000-006460	0300HSAC-30-B	30"	25	50.50	2.02
63000-007170	0300HSAC-36-B	36"	25	52.75	2.11
63000-008361	0300HSAC-48-B	48"	25	56.75	2.27
63000-008461	0300HSAC-48X-B	Extension*	25	30.75	1.23

Item Number	Model Number	Tube Length	Carton Qty	Price Pack	Price Each
63000-004060	0300HSAC-12	12"	200	305.91	1.53
63000-004450	0300HSAC-18	18"	200	321.36	1.61
63000-005860	0300HSAC-24	24"	200	333.72	1.67
63000-006450	0300HSAC-30	30"	150	261.62	1.74
63000-007160	0300HSAC-36	36"	150	277.07	1.85
63000-008350	0300HSAC-48	48"	150	301.79	2.01
63000-008450	0300HSAC-48X	Extension*	500	472.77	0.95

NOTE: Sold in Pack or Carton Quantities ONLY.
 *For Creating Tube Lengths over 48".

1/2" ADAPTER

For Pipe Thread

Item Number	Model Number	Bag Qty	Price Bag	Price Each
63000-001210	03206-B	25	31.75	1.27

RETROFIT ADAPTER

Connect Netafim head assemblies to other manufacturer's fittings

Item Number	Model Number	Bag Qty	Price Bag	Price Each
63000-002505	03302-B	25	11.50	0.46

SPRINKLER, MISTER AND FOGGER ASSEMBLIES

HEAD ASSEMBLIES

SPINNET SPRINKLER

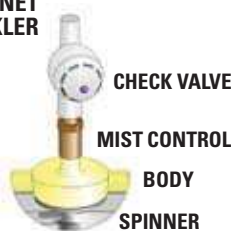

VIBRONET SPRINKLER

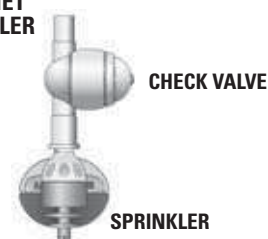

SPRINKLER HEAD ASSEMBLIES (WATERING)

Code	Item Number	Model Number	Description	Flow (GPH)	Bag Qty	Price Bag	Price Each
VN-BL	64300-001080	0354040L-B	VibroNet Blue Sprinkler	9.2	25	82.25	3.29
VN-GN	64300-005110	0354050L-B	VibroNet Green Sprinkler	11.7	25	82.25	3.29
R-R-BL	64200-032030	0355120070BL-B	SpinNet Red Mist, Red Body, Blue Spinner	18.4	25	82.25	3.29
BR-BR-BL	64200-033030	0355160090BL-B	SpinNet Brown Mist, Brown Body, Blue Spinner	23.4	25	82.25	3.29
R-R-GY	64200-001302	03551200070L-B	SpinNet Red Mist, Red Body, Grey Spinner	18.4	25	82.25	3.29
BR-Y-GY	64200-001805	03552000090L-B	SpinNet Brown Mist, Yellow Body, Grey Spinner	23.4	25	82.25	3.29
R-R-GN	64200-010805	03551200070GL-B	SpinNet Red Mist, Red Body, Green Spinner	18.4	25	82.25	3.29
BR-BR-GN	64200-014005	03551600090GL-B	SpinNet Brown Mist, Brown Body, Green Spinner	23.4	25	82.25	3.29

NOTE: All Head Assemblies are standard with Check Valve. Average flow at 32 psi.

NOTE: Sold in Bag Quantities ONLY.

SINGLE BENCH WITH VIBRONET SPRINKLERS



Bench Width	Spacing Between Sprinklers	Height Above Crop 2' - 3'	Height Above Crop 3' - 5'
4 ft.	3 ft.	VN-BL or VN-GN	VN-BL or VN-GN
5 ft.	3 ft.	VN-BL or VN-GN	VN-BL or VN-GN
6 ft.	3 ft.	VN-BL or VN-GN	VN-BL or VN-GN

ONE LINE FOR SINGLE BAY OR QUONSET WITH SPINNET SPRINKLERS



Bay Width	Spacing Between Sprinklers	Height Above Crop 2' - 3'	Height Above Crop 4' - 5'	Height Above Crop 6' - 7'
10 ft.	3 ft.	R-R-BL	-	-
12 ft.	3 ft.	R-R-BL	R-R-BL	-
14 ft.	3 ft.	BR-BR-BL	BR-BR-BL	R-R-BL
15 ft.	3 ft.	R-R-GY	BR-BR-BL	R-R-BL
16 ft.	3 ft.	R-R-GY	BR-Y-GY	R-R-BL
18 ft.	3 ft.	R-R-GN	BR-Y-GY	BR-Y-GY
20 ft.	3 ft.	-	R-R-GN	BR-BR-GN
22 ft.	3 ft.	-	R-R-GN	BR-BR-GN
24 ft.	3 ft.	-	-	BR-BR-GN

TWO LINE FOR SINGLE BAY OR QUONSET WITH SPINNET SPRINKLERS



Bay Width	Spacing Between Sprinklers	Spacing Between Sprinkler Lines	Height Above Crop 3'	Height Above Crop 4' - 5'	Height Above Crop 6' - 7'
20 ft.	3 ft.	11 ft.	R-R-BL	-	-
22 ft.	3 ft.	12 ft.	R-R-BL	R-R-BL	-
24 ft.	3 ft.	12 ft.	R-R-BL	R-R-BL	R-R-BL
26 ft.	3 ft.	14 ft.	BR-BR-BL	R-R-BL	R-R-BL
28 ft.	3 ft.	15 ft.	BR-BR-BL	R-R-BL	R-R-BL
30 ft.	3 ft.	16 ft.	R-R-GY	R-R-GY	BR-BR-BL
32 ft.	3 ft.	17 ft.	R-R-GN	R-R-GY	BR-BR-BL
34 ft.	3 ft.	18 ft.	R-R-GN	R-R-GY	BR-BR-BL
36 ft.	3 ft.	19 ft.	R-R-GN	R-R-GY	R-R-GN
38 ft.	3 ft.	20 ft.	BR-BR-GN	R-R-GN	R-R-GN

SPRINKLER, MISTER AND FOGGER ASSEMBLIES

MISTING HEAD ASSEMBLIES (GERMINATING)

Item Number	Model Number	Description	Bag Qty	Price Bag	Price Each
64300-001080	0354040L-B	VibroNet Mister, 9.2 GPH at 32 psi Blue nozzle w/Check Valve	25	82.25	3.29

NOTE: Sold in Bag Quantities ONLY.

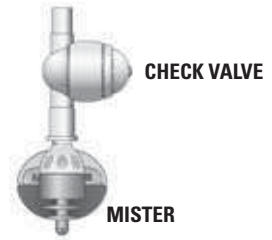

COOLNET PRO FOGGER HEAD ASSEMBLIES (HUMIDIFYING OR COOLING)

Item Number	Model Number	Description	Bag Qty	Price Bag	Price Each
63100-058397	0303420LL-B	CoolNet Pro Fogger, 4 Nozzles w/Check Valve Purple Pin, 8.1 GPH @ 60 psi (opening pressure 28 psi)	25	156.75	6.27
63100-058502	0303420HL-B	CoolNet Pro Fogger, 4 Nozzles w/Check Valve Orange Pin, 8.1 GPH @ 60 psi (opening pressure 58 psi)	25	156.75	6.27

NOTE: Sold in Bag Quantities ONLY.

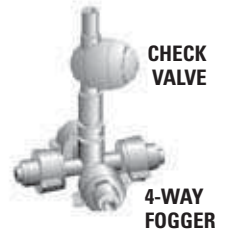

COMPONENTS



①



②



③



④



⑤

SPRINKLER, MISTER AND FOGGER COMPONENTS

Key	Item Number	Model Number	Description	Bag Qty	Price Bag	Price Each
1	64300-001010	0354040-B	VibroNet Sprinkler/Mister Blue - 9.2 GPH at 32 psi	25	37.25	1.49
	64300-005010	0354050-B	VibroNet Sprinkler Green - 11.7 GPH at 32 psi	25	37.25	1.49
	64300-000955	0354025-B	VibroNet Mister Brown - 5.3 GPH at 30 psi	25	40.75	1.63
2	63000-002987	0340020-B	Check Valve, Blue Pin (opens 22 psi, closes 10 psi)	25	41.75	1.67
	63000-003005	0340017-B	Check Valve, Purple Pin (opens 28 psi, closes 13 psi)	25	41.75	1.67
	63000-003205	0340037-B	Check Valve, Orange Pin (opens 58 psi, closes 26 psi)	25	41.75	1.67
3	64200-032010	0355120070B-B	SpinNet Assy, Red Mist, Red Body, Blue Spinner	25	37.25	1.49
	64200-033010	0355160090B-B	SpinNet Assy, Brown Mist, Brown Body, Blue Spinner	25	37.25	1.49
	64200-001255	03551200070-B	SpinNet Assy, Red Mist, Red Body, Grey Spinner	25	37.25	1.49
	64200-001785	03552000090-B	SpinNet Assy, Brown Mist, Yellow Body, Grey Spinner	25	37.25	1.49
	64200-010760	03551200070G-B	SpinNet Assy, Red Mist, Red Body, Green Spinner	25	37.25	1.49
	64200-013960	03551600090G-B	SpinNet Assy, Brown Mist, Brown Body, Green Spinner	25	37.25	1.49
4	63100-058305	0303420-B	CoolNet Pro Fogger 4 nozzles - 8.1 GPH at 60 psi	25	116.75	4.67
5	63120-001805	0306600-B	CoolNet Pro Fogger Blocker for 1 nozzle	25	5.75	0.23

NOTE: Sold in Bag Quantities ONLY.

COMPONENTS

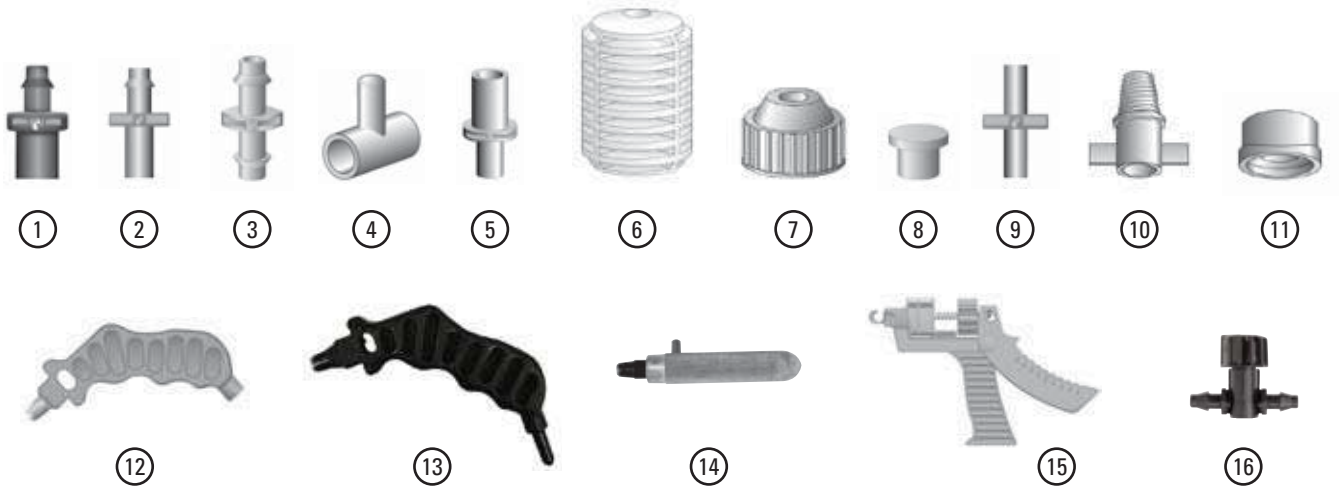

ASSEMBLY COMPONENTS AND ACCESSORIES

Key	Item Number	Model Number	Description	Bag Qty	Price Bag	Price Each
1	63000-001953	03220W-B	Barb x Female Connector - White	25	5.00	0.20
2	63000-002073	03221W-B	Barb x Male Connector - White	25	5.00	0.20
3	63000-001355	031748W-B	Barb x Barb Connector	25	5.00	0.20
4	63000-002505	03302-B	Retrofit Adapter - Female (adapts Netafim to other mfgr fittings)	25	11.50	0.46
5	63000-002610	03303-B	Retrofit Adapter - Male (adapts other mfgr sprinklers to Netafim)	25	4.25	0.17
6	63000-002915	03330C-B	White Stabilizer Weight	25	13.25	0.53
7	63000-001210	03206-B	1/2" Adapter for Pipe Thread	25	31.75	1.27
8	63000-002420	03301-B	Plug (replaces sprinkler or mister head)	100	28.00	0.28
9	63000-001420	03208W-B	Male x Male Connector - White	100	20.00	0.20
10	63000-002103	03228-B	Threaded 3/8" Connector x Female PVC Adapter	25	12.75	0.51
11	78241-002820	58-AI-B	Grommet	25	18.50	0.74
12	45000-001200	682901033	3 mm Plastic Punch (for drippers and sprinklers)	1	20.00	20.00
13	45000-001450	PPUNCH8	8 mm Plastic Punch	1	42.00	42.00
14	45000-001400	6804080	8 mm Metal Punch	1	45.00	45.00
15	45000-002270	45000-002270	Hanging Sprinkler Assembly Tool for tube lengths over 48"	1	72.00	72.00
16	76220-009360	EDTUBEMVLV-B	Manual Valve for Micro-Tubing	10	11.10	1.11

NOTE: Sold in Bag Quantities ONLY.

POLYETHYLENE TUBING

BLACK POLYETHYLENE (PE) TUBING

Item Number	Model Number	Inside Diameter	Outside Diameter	Size	Coil Length	Price Coil (ea)	Price Per 1,000'
40510-000003	14052062	.520"	.620"	16 mm	1,000'	119.25	119.25
40510-000025	14052062-05	.520"	.620"	16 mm	500'	59.63	119.25
40510-000024	14052062-01	.520"	.620"	16 mm	100'	18.86	188.62
40510-000005	14060070	.600"	.700"	18 mm	1,000'	135.72	135.72
40510-000036	14060070-05	.600"	.700"	18 mm	500'	67.86	135.72
40510-000018	14082094	.820"	.940"	3/4"	500'	110.06	220.11
40510-000070	14082094-01	.820"	.940"	3/4"	100'	25.48	254.81
40510-000020	14106120	1.06"	1.20"	1"	500'	165.69	331.37
40510-000085	14106120-01	1.06"	1.20"	1"	100'	33.14	331.37



BLACK POLYETHYLENE (PE) PRE-PUNCH TUBING

Item Number	Model Number	Inside Diameter	Outside Diameter	Pre-Punch Spacing	Size	Coil Length	Price Coil (ea)	Price Per 1,000'
40510-000255	84520620-18	.520"	.620"	18"	16 mm	1,000'	145.93	145.93
40510-000300	84520620-24	.520"	.620"	24"	16 mm	1,000'	139.26	139.26
40510-000234	84820940-36	.820"	.940"	36"	3/4"	500'	116.72	233.44
40510-000242	84106120-36	1.06"	1.20"	36"	1"	500'	172.35	344.70

NOTE: Minimum purchase 3,000' for spacings not listed above. Pricing calculated on a per punched hole basis.

UV WHITE™ POLYETHYLENE (PE) TUBING

Item Number	Model Number	Inside Diameter	Outside Diameter	Size	Coil Length	Price Coil (ea)	Price Per 1,000'
40510-000100	14W052062-05	.520"	.620"	16 mm	500'	68.57	137.14
40510-000105	14W082094	.820"	.940"	3/4"	500'	126.57	253.13
40510-000106	14W082094-01	.820"	.940"	3/4"	100'	29.30	293.03
40510-000108	14W106120	1.06"	1.20"	1"	500'	190.54	381.07
40510-000109	14W106120-01	1.06"	1.20"	1"	100'	38.11	381.07



SPECIAL ORDER
BRIGHT WHITE PE TUBING
CALL FOR QUOTE

UV WHITE™ POLYETHYLENE (PE) PRE-PUNCH TUBING

Item Number	Model Number	Inside Diameter	Outside Diameter	Pre-Punch Spacing	Size	Coil Length	Price Coil (ea)	Price Per 1,000'
40510-000252	84W820940-36	.820"	.940"	36"	3/4"	500'	133.24	266.47
40510-000181	84W106120-36	1.06"	1.20"	36"	1"	500'	197.21	394.41

NOTE: Minimum purchase 3,000' for spacings not listed above. Pricing calculated on a per punched hole basis.

OVAL TUBE

Item Number	Model Number	Size	Pressure Rating (psi)	Coil Length	Price Coil (ea)	Price Per 1,000'
43001-000035	OT1.00-42-660W	1.00"	42	660'	307.83	466.41
43001-000027	OT1.25-42-400W	1.25"	42	400'	263.16	657.91
43001-000029	OT1.50-42-350W	1.50"	42	350'	358.19	1,023.39
43001-000031	OT2.00-42-250W	2.00"	42	250'	347.21	1,388.83



12 coils per pallet

DRIPLINES

DRIPLINES FOR WATERING CONTAINERS



SPACE-IT™ DRIPLINE (Stocked Product)

Thinwall Dripline (8 ml .636" diameter) with Dripper Visibly Marked on Tubing
For Use Over Containers

Item Number	Model Number	Flow	Spacing	Coil Length	Price Coil (ea)	Price Per 1,000'
16523-000101	06SL8636.2DM-12	0.2 GPH	12"	9,000'	620.19	68.91
16523-000102	06SL8636.4DM-14	0.4 GPH	14"	9,000'	607.86	67.54
16523-000103	06SL8636.4DM-16	0.4 GPH	16"	9,000'	598.68	66.52
16523-000104	06SL8636.4DM-18	0.4 GPH	18"	9,000'	589.68	65.52
16523-000105	06SL8636.4DM-20	0.4 GPH	20"	9,000'	581.04	64.56
16523-000106	06SL8636.4DM-24	0.4 GPH	24"	9,000'	569.52	63.28

NOTE: Flow rates and dripper spacings not listed above are special order, non-stock products and are subject to a minimum order quantity. Contact Netafim USA Customer Service for pricing and availability.

DRIPLINES FOR FIELD PRODUCTION



DRIPNET PC DRIPLINE (Non-Stock Product)

Thinwall Pressure Compensating Dripline (13 ml, .636" diameter)

Item Number	Model Number	Flow	Spacing	Coil Length	Price Coil (ea)	Price Per 1,000'
17606-000074	06DF63613.26-12	0.26 GPH	12"	4,600'	590.92	128.46
17606-000067	06DF63613.4-18	0.4 GPH	18"	4,600'	564.51	122.72
17606-000068	06DF63613.4-24	0.4 GPH	24"	4,600'	536.27	116.58

NOTE: All items are non-stock and are subject to a minimum order of 8 coils. Additional wall thicknesses, spacings and flow rates are available. Contact Netafim USA Customer Service for pricing and availability.

UNIRAM DRIPLINE (Non-Stock Product)

Heavywall Pressure Compensating Dripline (18 mm)

Item Number	Model Number	Flow	Spacing	Coil Length	Price Coil (ea)	Price Per 1,000'
14201-000002	08UR18.6-12	0.6 GPH	12"	1,000'	386.17	386.17
14201-000037	08UR18.6-18	0.6 GPH	18"	1,000'	314.46	314.46
14201-000003	08UR18.6-24	0.6 GPH	24"	1,000'	275.84	275.84
14201-000005	08UR18.6-36	0.6 GPH	36"	1,000'	241.82	241.82

NOTE: All items are non-stock and are subject to a minimum order of 8 coils. Additional wall thicknesses, spacings and flow rates are available. Contact Netafim USA Customer Service for pricing and availability.



DRIPLINE AND POLYETHYLENE FITTINGS



16 MM (.520" - .540" I.D.) AND 18 MM (.620" I.D.) FITTINGS AND CONNECTORS

Key	Item Number	Model Number	Description	Bag Qty	Price Bag	Price Each
1	32500-010720	H520IC-B	16 mm Insert Coupling	50	22.50	0.45
	32500-014215	H620IC-B	18 mm Insert Coupling	100	60.00	0.60
2	32500-011330	H520IT3-B	16 mm Insert Tee	100	93.00	0.93
3	32500-012530	H520IE-B	16 mm Elbow Insert Connector	100	78.00	0.78
4	32500-011020	H520IMA075-B	16 mm Insert Adapter 3/4" MIPT	50	53.00	1.06
	00115-002150	H5703414018C-B	18 mm Insert Adapter 1/2" MIPT	100	89.00	0.89
5	32500-013030	H620FIG8-B	16 mm Figure 8 Line End	100	25.00	0.25
	32500-014430	H800FIG8-B	18 mm Figure 8 Line End	100	56.00	0.56
6	00005-008960	58ISV520	16 mm Inline Shut-Off Valve	1	2.90	2.90
	00005-008970	58ISV600	18 mm Inline Shut-Off Valve	1	3.40	3.40

NOTE: Sold in Bag Quantities ONLY.

3/4" (.820" I.D.) FITTINGS AND CONNECTORS

Key	Item Number	Model Number	Description	Bag Qty	Price Bag	Price Each
1	32500-021530	H820IC-B	3/4" Insert Coupling	100	116.00	1.16
4	32500-014827	H820IMA075-B	0.820" x 3/4" MIPT Insert Adapter	50	68.00	1.36
5	78241-002500	58AP8900	3/4" Figure 8 Line End	1	1.60	1.60
6	00005-008990	58ISV820	3/4" Inline Shut-off Valve	1	5.90	5.90

NOTE: Sold in Bag Quantities ONLY.



THINWALL DRIPLINE (.636" I.D.) FITTINGS AND CONNECTORS

Key	Item Number	Model Number	Description	Bag Qty	Price Bag	Price Each
1	32500-016770	T630CB-B	.636" TWD Insert Coupling with Rings	100	40.00	0.40
2	32500-016490	T630END-B	.636" TWD End Plug with Ring	100	50.00	0.50
3	32500-015270	T630MA075-B	.636" TWD 3/4" MIPT Male Adapter with Ring	50	47.50	0.95
4	00115-005150	T63036450170-B	.636" TWD Connector with grommet	100	80.00	0.80
4a	00115-000500	T264600	Grommet (for use with 1 1/2" or larger PVC)	100	28.00	0.28
5	00115-006251	T63042440170-B25	.636" TWD x Barb Connector, grommet, valve	25	46.25	1.85

TWD = Thinwall Dripline

Use 5/8" Drill for TWD Fittings to PVC

NOTE: Sold in Bag Quantities ONLY.

FILTERS

MESH/MICRON

Mesh	Micron	Color
40	400	Blue
80	200	Yellow
120	130	Red
140	115	Black

FILTRATION RECOMMENDATIONS

Water Source	Filtration Method
Well*	Screen or Disc Filters
Surface (pond, lake, canal)	Disc Filters
Recirculated	Disc Filters

*A Hydrocyclone (sand separator) is recommended for well water with more than 3 PPM sand.



3/4"

1"

1 1/2" SUPER

MANUAL DISC FILTERS

Item Number	Model Number	Filter Size	Mesh	Flow Range (GPM)	Max. Pressure	Price Each
70640-001200	25A45-120	3/4"	120	1-12	140 psi	29.00
70640-001300	25A45-140		140			29.00
70641-001600	25A47-120	1"	120	5-26	140 psi	89.00
70641-001700	25A47-140		140			89.00
70641-003420	25A17-120	1 1/2" Super	120	10-52	140 psi	184.00
70641-003430	25A17-140		140			184.00
70641-003640	25A30-120	2" Dual HP	120	40-120	174 psi	460.00
70641-003660	25A30-140		140			460.00
70640-004521	25A2DL-120	2" Dual Lite	120	40-110	115 psi	280.00
70640-004520	25A2DL-140		140			280.00
70640-006783	25A3TL-120F	3" Twin Lite	120	80-220	115 psi	536.00
70640-006786	25A3TL-140F		140			536.00



2" DUAL HP

2" DUAL LITE



3" TWIN LITE

NOTE: 120 mesh recommended for Drippers, Spray Stakes, Mistlers and Sprinklers.
140 mesh recommended for Fogger applications. Other mesh options available.



2" COMPACT LP DISC-KLEEN



2" LP DISC-KLEEN

AUTOMATIC DISC-KLEEN FILTERS

Item Number	Model Number	Description	Flow Range (GPM)	Price Each
70641-007220	26LP2A1-120DCLAX*	2" Compact LP Disc-Kleen - 120 mesh, DC	1-40	5,300.00
70641-007223	26LP2A1LF120DCLAX*	2" Compact LP Disc-Kleen Low Flow - 120 mesh, DC	1-80	5,300.00
70610-022000	26LP2PP2120AC	2" LP Disc-Kleen - 2 Filters, 120 mesh AC Solenoid	50-160	6,636.00
70610-022002	26LP2PP2120DC	2" LP Disc-Kleen - 2 Filters, 120 mesh DC Solenoid		6,636.00
70610-022100	26LP2PP3120AC	2" LP Disc-Kleen - 3 Filters, 120 mesh AC Solenoid	100-240	9,023.00
70610-022105	26LP2PP3120DC	2" LP Disc-Kleen - 3 Filters, 120 mesh DC Solenoid		9,023.00
70610-022200	26LP2PP4120AC	2" LP Disc-Kleen - 4 Filters, 120 mesh AC Solenoid	150-320	11,695.00
70610-022212	26LP2PP4120DC	2" LP Disc-Kleen - 4 Filters, 120 mesh DC Solenoid		11,695.00
70605-021550	26LP3PPB3120AC	3" LP Disc-Kleen - 3 Filters, 120 mesh AC Solenoid	150-450	13,486.00
70661-004450	26LP3PPB3120DC	3" LP Disc-Kleen - 3 Filters, 120 mesh DC Solenoid		13,486.00
70605-022660	26LP3PPB4120AC	3" LP Disc-Kleen - 4 Filters, 120 mesh AC Solenoid	250-600	17,163.00
70661-004520	26LP3PPB4120DC	3" LP Disc-Kleen - 4 Filters, 120 mesh DC Solenoid		17,163.00
70605-023560	26LP3PPB5120AC	3" LP Disc-Kleen - 5 Filters, 120 mesh AC Solenoid	350-750	21,125.00
-	26LP3PPB5120DC	3" LP Disc-Kleen - 5 Filters, 120 mesh DC Solenoid		21,125.00



3" LP DISC-KLEEN

*Backflush controller included. Requires (2) 9 volt batteries. AC model also available.

2" and 3" batteries are standard with polypropylene manifolds, plastic backflush valves and installed drain manifold - requires separate purchase of backflush controller. Minimum pressure for backflush is 30 psi downstream. Other mesh options available. Maximum Pressure: 90 psi. For 91-140 psi, a High Pressure Model is recommended.

FILTERS



APOLLO AUTOMATIC DISC-KLEEN FILTERS

Standard Model with Plastic Backflush Valve - Maximum Operating Pressure 90 psi

Item Number	Model Number	Description	Flow Range (GPM)	Price Each
-	26ASK3APPB4120AC	Apollo Disc-Kleen, Angle, 4 Filters, 120 mesh AC Solenoid	300-800	24,831.00
-	26ASK3APPB4120DC	Apollo Disc-Kleen, Angle, 4 Filters, 120 mesh DC Solenoid		24,831.00
70605-021960	26ASK4PPB3120AC	Apollo Disc-Kleen, Twin, 3 Filters, 120 mesh AC Solenoid	500-1,200	24,170.00
70605-021962	26ASK4PPB3120DC	Apollo Disc-Kleen, Twin, 3 Filters, 120 mesh DC Solenoid		24,170.00
70605-022970	26ASK4PPB4120AC	Apollo Disc-Kleen, Twin, 4 Filters, 120 mesh AC Solenoid	700-1,600	36,244.00
70661-015436	26ASK4PPB4120DC	Apollo Disc-Kleen, Twin, 4 Filters, 120 mesh DC Solenoid		36,244.00
70605-023851	26ASK4PPB5120AC	Apollo Disc-Kleen, Twin, 5 Filters, 120 mesh AC Solenoid	850-2,000	45,188.00
70661-015456	26ASK4PPB5120DC	Apollo Disc-Kleen, Twin, 5 Filters, 120 mesh DC Solenoid		45,188.00

Requires separate purchase of backflush controller. Standard with installed drain manifold.
 Minimum pressure for backflush is 30 psi downstream. Maximum Pressure: 90 psi. For pressures of 91-140 psi, a High Pressure Model is recommended. Large battery sizes with flow ranges to 3,200 GPM and other mesh options available, please contact Netafim USA Customer Service for details.

SCAN-KLEEN SCREEN FILTERS

Item Number	Model Number	Filter Size	Mesh	Max. Flow (GPM)	Price Each
70640-013200	27ASCAN3-120	3" Angle	120	250	1,840.00
70640-013180	27ASCAN3-150		150		1,840.00
70640-013250	27ASCAN4-120	4" Angle	120	300	2,172.00
70640-013260	27ASCAN4-150		150		2,172.00
70640-013300	27ASCAN4T-120	4" Twin	120	500	4,069.00
70640-013321	27ASCAN4T-150		150		4,069.00
70640-013350	27ASCAN6T-120	6" Twin	120	600	4,281.00
70640-013370	27ASCAN6T-150		150		4,281.00



NETAFIM BACKFLUSH CONTROLLERS

Item Number	Model Number	Description	Voltage	Price Each
00105-006200	31NBCAC2	2 Outputs with DP Sensor	24VAC	1,258.00
00105-006210	31NBCAC4	4 Outputs with DP Sensor		1,357.00
00105-006220	31NBCAC6	6 Outputs with DP Sensor		1,456.00
00105-006250	31NBCDCL2	2 Outputs with DP Sensor	12VDCL	1,258.00
00105-006260	31NBCDCL4	4 Outputs with DP Sensor		1,357.00
00105-006270	31NBCDCL6	6 Outputs with DP Sensor		1,456.00
73240-003195	31NBCACCARD	2 Output Expansion Card		24VAC
73240-003177	31NBCDCCARD	2 Output Expansion Card	12VDCL	99.00



All Controllers are standard with a mounting bracket.

NOTE: Controllers can be pre-installed on automatic disc filters for an additional fee.
 Call Netafim USA Customer Service for Pricing and Availability.

ALEX-TRONIX BACKFLUSH CONTROLLERS

Item Number	Model Number	Description	Price Each
00105-001400	23AXF2ACDC-D	2 Station 24VAC/12VDC Controller	1,453.00
00105-002300	23AXF4ACDC-D	4 Station 24VAC/12VDC/12VDCL Controller	1,981.00
00105-004950	23AXF8ACDC-D	8 Station 24VAC/12VDC/12VDCL Controller	2,240.00

PRESSURE REGULATORS

3/4" LOW FLOW PRESSURE REGULATORS

Item Number	Model Number	Flow Range (GPM)	Nominal Output Pressure (psi)	Regulating Units	Price Each
31000-001000	32PRV.75-LF15V2	.25 - 4.4	15	-	9.40
31000-001120	32PRV.75-LF20V2	.25 - 4.4	20	-	9.40
31000-001200	32PRV.75-LF35V2	.25 - 4.4	35	-	9.40



3/4" PRESSURE REGULATORS

Item Number	Model Number	Flow Range (GPM)	Nominal Output Pressure (psi)	Regulating Units	Price Each
30500-001100	32PRV.75-12V2K	4.5 - 17.6	12	1	17.00
30500-001300	32PRV.75-20V2K	4.5 - 17.6	20	1	17.00
30500-001600	32PRV.75-35V2K	4.5 - 17.6	35	1	17.00
30500-002000	32PRV.75-65V2K	4.5 - 17.6	65	1	17.00



1 1/2" PRESSURE REGULATORS

Item Number	Model Number	Flow Range (GPM)	Nominal Output Pressure (psi)	Regulating Units	Price Each
30520-001100	32PRV1.5-12V2K	11 - 35	12	2	44.00
30520-001300	32PRV1.5-20V2K	11 - 35	20	2	44.00
30520-001600	32PRV1.5-35V2K	11 - 35	35	2	44.00
30520-002000	32PRV1.5-65V2K	11 - 35	65	2	44.00



2" PRESSURE REGULATORS

Item Number	Model Number	Flow Range (GPM)	Nominal Output Pressure (psi)	Regulating Units	Price Each
30540-002200	32PRV2-412V2K	22 - 70	12	4	165.00
30540-002400	32PRV2-420V2K	22 - 70	20	4	165.00
30540-002700	32PRV2-435V2K	22 - 70	35	4	165.00



PRESSURE REGULATING UNITS

Item Number	Model Number	Nominal Output (psi)	Price Each
31500-001100	32PRVU-12V2K	12	12.00
31500-001300	32PRVU-20V2K	20	12.00
31500-001600	32PRVU-35V2K	35	12.00
31500-002000	32PRVU-65V2K	65	12.00



NOTES:

- 12 psi recommended for Thinwall Driplines.
 - 20 psi recommended for Non-Compensating Drippers and Spray Stakes.
 - 35 psi recommended for Sprinklers, Misters, Pressure Compensating Drippers and PC Spray Stakes.
 - 65 psi recommended for Foggers.
- Additional pressure options available.
Maximum operating pressure 145 psi.

AIR VENTS AND WATER METERS



1" COMBINATION



2" COMBINATION



2" DYNAMIC



3/4" & 1" GUARDIAN



1" GUARDIAN WITH SHRADER VALVE



2" GUARDIAN

AIR VENTS

Item Number	Model Number	Size	Description	Connection	Max. Pressure	Body	Price Each
70561-001250	65ARIB1	1"	Combination Air/Vacuum Relief, Continuous Acting	MPT	150 psi	Nylon	157.00
70561-001660	65ARIB2PP	2"	Combination Air/Vacuum Relief, Continuous Acting	MPT	240 psi	Polypropylene	195.00
70561-001735	65ARIDY2	2"	Dynamic	MPT	150 psi	Nylon	309.00
70561-002950	65ARIA075	3/4"	Guardian Air/Vacuum Relief	MPT	150 psi	Nylon	40.00
70561-002610	65ARIA100	1"	Guardian Air/Vacuum Relief	MPT	150 psi	Nylon	40.00
70561-004820	65ARIA100S	1"	Guardian Air/Vacuum Relief with Shrader Valve	MPT	150 psi	Nylon	51.00
70561-002710	65ARIA2	2"	Guardian Air/Vacuum Relief	FPT	150 psi	Nylon	55.00

Price discounts available for case quantity purchases, please contact Netafim USA Customer Service for details.

MPT = Male Pipe Thread

FPT = Female Pipe Thread

FERTILIZER METERS

Item Number	Model Number	Size and Body	Max. Flow (GPM)	Pulse (Gallons)	Connection	Price Each
70261-011000	36FMPO.75	3/4" Plastic	2.2	0.1	MPT	373.00
70261-011030	36FMPO.751	3/4" Plastic	2.2	1.0	MPT	373.00
70261-011300	36FMPVE1	1" PVC	44	1.0	MPT	952.00



3/4" PLASTIC



1" PVC

MPT = Male Pipe Thread

WATER METERS

Standard with Gallon Totalizer Register. Includes Pulse Reed Switch for pulsed output.

Item Number	Model Number	Size	Flow Range (GPM)*	Pulse (Gallons)	Maximum Pressure (psi)	Connection	Price Each
70261-002720	36M251T	1"	1.2 - 20	0.1	145		307.00
70261-003230	36M401.5T	1 1/2"	3.5 - 55	0.1	145	MPT	615.00
70261-005060	36WMR2T10	2"	8.8 - 110	10.0	230		602.00
70261-010220	36WST3F	3"	2.0 - 660	10.0	230		1,015.00
70261-009200	36IRT3F	3"	45 - 500	10.0	230	Flanged	889.00
70261-009500	36IRT4F	4"	50 - 688	10.0	230		1,156.00
70220-005300	36RD	Pulse Reed Switch	-	-	-	-	62.00

*Flow accuracy ± 2%. Acre foot totalizer is available as a non-standard option.

MPT = Male Pipe Thread



2" WMR



4" IRT

VALVES

SERIES 80 NYLON CONTROL 2-WAY VALVES

Item Number	Model Number	Size	Voltage	Price Each
71640-007355	61ET.75GH2		24VAC	44.00
-	61ET.75GH2-24DC	3/4"	24VDC	44.00
71640-007357	61ET.75GH2-12DC	Globe	12VDC	56.00
71640-007356	61ET.75GH2-L		12VDCL	56.00
71640-007358	61ET.75GH2-120		120VAC	78.00
71640-007406	61ET1GH2		24VAC	44.00
71610-013966	61ET1GH2-24DC	1"	24VDC	44.00
71610-014523	61ET1GH2-12DC	Globe	12VDC	56.00
71610-013967	61ET1GH2-L		12VDCL	56.00
71610-013968	61ET1GH2-120		120VAC	78.00
71640-007425	61ET1.5GH2		24VAC	110.00
-	61ET1.5GH2-24DC	1 1/2"	24VDC	141.00
-	61ET1.5GH2-12DC	Globe	12VDC	153.00
71610-014061	61ET1.5GH2-L		12VDCL	153.00
71610-014063	61ET1.5GH2-120		120VAC	175.00
71640-007426	61ET1.5GH2-AN		24VAC	148.00
-	61ET1.5GH2-AN-24DC	1 1/2"	24VDC	179.00
-	61ET1.5GH2-AN-12DC	Angle	12VDC	191.00
71610-014066	61ET1.5GH2-AN-L		12VDCL	191.00
-	61ET1.5GH2-AN-120		120VAC	213.00
71610-014528	61ET2GH2		24VAC	148.00
-	61ET2GH2-24DC	2"	24VDC	179.00
71610-014524	61ET2GH2-12DC	Globe	12VDC	191.00
71610-014525	61ET2GH2-L		12VDCL	191.00
71610-013971	61ET2GH2-120		120VAC	213.00
71640-007665	61ET2GH2-AN		24VAC	164.00
-	61ET2GH2-AN-24DC	2"	24VDC	195.00
-	61ET2GH2-AN-12DC	Angle	12VDC	206.00
-	61ET2GH2-AN-L		12VDCL	206.00
-	61ET2GH2-AN-120		120VAC	229.00

MAXIMUM RECOMMENDED FLOW RATES (GPM)

3/4"	1"	1 1/2"	2"	3"	4"	6"
50	50	90	175	390	600	1,300



3/4" OR 1" GLOBE



1 1/2" OR 2" GLOBE



1 1/2" OR 2" ANGLE

SERIES 80 2-WAY VALVES WITH CONTROLLER

Includes Battery Operated Aqua Pro Single Valve Controller

Item Number	Model Number	Size	Voltage	Price Each
71610-013955	61ET.75GH2-L-CONT	3/4" Globe	12VDCL	168.00
71610-013969	61ET1GH2-L-CONT	1" Globe	12VDCL	168.00
71610-014062	61ET1.5GH2-L-CONT	1 1/2" Globe	12VDCL	266.00
-	61ET1.5GH2-AN-L-CONT	1 1/2" Angle	12VDCL	303.00
71610-014526	61ET2GH2-L-CONT	2" Globe	12VDCL	303.00
-	61ET2GH2-AN-L-CONT	2" Angle	12VDCL	320.00



SERIES 80 WITH AQUA PRO CONTROLLER



AQUA PRO CONTROLLER

AQUA PRO CONTROLLER

Item Number	Model Number	Price Each
37000-002100	AP-CONTROLLER-P3	80.00

VALVES

SERIES 80 NYLON CONTROL 3-WAY VALVES

Model Number	Size	Function	Price Each
61ELTH1.5GH3		EL	246.00
61PRTH1.5GH3-*	1 1/2"	PR	319.00
61PRELTH1.5GH3-*	Globe	PREL	373.00
61PSTH1.5GH3-*		PS	358.00
61PSELTH1.5GH3-*		PSEL	424.00
61ELTH1.5GH3AN		EL	246.00
61PRTH1.5GH3AN-*	1 1/2"	PR	319.00
61PRELTH1.5GH3AN-*	Angle	PREL	373.00
61PSTH1.5GH3AN-*		PS	358.00
61PSELTH1.5GH3AN-*		PSEL	424.00
61ELTH2GH3		EL	260.00
61PRT2GH3-*	2"	PR	332.00
61PRELTH1.5GH3-*	Globe	PREL	418.00
61PSTH2GH3-*		PS	373.00
61PSELTH2GH3-*		PSEL	437.00
61ELTH2GH3AN		EL	260.00
61PRTH2GH3AN-*	2"	PR	332.00
61PRELTH2GH3AN-*	Angle	PREL	418.00
61PSTH2GH3AN-*		PS	373.00
61PSELTH2GH3AN-*		PSEL	437.00

Substitute * with proper Spring Color:

Y = Yellow (7-30 psi)

G = Green (14-65 psi)

R = Red (30-90 psi)

Function Code identification:

EL = Electric (standard with 24VAC - other voltages available)

PR = Pressure Reducing

PREL = Pressure Reducing Electric

PS = Pressure Sustaining

PSEL = Pressure Sustaining Electric



PS ANGLE



PREL GLOBE



NYLON ELECTRIC



NYLON PRESSURE REDUCING

3-WAY VALVES

Item Number	Model Number	Function	Size	Body	Connection	Price Each
-	V07020DGT055C01	Electric 24VAC	2"	Nylon	Threaded FPT	260.00
-	V07030PGT055C01	Electric 24VAC	3"	PVC	Threaded FPT	558.00
-	V07030PGS055C01	Electric 24VAC	3"	PVC	Slip	529.00
-	V07040PGS055C01	Electric 24VAC	4"	PVC	Slip	680.00
-	V07060PGS055C01	Electric 24VAC	6"	PVC	Slip	1,789.00
-	V32020DGT055C03	Pressure Reducing 24VAC	2"	Nylon	Threaded FPT	418.00
-	V32030PGS055C03	Pressure Reducing 24VAC	3"	PVC	Slip	669.00
35500-001320	61AQTVAC1	Aquative 24VAC Solenoid	-	-	-	93.00

Pressure Reducing Valves have a Green Pilot Spring for 14-65 psi. Also available with 12VDCL Solenoids.



NETAFIM USA
5470 E. HOME AVE.
FRESNO, CA 93727
CS 888 638 2346
WWW.NETAFIMUSA.COM