

USBlanks

MADE IN AMERICA

Surfboard Blank Catalog



FoamEZ.com

Phone: (714) 896-8233 - Fax: (714) 896-0001 - support@foamez.com

April 2015

WELCOME

Our mission at US Blanks is to establish a close partnership with customers to produce the best surfboard possible. We are committed to design, technology and to maintaining the highest level of quality while offering a wide range of products for custom ordered blanks, including an extensive variety of blank sizes, weights, stringers, rockers and glue colors.

If there is anything we can help you with at any time, please let us know. Our success is measured by our ability to accommodate your needs.

OUR COMPANY

The US Blanks team is comprised of former Clark Foam employees and leaders in the surf industry, with unparalleled experience in surfboard blank production.

Every blank we manufacture comes from our Southern California facility, making us the only polyurethane blank manufacturer producing exclusively US made surfboard blanks. Operating in California ensures that we exercise the highest standards in environmental protection and safety precautions for our entire team. Our location and industry-leading practices allow us to maintain longevity among staff and clients and provide unmatched customer service.

RECYCLING

US Blanks also proudly maintains a highly prioritized recycling initiative. Our EPS foam scraps and off-cuts are compacted and melted off-site. They are then recycled for use in a variety of applications from packaging to construction insulation. Our wood scraps, off-cuts, and sawdust from stringer production and packaging are reclaimed off-site for use outside of the surf industry. Our paper, plastic, and metal related to manufacturing, packaging, and office use is recycled using best practices and local recycling facilities.

BLANK MEASUREMENTS

All blank pictures in this catalog are drawn to the actual scale of the blanks. The wire frame diagrams are drawn on a scale of 1:12 for blank sizes shorter than 8'0", and 1:16 for blank sizes 8'0" and longer.

Actual measurements vary slightly due to the use of mold release, unpredictable shrinkage during molding, rail fill and rough rails.

The nose and tail rockers are measured from the bottom of the blank to the bottom of the nose and bottom of the tail.

Volume measurements are also listed for each blank size. These measurements are calculated using the Shape 3D scan method created from each model. Shape 3D and AKU computer files for each blank size are also available upon request. Please call our office for more details.

FOAM SELECTION

Polyurethane (PU)

US Blanks manufactures a water blown, Toluene Diisocyanate based polyester polyurethane blank. We feel this combination provides the best physical properties required by a surfboard, resulting in the strongest blank possible, and yields the best performance qualities. The quality, stability, and consistency of a TDI based polyurethane blank has long made it the choice of the majority of board builders.

While there are many formulations available for a TDI based blank, we believe our formulation provides the optimum strength while maintaining ease of shaping and maximum flex. We are continuously fine tuning our formulation to supply the shaper with a blank that exceeds industry standards for these characteristics.

To provide a truly custom polyurethane blank, we offer several densities for most blank sizes.

Actual pounds per cubic foot (pcf) of a given weight foam will vary with blank size due to mold compaction and skin to core ratio. The comparisons listed are based on the difference in pounds of foam used to pour each density and is an average among blank sizes.

The density of a blank will be identified by the color of the paint on the nose.

ORANGE (COMPETITION WEIGHT): approximately 12% - 13% lighter than BLUE. Currently only available in short boards.

RED (PERFORMANCE WEIGHT): approximately 6% - 7% lighter than BLUE.

BLUE (STOCK WEIGHT): considered our stock density and is the basis for comparison.

GREEN (CRUISER WEIGHT): approximately 9% - 10% heavier than BLUE

BROWN (CLASSIC WEIGHT): approximately 30% - 32% heavier than BLUE. These blanks will be identified with a brown tipped nose.

BLACK (TOW-IN WEIGHT): approximately 205% heavier than BLUE. These blanks will be identified with a black tipped nose.

Expanded Polystyrene (EPS)

US Blanks offers 2 types of surf-formulated EPS foam; Superfused Molded and Block-Cut.

Superfused Molded blanks are available in 13 different sizes, 2 densities (1.7 pcf and 2.0 pcf), and several different thicknesses offering the shaper a wide variety of options. The molding process also provides tighter fusion and cell structure than traditional EPS blanks,

process also provides tighter fusion and cell structure than traditional EPS blanks, although not as tight as traditional PU blanks. Superfused EPS blanks and additional information is listed on page 70.

Our surf formulated Block-Cut EPS blanks are available in 2 stock densities (1.5 pcf and 2.0 pcf), with a 3rd (1.0 pcf) available via custom order. Block-Cut EPS blanks are available in any range and size up to 16' long and 4' wide. Every blank within this catalog is available as Block-Cut EPS. Additional stock sizes are listed on page 83. Custom cut files may be submitted in either Shape 3D or AKU Shaper formats.

COLORED FOAM

US Blanks offers colored foam for stringers and full colored foam blanks.

Our colored stringer foam is made in Classic density and is available in stock colors of Blue, Red, Yellow, Orange, Green (Regular or Fresh), Black, Pink and Gray. We formulate our colors to be bright and bold. Occasionally we may have additional colors available.

Colored blanks are available for all sizes and all densities on a custom order basis. We offer colored blanks in the same colors as our stringer foam, and can also formulate any shade of the stock colors. Custom colors are available for minimum quantity orders. Custom mix-and-matching, configurations, and glue-ups are all available and only limited by one's creativity.

It may be possible to develop a proprietary custom color. Please contact our office for information.

STRINGER SELECTION

Our in-house mill capabilities allow us to offer nearly any conceivable cut or configuration. Some limits are set by the length or width of wood available. Our cedar comes 6" wide and will not fit all rockers, and our plywood has a length limit of 8'1".

Multi stringers, T-bands, off-set stringers, flares, and wedge cuts are all part of our custom stringer capability. Again, stringer configuration is only limited by one's creativity.

Parabolic rail stringer configurations are also available in a variety of different blank sizes. Our standard parabolic templates can be used in any of our shortboard sizes to suit your finished board dimensions and requirements. For a list of our template outlines and configurations please refer to the parabolic specification on page 93 of this catalog.

US Blanks currently offers 5 solid woods, various plywoods, and 2 types alternative materials for stringer selection.

Solid Woods

Balsa, Basswood, Dark Wood (Cedar Alternative), Cedar (6" wide and will not fit on all rockers), Old-Growth Redwood.

Plywoods

4mm unidirectional Poplar Ply, High Performance Ply & Team Ply (8'1" length limit). Additionally, our Poplar Ply is also available in 6mm at 10' length.

Appelcore Stringers are a 3 ply, colored-dyed, basswood stringer available in a wide range of color combinations. 5-ply (1/4") and 7-ply (3/8") are available at 8', 10', & 12'. Inquire for current availability.

Alternatives

PVC is available in red at 3mm and white at 4mm.

Powerline Stringers are a non-woven polymer laminated into a 4-ply panel. The stringer is colorless and translucent, but reflects and refracts the color of the glue line thereby allowing a wide variety color options.

ROCKER SELECTION

Everyone knows how important rocker is to the performance of a surfboard. US Blanks offers custom rockers and private rocker templates.

While our master plugs were designed with a Natural Rocker that fits a variety of designs, we know that individual style and design will require adjustments.

We use the deck line to adjust rocker, and all adjustments are referenced to the Natural Rocker. If desired, we can adjust rocker to the bottom. Adjustments can be made from almost any point on a blank and from one blank size to another. Unless instructed, all rocker adjustments will be made from the center of the blank. If the adjustment is made from a point other than center, the adjustment point will be part of the description. Rockers transferred from one blank size to another will require a match point. Radical rocker adjustments may result in bumps or dips created in the deck line.

Rocker adjustments on Block-Cut EPS blanks may be charged a slight fee, based on complexity of file adjustment required.

QUALITY GUARANTEE

US Blanks guarantees the quality of our blanks. If you receive a blank that does not meet our quality standards, we will replace the blank. In addition, if that blank has been shaped we will credit the customer with an additional blank OR a scheduled shaping fee. In order to be eligible for either credit, the inferior blank must be returned to US Blanks. We will not cover the costs of any work on the blank completed after the first notice of a problem. Refer to the US Blanks Sales Policy for specific details.

USBlanks™

MADE IN AMERICA

BLANK CODE DESCRIPTION

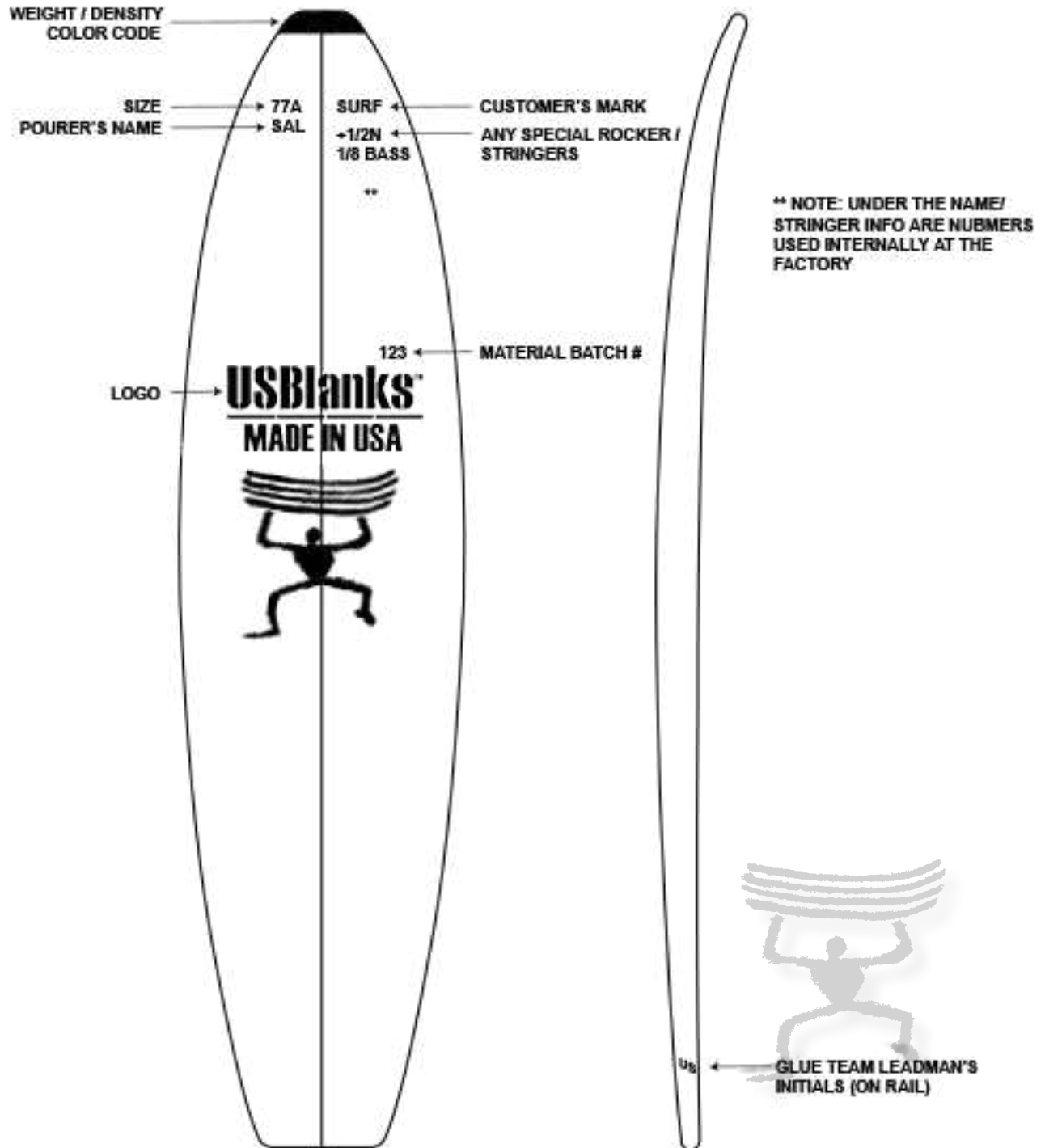

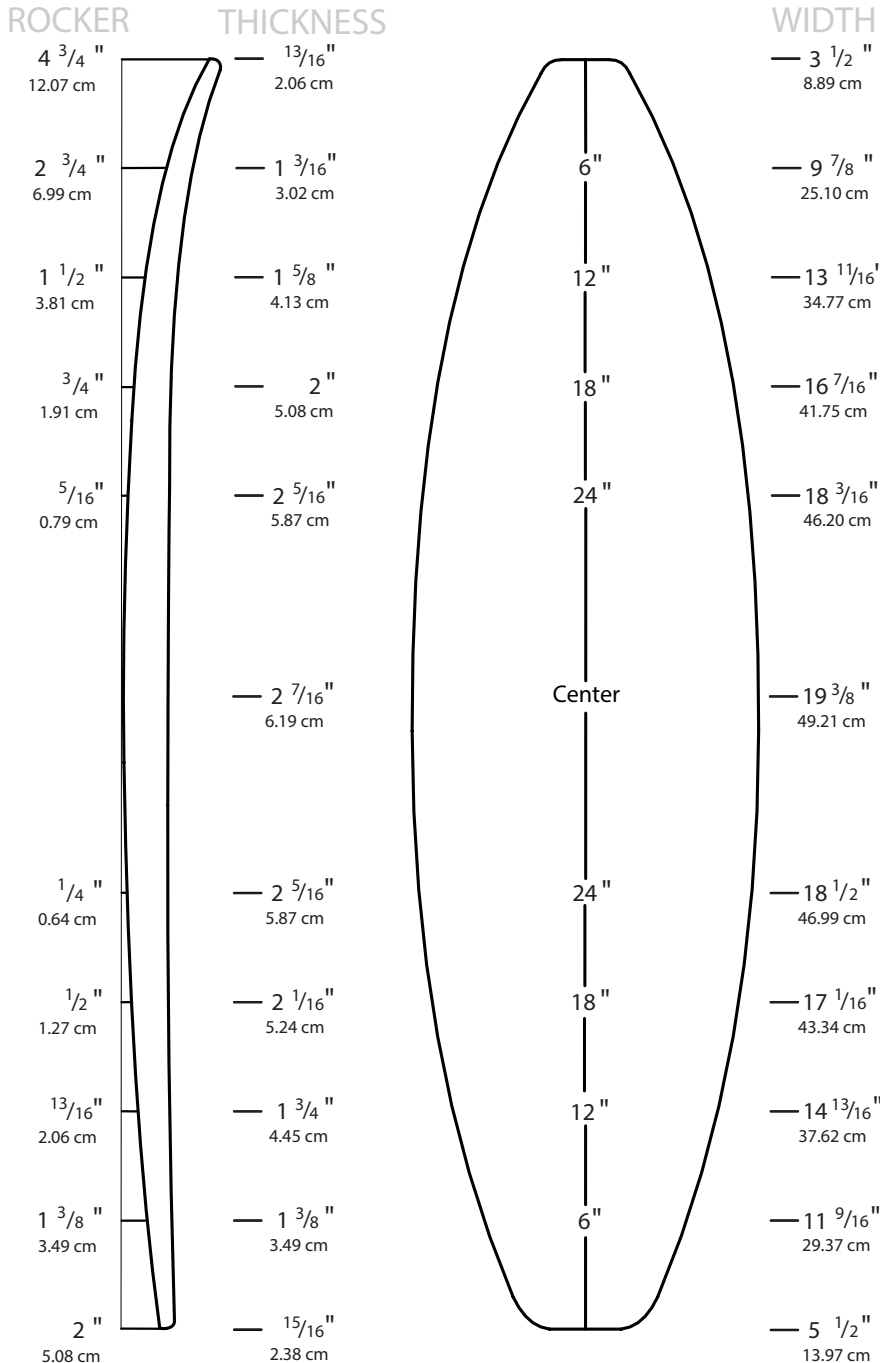

Overall Bottom Length: 5'10 1/4" (178.44 cm)

Tip-to-tip Deck Length: 5'9 5/8" (176.85 cm)

Maximum Width: 19 3/8" (49.21 cm)

Maximum Thickness: 2 7/16" (6.19 cm)

Displacement: 1.14 ft³ (32.2 L)

Introduced: April 2006

Available Rockers:

Designer Comments: This is an ideal "Grom" blank with medium volume. It has an excellent natural rocker which will also work very well in the 6'0P and 6'2P matched from the nose. A perfect hand shape blank that can also be used on the machine.

(310) 225-6774 USBlanks.com



5'10" RP

Overall Bottom Length: 5'11 1/4" (180.98 cm)

Tip-to-tip Deck Length: 5'10 3/4" (179.71 cm)

Maximum Width: 24 7/8" (63.18 cm)

Maximum Thickness: 2 15/16" (7.46 cm)

Displacement: 1.91 ft³ (54.1 L)

Introduced: October 2008. Designed for the ongoing fish revolution. This follow through design flows from the universally accepted 6'2"C from 1994.

Available Rockers:

Designer Comments: This is a versatile blank with enough volume to accommodate multiple styles of surfboard, but it was inspired by input from the famed "Fish Fry" events attended worldwide. It was designed for the modern hand shaper but modified for machine shapes. It easily nets 5'10" deck measurement with high performance rockers and thickness profiles. With research and development conducted from Africa to Japan, the 5'10" RP integrates input from many of surf designs most experienced minds. I utilize this blank with 4" of center removed for our vision of the high performance fish.

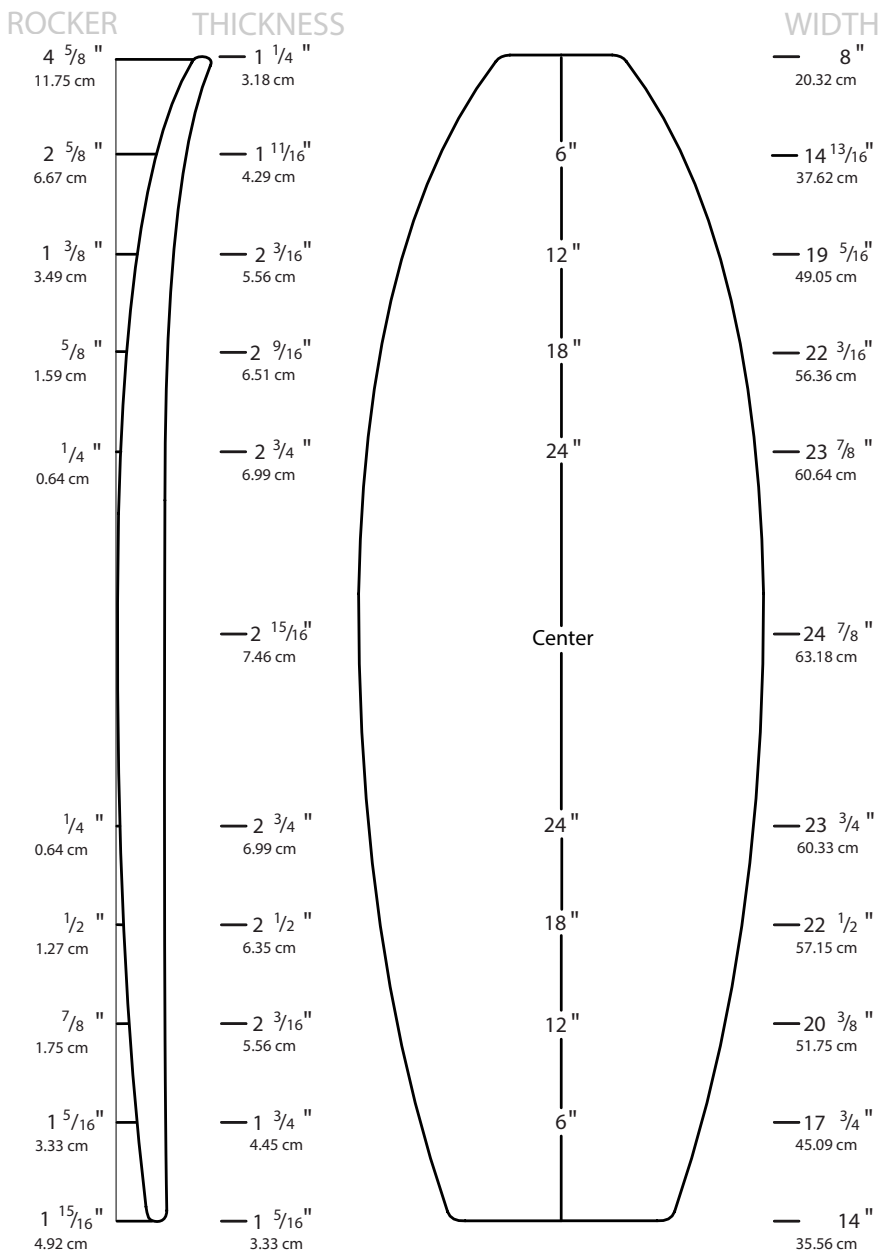

(310) 225-6774 USBlanks.com



ROCKER

THICKNESS

WIDTH

4 5/8" 11.75 cm
 2 11/16" 6.83 cm
 1 1/2" 3.81 cm
 13/16" 2.06 cm
 5/16" 0.79 cm
 3/16" 0.48 cm
 7/16" 1.11 cm
 3/4" 1.91 cm
 1 3/16" 3.02 cm
 1 11/16" 4.29 cm

7/8" 2.22 cm
 1 1/4" 3.18 cm
 1 5/8" 4.13 cm
 2" 5.08 cm
 2 1/4" 5.72 cm
 2 1/2" 6.35 cm
 2 5/16" 5.87 cm
 2 1/8" 5.40 cm
 1 7/8" 4.76 cm
 1 7/16" 3.65 cm
 1" 2.54 cm

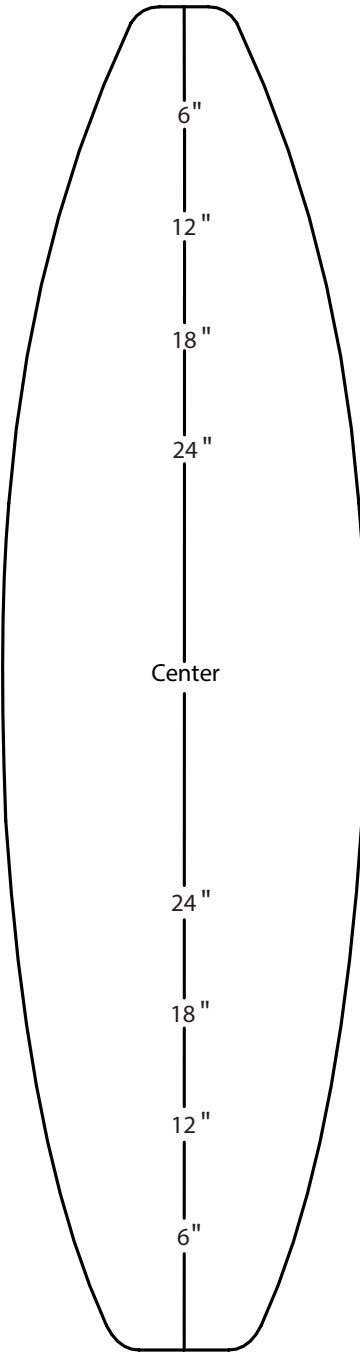

4" 10.16 cm
 10 1/16" 25.56 cm
 14 1/16" 35.72 cm
 16 13/16" 42.70 cm
 18 9/16" 47.15 cm
 20" 50.80 cm
 18 15/16" 48.10 cm
 17 11/16" 44.93 cm
 15 9/16" 39.53 cm
 12 3/8" 31.43 cm
 6 3/4" 17.15 cm

Overall Bottom Length: 6'0 3/4" (184.15 cm)

Tip-to-tip Deck Length: 6'0 1/4" (182.88 cm)

Maximum Width: 20" (50.80 cm)

Maximum Thickness: 2 1/2" (6.35 cm)

Displacement: 1.23 ft³ (34.9 L)

Introduced: January 2007

Available Rockers:

Designer Comments: This is a close to medium tolerance blank excellent for Junior sizes. Adjusted thickness flow in the nose and tail makes this a perfect quick shape blank. The design was based off the 6'2P.

Call (310) 225-6774 or visit www.usblanks.com



Overall Bottom Length: 6' 0 1/2" (184.15 cm)

Tip-to-tip Deck Length: 5' 11 3/4" (182.25 cm)

Maximum Width: 21 5/8" (54.93 cm)

Maximum Thickness: 3" (7.62 cm)

Displacement: 1.667 ft³ (47.2 L)

Introduced: March 2011

Available Rockers:

Designer Comments:

Designed to be a versatile blank for shorter, wider, relaxed rockered boards. Somewhere between a fish and performance short board. Plus volume under the chest. Semi-flat deck, and thicker on the ends should provide a wide range of options.

ROCKER

THICKNESS

WIDTH

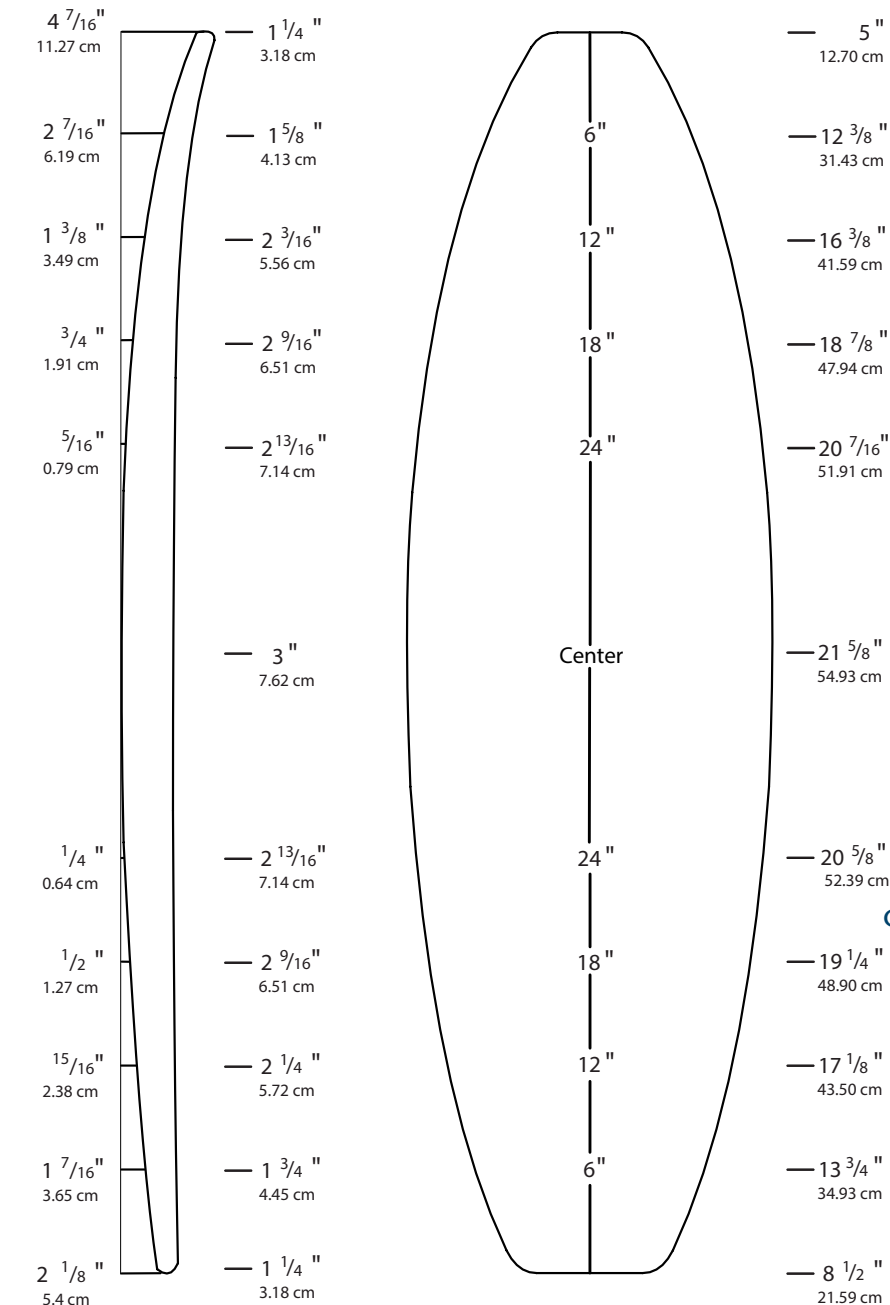

Call (310) 225-6774 or visit www.usblanks.com



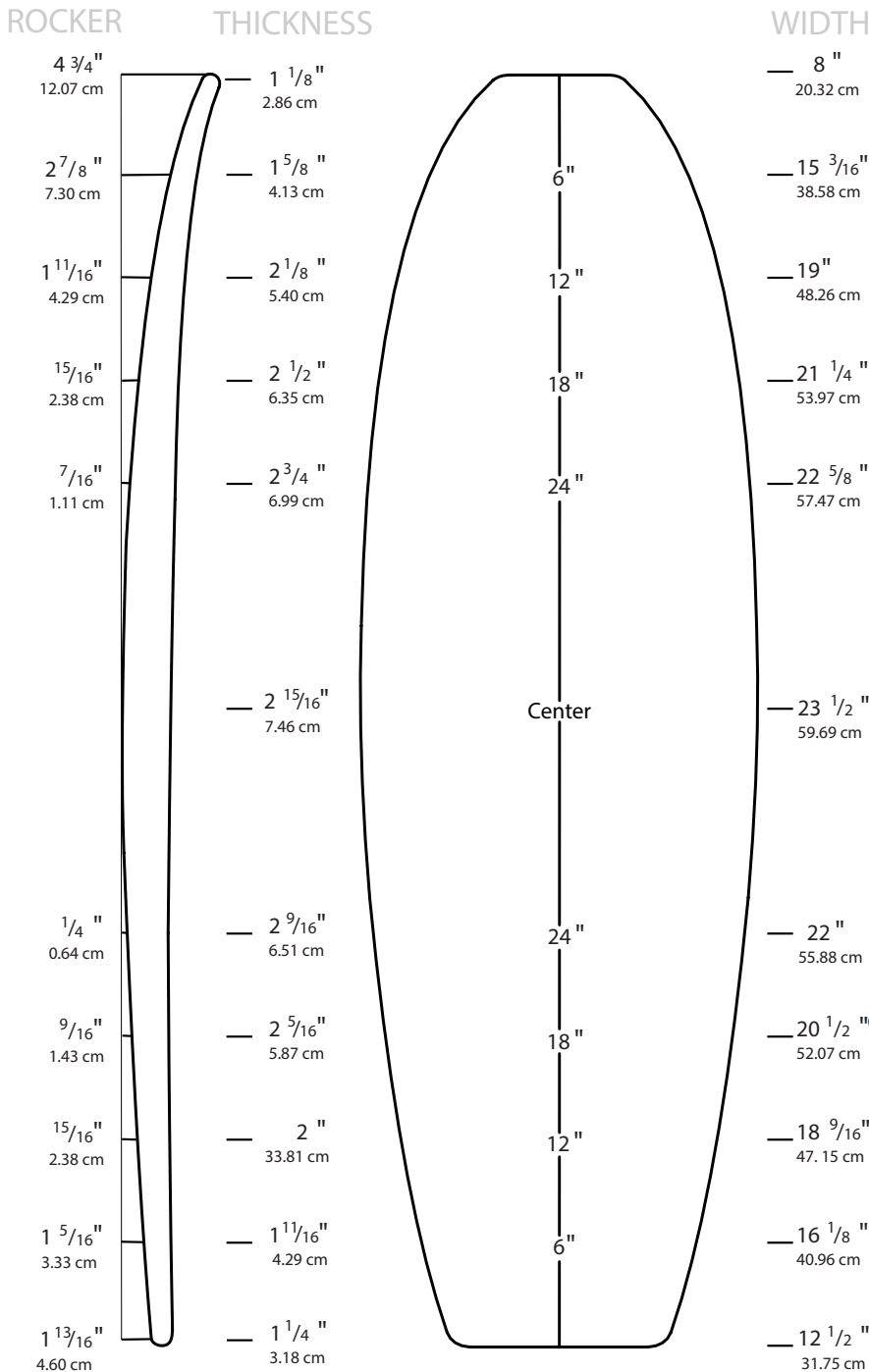

Overall Bottom Length: 6' 2 3/4" (189.87 cm)

Tip-to-tip Deck Length: 6' 2" (187.96 cm)

Maximum Width: 23 1/2" (59.69 cm)

Maximum Thickness: 2 15/16" (7.46 cm)

Displacement: 1.95 ft³ (55.1 L)

Introduced: July 2006

Available Rockers:

Designer Comments: I designed this one to be able to easily net a 6'1" by the bottom measurement for a shorter length contemporary or Retro fish (or single fin) design.

Call (310) 225-6774 or visit www.usblanks.com



ROCKER

THICKNESS

WIDTH

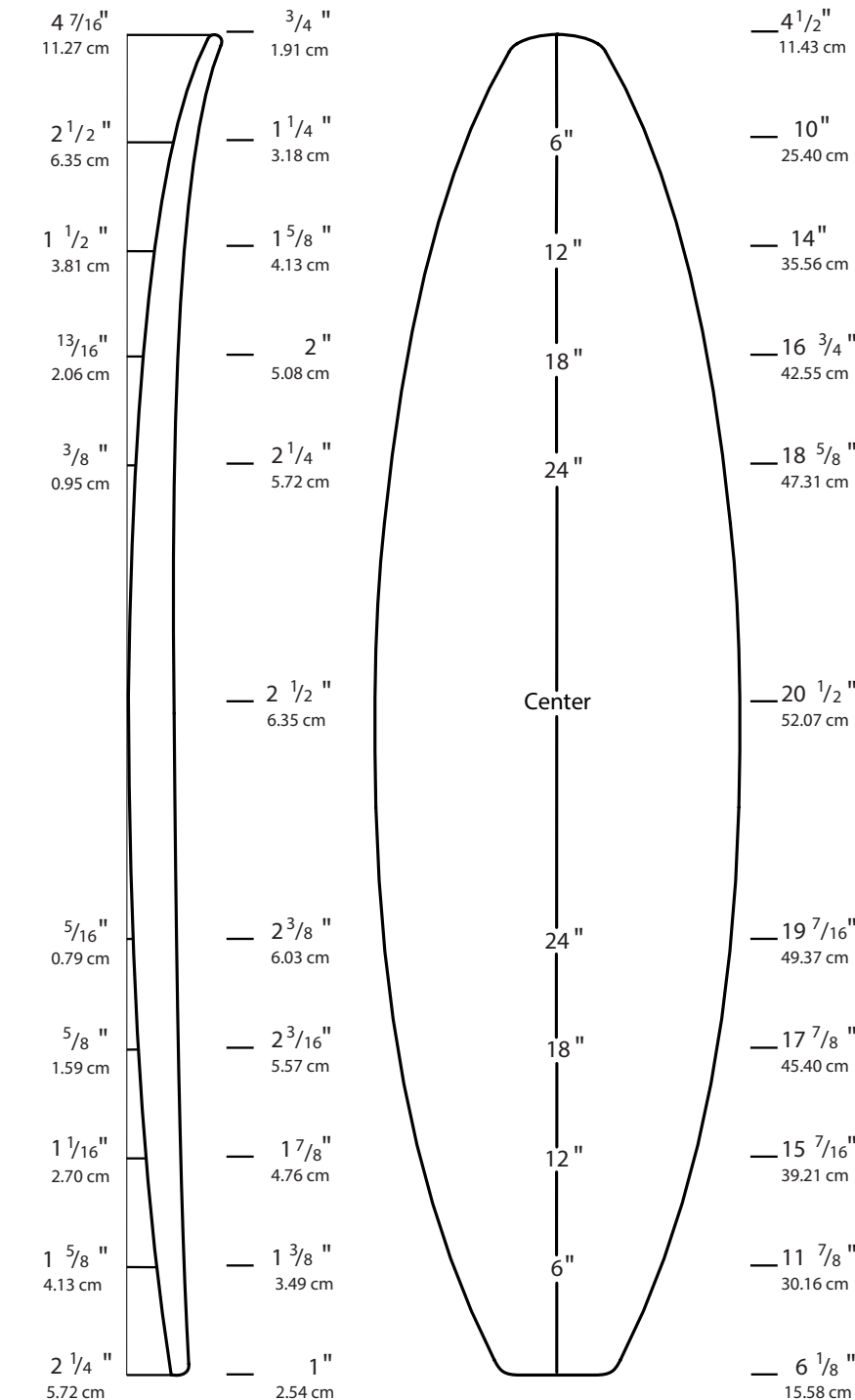

Overall Bottom Length: 6' 2 1/2" (189.23 cm)

Tip-to-tip Deck Length: 6' 1 7/8" (187.64 cm)

Maximum Width: 20 1/2" (52.07 cm)

Maximum Thickness: 2 1/2" (6.35 cm)

Displacement: 1.31 ft³ (37.2 L)

Introduced: July 2006

Available Rockers:

Designer Comments: Blank is designed for team boards and production shaping. It is a shorter version of the 6'7"P, which has a little more thickness in the nose and tail than the original. A medium tolerance blank.

Call (310) 225-6774 or visit www.usblanks.com



ROCKER

THICKNESS

WIDTH

5 1/2"
13.97 cm

3 5/16"
10.00 cm

1 13/16"
4.60 cm

15/16"
2.38 cm

7/16"
1.11 cm

5/16"
0.79 cm

9/16"
1.43 cm

15/16"
2.38 cm

1 7/16"
3.65 cm

2 1/16"
5.24 cm

3/4"
1.91 cm

1 1/4"
3.18 cm

1 11/16"
4.29 cm

2"
5.08 cm

2 5/16"
5.87 cm

2 9/16"
6.51 cm

2 5/16"
5.87 cm

2 3/16"
5.56 cm

1 7/8"
4.76 cm

1 5/8"
4.13 cm

1 1/4"
3.18 cm

6"

12"

18"

24"

Center

24"

18"

12"

6"

4 1/8"
10.48 cm

10 1/8"
25.72 cm

14 3/16"
36.04 cm

17 1/8"
43.50 cm

19"
48.26 cm

20 5/8"
52.39 cm

19 1/4"
48.90 cm

17 11/16"
44.93 cm

15 7/16"
39.21 cm

12 7/16"
31.59 cm

8"
20.32 cm

Overall Bottom Length: 6' 4 1/8" (193.36 cm)

Tip-to-tip Deck Length: 6' 3 1/4" (191.14 cm)

Maximum Width: 20 5/8" (52.39 cm)

Maximum Thickness: 2 9/16" (6.51 cm)

Displacement: 1.38 ft³ (39.2 L)

Introduced: July 2006

Available Rockers:

Designer Comments: Designed to be a versatile blank for boards 6'2" and under. I added a little nose width to accommodate most modern full nose short boards. This is an essentially thinner version of the 6'4" EA.

Call (310) 225-6774 or visit www.usblanks.com



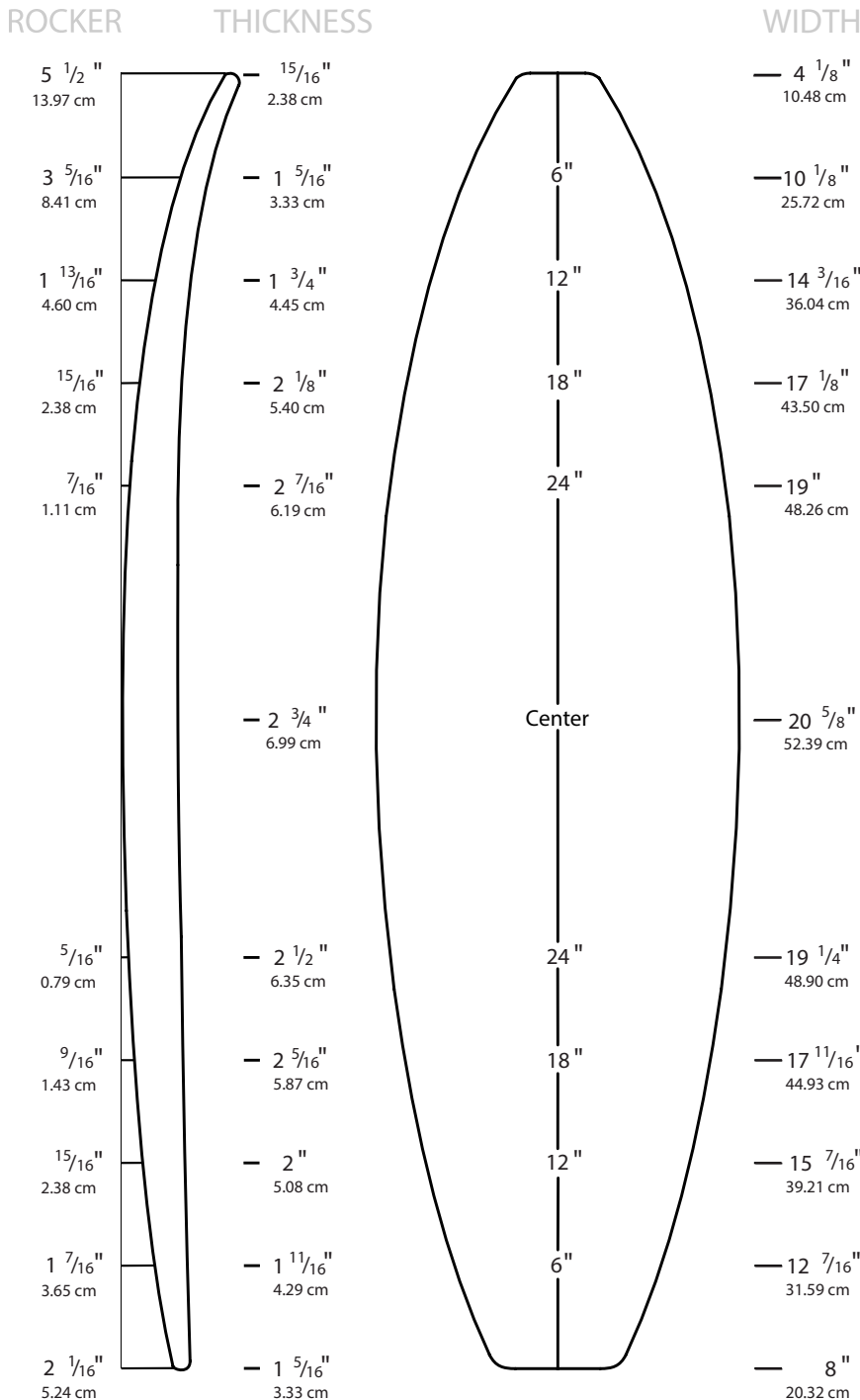

Overall Bottom Length: 6' 4 1/4" (193.66 cm)

Tip-to-tip Deck Length: 6' 3 1/2" (191.14 cm)

Maximum Width: 20 5/8" (52.39 cm)

Maximum Thickness: 2 3/4" (6.99 cm)

Displacement: 1.49 ft³ (42.3 L)

Introduced: July 2006

Available Rockers:

Designer Comments: Designed to be a versatile blank for modern shortboard designs 6'2" and under in length. I added a little nose width to accommodate most modern full nose short boards, and it also accommodates machine shapes.

Call (310) 225-6774 or visit www.usblanks.com



ROCKER

THICKNESS

WIDTH

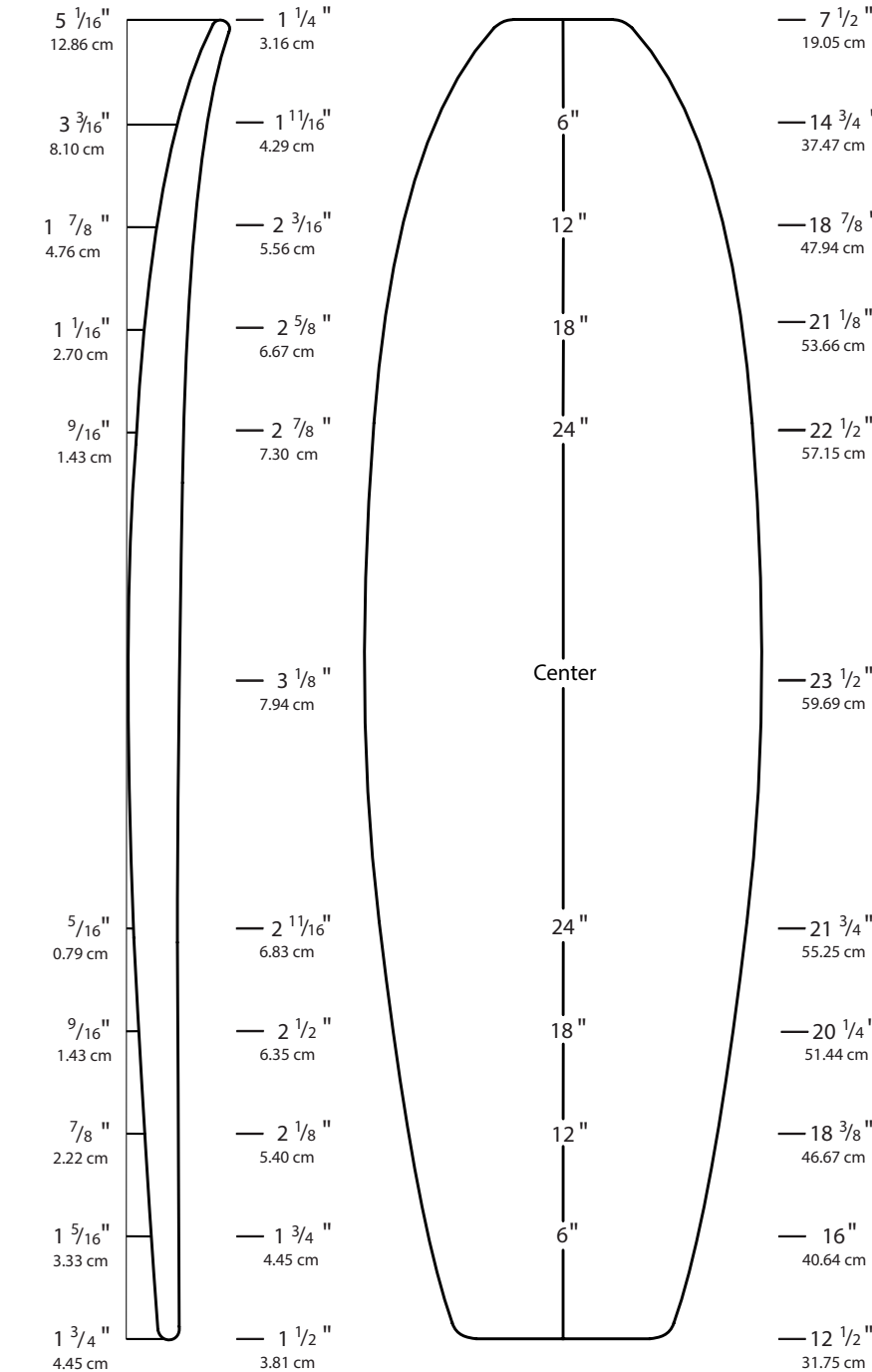

Overall Bottom Length: 6' 5 1/2" (196.85 cm)

Tip-to-tip Deck Length: 6' 4 7/8" (195.26 cm)

Maximum Width: 23 1/2" (59.69 cm)

Maximum Thickness: 3 1/8" (7.94 cm)

Displacement: 2.15 ft³ (60.9 L)

Introduced: July 2006

Available Rockers:

Designer Comments: This is my longer version of the 6'2" A, to be able to easily net a 6'4" by the bottom measurement for a shorter mid length contemporary or Retro fish (or single fin) design.

Call (310) 225-6774 or visit www.usblanks.com



ROCKER

THICKNESS

WIDTH

4 11/16"
11.91 cm

2 9/16"
6.51 cm

1 9/16"
3.97 cm

7/8"
2.22 cm

3/8"
0.95 cm

1/4"
0.64 cm

9/16"
1.43 cm

11/16"
1.75 cm

1 7/16"
3.65 cm

2 1/4"
5.72 cm

1 3/8"
3.49 cm

1 15/16"
4.92 cm

2 3/8"
6.03 cm

2 3/4"
6.99 cm

3"
7.62 cm

3 1/4"
8.62 cm

3 1/16"
7.78 cm

2 13/16"
7.14 cm

2 7/16"
6.19 cm

2"
5.08 cm

1 3/8"
3.49 cm

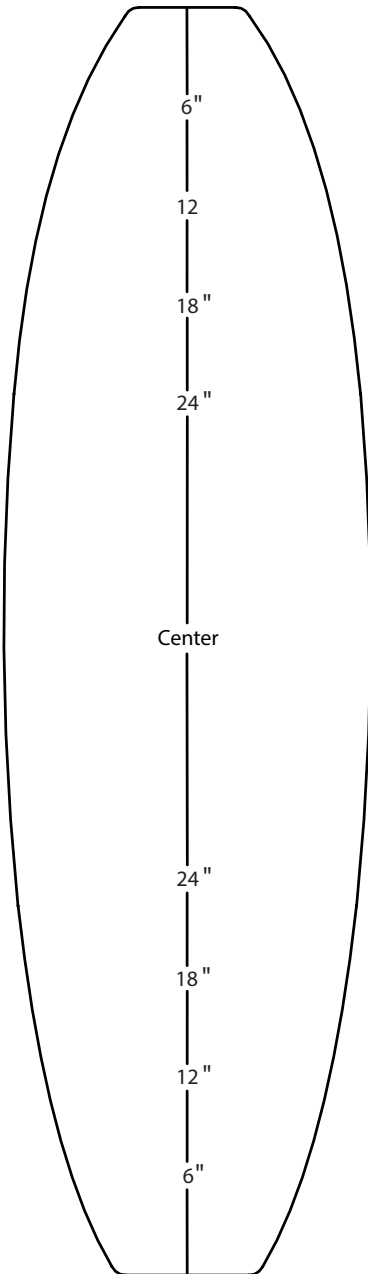

6 1/4"
15.88 cm

13 1/8"
33.34 cm

16 7/8"
42.86 cm

19 1/4"
48.90 cm

20 3/4"
52.71 cm

21 3/4"
55.25 cm

20 5/8"
52.39 cm

19 1/8"
48.58 cm

17"
43.18 cm

14"
35.56 cm

9 1/4"
23.50 cm

Overall Bottom Length: 6' 5 1/2" (196.85 cm)

Tip-to-tip Deck Length: 6' 4 3/4" (194.95 cm)

Maximum Width: 21 3/4" (55.25 cm)

Maximum Thickness: 3 1/4" (8.26 cm)

Displacement: 1.98 ft³ (56.0 L)

Introduced: April 2011

Available Rockers:

Designer Comments: This is the larger version of the 6'0" R. Designed to be a versatile blank for shorter, wider, relaxed rockered boards; somewhere between a fish and a performance short board. Plus volume under the chest. The semi-flat deck and thicker nose and tail provide a wide range of options.

Call (310) 225-6774 or visit www.usblanks.com



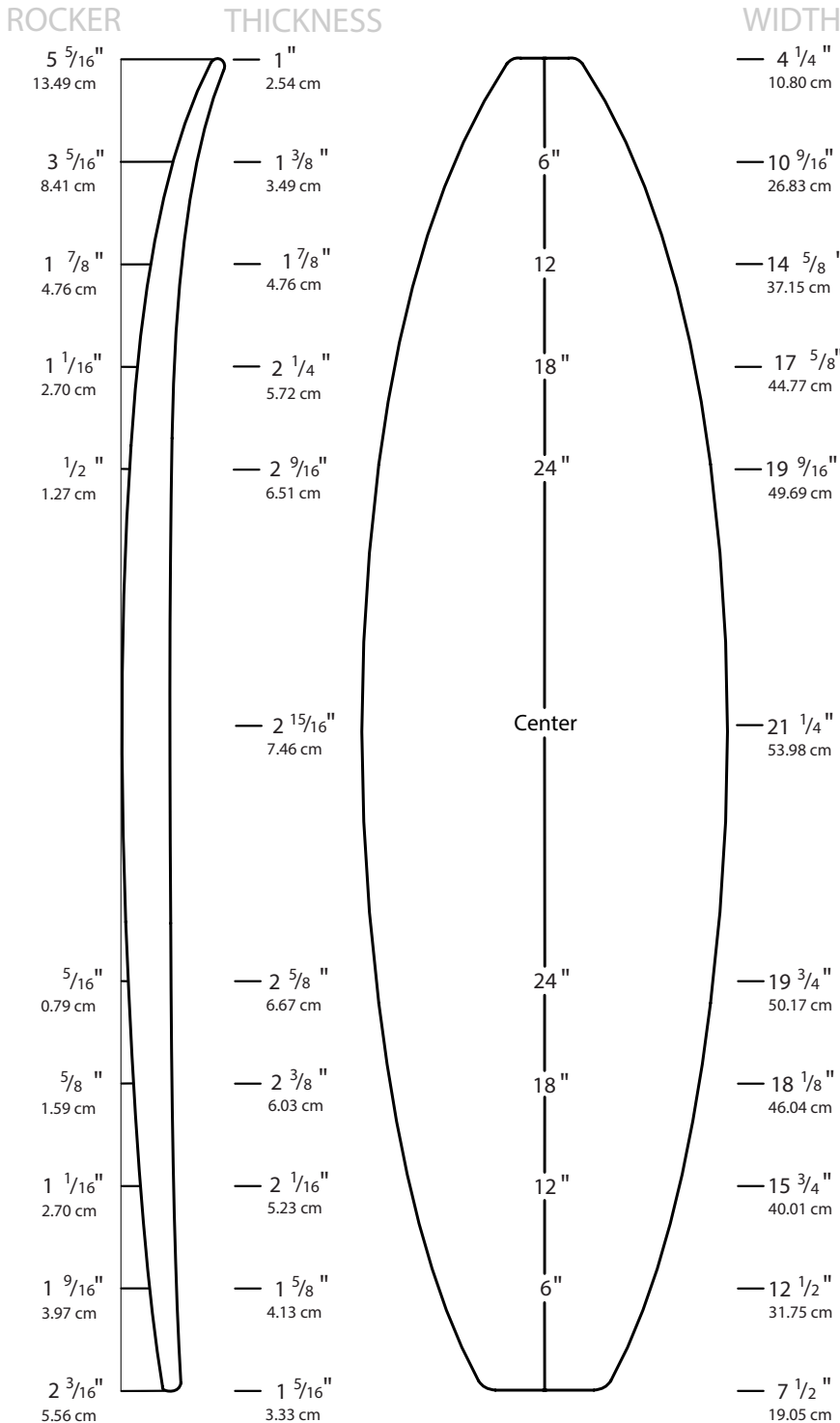

Overall Bottom Length: 6' 6 1/8" (198.44 cm)

Tip-to-tip Deck Length: 6' 5 3/8" (196.22 cm)

Maximum Width: 21 1/4" (53.98 cm)

Maximum Thickness: 2 15/16" (7.46 cm)

Displacement: 1.65 ft³ (46.7 L)

Introduced: July 2006

Available Rockers:

Designer Comments: This blank is intended for high-performance shortboard designs between 6'2" and 6'5" in length. It was designed in concert with the 6'4" EA and the 6'9" EA.

Call (310) 225-6774 or visit www.usblanks.com



ROCKER

THICKNESS

WIDTH

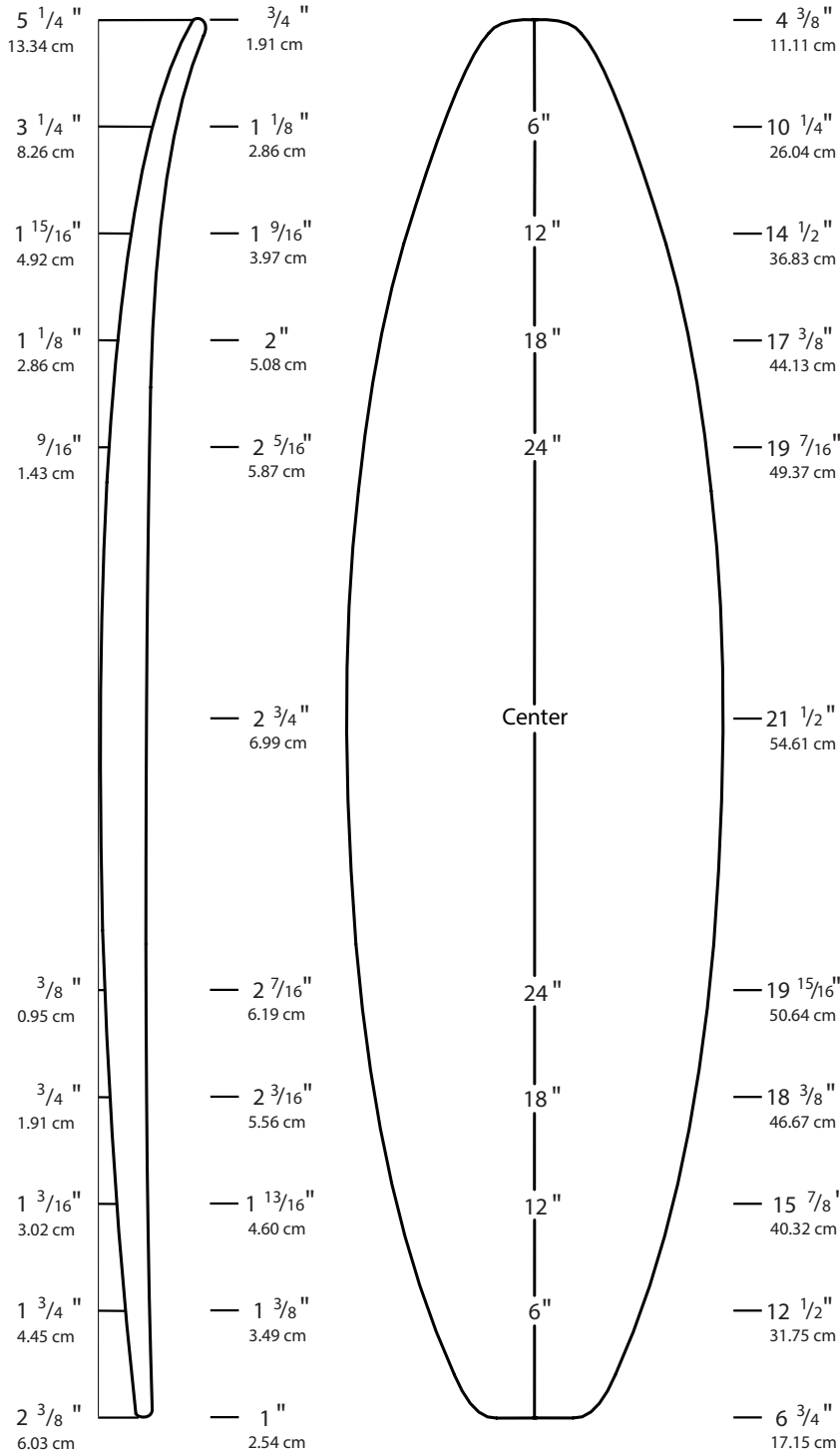

Overall Bottom Length: 6' 7 1/8" (200.66 cm)

Tip-to-tip Deck Length: 6' 6 1/2" (198.76 cm)

Maximum Width: 21 1/2" (54.61 cm)

Maximum Thickness: 2 3/4" (6.99 cm)

Displacement: 1.54 ft³ (43.6 L)

Introduced: July 2006

Available Rockers:

Designer Comments: Blank is designed for team boards and production shaping. It has a little more thickness in the nose and tail than the original 6'6"P. A medium tolerance blank.

Call (310) 225-6774 or visit www.usblanks.com



ROCKER

THICKNESS

WIDTH

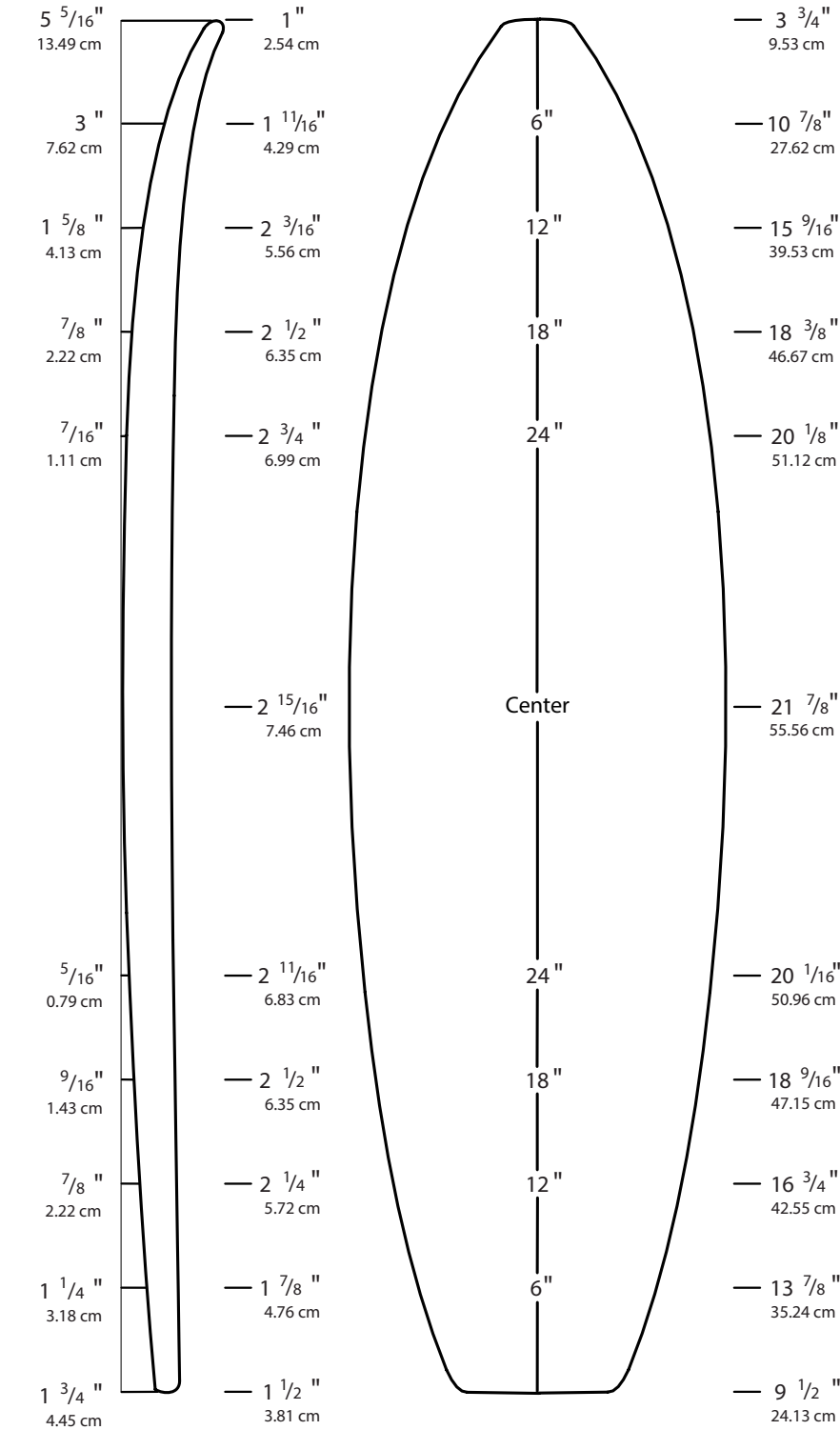

Overall Bottom Length: 6' 7 3/4" (202.57 cm)

Tip-to-tip Deck Length: 6' 7" (200.66 cm)

Maximum Width: 21 7/8" (55.56 cm)

Maximum Thickness: 2 15/16" (7.46 cm)

Displacement: 1.95 ft³ (55.3 L)

Introduced: July 2006

Available Rockers:

Designer Comments: I have listened to many shaper's feedback over the years with this blank. It nets a 6'6" bottom length. The slightly wider outline allows for board designs ranging from shortboard to fun shapes. The natural rocker is good for vee tail and contour nose type shapes. The Hawaii Rocker to be used for hi-performance styles.

(310) 225-6774 - USBlanks.com



6'8" AX

ROCKER

THICKNESS

WIDTH

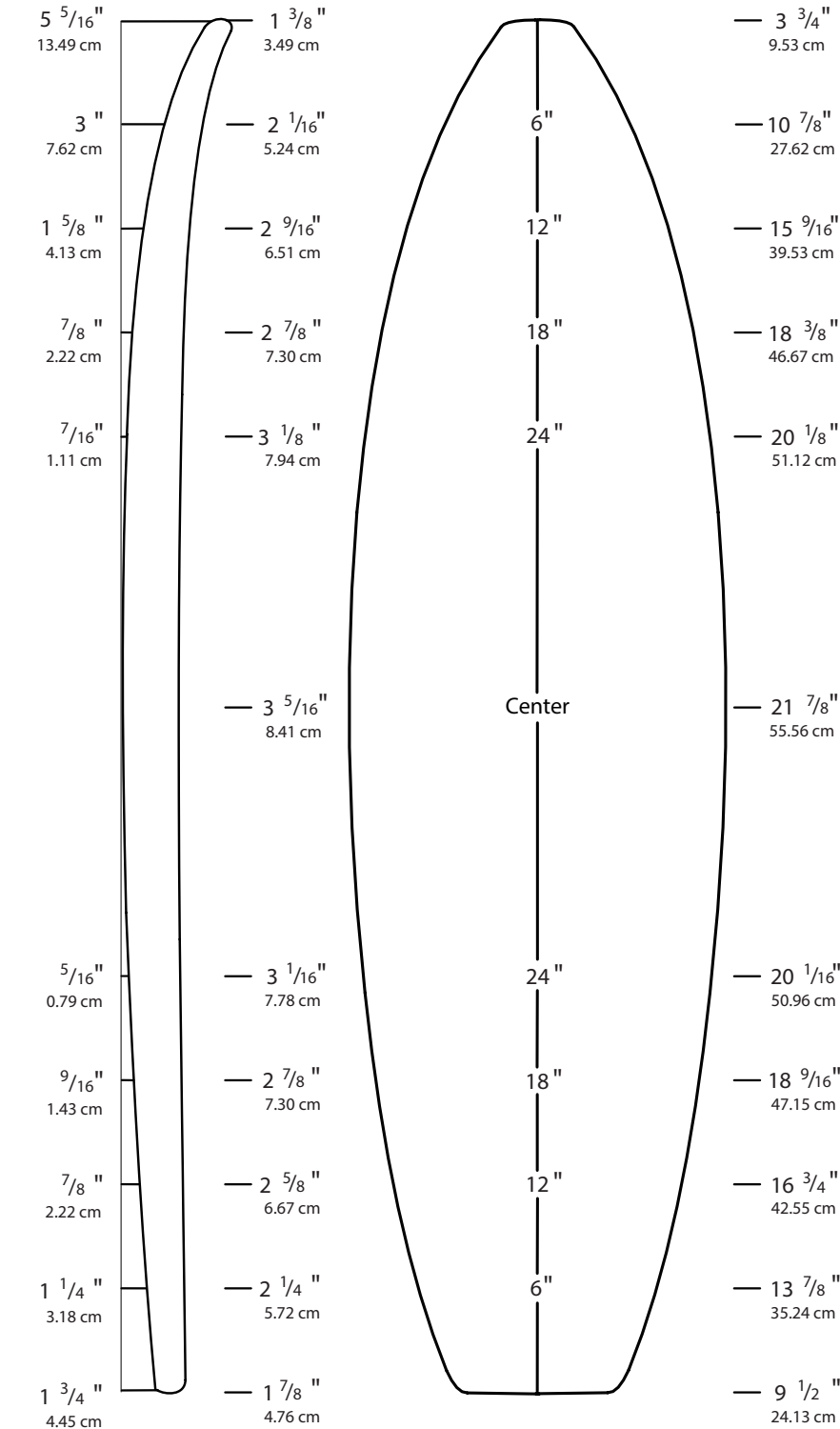

Overall Bottom Length: 6' 7 3/4" (202.57 cm)

Tip-to-tip Deck Length: 6' 7" (200.66 cm)

Maximum Width: 21 7/8" (55.56 cm)

Maximum Thickness: 3 5/16" (8.41 cm)

6'8A w/ 3/8" added thickness overall

Displacement: 2.24 ft³ (63.5 L)

Introduced: July 2006

Available Rockers:

Designer Comments: This is a 3/8" thicker version than the 6'8" A. I have listened to many shaper's feedback over the years with this blank. It nets a 6'6" bottom length. The slightly wider outline allows for board designs ranging from shortboard to fun shapes. The natural rocker is good for vee tail and contour nose type shapes. The Hawaii Rocker to be used for hi-performance styles.

Call (310) 225-6774 or visit www.usblanks.com



ROCKER

5 1/16" 12.86 cm
 3 1/16" 7.78 cm
 1 13/16" 4.60 cm
 1" 2.54 cm
 1/2" 1.27 cm

 3/8" 0.95 cm
 1 1/16" 1.75 cm
 1 1/8" 2.86 cm
 1 5/8" 4.13 cm
 2 3/16" 5.56 cm

THICKNESS

7/8" 2.22 cm
 1 3/16" 3.02 cm
 1 11/16" 1.69 cm
 2 1/16" 5.24 cm
 2 3/8" 6.03 cm

 2 3/4" 6.99 cm
 2 7/16" 6.19 cm
 2 3/16" 5.56 cm
 1 7/8" 4.76 cm
 1 1/2" 3.81 cm
 1" 2.54 cm

WIDTH

4 1/2" 11.43 cm
 10 1/2" 26.67 cm
 14 1/2" 36.83 cm
 17 1/4" 43.82 cm
 19 1/4" 48.90 cm

 21 3/8" 54.29 cm
 19 3/4" 50.17 cm
 18 3/16" 46.19 cm
 15 1/16" 39.85 cm
 12 1/16" 30.64 cm
 6 1/2" 16.51 cm

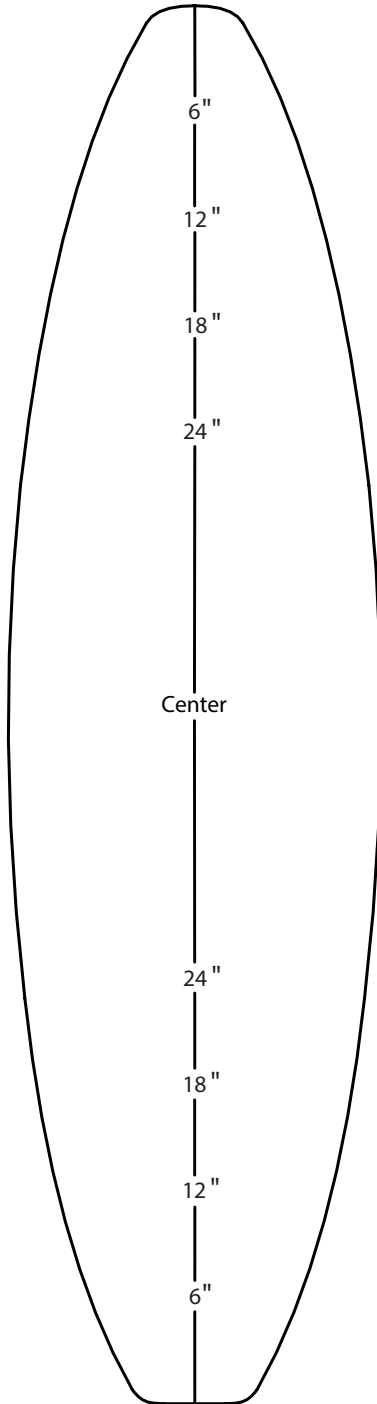

Overall Bottom Length: 6' 7 1/2" (201.93 cm)

Tip-to-tip Deck Length: 6' 6 3/4" (200.03 cm)

Maximum Width: 21 3/8" (54.29 cm)

Maximum Thickness: 2 3/4" (6.99 cm)

Displacement: 1.57 ft³ (44.4 L)

Introduced: July 2006

Available Rockers:

Designer Comments: Blank is designed for team boards and production shapers. Slightly narrower and longer than the 6'7" P, but with matching thicknesses. It's a medium tolerance blank.

Call (310) 225-6774 or visit www.usblanks.com



6'8" RP

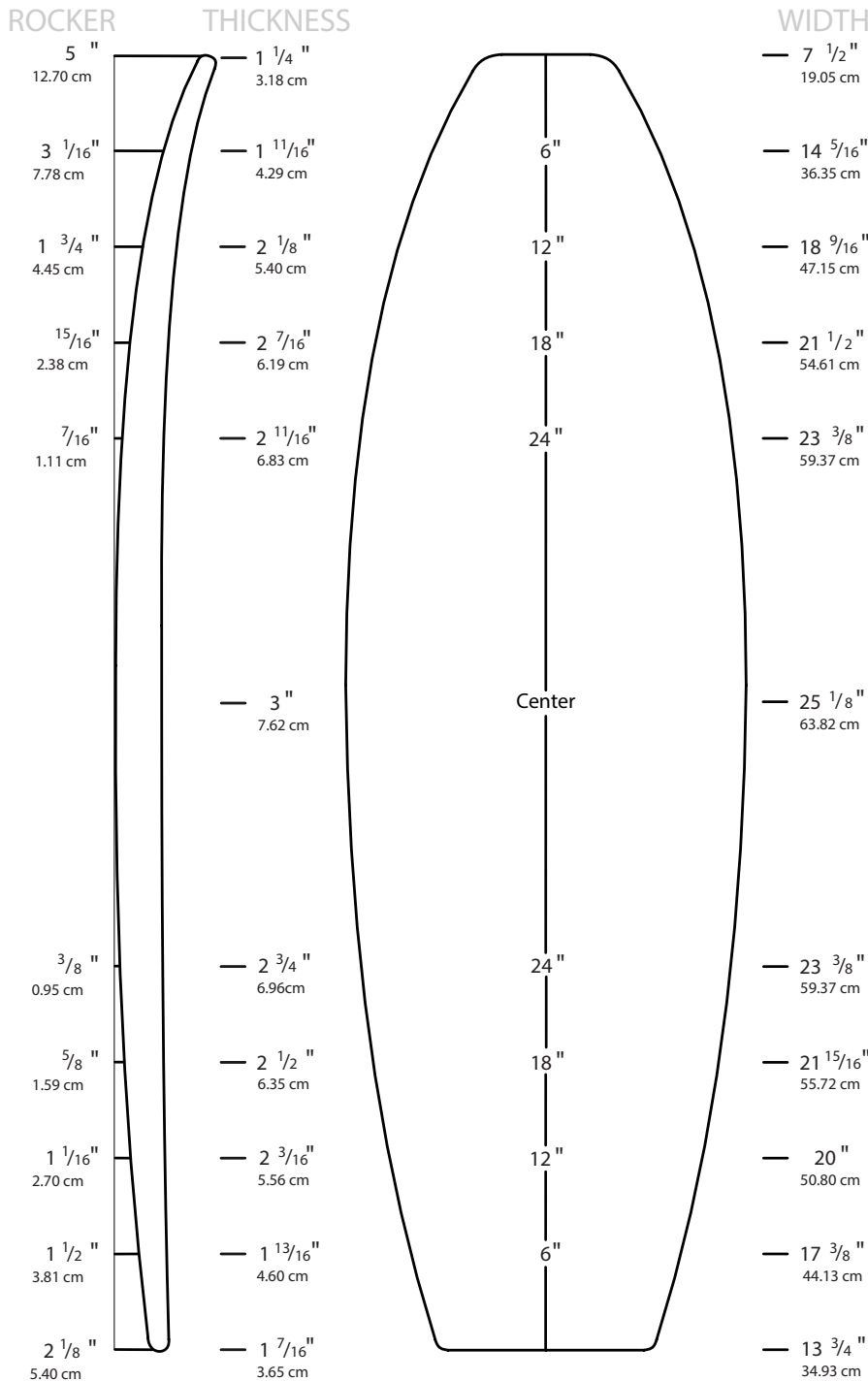

Overall Bottom Length: 6' 9 1/2" (207.01 cm)

Tip-to-tip Deck Length: 6' 8 3/4" (205.11 cm)

Maximum Width: 25 1/8" (63.82 cm)

Maximum Thickness: 3" (7.62 cm)

Displacement: 2.25 ft³ (63.8 L)

Introduced: November 2008

Available Rockers:

Designer Comments: Very versatile and designed with input from some of surfing's best designs minds, the 6'8"RP is influenced by a universal rocker with timeless profiles. This blank accommodates the trend to ride shorter, yet fuller volumed boards. It also provides enough volume for new levels of self expression for shapers and designers. It cleanly nets a 6'8" deck measurement with high performance rockers and thickness profiles. Excellent for contemporary Lis-Fish. Big brother to 5'10"RP. Modified and updated for machine use.

(310) 225-6774 - USBlanks.com



ROCKER

THICKNESS

WIDTH

5 9/16"
14.13 cm

3 7/16"
8.73 cm

2"
5.08 cm

1 1/8"
2.86 cm

9/16"
1.43 cm

7/16"
1.11 cm

3/4"
1.91 cm

1 3/16"
3.02 cm

1 3/4"
4.45 cm

2 1/2"
6.35 cm

15/16"
2.38 cm

1 3/8"
3.49 cm

1 7/8"
4.76 cm

2 3/16"
5.56 cm

2 1/2"
6.35 cm

2 15/16"
7.46 cm

2 5/8"
6.67 cm

2 3/8"
6.03 cm

2"
5.08 cm

1 5/8"
4.13 cm

1 1/8"
2.86 cm

6"

12"

18"

24"

Center

24"

18"

12"

6"

4"
10.16 cm

10 1/8"
25.72 cm

14 1/8"
35.88 cm

17 1/16"
43.34 cm

19 1/8"
48.58 cm

21 5/16"
54.13 cm

19 9/16"
49.69 cm

17 7/8"
45.40 cm

15 5/8"
39.69 cm

12 3/8"
31.43 cm

7"
17.78 cm

Overall Bottom Length: 6' 9" (205.74 cm)

Tip-to-tip Deck Length: 6' 8" (203.20 cm)

Maximum Width: 21 5/16" (54.13 cm)

Maximum Thickness: 2 15/16" (7.46 cm)

Displacement: 1.71 ft³ (48.3 L)

Introduced: July 2006

Available Rockers:

Designer Comments: This blank is designed to yield most modern short board designs. The thicker nose and tail give it added versatility for machining. I designed the rocker and foil to accommodate low and full rocker designs.

Call (310) 225-6774 or visit www.usblanks.com



ROCKER

THICKNESS

WIDTH

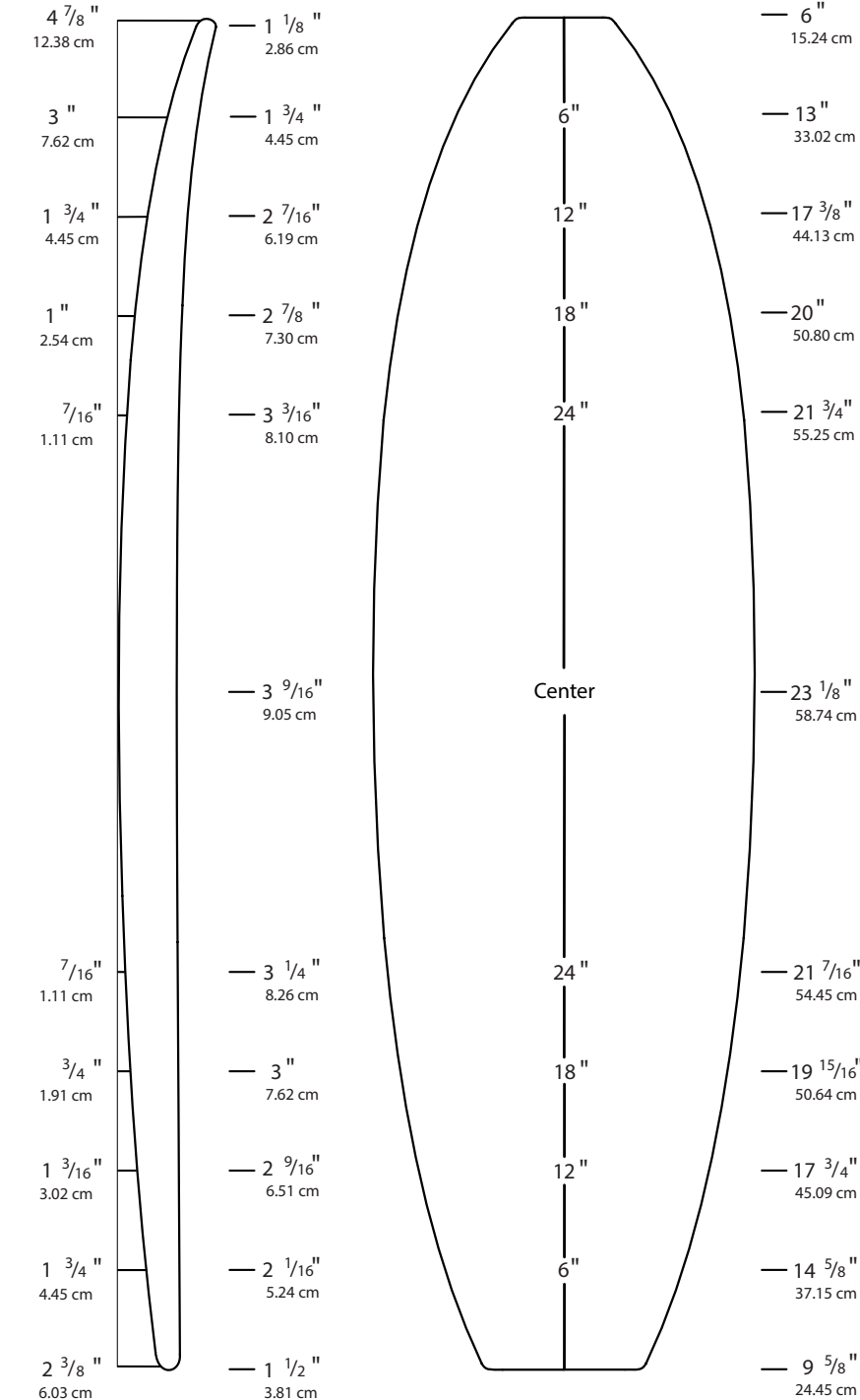

Overall Bottom Length: 6' 10 1/4" (208.92 cm)

Tip-to-tip Deck Length: 6' 9 5/8" (207.33 cm)

Maximum Width: 23 1/8" (58.74 cm)

Maximum Thickness: 3 9/16" (9.05 cm)

Displacement: 2.406 ft³ (68.1 L)

Introduced: October 2014

Available Rockers:

Designer Comments: The big brother to the 6'5" R to cover models in the upper size range. Designed to be a versatile blank for shorter, wider, relaxed rockered boards; somewhere between a fish and a performance short board. Plus volume under the chest. The semi-flat deck and thicker nose and tail provide a wide range of options.

Call (310) 225-6774 or visit www.usblanks.com



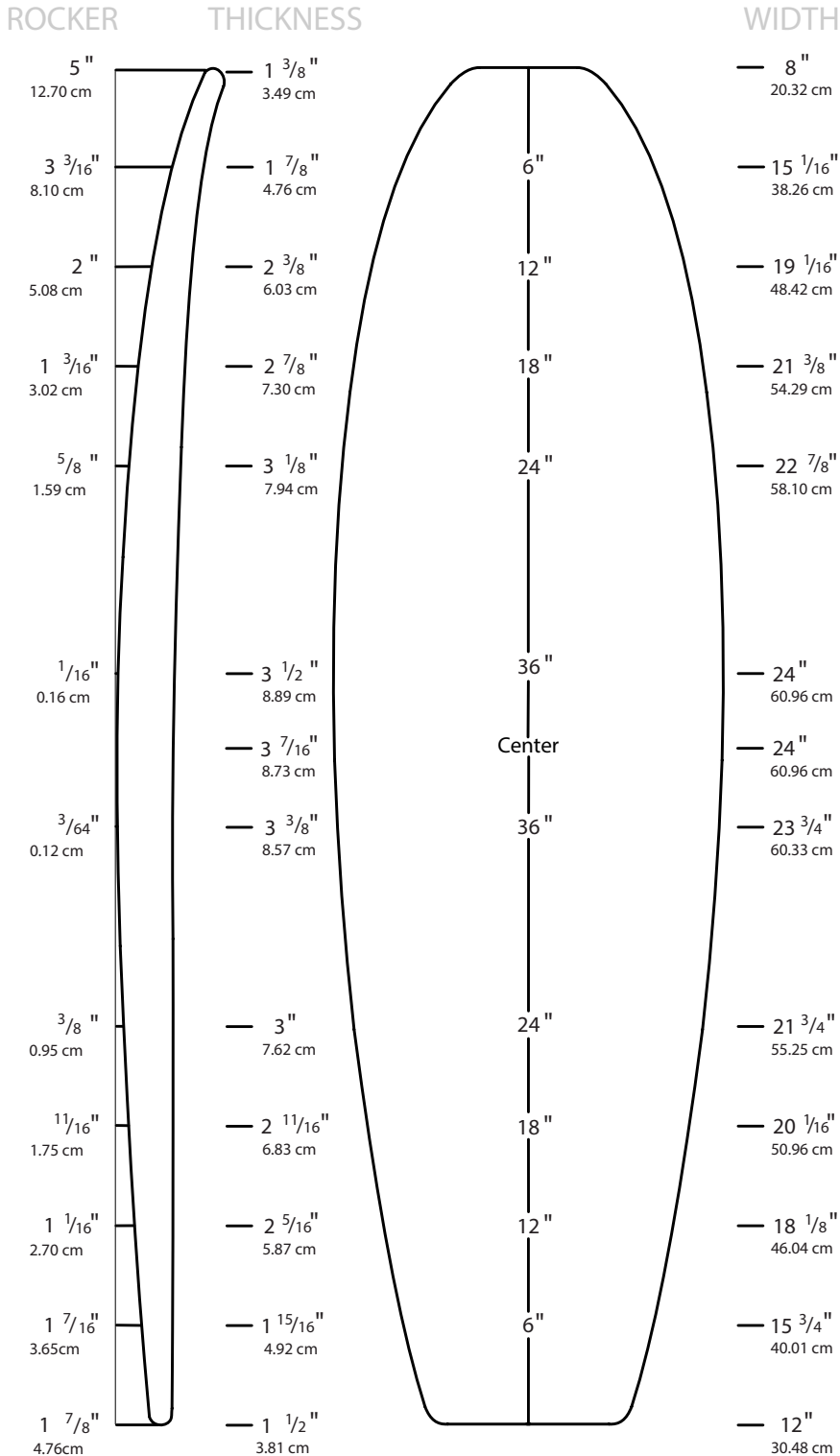

Overall Bottom Length: 6' 10" (208.28 cm)

Tip-to-tip Deck Length: 6' 9 1/2" (207.01 cm)

Maximum Width: 24" (60.96 cm)

Maximum Thickness: 3 1/2" (8.89 cm)

Displacement: 2.52 ft³ (71.4 L)

Introduced: July 2006

Available Rockers:

Designer Comments: This is my big guy fish blank, designed to be able to easily net a 6'9" by the bottom measurement for 6'5 to 6'9 length contemporary or Retro fish (or single fin) design.

Call (310) 225-6774 or visit www.usblanks.com



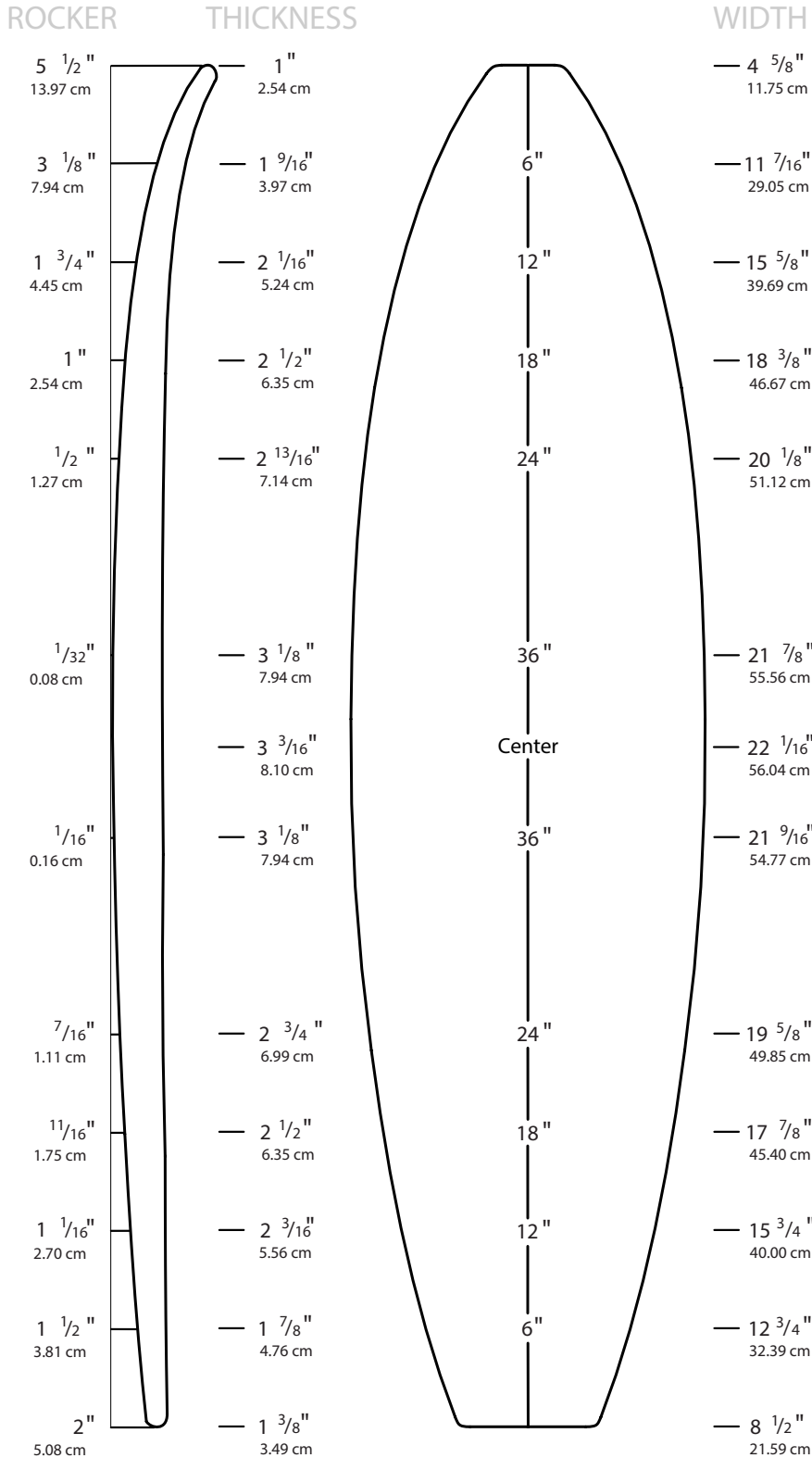

Overall Bottom Length: 6' 11 1/2" (212.09 cm)

Tip-to-tip Deck Length: 6' 10 3/4" (210.19 cm)

Maximum Width: 22 1/8" (56.20 cm)

Maximum Thickness: 3 3/16" (8.10 cm)

Displacement: 2.12 ft³ (60.0 L)

Introduced: July 2006

Available Rockers:

Designer Comments: The slightly wider outline allows for board designs ranging from bigger guy short boards to fun shapes. The natural rocker is good for vee in the tail and contoured bottom designs. The Hawaii Rocker to be used for hi-performance styles.

Call (310) 225-6774 or visit www.usblanks.com



USBlanks™

MADE IN AMERICA

7'1" A

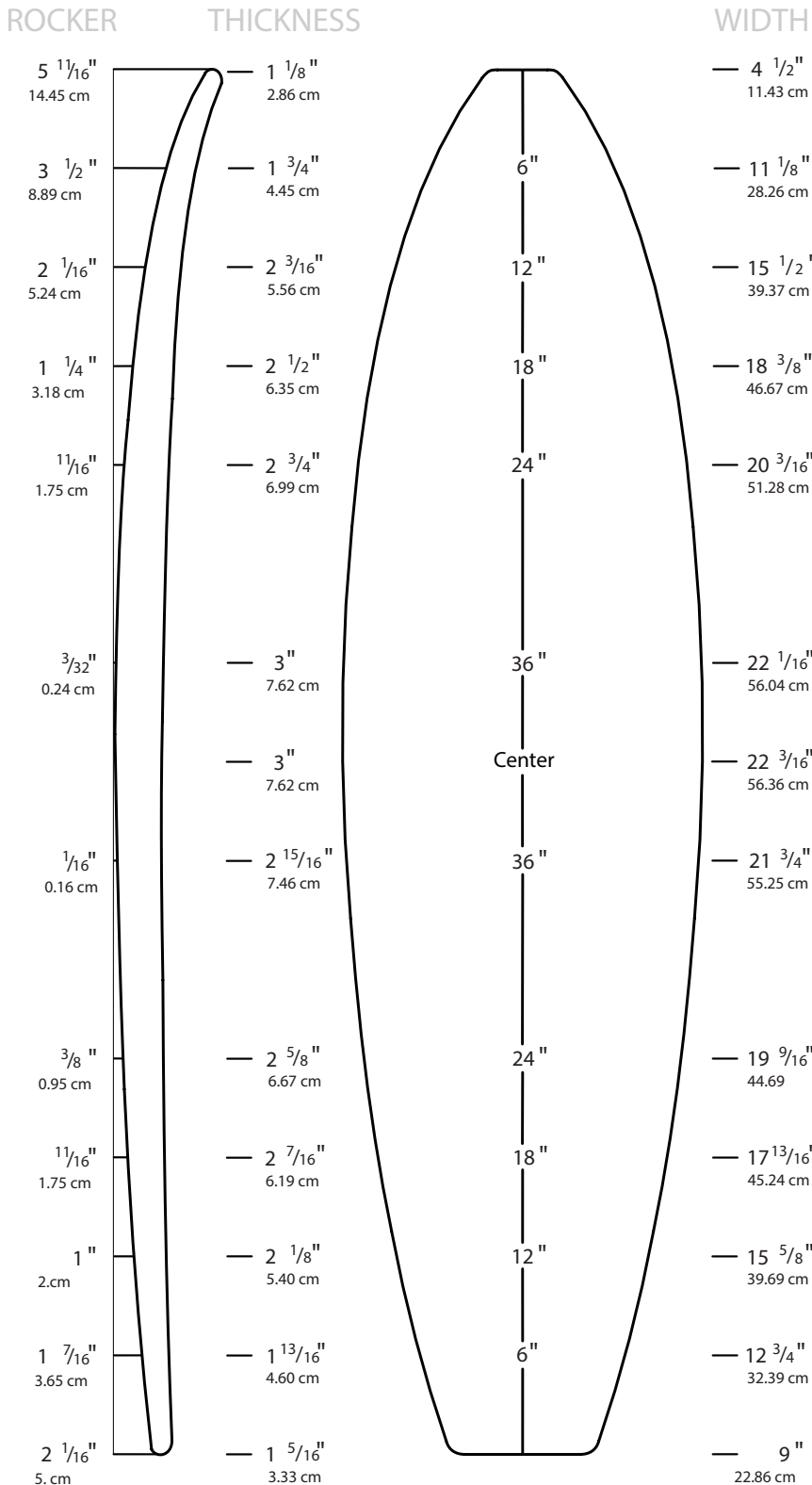

Overall Bottom Length: 7' 0 7/8" (215.58 cm)

Tip-to-tip Deck Length: 6' 11" (213.04 cm)

Maximum Width: 22 3/16" (56.36 cm)

Maximum Thickness: 3" (7.62 cm)

Displacement: 2.05 ft³ (58.1 L)

Introduced: July 2006

Available Rockers:

Designer Comments: About 3/16" thinner than the 7'0" A, this can net a 6'11" bottom length. The natural rocker is good for vee in the tail and contoured bottom designs. The Hawaii Rocker to be used for hi-performance styles. I personally like the 7'2" EA bottom curve glued up with this one for a flatter deck design.

Call (310) 225-6774 or visit www.usblanks.com



Designed by: **Pat Rawson**

ROCKER

THICKNESS

WIDTH

5 3/8" 13.65 cm
 3 5/16" 8.41 cm
 1 15/16" 4.92 cm
 1 1/8" 2.86 cm
 9/16" 1.43 cm
 1/32" 0.08 cm
 1/16" 0.16 cm
 5/16" 0.79 cm
 5/8" 1.59 cm
 1" 2.54 cm
 1 1/2" 3.81 cm
 2 1/4" 5.72 cm

7/8" 2.22 cm
 1 1/2" 3.49 cm
 2" 5.08 cm
 2 3/8" 6.03 cm
 2 11/16" 6.83 cm
 2 15/16" 7.46 cm
 3" 7.62 cm
 2 15/16" 7.46 cm
 2 11/16" 6.83 cm
 2 7/16" 6.19 cm
 2 1/8" 5.40 cm
 1 5/8" 4.13 cm
 1" 2.54 cm

6"
 12"
 18"
 24"
 36"
 Center
 36"
 24"
 18"
 12"
 6"

3 1/4" 8.26 cm
 11 1/8" 28.26 cm
 15 3/4" 40.01 cm
 18 5/8" 47.31 cm
 20 7/16" 51.91 cm
 22 5/16" 56.67 cm
 22 9/16" 57.31 cm
 22 5/16" 56.67 cm
 20 1/2" 52.07 cm
 18 11/16" 47.47 cm
 16 1/4" 41.28 cm
 12 7/16" 31.59 cm
 6" 15.24 cm

Overall Bottom Length: 7' 0 1/2" (214.63 cm)

Tip-to-tip Deck Length: 6' 11 3/4" (212.73 cm)

Maximum Width: 22 9/16" (57.31 cm)

Maximum Thickness: 3" (7.62 cm)

Displacement: 1.93 ft³ (54.6 L)

Introduced: July 2006

Available Rockers:

Designer Comments: This is primarily designed for making fun boards. It comes with a moderate but continuous even rocker and foil to make "positioning" the blank for the shape process easy. This is the shorter version of the 7'6" EA.

Call (310) 225-6774 or visit www.usblanks.com



USBlanks™

MADE IN AMERICA

7'2"EA

ROCKER

THICKNESS

WIDTH

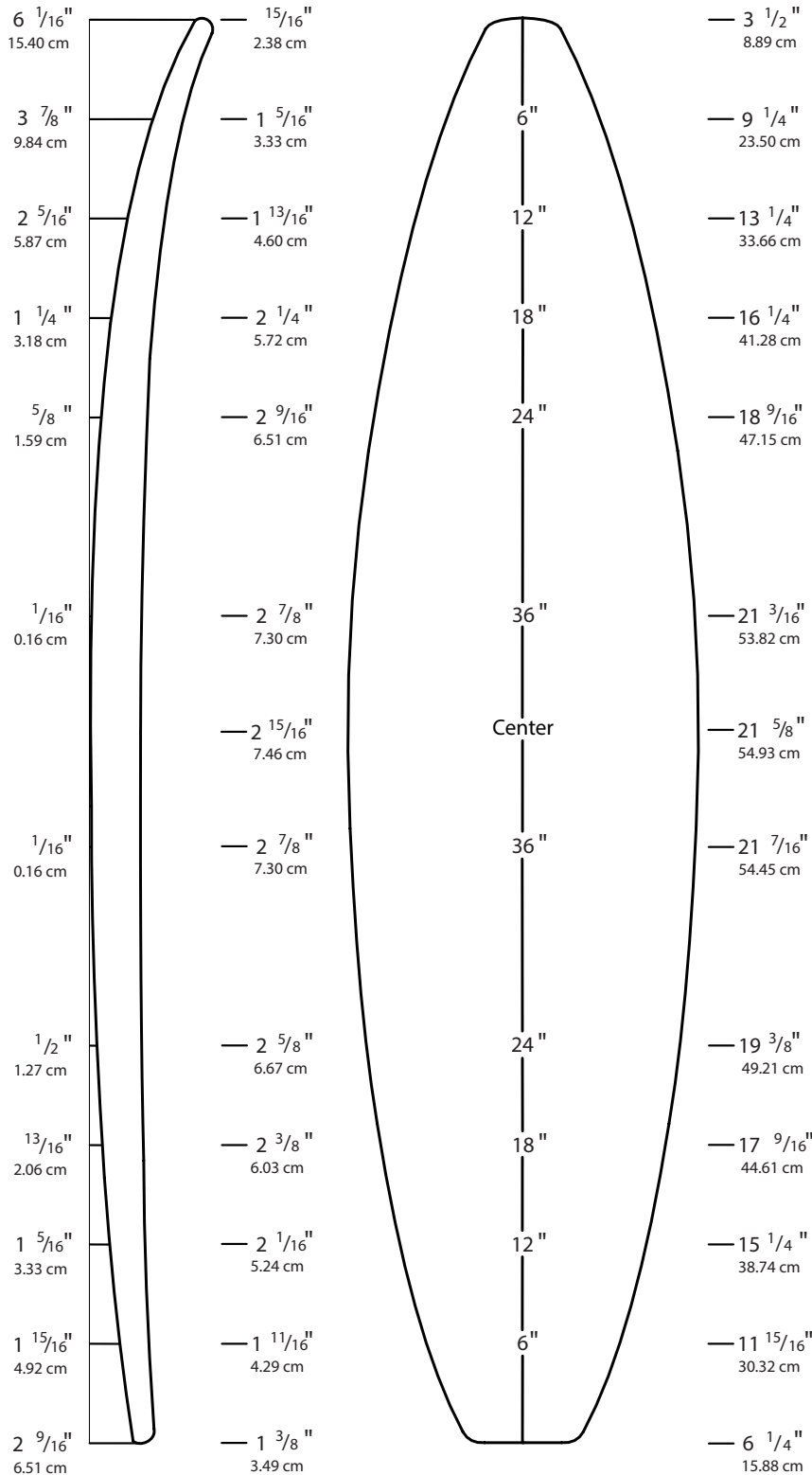

Overall Bottom Length: 7' 2 1/2" (219.71 cm)

Tip-to-tip Deck Length: 7' 1 7/8" (218.12 cm)

Maximum Width: 21 5/8" (54.93 cm)

Maximum Thickness: 2 15/16" (7.46 cm)

Displacement: 1.89 ft³ (53.4 L)

Introduced: April 2007

Available Rockers:

Designer Comments: This blank is a versatile high performance semi-gun which was designed in series with the 7'8"EA. The rocker and foil will accommodate a wide variety of bottom contours.

Call (310) 225-6774 or visit www.usblanks.com



Designed by: **Eric Arakawa**

USBlanks™

MADE IN AMERICA

7'3"A

ROCKER

THICKNESS

WIDTH

Overall Bottom Length: 7' 2 7/8" (220.66 cm)

Tip-to-tip Deck Length: 7' 2 3/8" (219.39 cm)

Maximum Width: 24" (60.96 cm)

Maximum Thickness: 3 5/8" (9.21 cm)

Displacement: 2.74 ft³ (77.7 L)

Introduced: July 2006

Available Rockers:

Designer Comments: This is my enlarged version of the 6'10"A fish blank. I designed this one as to be able to easily net a 7'1" by the bottom measurement. Should net 6'9 to 7'1 length for contemporary or Retro fish (or single fin) designs.

Call (310) 225-6774 or visit www.usblanks.com

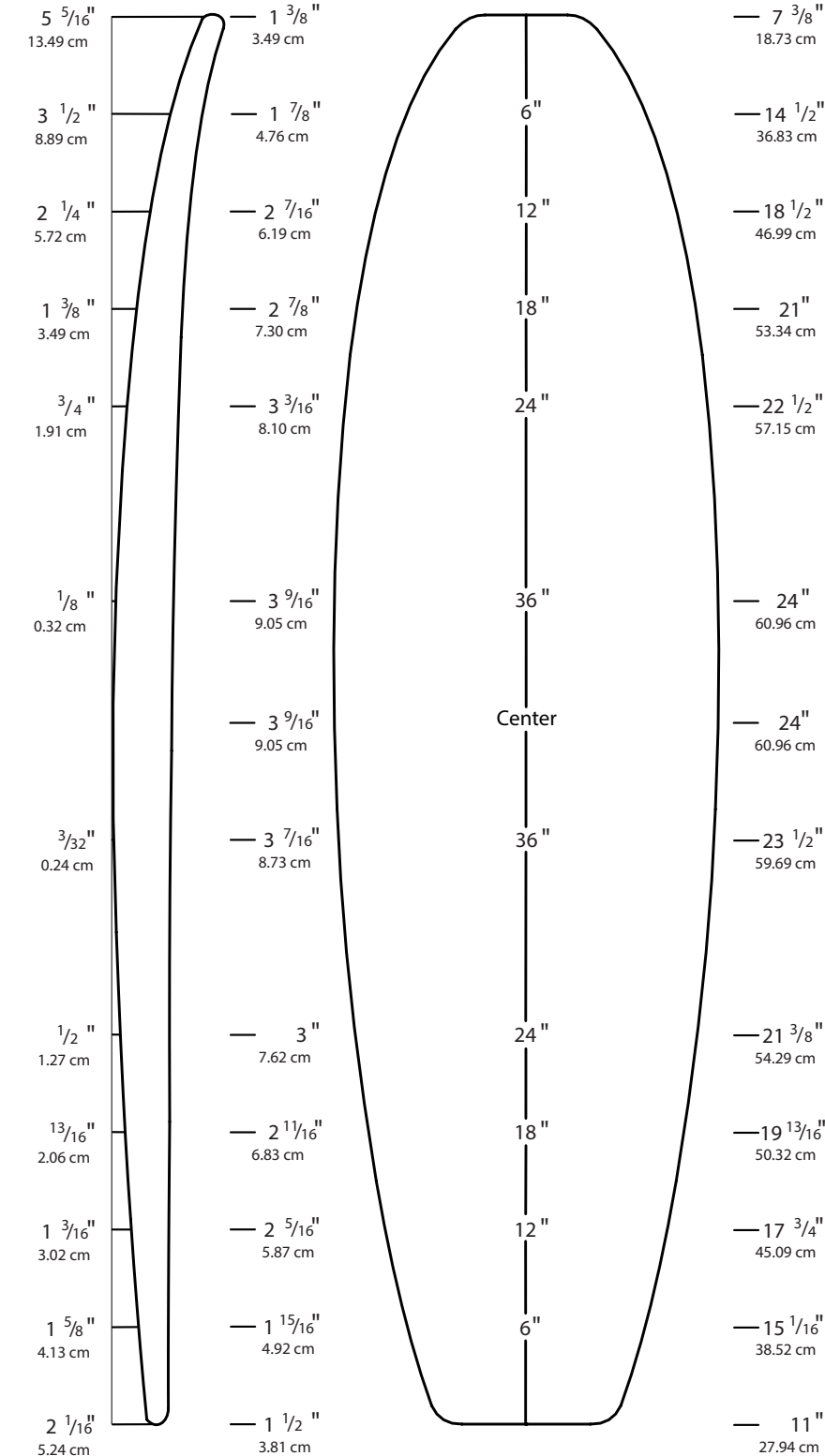

Designed by: **Pat Rawson**

7'4" SP

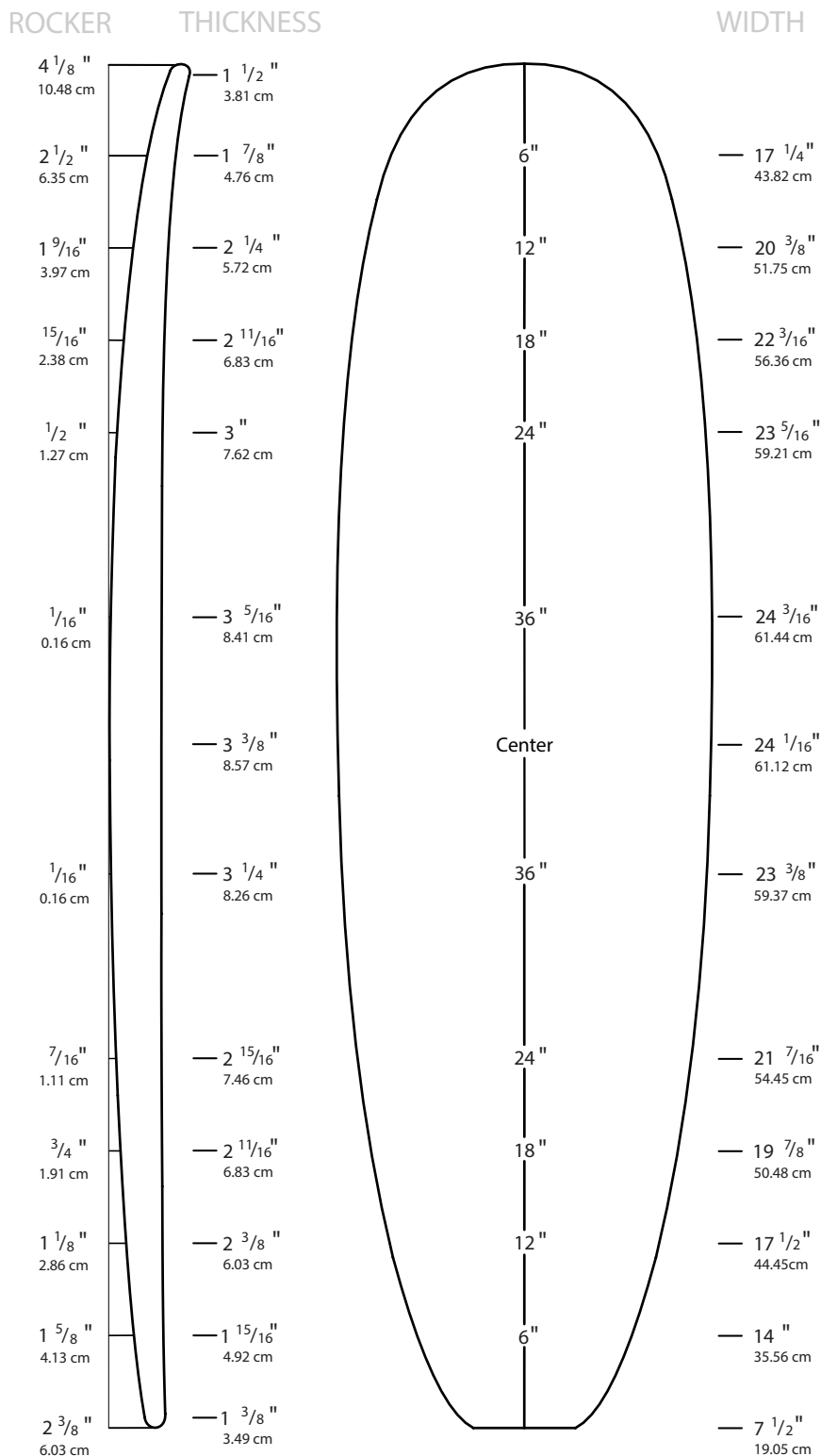

Overall Bottom Length: 7' 5 11/16" (227.81 cm)

Tip-to-tip Deck Length: 7' 4 3/4" (225.43 cm)

Maximum Width: 24 3/16" (61.44 cm)

Maximum Thickness: 3 3/8" (8.57 cm)

Displacement: 2.723 cubic feet (77.1 L)

Introduced: June 2014

Available Rockers:

Designer Comments: The 7'4" SP and the 7'10" SP were built together on Maui and are similar to the 8'4" SP, offering a more complete size progression for mini longboards. The outlines of both were widened relative to the 8'4" SP to make them usable for a broader range of designs. Natural rocker is fairly neutral in both the nose and tail, with enough thickness to shape them up or down, according to the shaper's preference. Ideal for boards in the 6'10" to 7'4" range.

Call (310) 225-6774 or visit www.usblanks.com



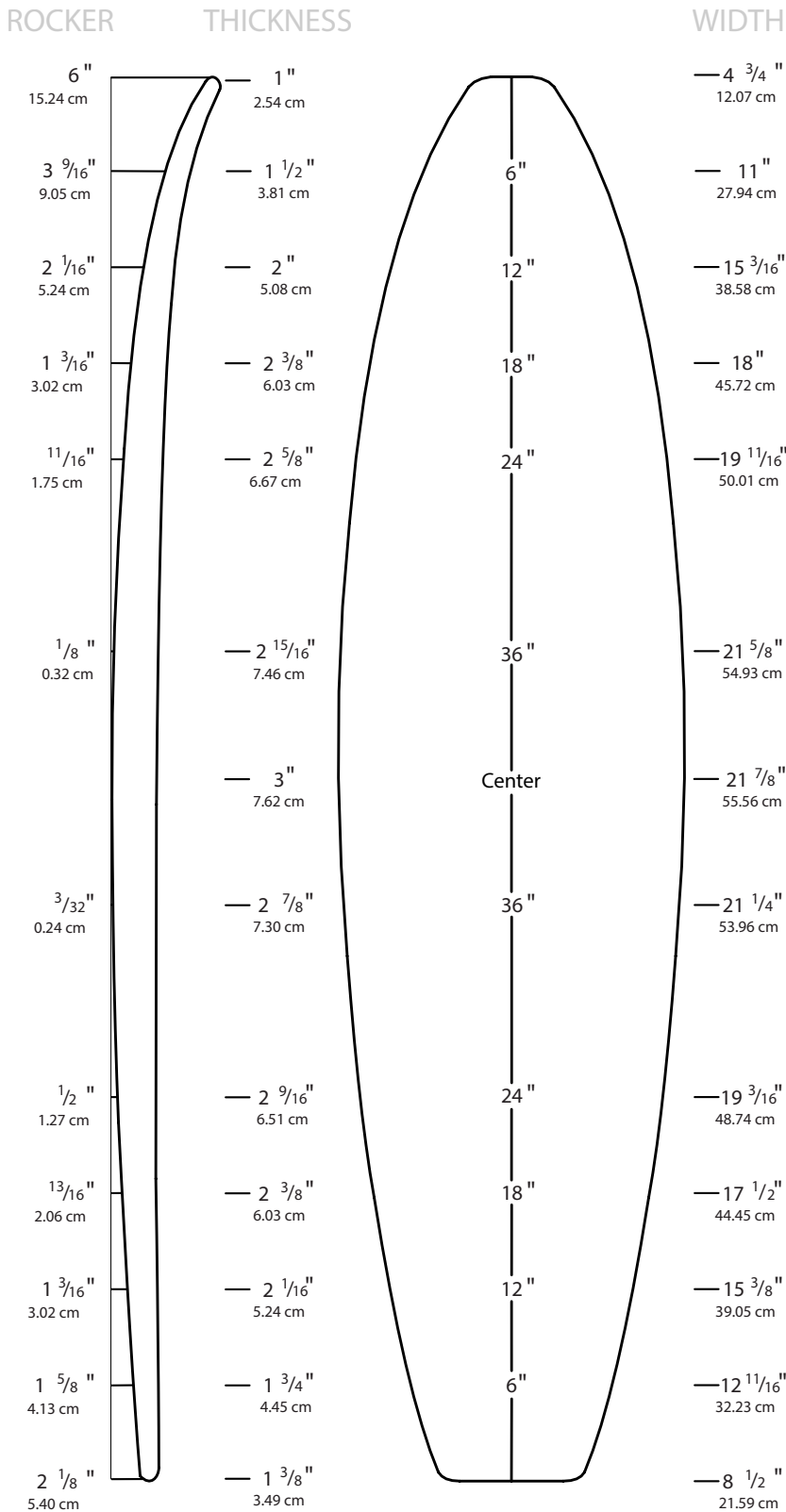

Overall Bottom Length: 7' 4 1/2" (224.79 cm)

Tip-to-tip Deck Length: 7' 3 7/16" (222.09 cm)

Maximum Width: 21 7/8" (55.56 cm)

Maximum Thickness: 3" (7.62 cm)

Displacement: 2.13 ft³ (60.2 L)

Introduced: July 2006

Available Rockers:

Designer Comments: Will net 7'3" bottom length. The natural rocker is good for vee in the tail and contoured bottom designs. The Hawaii Rocker to be used for hi-performance styles. I personally like the 7'2EA bottom extended curve glued up with this one for a flatter deck design.

Call (310) 225-6774 or visit www.usblanks.com



USBlanks™

MADE IN AMERICA

7'6" EA

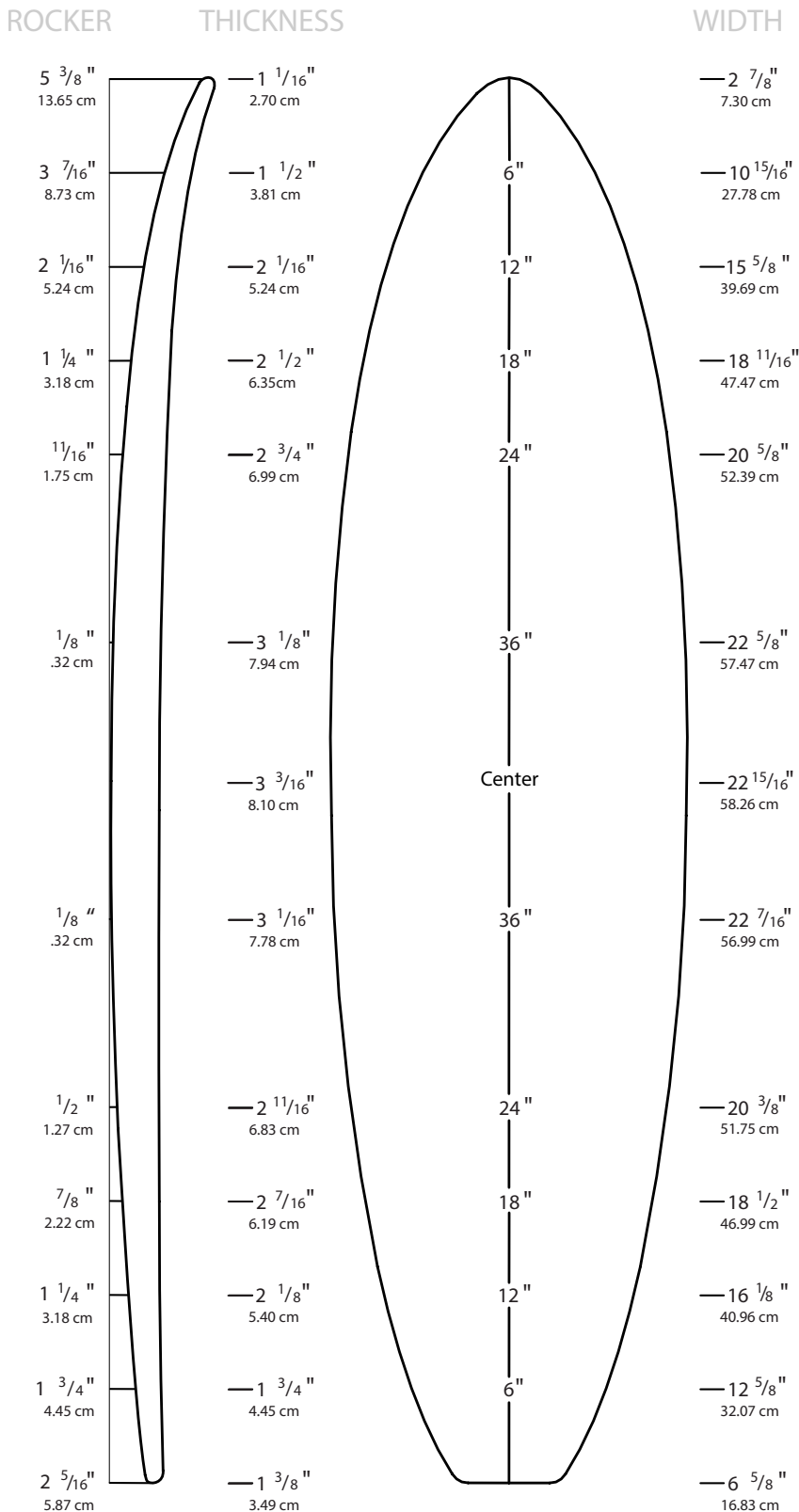

Overall Bottom Length: 7' 6" (228.60 cm)

Tip-to-tip Deck Length: 7' 5 3/8" (227.01 cm)

Maximum Width: 23" (58.42 cm)

Maximum Thickness: 3 3/16" (8.10 cm)

Displacement: 2.28 ft³ (64.6 L)

Introduced: July 2006

Available Rockers:

Designer Comments: This is primarily designed for making funboards. It comes with a moderate but continuous even rocker and foil to make "positioning" the blank for the shape process easy. The deck contour tapers to keep the foam harder on the rail on the finished shape. It's a longer version of the 7'1" EA.

Call (310) 225-6774 or visit www.usblanks.com



Designed by: **Eric Arakawa**

USBlanks™

MADE IN AMERICA

7'7" A

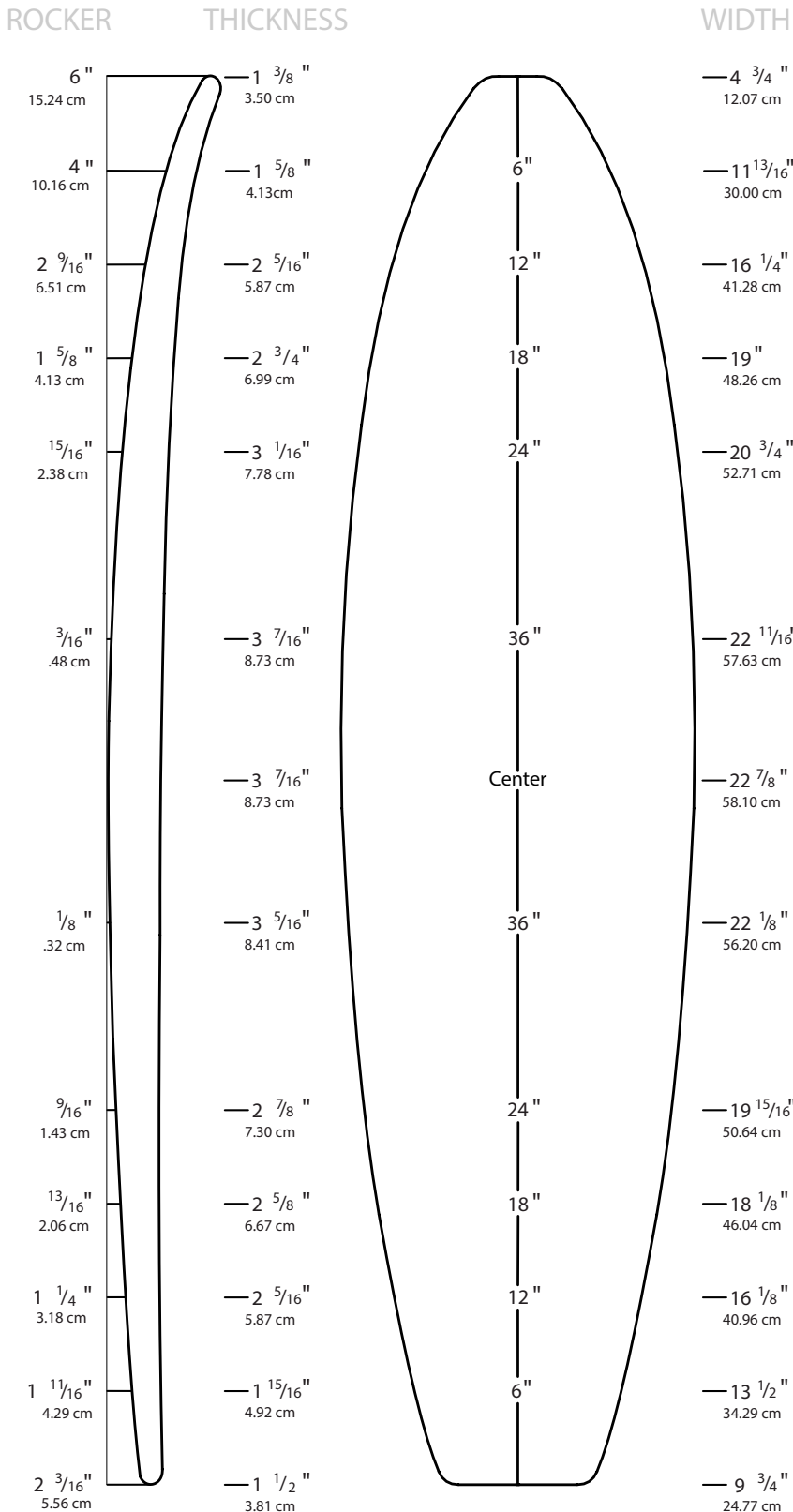

Overall Bottom Length: 7' 6 5/8" (230.19 cm)

Tip-to-tip Deck Length: 7' 6" (228.60 cm)

Maximum Width: 22 7/8" (58.10 cm)

Maximum Thickness: 3 7/16" (8.73 cm)

Displacement: 2.63 ft³ (74.6 L)

Introduced: July 2006

Available Rockers:

Designer Comments: The thicker 7'7" A blank easily nets a 7'5" bottom length. The natural rocker is good for vee in the tail and contoured bottom designs. The Hawaii Rocker to be used for hi-performance styles. I personally like the 7'8EA bottom curve (Hawaii Rocker) glued up with this one for a flatter deck design for a bigger rider.

Call (310) 225-6774 or visit www.usblanks.com



Designed by: **Pat Rawson**

USBlanks™

MADE IN AMERICA

7'8" EA

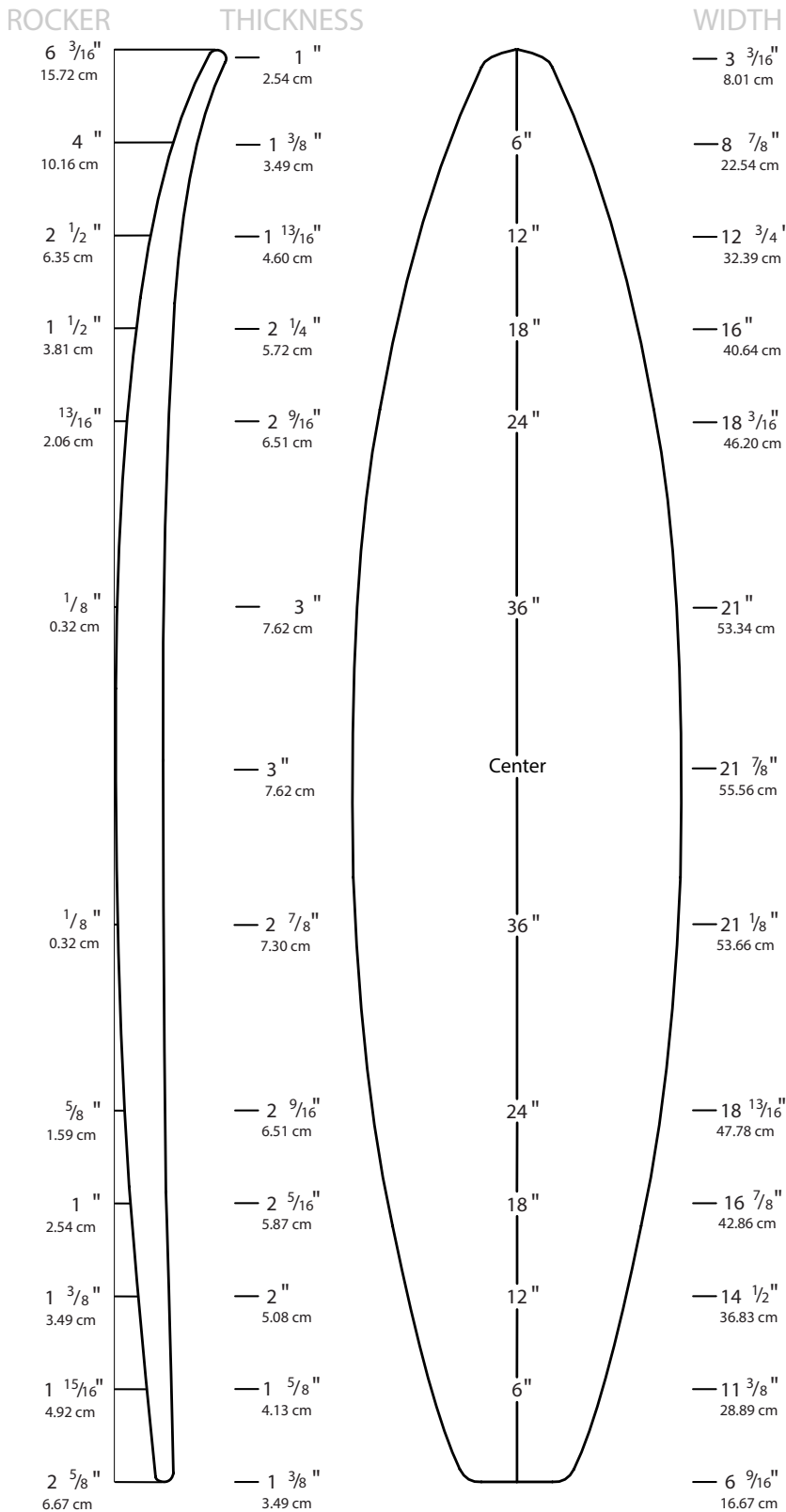

Overall Bottom Length: 7' 9" (236.22 cm)

Tip-to-tip Deck Length: 7' 8 3/16" (234.16 cm)

Maximum Width: 21 7/8" (55.56 cm)

Maximum Thickness: 3" (7.62 cm)

Displacement: 2.03 ft³ (57.5 L)

Introduced: June 2007

Available Rockers:

Designer Comments: Designed in series with the 7'2" EA to yield guns in the 7'0" to 7'7" range. This blank is a versatile high performance semi-gun. The rocker and foil will accommodate a wide variety of bottom contours.

Call (310) 225-6774 or visit www.usblanks.com



Designed by: **Eric Arakawa**

USBlanks™

MADE IN AMERICA

7'9"H

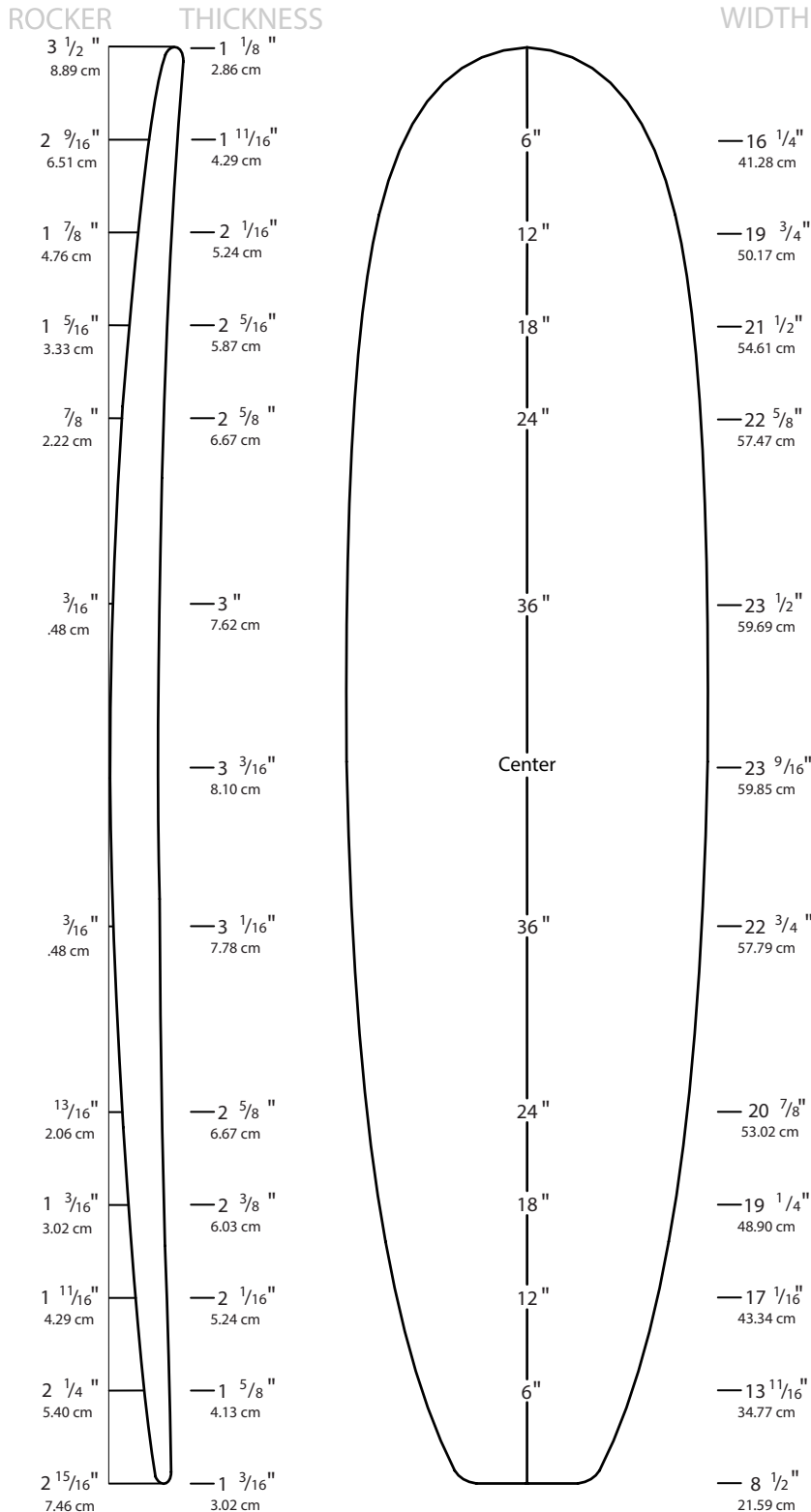

Overall Bottom Length: 7' 8 5/8" (235.27 cm)

Tip-to-tip Deck Length: 7' 8 3/8" (234.63 cm)

Maximum Width: 23 9/16" (59.85 cm)

Maximum Thickness: 3 3/16" (8.10 cm)

Displacement: 2.51 ft³ (71.2 L)

Introduced: July 2006

Available Rockers:

Designer Comments: Designed for retro funshapes. Based on feedback from 7'11"H and 8'4"H, improvements were made in the thickness and foil. Should accommodate many rockers and be an easy hand or machine shape blank.

Call (310) 225-6774 or visit www.usblanks.com



Designed by: **Roger Hinds**

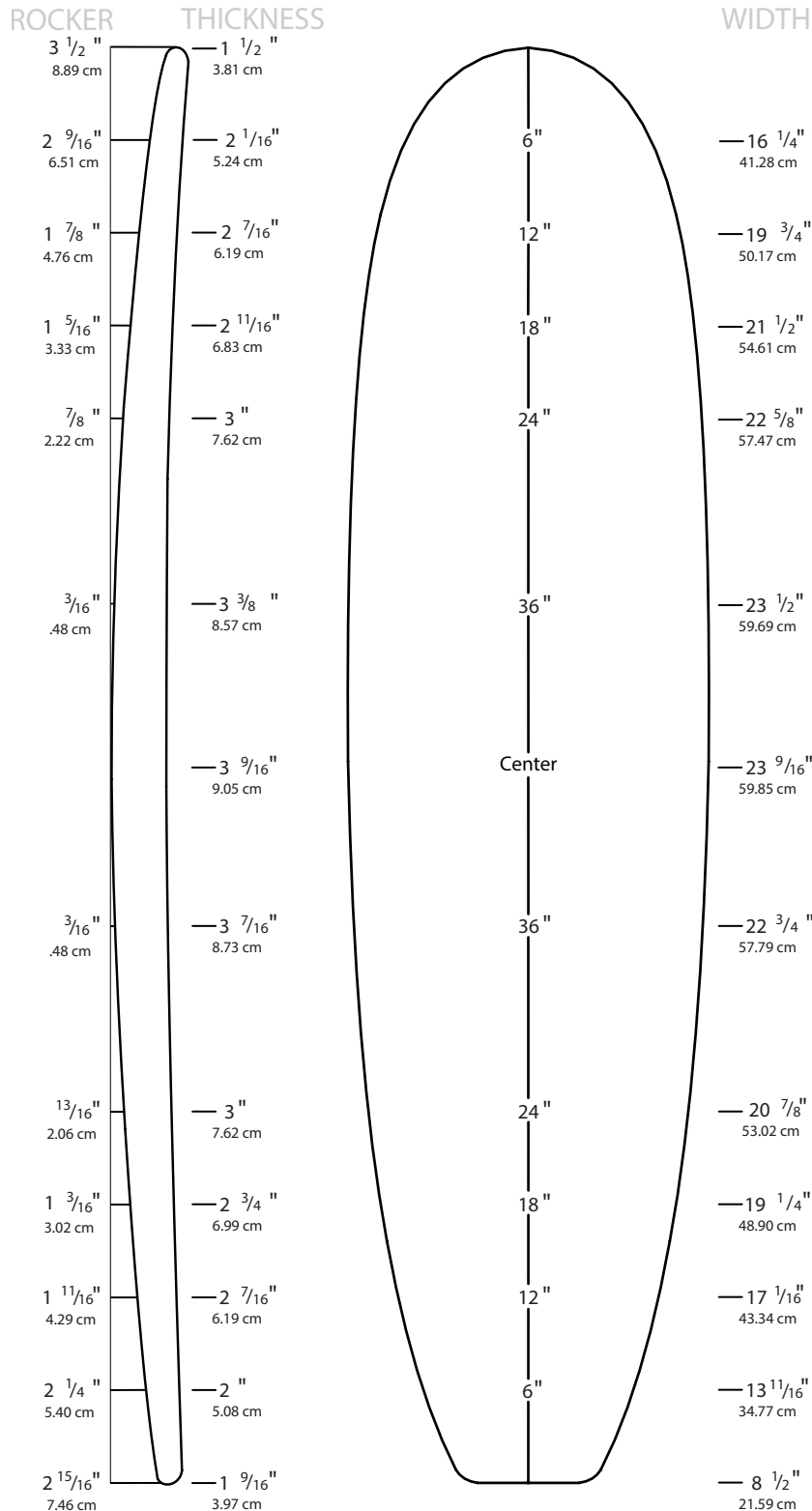

Overall Bottom Length: 7' 8 5/8" (235.27 cm)

Tip-to-tip Deck Length: 7' 8 3/8" (234.63 cm)

Maximum Width: 23 9/16" (59.85 cm)

Maximum Thickness: 3 9/16" (9.05 cm)

7'9H w/ 3/8" added thickness overall

Displacement: 2.86 ft³ (81.0 L)

Introduced: July 2006

Available Rockers:

Designer Comments: This is a 3/8" thicker version of the 7'9" H. Designed for retro funshapes. Based on feedback from 7'11"H and 8'4"H, improvements were made in the thickness and foil. Should accommodate many rockers and be an easy hand or machine shape blank.

Call (310) 225-6774 or visit www.usblanks.com



USBlanks™

MADE IN AMERICA

7'10" SP

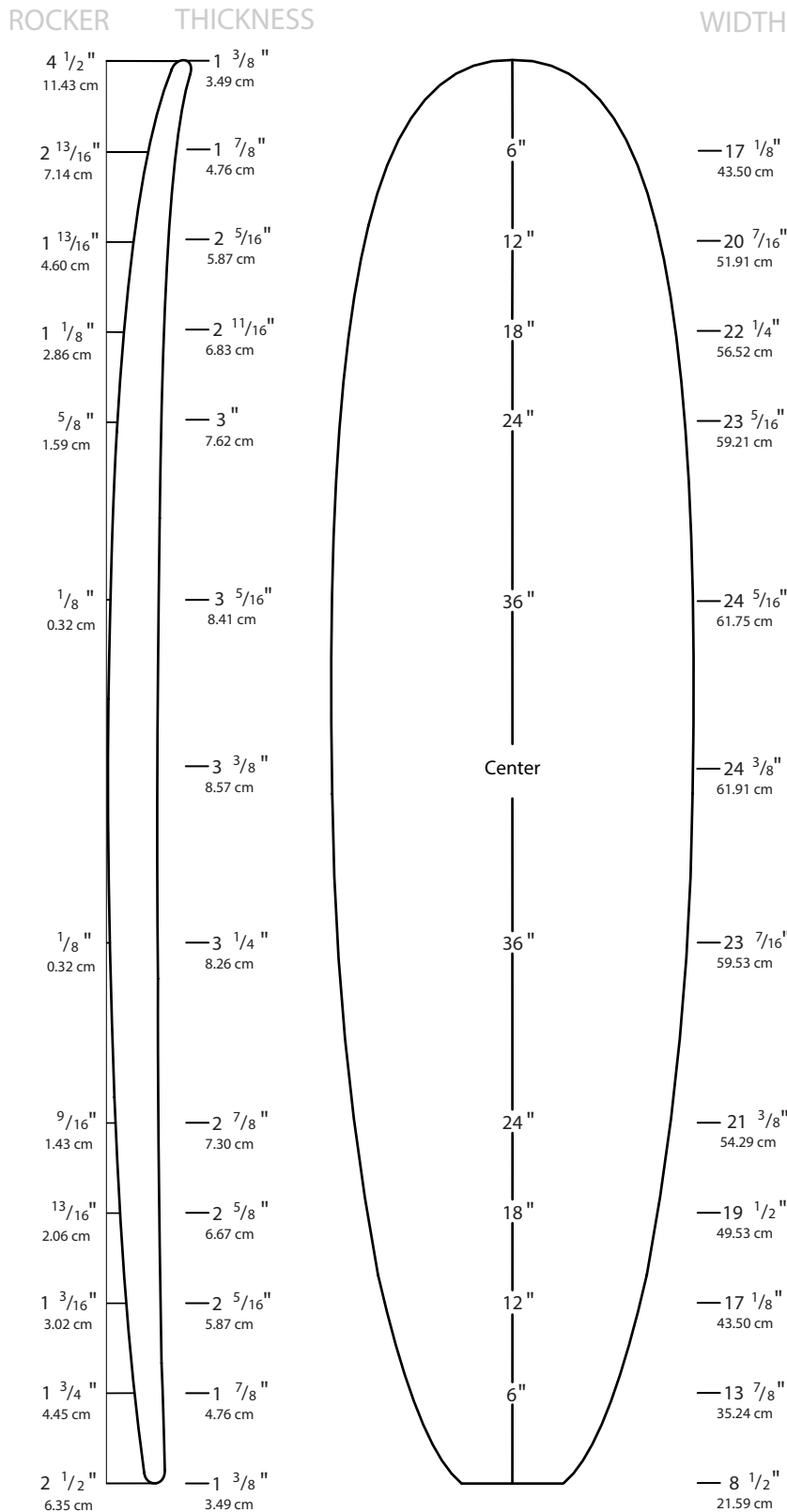

Overall Bottom Length: 7' 11 1/4" (241.94 cm)

Tip-to-tip Deck Length: 7' 10 3/4" (240.67 cm)

Maximum Width: 24 3/8" (61.91 cm)

Maximum Thickness: 3 3/8" (8.57 cm)

Displacement: 2.892 cubic feet (81.9 L)

Introduced: May 2014

Available Rockers:

Designer Comments: The 7'10" SP and the 7'4" SP were built together on Maui and are similar to the 8'4" SP, offering a more complete size progression for mini longboards. The outlines of both were widened relative to the 8'4" SP to make them usable for a broader range of designs. Natural rocker is fairly neutral in both the nose and tail, with enough thickness to shape them up or down, according to the shaper's preference. Ideal for boards in the 7'4" to 7'10" range.

Call (310) 225-6774 or visit www.usblanks.com



Designed by: **Charlie Smith & Tom Parrish**

USBlanks™

MADE IN AMERICA

7'11" A

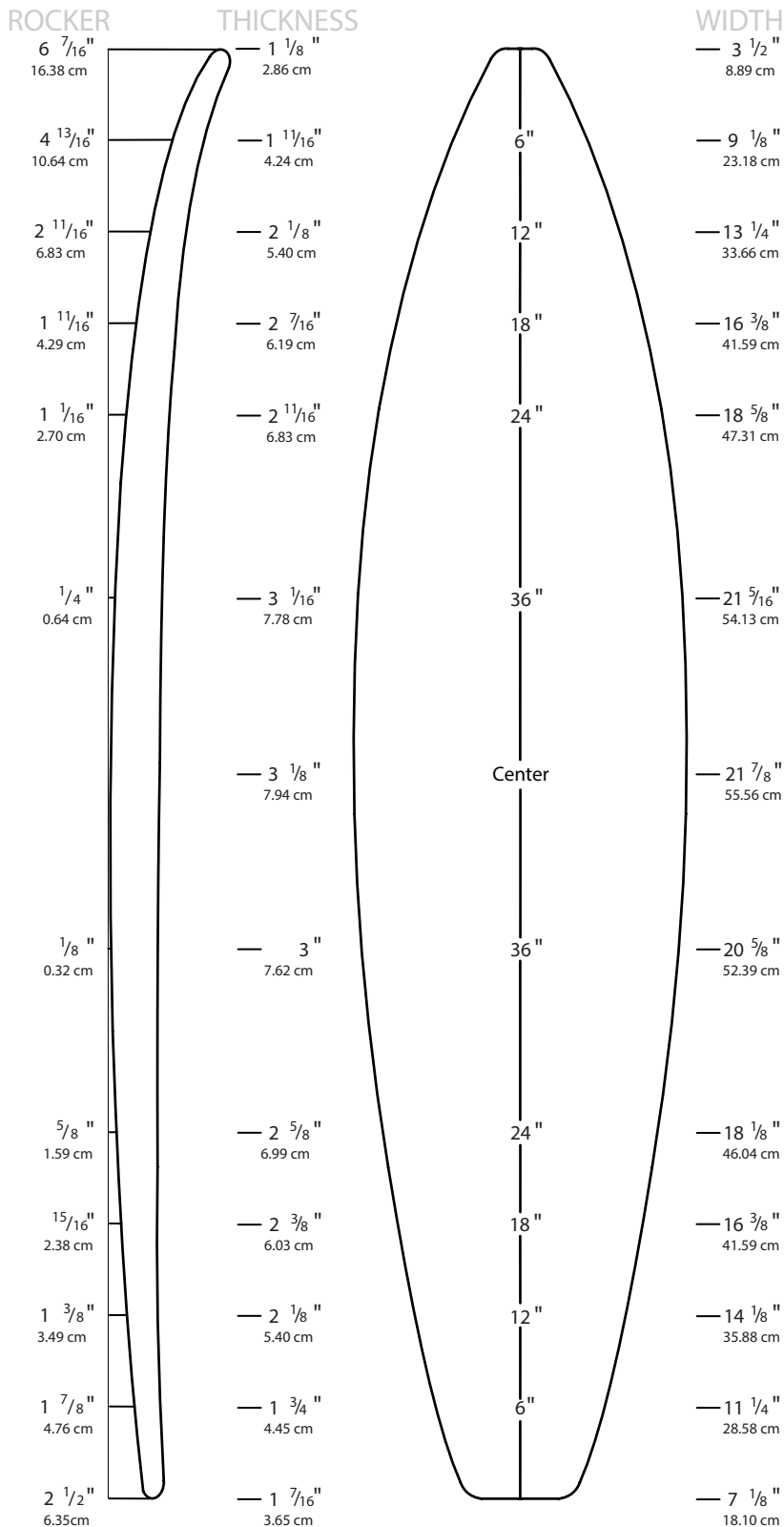

Overall Bottom Length: 7' 11 1/2" (242.57 cm)

Tip-to-tip Deck Length: 7' 10 11/16" (240.51 cm)

Maximum Width: 21 7/8" (55.56 cm)

Maximum Thickness: 3 1/8" (7.94 cm)

Displacement: 2.32 ft³ (65.7 L)

Introduced: September 2006

Available Rockers:

Designer Comments: This mid size gun blank can net a 7'9" bottom length. The natural rocker is good for vee in the tail and contoured bottom designs. The Hawaii Rocker to be used for hi-performance styles.

Call (310) 225-6774 or visit www.usblanks.com



Designed by: **Pat Rawson**

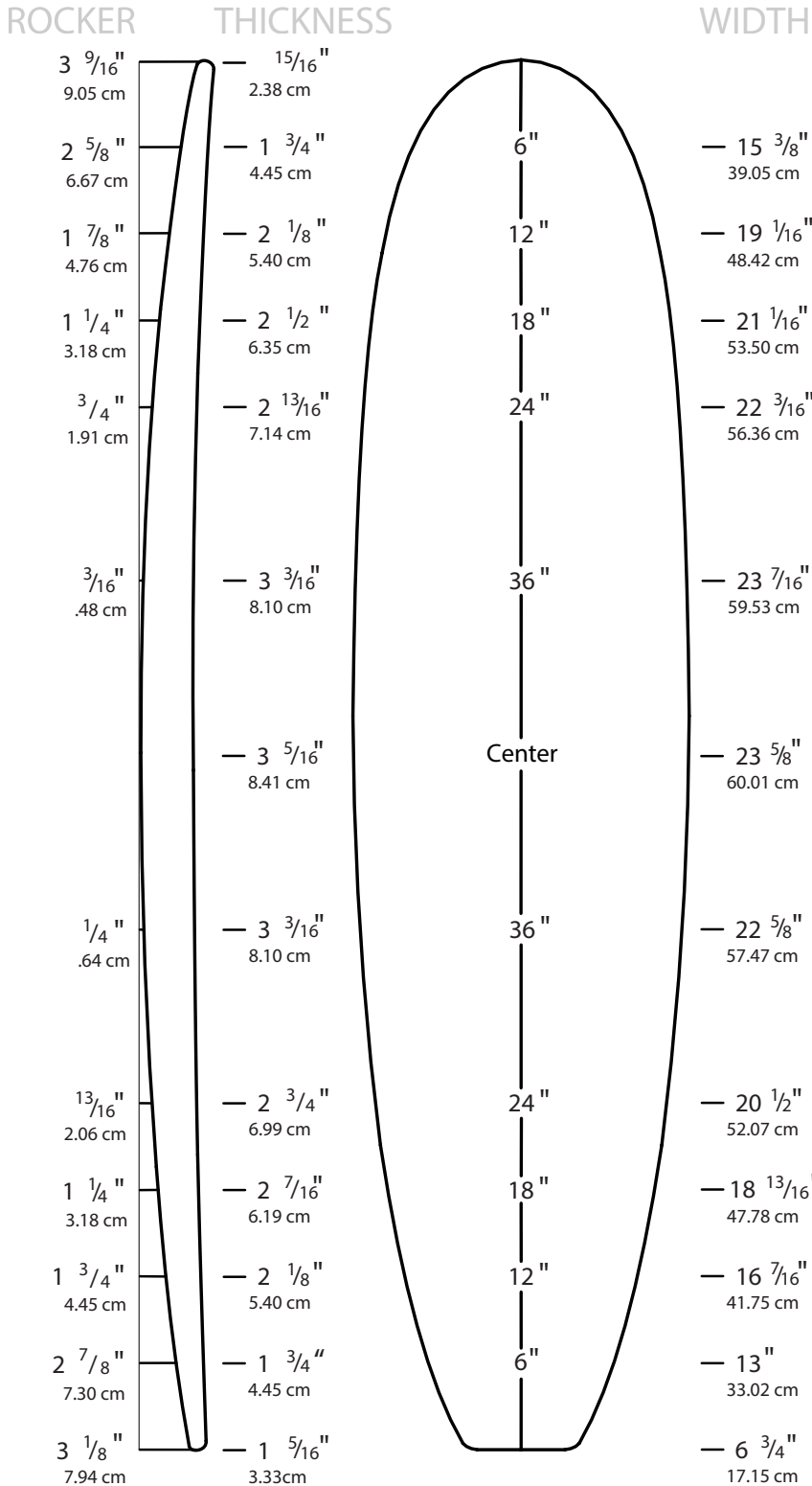

Overall Bottom Length: 8' 0 1/8" (244.16 cm)

Tip-to-tip Deck Length: 7' 11 5/8" (242.89 cm)

Maximum Width: 23 5/8" (60.01 cm)

Maximum Thickness: 3 5/16" (8.41 cm)

Displacement: 2.77 ft³ (78.4 L)

Introduced: July 2006

Available Rockers:

Designer Comments: Designed for retro funshapes. Based on feedback from 7'11"H and 8'4"H, improvements were made in the thickness and foil. Should accommodate many rockers and be an easy hand or machine shape blank.

Call (310) 225-6774 or visit www.usblanks.com



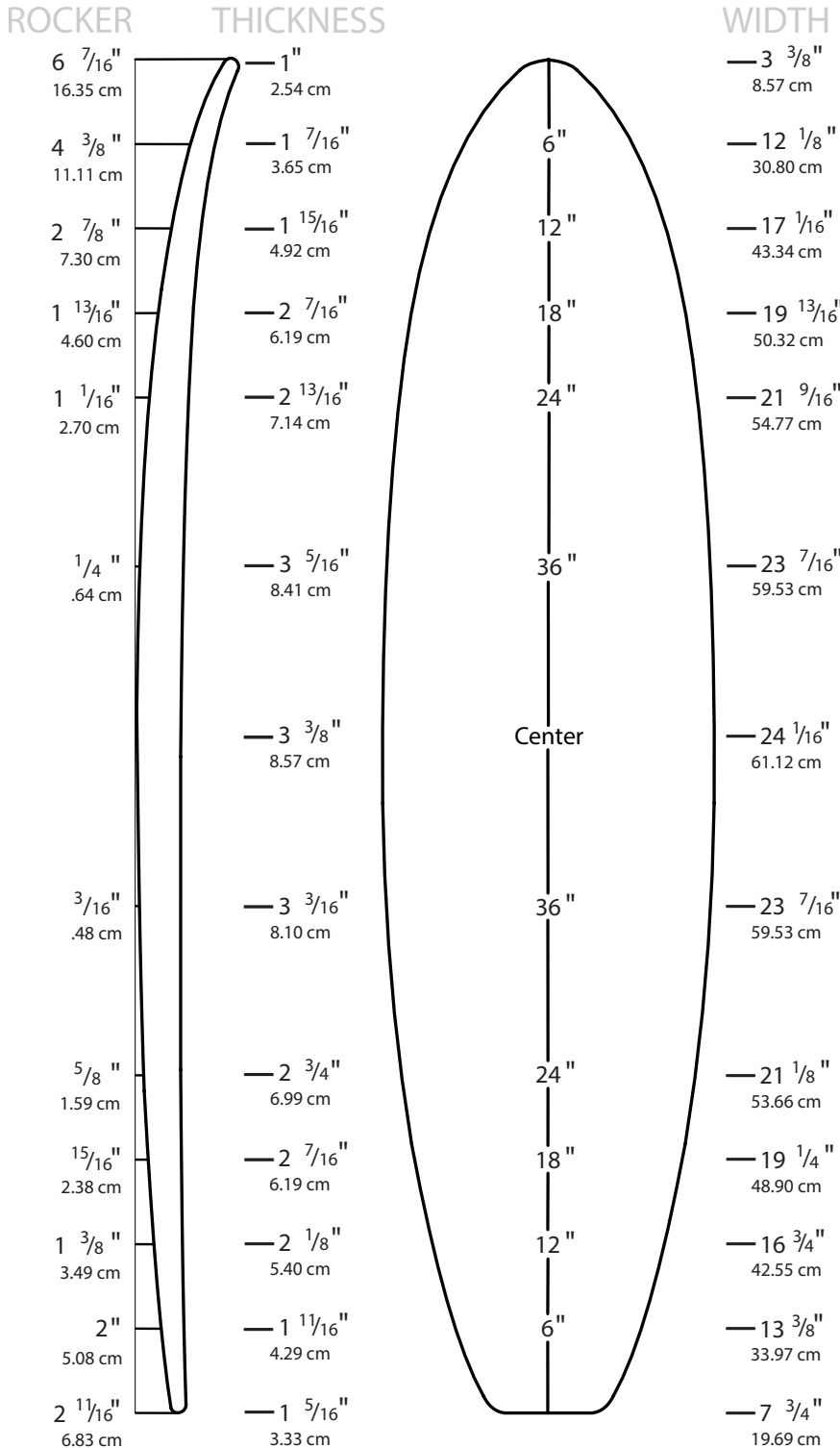

Overall Bottom Length: 8' 0 5/8" (245.43 cm)

Tip-to-tip Deck Length: 7' 11 3/4" (243.21 cm)

Maximum Width: 24 1/16" (61.19 cm)

Maximum Thickness: 3 3/8" (8.57 cm)

Displacement: 2.66 ft³ (75.3 L)

Introduced: July 2006

Available Rockers:

Designer Comments: This is primarily designed for making funboards. It comes with a moderate but continuous even rocker and foil to make "positioning" the blank for the shape process easy. It's a longer version of the 7'6" EA, but I added width forward to accommodate wider noses.

Call (310) 225-6774 or visit www.usblanks.com



ROCKER

6 5/8" 16.83 cm
 4 3/8" 11.11 cm
 2 11/16" 6.83 cm
 1 11/16" 4.29 cm
 1" 2.54 cm
 1/4" 0.64 cm
 3/16" 0.48 cm
 1 1/16" 1.75 cm
 1 1/16" 2.70 cm
 1 1/2" 3.81 cm
 2" 5.08 cm
 2 9/16" 6.51 cm

THICKNESS

1 5/16" 3.33 cm
 1 13/16" 4.60 cm
 2 7/16" 6.19 cm
 3" 7.62 cm
 3 3/8" 8.57 cm
 3 15/16" 10.00 cm
 4 1/16" 10.32 cm
 3 7/8" 9.84 cm
 3 3/8" 8.57 cm
 3" 7.62 cm
 2 5/8" 6.68 cm
 2 1/8" 5.40 cm
 1 3/4" 4.45 cm

WIDTH

4" 10.16 cm
 12 1/2" 31.75 cm
 17 3/8" 44.13 cm
 20 1/4" 52.07 cm
 22 7/16" 56.99 cm
 24 7/16" 62.07 cm
 25" 63.50 cm
 24 1/16" 61.12 cm
 21 7/8" 55.56 cm
 20 1/8" 51.12 cm
 17 11/16" 44.93 cm
 14 5/16" 36.35 cm
 9 1/2" 24.13 cm

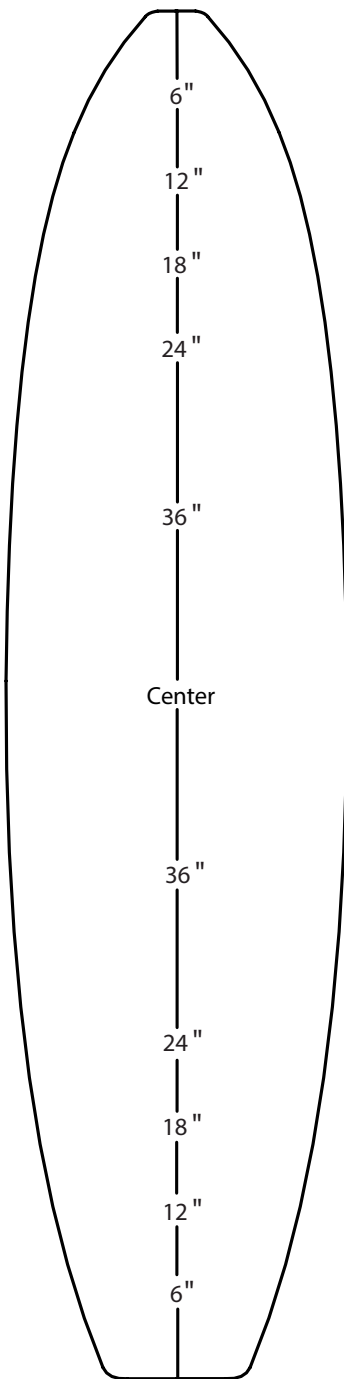

Overall Bottom Length: 8' 2 1/2" (250.19 cm)

Tip-to-tip Deck Length: 8' 1 1/2" (247.65 cm)

Maximum Width: 25" (63.50 cm)

Maximum Thickness: 4 1/16" (10.32 cm)

Displacement: 3.59 ft³ (101.7 L)

Introduced: July 2008

Available Rockers:

Designer Comments: I designed the 8'2" A to be a serious "big guy" blank for either high performance, retros, or fun gun styles. It has a performance bottom curve and enough volume for 300 lb. surfers. It should be able to yield 8'0" x 24" x 3 3/4" with ability to position the overall rocker and nose widths as needed. Cutting 2" length off the nose will enable a 18 1/2" nose width at 12" back, and facilitate well for big guy fish designs. My special thanks to Ben Aipa who provided inspiration on the overall design of this blank and the 9'3" A.

(310) 225-6774 - USBlanks.com



8'2" AX

ROCKER

THICKNESS

WIDTH

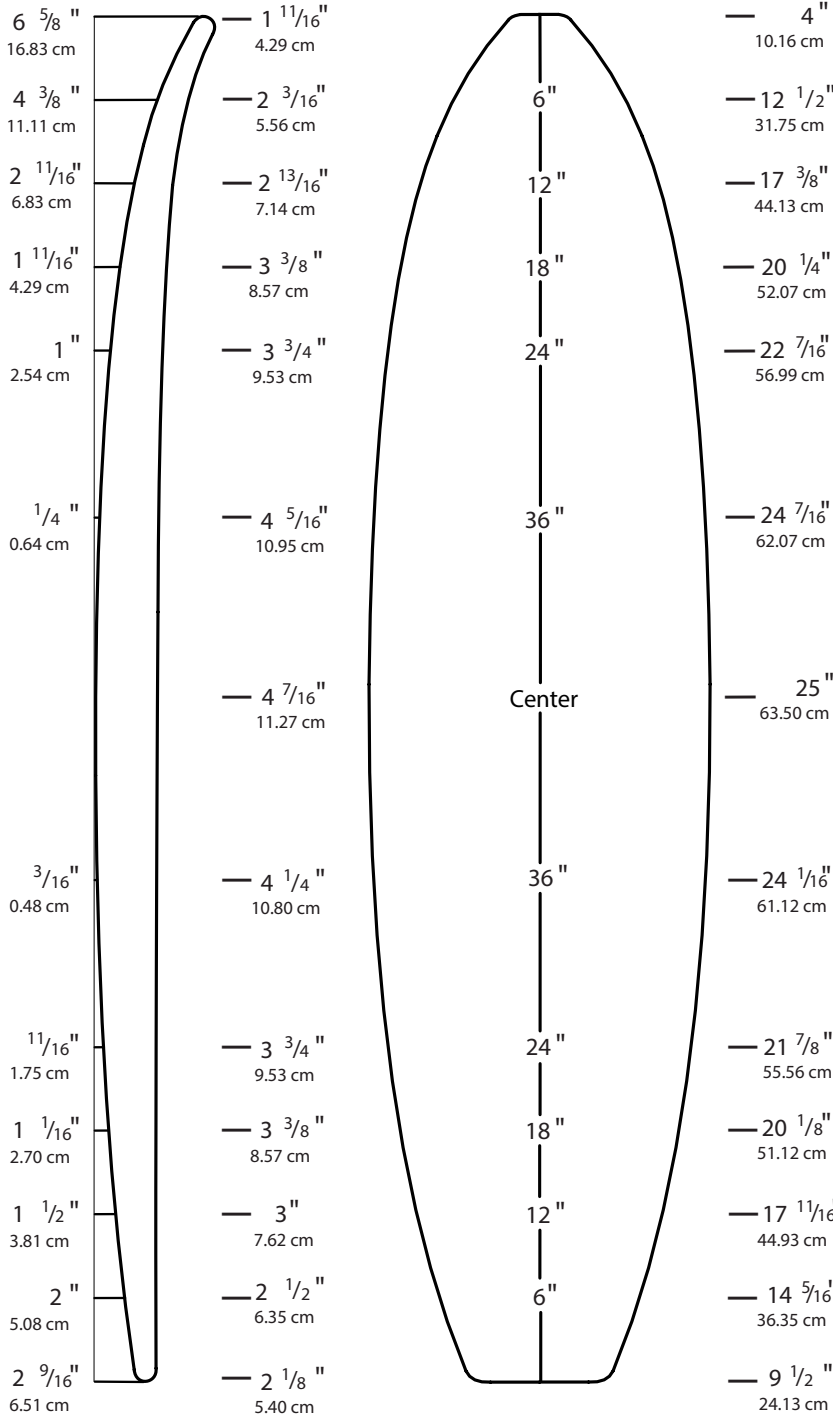

Overall Bottom Length: 8' 2 1/2" (250.19 cm)

Tip-to-tip Deck Length: 8' 1 1/2" (247.65 cm)

Maximum Width: 25" (63.50 cm)

Maximum Thickness: 4 7/16" (11.27 cm)

82A w/ 3/8" added thickness overall

Displacement: 3.99 ft³ (113.1 L)

Introduced: July 2008

Available Rockers:

Designer Comments: Same as the 8'2" A but shimmed to produce 3/8" thicker than the 8'2" A. I designed the 8'2" A to be a serious "big guy" blank for either high performance, retros, or fun gun styles. It has a performance bottom curve and enough volume for 300 lb. surfers. It should be able to yield 8'0" x 24" x 3 3/4" with ability to position the overall rocker and nose widths as needed. Cutting 2" length off the nose will enable a 18 1/2" nose width at 12" back, and facilitate well for big guy fish designs. My special thanks to Ben Aipa who provided inspiration on the overall design of this blank and the 9'3" A.

Call (310) 225-6774 or visit www.usblanks.com



USBlanks™

MADE IN AMERICA

8'3"H

ROCKER THICKNESS WIDTH

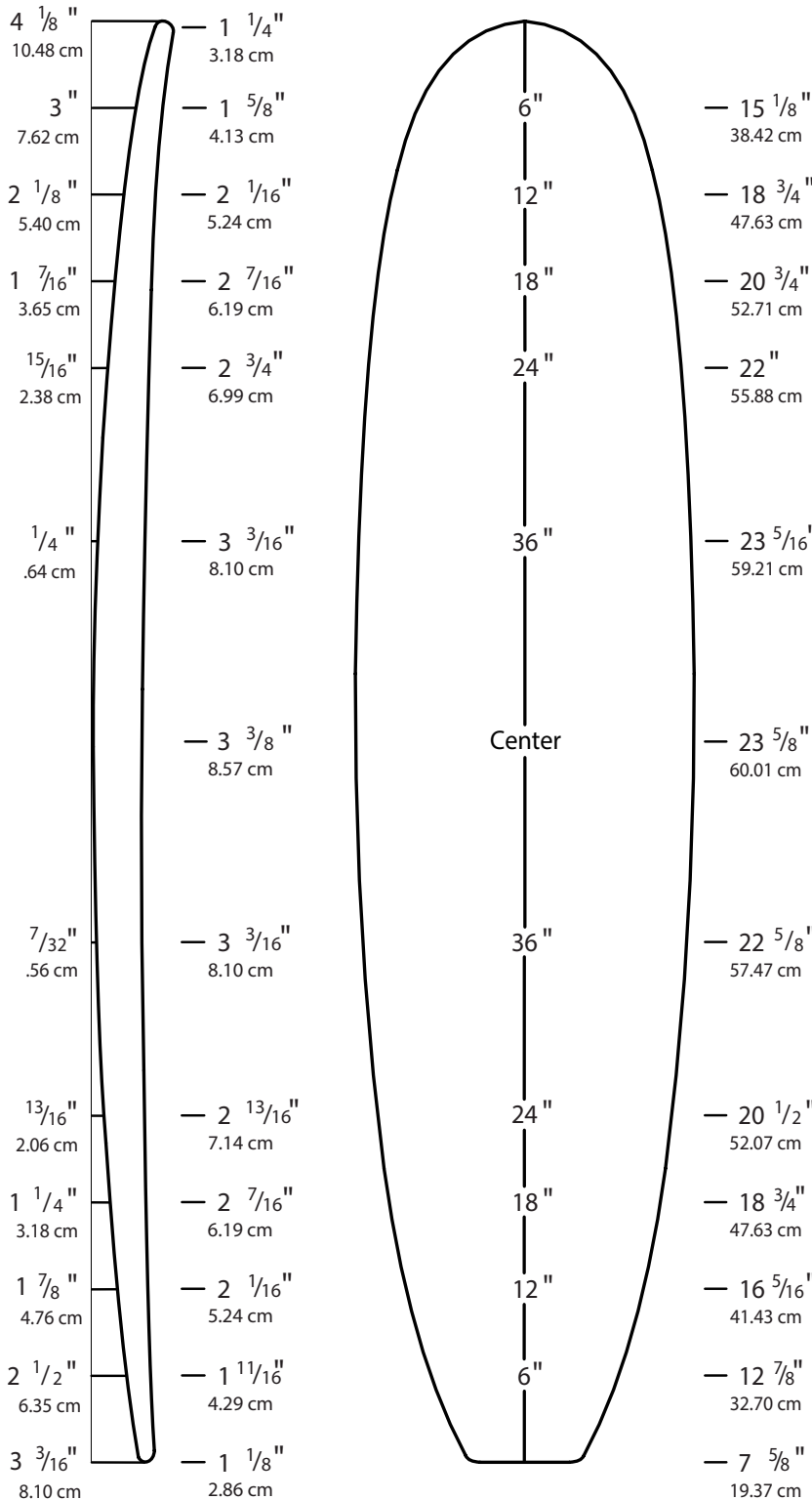

Overall Bottom Length: 8' 3 1/8" (251.78 cm)

Tip-to-tip Deck Length: 8' 2 5/8" (250.51 cm)

Maximum Width: 23 5/8" (60.01 cm)

Maximum Thickness: 3 3/8" (8.57 cm)

Displacement: 2.74 ft³ (77.6 L)

Introduced: July 2006

Available Rockers:

Designer Comments: Designed for retro funshapes. Based on feedback from 7'11"H and 8'4"H, improvements were made in the thickness and foil. Should accommodate many rockers and be an easy hand or machine shape blank.

Call (310) 225-6774 or visit www.usblanks.com



Designed by: **Roger Hinds**

USBlanks™

MADE IN AMERICA

8'4" SP

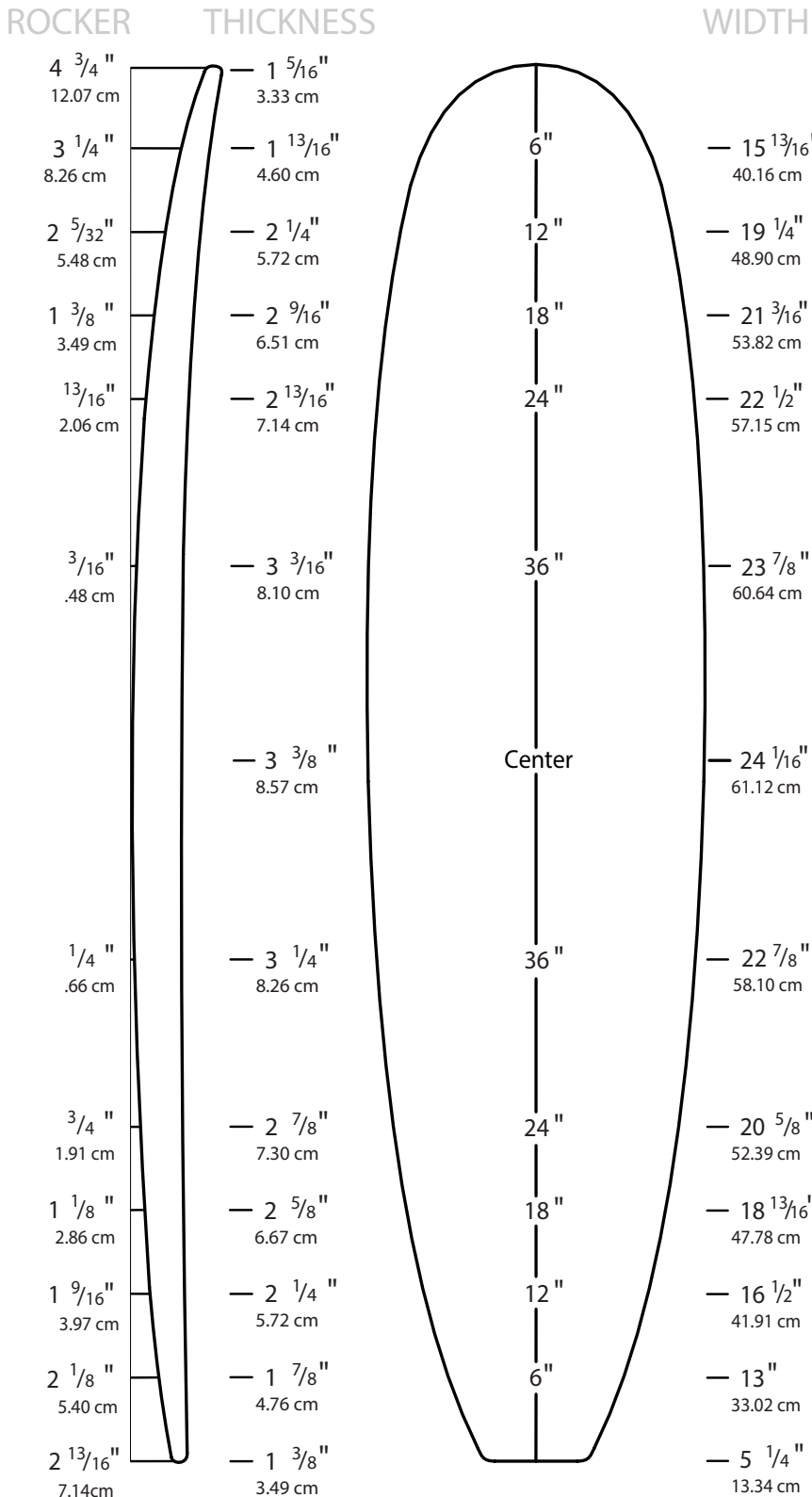

Overall Bottom Length: 8' 4 7/16" (255.11 cm)

Tip-to-tip Deck Length: 8' 3 13/16" (253.52 cm)

Maximum Width: 24 3/16" (61.44 cm)

Maximum Thickness: 3 3/8" (8.57 cm)

Displacement: 2.97 ft³ (84.0 L)

Introduced: May 2009

Available Rockers:

Designer Comments: This blank reflects four decades of collaboration between Charlie Smith and Tom Parrish in one form or another. The 8'4" SP allows for funboard, mini-longboard and noserider style templates. Natural rocker is fairly neutral in both the nose and tail, with enough thickness to shape it up or down, according to the shaper's preference. Ideal for boards in the 7'10" to 8'4" range.

Call (310) 225-6774 or visit www.usblanks.com



Designed by: **Charlie Smith & Tom Parrish**

USBlanks™

MADE IN AMERICA

8'4"SPX

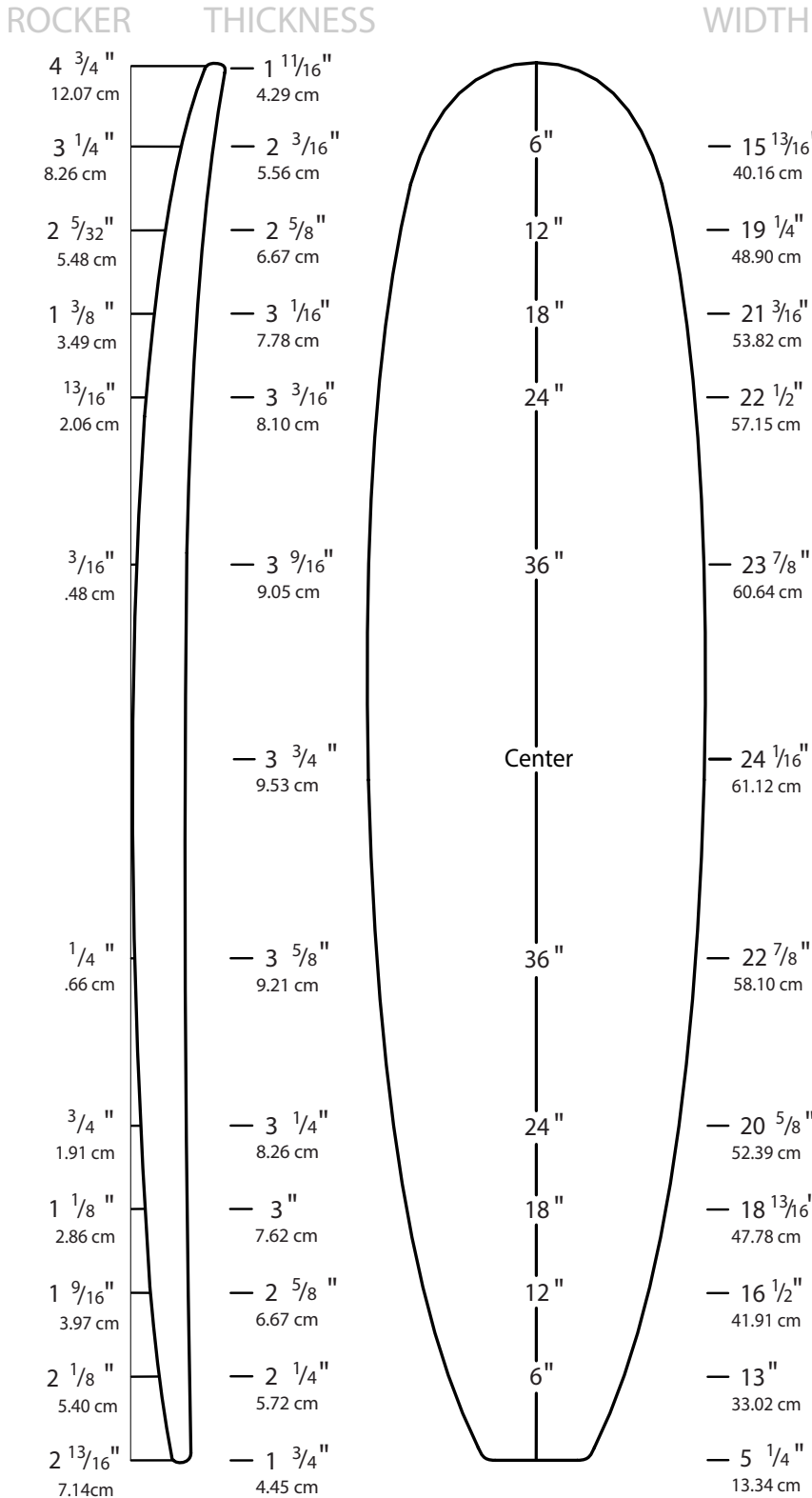

Overall Bottom Length: 8' 4 7/16" (255.11 cm)

Tip-to-tip Deck Length: 8' 3 13/16" (253.52 cm)

Maximum Width: 24 3/16" (61.44 cm)

Maximum Thickness: 3 3/4" (9.53 cm)

8'4 SP w/ 3/8" added thickness overall

Displacement: 3.33 ft³ (94.4 L)

Introduced: May 2009

Available Rockers:

Designer Comments: This is a 3/8" thicker version of the 8'4" SP. This blank reflects four decades of collaboration between Charlie Smith and Tom Parrish in one form or another. The 8'4" SP allows for funboard, mini-longboard and noserider style templates. Natural rocker is fairly neutral in both the nose and tail, with enough thickness to shape it up or down, according to the shaper's preference. Ideal for boards in the 7'10" to 8'4" range.

Call (310) 225-6774 or visit www.usblanks.com



Designed by: **Charlie Smith & Tom Parrish**

ROCKER

THICKNESS

WIDTH

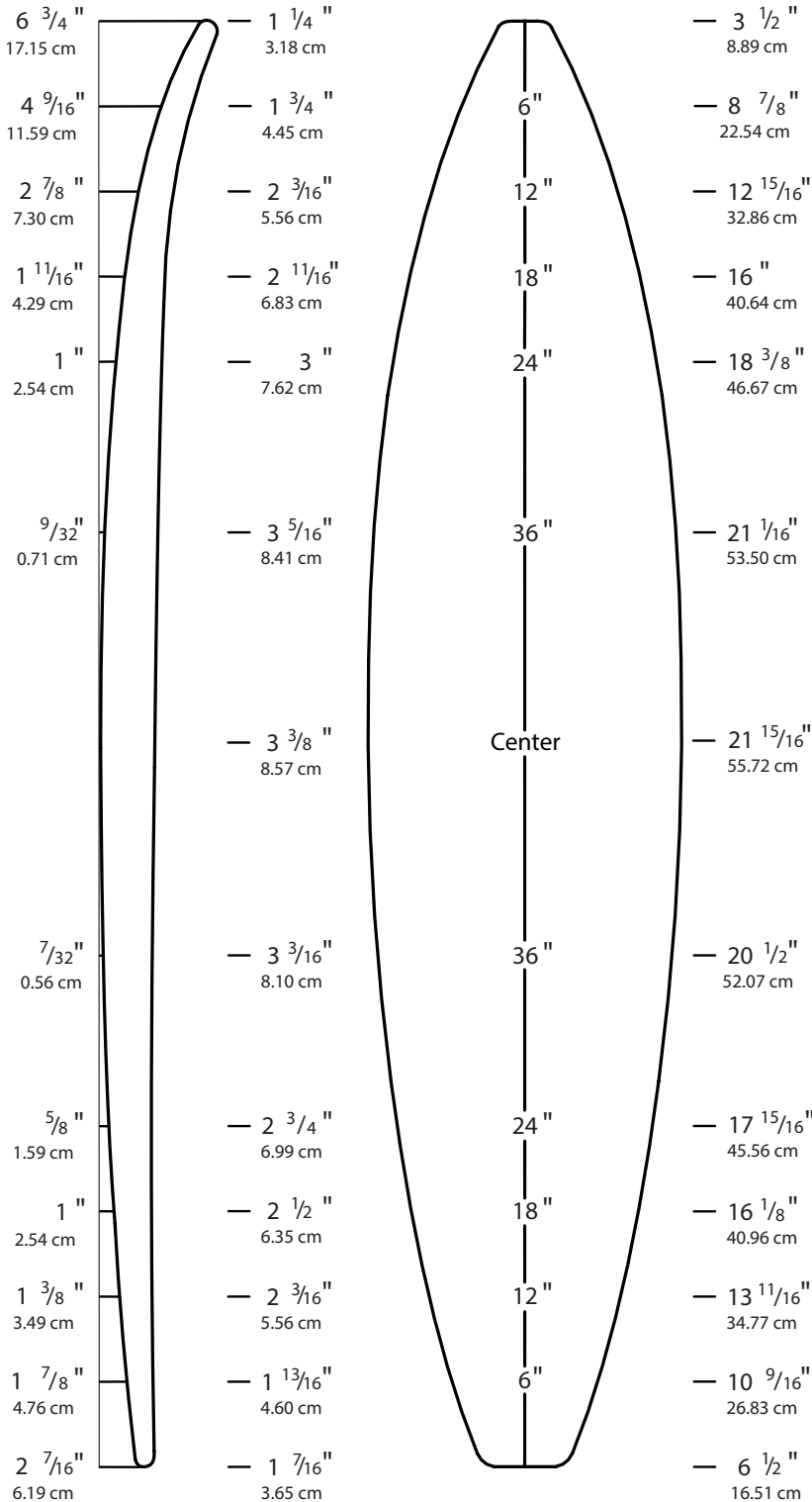

Overall Bottom Length: 8' 6 3/8" (260.03 cm)

Tip-to-tip Deck Length: 8' 5 1/2" (257.81 cm)

Maximum Width: 22" (55.88 cm)

Maximum Thickness: 3 3/8" (8.57 cm)

Displacement: 2.70 ft³ (76.5 L)

Introduced: September 2006

Available Rockers:

Designer Comments: The 8'5"A blank easily nets an 8'4" bottom length. The natural rocker is good for vee in the tail and contoured bottom designs. The Hawaii Rocker to be used for hi-performance styles.

Call (310) 225-6774 or visit www.usblanks.com



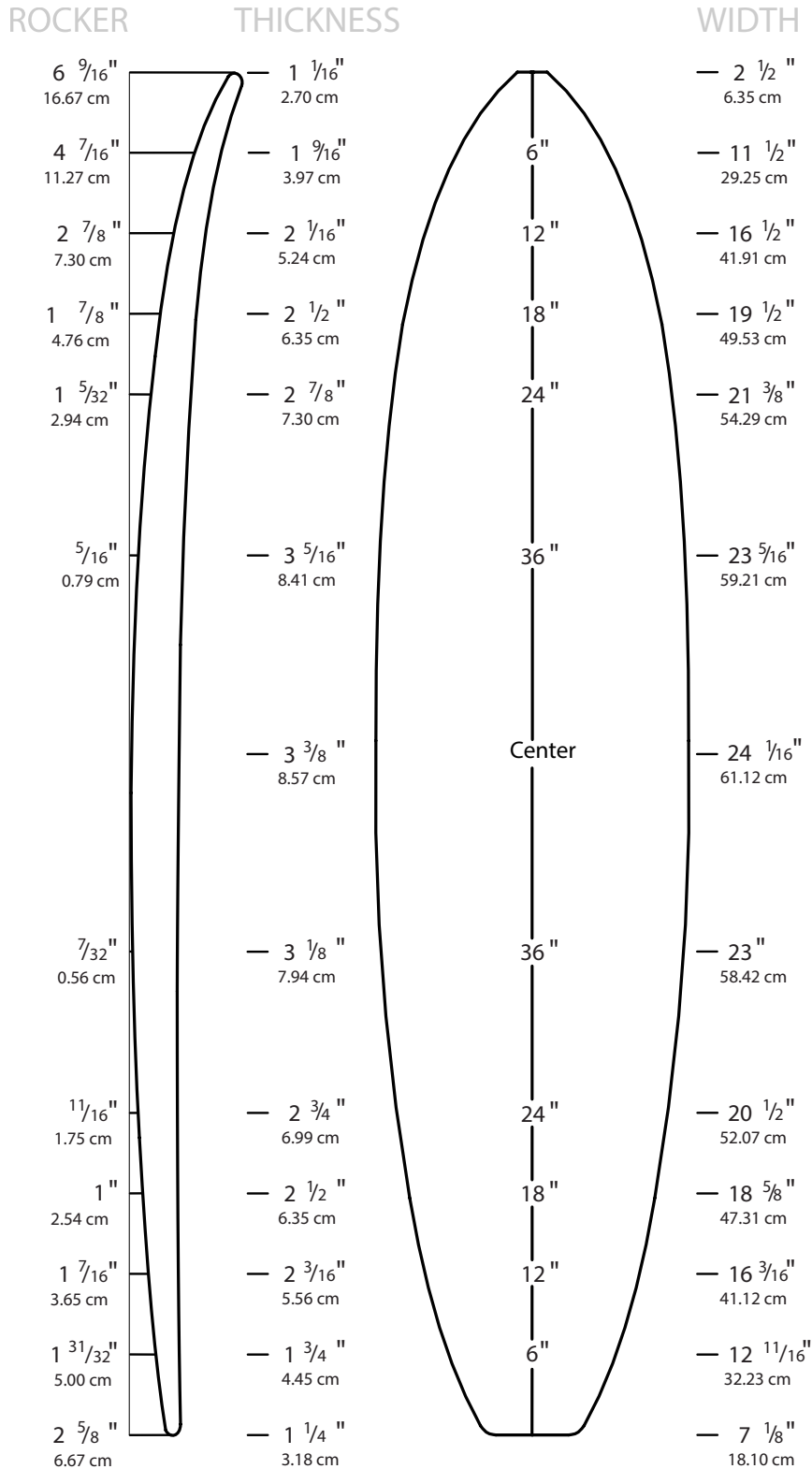

Overall Bottom Length: 8' 6" (259.08 cm)

Tip-to-tip Deck Length: 8' 5 1/8" (257.81 cm)

Maximum Width: 24 1/16" (61.12cm)

Maximum Thickness: 3 3/8" (8.57 cm)

Displacement: 2.72 ft³ (77.0 L)

Introduced: September 2006

Available Rockers:

Designer Comments: This blank is designed to yield big fun boards and big guy guns.

Call (310) 225-6774 or visit www.usblanks.com



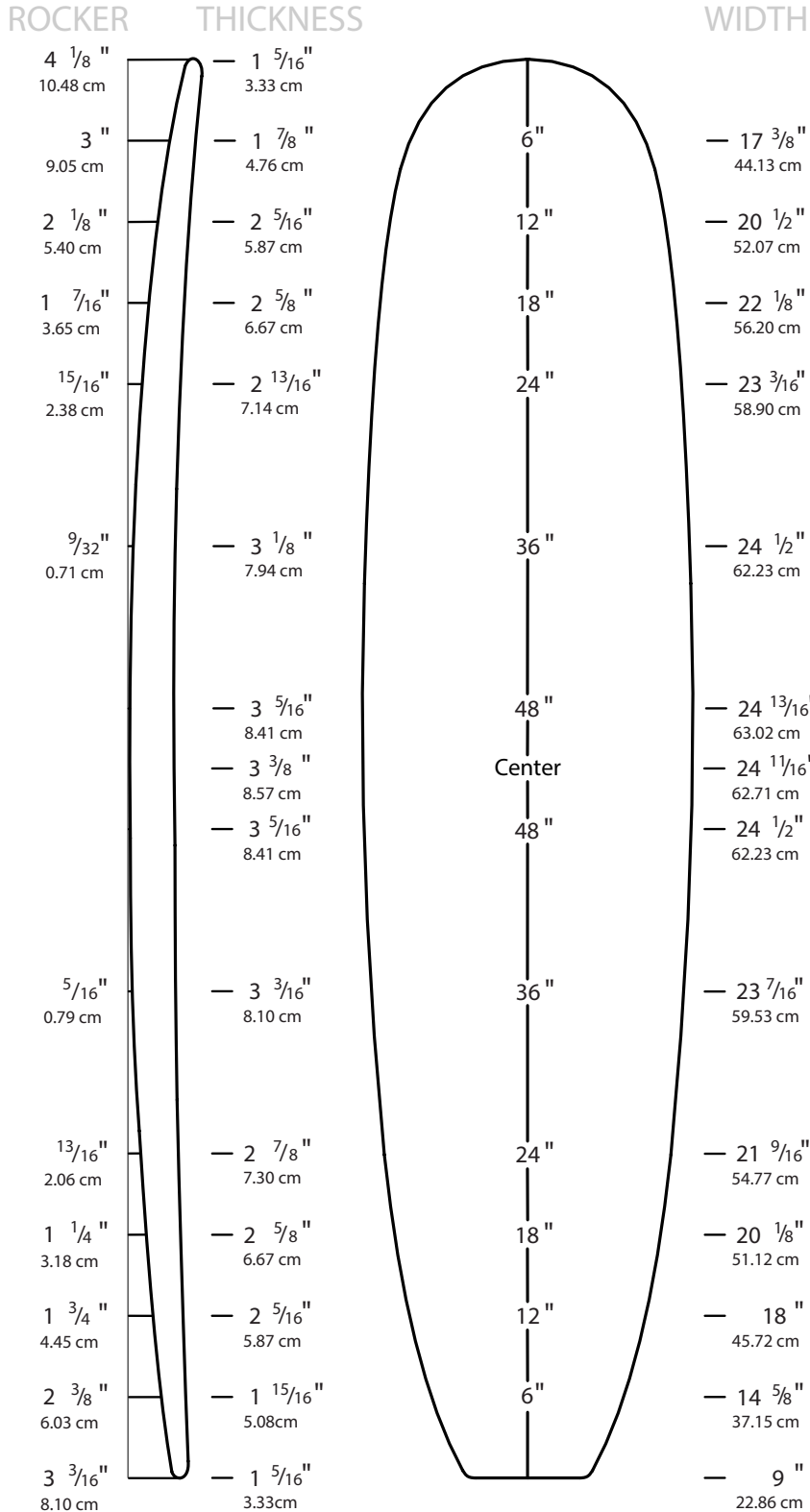

Overall Bottom Length: 8' 9" (266.70 cm)

Tip-to-tip Deck Length: 8' 8 1/2" (265.43 cm)

Maximum Width: 24 13/16" (63.02cm)

Maximum Thickness: 3 3/8" (8.57 cm)

Displacement: 3.25 ft³ (92.1 L)

Introduced: April 2007

Available Rockers:

Designer Comments: This was designed with the popular 9'3"Y as the reference, and intended for 8'6" longboards. As compared to the 9'3"Y it has proportionally less volume, it's 6" shorter, 1/4" narrower, 1/8" thinner and a little wider in the tail area.

Call (310) 225-6774 or visit www.usblanks.com



8'9"YX

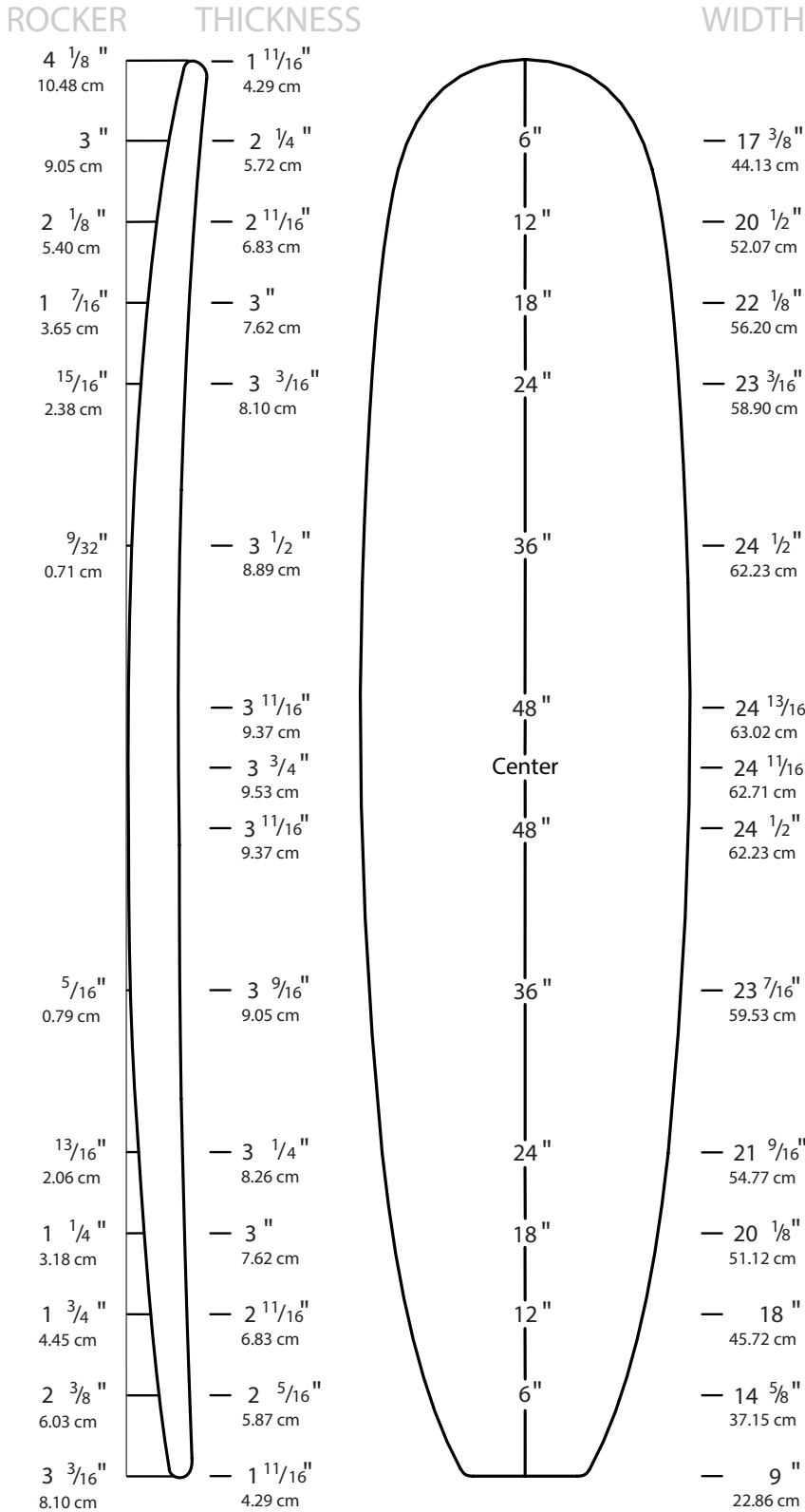

Overall Bottom Length: 8' 9" (266.70 cm)

Tip-to-tip Deck Length: 8' 8 1/2" (265.43 cm)

Maximum Width: 24 13/16" (63.02cm)

Maximum Thickness: 3 3/4" (9.53 cm)

8'9 Y w/ 3/8" added thickness overall

Displacement: 3.73 ft³ (105.7 L)

Introduced: April 2007

Available Rockers:

Designer Comments: This is a 3/8" thicker version of the 8'9"Y, designed with the popular 9'3"Y as the reference, and intended for 8'6" longboards. As compared to the 9'3"Y it has proportionally less volume, it's 6" shorter, 1/4" narrower, 1/8" thinner and a little wider in the tail area.

Call (310) 225-6774 or visit www.usblanks.com



USBlanks™

MADE IN AMERICA

9'2" A

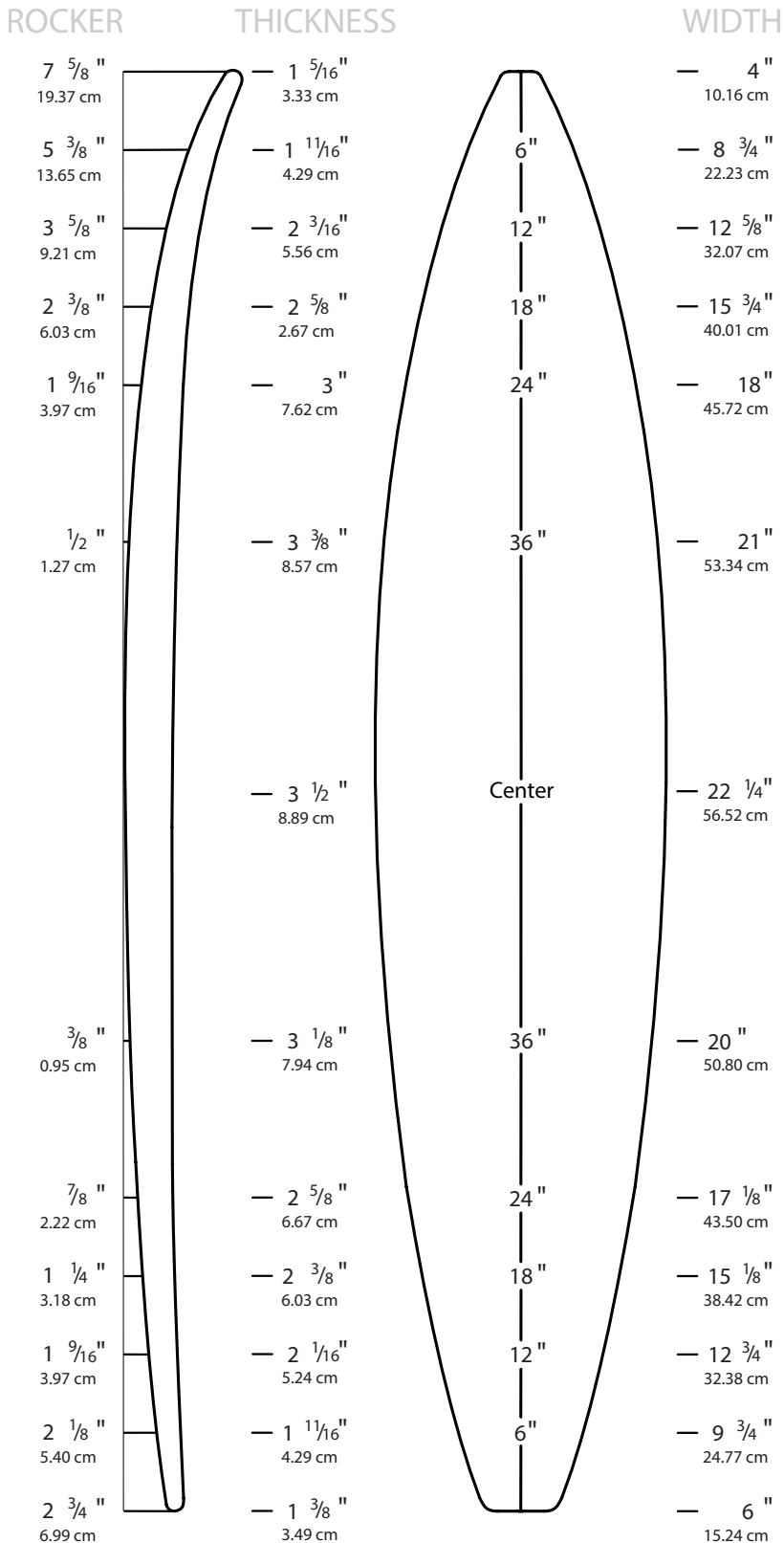

Overall Bottom Length: 9' 3" (281.94 cm)

Tip-to-tip Deck Length: 9' 2" (279.40 cm)

Maximum Width: 22 1/4" (56.52 cm)

Maximum Thickness: 3 1/2" (8.89 cm)

Displacement: 3.12 ft³ (88.3 L)

Introduced: September 2006

Available Rockers:

Designer Comments: The 9'2" A blank easily nets a 9'2" bottom length. It's designed for classic big wave paddle-in-guns. The natural rocker is good for vee in the tail and contoured bottom designs. The Hawaii Rocker to be used for hi-performance styles.

Call (310) 225-6774 or visit www.usblanks.com



Designed by: **Pat Rawson**

ROCKER

THICKNESS

WIDTH

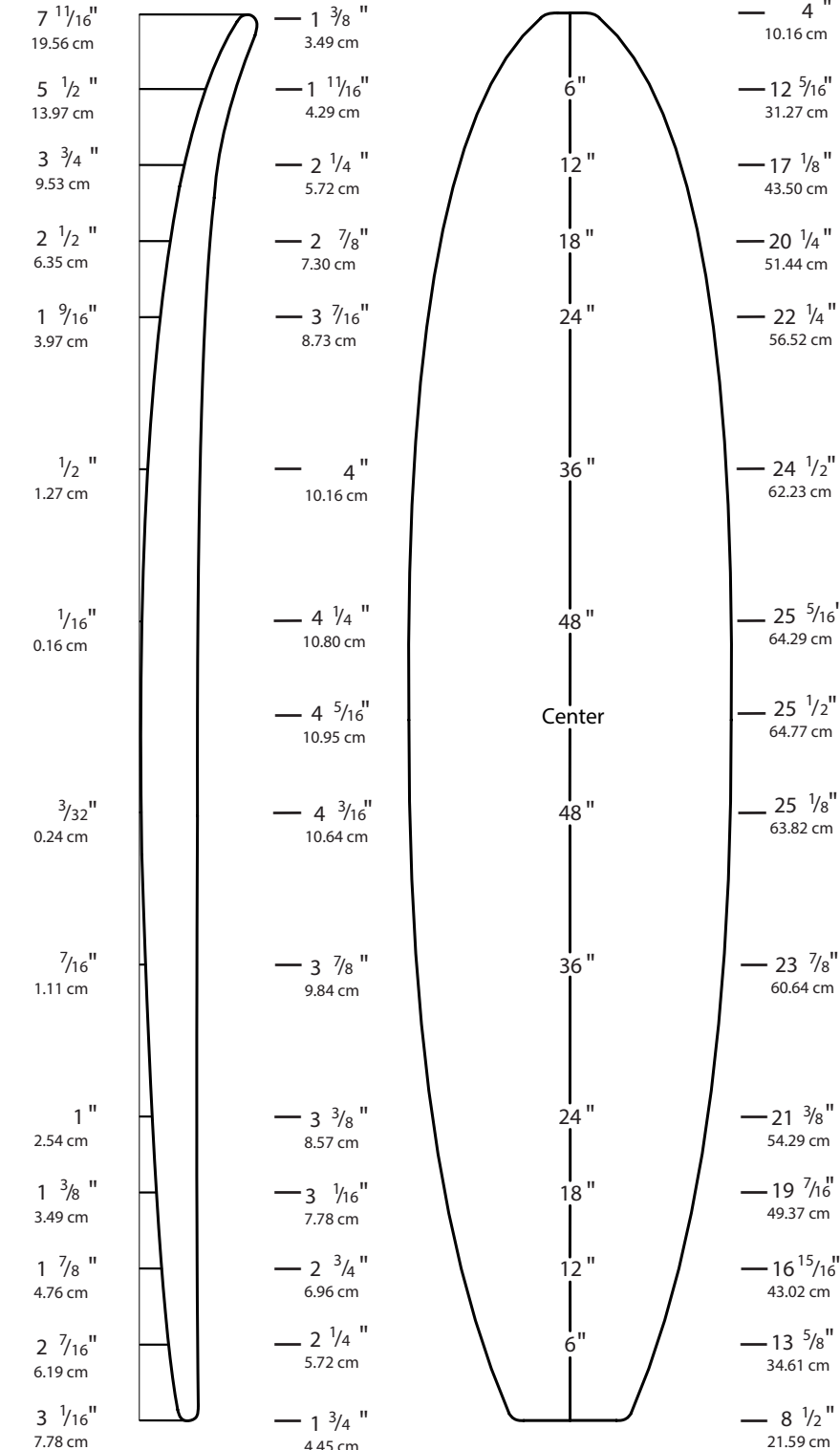

Overall Bottom Length: 9' 3 9/16" (283.37 cm)

Tip-to-tip Deck Length: 9' 2 5/8" (280.99 cm)

Maximum Width: 25 1/2" (64.77 cm)

Maximum Thickness: 4 5/16" (10.95 cm)

Displacement: 4.30 ft³ (121.7 L)

Introduced: July 2008

Available Rockers:

Designer Comments: I designed the 9'3" A to be a very serious "big guy" longer version of the 8'2" A blank for either high performance, retros or fun gun styles. Designed with a performance bottom curve and enough volume for 375 lb. surfers. It should be able to yield 9'0" x 24.5" x 4" also with ability to position the overall rocker and nose widths as needed. Cutting 2" of the length off the nose will enable an 18 3/4" nose width at 12" back, and facilitate well for big guy fish designs. My special thanks to Ben Aipa who provided inspiration on the overall design of this blank and the 8'2" A.

Call (310) 225-6774 or visit www.usblanks.com



9'3" AX

ROCKER

THICKNESS

WIDTH

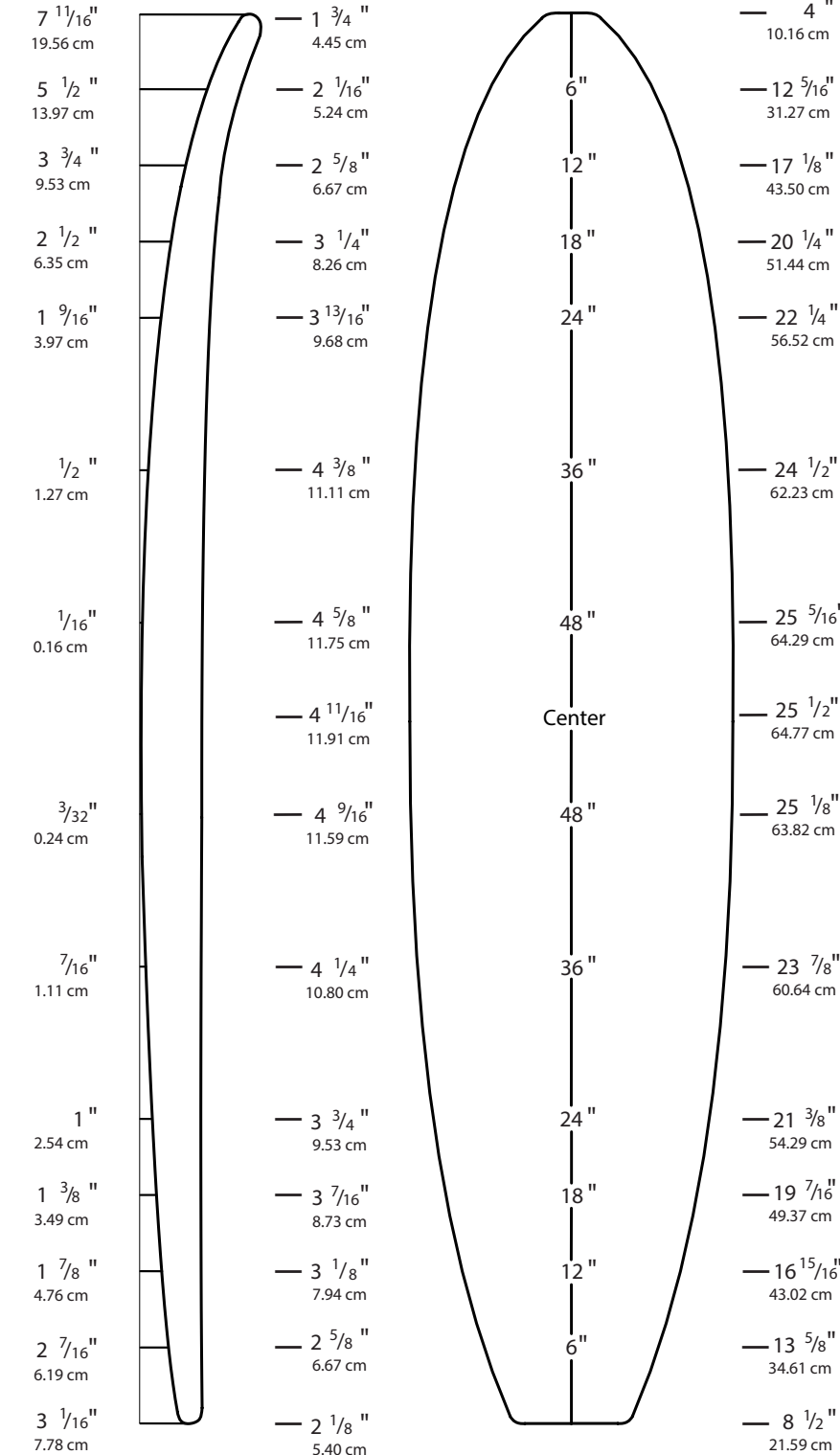

Overall Bottom Length: 9' 3 9/16" (283.37 cm)

Tip-to-tip Deck Length: 9' 2 5/8" (280.99 cm)

Maximum Width: 25 1/2" (64.77 cm)

Maximum Thickness: 4 11/16" (11.91 cm)

9'3 A w/ 3/8" added thickness overall

Displacement: 4.75 ft³ (134.6 L)

Introduced: July 2008

Available Rockers:

Designer Comments: This is the 3/8" thicker version of the 9'3" A. Designed to be a very serious "big guy" longer version of the 8'2" A blank for either high performance, retros or fun gun styles. Designed with a performance bottom curve and enough volume for 375 lb. surfers. It should be able to yield 9'0" x 24.5" x 4" also with ability to position the overall rocker and nose widths as needed. Cutting 2" of the length off the nose will enable an 18 3/4" nose width at 12" back, and facilitate well for big guy fish designs. My special thanks to Ben Aipa who provided inspiration on the overall design of this blank and the 8'2" A.

Call (310) 225-6774 or visit www.usblanks.com



USBlanks™

MADE IN AMERICA

9'3"Y

ROCKER THICKNESS WIDTH

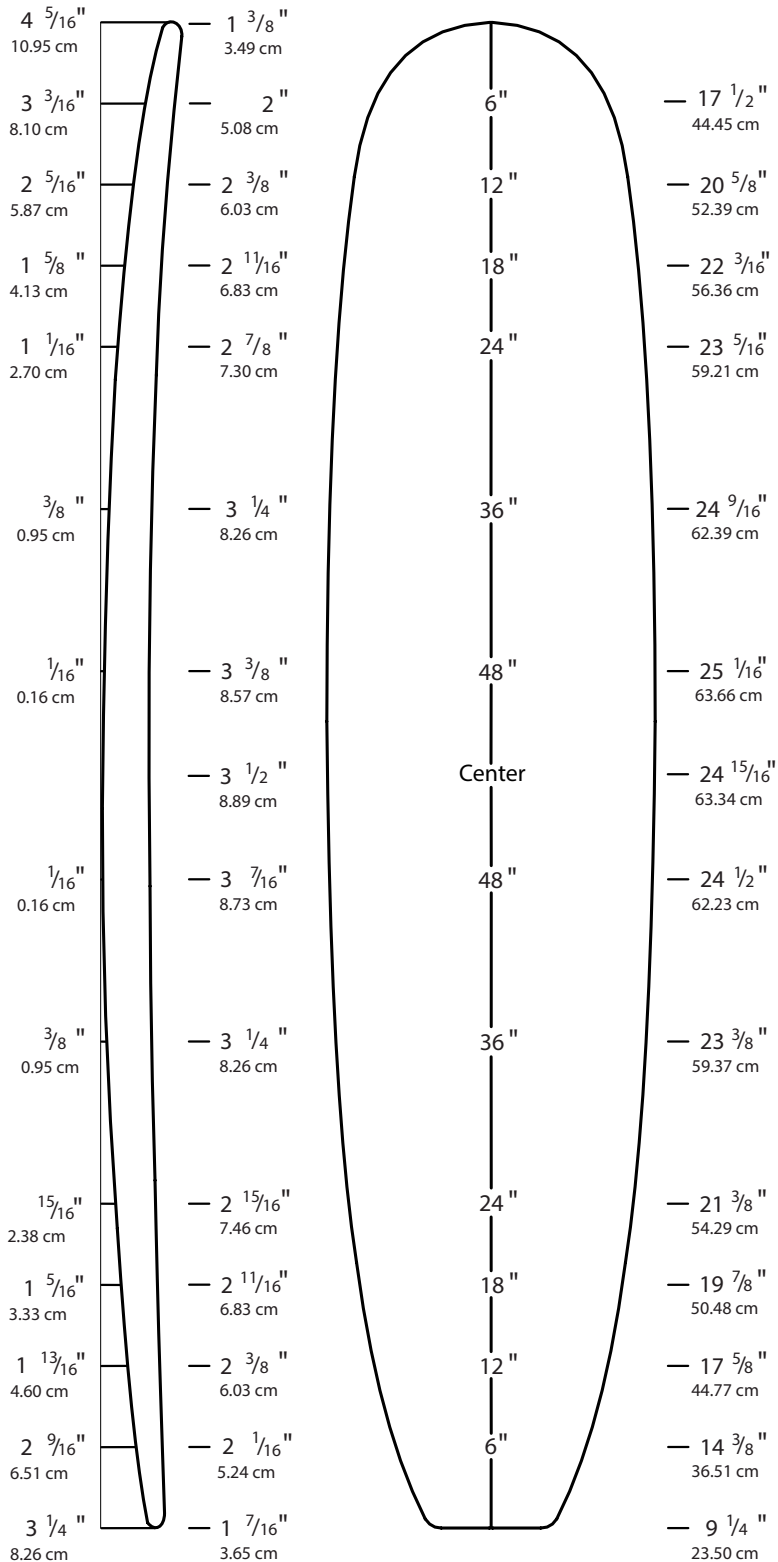

Overall Bottom Length: 9' 3" (281.94 cm)

Tip-to-tip Deck Length: 9' 2 5/8" (280.99cm)

Maximum Width: 25 1/16" (63.66 cm)

Maximum Thickness: 3 1/2" (8.89 cm)

Displacement: 3.70 ft³ (104.7 L)

Introduced: July 2006

Available Rockers:

Designer Comments: Intended for classic longboard designs under the 9'1" range, the 9'3"Y has proven to be one of the most popular blanks. The natural rocker is about in the middle of the demand curve. But remember, the further you change the natural rocker curve the wider the wood stringer it needed to hold it from spring back.

Call (310) 225-6774 or visit www.usblanks.com



Designed by: **Renny Yater**

USBlanks™

MADE IN AMERICA

9'4" B

ROCKER THICKNESS WIDTH

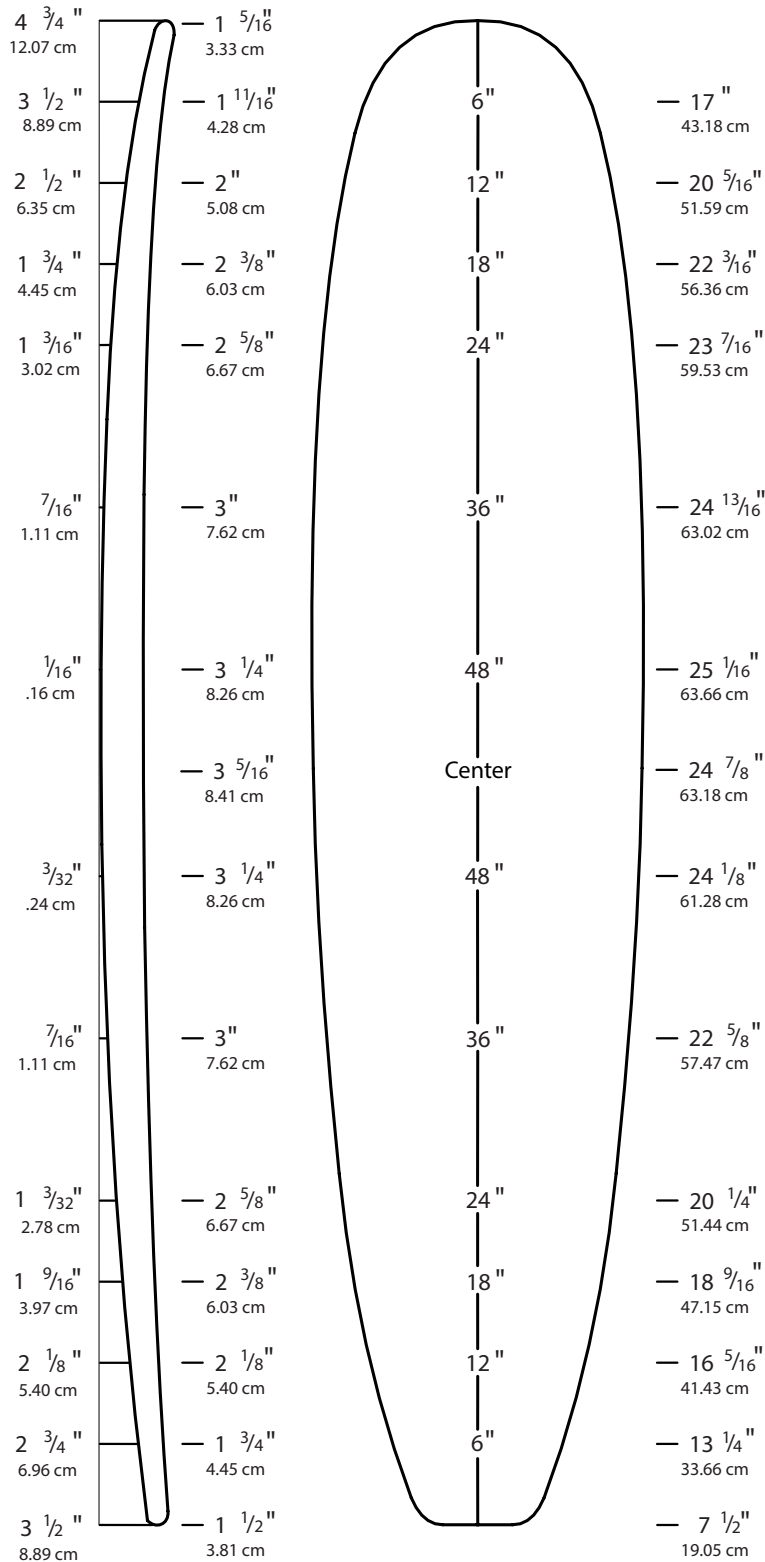

Overall Bottom Length: 9' 3 1/2" (283.21 cm)

Tip-to-tip Deck Length: 9' 3 1/16" (282.10 cm)

Maximum Width: 25 1/16" (63.66 cm)

Maximum Thickness: 3 5/16" (8.41 cm)

Displacement: 3.42 ft³ (96.7 L)

Introduced: July 2006

Available Rockers:

Designer Comments: From the original 9'4" B plug, with thickness added to the tail area of the deck to make it a more shaper friendly blank, close tolerance for strength, will net 24" x 3 1/8". Bottom rockers from the previous 9'4" B will work well with this blank.

Call (310) 225-6774 or visit www.usblanks.com



Designed by: **Bruce Jones**

USBlanks™

MADE IN AMERICA

9'5" M

ROCKER THICKNESS WIDTH

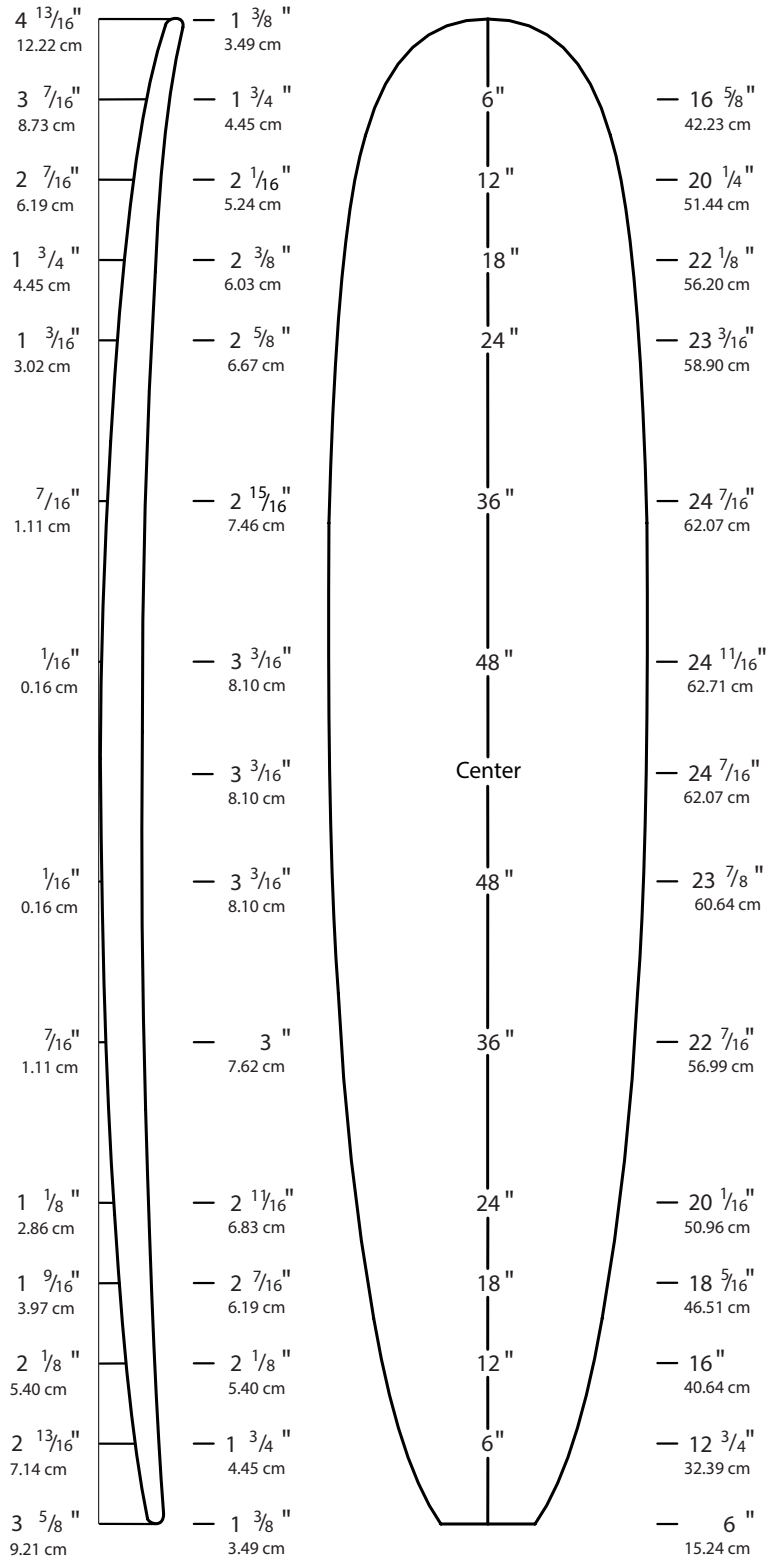

Overall Bottom Length: 9' 4 7/16" (285.59 cm)

Tip-to-tip Deck Length: 9' 3 3/4" (283.85 cm)

Maximum Width: 24 11/16" (62.71 cm)

Maximum Thickness: 3 3/16" (8.10 cm)

Displacement: 3.27 ft³ (92.7 L)

Introduced: August 2007

Available Rockers:

Designer Comments: This is a versatile high performance longboard blank designed to accommodate both machine and hand shaping. The deck is moderately flat with a slight taper out toward the tail to ensure maximum strength. It has slightly more volume in the nose and tail to allow more rocker to be shaped in if desired.

Call (310) 225-6774 or visit www.usblanks.com



Designed by: **Matt Yerxa**

USBlanks™

MADE IN AMERICA

9'8"Y

ROCKER THICKNESS WIDTH

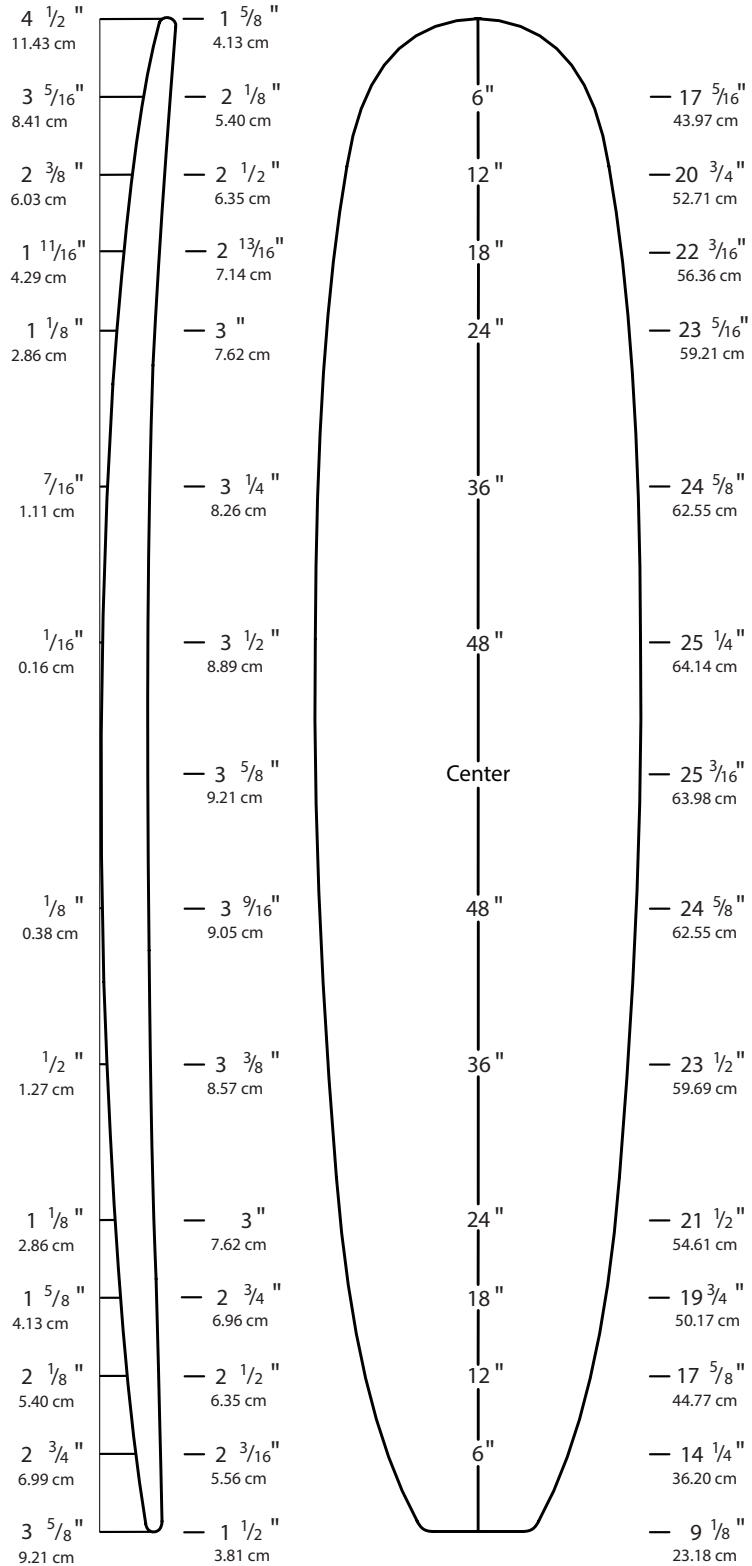

Overall Bottom Length: 9' 8 1/8" (294.96 cm)

Tip-to-tip Deck Length: 9' 7 3/4" (294.01 cm)

Maximum Width: 25 1/4" (64.14 cm)

Maximum Thickness: 3 5/8" (9.21 cm)

Displacement: 4.19 ft³ (118.7 L)

Introduced: July 2006

Available Rockers:

Designer Comments: Intended for classic longboard designs under the 9'6" range. The natural rocker is about in the middle of the demand curve. But remember, the further you change the natural rocker curve the wider the wood stringer it needed to hold it from spring back.

Call (310) 225-6774 or visit www.usblanks.com



Designed by: **Renny Yater**

USBlanks™

MADE IN AMERICA

9'9" A

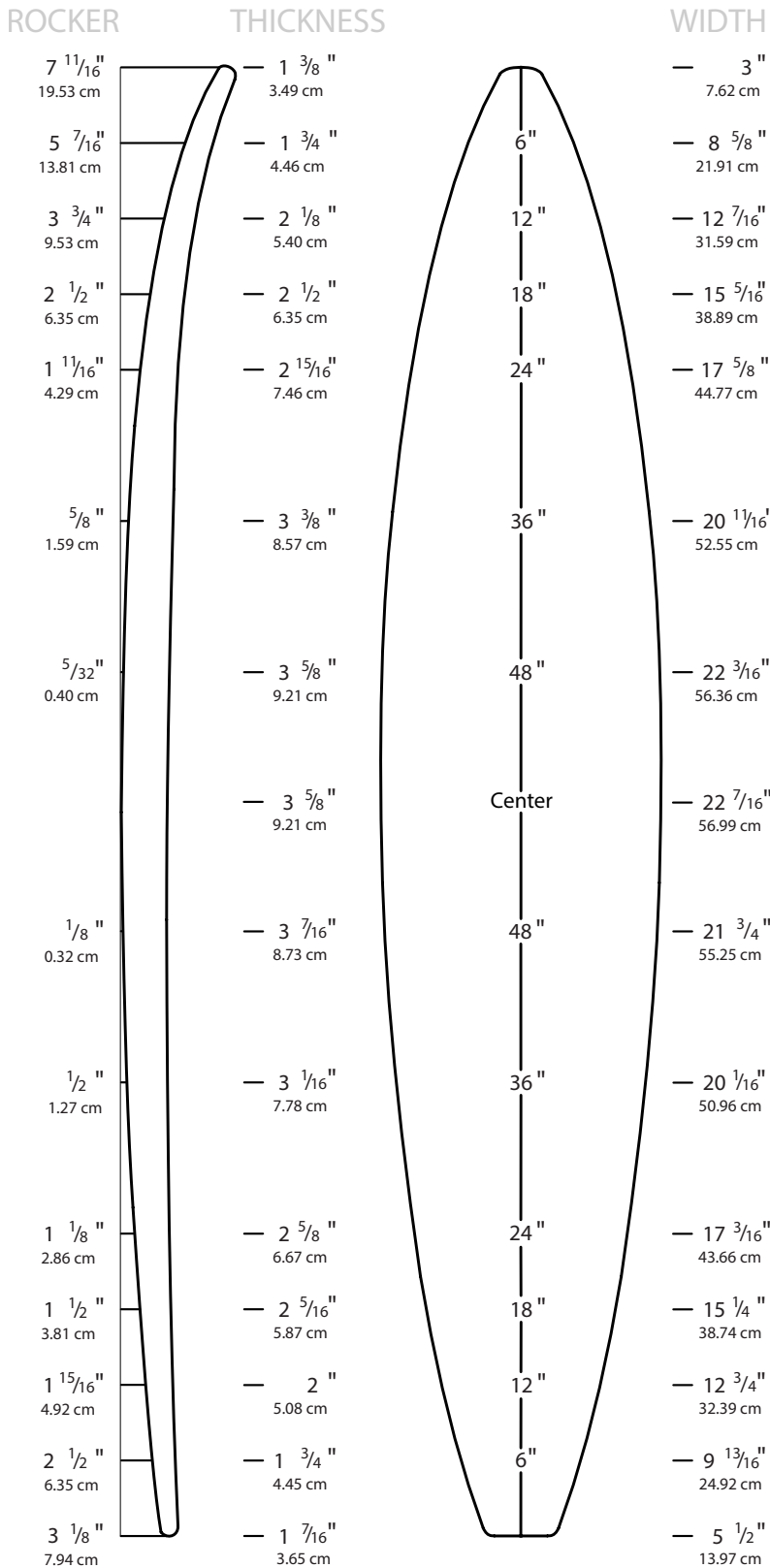

Overall Bottom Length: 9' 9 1/4" (297.82 cm)

Tip-to-tip Deck Length: 9' 8 3/8" (295.59 cm)

Maximum Width: 22 7/16" (56.99 cm)

Maximum Thickness: 3 11/16" (9.37 cm)

Displacement: 3.23 ft³ (91.5 L)

Introduced: September 2006

Available Rockers:

Designer Comments: The 9'9" A easily nets a 9'8" bottom length and is intended for big wave paddle guns. The natural rocker is good for vee in the tail and contoured bottom designs. The Hawaii Rocker to be used for hi-performance styles.

Call (310) 225-6774 or visit www.usblanks.com



Designed by: **Pat Rawson**

USBlanks™

MADE IN AMERICA

9'9" AX

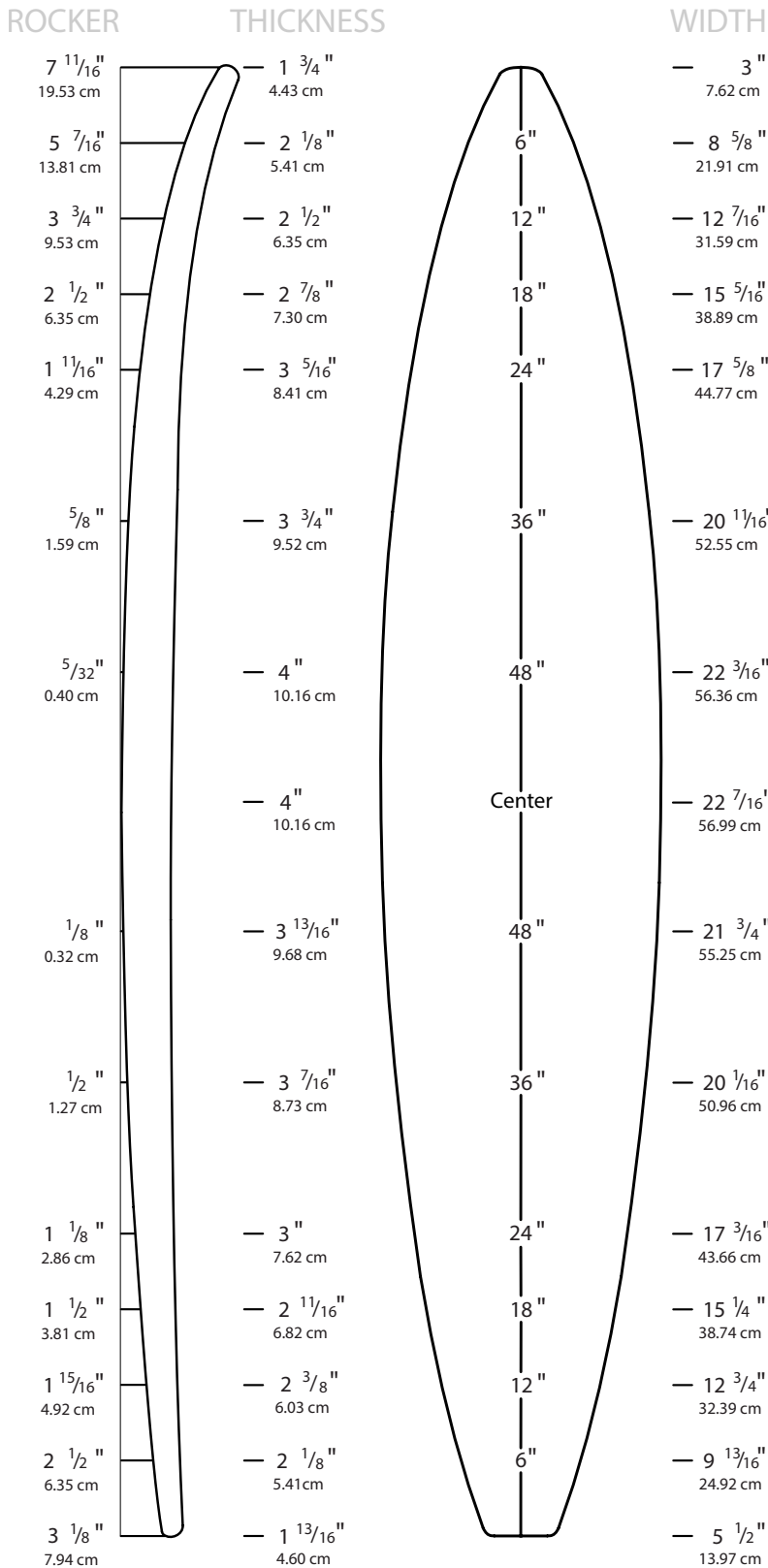

Overall Bottom Length: 9' 9 1/4" (297.82 cm)

Tip-to-tip Deck Length: 9' 8 3/8" (295.59 cm)

Maximum Width: 22 7/16" (56.99 cm)

Maximum Thickness: 4" (10.16 cm)

9'9 A w/ 3/8" added thickness overall

Displacement: 3.57 ft³ (101.4 L)

Introduced: September 2006

Available Rockers:

Designer Comments: This is the 9'9" A with an additional 3/8" thickness. The 9'9" A easily nets a 9'8" bottom length and is intended for big wave paddle guns. The natural rocker is good for vee in the tail and contoured bottom designs. The Hawaii Rocker to be used for hi-performance styles.

(310) 225-6774 - USBlanks.com



Designed by: **Pat Rawson**

USBlanks™

MADE IN AMERICA

9'9" B

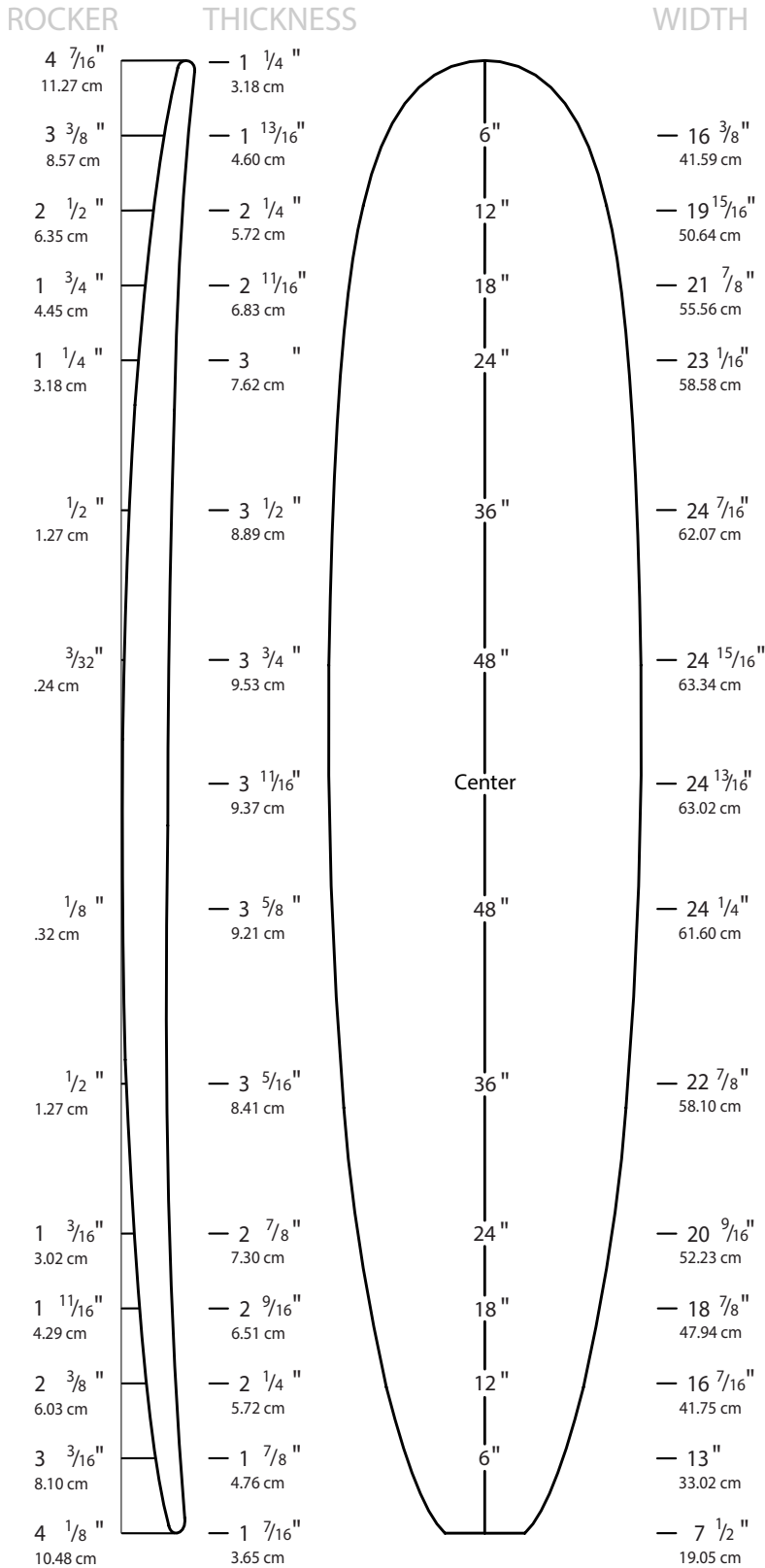

Overall Bottom Length: 9' 9 ⁵/₈" (298.77 cm)

Tip-to-tip Deck Length: 9' 9 ¹/₈" (297.50cm)

Maximum Width: 24 ¹⁵/₁₆" (63.34 cm)

Maximum Thickness: 3 ³/₄" (9.53 cm)

Displacement: 4.022 ft³ (113.9 L)

Introduced: July 2006

Available Rockers:

Designer Comments: Intended for longboard shapes from 9'2" to 9'6", this is a close tolerance blank that will net 24" x 3 ¹/₄" maximum dimensions. Natural rocker will make a nice all-around longboard shape. Rockers from the previous 9'8" will work well with this blank.

Call (310) 225-6774 or visit www.usblanks.com



Designed by: **Bruce Jones**

USBlanks™

MADE IN AMERICA

10'2"B

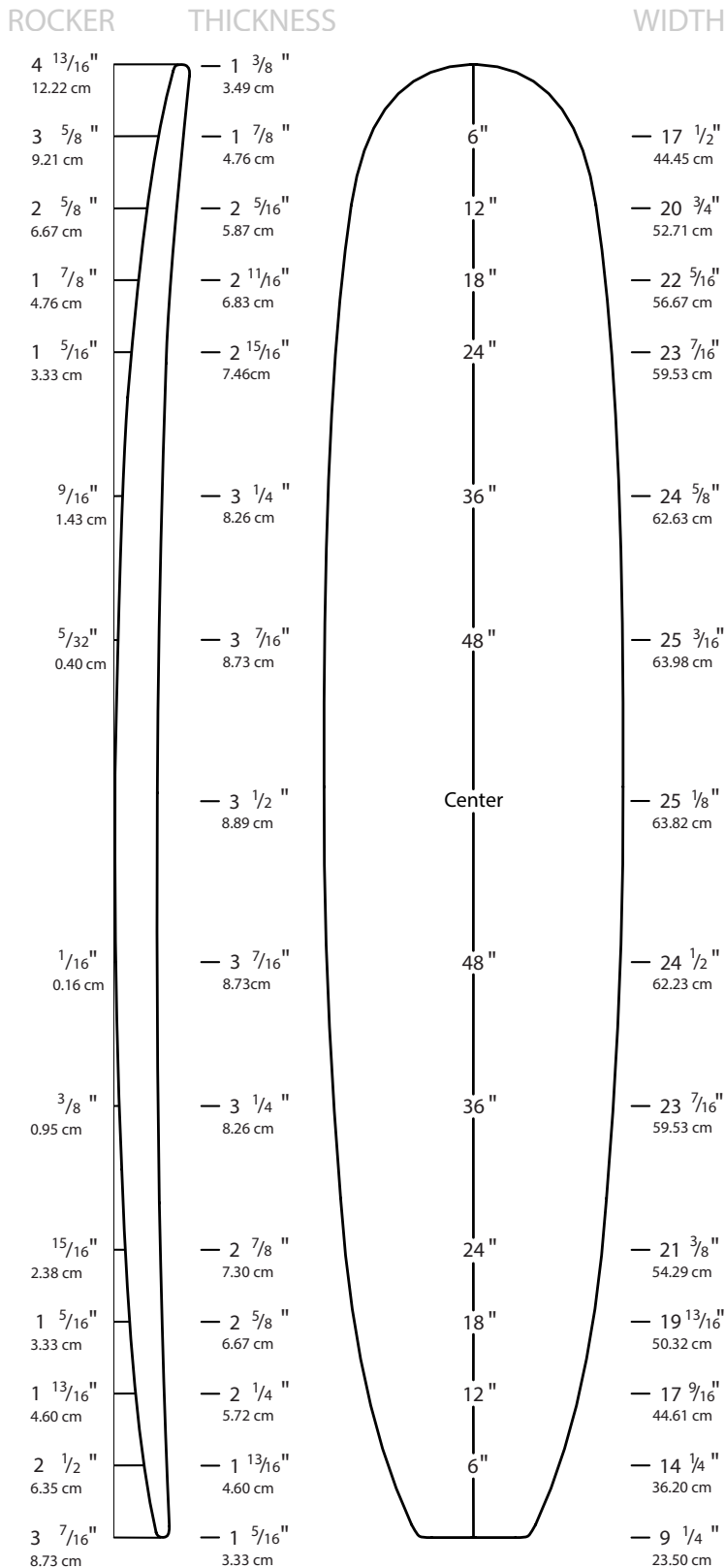

Overall Bottom Length: 10' 2 1/4" (310.52 cm)

Tip-to-tip Deck Length: 10' 1 1/2" (308.61 cm)

Maximum Width: 25 3/16" (63.98 cm)

Maximum Thickness: 3 1/2" (8.89 cm)

Displacement: 4.26 ft³ (120.6 L)

Introduced: July 2006

Available Rockers:

Designer Comments: Intended for longboard shapes from 9'8" to 10'0", this is a close tolerance blank to net 24" x 3 3/8" maximum dimensions. Rockers from the previous 10'1" will work well with this blank. 10'1" Y natural rocker is available for this blank.

Call (310) 225-6774 or visit www.usblanks.com



Designed by: **Bruce Jones**

10'2" BX

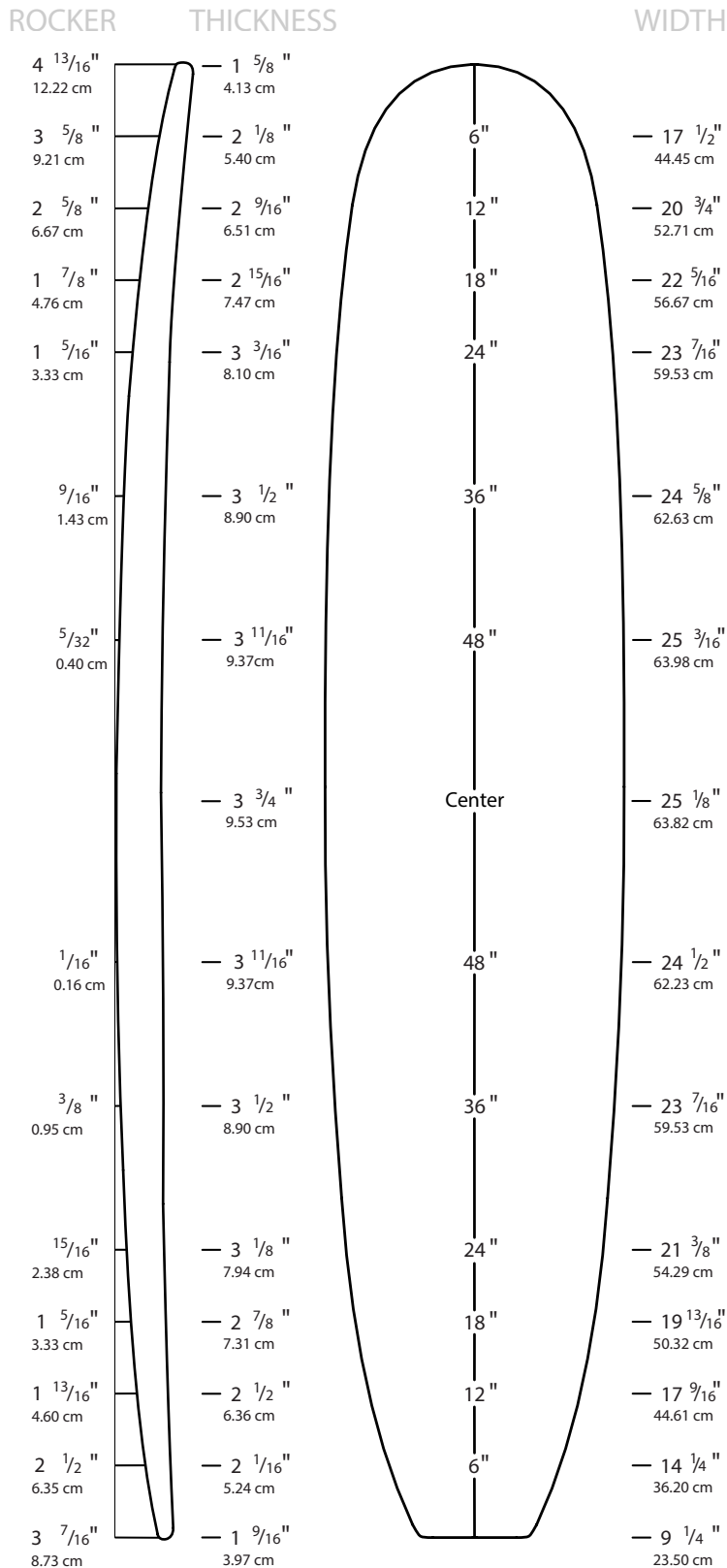

Overall Bottom Length: 10' 2 1/4" (310.52 cm)

Tip-to-tip Deck Length: 10' 1 1/2" (308.61 cm)

Maximum Width: 25 3/16" (63.98 cm)

Maximum Thickness: 3 3/4" (9.53 cm)

10'2 B w/ 1/4" added thickness overall

Displacement: 4.61 ft³ (130.5 L)

Introduced: July 2006

Available Rockers:

Designer Comments: Intended for longboard shapes from 9'8" to 10'0", this is a close tolerance blank to net 24" x 3 3/8" maximum dimensions. Rockers from the previous 10'1" will work well with this blank. 10'1" Y natural rocker is available for this blank.

Call (310) 225-6774 or visit www.usblanks.com



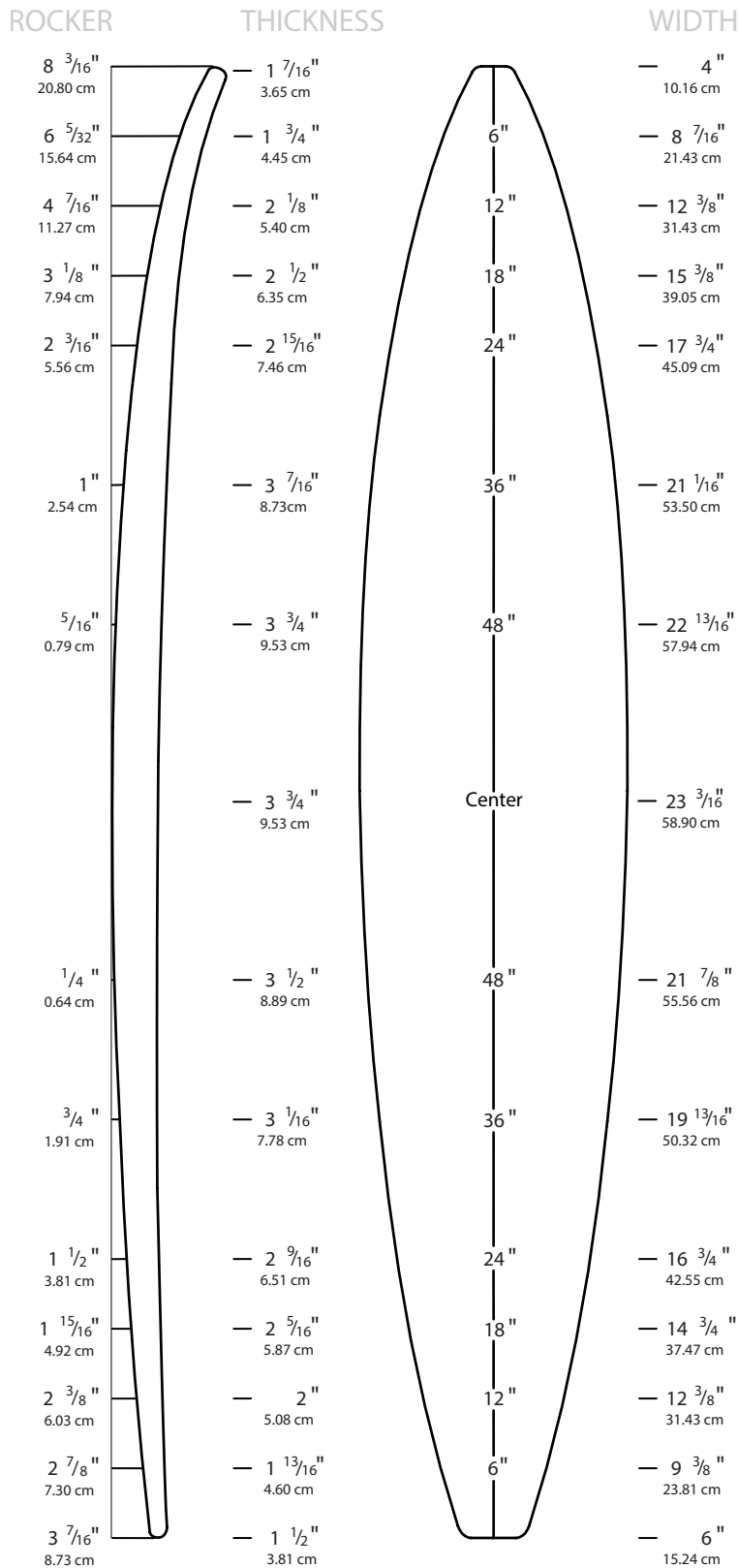

Overall Bottom Length: 10' 6 3/4" (321.95 cm)

Tip-to-tip Deck Length: 10' 5 7/8" (319.72 cm)

Maximum Width: 23 3/16" (58.90 cm)

Maximum Thickness: 3 3/4" (9.53 cm)

Displacement: 3.77 ft³ (106.8 L)

Introduced: September 2006

Available Rockers:

Designer Comments: The 10'6" A easily nets a 10'5" bottom length. The natural rocker is good for vee in the tail and contoured bottom designs. The Hawaii Rocker to be used for hi-performance styles.

(310) 225-6774 - USBlanks.com



10'6" AX

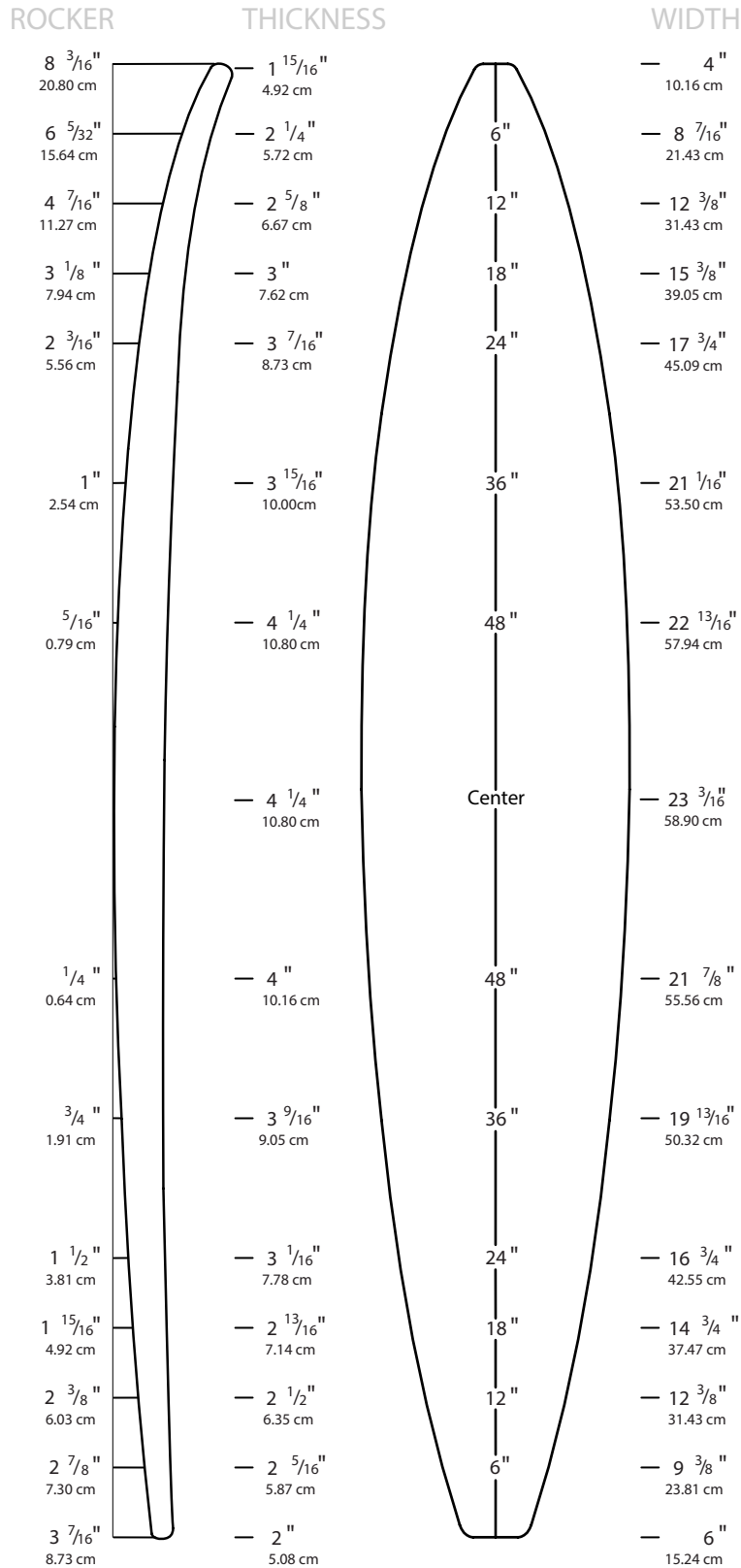

Overall Bottom Length: 10' 6 3/4" (321.95 cm)

Tip-to-tip Deck Length: 10' 5 7/8" (319.72 cm)

Maximum Width: 23 3/16" (58.90 cm)

Maximum Thickness: 4 1/4" (10.80 cm)

10'6 A w/ 1/2" added thickness overall

Displacement: 4.37 ft³ (123.7 L)

Introduced: September 2006

Available Rockers:

Designer Comments: This is the 10'6" A with 1/2" thickness added. The 10'6" A easily nets a 10'5" bottom length. The natural rocker is good for vee in the tail and contoured bottom designs. The Hawaii Rocker to be used for hi-performance styles.

Call (310) 225-6774 or visit www.usblanks.com



USBlanks™

MADE IN AMERICA

10'8" BG

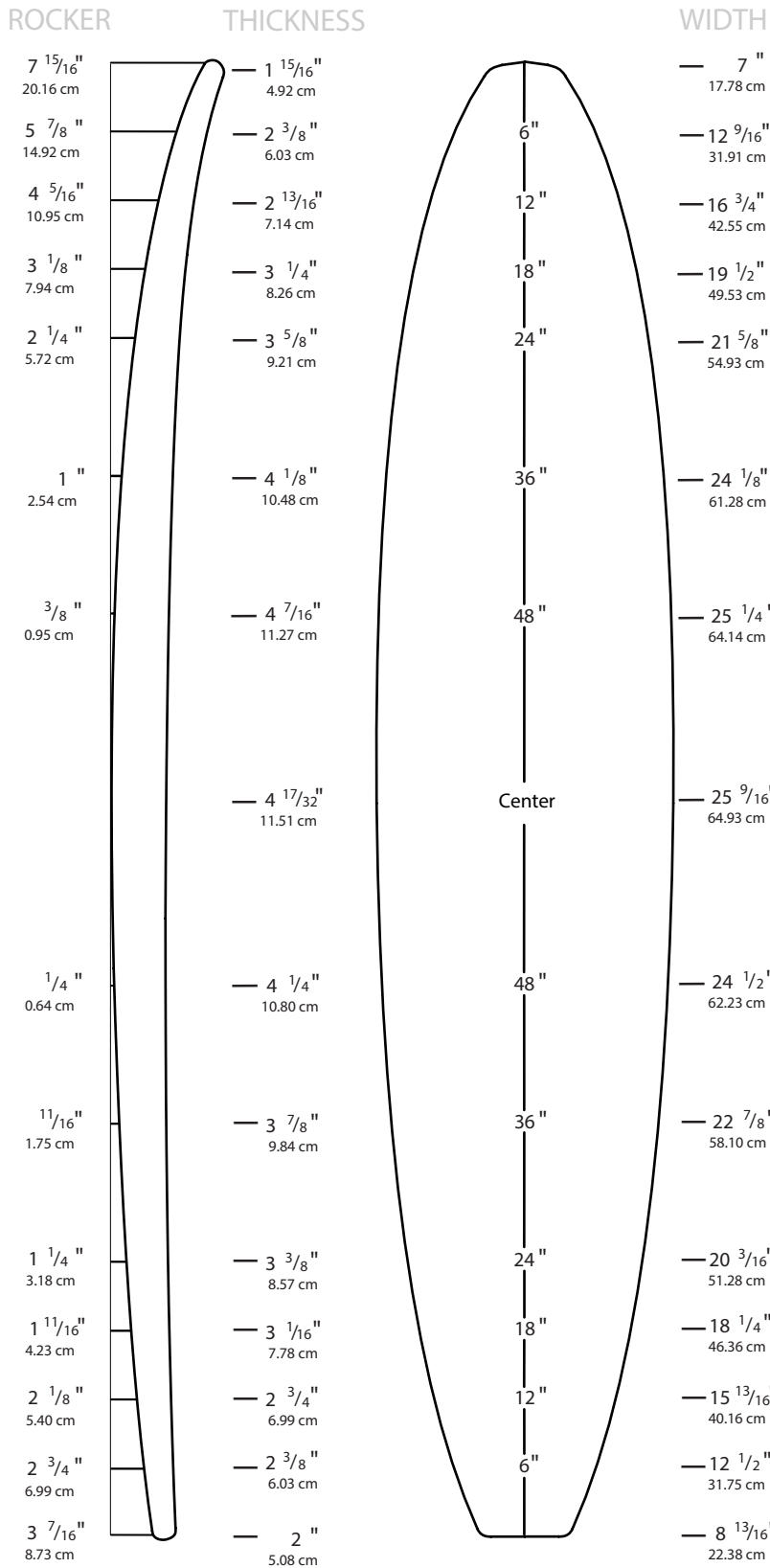

Overall Bottom Length: 10' 9 1/2" (328.93 cm)

Tip-to-tip Deck Length: 10' 8 1/4" (325.76 cm)

Maximum Width: 25 9/16" (64.93 cm)

Maximum Thickness: 4 9/16" (11.59 cm)

Displacement: 5.63 ft³ (159.3 L)

Introduced: November 2013

Available Rockers:

Designer Comments: The 10'8 BG was designed and built by Eric Arakawa and Pat Rawson using a combined effort. "The original plan was to build a combo Big Guy/Gun blank (ala 'BG') that could be offset-cut narrower for performance Guns, but have a built-in, wider stockwidth suitable for many different options. The 9'3" A was used as a conceptual starting point, and the bottom and deck contours are fairly flat in the stringer area to enable ordering an offset cut to net a narrower version (23.5" to 24") without the normal peak at the stringer that more contoured blanks can produce when narrowing by 2"-3". The rocker is universal and the natural rocker should offer many design opportunities, due to the ample thickness in the nose and tail areas.

Call (310) 225-6774 or visit www.usblanks.com



Designed by: **Eric Arakawa & Pat Rawson**

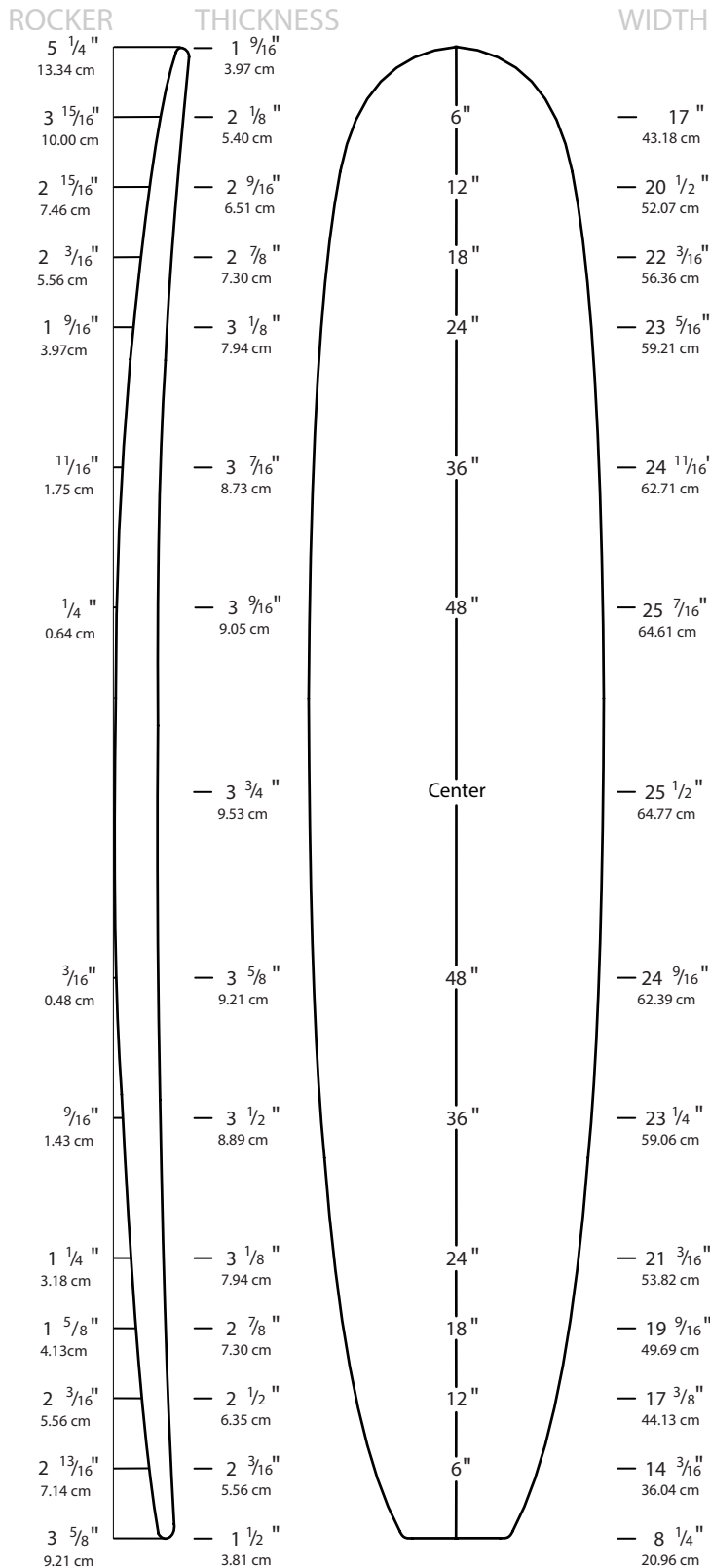

Overall Bottom Length: 10' 7 7/8" (324.80 cm)

Tip-to-tip Deck Length: 10' 7 5/16" (323.37 cm)

Maximum Width: 25 1/2" (64.77 cm)

Maximum Thickness: 3 3/4" (9.53 cm)

Displacement: 4.77 ft³ (135.2 L)

Introduced: September 2006

Available Rockers:

Designer Comments: Designer's Comments: Intended for classic longboard designs under the 10'6" range. The natural rocker is about in the middle of the demand curve. But remember, the further you change the natural rocker curve the wider the wood stringer it needed to hold it from spring back.

Call (310) 225-6774 or visit www.usblanks.com



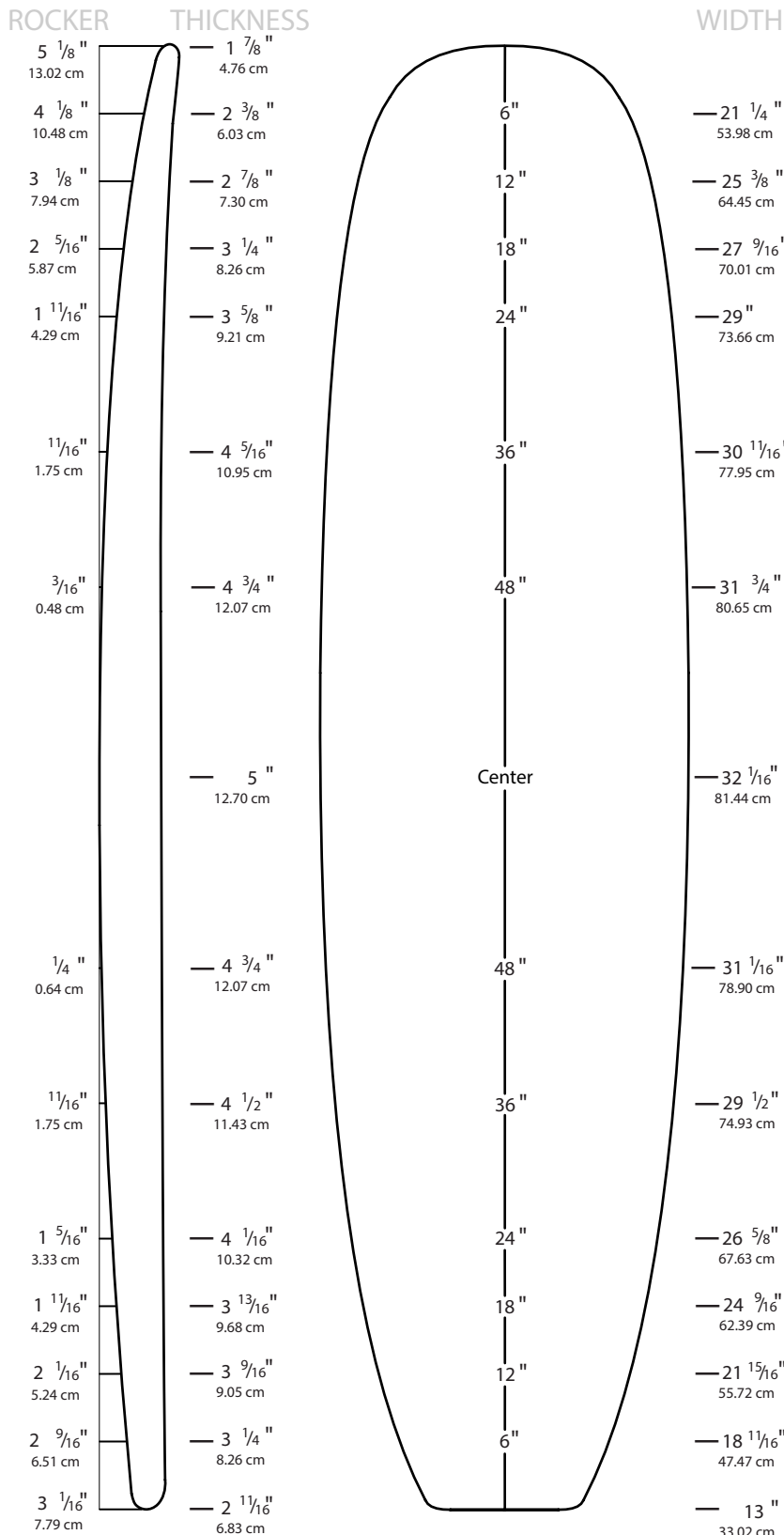

Overall Bottom Length: 10' 9 3/8" (328.61 cm)

Tip-to-tip Deck Length: 10' 9" (327.66 cm)

Maximum Width: 32 1/16" (81.44 cm)

Maximum Thickness: 5" (12.70 cm)

Displacement: 8.31 ft³ (235.3 L)

Introduced: August 2008

Available Rockers:

Designer Comments: I tried to make this Stand Up blank as versatile as possible. It has plenty of width and thickness to do just about anything in a Stand Up Paddle surfboard. The rocker should also allow shapers a wide range of options.

Call (310) 225-6774 or visit www.usblanks.com



ROCKER THICKNESS WIDTH

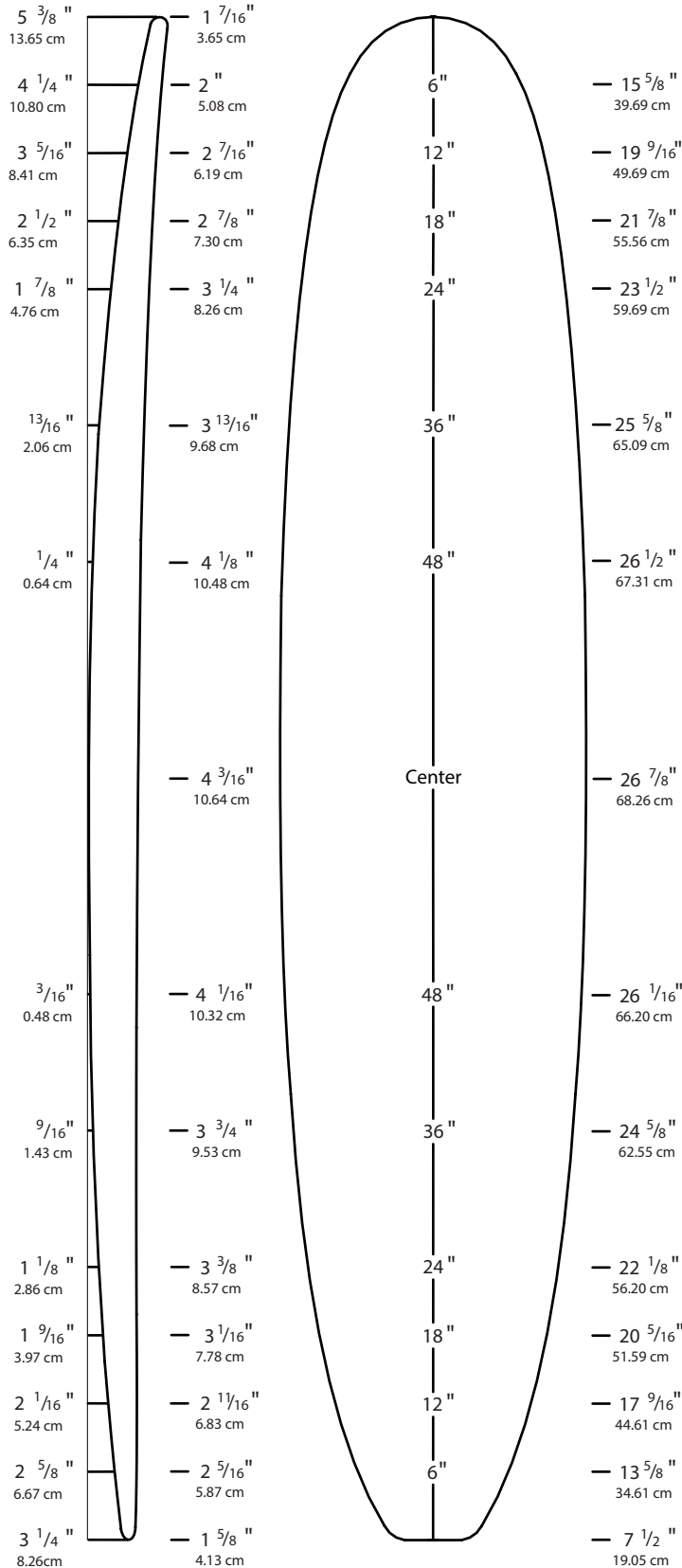

Overall Bottom Length: 11' 2 1/2" (341.63 cm)

Tip-to-tip Deck Length: 11' 2" (340.36 cm)

Maximum Width: 26 7/8" (68.26 cm)

Maximum Thickness: 4 7/32" (10.72 cm)

Displacement: 5.74 ft³ (162.7 L)

Introduced: January 1990. Has proved to be as versatile as outlined in comments. Good proportions for long guns.

Available Rockers:

Designer Comments: "Shaper's Delight" will yield an excellently proportioned 10'6". When finished, it will easily float persons up to 250 lbs. An excellent rental board. Nose rocker can be adjusted up to 6 1/2" or lowered to 4 1/2". Tail rocker can be adjusted up to 1" or down 1/2". Excellent family board. Perfect San Onofre board or for those crowded days at your favorite point break. Great for giving lessons. Perfect for noseriding. May be used for guns with rocker adjustment and width removed from center prior to gluing. Suggested minimum stringer thickness: 3/16".

Special note: All rockers for this blank will not fit on redwood or cedar.

Call (310) 225-6774 or visit www.usblanks.com



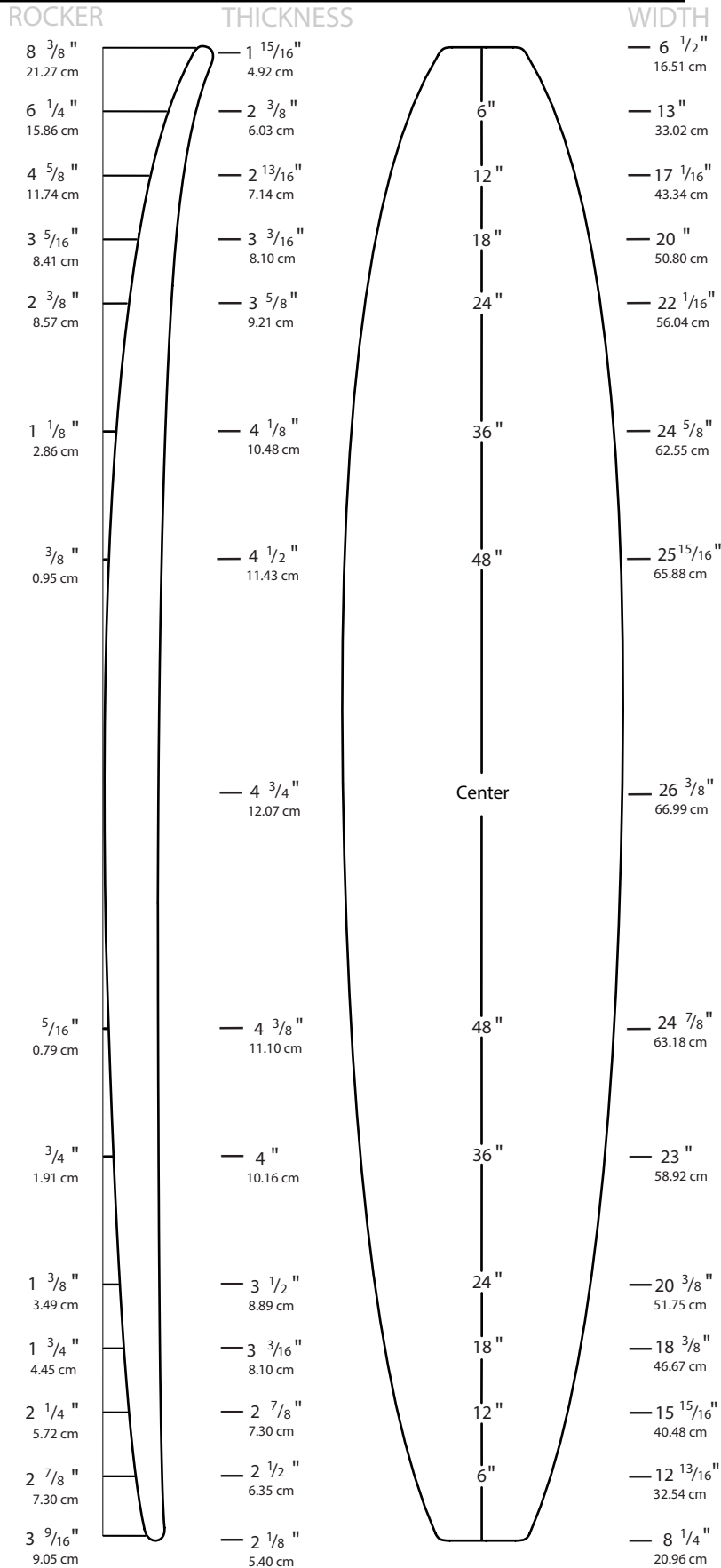

Overall Bottom Length: 11' 9 1/4" (358.78 cm)

Tip-to-tip Deck Length: 11' 8 5/16" (356.39cm)

Maximum Width: 26 3/8" (66.92 cm)

Maximum Thickness: 4 3/4" (12.07cm)

Displacement: 6.70 ft³ (189.7 L)

Introduced: January 2014

Available Rockers:

Shaper's Comments: The 11'8 BG is the big brother to the 10'8 BG, and was designed and built by Pat Rawson and Eric Arakawa using a combined effort. "The original plan was to build a combo Big Guy/Gun blank (ala "BG") that could be offset-cut narrower for performance Guns, but have a built-in, wider stock width suitable for many different options. The 93A was used as a conceptual starting point, and the bottom and deck contours are fairly flat in the stringer area to enable ordering an offset cut to net a narrower version (23.5" to 24") without the normal peak at the stringer that more contoured blanks can produce when narrowing by 2" - 3". The rocker is universal and the natural rocker should offer many design opportunities, due to the ample thickness in the nose and tail areas."

Call (310) 225-6774 or visit www.usblanks.com

Designed by:

**Pat Rawson &
Eric Arakawa**



SUPERFUSED EPS

Our proprietary bead and revolutionary molding and production techniques have allowed us to develop a surfboard specific product that is superior to any other EPS foam on the market today. Our Superfused EPS technology allows us to achieve superior bead fusion, consistency and quality. Combined with our progressive mold designs, we have taken epoxy board building to a whole new level.

Unlike most other EPS manufacturers, our blanks are shape molded under extreme pressure. This allows for superior penetration and bead fusion during the molding process that cannot be achieved in block molding. Combined with our proprietary bead and industry leading production techniques, our process generates fusion characteristics that simply cannot be achieved through other methods. The tight fusion means the foam is considerably more air tight and water tight than any of its predecessors thus eliminating the need for taping or spackling before machining, or spackling / seal coating before glassing. As a result it glasses up lighter and stronger as it absorbs less resin but maintains a superior mechanical bond due to its incredible surface properties.

Our shape molded blanks result in less work for the shaper as our outlines, rockers, and crowned decks allow the craftsman to zero in on the finished shape much more quickly and easily. Our molding capabilities also allow us to produce each blank size in different thicknesses which means you can choose the blank that best suits your shape while cutting down on shaping time and waste.

Due to the incredible strength and memory characteristics of EPS foam many shapers have experienced "spring back" problems in the past when applying forced rocker adjustments to this particular type of foam. By not applying any post induced surface tensions we have eliminated these known "spring back" problems. We accomplish this by starting with an excellent rocker along with increased volume in the nose and tail areas allowing the shaper to accommodate proprietary custom rocker configurations without having to make physical adjustments during the glue up process.

Another extremely important aspect of shape molding is the fact that it cuts down on waste and all EPS scraps are 100% recyclable. Please do your part and check with your local city to see if they offer a recycling program which you can participate in.

All sizes are offered in both 1.7 pcf and 2.0 pcf densities. Combined with our variable thickness capabilities, US Blanks SUPERFUSED EPS has quickly become the most user friendly, versatile, industry leading EPS on the market, and has set a new standard world wide.

ROCKER

THICKNESS

WIDTH

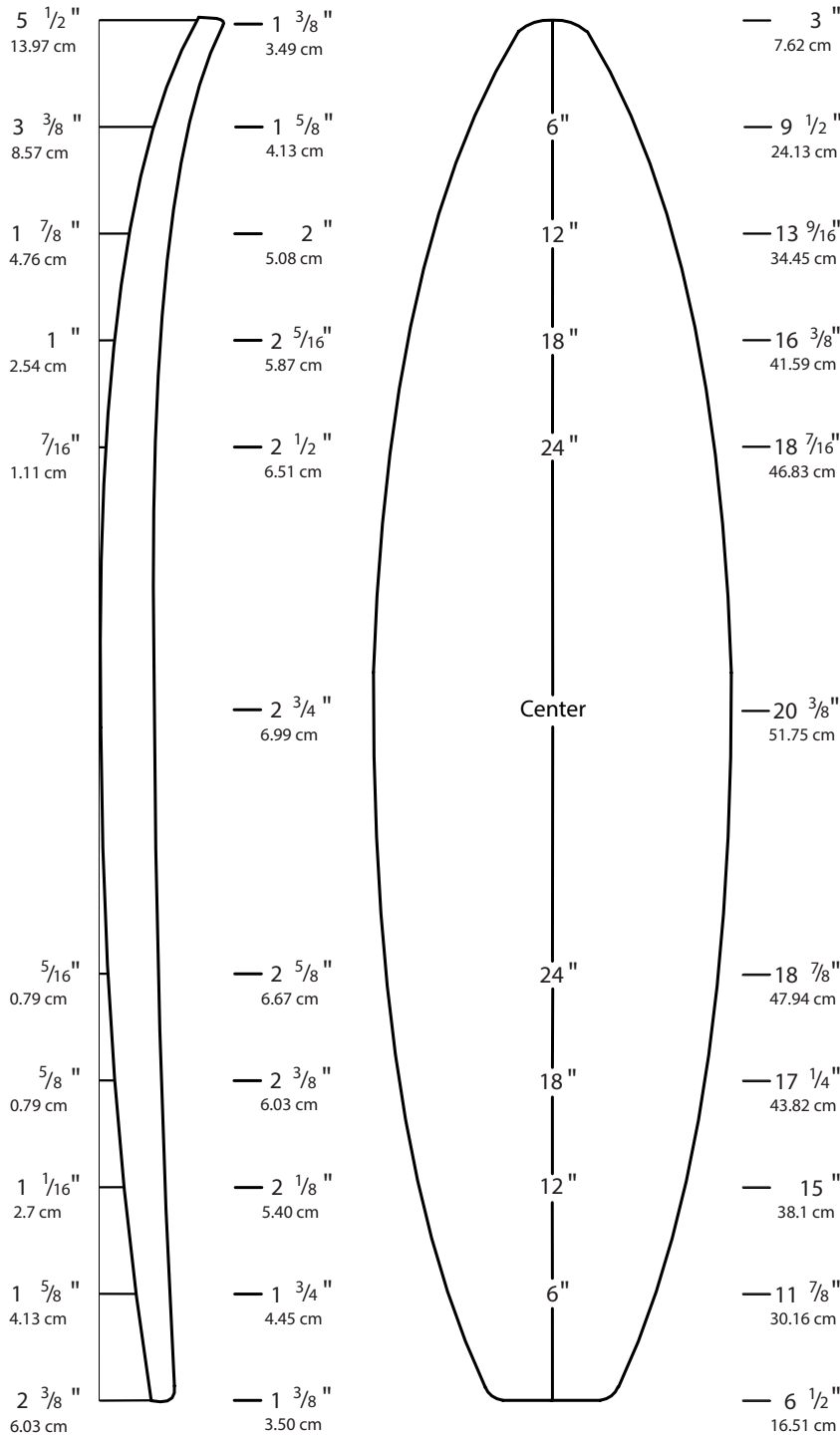

Overall Bottom Length: 6' 5 13/16" (197.64 cm)

Tip-to-tip Deck Length: 6' 4 13/16" (195.10 cm)

Maximum Width: 20 3/8" (51.75 cm)

Maximum Thickness: 2 3/4" (6.99 cm)

Displacement:

Introduced: October 2007

Available Rockers:

Available Densities: 1.7 PCF and 2.0 PCF

Designer Comments: This blank is designed for high performance short boards up to 20-1/4" in width. At 2-3/4" thick it remains versatile and will accept subtle rocker adjustments from center.

(310) 225-6774 - USBlanks.com



ROCKER

THICKNESS

WIDTH

5 1/2" 13.97 cm
 3 3/8" 8.57 cm
 1 7/8" 4.76 cm
 1" 2.54 cm
 7/16" 1.11 cm
 5/16" 0.79 cm
 5/8" 0.79 cm
 1 1/16" 2.7 cm
 1 5/8" 4.13 cm
 2 3/8" 6.03 cm

1 5/8" 4.13 cm
 1 7/8" 4.76 cm
 2 1/4" 5.72 cm
 2 9/16" 6.51 cm
 2 3/4" 6.99 cm
 3" 7.62 cm
 2 7/8" 7.30 cm
 2 5/8" 6.67 cm
 2 3/8" 6.03 cm
 2" 5.08 cm
 1 5/8" 4.13 cm

6"
 12"
 18"
 24"
 Center
 24"
 18"
 12"
 6"

3" 7.62 cm
 9 1/2" 24.13 cm
 13 9/16" 34.45 cm
 16 3/8" 41.59 cm
 18 7/16" 46.83 cm
 20 3/8" 51.75 cm
 18 7/8" 47.94 cm
 17 1/4" 43.82 cm
 15" 38.1 cm
 11 7/8" 30.16 cm
 6 1/2" 16.51 cm

Overall Bottom Length: 6' 5 13/16" (197.64 cm)

Tip-to-tip Deck Length: 6' 4 13/16" (195.10 cm)

Maximum Width: 20 3/8" (51.75 cm)

Maximum Thickness: 3" (7.62 cm)

Displacement:

Introduced: October 2007

Available Rockers:

Available Densities: 1.7 PCF and 2.0 PCF

Designer Comments: At 3" maximum thickness, this blank is identical to the previous version with 1/4" additional thickness along the entire length. Designed for high performance short boards up to 20-1/4" in width, and will also accommodate small Fish models due to the extra thickness. An ideal blank for machine shaping.

(310) 225-6774 - USBlanks.com



6'8" EPS SUPERFUSED

ROCKER

THICKNESS

WIDTH

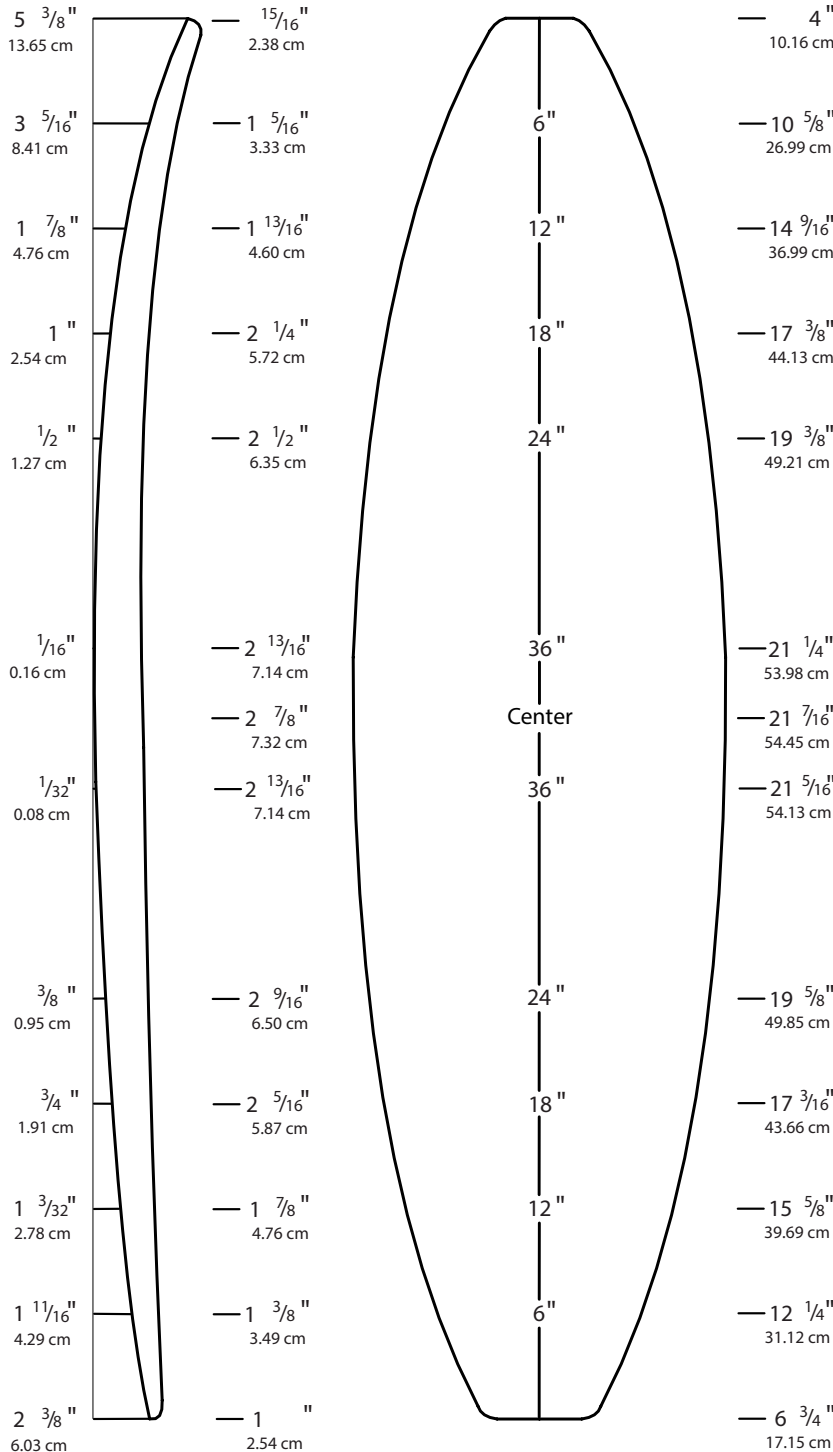

Overall Bottom Length: 6' 9" (205.74 cm)

Tip-to-tip Deck Length: 6' 8" (203.20 cm)

Maximum Width: 21 7/16" (54.45 cm)

Maximum Thickness: 2 7/8" (7.30 cm)

Displacement: Forthcoming

Introduced: February '08

Available Rockers:

Available Densities: 1.7 PCF and 2.0 PCF

Designer Comments: Designed for versatility to accommodate a wide range of board styles from Fishes to Big Guy short boards. The manufacturing process ensures uniform density and fusion throughout, thus allowing the shaper to use the maximum width of the blank if necessary. A closer tolerance version to yeild a quick shape and generate less waste.

(310) 225-6774 - USBlanks.com



ROCKER

5 3/8" 13.65 cm
 3 5/16" 8.41 cm
 1 7/8" 4.76 cm
 1" 2.54 cm
 1/2" 1.27 cm
 1/16" 0.16 cm
 1/32" 0.08 cm
 3/8" 0.95 cm
 3/4" 1.91 cm
 1 3/32" 2.78 cm
 1 11/16" 4.29 cm
 2 3/8" 6.03 cm

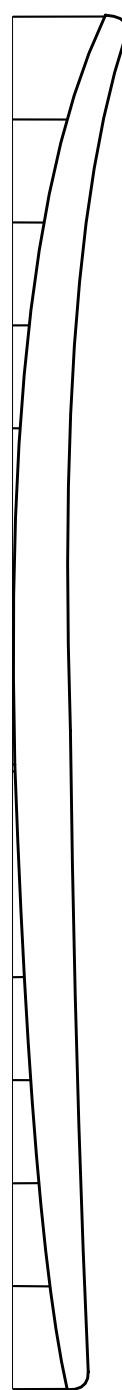

THICKNESS

1 1/4" 3.18 cm
 1 5/8" 4.13 cm
 2 3/16" 5.56 cm
 2 9/16" 6.51 cm
 2 7/8" 7.30 cm
 3 3/16" 8.10 cm
 3 1/4" 8.26 cm
 3 3/16" 8.10 cm
 2 7/8" 7.30 cm
 2 5/8" 6.67 cm
 2 1/4" 5.72 cm
 1 13/16" 4.60 cm
 1 3/8" 3.49 cm

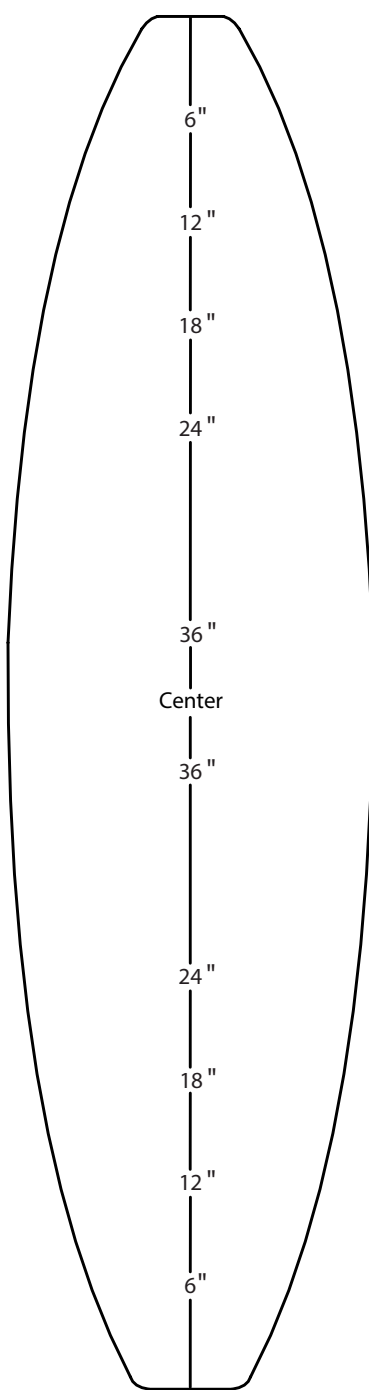

WIDTH

4" 10.16 cm
 10 5/8" 26.99 cm
 14 9/16" 36.99 cm
 17 3/8" 44.13 cm
 19 3/8" 49.21 cm
 21 1/4" 53.98 cm
 21 7/16" 54.45 cm
 21 5/16" 54.13 cm
 19 5/8" 49.85 cm
 17 3/16" 43.66 cm
 15 5/8" 39.69 cm
 12 1/4" 31.12 cm
 6 3/4" 17.15 cm

Overall Bottom Length: 6' 9" (205.74 cm)

Tip-to-tip Deck Length: 6' 8" (203.20 cm)

Maximum Width: 21 7/16" (54.45 cm)

Maximum Thickness: 3 1/4" (8.57 cm)

Displacement: Forthcoming

Introduced: April 2007

Available Rockers:

Available Densities: 1.7 PCF and 2.0 PCF

Designer Comments: "Maximum Volume Version" - Designed for maximum versatility to accommodate a wide range of board styles from Fishes to Big Guy short boards. The manufacturing process ensures uniform density and fusion throughout, thus allowing the shaper to use the maximum width of the blank if necessary. The nose and tail have added volume to yield most types of rockers. A real workhorse blank.

(310) 225-6774 - USBlanks.com



ROCKER

5 13/16" 14.76 cm
3 1/2" 8.89 cm
2 1/16" 5.24 cm
1 1/8" 2.86 cm
9/16" 1.43 cm
1/16" 0.16 cm
1/16" 0.16 cm
1/2" 1.27 cm
13/16" 2.06 cm
1 1/4" 3.18 cm
1 15/16" 4.92 cm
2 7/8" 7.30 cm

THICKNESS

1" 2.54 cm
1 5/16" 3.33 cm
1 7/8" 4.76 cm
2 1/4" 5.72 cm
2 9/16" 6.51 cm
2 7/8" 7.30 cm
2 15/16" 7.46 cm
2 7/8" 7.30 cm
2 9/16" 6.51 cm
2 3/16" 5.56 cm
2 1/8" 5.40 cm
1 9/16" 3.97 cm
1 1/8" 2.86 cm

WIDTH

2 3/4" 6.99 cm
9 5/8" 24.45 cm
13 3/4" 34.93 cm
16 3/4" 42.55 cm
18 13/16" 47.78 cm
21 1/8" 53.66 cm
21 9/16" 54.77 cm
21 1/4" 53.98 cm
19 1/4" 48.90 cm
17 5/8" 44.77 cm
14 13/16" 37.62 cm
11 5/16" 28.73 cm
5" 12.7 cm

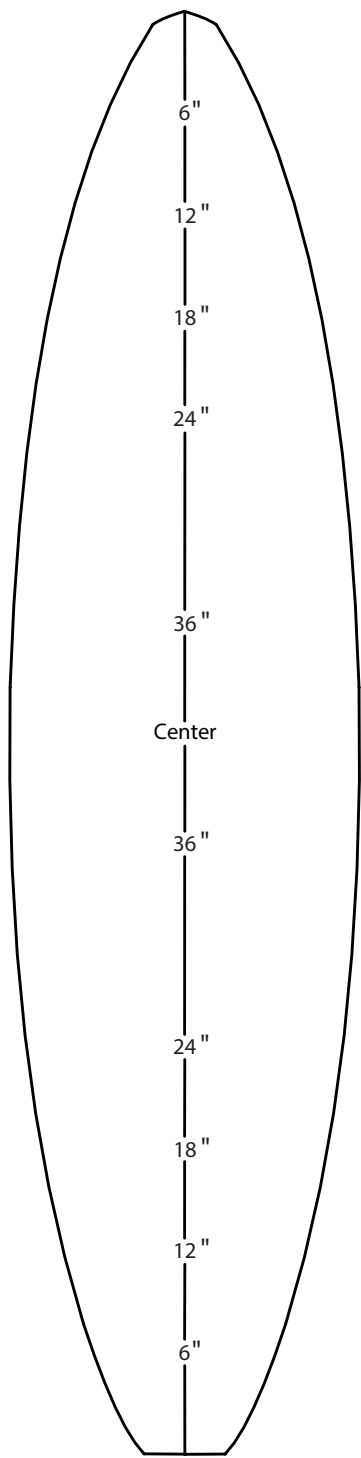

Overall Bottom Length: 7' 2 3/4" (220.35 cm)

Tip-to-tip Deck Length: 7' 1 3/4" (217.81 cm)

Maximum Width: 21 9/16" (54.77 cm)

Maximum Thickness: 2 15/16" (7.46 cm)

Displacement: Forthcoming

Introduced: October 2008

Available Rockers:

Available Densities: 1.7 PCF and 2.0 PCF

Designer Comments: Designed for high performance semi-guns. The added volume in the nose and tail will accommodate a wide variety of rockers.

(310) 225-6774 - USBlanks.com



ROCKER

5 13/16" 14.76 cm
 3 1/2" 8.89 cm
 2 1/16" 5.24 cm
 1 1/8" 2.86 cm
 9/16" 1.43 cm
 1/16" 0.16 cm
 1/16" 0.16 cm
 1/2" 1.27 cm
 13/16" 2.06 cm
 1 1/4" 3.18 cm
 1 15/16" 4.92 cm
 2 7/8" 7.30 cm

THICKNESS

1 3/8" 3.49 cm
 1 11/16" 4.29 cm
 2 1/4" 5.72 cm
 2 5/8" 6.67 cm
 2 15/16" 7.46 cm
 3 1/4" 8.26 cm
 3 5/16" 8.41 cm
 3 1/4" 8.26 cm
 2 13/16" 7.14 cm
 2 9/16" 6.51 cm
 2 1/2" 6.35 cm
 1 15/16" 4.92 cm
 1 1/2" 3.81 cm

WIDTH

2 3/4" 6.99 cm
 9 5/8" 24.45 cm
 13 3/4" 34.93 cm
 16 3/4" 42.55 cm
 18 13/16" 47.78 cm
 21 1/8" 53.66 cm
 21 9/16" 54.77 cm
 21 1/4" 53.98 cm
 19 1/4" 48.90 cm
 17 5/8" 44.77 cm
 14 13/16" 37.62 cm
 11 5/16" 28.73 cm
 5" 12.7 cm

6"
 12"
 18"
 24"
 36"
 Center
 36"
 24"
 18"
 12"
 6"

Overall Bottom Length: 7' 2 3/4" (220.35 cm)

Tip-to-tip Deck Length: 7' 1 3/4" (217.81 cm)

Maximum Width: 21 9/16" (54.77 cm)

Maximum Thickness: 3 5/16" (8.41 cm)

Displacement: Forthcoming

Introduced: June 2007

Available Rockers:

Available Densities: 1.7 PCF and 2.0 PCF

Designer Comments: "Maximum Volume Version"

- Designed for high performance semi-guns. The added volume in the nose and tail will accommodate a wide variety of rockers.

(310) 225-6774 - USBlanks.com



USBlanks™

MADE IN AMERICA

7'8" EPS SUPERFUSED

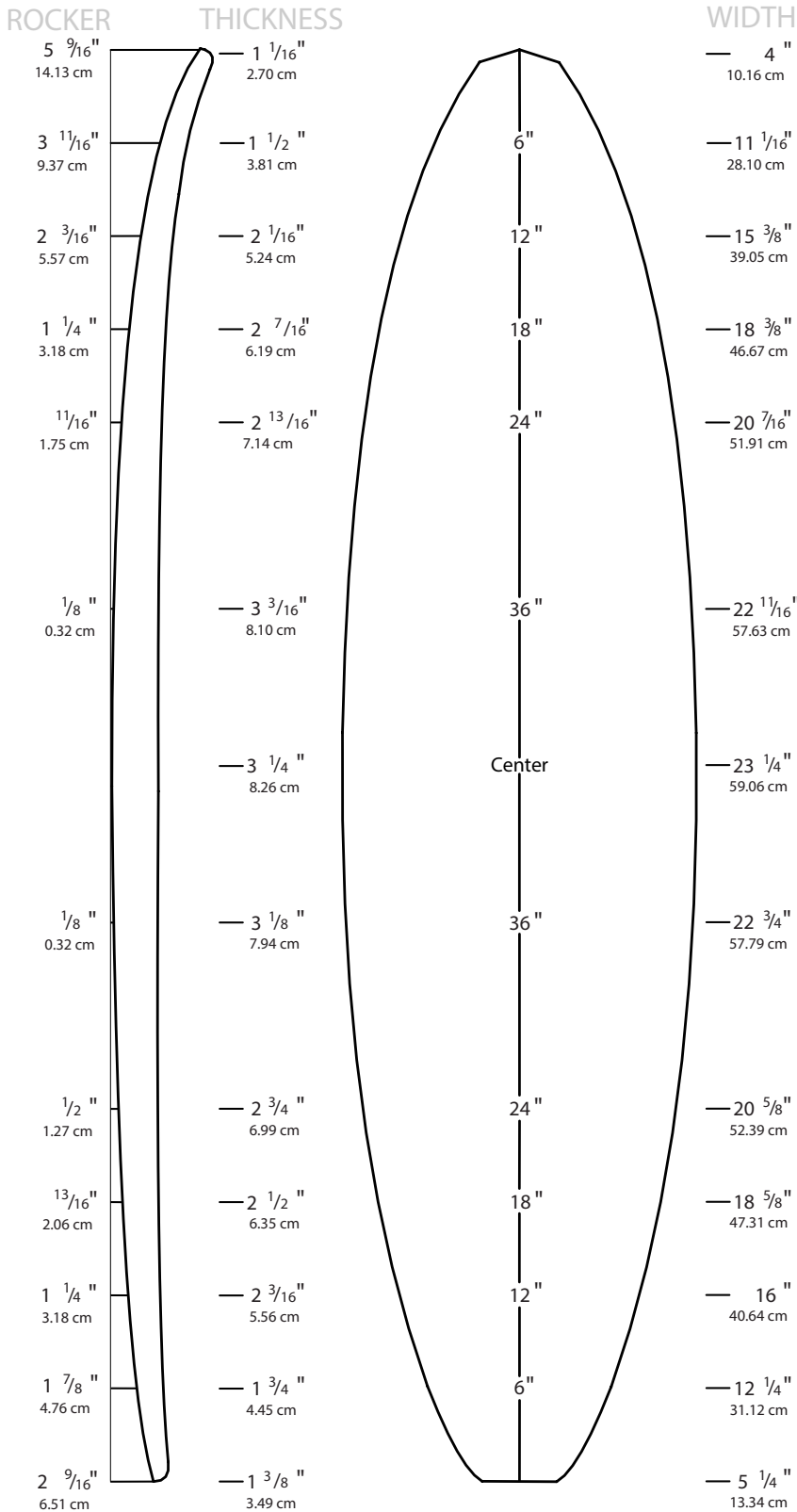

Overall Bottom Length: 7' 9" (236.22 cm)

Tip-to-tip Deck Length: 7' 7 7/8" (233.36 cm)

Maximum Width: 23 1/4" (59.06 cm)

Maximum Thickness: 3 1/4" (8.26 cm)

Displacement: Forthcoming

Introduced: March 2009

Available Rockers:

Available Densities: 1.7 PCF and 2.0 PCF

Designer Comments: This is a multi-purpose blank which can be used for Fun Boards, Big Guy boards and Guns. The extra volume will accommodate a wide variety of rocker configurations.

(310) 225-6774 - USBlanks.com



Designed by: **Eric Arakawa**

USBlanks™

MADE IN AMERICA

7'8" EPS SUPERFUSED

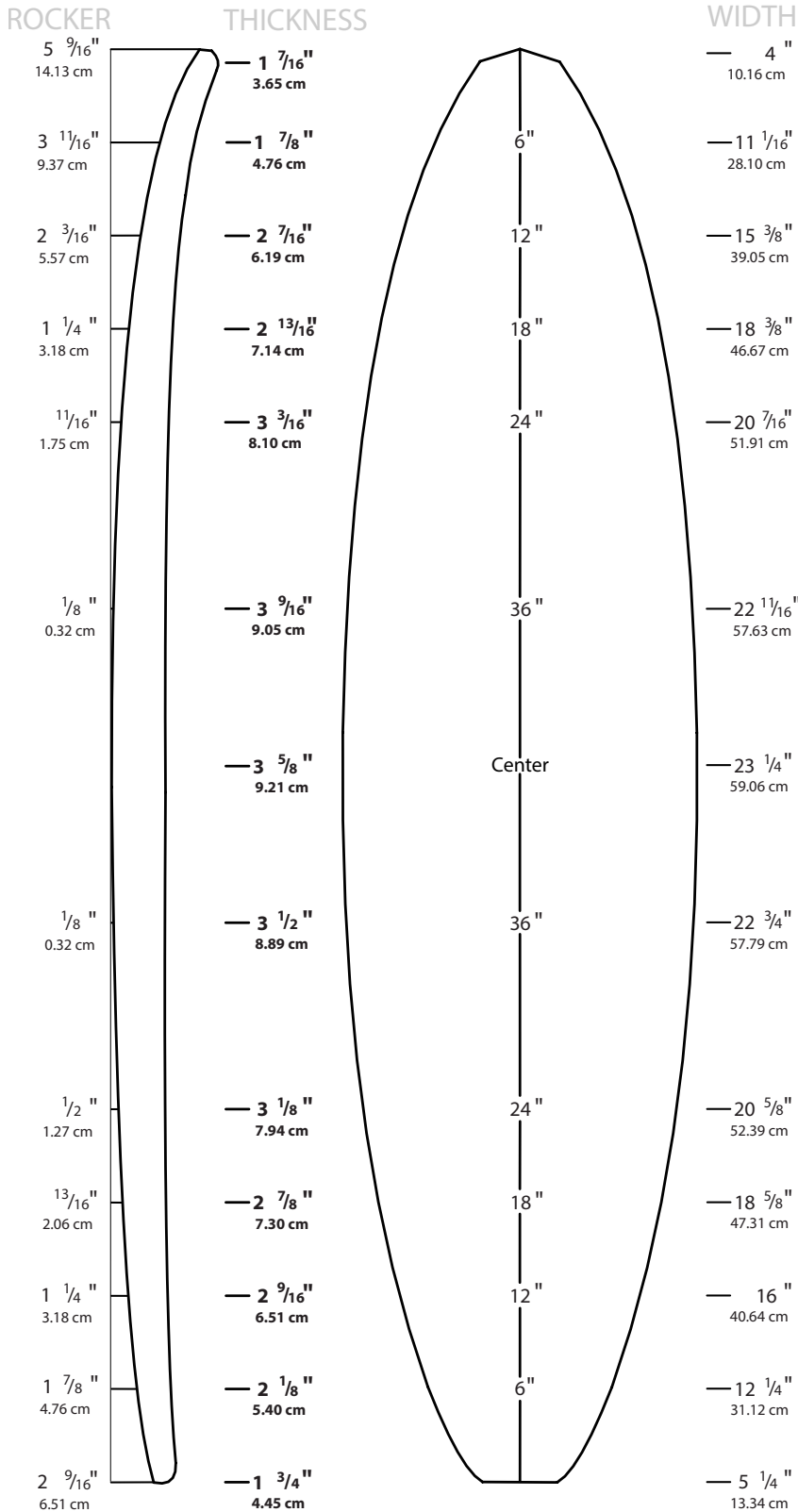

Overall Bottom Length: 7' 9" (236.22 cm)

Tip-to-tip Deck Length: 7' 7 7/8" (233.36 cm)

Maximum Width: 23 1/4" (59.06 cm)

Maximum Thickness: 3 5/8" (9.21 cm)

Displacement: Forthcoming

Introduced: June 2007

Available Rockers:

Available Densities: 1.7 PCF and 2.0 PCF

Designer Comments: "Maximum Volume Version"

- This is a multi-purpose blank which can be used for Fun Boards, Big Guy boards and Guns. The extra volume will accommodate a wide variety of rocker configurations.

(310) 225-6774 - USBlanks.com



Designed by: **Eric Arakawa**

USBlanks™

MADE IN AMERICA

8'8" EPS SUPERFUSED

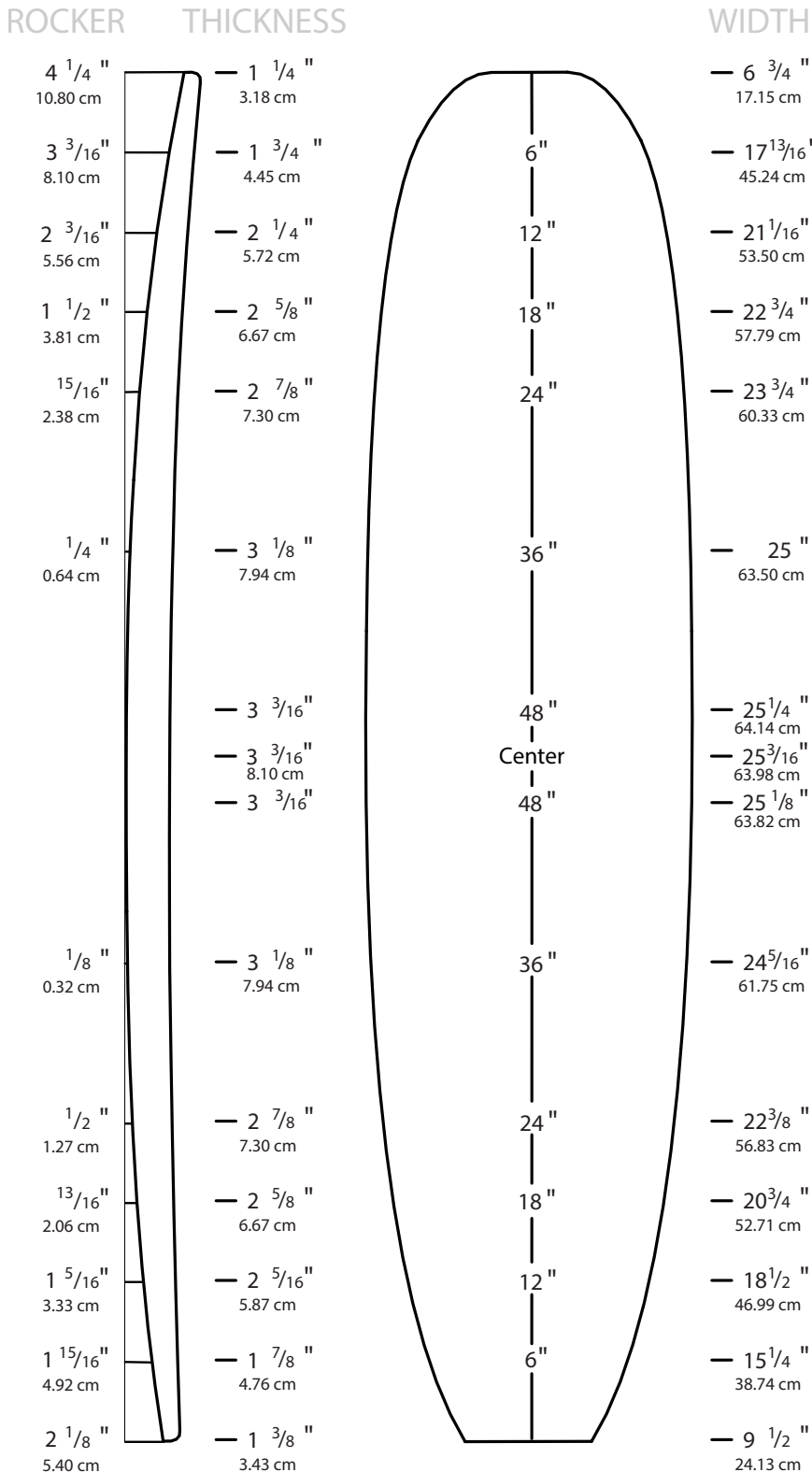

Overall Bottom Length: 8' 7 7/8" (263.84 cm)

Tip-to-tip Deck Length: 8' 7" (261.62 cm)

Maximum Width: 25 1/4" (64.14 cm)

Maximum Thickness: 3 3/16" (8.10 cm)

Displacement: Forthcoming

Introduced: March 2009

Available Rockers:

Available Densities: 1.7 PCF and 2.0 PCF

Designer Comments: This blank is a scaled down version of the 9'8" EPS. The goal was to design an EPS mold plug that would accommodate any longboard shape program in the 7'10" to 8'6" range for machine cutting purposes. After analyzing our rocker template data base we came up with a "middle of the road" rocker profile, and added thickness to the nose and tail to allow for straight to extreme rocker profiles. The plan shape and width have also been maximized. This blank is offered in 2 different thicknesses to accommodate for both machine shaping and hand shaping.

(310) 225-6774 - USBlanks.com



Designed by: **Renny Yater**

USBlanks™

MADE IN AMERICA

8'8" EPS SUPERFUSED

ROCKER

THICKNESS

WIDTH

- 4 1/4" / 10.80 cm
- 3 3/16" / 8.10 cm
- 2 3/16" / 5.56 cm
- 1 1/2" / 3.81 cm
- 15/16" / 2.38 cm
- 1/4" / 0.64 cm
- 1/8" / 0.32 cm
- 1/2" / 1.27 cm
- 13/16" / 2.06 cm
- 1 5/16" / 3.33 cm
- 1 15/16" / 4.92 cm
- 2 1/8" / 5.40 cm

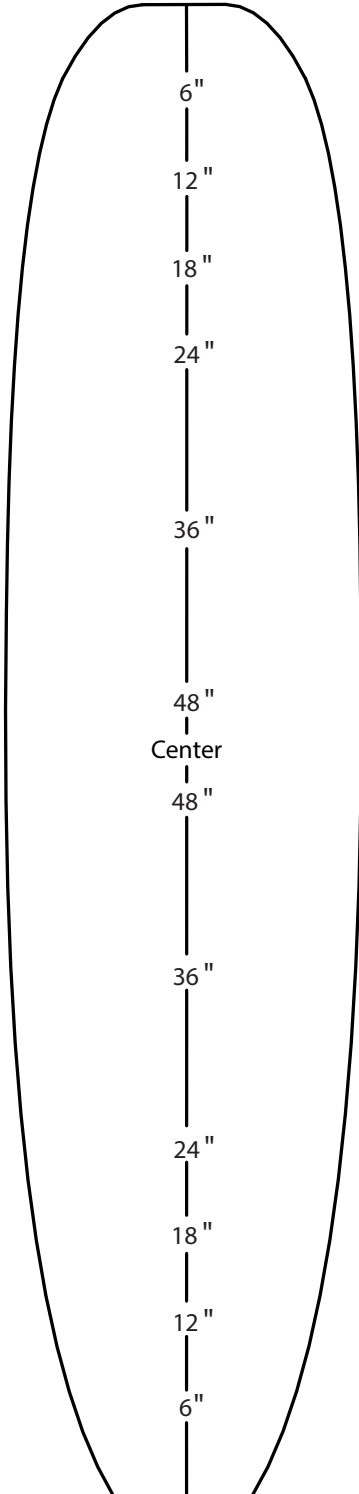

- 6 3/4" / 17.15 cm
- 17 13/16" / 45.24 cm
- 21 1/16" / 53.50 cm
- 22 3/4" / 57.79 cm
- 23 3/4" / 60.33 cm
- 25" / 63.50 cm
- 25 1/4" / 64.14 cm
- 25 3/16" / 63.98 cm
- 25 1/8" / 63.82 cm
- 24 5/16" / 61.75 cm
- 22 3/8" / 56.83 cm
- 20 3/4" / 52.71 cm
- 18 1/2" / 46.99 cm
- 15 1/4" / 38.74 cm
- 9 1/2" / 24.13 cm

Overall Bottom Length: 8' 7 7/8" (263.84 cm)
 Tip-to-tip Deck Length: 8' 7" (261.62 cm)
 Maximum Width: 25 1/4" (64.14 cm)
 Maximum Thickness: 3 9/16" (9.05 cm)
 Displacement: Forthcoming

Introduced: December 2014

Available Rockers:

Available Densities: 1.7 pcf and 2.0 pcf

Designer Comments: "Maximum Volume Version"
 This blank is a scaled down version of the 9'8" EPS. The goal was to design an EPS mold plug that would accommodate any longboard shape program in the 7'10" to 8'6" range for machine cutting purposes. After analyzing our rocker template data base we came up with a "middle of the road" rocker profile, and added thickness to the nose and tail to allow for straight to extreme rocker profiles. The plan shape and width have also been maximized. This blank is offered in 2 different thicknesses to accommodate for both machine shaping and hand shaping.

(310) 225-6774 - USBlanks.com



Designed by: Renny Yater

USBlanks™

MADE IN AMERICA

9'8" EPS SUPERFUSED

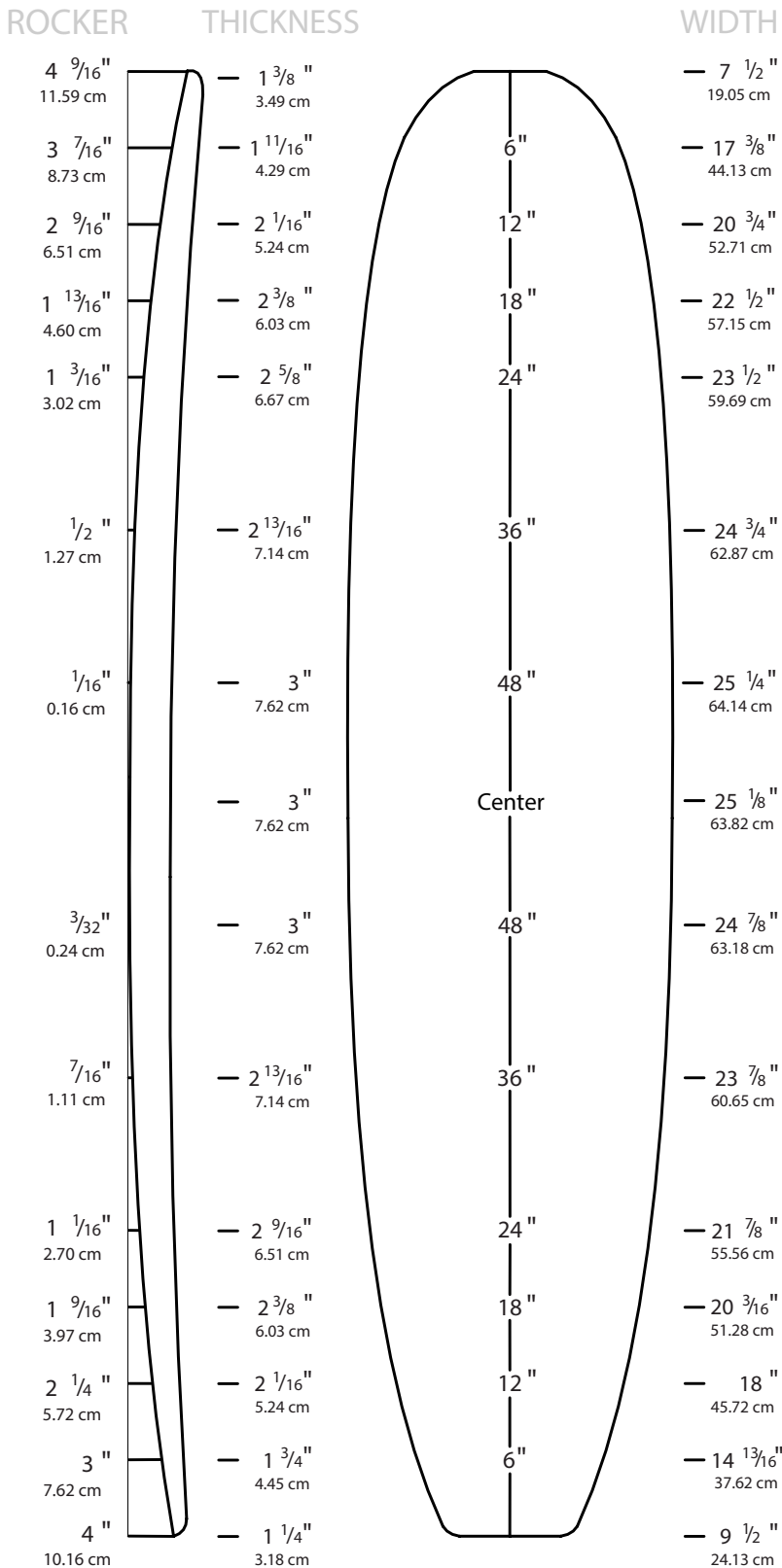

Overall Bottom Length: 9' 8" (274.32 cm)
 Tip-to-tip Deck Length: 9' 7 1/4" (274.96 cm)
 Maximum Width: 25 1/4" (64.14 cm)
 Maximum Thickness: 3" (7.62 cm)
 Displacement: Forthcoming
 Introduced: December 2007

Available Rockers:

Available Densities: 2.0 PCF

Designer Comments: This blank is the result of input by several people within the surfboard manufacturing industry. The goal was to design an EPS mold plug that would accommodate any longboard shape program in the 8'10" to 9'6" range for machine cutting purposes. After analyzing all the rocker templates in our data base we came up with a "middle of the road" rocker profile, and added thickness to the nose and tail to allow for straight to extreme rocker profiles. The plan shape and width have also been maximized. This blank is offered in 3 different thicknesses to accommodate for both machine shaping and hand shaping. This is the minimum volume version.

(310) 225-6774 - USBlanks.com



Designed by: **Renny Yater**

USBlanks™

MADE IN AMERICA

9'8" EPS SUPERFUSED

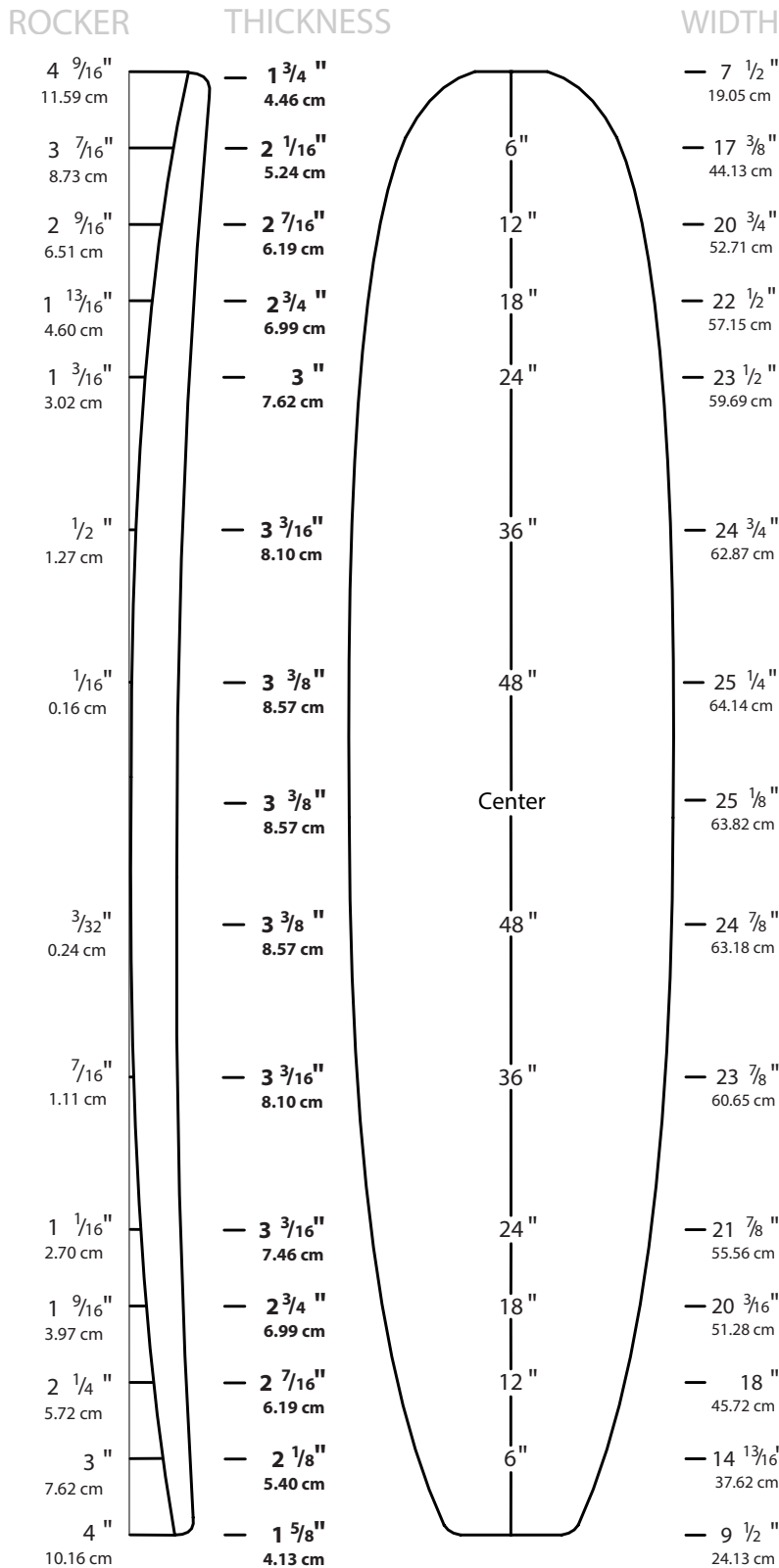

Overall Bottom Length: 9' 8" (274.32 cm)
 Tip-to-tip Deck Length: 9' 7 1/4" (274.96 cm)
 Maximum Width: 25 1/4" (64.14 cm)
 Maximum Thickness: 3 3/8" (8.57 cm)
 Displacement: Forthcoming
 Introduced: December 2007

Available Rockers:

Available Densities: 2.0 PCF

Designer Comments: This blank is the result of input by several people within the surfboard manufacturing industry. The goal was to design an EPS mold plug that would accommodate any longboard shape program in the 8'10" to 9'6" range for machine cutting purposes. After analyzing all the rocker templates in our data base we came up with a "middle of the road" rocker profile, and added thickness to the nose and tail to allow for straight to extreme rocker profiles. The plan shape and width have also been maximized. This blank is offered in 3 different thicknesses to accommodate for both machine shaping and hand shaping. This is the medium volume version.

(310) 225-6774 - USBlanks.com



Designed by: **Renny Yater**

USBlanks™

MADE IN AMERICA

9'8XX" EPS SUPERFUSED

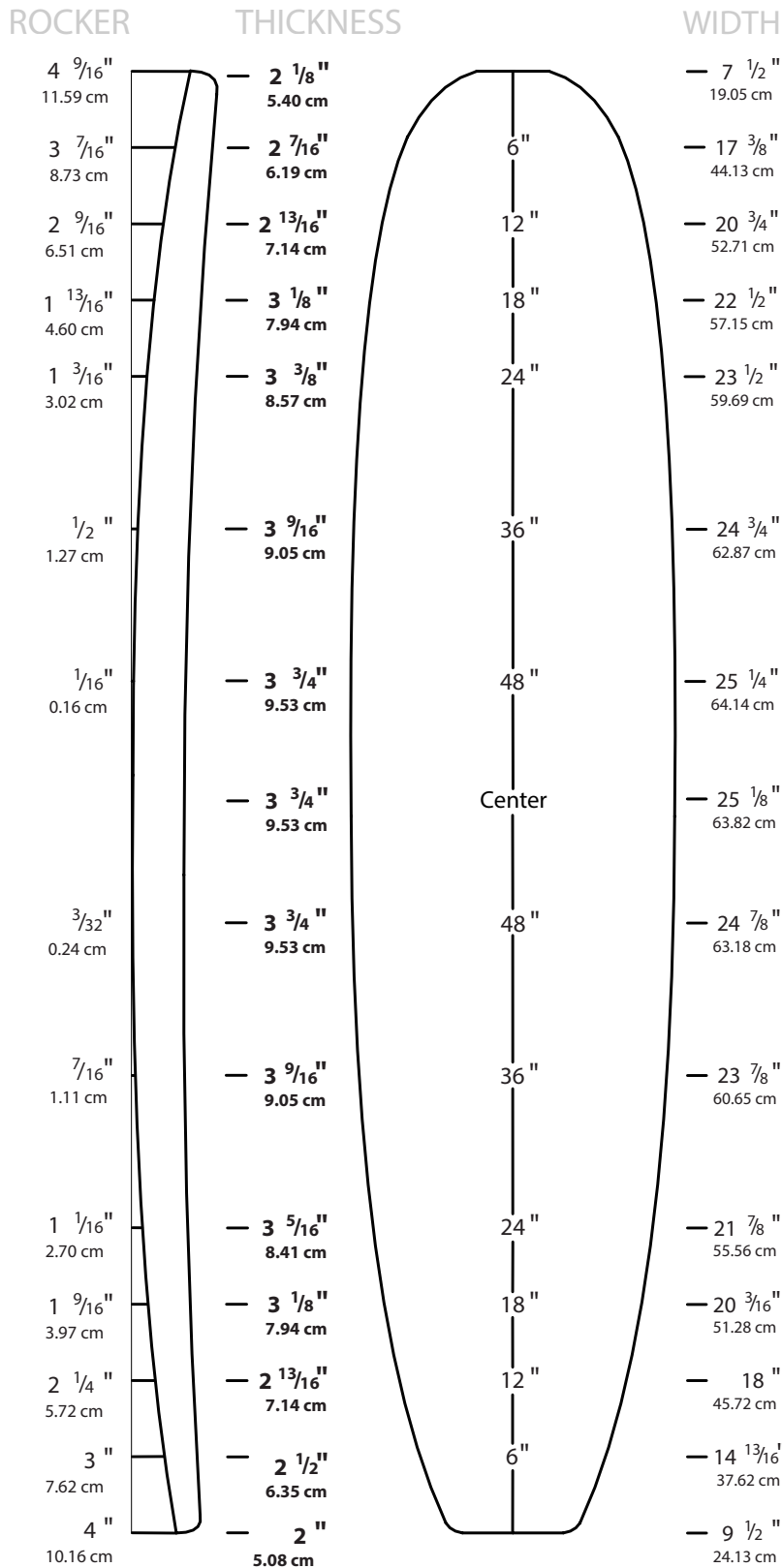

Overall Bottom Length: 9' 8" (274.32 cm)
 Tip-to-tip Deck Length: 9' 7 1/4" (274.96 cm)
 Maximum Width: 25 1/4" (64.14 cm)
 Maximum Thickness: 3 3/4" (9.53 cm)
 Displacement: Forthcoming
 Introduced: December 2007

Available Rockers:

Available Densities: 2.0 PCF

Designer Comments: This blank is the result of input by several people within the surfboard manufacturing industry. The goal was to design an EPS mold plug that would accommodate any longboard shape program in the 8'10" to 9'6" range for machine cutting purposes. After analyzing all the rocker templates in our data base we came up with a "middle of the road" rocker profile, and added thickness to the nose and tail to allow for straight to extreme rocker profiles. The plan shape and width have also been maximized. This blank is offered in 3 different thicknesses to accommodate for both machine shaping and hand shaping. This is the maximum volume version.

(310) 225-6774 - USBlanks.com



Designed by: **Renny Yater**

USBlanks™ EPS BLOCK CUT BLANKS

Manufactured from White Hot Surfboard Foam Billets

Available in 1.5 lb. or 2.0 lb. Density

Size	Type -Shaper	Standard Stringer	Length	Width	Nose Rocker	Tail Rocker	Center Thick.	Nose Thick.	Tail Thick.
6'0"P	Short Board - Patterson	Ply	73.00	20.06	4.63	1.69	2.38	0.88	1.06
6'2"A	Fish - Rawson	Ply	74.25	23.50	4.75	1.81	3.15	1.35	1.45
6'3"RS	Short Board - Rusty	Ply	75.00	21.00	4.87	2.00	2.62	1.25	1.37
63RSX	Short Board - Rusty	Ply	75.00	21.00	4.87	2.00	2.90	1.50	1.65
6'3"WH	Short Board - Rusty	Ply	75.75	20.60	5.60	1.73	2.75	1.40	1.50
6'3"WHX	Short Board - Rusty	Ply	75.75	20.60	5.60	1.73	3.15	1.75	1.87
6'5"A	Fish - Rawson	Ply	77.25	23.50	5.25	1.81	3.35	1.13	1.38
6'8"WH	Short Board - Rusty	Ply	79.00	21.75	5.25	2.34	2.88	1.15	1.25
6'8"WHX	Short Board - Rusty	Ply	79.00	21.75	5.25	2.34	3.50	1.75	1.85
6'9"RS	Short Board - Rusty	Ply	81.00	22.00	5.81	2.40	2.87	1.75	1.25
69RSX	Short Board - Rusty	Ply	81.00	22.00	5.81	2.40	3.18	1.50	1.50
6'10"A	Fish - Rawson	Ply	81.67	24.13	5.19	2.00	3.50	1.38	1.65
7'3"A	Fish - Rawson	1/8" Bass	87.04	24.11	5.50	2.13	3.63	1.38	1.50
7'5"A	Short Board - Rawson	1/8" Bass	87.96	22.06	6.13	2.19	3.00	0.88	1.38
8'1"EA	Short Board - Arakawa	1/8" Bass	96.05	24.14	6.44	2.57	3.44	1.00	1.32
9'2"A	Gun - Rawson	1/8" Bass	110.40	22.46	7.57	2.75	3.57	1.39	1.28
9'3"Y	Long Board - Yater	1/8" Bass	111.30	24.50	4.38	3.50	3.25	1.73	1.41
9'4"B	Long Board - Jones	1/8" Bass	111.44	24.50	4.88	3.63	3.25	0.90	1.32
9'8"Y	Long Board - Yater	1/8" Bass	116.40	24.50	4.50	3.69	3.63	1.45	1.55
9'9"A	Gun - Rawson	1/8" Bass	116.90	22.50	7.75	3.25	3.69	1.38	1.44
10'2"B	Long Board - Jones	1/8" Bass	122.22	24.50	4.82	3.82	3.73	1.27	1.58
9'6"A	SUP	1/8" Bass	114.00	32.00	5.25	4.25	4.93	2.25	1.25
10'0"	SUP	1/8" Bass	120.00	32.00	5.50	4.31	4.93	2.25	1.31
10'4"A	SUP	1/8" Bass	124.00	32.00	4.56	3.75	4.88	2.06	1.81
10'4"B	SUP	1/8" Bass	124.00	32.00	6.25	4.38	4.81	2.31	1.69
11'2"A	SUP	1/8" Bass	134.00	32.00	5.25	4.19	5.00	1.86	1.86
11'2"B	SUP	1/8" Bass	134.00	32.00	6.75	4.75	5.06	2.50	1.81
12'1"	SUP	1/8" Bass	145.00	32.00	6.13	3.38	5.19	2.56	2.50
12'6"A	SUP	1/8" Bass	150.00	32.00	6.31	3.50	5.50	2.86	2.75

310-225-6774 OR www.usblanks.com

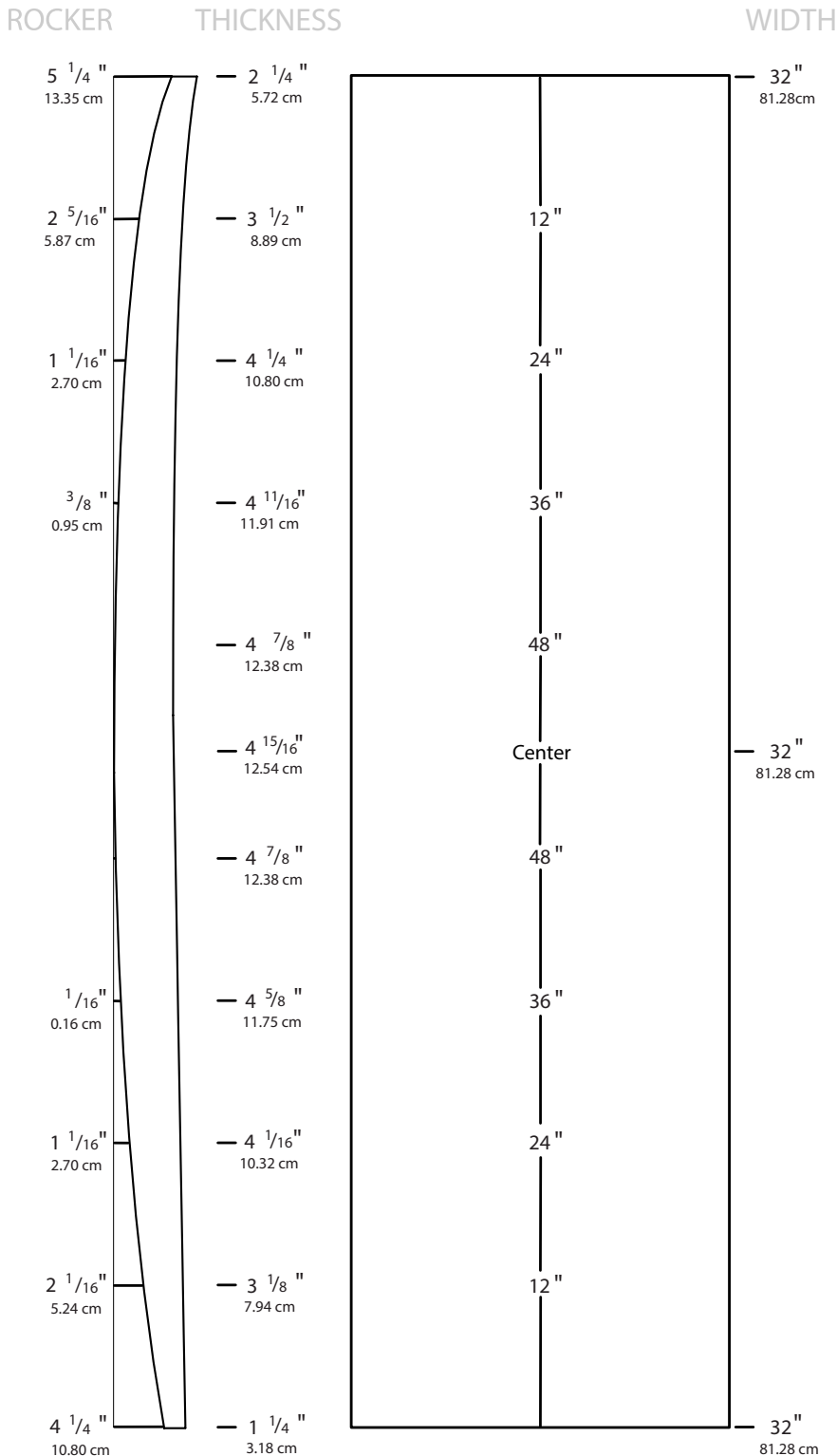

Overall Bottom Length: 9' 6 5/8" (291.15 cm)

Tip-to-tip Deck Length: 9' 6" (289.56 cm)

Maximum Width: 32" (81.28 cm)

Maximum Thickness: 4 15/16" (12.54 cm)

Available Density: 1.5 PCF or 2.0 PCF

Introduced: January 2011

Available Rockers:

Notes: Forthcoming

(310) 225-6774 - USBlanks.com



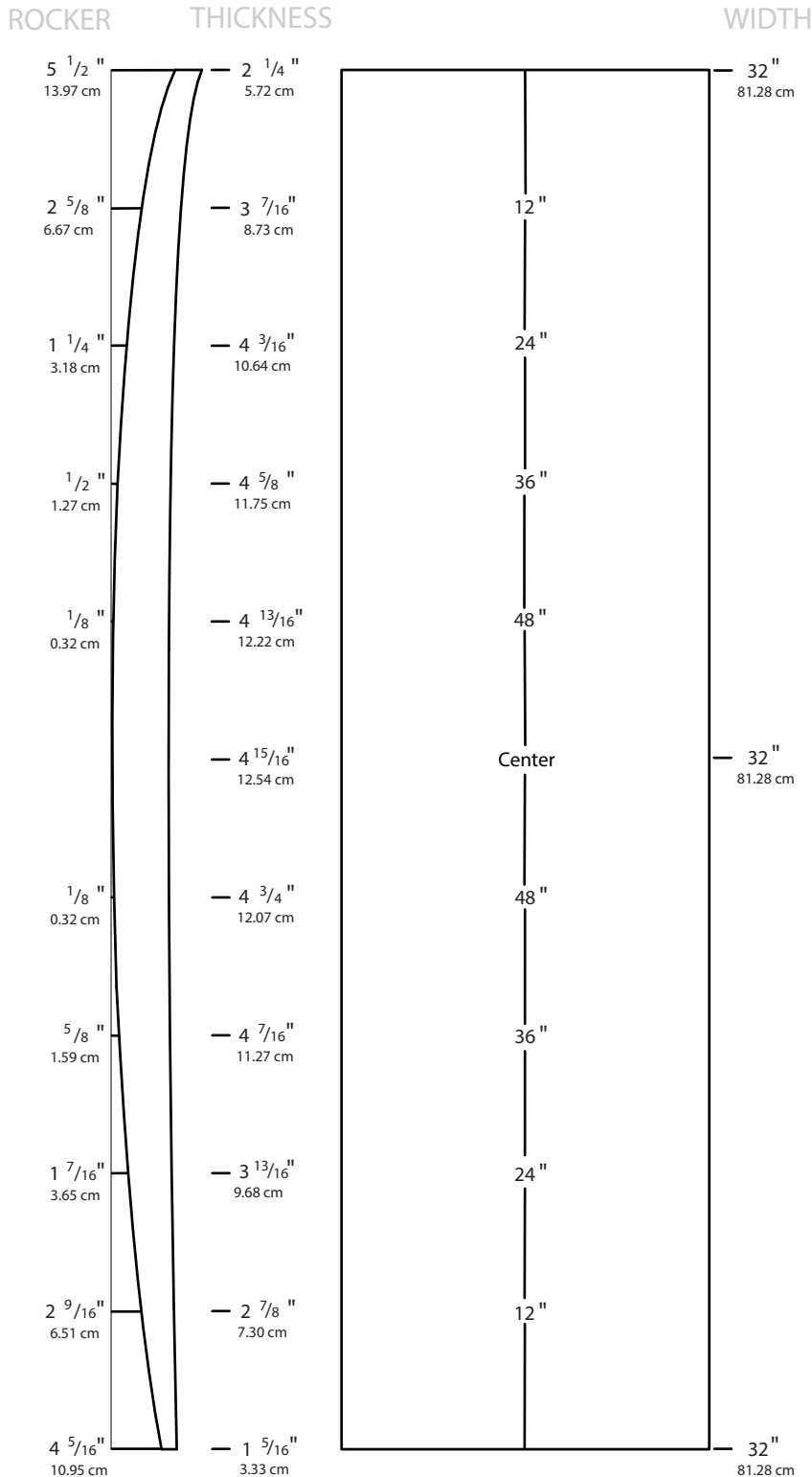

Overall Bottom Length: 10' 0 3/4" (306.71 cm)

Tip-to-tip Deck Length: 10' 0" (304.8 cm)

Maximum Width: 32" (81.28 cm)

Maximum Thickness: 4 15/16" (12.54 cm)

Available Density: 1.5 PCF or 2.0 PCF

Introduced: January 2011

Available Rockers:

Notes: Forthcoming

(310) 225-6774 - USBlanks.com



USBlanks™

MADE IN AMERICA

10'4" EPS A-SUP

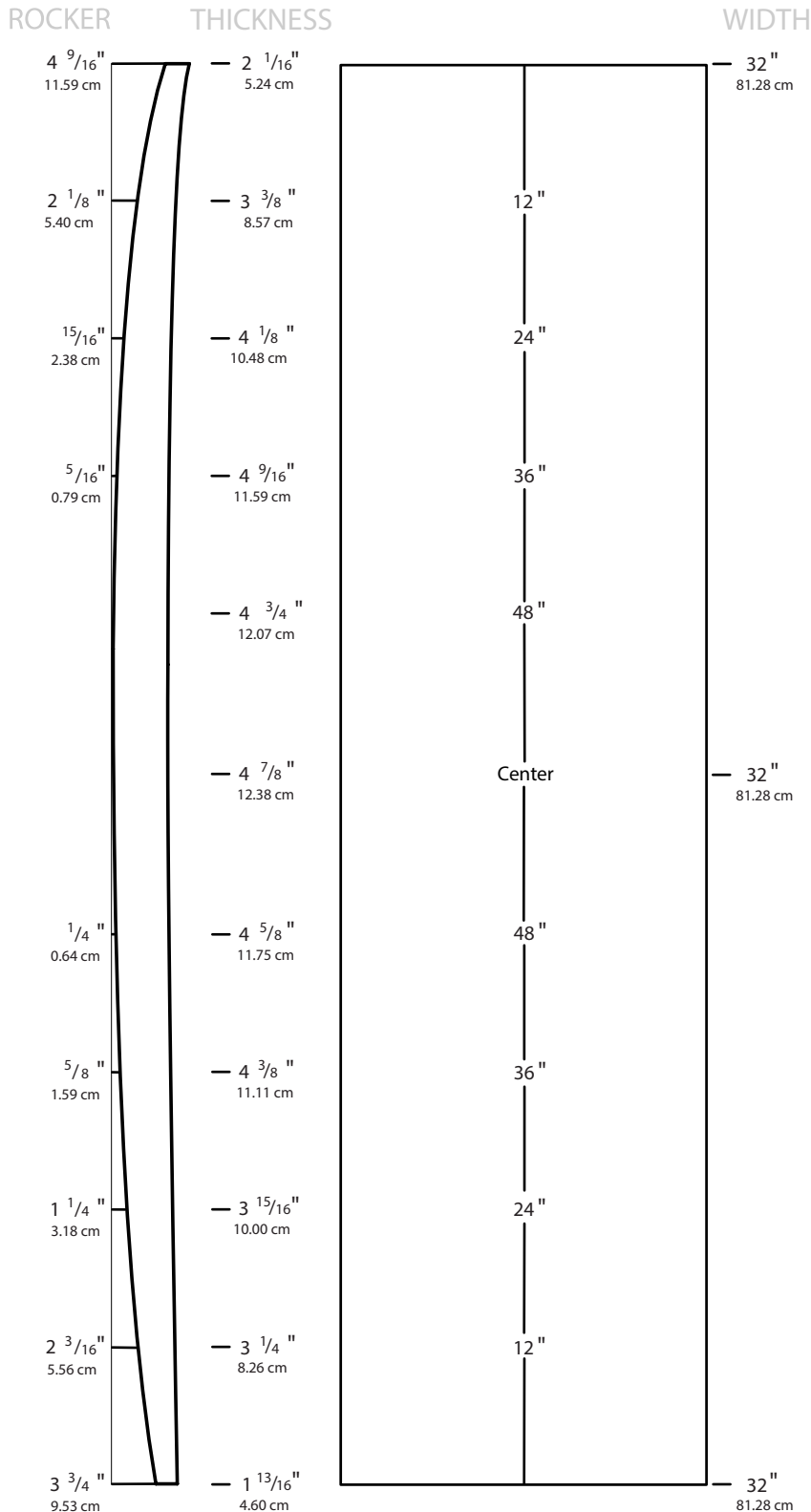

Overall Bottom Length: 10' 5 1/4" (318.14 cm)

Tip-to-tip Deck Length: 10' 4" (314.96 cm)

Maximum Width: 32" (81.28 cm)

Maximum Thickness: 4 7/8" (12.38 cm)

Available Density: 1.5 PCF or 2.0 PCF

Introduced: August 2009

Available Rockers:

Notes: Forthcoming

(310) 225-6774 - USBlanks.com



USBlanks™

MADE IN AMERICA

10'4" EPS

B-SUP

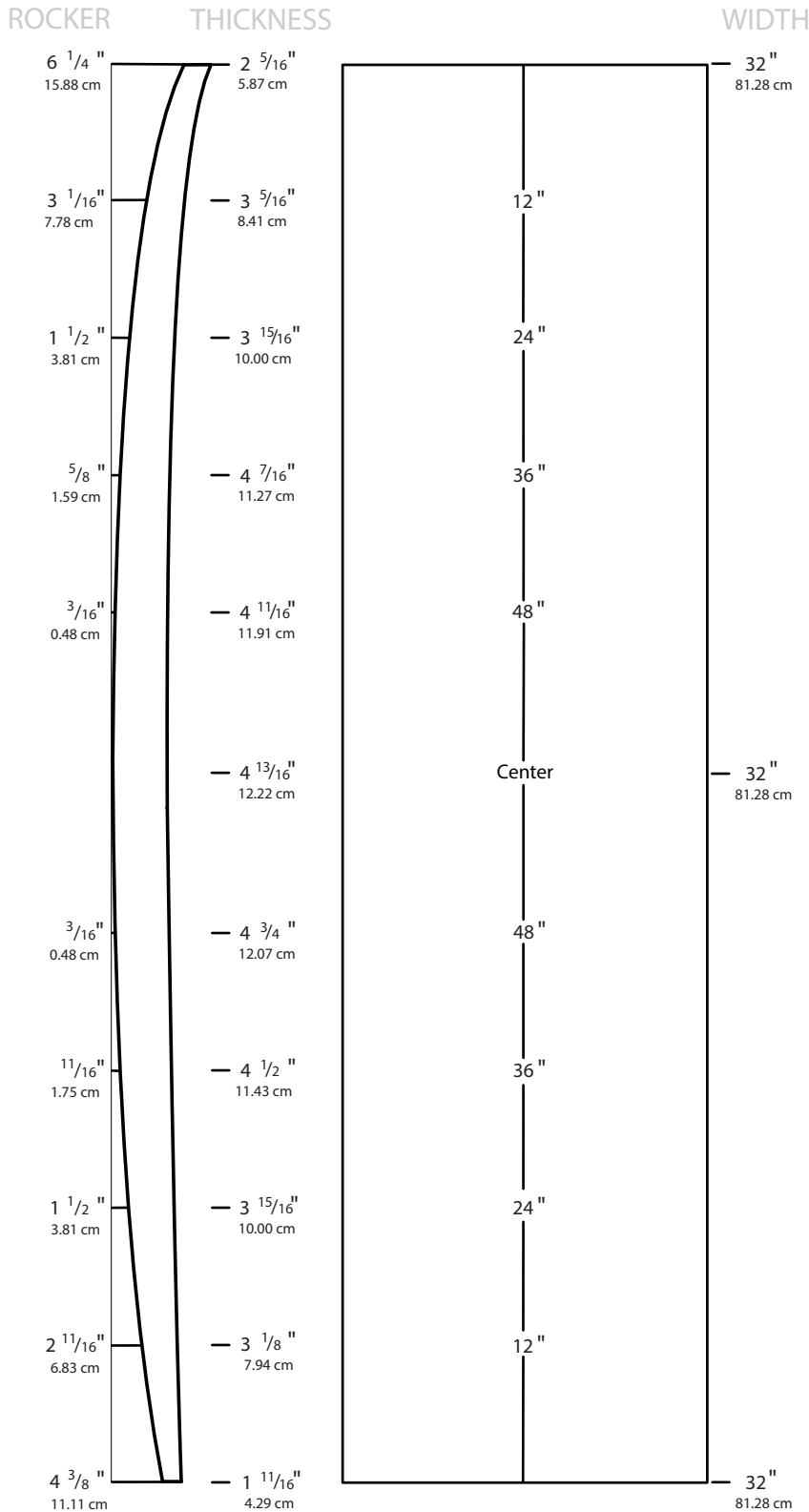

Overall Bottom Length: 10' 5 1/4" (318.14 cm)

Tip-to-tip Deck Length: 10' 4" (314.96 cm)

Maximum Width: 32" (81.28 cm)

Maximum Thickness: 4 13/16" (12.22 cm)

Available Density: 1.5 PCF or 2.0 PCF

Introduced: August 2009

Available Rockers:

Notes: Forthcoming

(310) 225-6774 - USBlanks.com



USBlanks™

MADE IN AMERICA

11'2" EPS

A-SUP

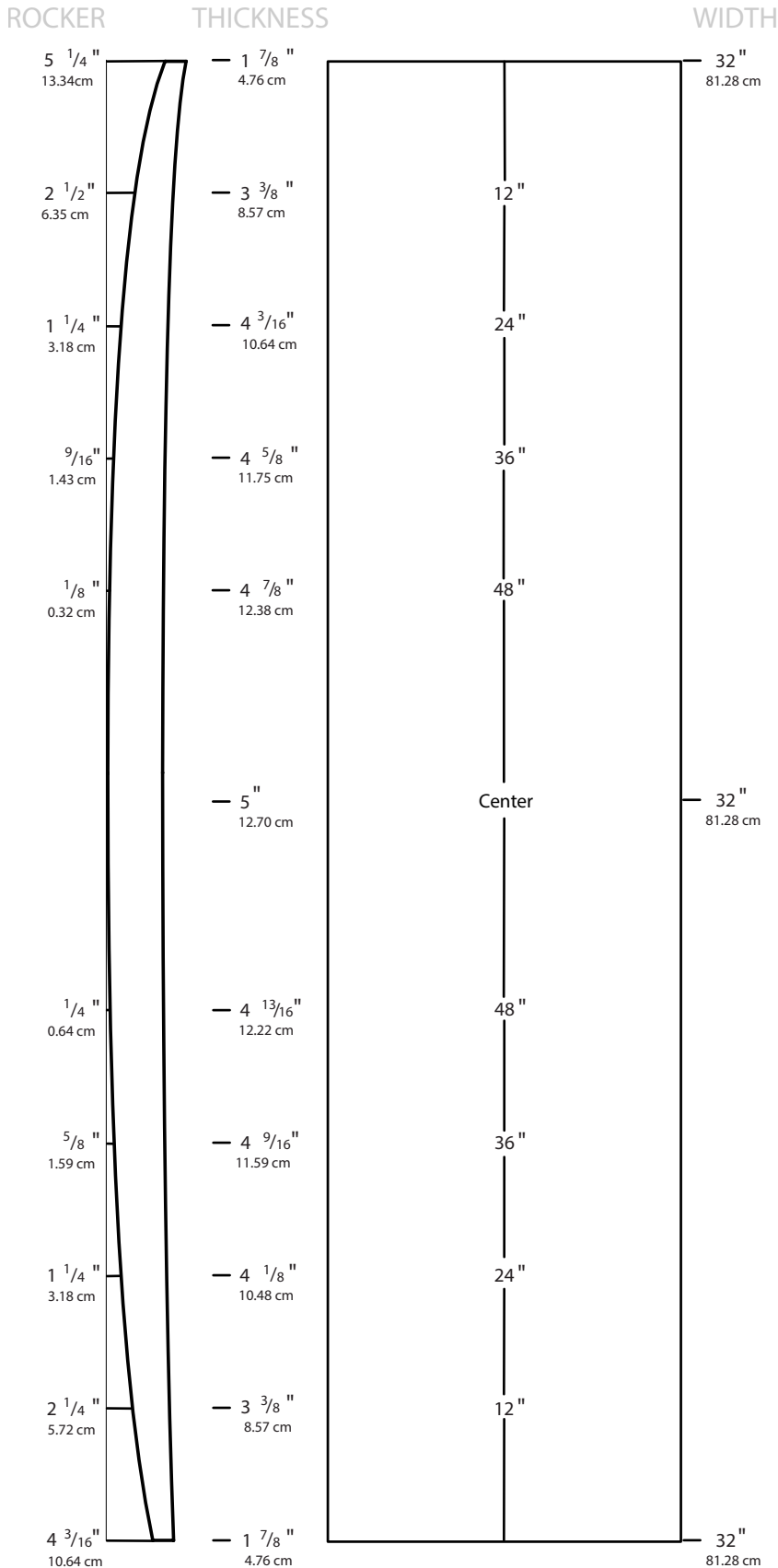

Overall Bottom Length: 11' 3 1/2" (344.17 cm)

Tip-to-tip Deck Length: 11' 2" (340.36 cm)

Maximum Width: 32" (81.28 cm)

Maximum Thickness: 5" (12.7 cm)

Available Densities: 1.5 PCF or 2.0 PCF

Introduced: August 2009

Available Rockers:

Notes: Forthcoming

(310) 225-6774 - USBlanks.com



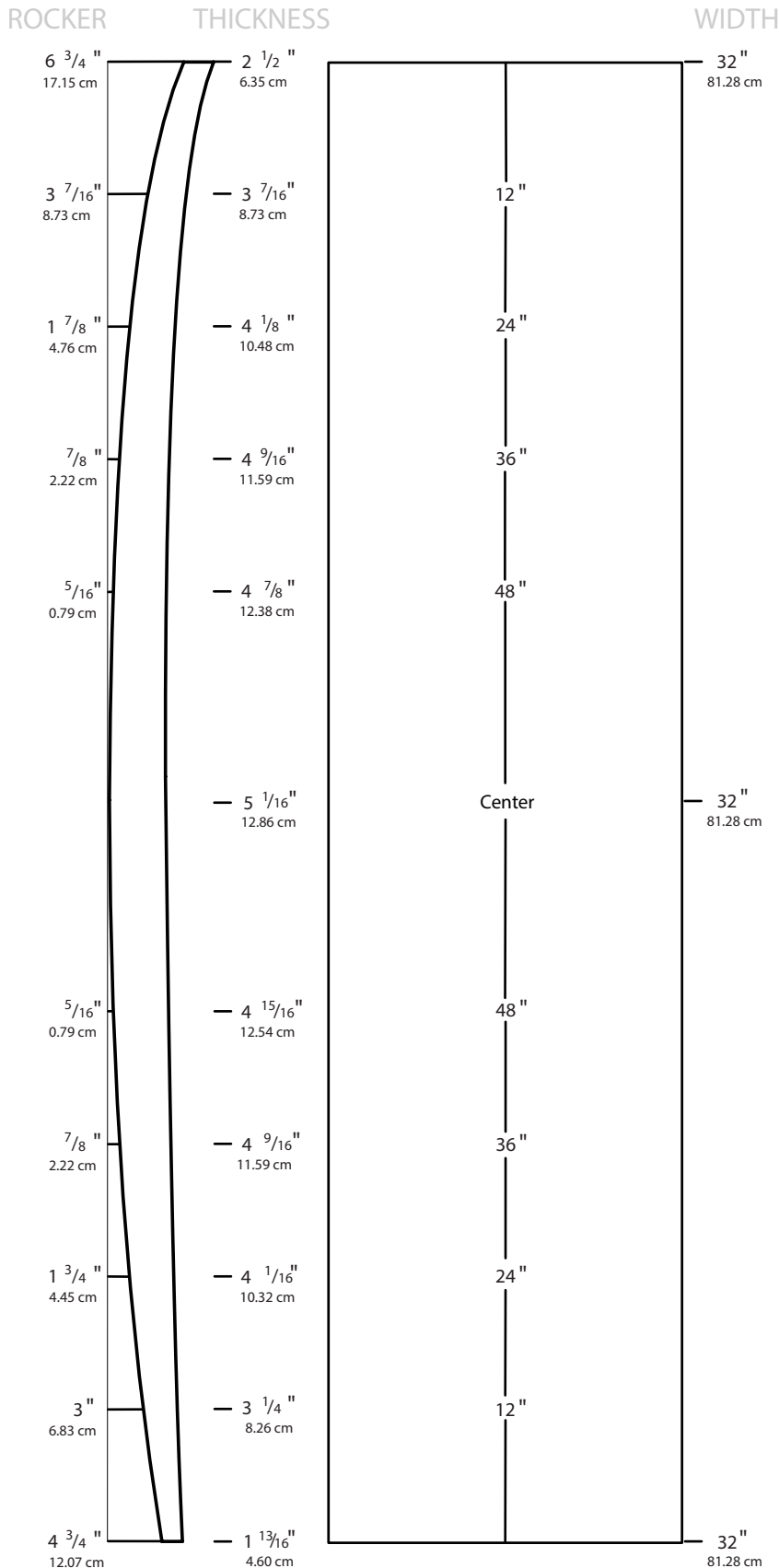

Overall Bottom Length: 11' 3 1/2" (344.17 cm)

Tip-to-tip Deck Length: 11' 2" (340.36 cm)

Maximum Width: 32" (81.28 cm)

Maximum Thickness: 5 1/16" (12.86 cm)

Available Densities: 1.5 PCF or 2.0 PCF

Introduced: August 2009

Available Rockers:

Notes: Forthcoming

(310) 225-6774 - USBlanks.com



USBlanks™ 12'1" EPS SUP

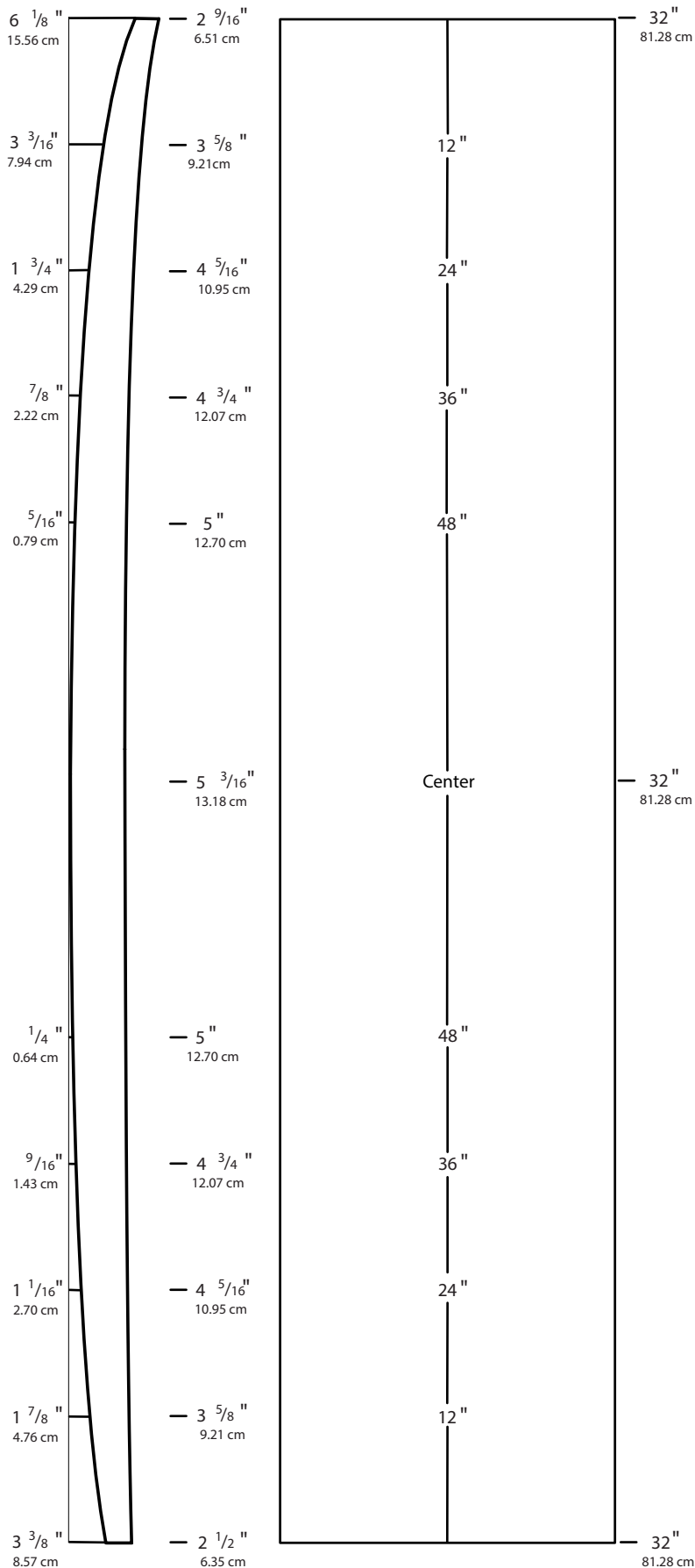

Overall Bottom Length: 12' 2 1/8" (371.16 cm)

Tip-to-tip Deck Length: 12' 1" (368.3 cm)

Maximum Width: 32" (81.28 cm)

Maximum Thickness: 5 3/16" (13.18 cm)

Available Densities: 1.5 PCF or 2.0 PCF

Introduced: August 2009

Available Rockers:

Notes: Forthcoming

(310) 225-6774 - USBlanks.com



USBlanks™ 12'6" EPS SUP

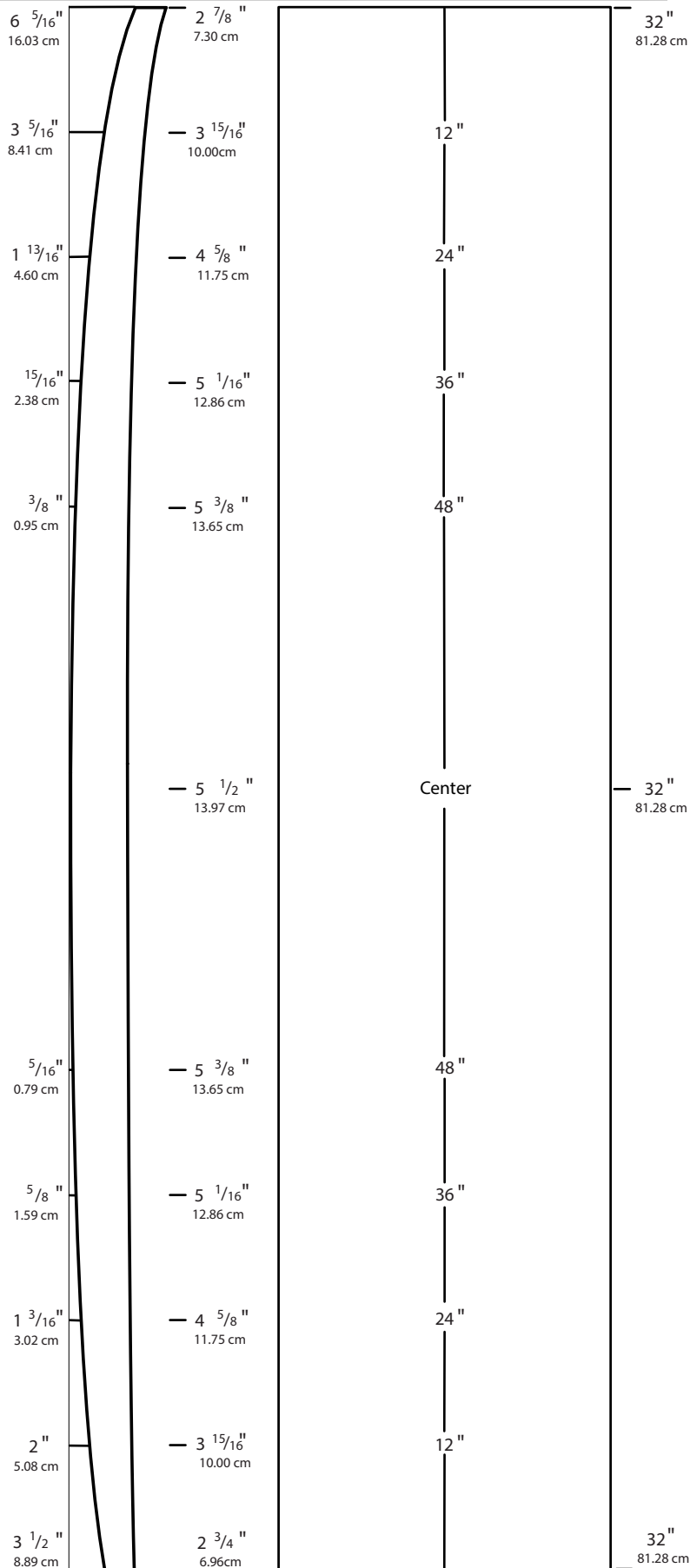

Overall Bottom Length: 12' 7 1/2" (384.81 cm)

Tip-to-tip Deck Length: 12' 6" (381.0 cm)

Maximum Width: 32" (81.28 cm)

Maximum Thickness: 5 1/2" (13.97 cm)

Available Density: 1.5 PCF or 2.0 PCF

Introduced: January 2011

Available Rockers:

Notes: Forthcoming

(310) 225-6774 - USBlanks.com



PARABOLIC STRINGERS

The parabolic template outlines depicted on the following pages are drawn to scale and are representative of the curvature positioning related to the given blank sizes. All templates are named based on their overall length from end to end. When ordering please specify the specific template to be used based on the finished board length. Any short board template can be used in any blank as long as the template is smaller than the blank itself (this does not apply to fish templates).

For example, you can request to use the 6'0" parabolic template in the 6'6" EA blank. As a general rule the maximum length template that can be used in a blank will be one size smaller than the blank itself (eg. 6'0" template in the 6'2" P or the 6'4" template in the 6'6" EA, etc.) We will only use the same length template in a blank when specifically requested by a customer. All templates can also be used in our SUPERFUSED EPS blanks.

Our "stock" parabolic templates can be adjusted in or out in the tail to accommodate a narrower or wider outline. Be aware that all dimensions from nose to tail will be affected when making this adjustment. Upon request customers may also submit "custom" templates to be kept as private outlines. Custom template set up will be subject to a one-time surcharge.

The most common stringer thicknesses in parabolic blanks are 3/32", 1/8" and 4mm ply (5/32"). The allowed maximum stringer thickness used for the 5'11" Fish and 6'4" Fish outlines is 3/32".

We suggest using the natural rocker in all parabolic blanks whenever possible. Parabolic stringers do not react to (or hold) rocker adjustments in the same manner as when adjusted from a center stringer. For this reason will not guarantee precise tolerances when making custom rocker adjustments in parabolic blanks.

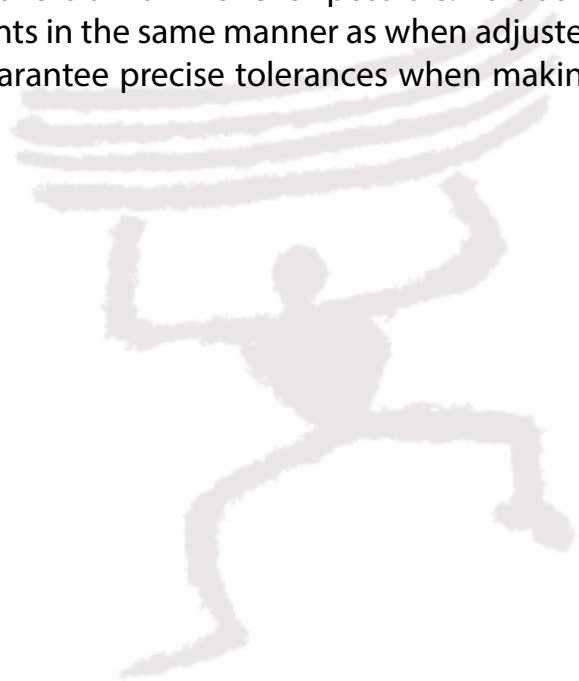

5'9" P PARABOLIC

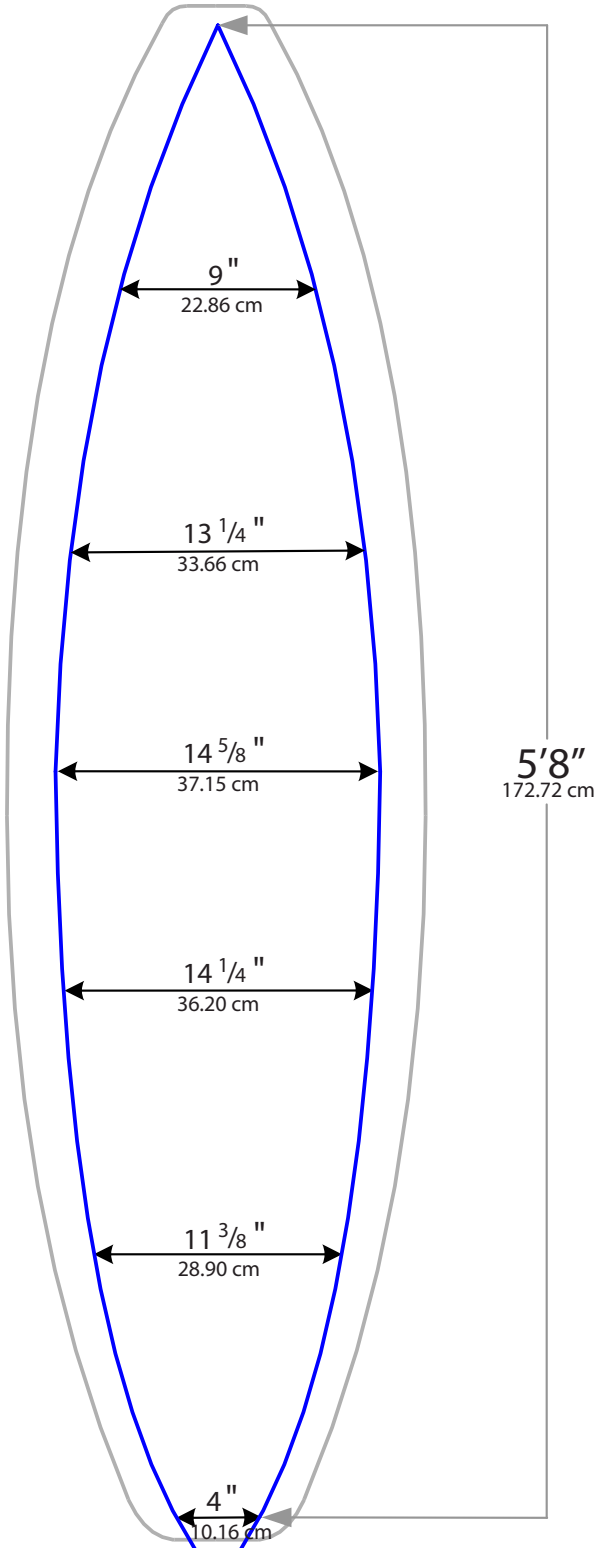

Overall Template Length: 5' 8" (172.72 cm)

Blank Width: 19 1/16" (48.42 cm)
(1/2" narrower than standard 5'9P)

Notes: This template is suitable for high performance shortboard shapes 5'8 and under.

* * All parabolic dimensions are "inside widths" measured across from cut to cut. Extra width must be added to the dimensions listed to account for thickness of stringers. Overall blank width is narrower due to the thickness of material removed during the cutting process.

Available Rockers:

5'9P Parabolic Natural Rocker - 5'8 template

(310) 225-6774 - USBlanks.com



6'0" P PARABOLIC

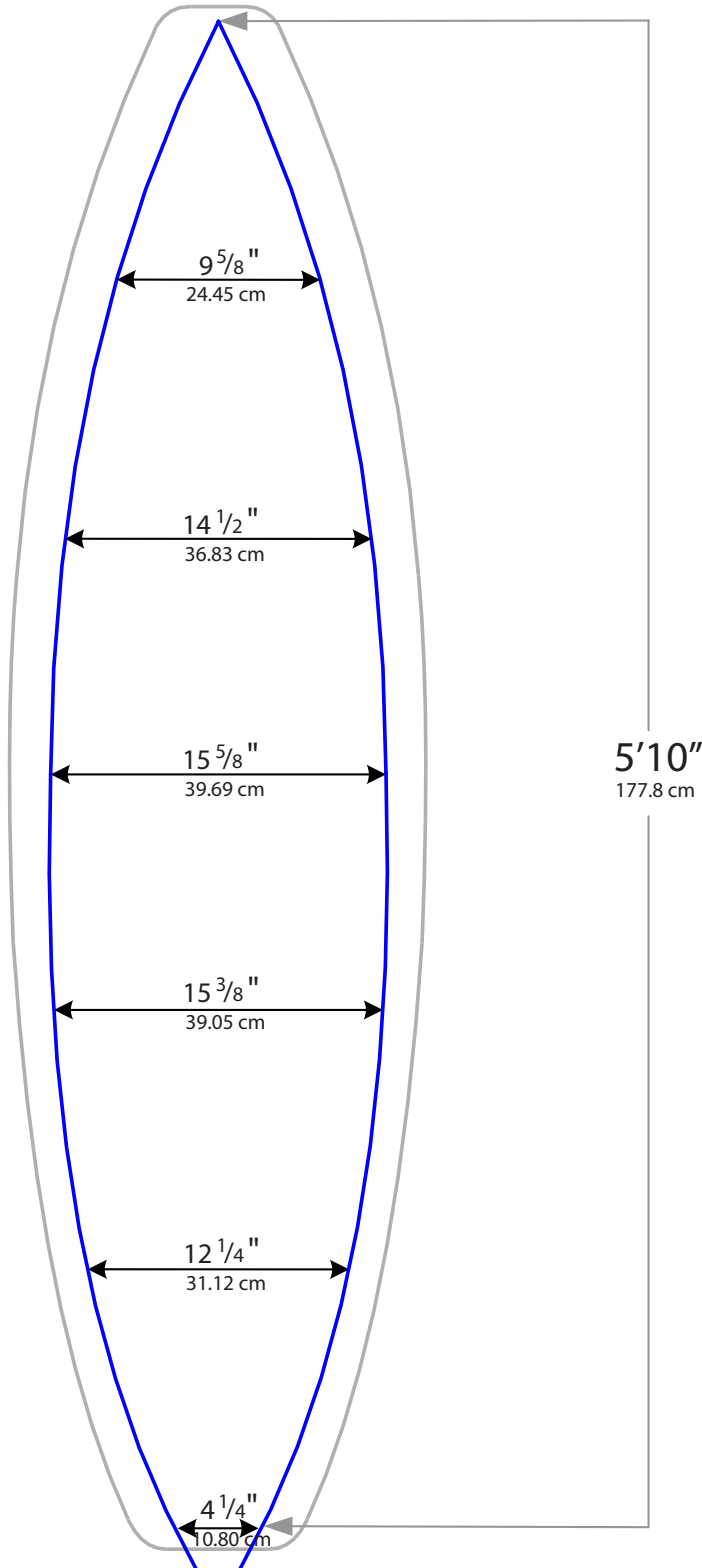

Overall Template Length: 5' 10" (177.80 cm)

Blank Width: 19 9/16" (49.69 cm)

(1/2" narrower than standard 6'0P)

Notes: This template is suitable for high performance short board shapes 5'10" and under.

* * All parabolic dimensions are "inside widths" measured across from cut to cut. Extra width must be added to the dimensions listed to account for thickness of stringers. Overall blank width is narrower due to the thickness of material removed during the cutting process.

Available Rockers:

6'0P Parabolic Natural Rocker - 5'10 template

(310) 225-6774 - USBlanks.com



6'2" A PARABOLIC

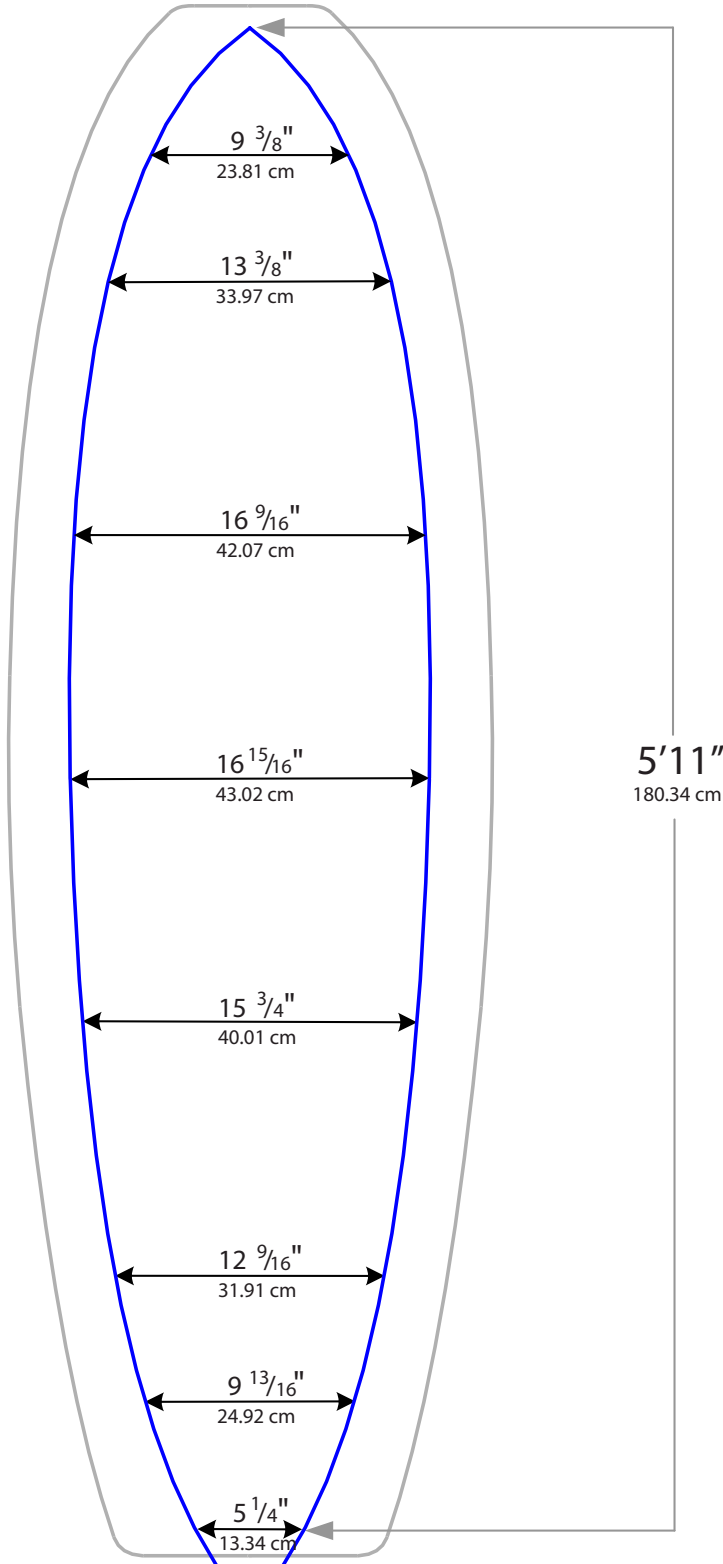

Overall Template Length: 5' 11" (180.34 cm)

Blank Width: 23 1/8" (58.74 cm)
(1/2" narrower than standard 6'2A)

Notes: This template is suitable for high performance FISH board shapes 5'11" and under.

Maximum stringer thickness allowed = 3/32"

* * All parabolic dimensions are "inside widths" measured across from cut to cut. Extra width must be added to the dimensions listed to account for thickness of stringers. Overall blank width is narrower due to the thickness of material removed during the cutting process.

Available Rockers:

6'2A Parabolic Natural Rocker - 5'11 FISH template

(310) 225-6774 - USBlanks.com



6'2" P PARABOLIC

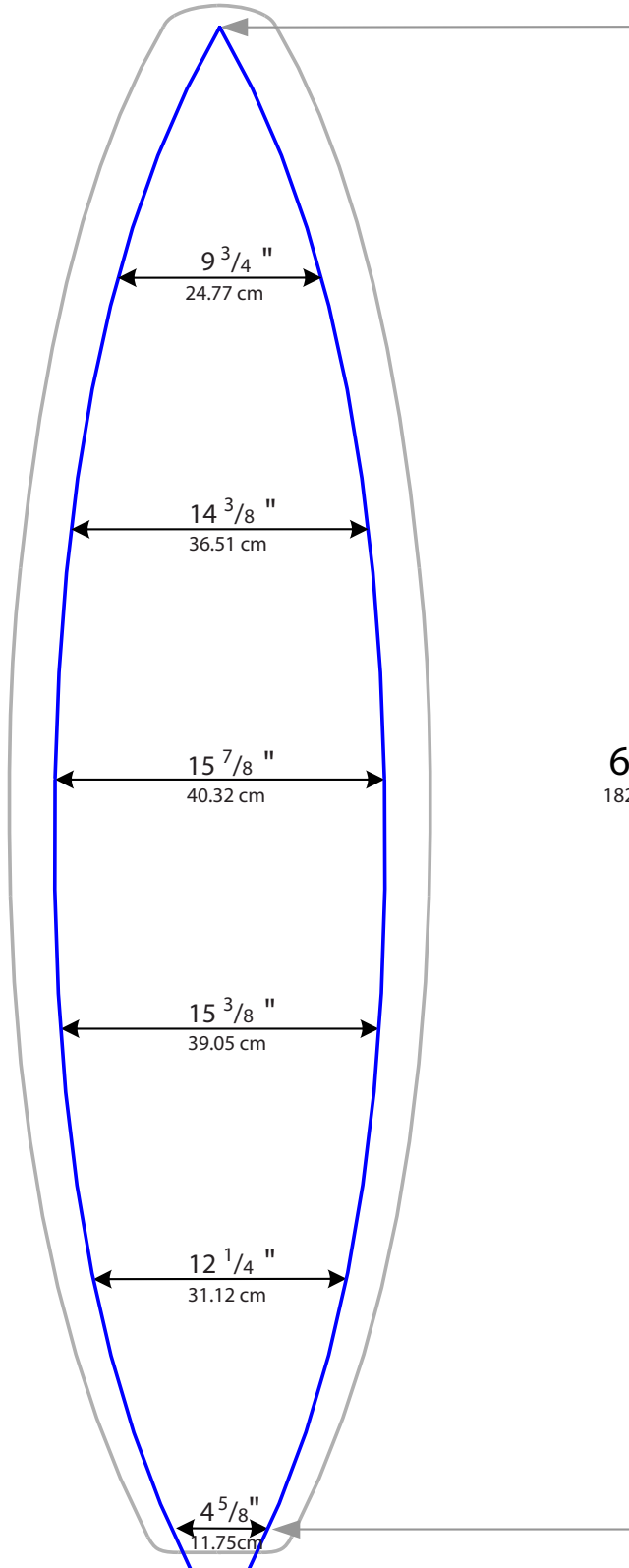

Overall Template Length: 6' 0" (182.88 cm)

Blank Width: 20 1/8" (51.12 cm)

(1/2" narrower than standard 6'2P)

Notes: This template is suitable for high performance short board shapes 6'0" and under.

* * All parabolic dimensions are "inside widths" measured across from cut to cut. Extra width must be added to the dimensions listed to account for thickness of stringers. Overall blank width is narrower due to the thickness of material removed during the cutting process.

Available Rockers:

6'2P Parabolic Natural Rocker - 6'0 template

6'2P Parabolic +1/2"N18" Rocker - 6'0 template

6'2P Parabolic Natural Rocker - 5'10 template

(310) 225-6774 - USBlanks.com



6'3" EA PARABOLIC

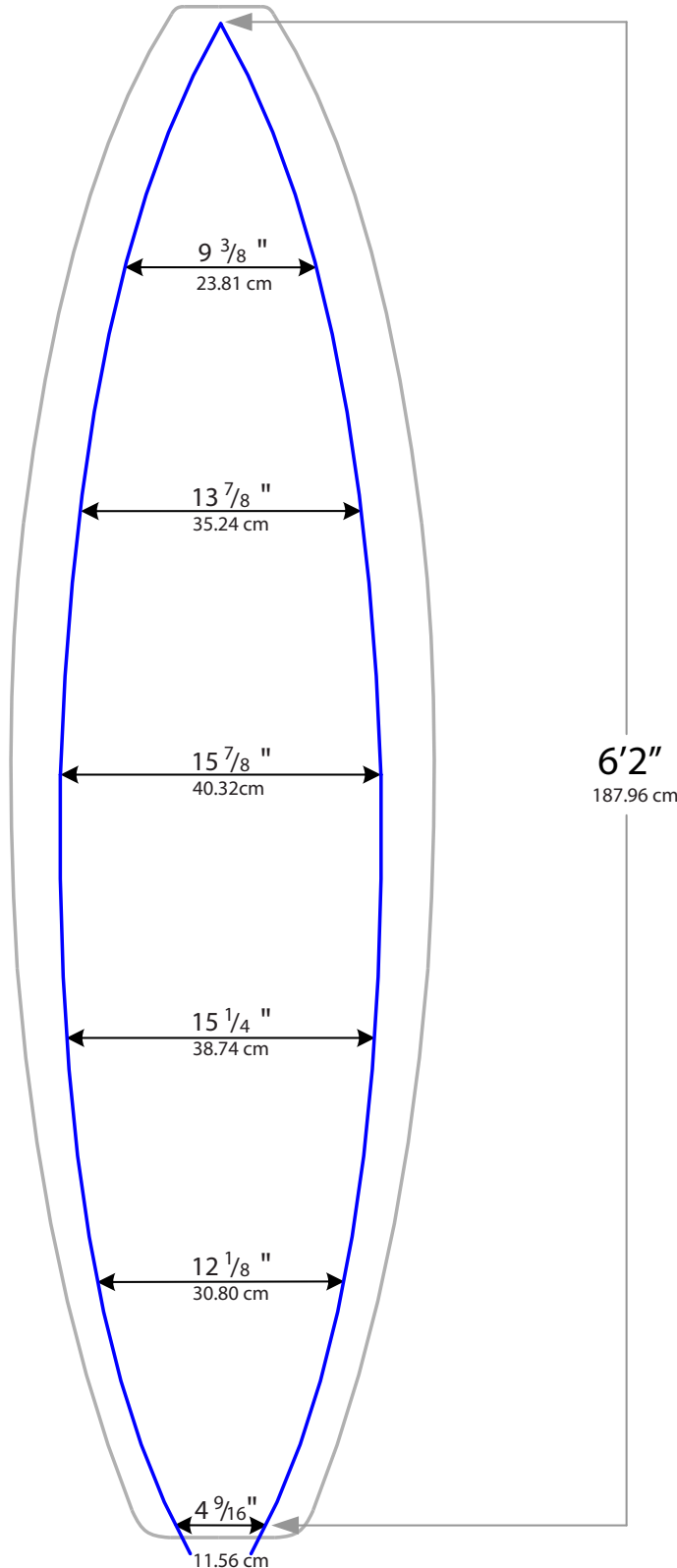

Overall Template Length: 6' 2" (187.96 cm)

Blank Width: 20 ⁵/₁₆" (51.59 cm)

(1/2" narrower than standard 6'3 EA)

Notes: This template is suitable for high performance short board shapes 6'2" and under.

* * All parabolic dimensions are "inside widths" measured across from cut to cut. Extra width must be added to the dimensions listed to account for thickness of stringers. Overall blank width is narrower due to the thickness of material removed during the cutting process.

Available Rockers:

- 6'3EA Parabolic Natural Rocker - 6'2 template
- 6'3EA Parabolic Natural Rocker - 6'0 template
- 6'3EA Parabolic Natural Rocker - 5'10 template

(310) 225-6774 - USBlanks.com



6'5" A PARABOLIC

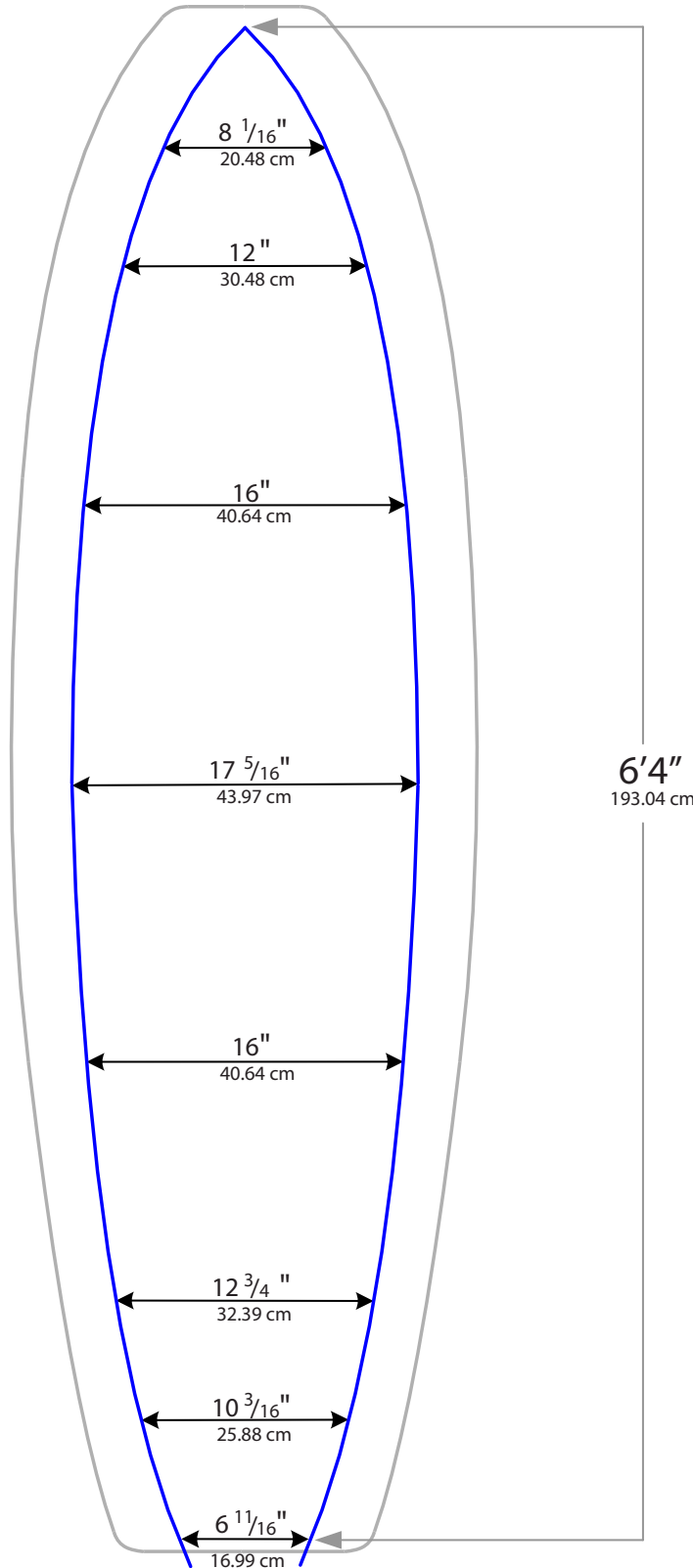

Overall Template Length: 6' 4" (193.04 cm)

Blank Width: 23 1/8" (58.74 cm)
(1/2" narrower than standard 6'5A)

Notes: This template is suitable for high performance FISH board shapes 6'4" and under.

Maximum stringer thickness allowed = 3/32"

* * All parabolic dimensions are "inside widths" measured across from cut to cut. Extra width must be added to the dimensions listed to account for thickness of stringers. Overall blank width is narrower due to the thickness of material removed during the cutting process.

Available Rockers:

6'5A Parabolic Natural Rocker - 6'4 Fish template

(310) 225-6774 - USBlanks.com



6'6"EA PARABOLIC

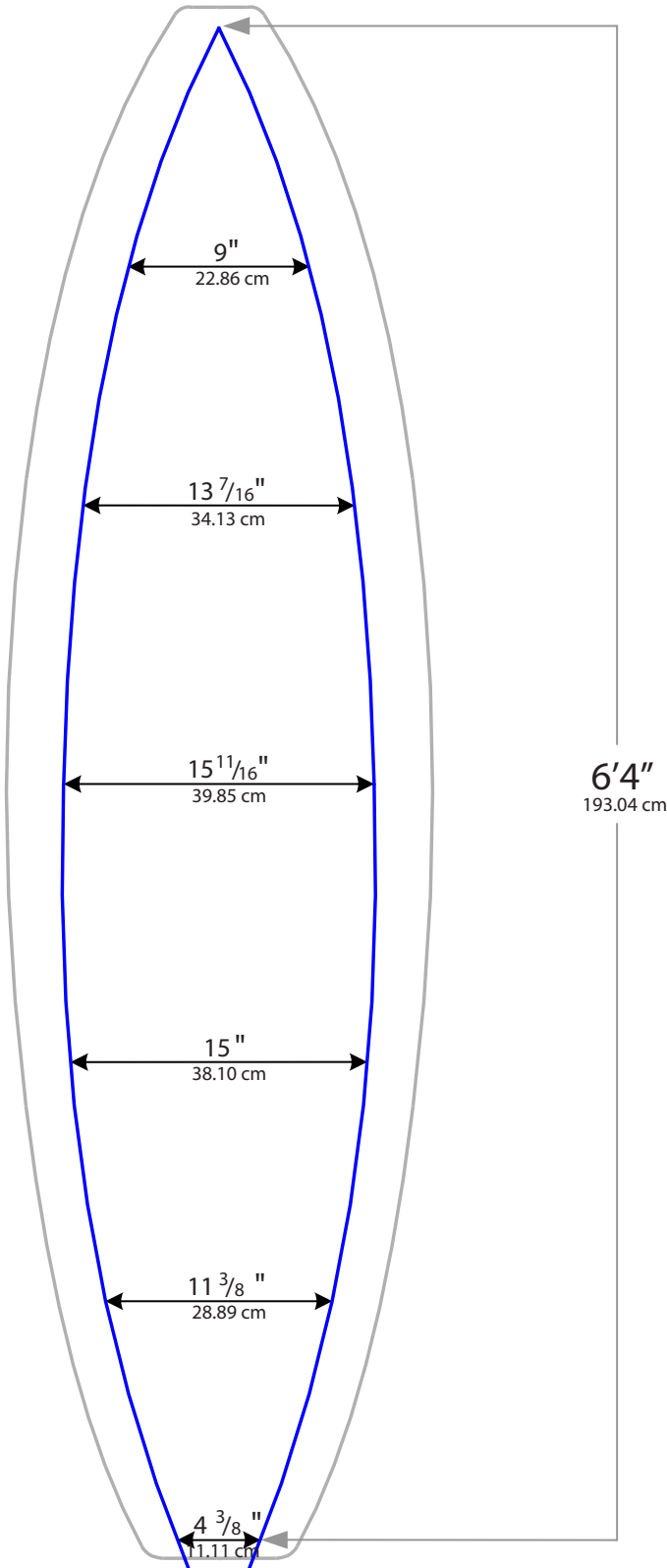

Overall Template Length: 6' 4" (193.04 cm)

Blank Width: 20 ¹⁵/₁₆" (53.18 cm)

(1/2" narrower than standard 6'6EA)

Notes: This template is suitable for high performance short board shapes 6'4" and under.

* * All parabolic dimensions are "inside widths" measured across from cut to cut. Extra width must be added to the dimensions listed to account for thickness of stringers. Overall blank width is narrower due to the thickness of material removed during the cutting process.

Available Rockers:

- 6'6EA Parabolic Natural Rocker - 6'4 template
- 6'6EA Parabolic Natural Rocker - 6'2 template
- 6'6EA Parabolic Natural Rocker - 6'0 template
- 6'6EA Parabolic Natural Rocker - 5'10 template

(310) 225-6774 - USBlanks.com



6'7" P PARABOLIC

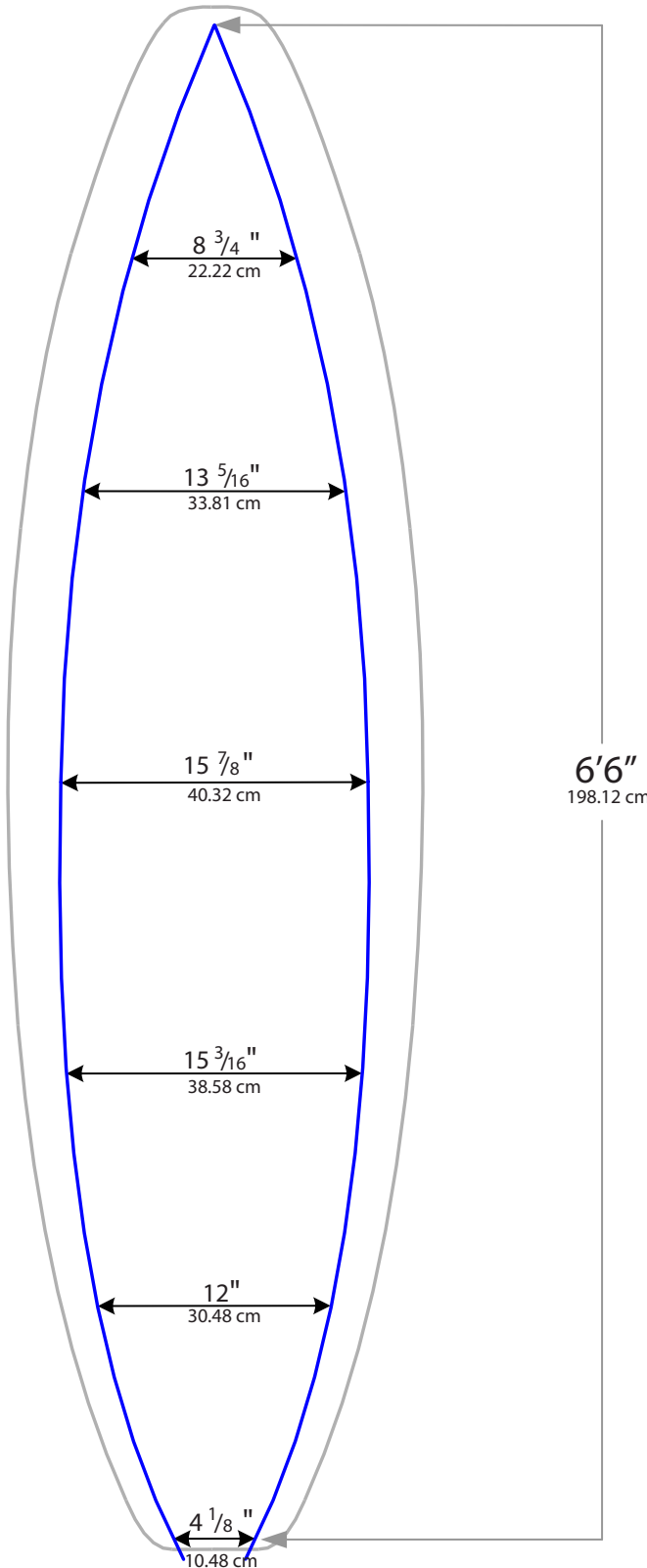

Overall Template Length: 6' 6" (198.12 cm)

Blank Width: 21" (53.34 cm)

(1/2" narrower than standard 6'7" P)

Notes: This template is suitable for high performance short board shapes 6'6" and under.

* * All parabolic dimensions are "inside widths" measured across from cut to cut. Extra width must be added to the dimensions listed to account for thickness of stringers. Overall blank width is narrower due to the thickness of material removed during the cutting process.

Available Rockers:

6'7" Parabolic Natural Rocker - 6'6" template

6'7" Parabolic +1/4" T20" Rocker - 6'4" template

(310) 225-6774 - USBlanks.com



6'9"EA
PARABOLIC

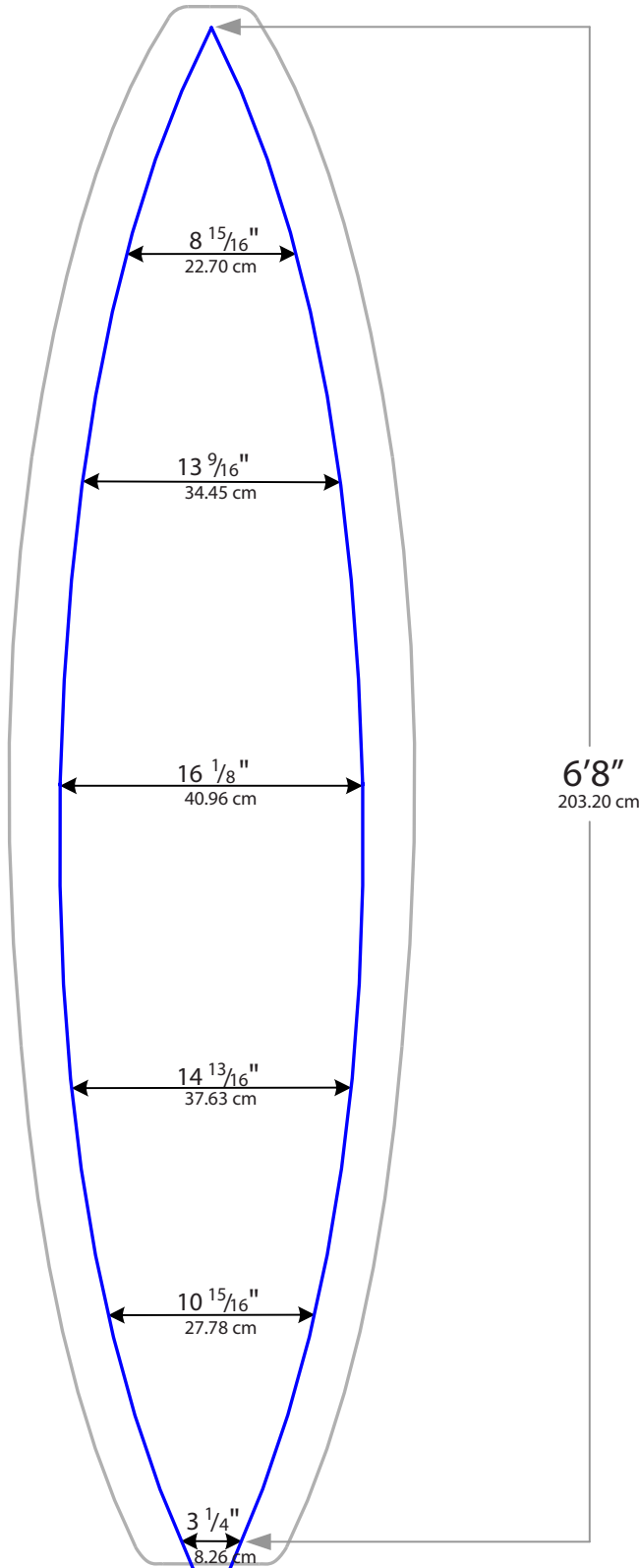

Overall Template Length: 6' 8" (203.20 cm)

Blank Width: 20 ¹³/₁₆" (49.69 cm)

(1/2" narrower than standard 6'9EA)

Notes: This template is suitable for high performance short board shapes 6'8" and under.

* * All parabolic dimensions are "inside widths" measured across from cut to cut. Extra width must be added to the dimensions listed to account for thickness of stringers. Overall blank width is narrower due to the thickness of material removed during the cutting process.

Available Rockers:

6'9EA Parabolic Natural Rocker - 6'8 template

6'9EA Parabolic Natural Rocker - 6'6 template

(310) 225-6774 - USBlanks.com



7'1" EA PARABOLIC

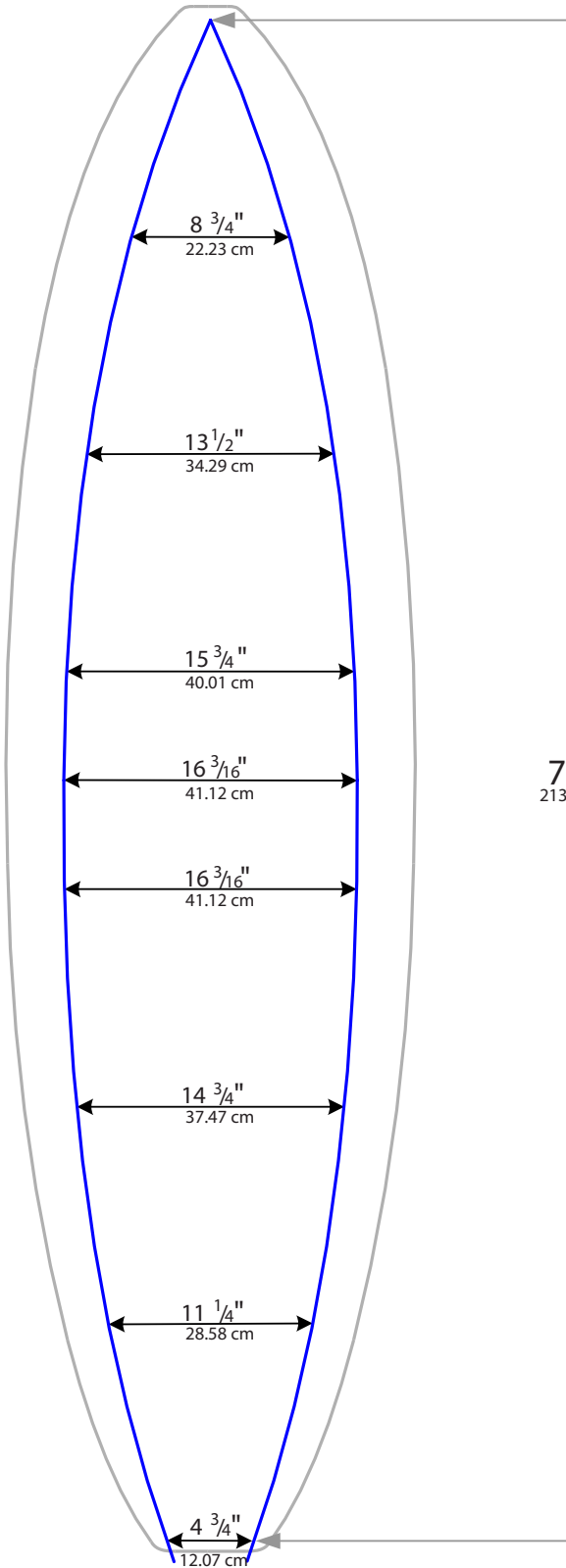

Overall Template Length: 7'0" (213.36 cm)

Blank Width: 22 3/16" (57.63 cm)

(1/2" narrower than standard 7'1EA)

Notes: This template is suitable for high performance short board shapes 7'0" and under.

* * All parabolic dimensions are "inside widths" measured across from cut to cut. Extra width must be added to the dimensions listed to account for thickness of stringers. Overall blank width is narrower due to the thickness of material removed during the cutting process.

Available Rockers:

7'1EA Parabolic Natural Rocker - 7'0 template

(310) 225-6774 - USBlanks.com



9'4" B

PARABOLIC

Outline "A"

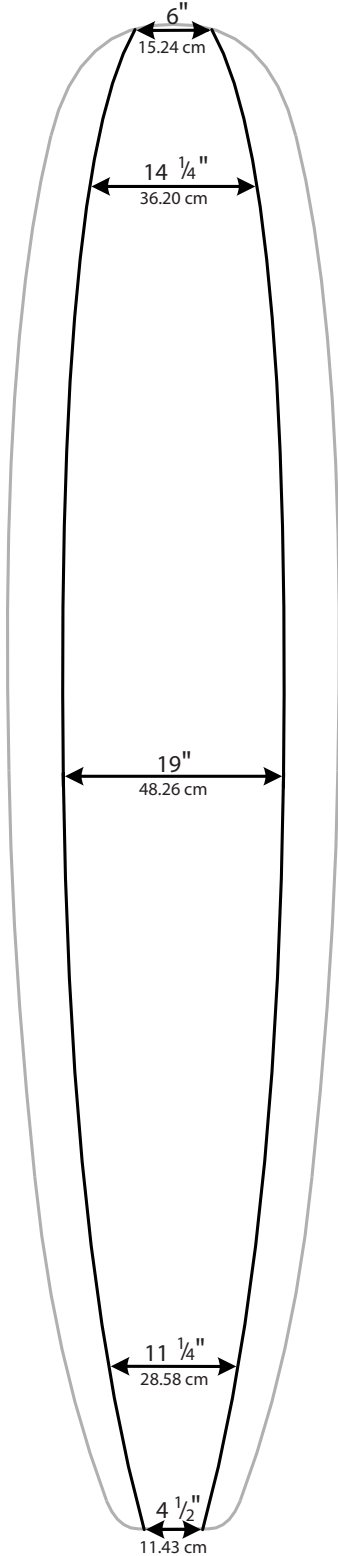

Outline "B"

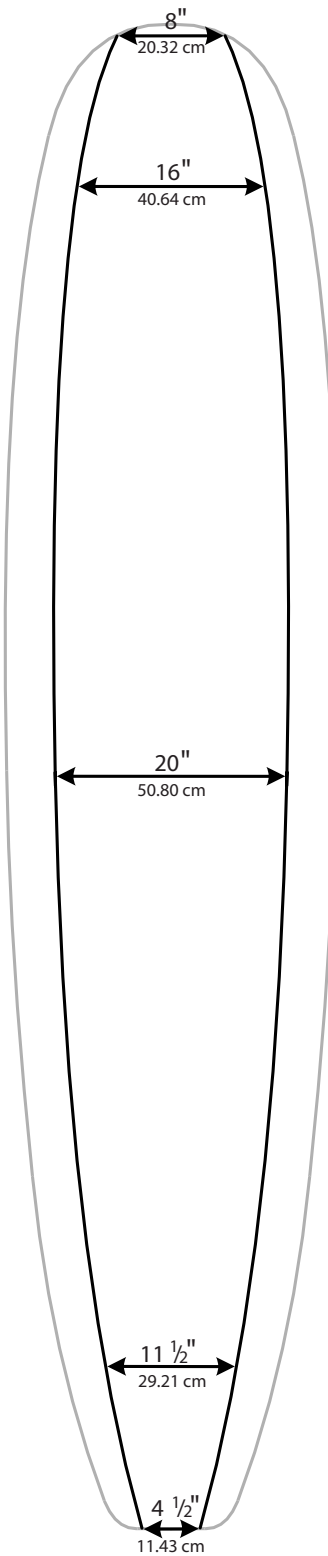

Overall Template Length: 9' 4" (284.48 cm)

Blank Width: 24 11/16" (62.71 cm)

(1/2" narrower than standard 9'4B)

Notes: This template is suitable for long board shapes 9'4" and under.

This outline can be used on the following blanks:

93Y, 94B, 95M, 98Y and 98EPS

* * All parabolic dimensions are "inside widths" measured across from cut to cut. Extra width must be added to the dimensions listed to account for thickness of stringers. Overall blank width is narrower due to the thickness of material removed during the cutting process.

Available Rockers:

94B Natural Rocker

(310) 225-6774 - USBlanks.com



MULTI BOARD BOXES WITH BOX ENDS

BOX SIZE:	INSIDE DIMENSIONS		
	LENGTH	WIDTH	HEIGHT
1. 7'4"	7'2" (2.24 m)	25" (63.5 cm)	12" (30.5 cm)
2. 8'4"	8'2" (2.49 m)	25" (63.5 cm)	12" (30.5 cm)
3. 10'8"	10'6" (3.32 m)	26" (76.2 cm)	14" (35.5 cm)
4. 12'5"	12'3" (3.73 m)	33" (83.8 cm)	12.5" (31.6 cm)

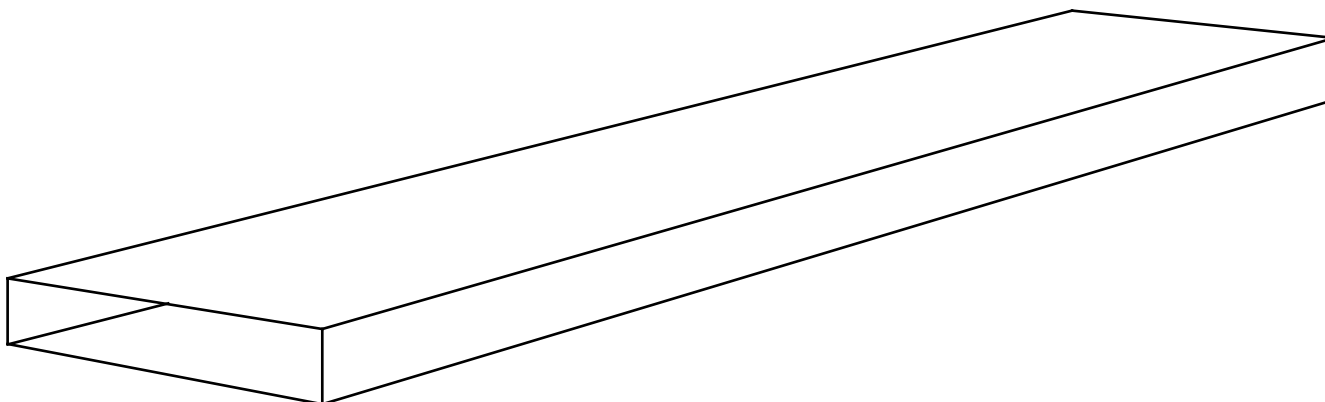

BOXES ARE A GLUED TUBE MADE OF 275# KRAFT

ENDS STAPLE IN FOR A STRUCTUAL FIT.

BOXES ARE PLAIN WITH NO LOGO.