

# HR-1103 Low Power RF Module

## User Manual

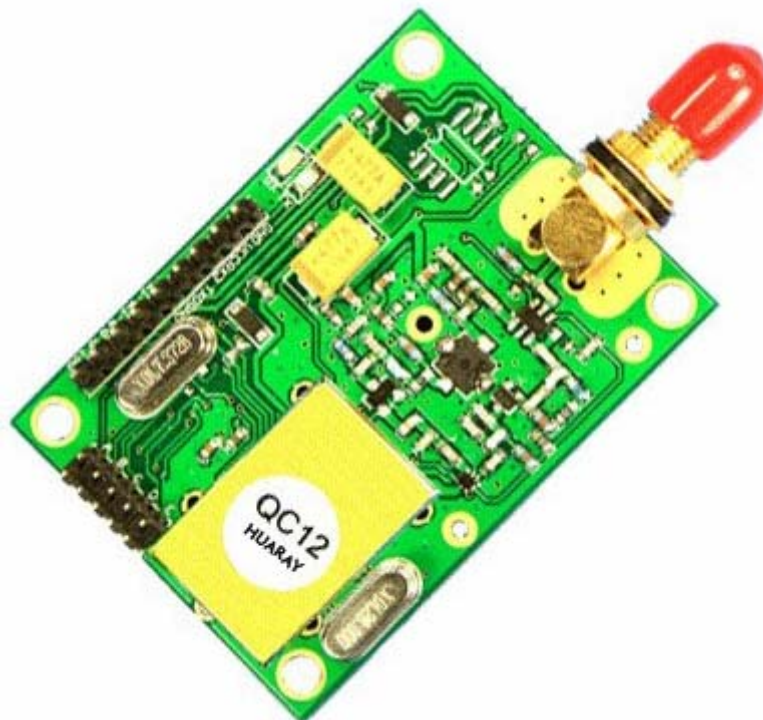

### ORIENTAL HUARAY GROUP LIMITED

---

Tel: 86 755 81782516

Cell phone: 86 15813856667

Fax: 86 755 81782518

Address: Huaxia Industrial park, Jingbei, Shiyan, BaoAn district, Shenzhen, China      Postal code: 518108

Website: [www.ohglrf.com](http://www.ohglrf.com)

E-mail: [sales@ohglrf.com](mailto:sales@ohglrf.com) or [jet.zhang8@gmail.com](mailto:jet.zhang8@gmail.com)

### I 、 HR-1103 Interface definition:

HR-1103 has a 9-pin connector (con1), its definitions as well as connection method for terminals as the following show:

Pin No	Pin name	Description	level	Connect To the terminal	Memo
1	GND	ground		ground	
2	VCC	Power supply DC	+ 4.5 ~ 5.0V		
3	RXD/TTL	Serial data receiving interface	TTL	TXD	
4	TXD/TTL	Serial data transmitting interface	TTL	RXD	

5	SGND	Grounding of the signal			It can connected with the ground (pin 1)
6	A(TX)	A of RS-485 Or B of RS-232		A(RX)	
7	B(RX)	B of RS-485 Or A of RS-232		B(TX)	
8	SLEEP	Sleep control(input)	TTL	Sleep signal	Low efficiency t>15ms
9	RESET	Reset control(input)	TTL	Reset signal	Negative pulse reset 1ms

## II、Configure about the channel, interface baud rate and data format:

Before using HR-1103, you need to make simple configuration of the system parameter such as interface and data format.

There is one group of 5-bit short-circuit wire(J1) on the bottom right



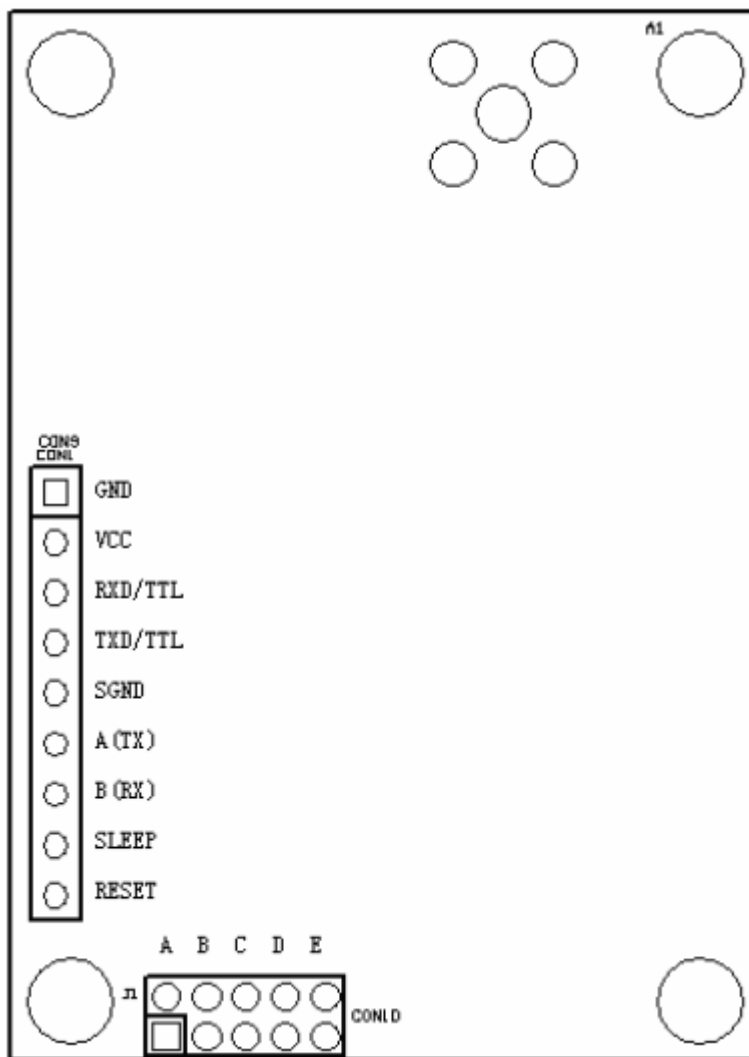



The configuration is as following show:



**A. Channel configuration:**

ABC jumper wires of J1 provide 8 kinds of options and you can choose to use 0-7 channels.

Jumper ABC	Channel numbers	Center frequency 433 MHz	Center frequency 470 MHz	Center frequency 868 MHz	Center frequency 915 MHz
	0 (ABC all without short circuit wire)	432.9 MHz	469.2 MHz	867.9MHz	914.9MHz
	1 (A with short circuit wire, the B and C without wire)	433.1 MHz	469.4 MHz	868.1MHz	915.1MHz

	2	433.3 MHz	469.6 MHz	868.3MHz	915.3MHz
	3	433.5 MHz	469.8 MHz	868.5MHz	915.5MHz
	4	433.7 MHz	470 MHz	868.7MHz	915.7MHz
	5	433.9 MHz	470.2 MHz	868.9MHz	915.9MHz
	6	434.1 MHz	470.4 MHz	869.1MHz	916.1MHz
	7	434.3 MHz	470.6 MHz	869.3MHz	916.3MHz

### B. Selection of interface mode

HR-1103 provides 2 serial ports, COM1(Pin3 and Pin4 of COM1) is fixed as UART serial port of TTL level, COM2 (Pin6 and Pin7 of COM1) is fixed as RS232/RS485 interface, which connection interface the user choice needs, when ordering indicates by all means must.

### 2. TTL interface connection sketch map

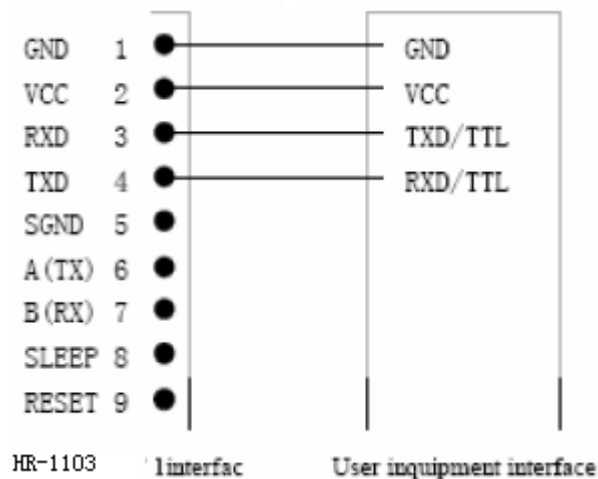

**Attention:** The other pin (pin 4, 5, 6, 7, 8, 9) should not connect with the wire, if not it will make signal interface

**Note:** Please do not connect any wire on Pin7 and Pin8 if com2 is no use  
The connection wire as next picture

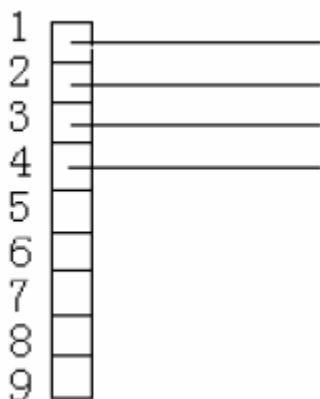

### 3. RS-232/RS485 interface connection sketch map

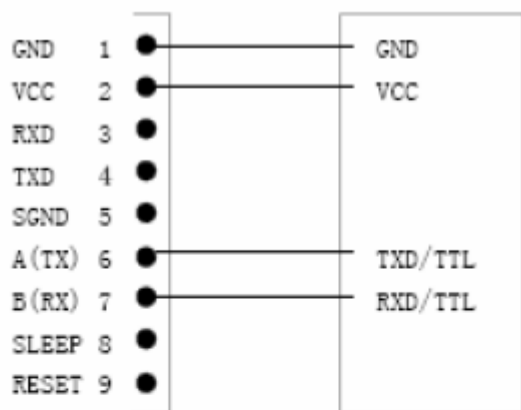

HR-1103 interface User inquipment interface



**Note: Please do not connect any wire on Pin3 and Pin4, if COM1 is no use, if the two use different Power supply please make sure the two use the same GND (join the two`s GND together)**

#### C. Interface baud rate

The baud rate is determined by the hardware

Memo: ● means short circuit ○ means open

(If you need choose the rate as you do not want us to confirm it for you, you can

join the PIN by yourself as following show)

Baud rate (BPS)	JP1	JP2	JP3
600	○	○	○
1200	●	○	○
2400	○	●	○
4800	●	●	○
9600	○	○	●
19200	●	○	●
38400	○	●	●
57600	●	●	●

**D. The Pin D and Pin E is used for choosing the verify method: it means choose 8E1/8O1:**

D=0 (without short circuit), E=0 (without short circuit) 8N1 no parity

D=1 (with short circuit), E=0 (with short circuit) 8O1 odd parity

D=0 (without short circuit), E=1 (with short circuit) 8E1 even parity

Note: Channel setting, COM2's interface made and parity mode is fixed after the power is on, if you want to change the setting, you must reset the modules or Power on again.

### III、 Technical specification of HR-1103:

Serial number	item	Parameter	Memo
1	Modulation mode	GFSK/FSK	
2	Work frequency	433MHz/470MHz/868MHz/915MHz	
3	Transmission power	≥32dBm(1.5W)	
4	Receiving sensitivity	-118 ~ -119dBm	
5	Channel amount	8channel	
6	Transmitting current	≤850mA	
7	Receiving current	≤45mA	
8	Sleeping current	≤20uA	
9	Baud rate	600/1200/2400/4800/9600/19200/38400/57600bps	First ordered

10	Interface mode	UART TTL/RS-232/RS-485	First ordered
11	Power supply	+4~5VDC	
12	Working temperature	-25℃~80℃	
13	Working humidity	10%~90%(relative humidity without condensation)	
14	Dimension	52.8mm×37.9mm×10mm	
15	Transmit distance	2500m (in the open air and use Flagelliform antenna)	

#### IV、Dimension:

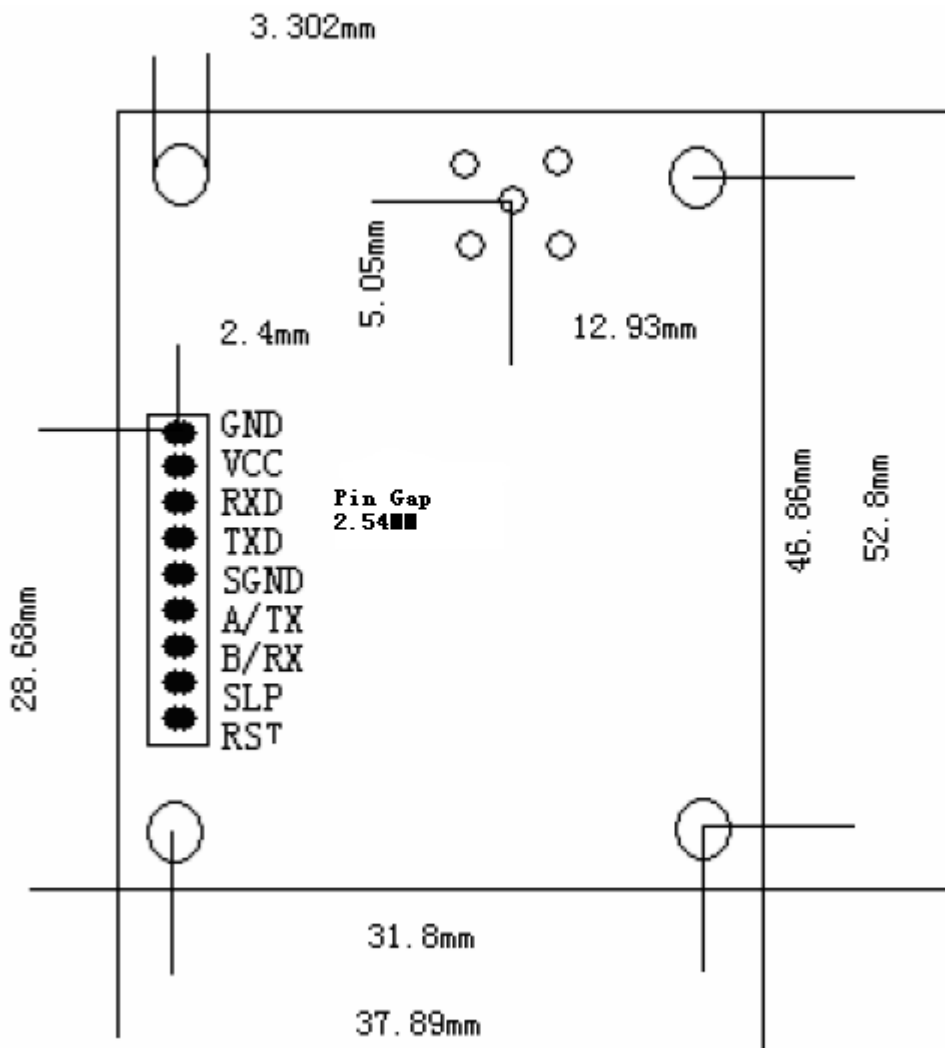

## **V、 Technology support and after service:**

We offer sufficient technology support for user use the module and further development for free: mending broken module one year for free, always offer sold service.

To adapt different user structure, we can develop smaller module or various modules