

# CS6000B SERIES

Operation Manual

Duplex Models



**BALBOA™ Series by HYDROQUIP™**

# Introduction

This manual covers electrical and installation details on the following product series. Some photos and instructions may not apply to the product you have purchased.

**-U Series** "Fixed" Heater configuration: This series is designed to fit the most common heater position. Depending upon the actual control being replaced, you may still need to modify the plumbing to achieve proper alignment.

**-US Series** "Slide" Heater configuration: This series is designed to allow the heater to be positioned within 20" of the control to provide an installation with a minimum of plumbing modifications. Depending upon the actual control being replaced, you may still need to modify the plumbing to achieve proper alignment.

**-VH Series** "Versi-Heat" Heater configuration: This series is designed to allow the heater to be positioned within 60" of the control to provide an installation where there may not be enough room in the immediate equipment area and to minimize plumbing modifications. Depending upon the actual control being replaced, you may still need to modify the plumbing to achieve proper alignment.

**-LH Series** "Less Heater" configuration: This series allows the use of customer supplied custom heater configurations which may not have been available from Hydro-Quip. Please refer to the "LH" wiring diagram enclosed with the "LH" wiring harness for specific wiring connections and details NOT covered within this manual.

# Contents

Important Safety Instructions.....	3-4
Electrical Installation.....	5-7
GFCI Wiring Detail.....	8
Heater Installation.....	9
Versi-Heat / Optional Heaters.....	10
Universal Sensor Fitting Kit.....	10
Power Connection.....	11
Sensor Connections.....	12
Cord Connections.....	13
Circuit Board Configurations.....	14-19
System Start-Up.....	19-20
Heater Start-Up Sequence.....	20
Filtration Programming.....	21
Modes /Behaviors.....	21
Spa Side Control Operation.....	22
Optional Equipment.....	23
Operational Considerations.....	24
Spa Side Messages.....	25-26
TroubleShooting.....	26-27
Testing Sensors.....	28
System Plug Pinouts.....	28
System Data Label.....	29
Warranty Information.....	29

# IMPORTANT SAFETY INSTRUCTIONS

- ! **DANGER** To reduce the risk of injury, do not permit children to use this product unless they are closely supervised at all times.
- ! **WARNING - RISK OF CHILD DROWNING.** Extreme caution must be exercised to prevent unauthorized access by children. To avoid accidents, ensure that children cannot use a spa or hot tub unless they are supervised at all times.
- ! **DANGER** To reduce the risk of injury to persons, do not remove suction fittings.
- ▶ Spa location must accommodate sufficient drainage of water around the base of the structure, as well as the power source compartment.
- ▶ Prolonged immersion in water that is warmer than normal body temperature can result in a dangerous condition known as HYPERTHERMIA. The causes, symptoms, and effects of hyperthermia may be described as follows: Hyperthermia occurs when the internal temperature of the body reaches a level several degrees above the normal body temperature of 98.6°F. The symptoms of hyperthermia include dizziness, fainting, drowsiness, lethargy, and an increase in the internal temperature of the body. The effects of hyperthermia include (1) unawareness of impending hazard, (2) failure to perceive heat, (3) failure to recognize the need to exit spa, (4) physical inability to exit spa, (5) fetal damage in pregnant women, (6) unconsciousness resulting in danger of drowning. **WARNING** The use of alcohol, drugs or medication can greatly increase the risk of fatal hyperthermia in hot tubs and spas.
- ! **DANGER - RISK OF ELECTRICAL SHOCK.**  
A spa may be installed within 5 feet of metal surfaces if each metal surface is permanently connected by a solid copper conductor attached to the wire connector on the terminal box . Refer to NEC and local codes in effect at the time of installation.)
- ▶ A bonding lug is provided on the control box to permit connection of a solid copper bonding conductor between this point and any equipment, metal enclosures of electrical equipment, metal water pipe, or conduit within 5 feet (1.5m) of the unit as needed to comply with local requirements.
- ▶ Bond accessible metal to the dedicated connector on the equipment grounding bus, bond the equipment ground bus to the local common bonding grid as part of the installation in the form of (1) a reinforced concrete slab for support, (2) a ground plate provided beneath the hot tub or spa, or (3) a permanent ground connection that is acceptable to the local inspection authority.
- ! **DANGER RISK OF ELECTRICAL SHOCK.** Do not permit any electrical appliance, such as a light, telephone, radio, or television, within 5 feet (1.5m) of a spa or hot tub.

## To reduce the risk of injury:

- ▶ The water in a spa or hot tub should never exceed 104°F (40°C). Water temperatures between 100°F (38°C) and 104°F (40°C) are considered safe for a healthy adult. Lower water temperatures are recommended for extended use (exceeding 10-15 minutes) and for young children.
- ▶ Excessive water temperatures have a high potential for causing fetal damage during the early months of pregnancy, pregnant or possibly pregnant women should limit spa or hot tub water temperatures to 100°F(38°C).

Before entering the spa or hot tub, the user should measure the water temperature with an accurate thermometer.

The use of alcohol, drugs, or medication before or during spa or hot tub use may lead to unconsciousness with the possibility of drowning.

Persons suffering from obesity or with a medical history of heart disease, low or high blood pressure, circulatory system problems, or diabetes should consult a physician before using a spa or hot tub.

Persons using medication should consult a physician before using a spa or hot tub since some medication may affect heart rate, blood pressure, and circulation.

#### **For Cord and Plug Connected Units**

Must be connected to a grounded, grounding type receptacle only. NEVER connect the spa to an extension cord.

Do not bury the cord.

**WARNING** -To reduce the risk of electrical shock, replace damaged cord immediately.

#### **For Permanently Installed Units**

A terminal marked "G" or "ground" is provided in the wiring box located inside the equipment compartment. To reduce the risk of electric shock, connect the terminal or connector to the grounding terminal of your electrical service or supply panel with a continuous green insulated copper wire in accordance with National Electric Code Table 250-95 and any other local codes in effect at the time of the installation.

#### **For Permanently Installed Units not Provided with an Internal Disconnecting Method**

The electrical supply for this product must include a suitably rated switch or circuit breaker to open all ungrounded supply conductors to comply with Section 422-30 of the National Electric Code, ANSI/NFPA 70 1987. The disconnecting means must be readily accessible to the tub occupant but installed at least 5 feet (1.5m) from the tub water.

#### **For Units with Gas Heaters**

**WARNING** - Do not install indoors. This unit uses a gas heater that requires proper ventilation and is intended for outdoor use only.

#### **High Voltage Warning**

**HIGH VOLTAGE CAN SERIOUSLY INJURE OR KILL!**

**ONLY EXPERIENCED TECHNICIANS SHOULD SERVICE THIS EQUIPMENT.**

**DO NOT** remove the protective covers from any electrical enclosure, or attempt to service any related electrical device, unless you are a qualified electrician or service professional.

#### **DANGER**

**Risk of electric shock. Before working with any electrical connections, make certain that the Main Power breaker from the house breaker box has been turned off.**

#### **WARNING**

**All electrical work must be performed by a qualified electrician and must conform to all local codes.**

#### **IMPORTANT**

**Due to the danger of severe electrical shock, locate all power disconnects before servicing a spa. Precautions must be taken whenever working with breaker boxes, G.F.C.I.'s, or service disconnects.**

# Electrical Installation

A licensed electrician must accomplish the electrical installation in accordance with the National Electric Code(NEC) Article 680, and any local codes in effect at the time of installation.

Refer to the System Data Label for equipment voltage and maximum amperage draws.

The GFCI (Ground Fault Circuit Interrupter) is a mandatory electrical safety device required for all portable spas and hot tubs as specified in the National Electrical Code Article 680-42. The GFCI in your particular installation may be installed at the electrical service panel or a separate sub-panel.

Use copper conductors ONLY. The ground must be sized following the National Electric Code, Table 250-122. For Power conductor size, refer to the National Electric Code Table 310-16.

A bonding lug has been provided on the control box to allow connection to local ground points. To reduce the risk of electrical shock, a solid copper bonding wire should be connected from this lug to any metal objects within 5 feet of the spa.

The NEC and most local codes require that a “disconnect” be installed within “line-of-site” of the spa.

<b>Circuit &amp; Breaker Rating</b>	<b>15A</b>	<b>20A</b>	<b>30A</b>	<b>40A</b>	<b>50A</b>	<b>60A</b>
<b>Maximum Amps</b>	<b>12A</b>	<b>16A</b>	<b>24A</b>	<b>32A</b>	<b>40A</b>	<b>48A</b>
<b>Minimum Wire Size</b>	<b>14</b>	<b>12</b>	<b>10</b>	<b>8</b>	<b>6</b>	<b>4</b>

The above table is a wiring chart representation.

**IMPORTANT- If your electrician is not absolutely sure how to connect your system correctly, call your local dealer. Any mistake may be costly and void your equipment warranty.**

# Electrical Installation

If your system was configured to include a 120VAC power cord, ensure that the proper receptacle has been installed (a dedicated circuit is required). DO NOT under any circumstances modify a 20 Amp plug to fit into a 15 Amp receptacle or use an extension cord. Doing so will create hazardous conditions and/or invalidate the warranty.

## OPTION 1 Units with 15A / 20A GFCI Plug Connection

15/20AMP CORD END GFCI

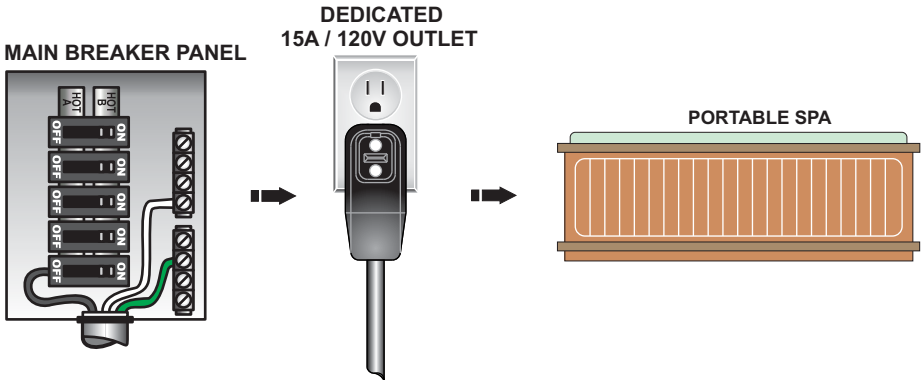

This illustration depicts a typical 15 AMP, cord-end GFCI installation. (The spa must be installed on a dedicated circuit.)

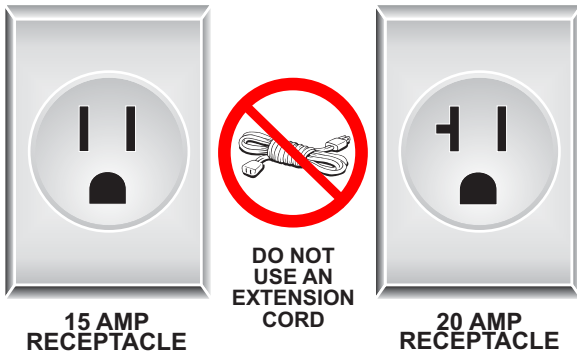

# Electrical Installation

## OPTION 2

### GFCI Installed in Main Service Panel

20-60AMP HARDWIRED

#### MAIN BREAKER PANEL

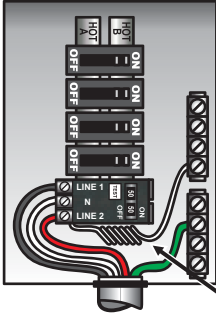

#### INLINE SPA DISCONNECT

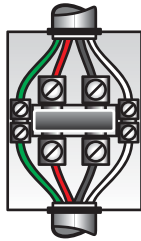

#### PORTABLE SPA

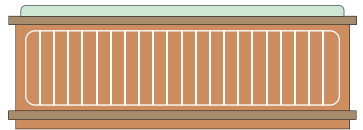

REFER TO GFCI WIRING DETAIL ON PAGE 8

Option 2 shows the power from GFCI breaker installed into main service panel to a service disconnect within line-of-site of the spa. If the manufacturer of your homes main breaker panel makes a GFCI breaker, you may be able to add it to an open slot in the panel.

## OPTION 3

### Subpanel GFCI Installed

20-60AMP HARDWIRED

#### MAIN BREAKER PANEL

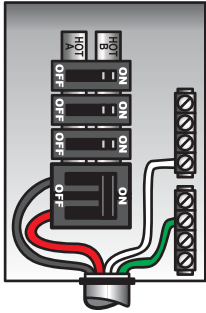

#### GFCI DISCONNECT

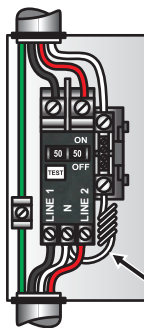

#### INLINE SPA DISCONNECT

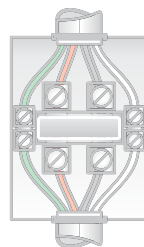

TO PORTABLE SPA



REFER TO GFCI WIRING DETAIL ON PAGE 8

Option 3 shows the power from main service panel to a GFCI subpanel within line-of-site of the spa. (Note: Most local codes will allow a GFCI subpanel to be a disconnect. If this is not the case in your installation, a disconnect must be provided.)



# GFCI Wiring Detail

It is important that the GFCI circuit breaker is installed correctly. Often this component has been improperly installed causing the breaker to instantly trip when the system is turned on. Below is an illustration of a typical GFCI breaker installation.

**WARNING: Refer to the circuit breaker manufacturers installation instructions. This illustration is meant to be a guide for Field Technicians and is not intended to override or substitute the instructions supplied with the circuit breaker.**

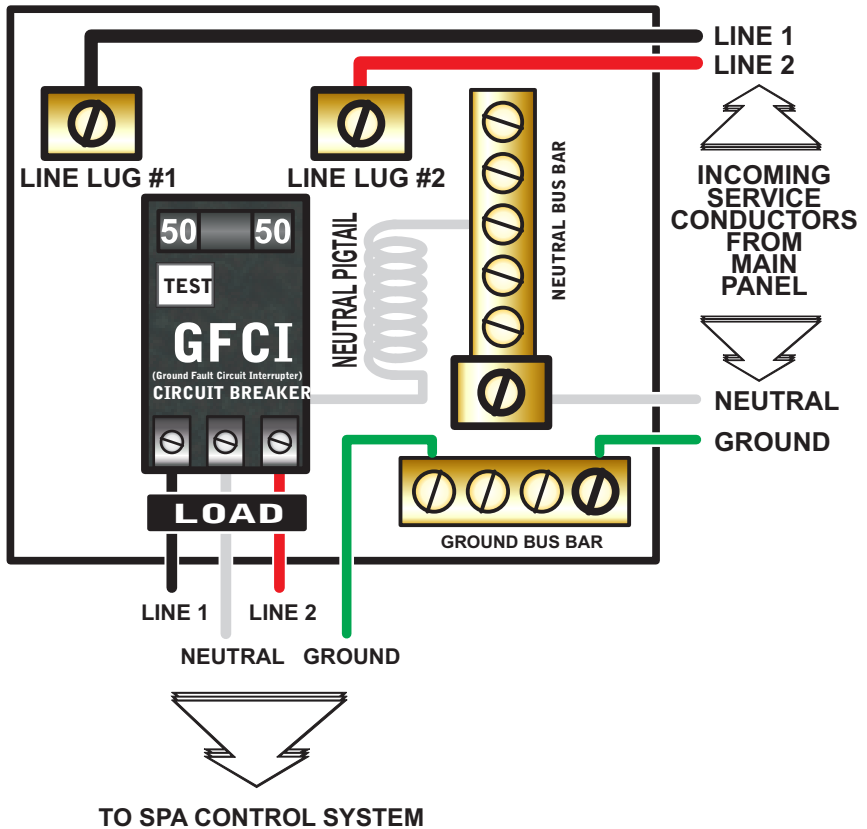

**LOAD NEUTRAL MUST BE CONNECTED DIRECTLY TO GFCI AS SHOWN**

# Heater Installation

The "U" Series Fixed Heater and "US" Series Slide Heater systems will arrive from the factory with the heater mounted in the bottom location as pictured in Step 1. The "US" Series Slide Heater can be installed and used in this configuration or you can move the Slide Heater to the back of the control as shown below to align easily with your particular plumbing arrangement.

## Step 1

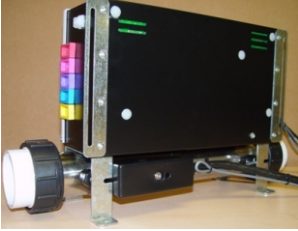

Remove the control system from the carton and verify contents for completeness. If the application is a bottom mount install then you are ready to go directly to step 7.

## Step 3

Position 1

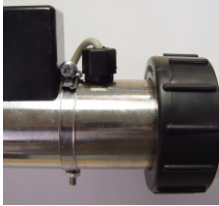

Position 2



The adjustable clamp on the right will be in position 1. Remove the clamp and relocate it to position 2.

## Step 5



Align the other studded clamp and attach to the other slide bracket. Now determine the proper alignment for the heater and tighten the nuts and clamps

## Step 7



9 Connect the power control cords from the heater to the matching receptacles on the control box.

## Step 2



If you need to utilize the slide brackets simply remove the (2) 3/8" outer nuts securing the heater to the foot brackets and remove from under the box.

## Step 4



The mounting studs are attached to adjustable clamps on the heater. Loosen the clamps to adjust the stud locations to align with the slide brackets on one end. Do not tighten the nuts yet.

## Step 6

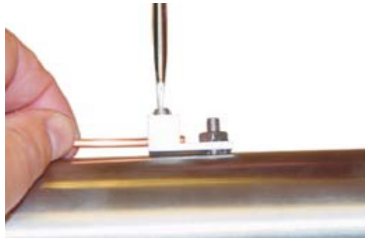

Ground/Bond the heater directly to the control box using the **included** #8 solid bonding wire.

## Versi-Heat / Optional Heaters

The Versi-Heat series heaters are supplied with a 60" cord which allows for versatile installations and locations. **BE SURE HEATER IS INSTALLED HORIZONTALLY.** The Heater can be installed on either the pressure or vacuum side of the pump.

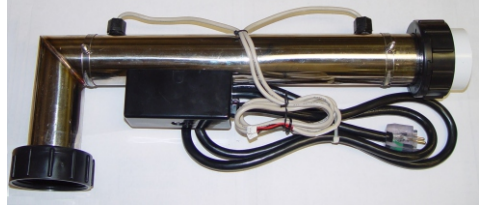

**IMPORTANT - Heater pump must provide a minimum flow of 23 GPM through the heater.**

## Universal Sensor Fitting Kit

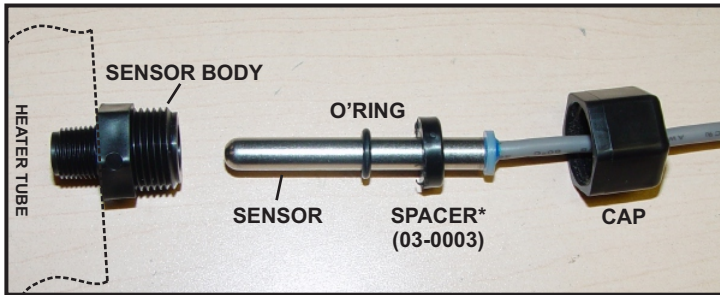

The **SPACER** (HQ PT# 03-0003\*) **is always** required when using this assy to assure a leak-free seal. Note the orientation of the **SPACER**, the flat side goes against the **O'RING**, concave side towards the **CAP**.

It is not necessary to replace the existing **SENSOR BODY** unless leaking, cracked or damaged.

Thread sealer **is not** required when screwing the **CAP** to the **SENSOR BODY**. (**hand tighten only**)

A thread sealer such as teflon tape **will be** required if replacing the **SENSOR BODY**.

**SENSOR** not included in fitting kit. (HQ PT#: 39-0021-K.)

When replacing sensors, please keep in mind that the heater assembly will contain water pressure even with the spa's power off. Close available slice valves and proceed with caution not to allow water on the surrounding electronics.

### Part Numbers

- 12" Temperature Sensor (HQ PT#. 48-0202-K)
- 24" Temperature Sensor (HQ PT#. 48-0202A-K)
- 46" Temperature Sensor (HQ PT#. 48-0202B-K)
- 82" Temperature Sensor (HQ PT#. 48-0202C-K)
- M7 Sensor Fitting Kit (HQ PT#. 39-0021-K)
- 15 pcs Kit, O'ring & Spacer, M7 (HQ PT#. 48-0002)

All Sensors include PT# 39-0021-K

# Power Connection

**IMPORTANT:** Always refer to the product data label (located on top of the control box) for specific electrical information.

- Use copper conductors only as required by the NEC.
- Secure wires as defined by the NEC and in compliance with any local codes in effect at the time of installation.

## 240-VOLT ELECTRICAL SERVICE REQUIREMENTS

Move Dipswitch A10 to the off or down position to place the system in high amp mode. High amp mode allows the heater to stay on when high speed pump(s) or blower is turned on.

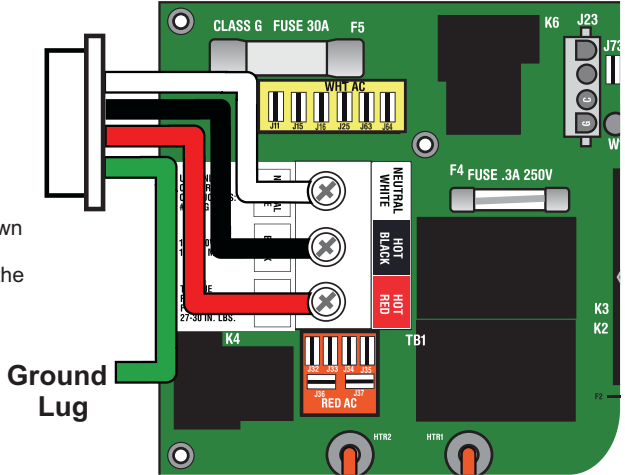
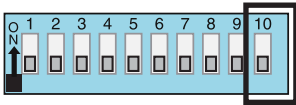

## 120-VOLT ELECTRICAL SERVICE REQUIREMENTS

Connect the white jumper wire included in the configuration kit to an available RED AC and WHT AC terminal.

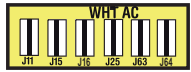

Move Dipswitch A10 to the on or up position to place the system in low amp mode. Low amp mode turns the heater off when a high speed pump(s) or blower is turned on.

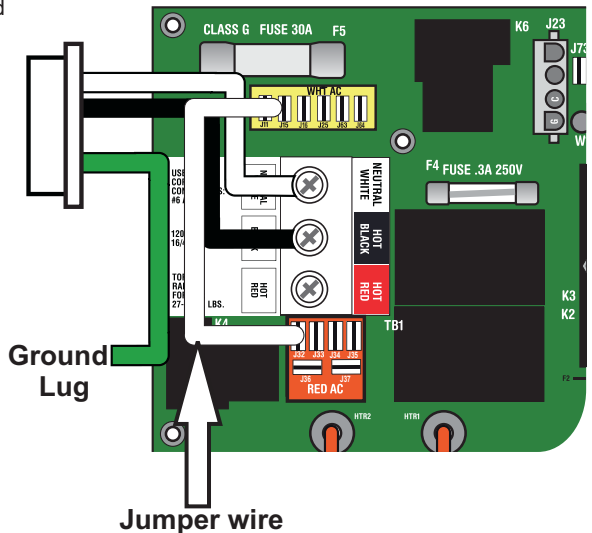
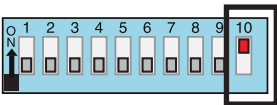

Heater wattage is rated at 240V. When running 120V to heater, output is approximately 25%.

**IMPORTANT- All equipment must be rated for 120VAC.**

# Sensor Connections

The control system contains the temperature sensors inside the heater tube. If your spa has a pre-existing temperature sensor, do not connect it to the control system. It may be required to leave the old temperature sensor installed in the wall of the spa to prevent leaking.

As shown below, the control systems are shipped with the sensors secured to the heater assembly. Remove the securing ties and route sensors through the access hole located above the heater connector on the left side of the system. See figure 1.

With the sensors routed through the system, plug the sensors in to "SEN A" and "SEN B" See figure 2.

The two temperature sensors are the same value and completely interchangeable.

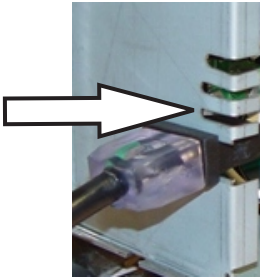

Figure 1

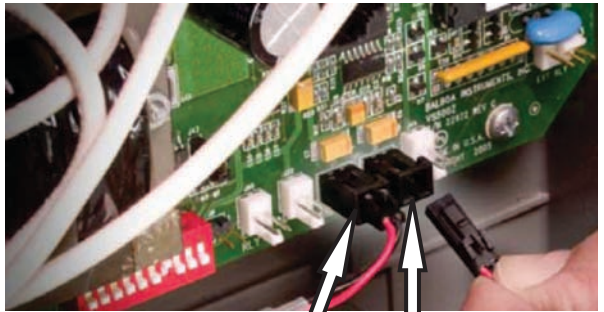
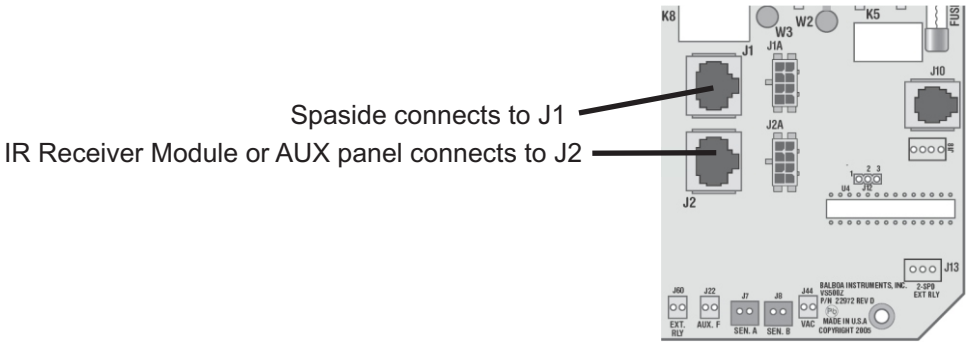

Figure 2

Sensor A    Sensor B

# Cord Connections



## 2-SPEED PUMP CORD CONFIGURATION

The following wiring configuration is for two-speed pump circuits.

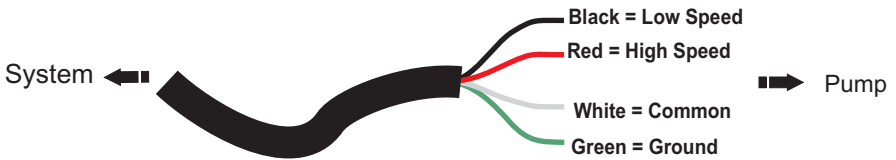

## SINGLE SPEED PUMP / ACCESSORY CORD CONFIGURATION

The following wiring configuration is for single-speed pump circuits, circulation pumps, ozones, blowers and accessories.



# Circuit Board Configurations

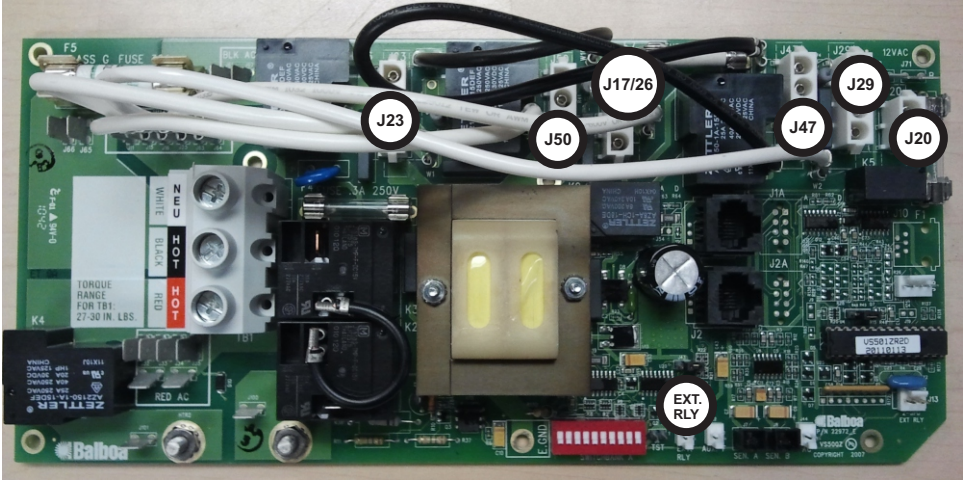

Figure 1

All Device outputs are preset for 120V outputs (as seen above in figure 1). If 240V output is required, please utilize the chart below to configure the appropriate outputs for 240V. For example, to convert pump 1 to 240V, move the red coded wire to J32 (as shown in Figure 2).

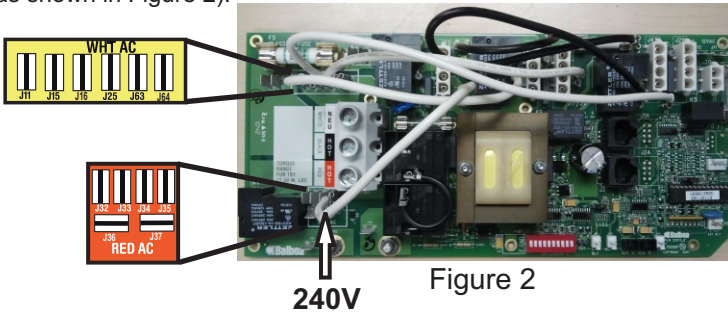

Figure 2

## Voltage Selection Chart for 240V Conversion

Device	Plug Location	Volts	Amps	Wire Color Code	Move To
2 SPD P1	J23	240V	12A	Red	RED AC / J32
Circ Pump	J47	240V	4A	Brown	RED AC / J33
Blower / P2	J17/26	240V	12A	Violet / Blue	RED AC / J34
AV	J50	240V	2A	White	RED AC / J35
Ozone	J29	240V	1A	Yellow	RED AC / J36
Light	J20	240V	1A	NA	NA
Blower / P2	Expander Board	240V	12A	Violet / Blue	RED AC / J37

## Expander Board

Connects to:  
WHT / 120V  
or Red / 240V-J37  
depending on equipment  
rating. ( Pre-configured  
for WHT / 120V )



Connects to Ext. RLY  
jack on circuit board



Connects to J65 or J66

**IMPORTANT-** Circulation pump and ozone must be same voltage rating. 14

# Circuit Board Configurations

**IMPORTANT: Power off spa when making any dip switch changes.**

## Dip Switch Chart for CS610\*B (\* = 0,7,8,9)

- A1 Test Mode (normally OFF)
- A2 "ON" position: Button layout will be: Pump 1, Light, Temp Down, Temp Up \*  
"OFF" position: Button layout will be: Unused, Pump 1, Temp, Light
- A3 "ON" position: use Mini Panel \*   
"OFF" position: use Lite Duplex or Digital Duplex panel 
- A4 Aux Freeze (must be OFF)
- A5+A9 Pump 1 speeds and Circ Modes:

A5	A9	Circ Mode	Pump 1 Speed
OFF	OFF	Non-circ	2-speed
ON	OFF	Thermostatically Controlled	1-speed
OFF	ON	24 hours with 3°F shut-off	1-speed
ON	ON	24 hours with 3°F shut-off	2-speed

- A6 "ON" position: 50Hz operation  
"OFF" position: 60Hz operation
- A7 "ON" position: Standard mode only  
"OFF" position: Std/Ecn/Sleep mode changes allowed
- A8 "ON" position: temperature is displayed in degrees Celsius  
"OFF" position: temperature is displayed in degrees Fahrenheit
- A10 "ON" position: heater is disabled while any high-speed pump is running (low amperage mode)  
"OFF" position: heater can run while any/all high-speed pumps are running (high amperage mode)

Hot tubs equipped with pump 1 as a single speed pump must utilize a circulation pump as the heater pump.

## Switchbank A

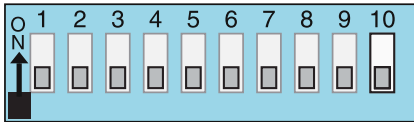

- A1, Test Mode OFF
- A2, Un, P1, TE, LT
- A3, Duplex Panel
- A4, Aux Freeze
- A5, 2-speed P1

- A6, 60 Hz
- A7, Mode changes allowed
- A8, Degrees F
- A9, Non-Circ Mode
- A10, High Amp mode

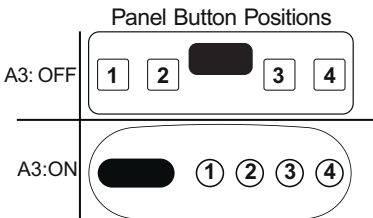

Panel Button Assignments



A2: OFF	1=Unused 2=Pump 1	3=Temp 4=Light
A2: ON	1=Pump 1 2=Light	3=Temp Down 4=Temp Up



# Circuit Board Configurations

**IMPORTANT: Power off spa when making any dip switch changes.**

## Dip Switch Chart for CS620\*B (\* = 0,7,8,9)

- A1 Test Mode (normally OFF)
- A2 "ON" position: Standard mode only  
"OFF" position: Std/Ecn/Sleep mode changes allowed
- A3 "ON" position: use Mini Panel \*   
"OFF" position: use Digital Duplex or Light Duplex panel 
- A4 Aux Freeze (must be OFF)
- A5+A9 Pump 1 speeds and Circ Modes:

A5	A9	Circ Mode	Pump 1 Speed
OFF	OFF	Non-circ	2-speed
ON	OFF	Thermostatically Controlled	1-speed
OFF	ON	24 hours with 3°F shut-off	1-speed
ON	ON	24 hours with 3°F shut-off	2-speed

- A6 "ON" position: 50Hz operation  
"OFF" position: 60Hz operation
- A7 N/A (must remain OFF)
- A8 "ON" position: temperature is displayed in degrees Celsius  
"OFF" position: temperature is displayed in degrees Fahrenheit
- A10 "ON" position: heater is disabled while any high-speed pump or blower is running (low amperage mode)  
"OFF" position: heater can run while any/all high-speed pumps or blowers are running (high amperage mode)

Note: Aux is required. For no Aux, use CS6100 series system.

Hot tubs equipped with pump 1 as a single speed pump must utilize a circulation pump as the heater pump.

## Switchbank A

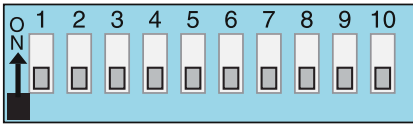

- |  |   |
|--|---|
| <ul style="list-style-type: none"> <li><b>A1, Test Mode OFF</b></li> <li><b>A2, Mode changes allowed</b></li> <li><b>A3, Duplex Panel</b></li> <li><b>A4, Aux Freeze</b></li> <li><b>A5, 2-speed P1</b></li> </ul> | <ul style="list-style-type: none"> <li><b>A6, 60 Hz</b></li> <li><b>A7, N/A</b></li> <li><b>A8, Degrees F</b></li> <li><b>A9, Non-Circ Mode</b></li> <li><b>A10, High Amp mode</b></li> </ul> |
|--|---|

### Panel Button Positions

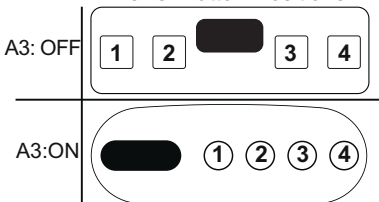

### Panel Button Assignments

- 1=Pump 2 or Blower      3=Temp
- 2=Pump 1                      4=Light

# Circuit Board Configurations

**IMPORTANT: Power off spa when making any dip switch changes.**

## Dip Switch Chart for CS622\*B (\* = 0,7,8,9)

- A1 Test Mode (normally OFF)
- A2+A10 Control amp draw requirements (See Table 1)
- A3 "ON" position: use Mini Panel
  - "OFF" position: use Digital Duplex or Light Duplex panel
- A4 Aux Freeze (must be OFF)
- A5+A9 Pump 1 speeds and Circ Modes:

A5	A9	Circ Mode	Pump 1 Speed
OFF	OFF	Non-circ	2-speed
ON	OFF	Thermostatically Controlled	1-speed
OFF	ON	24 hours with 3°F shut-off	1-speed
ON	ON	24 hours with 3°F shut-off	2-speed

- A6 "ON" position: 50Hz operation  
"OFF" position: 60Hz operation
  - A7 "ON" position: Standard mode only  
"OFF" position: Std/Ecn/Sleep mode changes allowed
  - A8 "ON" position: temperature is displayed in degrees Celsius  
"OFF" position: temperature is displayed in degrees Fahrenheit
- Note: Panel layout is always Pump 2, Pump 1, Temp, Light

Hot tubs equipped with pump 1 as a single speed pump must utilize a circulation pump as the heater pump.

### Switchbank A

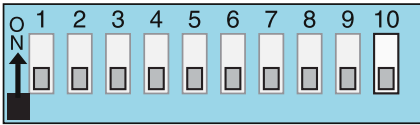

- A1, Test Mode OFF
- A6, 60 Hz
- A2, See Table 1
- A7, Mode changes allowed
- A3, Duplex Panel
- A8, Degrees F
- A4, Aux Freeze
- A9, Non-Circ Mode
- A5, 2-speed P1
- A10, See Table 1

Table 1		# of Hi-Speed Pumps/Blower Before Heat Disabled
A2	A10	
OFF	OFF	0
ON	OFF	1
OFF	ON	2
ON	ON	3

### Panel Button Positions

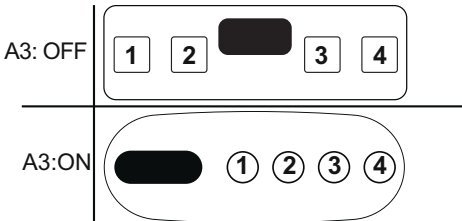

### Panel Button Assignments

- 1=Pump 2
- 3=Temp
- 2=Pump 1
- 4=Light

# Circuit Board Configurations

**IMPORTANT: Power off spa when making any dip switch changes.**

## Dip Switch Chart for CS623\*B (\* = 0,7,8,9)

- A1 Test Mode (normally OFF)
- A2 "ON" position: Standard mode only  
"OFF" position: Std/Ecn/Sleep mode changes allowed
- A3 "ON" position: use Mini Panel   
"OFF" position: use Digital Duplex or Light Duplex panel 
- A4 Aux Freeze (must be OFF)
- A5+A9 Pump 1 speeds and Circ Modes:

A5	A9	Circ Mode	Pump 1 Speed
OFF	OFF	Non-circ	2-speed
ON	OFF	Thermostatically Controlled	1-speed
OFF	ON	24 hours with 3°F shut-off	1-speed
ON	ON	24 hours with 3°F shut-off	2-speed

- A6 "ON" position: 50Hz operation  
"OFF" position: 60Hz operation
- A7 Control amp draw requirements (See Table 1)
- A8 "ON" position: temperature is displayed in degrees Celsius  
"OFF" position: temperature is displayed in degrees Fahrenheit  
Note: Panel layout is always Pump 2+Blower, Pump 1, Temp, Light

Hot tubs equipped with pump 1 as a single speed pump must utilize a circulation pump as the heater pump.

## Switchbank A

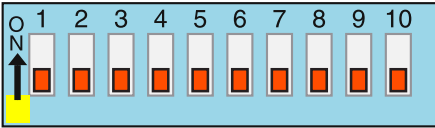

- A1, Test Mode OFF
- A6, 60 Hz
- A2, Mode changes allowed
- A7, See Table 1
- A3, Duplex Panel
- A8, Degrees F
- A4, Aux Freeze
- A9, Non-Circ Mode
- A5, 2-speed P1
- A10, See Table 1

**Table 1** # of Hi-Speed Pumps/Blower Before Heat Disabled

A7	A10	
OFF	OFF	0
ON	OFF	1
OFF	ON	2
ON	ON	3

**Alert:** connect to expander board.  
connect to J17/26.

### Panel Button Positions

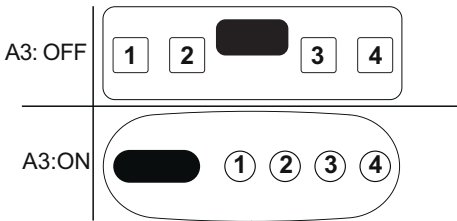

- Panel Button Assignments**
- 1=Pump 2+Blower
  - 3=Temp
  - 2=Pump 1
  - 4=Light

# Circuit Board Configurations

## ECO200 Series Panel



Switchbank A



Dipswitch A3 must be in the on / up position for the ECO200 series spaside to operate correctly.

## ECO401 Series Panel



Switchbank A

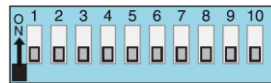

Prior to connecting the optional ECO401 series spaside. Move dipswitch A3 to the off / down position.

## System Start-Up

- 1) Unplug the power cord (120-volt system only) or turn the electrical power "OFF" at the service or breaker panel (120 or 240 volt permanently connected units.)
- 2) Open all **WATER** shut-off valves.
- 3) For spas equipped with a hose bib or drain valve, make sure that it has been closed.
- 4) For spas equipped with in-line or pressure water filters, make sure that the filter nut, housing drain plug, and air relief valve are closed and tight.
- 5) Using a standard water hose, fill the spa with fresh tap water to the level recommended by the spa manufacturer.
- 6) Inspect all plumbing connections and lines for any sign of water leaks.
- 7) Close all **AIR** control valves. **WARNING:** Do not confuse with **WATER** shut-off valves.
- 8) Plug the unit into the proper outlet (120-volt system) or turn on the breaker at the electrical service panel (240-volt system).
- 9) When the system is first started (or any time power is reset) it will go through a series of diagnostic checks, displaying various information on the display, and finally ending with the spaside panel reading "PR" meaning Priming Mode.

- 10) During Priming Mode, press “Jets” button(s) repeatedly and be sure all pumps are free of air.
- 11) On systems with a pressure filter, bleed off the trapped air by opening the Air-Relief valve. You will notice a steady flow of water when the air has been bled completely.
- 12) If equipped, switch the “AIR BLOWER” on to verify that it is working, then switch it off.
- 13) If equipped, switch the “LIGHT” on to verify that it is working, then switch it off.
- 14) If equipped, switch the “AUXILIARY PUMP” on to verify that it is working, allow to run until all air is evacuated from the plumbing system, then switch it off.
- 15) Adjust temperature to the desired set point for comfortable use of the spa. The pump low speed and heater will activate until the set point has been reached.

## Heater Start-Up Sequence

The HydroQuip heater goes through a testing phase every time it starts up to assure that there is adequate water flow.

- 1) Prior to heating, the pump will run for at least 2 minutes and verify that sensors are within specifications.
- 2) The heater turns on for 6.5 to 18 seconds. At this point, the heat indicator on the panel is “solid”. During this time the spa side panel is not immediately responsive.
- 3) The heater turns off for 90 seconds, checking for adequate water flow in the heater. At this point, the heat indicator on the spa side panel may appear to “flicker” or “dim”.
- 4) After adequate water flow has been verified, the heat indicator on the spa side panel returns to “solid” and the spa will heat to set temperature.

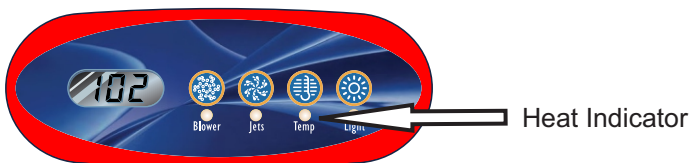
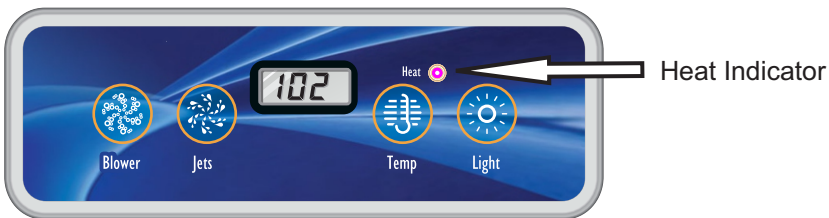

## Filtration Programming

The first preset filter cycle begins 6 minutes after the spa is powered up. The second preset filter cycle begins 12 hours later. Filter duration is programmable for 2, 4, 6, or 8 hours or for continuous filtration (indicated by fc ). To program, press “Temp,” then “Jets 1.” Press “Temp” to adjust the number of hours of filtration. Press “Jets 1” to exit programming.

**For non-circulation pump systems**, low-speed pump 1 and the ozone generator (if installed) run during filtration.

**For 24 hour circulation systems**, the circ pump and the ozone generator (if installed) run 24 hours. In hot environments, the circulation pump may turn off for 30 minute periods, except during filter cycles.

**For non-24 hour circulation pump systems**, the circ pump and ozone generator (if installed) run during filtration (and may also run automatically at other times).

**At the beginning of each filter cycle** all other pumps and blowers will run briefly to purge the plumbing to prevent water from becoming stale.

**IMPORTANT - Heater pump must provide a minimum flow of 23 GPM through the heater.**

## Modes / Behaviors

### Standard Mode

STANDARD Mode maintains set temperature. “St” will be displayed momentarily when you switch into Standard Mode. Non-Circ systems will turn on pump 1 low every 30 minutes for 2 minutes to measure water temperature.

### Economy Mode

ECONOMY Mode heats the spa to the set temperature only during filter cycles. “Ec” will display when water temp is not current, and will alternate with water temp when the pump is running.

### Sleep Mode

SLEEP Mode heats the spa to within 20°F/10°C of the set temperature only during filter cycles. “SL” will display when water temp is not current, and will alternate with water temp when the pump is running.

### How to change modes

Mode is changed by pressing the “Temp” or “Set” button, then pressing the “Light” button.

Note that the last measured spa temperature displayed is current only when the pump has been running for at least 2 minutes.

On non-circ systems, the low speed of pump 1 runs when the blower or any other pump is on. It may also activate for at least 2 minutes every 30 minutes to detect the spa temperature (polling) and then to heat to the set temperature if needed, depending upon mode. When the low speed turns on automatically, it cannot be deactivated from the panel; however, the high speed of pump 1 may be started.

## Spaside Control Operation



### Temp

For Spasides with one temperature button. Press the “Temp” button once to display the set temperature. To change the set temperature, press the pad a second time before the LCD stops flashing. Each press of the “Temp” button will continue to either raise or lower the set temperature. If the opposite direction is desired, release the pad and let the display revert to the current water temperature. Press the pad to display the set temperature, and again to make the temperature change in the desired direction. After three seconds, the LCD will automatically display the last measured spa temperature.

**Temperature range (80°F - 104°F/26.0°C - 40.0°C)** The last measured temperature is constantly displayed on the LCD.

**Note that the last measured spa temperature displayed is current only when the pump has been running for at least 2 minute.**



### Jets

Press “Jets 1” to turn pump 1 on or off, and to shift between low and high speeds (if equipped). The low-speed will turn off after 4 hours. High-speed will turn off after 15 minutes. Low-speed may run automatically at times, during which it cannot be deactivated from the panel, but high-speed may be operated. A light will appear next to the Jets button when it is active.



### Blower

Press this key to turn the blower on and off, an automatic timer will turn the blower off after 30 minutes of operation. A light will appear next to the Blower button when it is active. Heater pump will run when blower is activated.



### Light

Press this key to turn the light on and off, an automatic timer will turn the light off after 4 hours of operation. A light will appear next to the Lights button when it is active.

## Optional Equipment

Dolphin Remote  
Part Number 34-0215



IR Receiver  
Part Number 34-0216C



## Spa Light

Your control may contain a high intensity, low voltage light to enhance night time use. This illustration shows how and where to find the bulb for replacement. It also shows the mounted spa light with a replacement (colored) lens. Colored lenses will further the enhancement of the light. Simply snap on or off to change the mood of your spa. Wall fitting, reflector and lenses are not included. Spa light circuit is LED compatible.

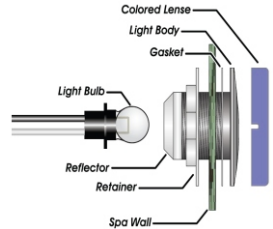



## Operation Considerations

The following describes situations you may encounter and situations to be aware of.

### Warm Weather Conditions

Since your spa will normally be expected to maintain warm to hot water ready for use, a great deal of attention has been directed to the energy conservation detail of insulation to keep electrical cost down. Energy conservation efficiency may be achieved by extensive insulation of the spa cabinet, plumbing, spa shell and in some climates full foam insulation may have been provided. This energy conservation feature may cause an inconvenience during warmer times of the year. During warm periods of the year, the temperature within the equipment compartment can elevate to a point that the pump will automatically turn off for a short amount of time (15-30 minutes) to allow the pump to cool down before automatically restarting. This cool down feature will not harm your spa, but serves only to protect the pump from damage as an indicator that it is too hot. To minimize this occurrence, refrain from using your Hydrotherapy Jets for prolonged periods of time during warm seasons. The jet pump chosen for your spa has been specifically sized for maximum performance and your Hydrotherapy enjoyment.

### Filtration System

Please refer to your Spa Manufactures Owner's Manual regarding the operation, maintenance and cleaning of your filtration system.

**IMPORTANT - Heater pump must provide a minimum flow of 23 GPM through heater.**

### Winterizing

When freezing weather and/or power losses are expected, contact your local spa dealer for freeze protection or winterizing recommendations for both the spa and the equipment system. Freeze related damage is not covered by the warranty.

### Chemical Water Treatment

Your dealer is familiar with local water conditions and which chemicals are compatible with and designed specifically for your spa. This is the best person to advise you on proper water quality management. The one thing you can do to insure years of trouble free equipment operations is to maintain proper water chemistry.





Two basic goals of the chemical water treatment are sanitizing and balancing the water. Sanitizing simply means keeping the water free from microorganisms including algae, bacteria and viruses. The current most popular chemicals for sanitizing include chlorine, bromine and ozone.

Balancing water means establishing a balance among pH, total alkalinity and total hardness. Water that is unbalanced can corrode the spa and it's support equipment or leave deposits of minerals. Properly balanced water is essential to allow the sanitizing chemical to work effectively. There are numerous chemical additives to help you in controlling pH, total hardness and alkalinity. Never use softened water when filling you spa. Softened water is extremely corrosive to the metal parts of the spa equipment and may lead to an unforeseen failure. Sometimes, despite your most diligent efforts, your water may become to far out of balance to be managed chemically. At this point it is probably better to drain and clean the spa and start over with fresh water. Equipment failure caused by improper water chemistry will not be covered under warranty. Saltwater purification systems can potentially damage your equipment. Any related failures will not be covered under warranty.

## Spa Side Messages

Message	Meaning	Action Required
	No Message on display. Power has been cut off to the spa.	The control panel will be disabled until power returns.
--	Temperature unknown.	After the pump has been running for 2 minutes, the current water temperature will be displayed.
HH	"Overheat" - The spa has shut down.* One of the sensors has detected 118°F/47.8°C at the heater.	DO NOT ENTER THE WATER. Remove the spa cover and allow water to cool. Once the heater has cooled, reset by pushing any button. If spa does not reset, shut off the power to the spa and call your dealer or service organization.
OH	"Overheat" - The spa has shut down.* One of the sensors has detected that the spa water is 110°F/43.5°C.	DO NOT ENTER THE WATER. Remove the spa cover and allow water to cool. At 107°F/41.7°C, the spa should automatically reset. If spa does not reset, shut off the power to the spa and call your dealer or service organization.
SA	Spa is shut down.* The sensor that is plugged into the Sensor "A" jack is not working.	Test sensors, possible defective sensor refer to page 28. If the problem persists, contact your dealer or service organization. (May appear temporarily in an overheat condition.)
Sb	Spa is shut down.* The sensor that is plugged into the Sensor "B" jack is not working.	Test sensors, possible defective sensor refer to page 28. If the problem persists, contact your dealer or service organization. (May appear temporarily in an overheat condition.)
Sn	Sensors are out of balance. If alternating with spa temperature, it may just be a temporary condition. If flashing by itself, spa is shut down.*	Cycle power to spa. If problem persists, contact your dealer or service organization.
HL	A significant difference between temperature sensors has been detected. This could indicate a flow problem.	Clean or replace filter. Open all jets and valves. If the water level is normal, make sure all pumps have been primed. If problem persists, contact your dealer or service organization.
LF	Persistent low flow problems. (Displays on the fifth occurrence of "HL" message within 24 hrs.) Functions continue to run normally.	Clean or replace filter. Open all jets and valves. Follow action required for "HL" message. Heating capability of the spa will not reset automatically; you may press any button to reset.
dr	Possible inadequate water, poor flow, or air bubbles in detected in the heater. Spa is shut down for 15 minutes.	Clean or replace filter. If water level is normal, make sure all pumps have been primed. Press any button to reset. This message will reset within 15 minutes. If problem persists, contact your dealer or service organization.
dy	Inadequate water detected in heater. (Displays on third occurrence of "dr" message.) Spa is shut down.*	Clean or replace filter. Follow action required for "dr" message. Spa will not automatically reset. Press any button to reset manually.

## Spa Side Messages

Message	Meaning	Action Required
	<p>"Ice" - Potential freeze condition detected.</p> <p><i>* Even when spa is shut down, some equipment will turn on if freeze protection is needed.</i></p>	<p>No action required. All equipment will automatically activate regardless of spa status. The equipment stays on 4 minutes after the sensors detect that the spa temperature has risen to 45°F/7.2°C or higher. An optional freeze sensor may be added to protect against extraordinary freeze conditions. Auxiliary freeze sensor protection is advisable in colder climates. See your dealer for details.</p>
	Standard Mode	Refer to the modes / Behaviors section on page 22.
	Economy Mode	Refer to the modes / Behaviors section on page 22.
	Sleep Mode	Refer to the modes / Behaviors section on page 22.

## TroubleShooting

The following describes situations and possible solutions to common problems you may encounter as a spa owner.

### Nothing Operates

- Main Breaker is OFF - *Set to On.*
- Sub-Panel Breaker Off - *Set to On.*
- Equipment GFCI Off - *Set to On.*
- Power switch in Off position - *Set to On.*
- Components not plugged in - *Plug in components.*
- Power cord not plugged in - *Plug in power cord.*
- Over or High Temperature Protection On - *Refer to Spa Side Messages.*

### No, Low or Surging Water Flow

- Air Lock in Plumbing System - *"Bleed" the system.*
- Restricted Flow - *Insure that the water shut-off valves are open and that suction fittings are not blocked by debris.*
- Dirty Filter - *Clean or replace filter.*
- Low Water Level - *Increase water level to recommended level.*

### Low Speed Pump Not Operational

- Circuit board configuration is Incorrect - *Contact your local dealer.*
- Pump Not Plugged-In - *Plug in the Pump.*
- Blown Fuse - *Contact your local dealer.*

### Jets or Blower Not Operational

- Blower or Pump Not Plugged-In - *Plug in the Blower or Pump.*
- Blown Fuse - *Contact your local dealer.*
- Over or High Temperature Protection On - *Refer to Spa Side Messages.*

## **Therapy Jet Not Operational**

- Water Shut-Off Valves are Closed - *Open Shut-Off valves.*
- Dirty Filter - *Clean or replace filter.*
- Jets Not Properly Adjusted - *Adjust Jets properly.*
- Diverter Valve Not Properly Adjusted - *Adjust diverter valve properly.*
- Thermal Overload Tripping - *Check for restricted flow of water.*

## **Water Leaks**

- Spa Overfilled - *Adjust water level.*
- Too Many People in the Spa - *Adjust water level.*
- Drain-Valve Left Open - *Close drain valve.*
- Couplings or Unions Loose - *Tighten or contact your local dealer.*
- Pump Seal Leaking - *Contact your local dealer.*
- Plumbing / Connections Leaking - *Contact your local dealer.*
- Water Leaking from Spaside Control - *Contact your local dealer.*
- Water in Air Blower Plumbing - *Contact your local dealer.*

## **No Heat**

- Temperature Not Set Correctly - *Adjust Set Point.*
- Over or High Temperature Protection On - *Refer to Spa Side Messages*
- Current Limiting On - *120V Systems will not heat if High Speed or Blower is on. Contact your local dealer.*
- No Power - *Reset breaker at service panel.*
- Low Water Flow - *Clean or Replace filter.*
- System is in Economy or Sleep Mode - *Refer to modes / behaviors on page 21.*

## **Light Not Operation**

- Light Bulb Defective - *Replace bulb or contact your local dealer.*
- Reflector has Fallen Off - *Replace deflector or contact your local dealer.*
- Light Not Plugged-In - *Plug in the Light.*

## **High Heat**

- Filter Cycles Running Too Long - *Adjust filter cycles down.*
- Temperature Set Too High - *Adjust Set Point.*
- High Ambient Temperature - *Remove spa cover.*

## **GFCI Breaker Trips Occasionally**

- Lightning / Electrical Storm or Power Surge - *Reset GFCI Breaker.*
- NOTE: The GFCI breaker must be properly installed by a licensed electrician.

## **GFCI Breaker Trips Immediately**

- Defective Component or Improper GFCI Breaker Installation - *Contact a qualified service technician or the factory for assistance.*

## Testing the Sensor Set

**IMPORTANT:** For the following set of instruction, the power must be off when plugging in or unplugging sensors.

- 1) Check sensor wires for cracks or damage that may indicate the presence of a rodent.
- 2) Inspect connections of both sensors on the circuit board. The plugs must be clean.
- 3) If the spaside has the error message of SA or Sb, this is an indication of a faulty sensor or possibly a faulty circuit board.
- 4) With the power off to the spa, unplug the two sensors from the circuit board and exchange their positions (i.e., plug the one that was in the "Sen. A jack into the "Sen. B jack and vice versa).
- 5) Power up the spa, if the error message did not change (i.g. original error message was SA and still displays SA) this is an indication of a faulty circuit board. If the error message changed (i.g., original error message was SA and now displays Sb) replace the sensor in the corresponding plug on the circuit board.
- 6) When replacing sensors, please keep in mind that the heater assembly will contain water pressure even with the spa's power off. Close available slice valves and proceed with caution not to allow water on the surrounding electronics.

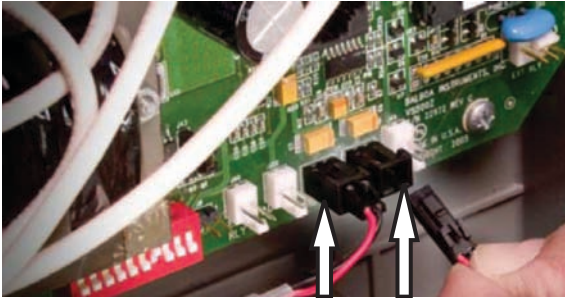

Sensor A      Sensor B

## System Plug Pinouts

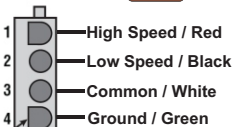
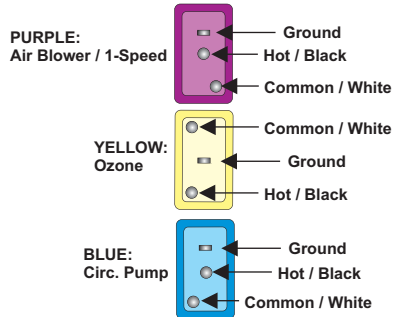
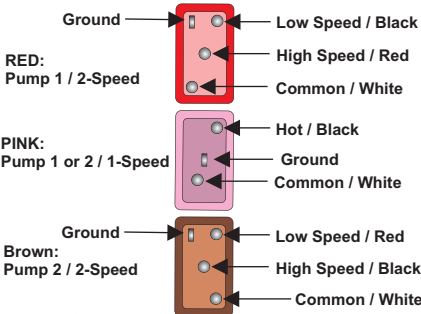

Note flat sides in connector

## System Data Label

**Note:** This information will be necessary if you should ever have to request warranty or any other type of service.

The system data label is located on the control box. This label is very important and contains information you will need to establish your electrical service. The voltage and amperage ratings are shown on the bottom of the label. Product, Model, Serial and Code numbers are also shown on the label.



REFER TO NEC FOR  
BREAKER SIZING

ORDER CODE: CS6200-U  
MODEL: ZZEKX0L-0505GE0  
SERIAL:  
CODE: HYD0D-6801-  
VOLTS: 120 240  
AMPS: 16 40-48  
PRODUCT: HQ 7000  
1 PHASE - 60Hz



## Warranty Information

To all original purchasers, HydroQuip, warrants this product to be free from defects in material and workmanship for a period of 1 year from the date of manufacture.

Hydro-Quip will, at its discretion, repair or replace any part which has been found to be defective.

This warranty excludes damage as a result of: normal wear, freezing, low voltage, chemical abuse, accident, negligence, alteration, improper installation, use or care.

To obtain warranty service, return defective products within the warranty period to Hydro-Quip.

The Hydro-Quip Limited Warranty is for service on the control box only. Purchaser is responsible for removal or reinstallation labor, freight charges, or any other such costs incurred in obtaining warranty service.

Hydro-Quip assumes no responsibility for incidental or consequential damages. Some states do not allow the exclusion of incidental or consequential damages, so the above limitations and exclusions may not apply to you. This warranty gives you specific legal rights and you may also have other rights, which vary from state to state.

If you are the end user for this control system, the spa dealer may provide a different warranty; contact your spa dealer for details and warranty information.





**HYDROQUIP**<sup>TM</sup>

510A N. Sheridan Street · Corona, CA 92880-2024

Email: [info@hydroquip.com](mailto:info@hydroquip.com) · Internet: <http://www.hydroquip.com/>

Telephone: 951.273.7575 · Fax: 800.332.7190